



MET Laboratories, Inc. *Safety Certification - EMI - Telecom Environmental Simulation*

914 WEST PATAPSCO AVENUE • BALTIMORE, MARYLAND 21230-3432 • PHONE (410) 354-3300 • FAX (410) 354-3313

33439 WESTERN AVENUE • UNION CITY, CALIFORNIA 94587 • PHONE (510) 489-6300 • FAX (510) 489-6372

3162 BELICK STREET • SANTA CLARA, CALIFORNIA 95054 • PHONE (408) 748-3585 • FAX (510) 489-6372

August 6, 2009

Bug Labs, Inc.
915 Broadway Suite 1100
New York, NY 10010

Dear Hector Rodriguez,

Enclosed is the EMC Wireless test report for compliance testing of the Bug Labs, Inc., BUG Base with WiFi Module as tested to the requirements of Title 47 of the CFR, Ch. 1 (10-1-06 ed.), Part 15, Subpart B, ICES-003, Issue 4 February 2004 for a Class B Digital Device and FCC Part 15 Subpart C, RSS-210, Issue 7, June 2007 for Intentional Radiators.

Thank you for using the services of MET Laboratories, Inc. If you have any questions regarding these results or if MET can be of further service to you, please feel free to contact me.

Sincerely yours,
MET LABORATORIES, INC.

Jennifer Warnell
Documentation Department

Reference: (\Bug Labs, Inc.\EMC26266-FCC247)

Certificates and reports shall not be reproduced except in full, without the written permission of MET Laboratories, Inc.

Electromagnetic Compatibility Criteria Test Report

for the

**Bug Labs, Inc.
BUG Base with WiFi Module**

Tested under
the FCC Certification Rules
contained in
Title 47 of the CFR, Parts 15 Subpart B & ICES-003
for Class B Digital Devices
&
15.247 Subpart C & RSS-210, Issue 7, June 2007
for Intentional Radiators

MET Report: EMC26266-FCC247

August 6, 2009

Prepared For:

**Bug Labs, Inc.
915 Broadway Suite 1100
New York, NY 10010**

Prepared By:
MET Laboratories, Inc.
914 W. Patapsco. Ave.
Baltimore, MD 21230

Electromagnetic Compatibility Criteria Test Report

for the

Bug Labs, Inc. BUG Base with WiFi Module

Tested under
the FCC Certification Rules
contained in
Title 47 of the CFR, Parts 15 Subpart B & ICES-003
for Class B Digital Devices
&
15.247 Subpart C & RSS-210, Issue 7, June 2007
for Intentional Radiators

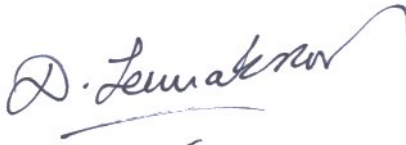

Dusmantha Tennakoon, Project Engineer
Electromagnetic Compatibility Lab



Jennifer Warnell
Documentation Department

Engineering Statement: The measurements shown in this report were made in accordance with the procedures indicated, and the emissions from this equipment were found to be within the limits applicable. I assume full responsibility for the accuracy and completeness of these measurements, and for the qualifications of all persons taking them. It is further stated that upon the basis of the measurements made, the equipment tested is capable of operation in accordance with the requirements of the FCC Rules Parts 15B, 15.247 and Industry Canada standards ICES-003, Issue 4 February 2004, RSS-210, Issue 7, June 2007 under normal use and maintenance.



Shawn McMillen,
Wireless Manager, Electromagnetic Compatibility Lab



Report Status Sheet

Revision	Report Date	Reason for Revision
Ø	August 6, 2009	Initial Issue.

Table of Contents

I.	Executive Summary	1
	A. Purpose of Test	2
	B. Executive Summary	2
II.	Equipment Configuration	3
	A. Overview	4
	B. References	5
	C. Test Site	5
	D. Description of Test Sample	6
	E. Equipment Configuration	7
	F. Support Equipment	7
	G. Ports and Cabling Information	7
	H. Mode of Operation	7
	I. Method of Monitoring EUT Operation	8
	J. Modifications	8
	a) Modifications to EUT	8
	b) Modifications to Test Standard	8
	K. Disposition of EUT	8
III.	Electromagnetic Compatibility Criteria for Unintentional Radiators	9
	§ 15.107(a) Conducted Emissions Limits	10
	§ 15.109(a) Radiated Emissions Limits	14
IV.	Electromagnetic Compatibility Criteria for Intentional Radiators	19
	§ 15.203 Antenna Requirement	20
	§ 15.207(a) Conducted Emissions Limits	21
	§ 15.247(a) 6 dB and 99% Bandwidth	22
	§ 15.247(b) Peak Power Output and RF Exposure	23
	Radiated Spurious Emissions Requirements and Band Edge	24
	§ 15.247(d) RF Conducted Spurious Emissions Requirements and Band Edge	38
	§ 15.247(e) Peak Power Spectral Density	39
V.	Test Equipment	40
VI.	Certification & User's Manual Information	42
	A. Certification Information	43
	B. Label and User's Manual Information	47
VII.	ICES-003 Procedural & Labeling Requirements	49

List of Tables

Table 1. Executive Summary of EMC Part 15.247 Compliance Testing	2
Table 2. EUT Summary Table.....	4
Table 3. References	5
Table 4. Equipment Configuration	7
Table 5. Ports and Cabling Information	7
Table 6. Conducted Limits for Radio Frequency Devices calculated from FCC Part 15 Subsections 15.107(a) (b) and 15.207(a)	10
Table 7. Conducted Emissions - Voltage, AC Power, Phase Line (120 VAC, 60 Hz).....	11
Table 8. Conducted Emissions - Voltage, AC Power, Neutral Line (120 VAC, 60 Hz).....	12
Table 9. Radiated Emissions Limits calculated from FCC Part 15, §15.109 (a) (b)	14
Table 10. Radiated Emissions Limits, Test Results, FCC Limits.....	15
Table 11. Radiated Emissions Limits, Test Results, ICES-003 Limits	17
Table 12. Conducted Limits for Intentional Radiators from FCC Part 15 § 15.207(a)	21
Table 13. Output Power Requirements from §15.247	23
Table 14. Radiated Emissions Limits Calculated from FCC Part 15, § 15.209 (a)	24
Table 15. Restricted Bands of Operation.....	24
Table 16. Radiated Harmonic Emissions, 802.11b.....	26
Table 17. Radiated Harmonic Emissions, 802.11g.....	26
Table 18. Radiated Emissions, Bluetooth.....	30

List of Figures

Figure 1. Block Diagram of Test Configuration.....	6
--	---

List of Photographs

Photograph 1. Conducted Emissions, Test Setup	13
Photograph 2. Radiated Emission, Test Setup.....	18
Photograph 3. Radiated Spurious Emission and Radiated Band Edge, Test Setup	37

List of Terms and Abbreviations

AC	Alternating Current
ACF	Antenna Correction Factor
Cal	Calibration
<i>d</i>	Measurement Distance
dB	Decibels
dB μ A	Decibels above one microamp
dB μ V	Decibels above one microvolt
dB μ A/m	Decibels above one microamp per meter
dB μ V/m	Decibels above one microvolt per meter
DC	Direct Current μ
E	Electric Field
DSL	Digital Subscriber Line
ESD	Electrostatic Discharge
EUT	Equipment Under Test
<i>f</i>	Frequency
FCC	Federal Communications Commission
GRP	Ground Reference Plane
H	Magnetic Field
HCP	Horizontal Coupling Plane
Hz	Hertz
IEC	International Electrotechnical Commission
kHz	kilohertz
kPa	kilopascal
kV	kilovolt
LISN	Line Impedance Stabilization Network
MHz	Megahertz
μ H	microhenry
μ	microfarad
μ s	microseconds
NEBS	Network Equipment-Building System
PRF	Pulse Repetition Frequency
RF	Radio Frequency
RMS	Root-Mean-Square
TWT	Traveling Wave Tube
V/m	Volts per meter
VCP	Vertical Coupling Plane

I. Executive Summary

A. Purpose of Test

An EMC evaluation was performed to determine compliance of the Bug Labs, Inc. BUG Base with WiFi Module, with the requirements of Part 15, §15.247. All references are to the most current version of Title 47 of the Code of Federal Regulations in effect. In accordance with §2.1033, the following data is presented in support of the Certification of the BUG Base with WiFi Module. Bug Labs, Inc. should retain a copy of this document which should be kept on file for at least two years after the manufacturing of the BUG Base with WiFi Module, has been **permanently** discontinued

B. Executive Summary

The following tests were conducted on a sample of the equipment for the purpose of demonstrating compliance with Part 15, §15.247, in accordance with Bug Labs, Inc., purchase order number 300. All tests were conducted using measurement procedure ANSI C63.4-2003.

FCC Reference	IC Reference	Description	Compliance
47 CFR Part 15.247:2005	RSS-210 Issue 7: 2007	Applicable Standard	Compliant
47 CFR Part 15.107 (a)	RSS-210 Issue 7: 2007	Conducted Emission Limits for a Class B Digital Device	Compliant
47 CFR Part 15.109 (a)	RSS-210 Issue 7: 2007	Radiated Emission Limits for a Class B Digital Device	Compliant
Title 47 of the CFR, Part 15 §15.203	N/A	Antenna Requirement	Compliant
Title 47 of the CFR, Part 15 §15.207(a)	RSS-210(7.2.2)	Conducted Emission Voltage	See FCC ID: U9R-W2CBW003
Title 47 of the CFR, Part 15 §15.247(a)(1)	RSS-210(A8.1)	Occupied Bandwidth	See FCC ID: U9R-W2CBW003
Title 47 of the CFR, Part 15 §15.247(b)	RSS-210(A8.4)	RF Output Power	See FCC ID: U9R-W2CBW003
Title 47 of the CFR, Part 15 §15.209, §15.247(d)	RSS-210(A8.5)	Radiated Spurious Emissions	Compliant
Title 47 of the CFR, Part 15 §15.205	RSS-210(A8.5)	Emissions at Restricted Band	Compliant
Title 47 of the CFR, Part 15 §15.209, §15.247(d)	RSS-210(A8.5)	Conducted Spurious Emissions	See FCC ID: U9R-W2CBW003
Title 47 of the CFR, Part 15; §15.247(e)	RSS-210(A8.3)	Power Spectral Density	See FCC ID: U9R-W2CBW003
Title 47 of the CFR, Part 15 §15.247(i)	RSS-Gen(5.5)	Maximum Permissible Exposure	See FCC ID: U9R-W2CBW003
N/A	RSS-Gen(4.8)	Receiver Spurious Emissions	Compliant

Table 1. Executive Summary of EMC Part 15.247 Compliance Testing



II. Equipment Configuration

A. Overview

MET Laboratories, Inc. was contracted by Bug Labs, Inc. to perform testing on the BUG Base with WiFi Module, under Bug Labs, Inc.'s purchase order number 300.

This document describes the test setups, test methods, required test equipment, and the test limit criteria used to perform compliance testing of the Bug Labs, Inc., BUG Base with WiFi Module.

The results obtained relate only to the item(s) tested.

Model(s) Tested:	BUG Base with WiFi Module	
Model(s) Covered:	BUG Base with WiFi Module	
EUT Specifications:	Primary Power: 120 VAC, 60 Hz	
	FCC ID: W3J-BUGBASE	
	Type of Modulations:	802.11b/g: CCK and OFDM Bluetooth: DSSS
	Equipment Code:	802.11b/g: DTS Bluetooth: DSS
	Peak RF Output Power:	802.11b/g: 15.24 dBm Bluetooth: 5.26 dBm
	EUT Frequency Ranges:	802.11b/g: 2412 – 2462 MHz Bluetooth: 2402 – 2480 MHz
Analysis:	The results obtained relate only to the item(s) tested.	
Environmental Test Conditions:	Temperature: 15-35° C	
	Relative Humidity: 30-60%	
	Barometric Pressure: 860-1060 mbar	
Evaluated by:	Dusmantha Tennakoon	
Report Date(s):	August 6, 2009	

Table 2. EUT Summary Table

Note: The EUT is considered the base unit + WiFi module. The WiFi module also supports Bluetooth.

B. References

CFR 47, Part 15, Subpart C	Federal Communication Commission, Code of Federal Regulations, Title 47, Part 15: General Rules and Regulations, Allocation, Assignment, and Use of Radio Frequencies
RSS-210, Issue 7, June 2007	Low-power Licence-exempt Radiocommunications Devices (All Frequency Bands): Category I Equipment
CFR 47, Part 15, Subpart B	Electromagnetic Compatibility: Criteria for Radio Frequency Devices
ICES-003, Issue 4 February 2004	Electromagnetic Compatibility: Criteria for Radio Frequency Devices
ANSI C63.4:2003	Methods and Measurements of Radio-Noise Emissions from Low-Voltage Electrical And Electronic Equipment in the Range of 9 kHz to 40 GHz
ANSI/NCSL Z540-1-1994	Calibration Laboratories and Measuring and Test Equipment - General Requirements
ANSI/ISO/IEC 17025:2000	General Requirements for the Competence of Testing and Calibration Laboratories

Table 3. References

C. Test Site

All testing was performed at MET Laboratories, Inc., 914 W. Patapsco Ave., Baltimore, MD 21230. All equipment used in making physical determinations is accurate and bears recent traceability to the National Institute of Standards and Technology.

Radiated Emissions measurements were performed in a 3 meter semi-anechoic chamber (equivalent to an Open Area Test Site). In accordance with §2.948(a)(3), a complete site description is contained at MET Laboratories.

D. Description of Test Sample

The BUG Base with WiFi Module, Equipment Under Test (EUT), is a portable/transportable modular computer platform capable of accepting up to 3 different modules to implement customizable functionality. The “Hiro P” B2_Base is a fully functional computer platform based on an ARM11 processor. It can operate by itself and/or have extended functionally through the addition of up to four functionality modules. The EUT configuration will consist of:

Configuration:

LCD display with touch screen (previously certified to FCC part 15 B), a BugBee Module (new modules to be certified to FCC part 15 B), and an Audio (BugAudio) module (previously certified to FCC part 15-B). The “Hiro P” automatically detects the presence of the modules, determines their type and configures them for basic operation. As configured, the EUT will automatically run an application to display a banner on the LCD module to show it is operating. The banner image will be automatically refreshed every few milliseconds. The BugBee module contains an 802.15.4 compliant radio with modular certification. In this configuration the Bugbee is being tested for radiated emissions only. The Bugbee will be turned on as a coordinator and its operating state can be verified via communication with another BugBee on another unit that will flash an LED each time a message is exchanged. The BugAudio module will be exercised periodically to emit a short audible sound burst. Note that only the unit under test will go into the test chamber. The EUT contains a WiFi/Bluetooth module with fixed, non-user changeable chip antenna.

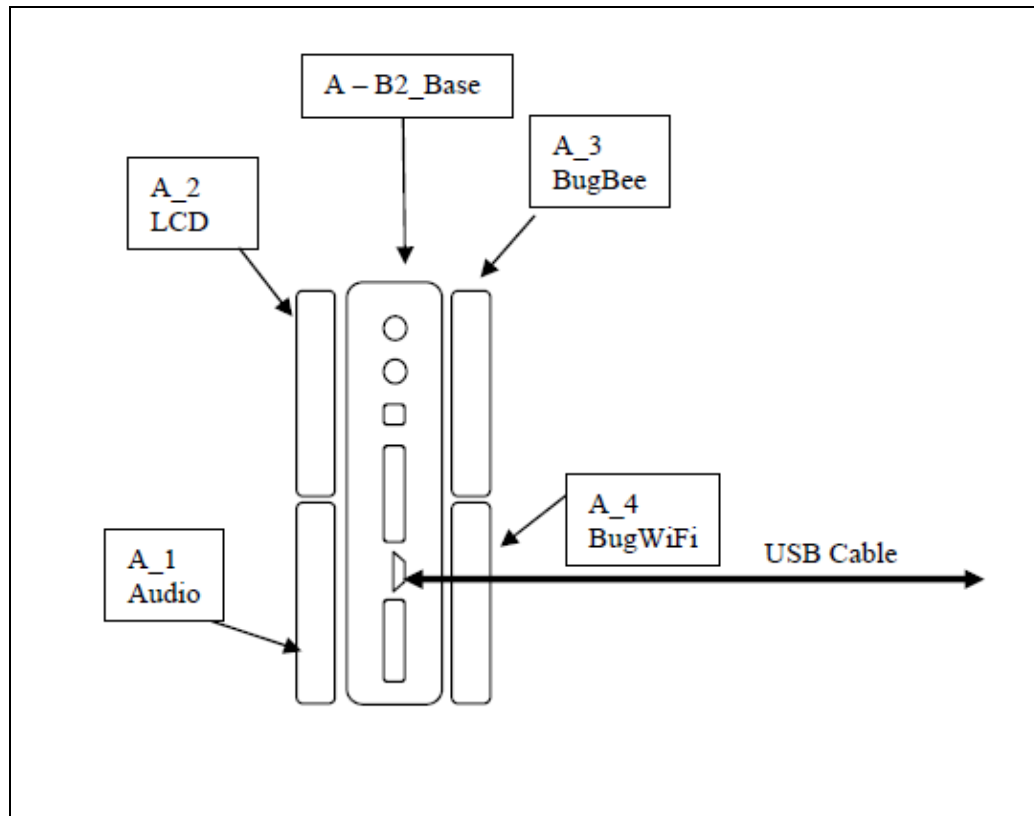

Figure 1. Block Diagram of Test Configuration

E. Equipment Configuration

The EUT was set up as outlined in Figure 1, Block Diagram of Test Setup. All cards, racks, etc., incorporated as part of the EUT is included in the following list.

Ref. ID	Name / Description	Model Number	Part Number	Serial Number	Revision
A	B2-BASE: BUG BASE UNIT	HIRO P SERIES 1.0	10010	BG78730	1.2
A_1	AUDIO (MODULE ATTACHED TO B2-BASE)	BL-AUDIO-01	11060	E4918	1.1
A_2	LCD (DISPLAY MODULE ATTACHED TO B2-BASE)	BL-LCD25-01	11010	E2821	1.1
A_3	BUGBEE (802.15.4 COMPLIANT MODULE)	BL-BUGBEE-01	11070	E5667	1.1
A_4	BUGWIFI (WIFI/BLUETOOTH MODULE)	BL-WIFI-01	11080	E5640	1.0

Table 4. Equipment Configuration

F. Support Equipment

The EUT did not require any support equipment for operation or monitoring.

G. Ports and Cabling Information

Ref. ID	Port Name on EUT	Cable Description	Qty.	Length (m)	Shielded (Y/N)	Termination Point
1	DC INPUT	AC/DC ADAPTER CABLE	1	1.5	YES	110-240V/50-60HZ
2	OTG	OTG TO MINI-B USB	1	1	NO	NA

Table 5. Ports and Cabling Information

H. Mode of Operation

Unit will be powered and will automatically run an application to exercise the attached modules as described in the previous section. The battery in the unit will be charging as long as the unit is powered via the AC/DC power adapter. An SD Memory card will be equipped on the microSD slot of the UUT. The operating File System will reside on the SD card ensuring periodic access to the card by the operating software. The software driver associated with each attached module will be automatically loaded to enable the Hiro P processor to interact with each attached module.

I. Method of Monitoring EUT Operation

The WiFi and Bluetooth radio were configured to transmit continuously for testing purposes.

J. Modifications

a) Modifications to EUT

No modifications were made to the EUT.

b) Modifications to Test Standard

No modifications were made to the test standard.

K. Disposition of EUT

The test sample including all support equipment submitted to the Electro-Magnetic Compatibility Lab for testing was returned to Bug Labs, Inc. upon completion of testing.

III. Electromagnetic Compatibility Criteria for Unintentional Radiators

Electromagnetic Compatibility Criteria

§ 15.107 Conducted Emissions Limits

Test Requirement(s): **15.107 (a)** Except for Class A digital devices, for equipment that is designed to be connected to the public utility (AC) power line, the radio frequency voltage that is conducted back onto the AC power line on any frequency or frequencies within the band 150 kHz to 30 MHz shall not exceed the limits in Table 6. Compliance with this provision shall be based on the measurement of the radio frequency voltage between each power line and ground at the power terminals.

15.107 (b) For a Class A digital device that is designed to be connected to the public utility (AC) power line, the radio frequency voltage that is conducted back onto the AC power line on any frequency or frequencies within the band 150 kHz to 30 MHz shall not exceed the limits in Table 6. Compliance with this provision shall be based on the measurement of the radio frequency voltage between each power line and ground at the power terminals. The lower limit applies at the band edges.

15.207(a), Except as shown in paragraphs (b) and (c) of this section*, charging, AC adapters or battery eliminators the radio frequency voltage that is conducted back onto the AC power line on any frequency or frequencies, within the band 150 kHz to 30 MHz, shall not exceed the limits in the Table 6, as measured using a 50 μ H/50 ohms line impedance stabilization network (LISN). Compliance with the provisions of this paragraph shall be based on the measurement of the radio frequency voltage between each power line and ground at the power terminal. The lower limit applies at the boundary between the frequencies ranges.

Frequency range (MHz)	Class A Conducted Limits (dB μ V)		*Class B Conducted Limits (dB μ V)	
	Quasi-Peak	Average	Quasi-Peak	Average
* 0.15- 0.45	79	66	66 - 56	56 - 46
0.45 - 0.5	79	66	56	46
0.5 - 30	73	60	60	50

Note 1 — The lower limit shall apply at the transition frequencies.
 Note 2 — The limit decreases linearly with the logarithm if the frequency in the range 0.15 MHz to 0.5 MHz.
 * -- Limits per Subsection 15.207(a).

Table 6. Conducted Limits for Radio Frequency Devices calculated from FCC Part 15 Subsections 15.107(a) (b) and 15.207(a)

Test Procedures: The EUT was placed on a non-metallic table, 80 cm above the ground plane inside a semi-anechoic chamber. The method of testing, test conditions, and test procedures of ANSI C63.4 were used. The EUT was powered through a 50 Ω /50 μ H LISN. An EMI receiver, connected to the measurement port of the LISN, scanned the frequency range from 150 kHz to 30 MHz in order to find the peak conducted emissions.

Test Results: The EUT was compliant with the Class B requirement(s) of this section.

Test Engineer(s): Dusmantha Tennakoon

Test Date(s): 01/26/09

Conducted Emissions - Voltage, AC Power, Phase Line (120 VAC, 60 Hz)

Frequency (MHz)	Quasi-Peak Amplitude (dBμV)	Quasi-Peak Limit (dBμV)	Quasi-Peak Margin (dBμV)	Average Amplitude (dBμV)	Average Limit (dBμV)	Average Margin (dBμV)
0.1526	46.77942	65.86	-19.0806	35.08942	55.86	-20.7706
0.168	36.2056	65.06	-28.8544	27.6956	55.06	-27.3644
0.5662	34.26	56	-21.74	28.97	46	-17.03
3.002	27.83	56	-28.17	21.64	46	-24.36
17.52	17.38	60	-42.62	12.23	50	-37.77
29.2	29.6028	60	-30.3972	22.5428	50	-27.4572

Table 7. Conducted Emissions - Voltage, AC Power, Phase Line (120 VAC, 60 Hz)

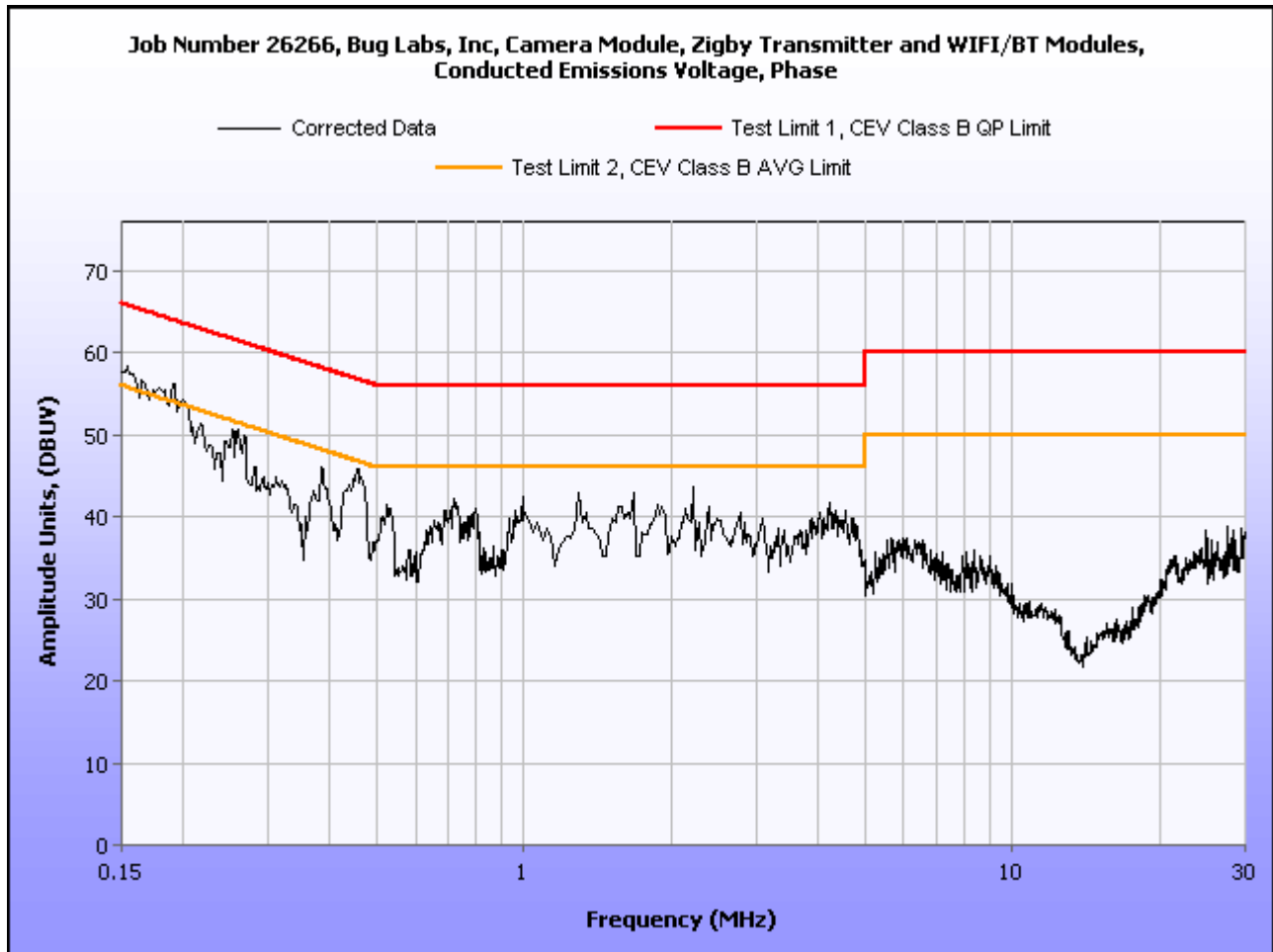

Plot 1. Conducted Emission, Phase Line Plot

Conducted Emissions - Voltage, AC Power, Neutral Line (120 VAC, 60 Hz)

Frequency (MHz)	Quasi-Peak Amplitude (dBμV)	Quasi-Peak Limit (dBμV)	Quasi-Peak Margin (dBμV)	Average Amplitude (dBμV)	Average Limit (dBμV)	Average Margin (dBμV)
0.1544	40.81248	65.76	-24.9475	25.46248	55.76	-30.2975
0.1789	30.47413	64.54	-34.0659	21.74413	54.54	-32.7959
0.5575	39.33	56	-16.67	34.12	46	-11.88
1.833	36.99	56	-19.01	27.15	46	-18.85
15.43	21.3	60	-38.7	17.67	50	-32.33
29.82	31.57288	60	-28.4271	27.35288	50	-22.6471

Table 8. Conducted Emissions - Voltage, AC Power, Neutral Line (120 VAC, 60 Hz)

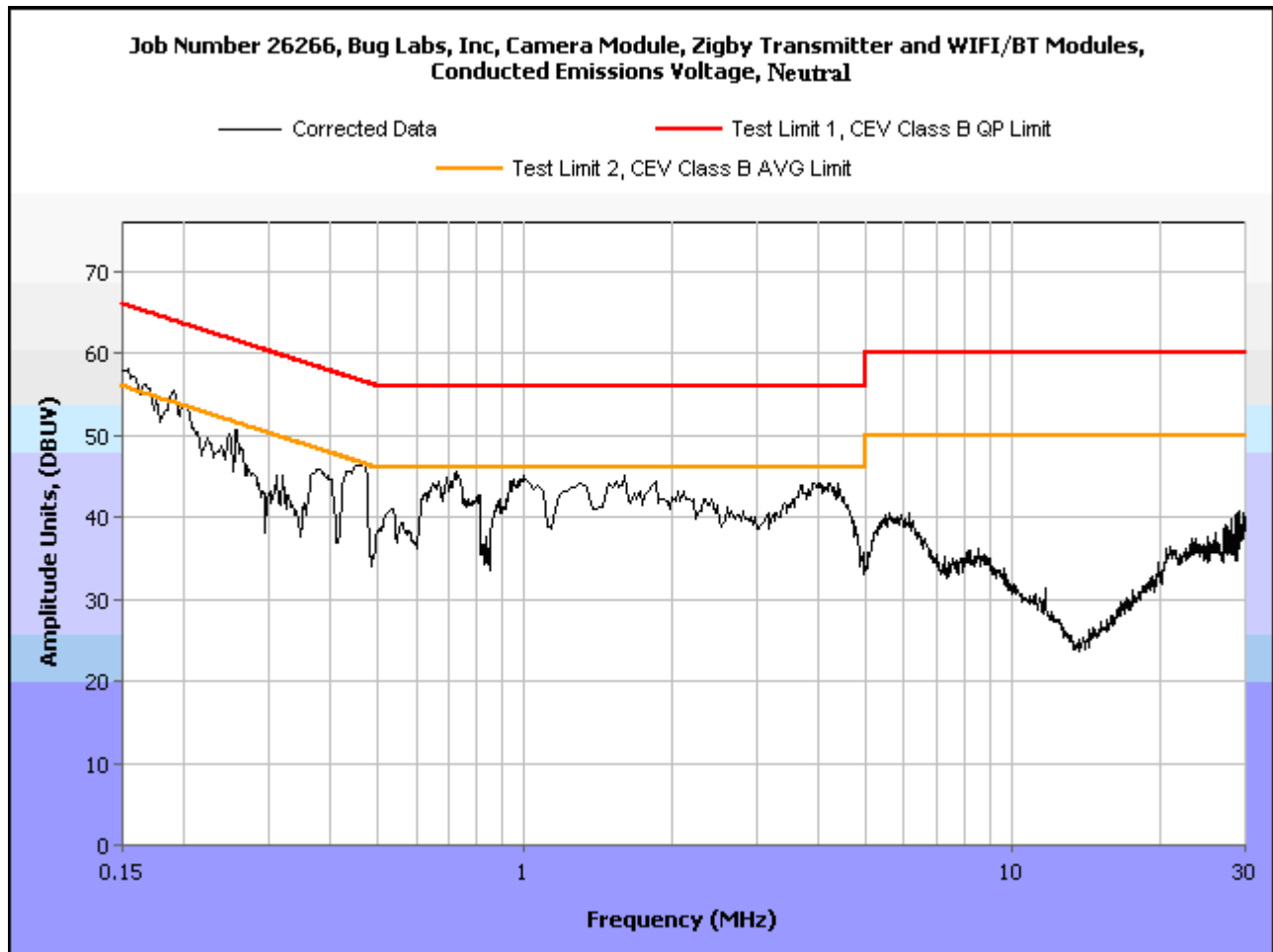

Plot 2. Conducted Emission, Neutral Line Plot

Conducted Emission Limits Test Setup



Photograph 1. Conducted Emissions, Test Setup

Radiated Emission Limits

§ 15.109 Radiated Emissions Limits

Test Requirement(s): **15.109 (a)** Except for Class A digital devices, the field strength of radiated emissions from unintentional radiators at a distance of 3 meters shall not exceed the Class B limits expressed in Table 9.

15.109 (b) The field strength of radiated emissions from a Class A digital device, as determined at a distance of 10 meters, shall not exceed the Class A limits expressed in Table 9.

Frequency (MHz)	Field Strength (dB μ V/m)	
	§15.109 (b), Class A Limit (dB μ V) @ 10m	§15.109 (a), Class B Limit (dB μ V) @ 3m
30 - 88	39.00	40.00
88 - 216	43.50	43.50
216 - 960	46.40	46.00
Above 960	49.50	54.00

Table 9. Radiated Emissions Limits calculated from FCC Part 15, §15.109 (a) (b)

Test Procedures: The EUT was placed on a non-metallic table, 80 cm above the ground plane inside a semi-anechoic chamber. The method of testing and test conditions of ANSI C63.4 were used. An antenna was located 3 m from the EUT on an adjustable mast. A pre-scan was first performed in order to find prominent radiated emissions. For final emissions measurements at each frequency of interest, the EUT was rotated and the antenna height was varied between 1 m and 4 m in order to maximize the emission. Measurements in both horizontal and vertical polarities were made and the data was recorded. Unless otherwise specified, measurements were made using a quasi-peak detector with a 120 kHz bandwidth.

Test Results: The EUT was compliant with the Class B requirement(s) of this section.

Test Engineer(s): Dusmantha Tennakoon

Test Date(s): 01/26/09

Radiated Emissions Limits Test Results, Class B

Frequency (MHz)	EUT Azimuth (Degrees)	Antenna Polarity (H/V)	Antenna Height (m)	Uncorrected Amplitude (dBuV)	Antenna Correction Factor (dB) (+)	Cable Loss (dB) (+)	Distance Correction Factor (dB) (-)	Corrected Amplitude (dBuV/m)	Limit (dBuV/m)	Margin (dB)
31.810	0	H	1.00	15.56	5.88	0.12	0.00	21.56	40.00	-18.44
31.810	353	V	1.23	26.71	4.70	0.12	0.00	31.53	40.00	-8.47
37.110	0	H	1.00	16.26	8.11	0.17	0.00	24.54	40.00	-15.46
37.110	360	V	1.00	27.60	6.89	0.17	0.00	34.66	40.00	-5.34
109.778	0	H	1.00	16.26	7.21	0.27	0.00	23.74	43.50	-19.76
109.778	187	V	1.00	22.96	7.60	0.27	0.00	30.82	43.50	-12.68
146.371	0	H	1.00	16.03	7.95	0.41	0.00	24.40	43.50	-19.10
146.371	360	V	1.00	19.69	7.90	0.41	0.00	28.00	43.50	-15.50
184.629	0	H	1.00	16.48	9.95	0.39	0.00	26.82	43.50	-16.68
184.629	256	V	1.00	17.50	9.38	0.39	0.00	27.27	43.50	-16.23
664.967	306	H	1.00	18.59	20.30	2.58	0.00	41.47	46.00	-4.53
664.967	0	V	1.00	15.80	20.20	2.58	0.00	38.58	46.00	-7.42

Table 10. Radiated Emissions Limits, Test Results, FCC Limits

Note: The EUT was tested at 3 m.

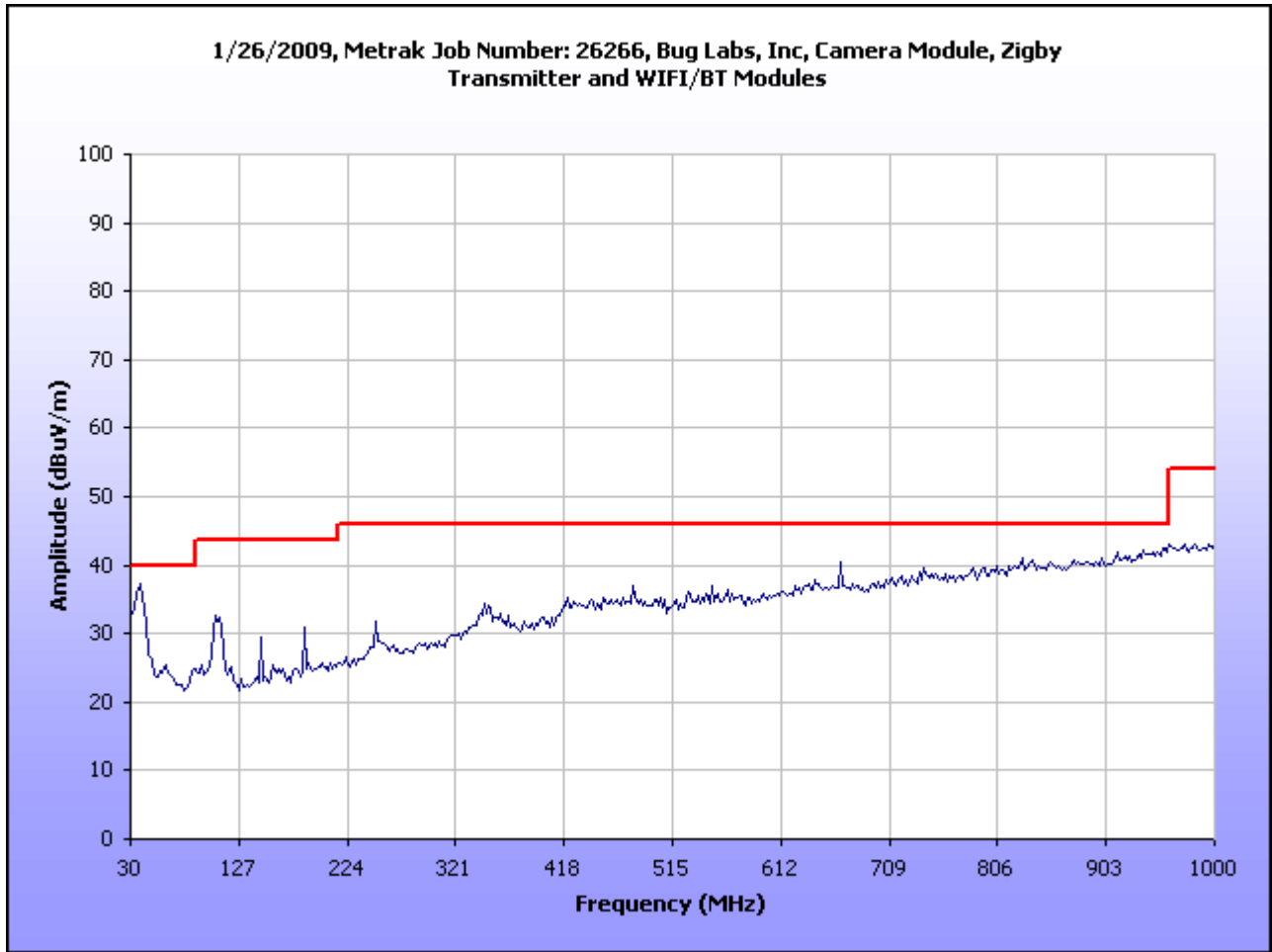

Plot 3. Radiated Emissions, Pre-Scan, FCC Limits

Radiated Emissions Limits Test Results, Class B

Frequency (MHz)	EUT Azimuth (Degrees)	Antenna Polarity (H/V)	Antenna Height (m)	Uncorrected Amplitude (dBuV)	Antenna Correction Factor (dB) (+)	Cable Loss (dB) (+)	Distance Correction Factor (dB) (-)	Corrected Amplitude (dBuV/m)	Limit (dBuV/m)	Margin (dB)
31.810	0	H	1.00	15.56	5.88	0.12	10.46	11.10	30.00	-18.90
31.810	353	V	1.23	26.71	4.70	0.12	10.46	21.07	30.00	-8.93
37.110	0	H	1.00	16.26	8.11	0.17	10.46	14.08	30.00	-15.92
37.110	360	V	1.00	27.60	6.89	0.17	10.46	24.20	30.00	-5.80
109.778	0	H	1.00	16.26	7.21	0.27	10.46	13.28	30.00	-16.72
109.778	187	V	1.00	22.96	7.60	0.27	10.46	20.36	30.00	-9.64
146.371	0	H	1.00	16.03	7.95	0.41	10.46	13.94	30.00	-16.06
146.371	360	V	1.00	19.69	7.90	0.41	10.46	17.54	30.00	-12.46
184.629	0	H	1.00	16.48	9.95	0.39	10.46	16.36	30.00	-13.64
184.629	256	V	1.00	17.50	9.38	0.39	10.46	16.81	30.00	-13.19
664.967	306	H	1.00	18.59	20.30	2.58	10.46	31.01	37.00	-5.99
664.967	0	V	1.00	15.80	20.20	2.58	10.46	28.12	37.00	-8.88

Table 11. Radiated Emissions Limits, Test Results, ICES-003 Limits

Notes: The EUT was tested at 3 m. The data has been corrected for comparison with the 10 m limit using the formula: $20\log(3\text{ m}/10\text{ m})$ as expressed in the 'Distance Correction' column.

Note: The highest measured receiver spurs were 31.01 dBuV/m at 10 m.

Radiated Emission Limits Test Setup

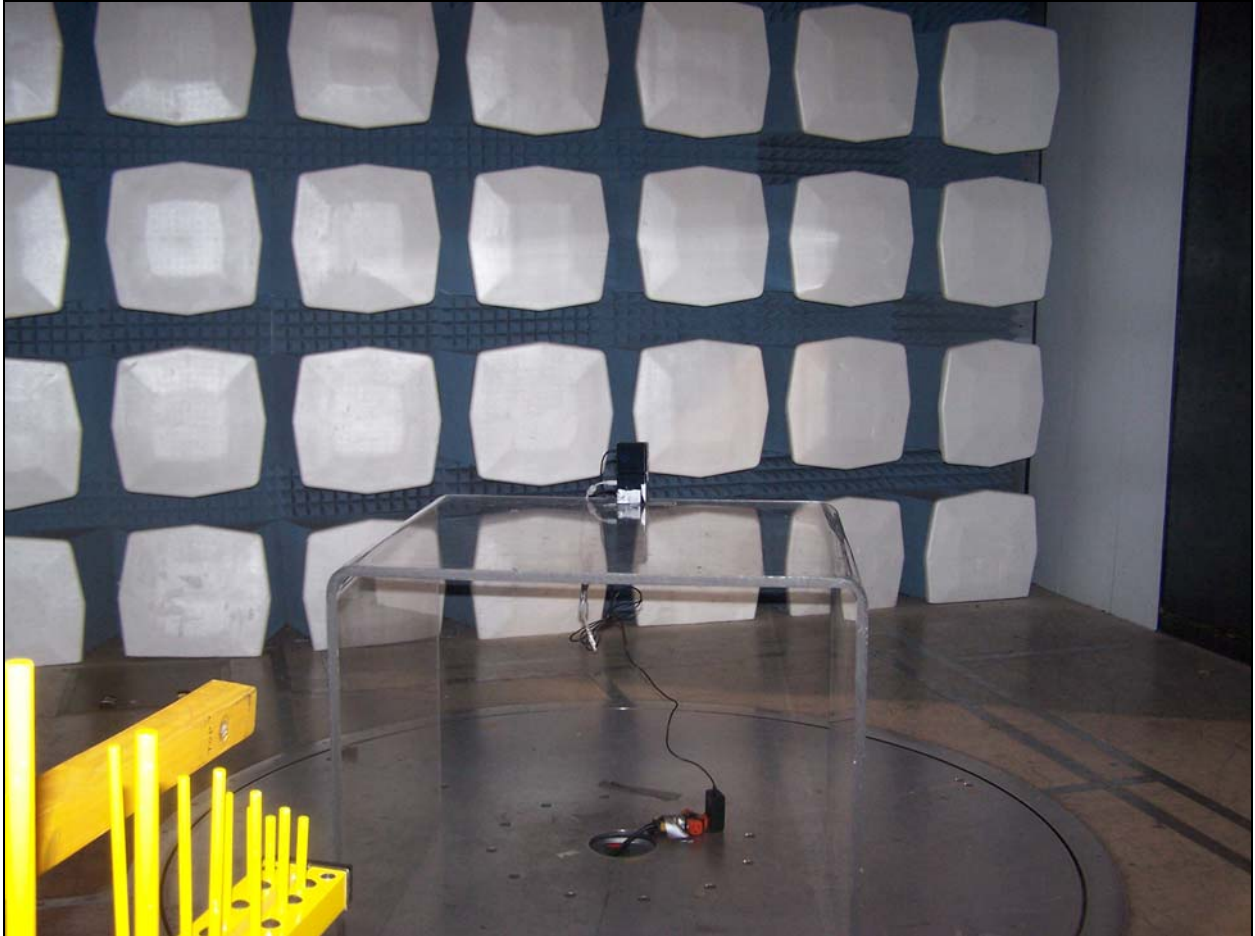

Photograph 2. Radiated Emission, Test Setup

IV. Electromagnetic Compatibility Criteria for Intentional Radiators

Electromagnetic Compatibility Criteria for Intentional Radiators

§ 15.203 Antenna Requirement

Test Requirement: § 15.203: An intentional radiator shall be designed to ensure that no antenna other than that furnished by the responsible party shall be used with the device. The use of a permanently attached antenna or of an antenna that uses a unique coupling to the intentional radiator shall be considered sufficient to comply with the provisions of this section. The manufacturer may design the unit so that a broken antenna can be replaced by the user, but the use of a standard antenna jack or electrical connector is prohibited.

The structure and application of the EUT were analyzed to determine compliance with Section 15.203 of the Rules. Section 15.203 states that the subject device must meet at least one of the following criteria:

- a.) Antenna must be permanently attached to the unit.
- b.) Antenna must use a unique type of connector to attach to the EUT.
- c.) Unit must be professionally installed. Installer shall be responsible for verifying that the correct antenna is employed with the unit.

Results: The EUT as tested is compliant the criteria of §15.203. The antenna is a chip antenna and is permanently mounted to the board.

Test Engineer(s): Dusmantha Tennakoon

Test Date(s): 07/21/09

Electromagnetic Compatibility Criteria for Intentional Radiators

§ 15.207 Conducted Emissions Limits

Test Requirement(s): § 15.207 (a): For an intentional radiator that is designed to be connected to the public utility (AC) power line, the radio frequency voltage that is conducted back onto the AC power line on any frequency or frequencies, within the band 150 kHz to 30MHz, shall not exceed the limits in the following table, as measured using a 50 μ H/50 Ω line impedance stabilization network (LISN). Compliance with the provisions of this paragraph shall be based on the measurement of the radio frequency voltage between each power line and ground at the power terminal. The lower limit applies at the boundary between the frequency ranges.

Frequency range (MHz)	§ 15.207(a), Conducted Limit (dB μ V)	
	Quasi-Peak	Average
* 0.15- 0.45	66 - 56	56 - 46
0.45 - 0.5	56	46
0.5 - 30	60	50

Table 12. Conducted Limits for Intentional Radiators from FCC Part 15 § 15.207(a)

Test Results: See FCC ID: U9R-W2CBW003.

Electromagnetic Compatibility Criteria for Intentional Radiators

§ 15.247(a) 6 dB and 99% Bandwidth

Test Requirements: § 15.247(a): Operation under the provisions of this section is limited to frequency hopping and digitally modulated intentional radiators that comply with the following provisions:

For systems using digital modulation techniques, the EUT may operate in the 902-928 MHz, 2400-2483.5 MHz and 5725-5850 MHz bands. The minimum 6dB bandwidth shall be at least 500 kHz.

Test Results See FCC ID: U9R-W2CBW003.

Electromagnetic Compatibility Criteria for Intentional Radiators

§ 15.247(b) Peak Power Output and RF Exposure

Test Requirements: §15.247(b): The maximum peak output power of the intentional radiator shall not exceed the following:

Digital Transmission Systems (MHz)	Output Limit (Watts)
902-928	1.000
2400-2483.5	1.000
5725- 5850	1.000

Table 13. Output Power Requirements from §15.247

§15.247(c): if transmitting antennas of directional gain greater than 6 dBi are used the peak output power from the intentional radiator shall be reduced below the stated values in the Table 13, as appropriate, by the amount in dB that the directional gain of the antenna exceeds 6 dBi.

Systems operating in the 2400 – 2483.5 MHz band may employ transmitting antennas with directional gain greater than 6 dBi provided the maximum peak output power of the intentional radiator is reduced by 1 dB for every 3 dB that the directional gain of the antenna exceeds 6 dBi.

Systems operating in the 5725 – 5850 MHz band that are used exclusively for fixed, point-to-point operations may employ transmitting antennas with directional gain greater than 6 dBi without any corresponding reduction in transmitter peak output power.

Fixed, point-to-point operation excludes the use of point-to-multipoint systems, omnidirectional applications, and multiple co-located intentional radiators transmitting the same information. The operator of the spread spectrum intentional radiator or, if the equipment is professionally installed, the installer is responsible for ensuring that the system is used exclusively for fixed, point-to-point operations. The instruction manual furnished with the intentional radiator shall contain language in the installation instructions informing the operator and the installer of this responsibility.

Test Results: See FCC ID: U9R-W2CBW003.

Electromagnetic Compatibility Criteria for Intentional Radiators

Radiated Spurious Emissions Requirements and Band Edge

Test Requirements: §15.209: Emissions outside the frequency band.

§ 15.209 (a): Except as provided elsewhere in this subpart, the emissions from an intentional radiator shall not exceed the field strength levels specified in Table 14.

Frequency (MHz)	§ 15.209(a), Radiated Emission Limits (dBµV) @ 3m
30 - 88	40.00
88 - 216	43.50
216 - 960	46.00
Above 960	54.00

Table 14. Radiated Emissions Limits Calculated from FCC Part 15, § 15.209 (a)

§15.205(a): Except as shown in paragraph (d) of this section, only spurious emissions are permitted in any of the frequency bands listed below:

MHz	MHz	MHz	GHz
0.090–0.110-----	16.42–16.423	399.9–410	4.5–5.15
¹ 0.495–0.505-----	16.69475–16.69525	608–614	5.35–5.46
2.1735–2.1905-----	16.80425–16.80475	960–1240	7.25–7.75
4.125–4.128-----	25.5–25.67	1300–1427	8.025–8.5
4.17725–4.17775-----	37.5–38.25	1435–1626.5	9.0–9.2
4.20725–4.20775-----	73–74.6	1645.5–1646.5	9.3–9.5
6.215–6.218-----	74.8–75.2	1660–1710	10.6–12.7
6.26775–6.26825-----	108–121.94	1718.8–1722.2	13.25–13.4
6.31175–6.31225-----	123–138	2200–2300	14.47–14.5
8.291–8.294-----	149.9–150.05	2310–2390	15.35–16.2
8.362–8.366-----	156.52475–156.52525	2483.5–2500	17.7–21.4
8.37625–8.38675-----	156.7–156.9	2655–2900	22.01–23.12
8.41425–8.41475-----	162.0125–167.17	3260–3267	23.6–24.0
12.29–12.293-----	167.72–173.2	3332–3339	31.2–31.8
12.51975–12.52025-----	240–285	3345.8–3358.36	43–36.5
12.57675–12.57725-----	322–335.4	3600–4400	(²)

Table 15. Restricted Bands of Operation

¹ Until February 1, 1999, this restricted band shall be 0.490 – 0.510 MHz.

² Above 38.6

Test Procedures: The transmitter was turned on. Measurements were performed of the low, mid and high Channels. The EUT was rotated orthogonally through all three axes. Only noise floor was measured above 18 GHz.

Test Results: The EUT was compliant with the Radiated Spurious Emission limits of this section.

Test Engineer(s): Dusmantha Tennakoon

Test Date(s): 07/29/09

Emissions Requirements – Radiated

Mode	Channel	Frequency (GHz)	Measured Amplitude @ 25 cm (dBuV)	Antenna Correction Factor (dB) (+)	Pre-amp Gain (dB) (-)	Distance correction factor (dB) (-)	Corrected Amplitude @ 3m (dBuV/m)	Limit (dBuV/m)	Margin (dB)	Remark
b	1	1.2	59.71	24.5	31.9	21.58	30.73	74	-43.27	Peak
		1.2	57.45	24.5	31.9	21.58	28.47	54	-25.53	Avg.
		2.281	51.64	27.9	30.26	21.58	27.7	74	-46.3	Peak
		2.281	38.71	27.9	30.26	21.58	14.77	54	-39.23	Avg.
		4.824	45.94	33.8	29.8	21.58	28.36	74	-45.64	Peak
		4.824	39.33	33.8	29.8	21.58	21.75	54	-32.25	Avg.
	6	1.2603	55.08	24.5	31.9	21.58	26.1	74	-47.9	Peak
		1.2603	51.51	24.5	31.9	21.58	22.53	54	-31.47	Avg.
		1.768	49.77	27.9	30.26	21.58	25.83	74	-48.17	Peak
		1.768	42.32	27.9	30.26	21.58	18.38	54	-35.62	Avg.
		4.874	48.75	33.8	29.8	21.58	31.17	74	-42.83	Peak
		4.874	43.77	33.8	29.8	21.58	26.19	54	-27.81	Avg.
	11	1.26005	55.59	24.5	31.9	21.58	26.61	74	-47.39	Peak
		1.26005	52.8	24.5	31.9	21.58	23.82	54	-30.18	Avg.
		1.76785	53.02	27.9	30.26	21.58	29.08	74	-44.92	Peak
		1.76785	42.15	27.9	30.26	21.58	18.21	54	-35.79	Avg.
		4.924	51.09	33.8	29.8	21.58	33.51	74	-40.49	Peak
		4.924	47.38	33.8	29.8	21.58	29.8	54	-24.2	Avg.

Table 16. Radiated Harmonic Emissions, 802.11b

Mode	Channel	Frequency (GHz)	Measured Amplitude @ 1 m (dBuV)	Antenna Correction Factor (dB) (+)	Pre-amp Gain (dB) (-)	Distance correction factor (dB) (-)	Corrected Amplitude @ 3m (dBuV/m)	Limit (dBuV/m)	Margin (dB)	Remark
g	1	4.824	57.18	27.9	30.26	9.54	45.28	74	-28.72	Peak
		4.824	43.28	27.9	30.26	9.54	31.38	54	-22.62	Avg.
		7.236	48.15	33.8	29.8	9.54	42.61	74	-31.39	Peak
		7.236	26.93	33.8	29.8	9.54	21.39	54	-32.61	Avg.
	6	4.874	61.28	27.9	30.26	9.54	49.38	74	-24.62	Peak
		4.874	48.66	27.9	30.26	9.54	36.76	54	-17.24	Avg.
		7.311	50.15	33.8	29.8	9.54	44.61	74	-29.39	Peak
		7.311	27.98	33.8	29.8	9.54	22.44	54	-31.56	Avg.
	11	4.924	56.67	27.9	30.26	9.54	44.77	74	-29.23	Peak
		4.924	43.07	27.9	30.26	9.54	31.17	54	-22.83	Avg.
		7.386	47.19	33.8	29.8	9.54	41.65	74	-32.35	Peak
		7.386	26.81	33.8	29.8	9.54	21.27	54	-32.73	Avg.

Table 17. Radiated Harmonic Emissions, 802.11g

Note: All other emissions were measured at the noise floor of the spectrum analyzer.

Radiated Spurious Emissions

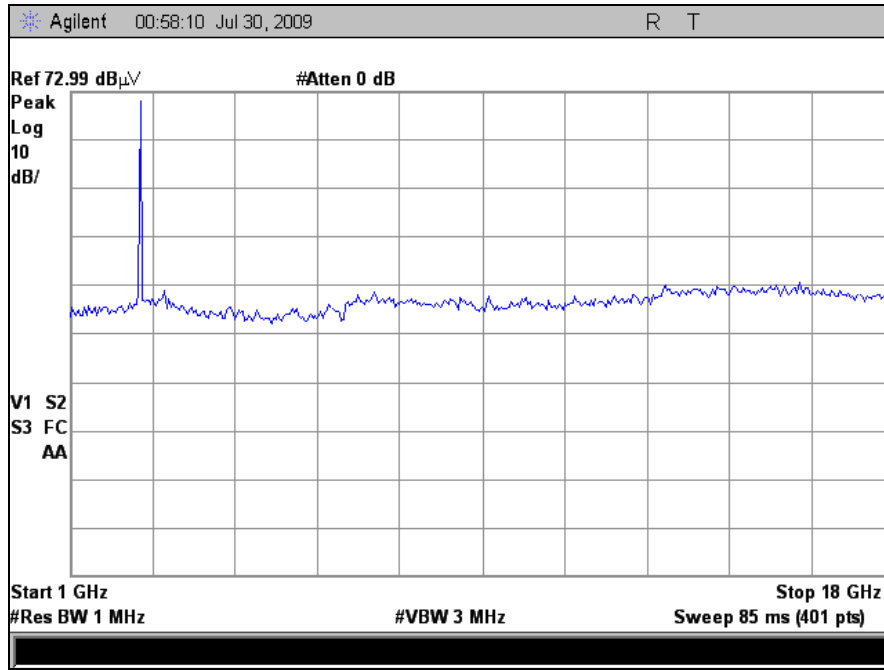

Plot 4. Radiated Spurious Emissions, 802.11b, Low Channel

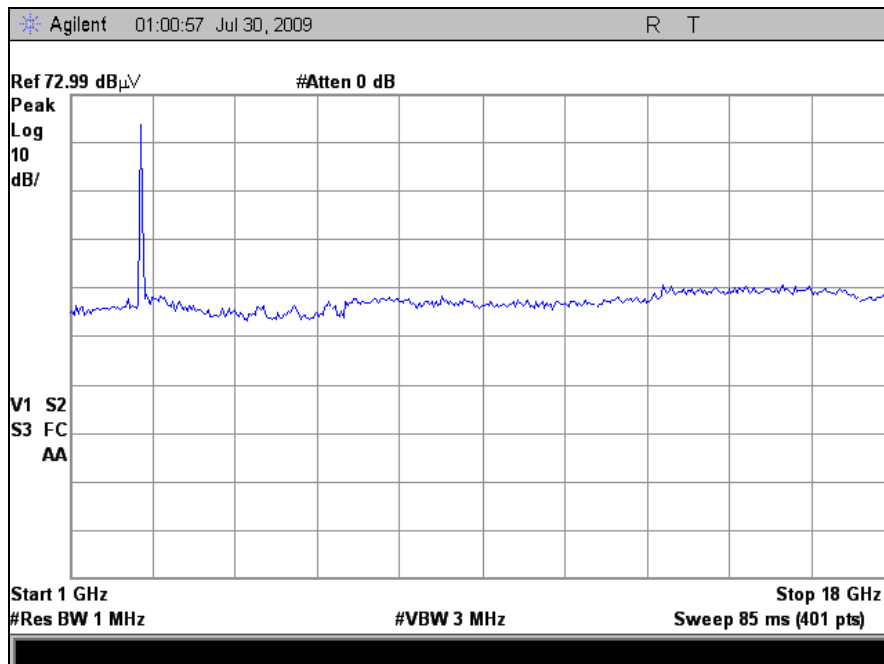

Plot 5. Radiated Spurious Emissions, 802.11b, Mid Channel

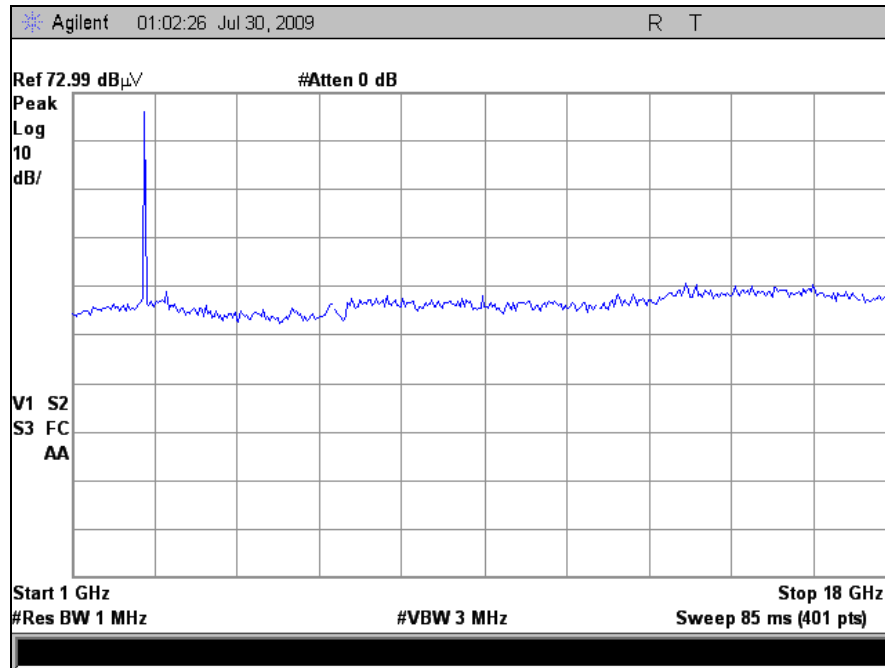

Plot 6. Radiated Spurious Emissions, 802.11b, High Channel

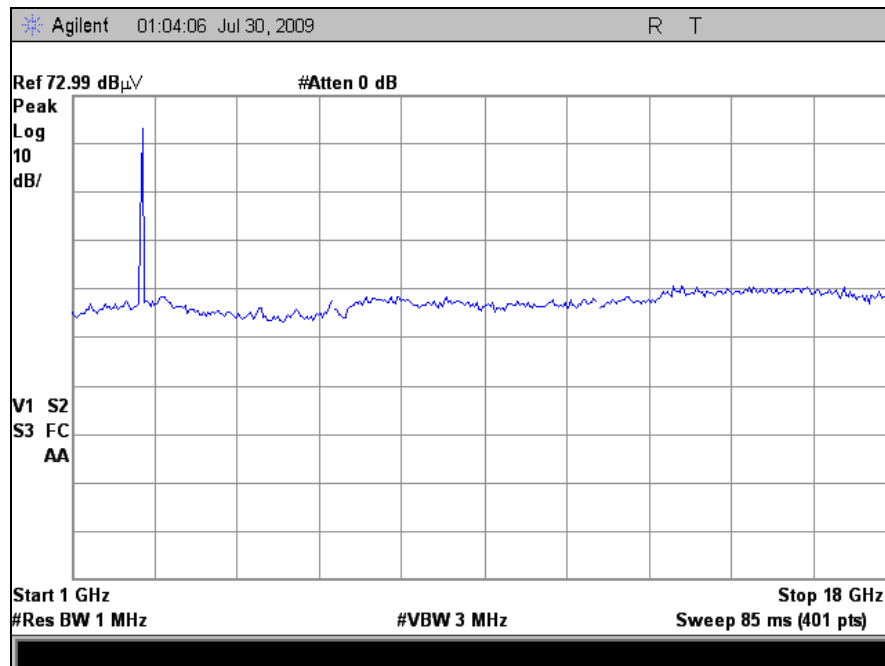

Plot 7. Radiated Spurious Emissions, 802.11g, Low Channel

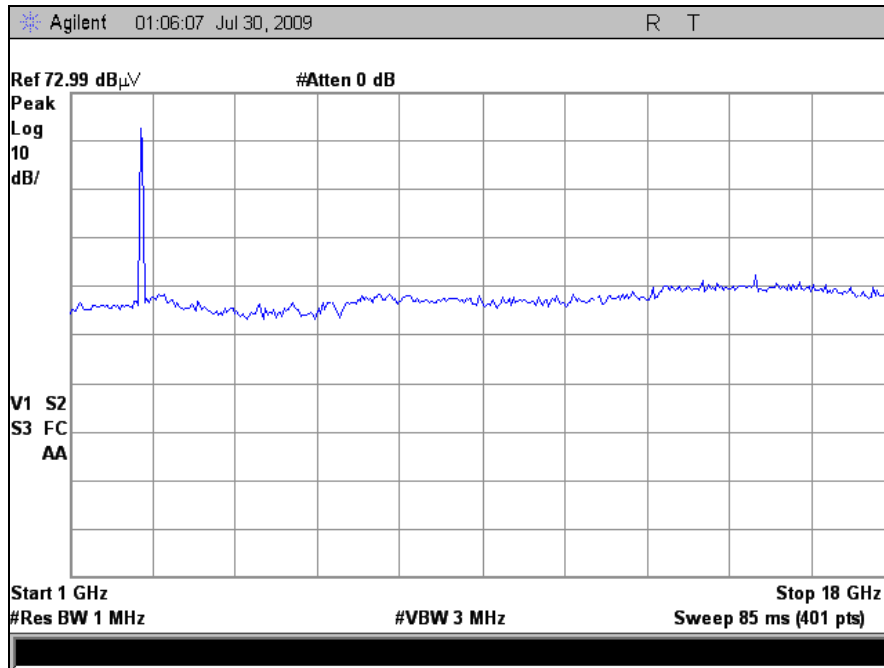

Plot 8. Radiated Spurious Emissions, 802.11g, Mid Channel

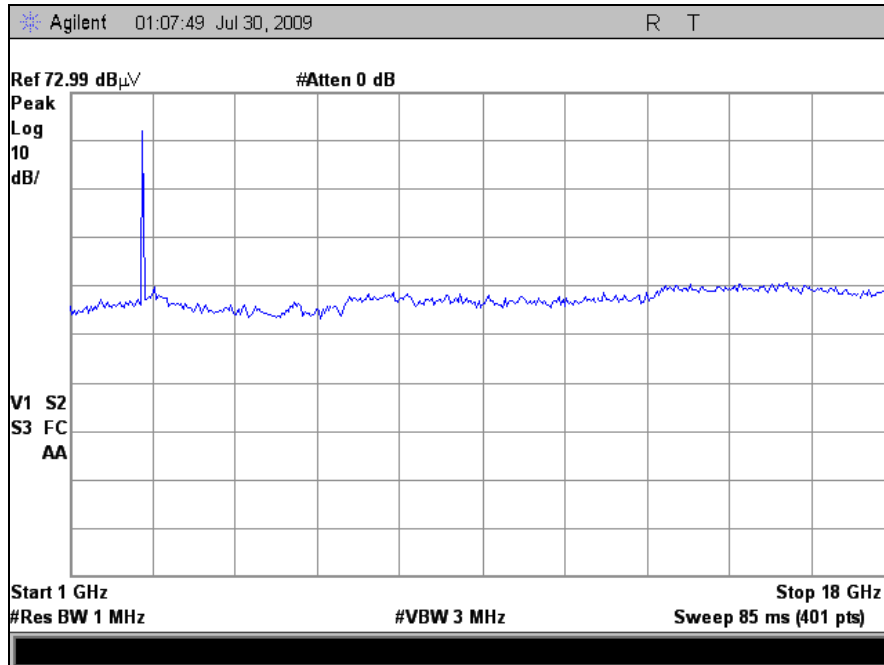

Plot 9. Radiated Spurious Emissions, 802.11g, High Channel

Frequency (GHz)	Measured Amplitude @ 25 cm (dBuV)	Antenna Correction Factor (dB) (+)	Pre-amp Gain (dB) (-)	Distance correction factor (dB) (-)	Corrected Amplitude @ 3m (dBuV/m)	Limit (dBuV/m)	Margin (dB)	Remark
1.2602	58.05	24.9	31.9	21.58	29.47	74	-44.53	Peak
1.2602	52.62	24.9	31.9	21.58	24.04	54	-29.96	Avg.
1.7674	54.74	27.9	30.26	21.58	30.8	74	-43.2	Peak
1.7674	48.52	27.9	30.26	21.58	24.58	54	-29.42	Avg.
4.8765	54.89	33.8	29.8	21.58	37.31	74	-36.69	Peak
4.8765	44.82	33.8	29.8	21.58	27.24	54	-26.76	Avg.

Table 18. Radiated Emissions, Bluetooth

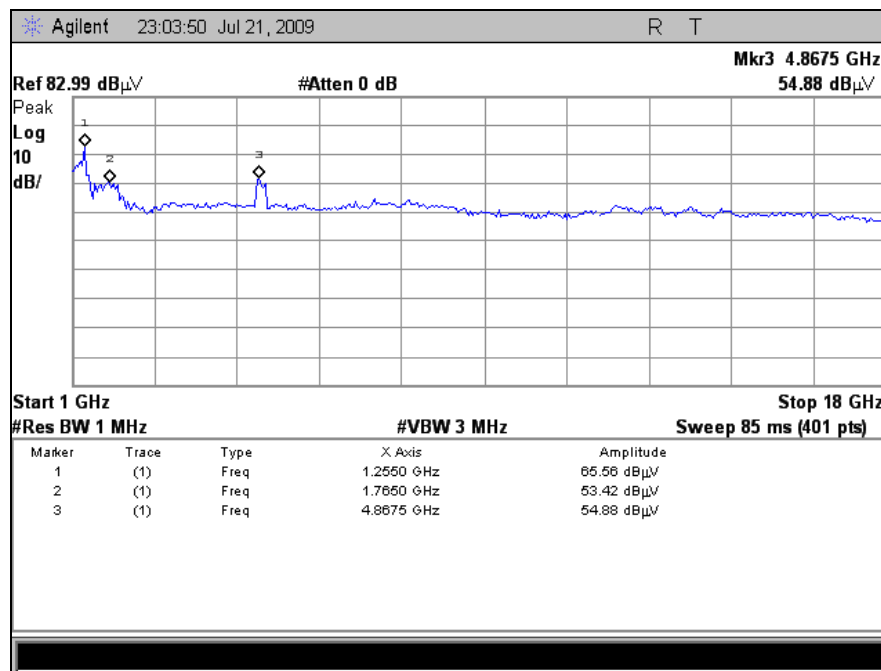

Plot 10. Radiated Spurious Emissions, Bluetooth

Radiated Band Edge Measurements

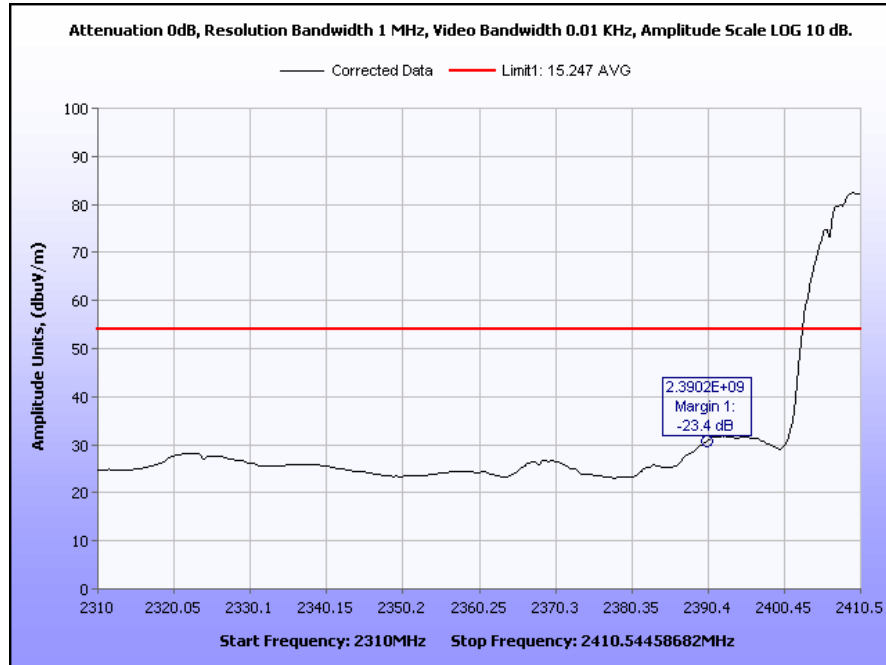

Plot 11. Lower Band Edge, Average, 802.11b

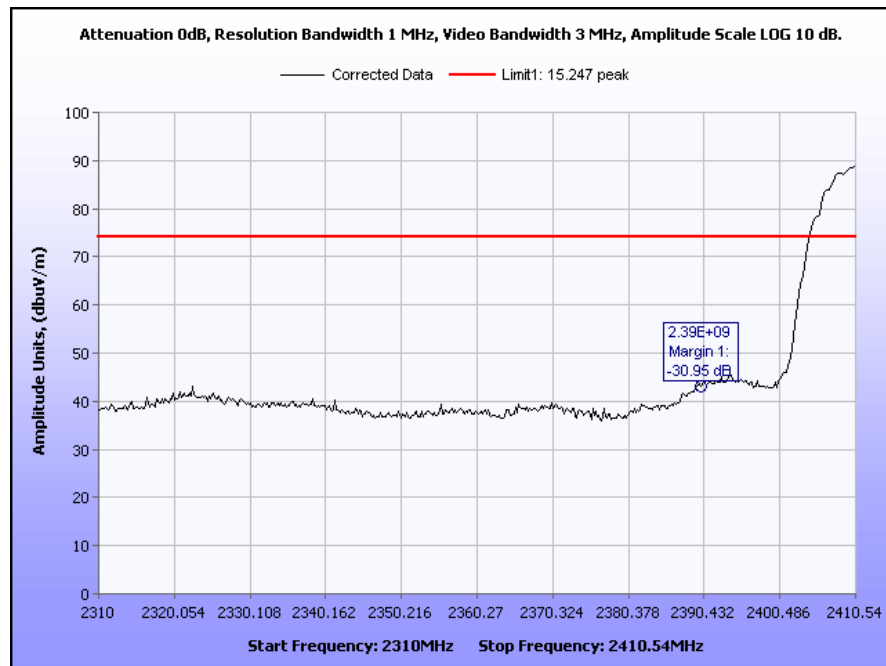

Plot 12. Lower Band Edge, Peak, 802.11b

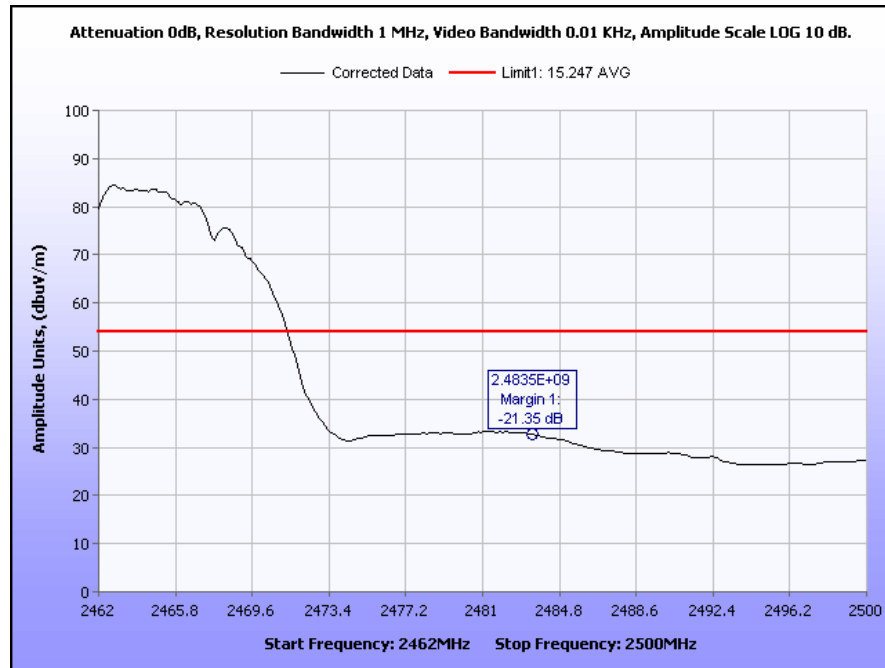

Plot 13. Upper Band Edge, Average, 802.11b

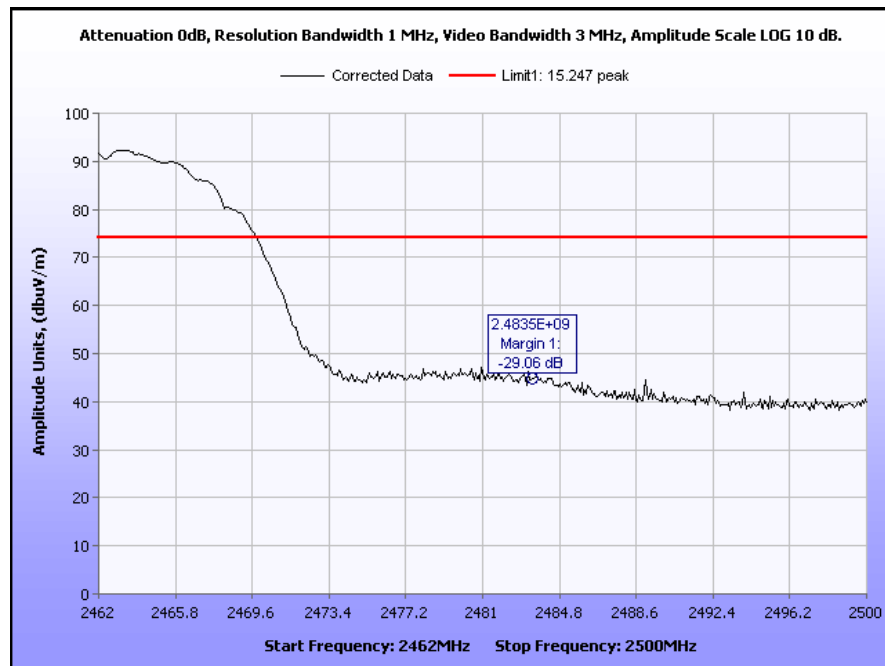

Plot 14. Upper Band Edge, Peak, 802.11b

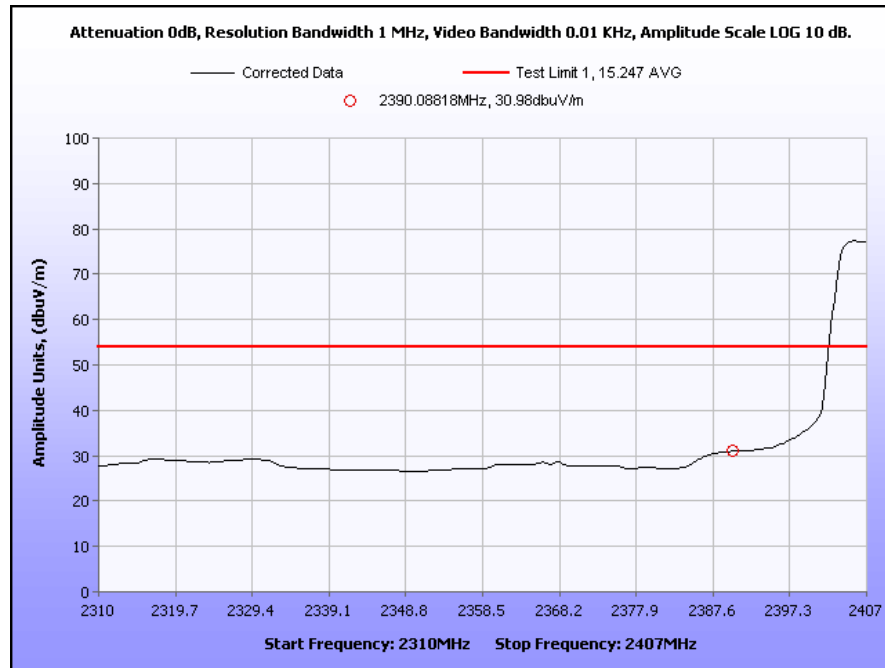

Plot 15. Lower Band Edge, Average, 802.11g

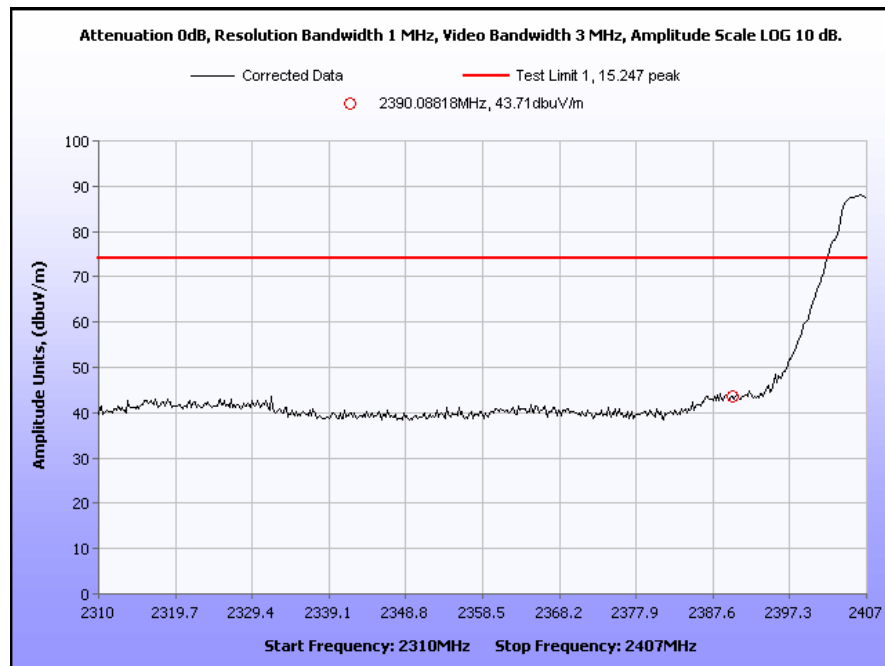

Plot 16. Lower Band Edge, Peak, 802.11g

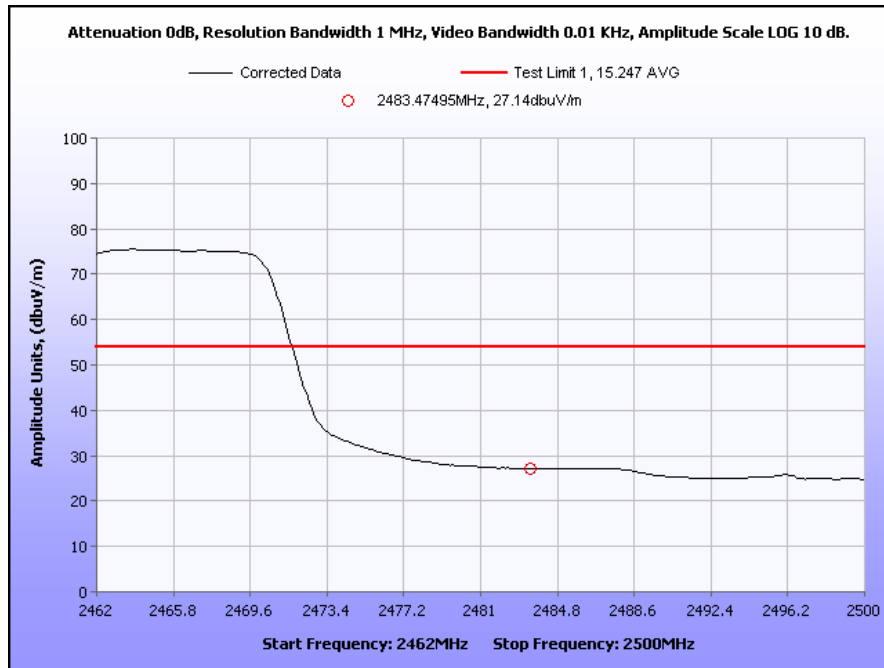

Plot 17. Upper Band Edge, Average, 802.11g

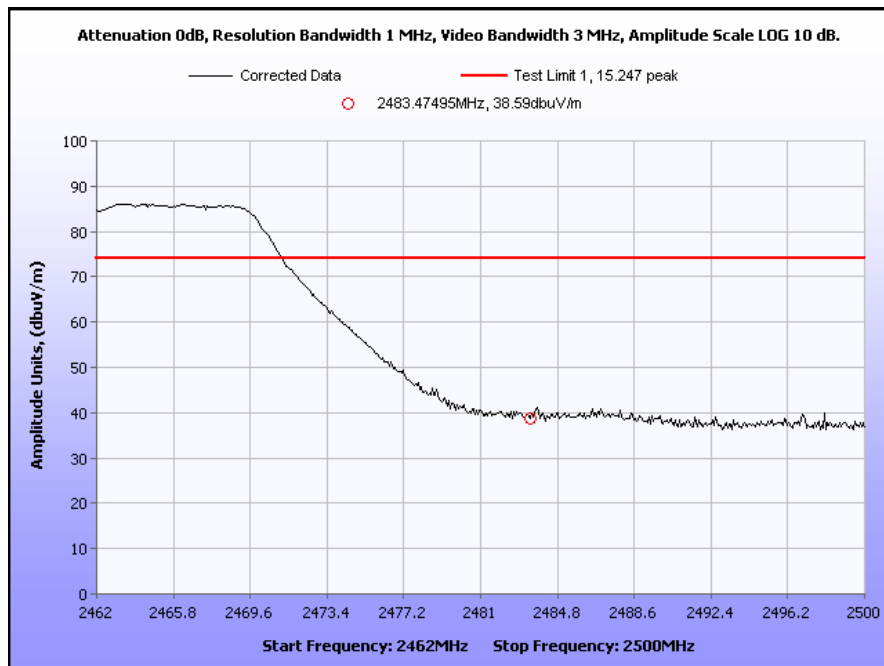

Plot 18. Upper Band Edge, Peak, 802.11g

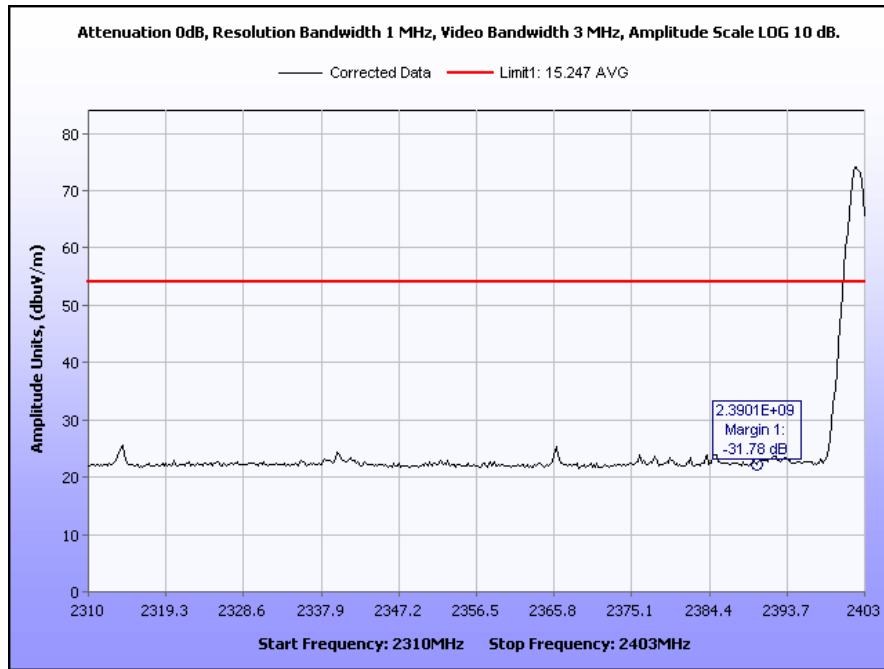

Plot 19. Lower Band Edge, Average Detector, Bluetooth

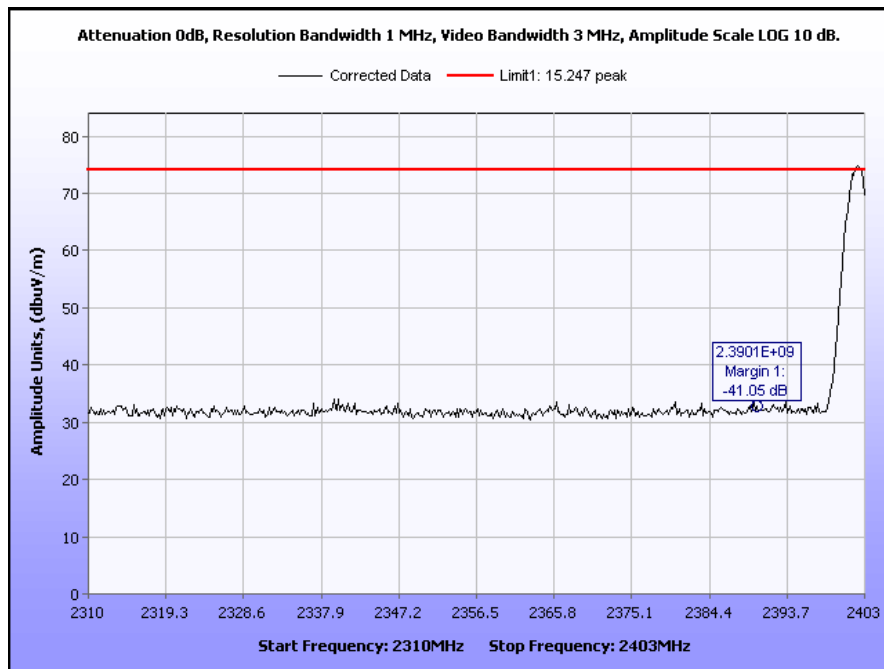

Plot 20. Lower Band Edge, Peak, Bluetooth

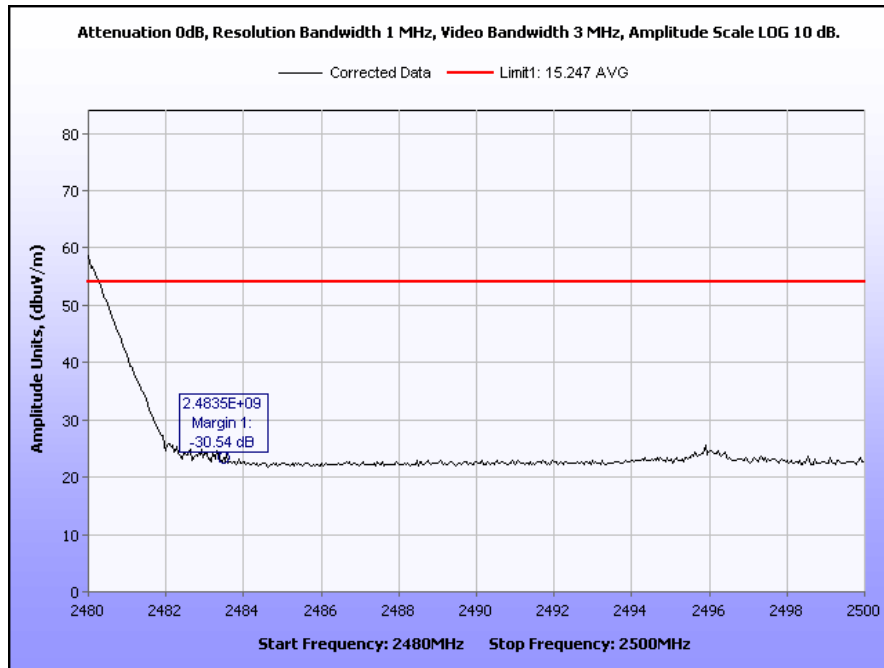

Plot 21. Upper Band Edge, Average Detector, Bluetooth

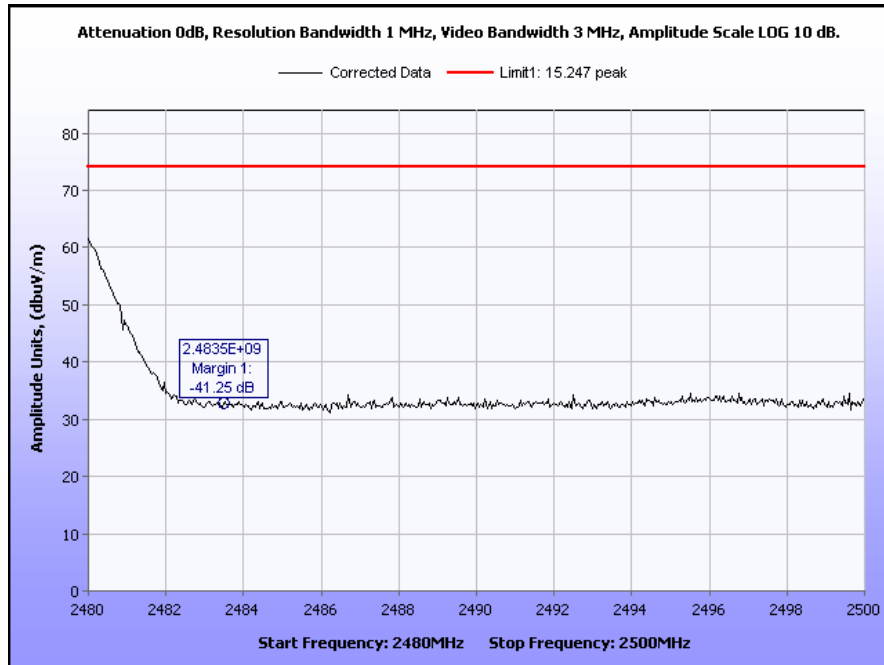

Plot 22. Upper Band Edge, Peak, Bluetooth



Photograph 3. Radiated Spurious Emission and Radiated Band Edge, Test Setup

Electromagnetic Compatibility Criteria for Intentional Radiators

§ 15.247(d) RF Conducted Spurious Emissions Requirements and Band Edge

Test Requirement: **15.247(d)** In any 100 kHz bandwidth outside the frequency band in which the spread spectrum or digitally modulated intentional radiator is operating, the radio frequency power that is produced by the intentional radiator shall be at least 20 dB below that in the 100 kHz bandwidth within the band that contains the highest level of the desired power, based on either an RF conducted or a radiated measurement, provided the transmitter demonstrates compliance with the peak conducted power limits. If the transmitter complies with the conducted power limits based on the use of RMS averaging over a time interval, as permitted under paragraph (b)(3) of this section, the attenuation required under this paragraph shall be 30 dB instead of 20 dB.

Test Results: See FCC ID: U9R-W2CBW003.

Electromagnetic Compatibility Criteria for Intentional Radiators

§ 15.247(e) Peak Power Spectral Density

Test Requirements: §15.247(e): For digitally modulated systems, the peak power spectral density conducted from the intentional radiator to the antenna shall not be greater than 8dBm in any 3 kHz band during any time interval of continuous transmission.

Test Results: See FCC ID: U9R-W2CBW003.

IV. Test Equipment

Test Equipment

Calibrated test equipment utilized during testing was maintained in a current state of calibration per the requirements of ANSI/NCSL Z540-1-1994 and ANSI/ISO/IEC 17025:2000.

Test Name: Conducted Emissions (15.107)					Test Date(s): 01/26/09	
MET Asset #	Nomenclature	Manufacturer	Model	Last Cal Date	Cal Due Date	
1T4621	ESA-E SERIES SPECTRUM ANALYZER	AGILENT	E4402B	02/29/2008	03/01/2009	
1T4214	SHIELD ROOM #4	UNIVERSAL SHIELD INC	N/A	SEE NOTE		
1T4564	LISN (24 AMP)	SOLAR ELECTRONICS	9252-50-R-24-BNC	09/25/2008	09/25/2009	
1T4619	THERMO-HYGROMETER	CONTROL COMPANY	S6-627-9	11/07/2008	11/07/2010	
1T4502	COMB GENERATOR	COM-POWER	CGC-255	09/08/2008	09/08/2009	
Test Name: Radiated Emissions (15.109)					Test Date(s): 01/26/09	
MET Asset #	Nomenclature	Manufacturer	Model	Last Cal Date	Cal Due Date	
1T4300	SEMI-ANECHOIC CHAMBER # 1	EMC TEST SYSTEMS	NONE	02/17/2006	05/17/2009	
1T4303	ANTENNA; BILOG	SCHAFNER - CHASE EMC	CBL6140A	07/07/2008	07/07/2009	
1T4409	EMI RECEIVER	ROHDE & SCHWARZ	ESIB7	04/18/2008	04/18/2009	
1T4632	THERMO/HYGROMETER	CONTROL COMPANY	S6-627-9	09/25/2007	09/25/2009	
1T4568	RADIATING NOISE SOURCE	MET LABORATORIES	N/A	SEE NOTE		
Test Name: Radiated Spurious Emissions (15.205 and 15.209)					Test Date(s): 07/21/2009	
MET Asset #	Nomenclature	Manufacturer	Model	Last Cal Date	Cal Due Date	
1T4300	SEMI-ANECHOIC CHAMBER # 1	EMC TEST SYSTEMS	NONE	08/24/2007	08/24/2010	
1T4612	ESA-E SERIES SPECTRUM ANALYZER	AGILENT	E4407B	02/17/2009	02/17/2010	
1T4442	PRE-AMPLIFIER, MICROWAVE	MITEQ	AFS42-01001800-30-10P	SEE NOTE		
1T2511	ANTENNA; HORN	EMCO	3115	07/29/2008	07/29/2009	
1T4592	RF FILTER KIT	VARIOUS	N/A	SEE NOTE		

Note: Functionally tested equipment is verified using calibrated instrumentation at the time of testing.

V. Certification & User's Manual Information

Certification & User's Manual Information

A. Certification Information

The following is extracted from Title 47 of the Code of Federal Regulations, Part 2, Subpart I — Marketing of Radio frequency devices:

§ 2.801 Radio-frequency device defined.

As used in this part, a radio-frequency device is any device which in its operation is capable of Emitting radio-frequency energy by radiation, conduction, or other means. Radio- frequency devices include, but are not limited to:

- (a) The various types of radio communication transmitting devices described throughout this chapter.
- (b) *The incidental, unintentional and intentional radiators defined in Part 15 of this chapter.*
- (c) The industrial, scientific, and medical equipment described in Part 18 of this chapter.
- (d) Any part or component thereof which in use emits radio-frequency energy by radiation, conduction, or other means.

§ 2.803 Marketing of radio frequency devices prior to equipment authorization.

- (a) Except as provided elsewhere in this chapter, no person shall sell or lease, or offer for sale or lease (including advertising for sale or lease), or import, ship or distribute for the purpose of selling or leasing or offering for sale or lease, any radio frequency device unless:
 - (1) In the case of a device subject to certification, such device has been authorized by the Commission in accordance with the rules in this chapter and is properly identified and labeled as required by §2.925 and other relevant sections in this chapter; or
 - (2) In the case of a device that is not required to have a grant of equipment authorization issued by the Commission, but which must comply with the specified technical standards prior to use, such device also complies with all applicable administrative (including verification of the equipment or authorization under a Declaration of Conformity, where required), technical, labeling and identification requirements specified in this chapter.
- (d) Notwithstanding the provisions of paragraph (a) of this section, the offer for sale solely to business, commercial, industrial, scientific or medical users (but not an offer for sale to other parties or to end users located in a residential environment) of a radio frequency device that is in the conceptual, developmental, design or pre-production stage is permitted prior to equipment authorization or, for devices not subject to the equipment authorization requirements, prior to a determination of compliance with the applicable technical requirements *provided* that the prospective buyer is advised in writing at the time of the offer for sale that the equipment is subject to the FCC rules and that the equipment will comply with the appropriate rules before delivery to the buyer or to centers of distribution.

- (e)(1) Notwithstanding the provisions of paragraph (a) of this section, prior to equipment authorization or determination of compliance with the applicable technical requirements any radio frequency device may be operated, but not marketed, for the following purposes and under the following conditions:
- (i) *Compliance testing*;
 - (ii) Demonstrations at a trade show provided the notice contained in paragraph (c) of this section is displayed in a conspicuous location on, or immediately adjacent to, the device;
 - (iii) Demonstrations at an exhibition conducted at a business, commercial, industrial, scientific or medical location, but excluding locations in a residential environment, provided the notice contained in paragraphs (c) or (d) of this section, as appropriate, is displayed in a conspicuous location on, or immediately adjacent to, the device;
 - (iv) Evaluation of product performance and determination of customer acceptability, provided such operation takes place at the manufacturer's facilities during developmental, design or pre-production states; or
 - (v) Evaluation of product performance and determination of customer acceptability where customer acceptability of a radio frequency device cannot be determined at the manufacturer's facilities because of size or unique capability of the device, provided the device is operated at a business, commercial, industrial, scientific or medical user's site, but not at a residential site, during the development, design or pre-production stages.
- (e)(2) For the purpose of paragraphs (e)(1)(iv) and (e)(1)(v) of this section, the term *manufacturer's facilities* includes the facilities of the party responsible for compliance with the regulations and the manufacturer's premises, as well as the facilities of other entities working under the authorization of the responsible party in connection with the development and manufacture, but not the marketing, of the equipment.
- (f) For radio frequency devices subject to verification and sold solely to business, commercial, industrial, scientific and medical users (excluding products sold to other parties or for operation in a residential environment), parties responsible for verification of the devices shall have the option of ensuring compliance with the applicable technical specifications of this chapter at each end user's location after installation, provided that the purchase or lease agreement includes a proviso that such a determination of compliance be made and is the responsibility of the party responsible for verification of the equipment.

Certification & User's Manual Information

The following is extracted from Title 47 of the Code of Federal Regulations, Part 2, Subpart J — Equipment Authorization Procedures:

§ 2.901 Basis and Purpose

- (a) In order to carry out its responsibilities under the Communications Act and the various treaties and international regulations, and in order to promote efficient use of the radio spectrum, the Commission has developed technical standards for radio frequency equipment and parts or components thereof. The technical standards applicable to individual types of equipment are found in that part of the rules governing the service wherein the equipment is to be operated.¹ *In addition to the technical standards provided, the rules governing the service may require that such equipment be verified by the manufacturer or importer, be authorized under a Declaration of Conformity, or receive an equipment authorization from the Commission by one of the following procedures: certification or registration.*
- (b) The following sections describe the verification procedure, the procedure for a Declaration of Conformity, and the procedures to be followed in obtaining certification from the Commission and the conditions attendant to such a grant.

§ 2.907 Certification.

- (a) Certification is an equipment authorization issued by the Commission, based on representation and test data submitted by the applicant.
- (b) Certification attaches to all units subsequently marketed by the grantee which are identical (see Section 2.908) to the sample tested except for permissive changes or other variations authorized by the Commission pursuant to Section 2.1043.

¹ In this case, the equipment is subject to the rules of Part 15. More specifically, the equipment falls under Subpart B (of Part 15), which deals with unintentional radiators.

Certification & User's Manual Information

§ 2.948 Description of measurement facilities.

- (a) Each party making measurements of equipment that is subject to an equipment authorization under Part 15 or Part 18 of this chapter, regardless of whether the measurements are filed with the Commission or kept on file by the party responsible for compliance of equipment marketed within the U.S. or its possessions, shall compile a description of the measurement facilities employed.
- (1) If the measured equipment is subject to the verification procedure, the description of the measurement facilities shall be retained by the party responsible for verification of the equipment.
- (i) *If the equipment is verified through measurements performed by an independent laboratory, it is acceptable for the party responsible for verification of the equipment to rely upon the description of the measurement facilities retained by or placed on file with the Commission by that laboratory. In this situation, the party responsible for the verification of the equipment is not required to retain a duplicate copy of the description of the measurement facilities.*
- (ii) If the equipment is verified based on measurements performed at the installation site of the equipment, no specific site calibration data is required. It is acceptable to retain the description of the measurement facilities at the site at which the measurements were performed.
- (2) If the equipment is to be authorized by the Commission under the certification procedure, the description of the measurement facilities shall be filed with the Commission's Laboratory in Columbia, Maryland. The data describing the measurement facilities need only be filed once but must be updated as changes are made to the measurement facilities or as otherwise described in this section. At least every three years, the organization responsible for filing the data with the Commission shall certify that the data on file is current.

Certification & User's Manual Information

Label and User's Manual Information

The following is extracted from Title 47 of the Code of Federal Regulations, Part 15, Subpart A — General:

§ 15.19 Labeling requirements.

(a) *In addition to the requirements in Part 2 of this chapter, a device subject to certification or verification shall be labeled as follows:*

- (1) Receivers associated with the operation of a licensed radio service, e.g., FM broadcast under Part 73 of this chapter, land mobile operation under Part 90, etc., shall bear the following statement in a conspicuous location on the device:

This device complies with Part 15 of the FCC Rules. Operation is subject to the condition that this device does not cause harmful interference.

- (2) A stand-alone cable input selector switch, shall bear the following statement in a conspicuous location on the device:

This device is verified to comply with Part 15 of the FCC Rules for use with cable television service.

- (3) All other devices shall bear the following statement in a conspicuous location on the device:

This device complies with Part 15 of the FCC Rules. Operation is subject to the following two conditions: (1) This device may not cause harmful interference, and (2) this device must accept any interference received, including interference that may cause undesired operation.

- (4) Where a device is constructed in two or more sections connected by wires and marketed together, the statement specified under paragraph (a) of this section is required to be affixed only to the main control unit.

- (5) When the device is so small or for such use that it is not practicable to place the statement specified under paragraph (a) of this section on it, the information required by this paragraph shall be placed in a prominent location in the instruction manual or pamphlet supplied to the user or, alternatively, shall be placed on the container in which the device is marketed. However, the FCC identifier or the unique identifier, as appropriate, must be displayed on the device.

§ 15.21 Information to user.

The users manual or instruction manual for an intentional or unintentional radiator shall caution the user that changes or modifications not expressly approved by the party responsible for compliance could void the user's authority to operate the equipment.

Verification & User's Manual Information

The following is extracted from Title 47 of the Code of Federal Regulations, Part 15, Subpart B — Unintentional Radiators:

§ 15.105 Information to the user.

- (a) For a Class A digital device or peripheral, the instructions furnished the user shall include the following or similar statement, placed in a prominent location in the text of the manual:

Note: This equipment has been tested and found to comply with the limits for a Class A digital device, pursuant to Part 15 of the FCC Rules. These limits are designed to provide reasonable protection against harmful interference when the equipment is operated in a commercial environment. This equipment generates, uses, and can radiate radio frequency energy and, if not installed and used in accordance with the instruction manual, may cause harmful interference to radio communications. Operation of this equipment in a residential area is likely to cause harmful interference in which case the user will be required to correct the interference at own expense.

- (b) For a Class B digital device or peripheral, the instructions furnished the user shall include the following or similar statement, placed in a prominent location in the text of the manual:

Note: This equipment has been tested and found to comply with the limits for a Class B digital device, pursuant to Part 15 of the FCC Rules. These limits are designed to provide reasonable protection against harmful interference when the equipment is operated in a residential environment. This equipment generates, uses, and can radiate radio frequency energy and, if not installed and used in accordance with the instruction manual, may cause harmful interference to radio communications. However, there is no guarantee that interference will not occur in a particular installation. If this equipment does cause harmful interference to radio or television reception, which can be determined by turning the equipment off and on, the user is encouraged to try to correct the interference by one or more of the following measures:

- Reorient or relocate the receiving antenna.
- Increase the separation between the equipment and receiver.
- Connect the equipment into an outlet on a circuit different from that to which the receiver is connected.
- Consult the dealer or an experienced radio/TV technician for help.

ICES-003 Procedural & Labeling Requirements

From the Industry Canada Electromagnetic Compatibility Advisory Bulletin entitled, "Implementation and Interpretation of the Interference-Causing Equipment Standard for Digital Apparatus, ICES-003" (EMCAB-3, Issue 2, July 1995):

"At present, CISPR 22: 2002 and ICES technical requirements are essentially equivalent. Therefore, if you have CISPR 22: 2002 approval by meeting CISPR Publication 22, the only additional requirements are: to attach a note to the report of the test results for compliance, indicating that these results are deemed satisfactory evidence of compliance with ICES-003 of the Canadian Interference-Causing Equipment Regulations; to maintain these records on file for the requisite five year period; and to provide the device with a notice of compliance in accordance with ICES-003."

Procedural Requirements:

According to Industry Canada's Interference Causing Equipment Standard for Digital Apparatus ICES-003 Issue 4, February 2004:

- Section 6.1: A record of the measurements and results, showing the date that the measurements were completed, shall be retained by the manufacturer or importer for a period of at least five years from the date shown in the record and made available for examination on the request of the Minister.
- Section 6.2: A written notice indicating compliance must accompany each unit of digital apparatus to the end user. The notice shall be in the form of a label that is affixed to the apparatus. Where because of insufficient space or other constraints it is not feasible to affix a label to the apparatus, the notice may be in the form of a statement in the user's manual.

Labeling Requirements:

The suggested text for the notice, in English and in French, is provided below, from the Annex of ICES-003:

This Class [²] digital apparatus complies with Canadian ICES-003.

Cet appareil numérique de la classe [¹] est conforme à la norme NMB-003 du Canada.

² Insert either A or B but not both as appropriate for the equipment requirements.

End of Report