



# FCC TEST REPORT

According to

## FCC CFR Title 47 Part 15 Subpart C

Applicant	: Pegatron Corporation
Address	: 5F., No.76, Ligong St., Beitou District, Taipei City 112, Taiwan
Manufacturer	: Maintek Computer(Suzhou) Co., Ltd
Address	: No.233 JinFeng Road., SuZhou City, JiangSu Province, China
Equipment	: IP Set-Top
Model No.	: Cisco CX041AE1; Cisco ITV8100; Cisco ITV81000; CX041AE1; ITV8100; ITV81000
FCC ID	: VUIITV8100

- The test result refers exclusively to the test presented test model / sample.
- Without written approval of **Cerpass Technology Corp.** the test report shall not be reproduced except in full.
- The test report must not be used by the clients to claim product certification approval by **NVLAP** or any agency of the Government.



## Table of Contents

<b>1. Report of Measurements and Examinations .....</b>	<b>6</b>
1.1 List of Measurements and Examinations .....	6
<b>2. Test Configuration of Equipment under Test .....</b>	<b>7</b>
2.1 Feature of Equipment under Test .....	7
2.2 Antenna List .....	7
2.3 Carrier Frequency of Channels .....	7
2.4 Test Manner .....	8
2.5 Description of Test System .....	8
2.6 General Information of Test .....	9
2.7 Measurement Uncertainty .....	10
<b>3. Antenna Requirements .....</b>	<b>11</b>
3.1 Standard Applicable .....	11
3.2 Antenna Construction and Directional Gain .....	11
<b>4. Test of Conducted Emission .....</b>	<b>12</b>
4.1 Test Limit .....	12
4.2 Test Procedures .....	12
4.3 Typical Test Setup .....	13
4.4 Measurement Equipment .....	14
4.5 Test Result and Data .....	15
<b>5. Test of Radiated Emission .....</b>	<b>17</b>
5.1 Test Limit .....	17
5.2 Test Procedures .....	18
5.3 Typical Test Setup .....	18
5.4 Measurement Equipment .....	19
5.5 Test Result and Data .....	20
<b>6. Occupied Bandwidth .....</b>	<b>24</b>
6.1 Test Limit .....	24
6.2 Test Procedures .....	24
6.3 Test Setup Layout .....	24
6.4 Measurement Equipment .....	24
6.5 Test Result and Data .....	25
<b>7. Maximum Peak Output Power .....</b>	<b>27</b>
7.1 Test Limit .....	27
7.2 Test Procedure .....	27
7.3 Test Setup Layout .....	27
7.4 Measurement Equipment .....	27
7.5 Test Result and Data .....	28
<b>8. Band Edges Measurement .....</b>	<b>29</b>
8.1 Test Limit .....	29
8.2 Test Procedure .....	29



---

8.3	Test Setup Layout.....	29
8.4	Measurement Equipment .....	29
8.5	Test Result and Data .....	30
<b>9.</b>	<b>Power Spectral Density .....</b>	<b>34</b>
9.1	Test Limit.....	34
9.2	Test Procedure .....	34
9.3	Test Setup Layout.....	34
9.4	Measurement Equipment .....	34
9.5	Test Result and Data .....	35



Document history

ORIGINAL.

Additional attachment as following record:

Attachment No.	Date	Description



# FCC TEST REPORT

according to

## FCC CFR Title 47 Part 15 Subpart C

Applicant	: Pegatron Corporation
Address	: 5F., No.76, Ligong St., Beitou District, Taipei City 112, Taiwan
Manufacturer	: Maintek Computer(Suzhou) Co., Ltd
Address	: No.233 JinFeng Road., SuZhou City, JiangSu Province, China
Equipment	: IP Set-Top
Model No.	: Cisco CX041AE1; Cisco ITV8100; Cisco ITV81000; CX041AE1; ITV8100; ITV81000
FCC ID	: VUIITV8100

I HEREBY CERTIFY THAT :

The measurements shown in this test report were made in accordance with the procedures given in **ANSI C63.4 – 2009** and the energy emitted by this equipment was **passed** **CISPR PUB. 22 and FCC Part 15** in both radiated and conducted emission class B limits. Testing was carried out on Dec 23,2014 at **Cerpass Technology Corp.**

Signature

Miro Chueh/ Technical director



## 1. Report of Measurements and Examinations

### 1.1 List of Measurements and Examinations

FCC Rule	Description of Test	Result
15.203	Antenna Requirement	Pass
15.207	Conducted Emission	Pass
15.247(d)	Radiated Emission	Pass
15.247(a)(2)	6dB Bandwidth	Pass
15.247(b)	Maximum Peak Output Power	Pass
15.247(d)	Band Edge Emissions	Pass
15.247(e)	Power Spectral Density	Pass



## 2. Test Configuration of Equipment under Test

### 2.1 Feature of Equipment under Test

Items	Description
Product Name	IP Set-Top
Model No.	Cisco CX041AE1; Cisco ITV8100; Cisco ITV81000; CX041AE1; ITV8100; ITV81000
Modulation	DSSS(O-QPSK)
Data Rate	DSSS(250kbps)
Frequency Range	2425~2475
Channel Number	3

### 2.2 Antenna List

Antenna No.	Model Name	Antenna Type	Antenna Gain (dBi)
1	Xi4 PCB Antenna	PCB Antenna	4.55dBi

### 2.3 Carrier Frequency of Channels

Channel	Frequency(MHz)
15	2425
20	2450
25	2475



## 2.4 Test Manner

Preliminary tests were performed in different data rate to find the worst radiated emission. The data rate shown in the table below is the worst-case rate with respect to the specific test item. Investigation has been down on all the possible configurations for searching the worst cases. The following table is a list of the test modes shown in this test report.

Control Software		Tera Term VT		
Test Items	Test Mode	Data Rate	Test Channel	Antenna
Maximum Conducted Output Power	Continued Tx mode	250kbps	15/20/25	--
Power Spectral Density	Continued Tx mode	250kbps	15/20/25	--
6dB spectrum Bandwidth	Continued Tx mode	250kbps	15/20/25	--
Radiated Emission	Continued Tx mode	250kbps	15/20/25	1
Band Edge Emission	Continued Tx mode	250kbps	15/25	1

## 2.5 Description of Test System

No	Device	Manufacturer	Model No.	Description
N/A	N/A	N/A	N/A	N/A

Use Cable:

No.	Cable	Quantity	Description
N/A	N/A	N/A	N/A





## 2.6 General Information of Test

Test Site:	CerpPASS Technology Corp.
Performand Location :	No.66,Tangzhuang Road, Suzhou Industrial Park, Jiangsu 215006, China
NVLAP LAB Code :	200814-0
FCC Registration Number :	916572, 331395
IC Registration Number :	7290A-1, 7290A-2
VCCI Registration Number :	T-343 for Telecommunication Test C-2919 for Conducted emission test R-2670 for Radiated emission test below 1GHz G-227 for Radiated emission test above 1GHz



## 2.7 Measurement Uncertainty

Measurement Item	Measurement Frequency	Polarization	Uncertainty
Conducted Emission	9 kHz ~ 30 MHz	LINE/NEUTRAL	$\pm 2.71$ dB
Radiated Emission	30 MHz ~ 25GHz	Vertical	$\pm 4.11$ dB
		Horizontal	$\pm 4.10$ dB
Occupied Bandwidth	---	---	$\pm 7500$ Hz
Maximum Peak Output Power	---	---	$\pm 1.4$ dB
Band Edges	---	---	$\pm 2.2$ dB
Power Spectral Density	---	---	$\pm 2.2$ dB



### 3. Antenna Requirements

#### 3.1 Standard Applicable

For intentional device, according to FCC 47 CFR Section 15.203, an intentional radiator shall be designed to ensure that no antenna other than that furnished by the responsible party shall be used with the device.

And according to FCC 47 CFR Section 15.247 (b), if transmitting antennas of directional gain greater than 6dBi are used, the power shall be reduced by the amount in dB that the directional gain of the antenna exceeds 6dBi.

#### 3.2 Antenna Construction and Directional Gain

Antenna type: PCB Antenna

Antenna Gain: 4.55 dBi



## 4. Test of Conducted Emission

### 4.1 Test Limit

Conducted Emissions were measured from 150 kHz to 30 MHz with a bandwidth of 9 KHz on the 120 VAC power and return leads of the EUT according to the methods defined in ANSI C63.4-2003 Section 3.1. The EUT was placed on a nonmetallic stand in a shielded room 0.8 meters above the ground plane as shown in section 2.2. The interface cables and equipment positioning were varied within limits of reasonable applications to determine the position produced maximum conducted emissions.

Frequency (MHz)	Quasi Peak (dB $\mu$ V)	Average (dB $\mu$ V)
0.15 – 0.5	66-56*	56-46*
0.5 – 5.0	56	46
5.0 – 30.0	60	50

\*Decreases with the logarithm of the frequency.

### 4.2 Test Procedures

The EUT was setup according to ANSI C63.4, 2003 and tested according to DTS test procedure of Oct 2002 KDB558074 for compliance to FCC 47CFR 15.247 requirements.

The EUT was placed on a platform of nominal size, 1 m by 1.5 m, raised 80 cm above the conducting ground plane. The vertical conducting plane was located 40 cm to the rear of the EUT. All other surfaces of EUT were at least 80 cm from any other grounded conducting surface. The EUT and simulators are connected to the main power through a line impedance stabilization network (LISN). The LISN provides a 50 ohm /50uH coupling impedance for the measuring equipment. The peripheral devices are also connected to the main power through a LISN. (Please refer to the block diagram of the test setup and photographs)

Each current-carrying conductor of the EUT power cord, except the ground (safety) conductor, was individually connected through a LISN to the input power source.

The excess length of the power cord between the EUT and the LISN receptacle were folded back and forth at the center of the lead to form a bundle not exceeding 40 cm in length.

Conducted emissions were investigated over the frequency range from 0.15MHz to 30MHz using a receiver bandwidth of 9kHz.



### 4.3 Typical Test Setup

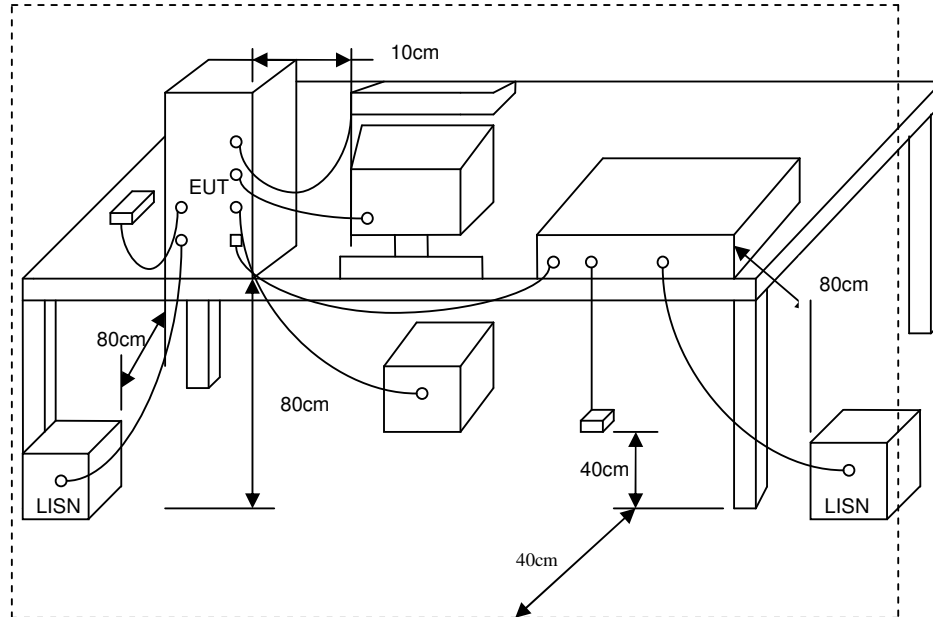



#### 4.4 Measurement Equipment

Instrument/Ancillary	Manufacturer	Model No.	Serial No.	Calibration Date	Valid Date.
Test Receiver	R&S	ESCI	100565	2014.03.24	2015.03.23
AMN	R&S	ESH2-Z5	100182	2014.09.11	2015.09.10
ISN	FCC	FCC-TLISN-T2-02	20379	2014.03.24	2015.03.23
ISN	FCC	FCC-TLISN-T4-02	20380	2014.03.24	2015.03.23
ISN	FCC	FCC-TLISN-T8-02	20381	2014.03.24	2015.03.23
ISN	TESEQ	ISN ST08	30175	2014.03.24	2015.03.23
Current Probe	R&S	EZ-17	100303	2014.04.04	2015.04.03
Passive Voltage Probe	R&S	ESH2-Z3	100026	2014.03.24	2015.03.23
Pulse Limiter	R&S	ESH3-Z2	100529	2014.03.24	2015.03.23
Temperature/ Humidity Meter	Zhicheng	ZC1-11	CEP-TH-004	2014.03.31	2015.03.30



### 4.5 Test Result and Data

Test Mode :	Normal Link	Phase :	Line
Temperature :	20°C	Humidity:	51%
Pressur(mbar) :	1002	Date:	2014-12-23

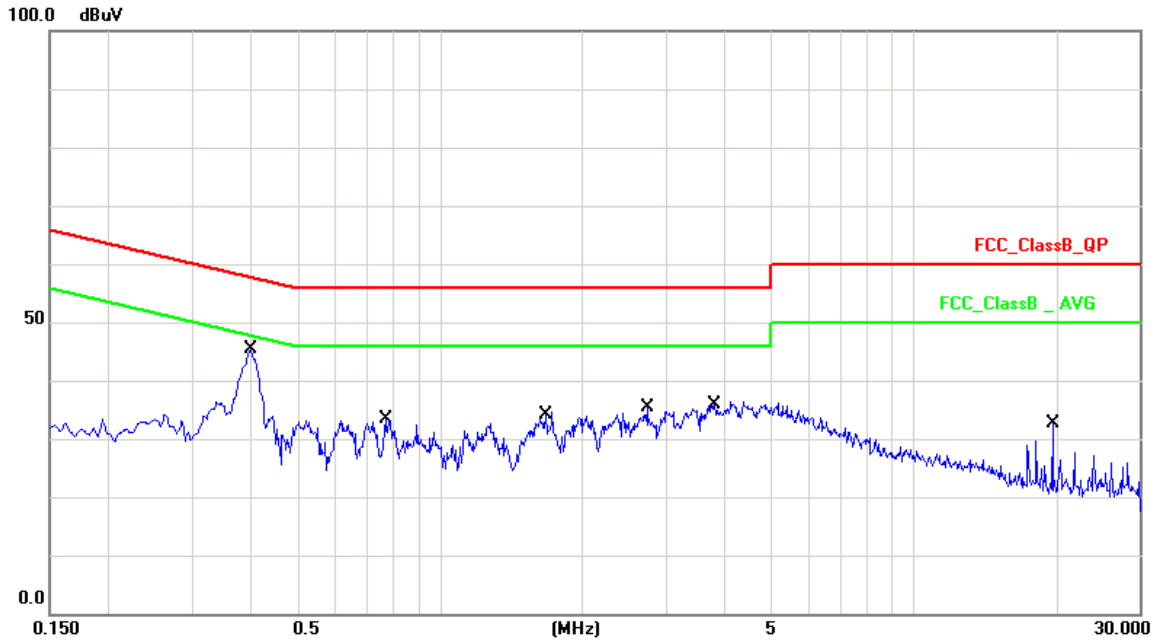

No.	Frequency (MHz)	Factor (dB)	Reading (dBuV)	Level (dBuV)	Limit (dBuV)	Margin (dB)	Detector
1	0.3980	10.15	31.86	42.01	57.90	-15.89	QP
2	0.3980	10.15	24.97	35.12	47.90	-12.78	AVG
3	0.7700	10.14	16.59	26.73	56.00	-29.27	QP
4	0.7700	10.14	9.62	19.76	46.00	-26.24	AVG
5	1.6740	10.17	16.71	26.88	56.00	-29.12	QP
6	1.6740	10.17	10.47	20.64	46.00	-25.36	AVG
7	2.7460	10.18	19.33	29.51	56.00	-26.49	QP
8	2.7460	10.18	12.13	22.31	46.00	-23.69	AVG
9	3.8100	10.20	20.45	30.65	56.00	-25.35	QP
10	3.8100	10.20	12.08	22.28	46.00	-23.72	AVG
11	19.6620	10.35	19.38	29.73	60.00	-30.27	QP
12	19.6620	10.35	14.28	24.63	50.00	-25.37	AVG

Note: Measurement Level = Reading Level + Correct Factor



Test Mode :	Normal Link	Phase :	Neutral
Temperature :	20°C	Humidity :	51%
Pressur(mbar) :	1002	Date :	2014-12-23

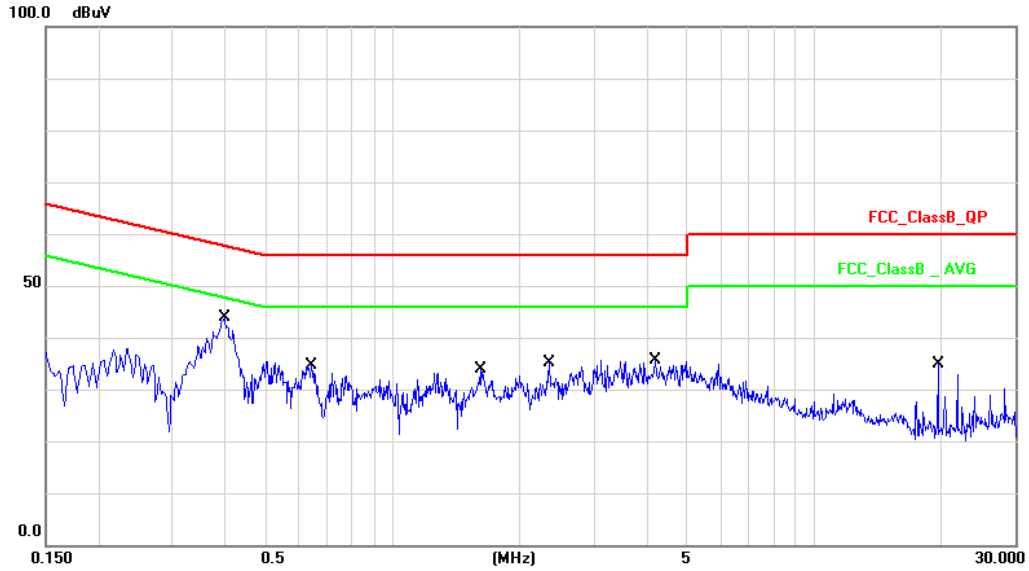

No.	Frequency (MHz)	Factor (dB)	Reading (dBuV)	Level (dBuV)	Limit (dBuV)	Margin (dB)	Detector
1	0.3980	10.15	29.96	40.11	57.89	-17.78	QP
2	0.3980	10.15	24.68	34.83	47.89	-13.06	AVG
3	0.6419	10.16	19.54	29.70	56.00	-26.30	QP
4	0.6419	10.16	13.36	23.52	46.00	-22.48	AVG
5	1.6180	10.18	17.68	27.86	56.00	-28.14	QP
6	1.6180	10.18	12.50	22.68	46.00	-23.32	AVG
7	2.3580	10.19	17.38	27.57	56.00	-28.43	QP
8	2.3580	10.19	11.44	21.63	46.00	-24.37	AVG
9	4.2100	10.22	17.73	27.95	56.00	-28.05	QP
10	4.2100	10.22	10.57	20.79	46.00	-25.21	AVG
11	19.6620	10.45	22.35	32.80	60.00	-27.20	QP
12	19.6620	10.45	17.48	27.93	50.00	-22.07	AVG

Note: Measurement Level = Reading Level + Correct Factor





## 5. Test of Radiated Emission

### 5.1 Test Limit

Radiated emissions from 9 KHz to 25 GHz were measured according to the methods defines in ANSI C63.4-2003. The EUT was placed, 0.8 meter above the ground plane, as shown in section 5.6.3. The interface cables and equipment positions were varied within limits of reasonable applications to determine the positions producing maximum radiated emissions

For unintentional device, according to § 15.109(a), except for Class A digital devices, the field strength of radiated emissions from unintentional radiators at a distance of 3 meters shall not exceed the following values:

FREQUENCIES(MHz)	FIELD STRENGTH (microvolts/meter)	MEASUREMENT DISTANCE(meters)
0.009~0.490	2400/F(kHz)	300
0.490~1.705	24000/F(kHz)	30
1.705~30.0	30	30
30~88	100	3
88~216	150	3
216~960	200	3
Above 960	500	3

For unintentional device, according to CISPR PUB.22, for Class B digital devices, the general requirement of field strength of radiated emissions from intentional radiators at a distance of 10 meters shall not exceed the below table.

Frequency (MHz)	Distance Meters	Radiated (dB $\mu$ V/ m)
30-230	10	30
230-1000	10	37



## 5.2 Test Procedures

- a. The EUT was placed on a rotatable table top 0.8 meter above ground.
- b. The EUT was set 3 meters from the interference receiving antenna which was mounted on the top of a variable height antenna tower.
- c. The table was rotated 360 degrees to determine the position of the highest radiation.
- d. The antenna is a broadband antenna and its height is varied between one meter and four meters above ground to find the maximum value of the field strength both horizontal polarization and vertical polarization of the antenna are set to make the measurement.
- e. For each suspected emission the EUT was arranged to its worst case and then tune the antenna tower (from 1 M to 4 M) and turn table (from 0 degree to 360 degrees) to find the maximum reading.
- f. Set the test-receiver system to Peak or CISPR quasi-peak Detect Function and specified bandwidth with Maximum Hold Mode.
- g. If the emission level of the EUT in peak mode was 3 dB lower than the limit specified, then testing will be stopped and peak values of EUT will be reported, otherwise, the emissions which do not have 3 dB margin will be repeated one by one using the quasi-peak method and reported.
- h. For testing above 1GHz, the emission level of the EUT in peak mode was 20dB lower than average limit (that means the emission level in peak mode also complies with the limit in average mode), then testing will be stopped and peak values of EUT will be reported, otherwise, the emissions will be measured in average mode again and reported.

## 5.3 Typical Test Setup

Below 1GHz Test Setup

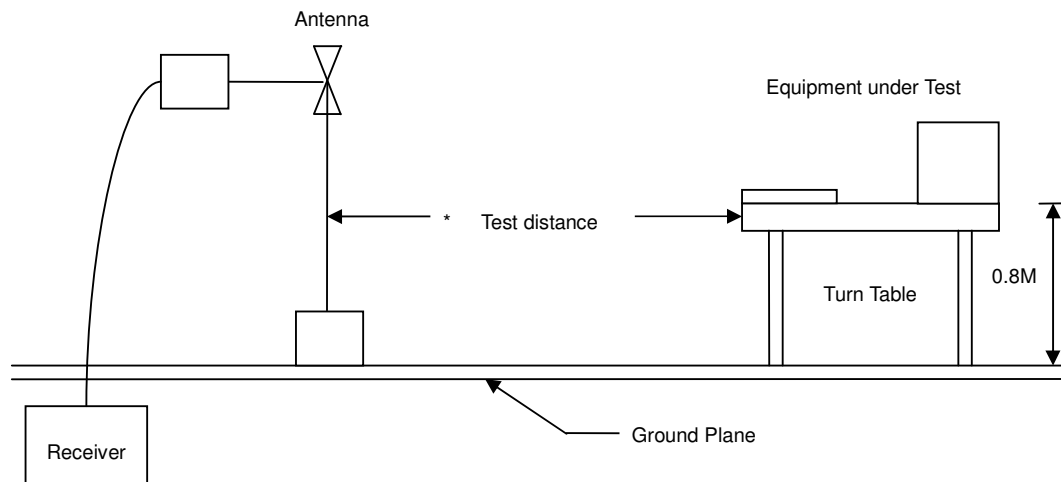

Above 1GHz Test Setup

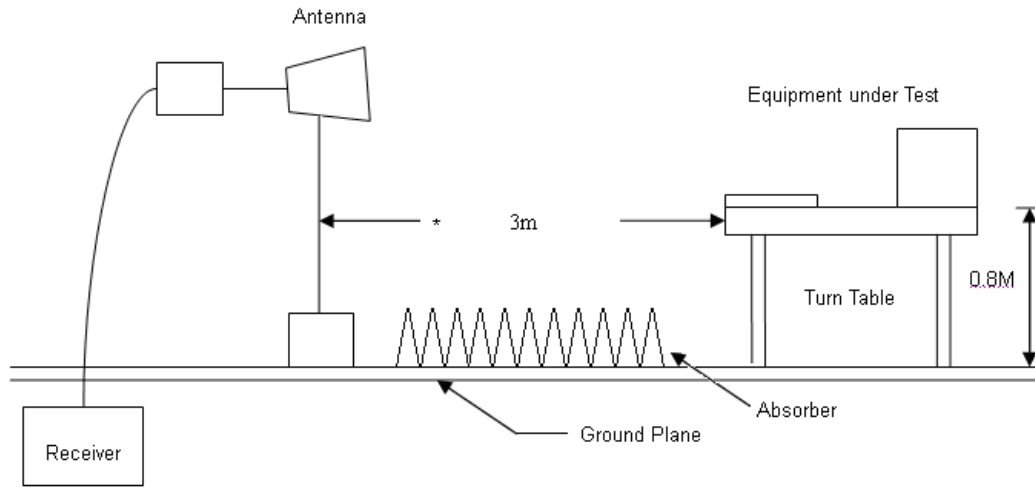

### 5.4 Measurement Equipment

Instrument	Model No.	Manufacturer	Serial No.	Calibration Date	Valid Date
EMI Test Receiver	R&S	ESCI	100563	2014.02.10	2015.02.09
H64 Preamplifier	HP	8447F	3113A05582	2014.03.10	2015.03.09
Preamplifier	Agilent	8449B	3008A02342	2014.03.10	2015.03.09
Ultra Broadband Antenna	R&S	HL562	100362	2015.05.02	2015.05.01
Broad-Band Horn Antenna	Schwarzbeck	BBHA9120D	9120D-619	2014.05.02	2015.05.01
Broad-Band Horn Antenna	Schwarzbeck	BBHA9170	9170-347	2014.05.12	2015.05.11
Spectrum Analyzer	R&S	FSP40	100324	2014.03.10	2015.03.09
Temperature/ Humidity Meter	Zhicheng	ZC1-11	CEP-TH-002	2014.03.10	2015.03.09



## 5.5 Test Result and Data

### Under 1G:

Site : EMC Lab AC 102	Time : 2014-12-23
Limit : FCC_CLASS_B_03M_QP	Margin : 6
EUT : IP SET-TOP	Probe : VERTICAL/ HORIZONTAL
	Note : Normal Link

Frequency (MHz)	AntPol. H/V	Correct Factor (dB)	Reading level (dBuV)	Measure Level (dBuV/m)	Limit 3m (dBuV/m)	Safe Margin (dB)	Detector mode (PK/QP)
251.1595	H	-8.74	45.14	36.40	46	-9.6	QP
358.9048	H	-4.41	49.39	44.98	46	-1.02	QP
376.9872	H	-4.95	46.27	41.32	46	-4.68	QP
480.7018	H	-1.10	40.39	39.29	46	-6.71	QP
600.3654	H	-1.05	38.95	37.90	46	-8.10	QP
960.7484	H	3.17	36.47	39.64	54	-14.36	QP
56.3693	V	-16.94	49.28	32.34	40	-7.66	QP
250.7415	V	-8.74	46.49	37.75	46	-8.25	QP
359.6971	V	-4.41	46.36	41.95	46	-4.05	QP
480.3235	V	-1.10	42.17	41.07	46	-4.93	QP
500.8777	V	-2.20	40.39	38.19	46	-7.81	QP
600.9682	V	-1.05	42.33	41.28	46	-4.72	QP

### Note:

1. All Readings below 1GHz are Quasi-Peak, above are performed with peak and/or average measurements as necessary.
2. Measurement Level = Reading Level + Correct Factor

**Above 1G:**

Site : EMC Lab AC 102	Time : 2014-12-23
Limit : FCC_15_03M_PK	Margin : 6
EUT : IP SET-TOP	Probe : VERTICAL/ HORIZONTAL
	Note : 2425MHz

Frequency (MHz)	AntPol. H/V	Correct Factor (dB)	Reading level (dBuV)	Measure Level (dBuV/m)	Limit 3m (dBuV/m)	Safe Margin (dB)	Detector mode
4844.000	H	6.46	42.29	48.75	74.00	-25.25	PK
4844.000	H	6.46	27.96	34.42	54.00	-19.58	AVG
4844.000	V	6.46	43.08	49.54	74.00	-24.46	PK
4844.000	V	6.46	27.93	34.39	54.00	-19.61	AVG

**Note:**

1. All Readings below 1GHz are Quasi-Peak, above are performed with peak and/or average measurements as necessary.
2. Measurement Level = Reading Level + Correct Factor



Site : EMC Lab AC 102	Time : 2014-12-23
Limit : FCC_15_03M_PK	Margin : 6
EUT : IP SET-TOP	Probe : VERTICAL/ HORIZONTAL
	Note : 2450MHz

Frequency (MHz)	AntPol. H/V	Correct Factor (dB)	Reading level (dBuV)	Measure Level (dBuV/m)	Limit 3m (dBuV/m)	Safe Margin (dB)	Detector mode
4898.000	H	6.60	40.74	47.34	74.00	-26.66	PK
4898.000	H	6.60	28.44	35.04	54.00	-18.96	AVG
4898.000	V	6.60	41.66	47.26	74.00	-26.74	PK
4898.000	V	6.60	29.09	34.69	54.00	-19.31	AVG

Note:

1. All Readings below 1GHz are Quasi-Peak, above are performed with peak and/or average measurements as necessary.
2. Measurement Level = Reading Level + Correct Factor



Site : EMC Lab AC 102	Time : 2014-12-23
Limit : FCC_15_03M_PK	Margin : 6
EUT : IP SET-TOP	Probe : VERTICAL/ HORIZONTAL
	Note : 2475MHz

Frequency (MHz)	AntPol. H/V	Correct Factor (dB)	Reading level (dBuV)	Measure Level (dBuV/m)	Limit 3m (dBuV/m)	Safe Margin (dB)	Detector mode
4952.000	H	6.73	40.75	47.48	74.00	-26.52	PK
4952.000	H	6.73	28.52	35.25	54.00	-18.75	AVG
4952.000	V	6.73	40.50	47.23	74.00	-26.77	PK
4952.000	V	6.73	29.10	35.83	54.00	-18.17	AVG

Note:

1. All Readings below 1GHz are Quasi-Peak, above are performed with peak and/or average measurements as necessary.
2. Measurement Level = Reading Level + Correct Factor



## 6. Occupied Bandwidth

### 6.1 Test Limit

Systems using digital modulation techniques may operate in the 902 - 928 MHz, 2400 - 2483.5 MHz, and 5725- 5850 MHz band. The minimum 6 dB bandwidth shall be at least 500 kHz.

### 6.2 Test Procedures

- a. The transmitter output was connected to the spectrum analyzer.
- b. Set RBW of spectrum analyzer to 1~5% of the emission bandwidth and  $VBW \geq 3x RBW$ .
- c. The 6 dB bandwidth is defined as the total spectrum the power of which is higher than peak power minus 6 dB.
- d. The 6dB Bandwidth was measured and recorded.

### 6.3 Test Setup Layout

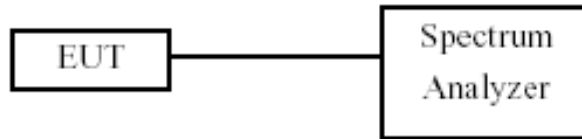

### 6.4 Measurement Equipment

Instrument/Ancillary	Model No.	Manufacturer	Serial No.	Calibration Date	Valid Date
Spectrum Analyzer	Agilent	N9010A	MY53400169	2014.09.28	2015.09.27





6.5 Test Result and Data

Test Item	Occupied Bandwidth
Test Mode	Transmit by DSSS(O-QPSK)
Test Date	2014-12-23

Channel No.	Frequency (MHz)	Measurement Level (kHz)	Required Limit (kHz)	Result
15	2425	1624	500	Pass
20	2450	1619	500	Pass
25	2475	1626	500	Pass

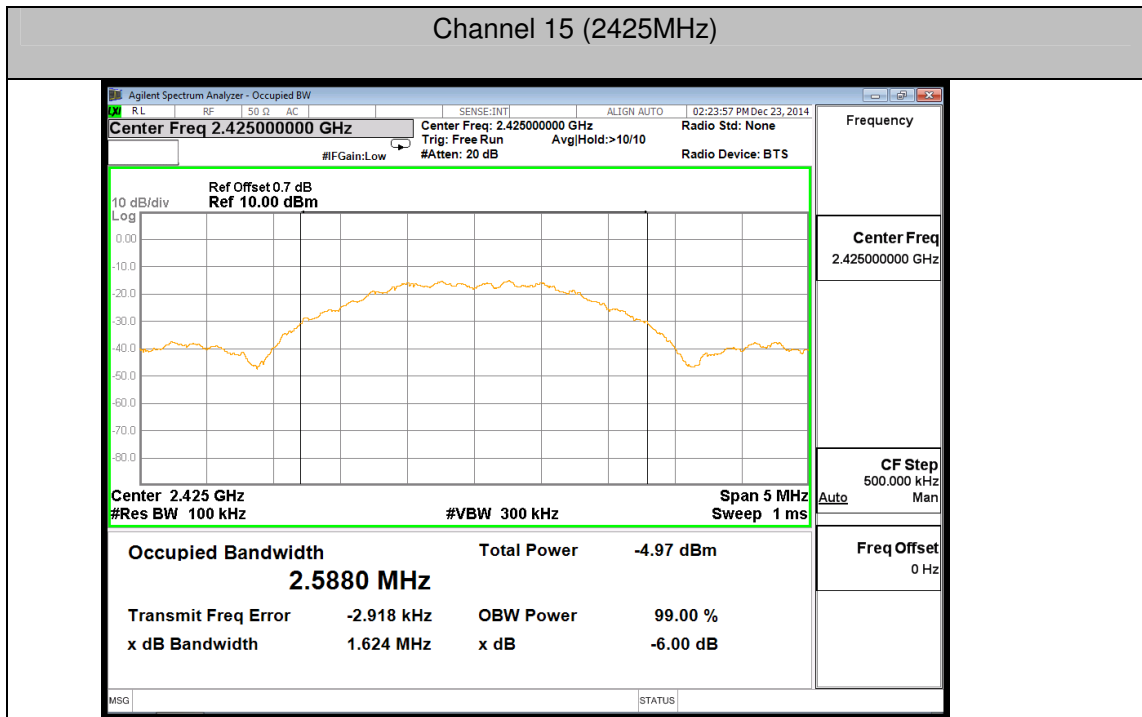



### Channel 20 (2450MHz)

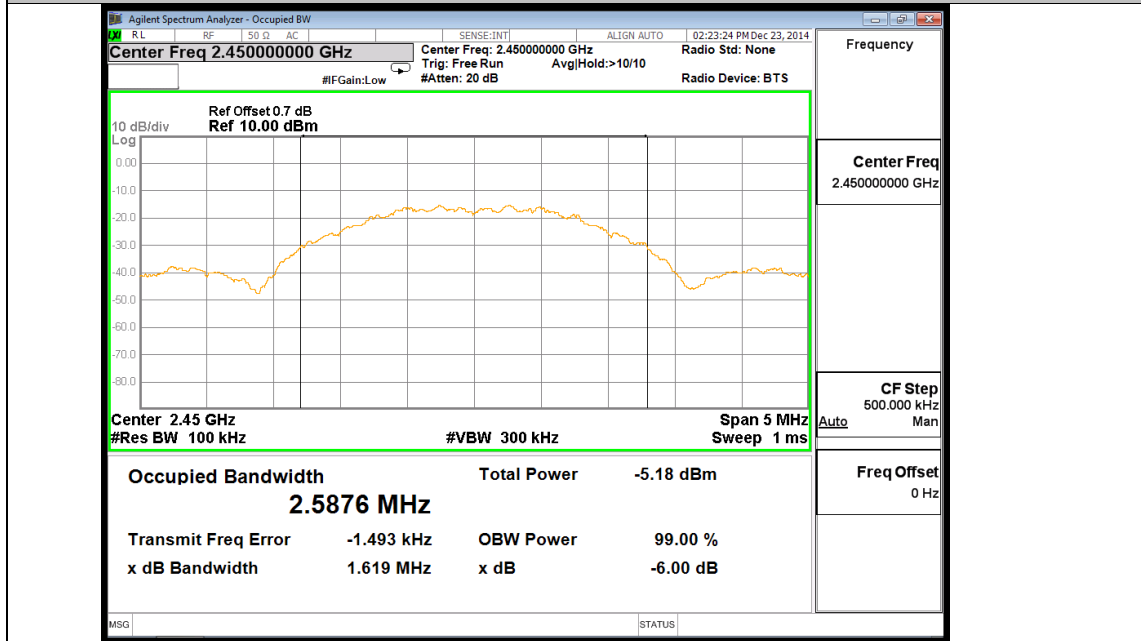

### Channel 25 (2475MHz)

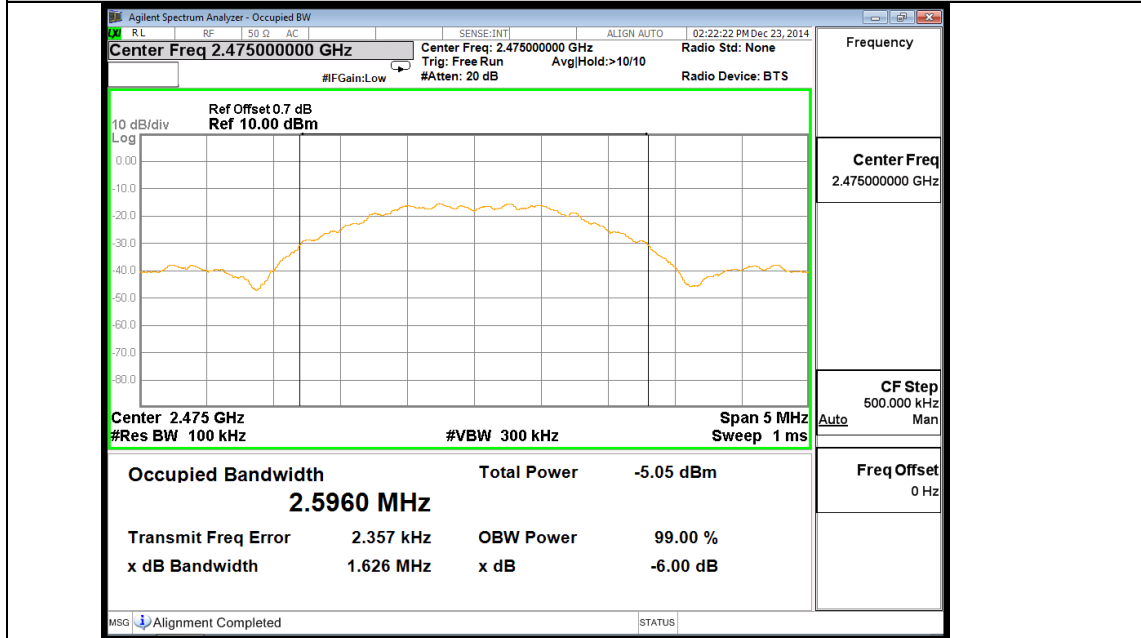



## 7. Maximum Peak Output Power

### 7.1 Test Limit

The maximum peak power shall be less 1Watt (30dBm).

The conducted output power limits specified in §15.247(b) are based on the use of transmit antennae with directional gains that do not exceed 6 dBi. If transmit antennae with an effective directional gain greater than 6 dBi are used, then the conducted output power from the EUT shall be reduced as specified in §15.247(b) and (c).

### 7.2 Test Procedure

The transmitter output was connected to a calibrated attenuator, the other end of which was connected to a spectrum analyzer.

“9.1.2 integrated band power method” of KDB558074 was used to test the power.

Select the “channel power” selection in “measurement” on spectrum analyzer,

The test procedure and setup as following:

Set the RBW = 1 MHz.

Set the VBW = 3 MHz.

Set the span 50MHz for 802.11b/g/n(20) and 90MHz for n(40)

Set the integ BW 25MHz for 802.11b/g/n(20) and 45MHz for n(40)

Detector = peak.

Sweep time = auto couple.

Trace mode = max hold.

Allow trace to fully stabilize.

Record the power value in dBm.

The power output at the transmitter antenna port was determined by adding the value of the attenuator to the spectrum analyzer reading.

### 7.3 Test Setup Layout

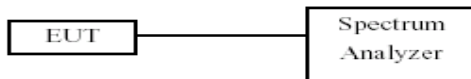

### 7.4 Measurement Equipment

Instrument/Ancillary	Model No.	Manufacturer	Serial No.	Calibration Date	Valid Date
Spectrum Analyzer	Agilent	N9010A	MY53400169	2014.09.28	2015.09.27
Temperature/ Humidity Meter	Zhicheng	ZC1-11	CEP-TH-002	2014.09.25	2015.09.25



### 7.5 Test Result and Data

Test Item	Maximum Peak Output Power
Test Mode	Transmit by DSSS(O-QPSK)
Test Date	2014-12-23

Channel No.	Frequency (MHz)	Measurement (dBm) Peak	Required Limit (dBm)	Result
15	2425	-2.06	30	Pass
20	2450	-1.95	30	Pass
25	2475	-1.65	30	Pass



## 8. Band Edges Measurement

### 8.1 Test Limit

Below -20dB of the highest emission level of operating band (In 100 kHz Resolution Bandwidth)

### 8.2 Test Procedure

- a. The transmitter output was connected to the spectrum analyzer via a low lose cable.
- b. Set RBW of spectrum analyzer to 100 KHz and VBW of spectrum analyzer to 300 KHz with convenient frequency span including 100 KHz bandwidth from band edge.
- c. The band edges was measured and recorded.

### 8.3 Test Setup Layout

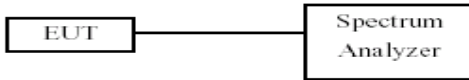

### 8.4 Measurement Equipment

Instrument/Ancillary	Model No.	Manufacturer	Serial No.	Calibration Date	Valid Date
Spectrum Analyzer	Agilent	N9010A	MY53400169	2014.09.28	2015.09.27



### 8.5 Test Result and Data

Channel No.	Frequency (MHz)	Maximum Value in frequency (MHz)	Maximum Value (dBm)
15	2425	2400	-66.395
25	2475	2483.5	-64.126

Channel 15 2425MHz

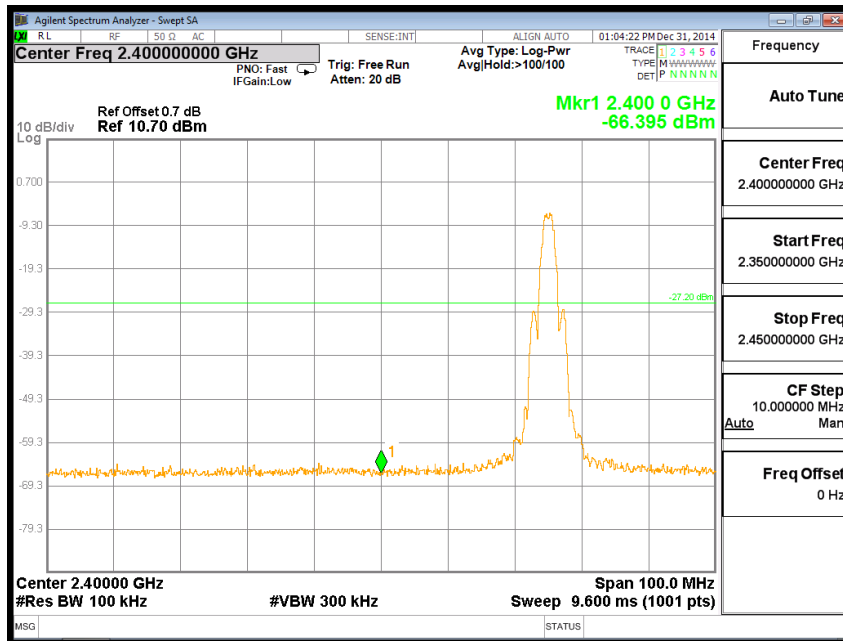

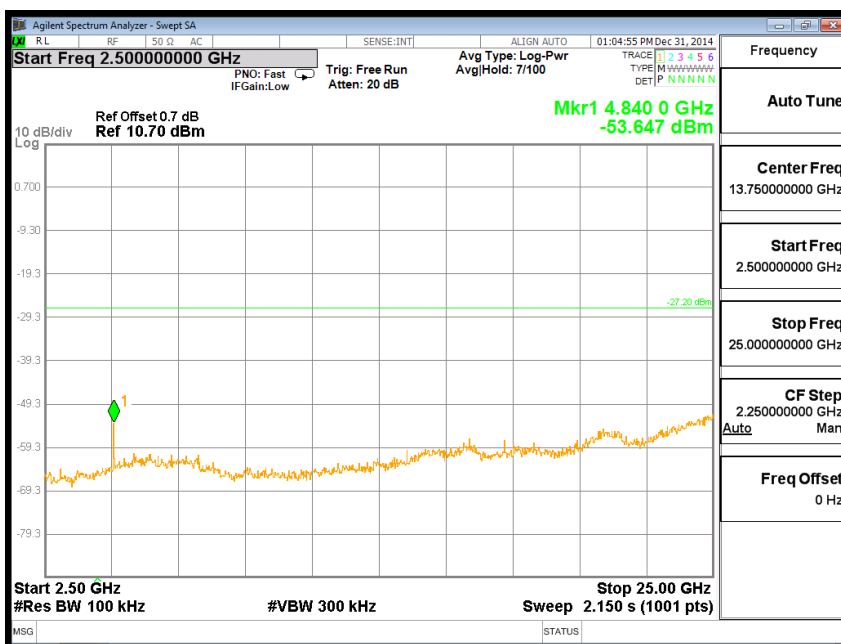

Channel 25 2475MHz

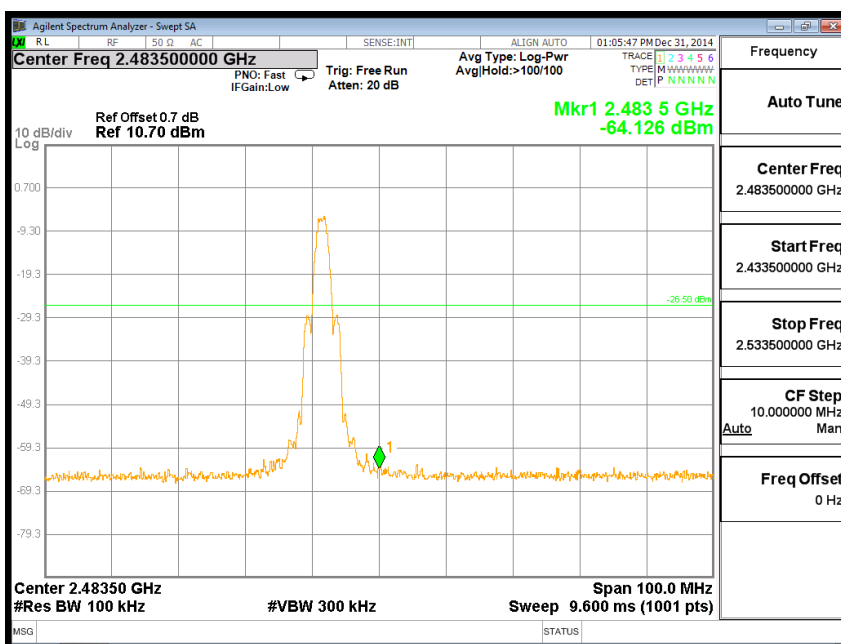

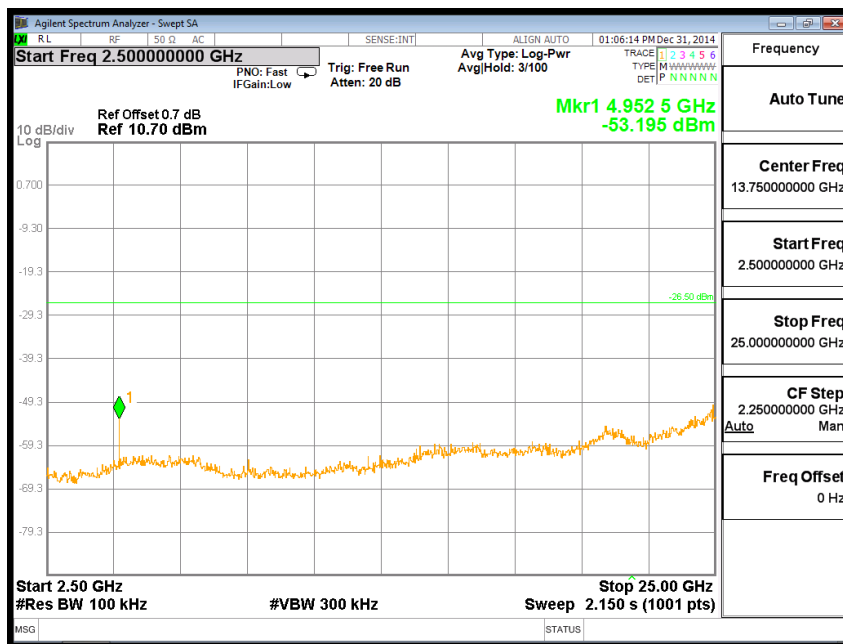



**Restrict Band Emission Measurement Data**

Channel 15						Fundamental Frequency: 2425 MHz				
Frequency (MHz)	Ant-Pol H/V	Meter Reading	Corrected Factor	Result (dBuV/m)	Remark	Limit@3m (dBuV/m)		Margin (dB)	Table (Deg.)	Ant High (cm)
						Peak	Ave.			
2390	H	41.48	10.6	52.08	Peak	74	54	-21.92	348	200
2390	H	32.52	10.6	43.12	Ave	74	54	-10.88	348	200
2390	V	51.95	10.98	62.93	Peak	74	54	-11.07	360	100
2390	V	37.58	10.98	48.56	Ave	74	54	-5.44	360	100
Channel 25						Fundamental Frequency: 2475 MHz				
Frequency (MHz)	Ant-Pol H/V	Meter Reading	Corrected Factor	Result (dBuV/m)	Remark	Limit@3m (dBuV/m)		Margin (dB)	Table (Deg.)	Ant High (cm)
						Peak	Ave.			
2483.5	H	43.14	10.78	53.92	Peak	74	54	-20.08	0	200
2483.5	H	31.62	10.78	42.4	Ave	74	54	-11.6	249	200
2483.5	V	48.49	11.02	59.51	Peak	74	54	-14.49	251	100
2483.5	V	36.28	11.02	47.3	Ave	74	54	-6.7	251	100



## 9. Power Spectral Density

### 9.1 Test Limit

The Maximum of Power Spectral Density Measurement is 8dBm.

### 9.2 Test Procedure

- a. The transmitter output was connected to spectrum analyzer.
- b. The spectrum analyzer's resolution bandwidth were set at 3KHz RBW and 10KHz VBW as that of the fundamental frequency. Set the sweep time=auto couple.
- c. The power spectral density was measured and recorded.

### 9.3 Test Setup Layout

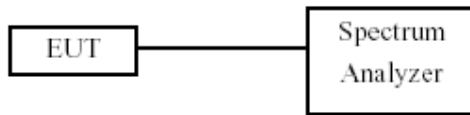

### 9.4 Measurement Equipment

Instrument/Ancillary	Model No.	Manufacturer	Serial No.	Calibration Date	Valid Date
Spectrum Analyzer	Agilent	N9010A	MY53400169	2014.09.28	2015.09.27



### 9.5 Test Result and Data

Test Item	Power Spectral Density
Test Date	2014-12-23

Channel	Frequency (MHz)	Power Spectral Density (dBm/3kHz)	Limit (dBm/3kHz)	Result
15	2425	-18.980	8	Pass
20	2450	-19.113	8	Pass
25	2475	-18.064	8	Pass

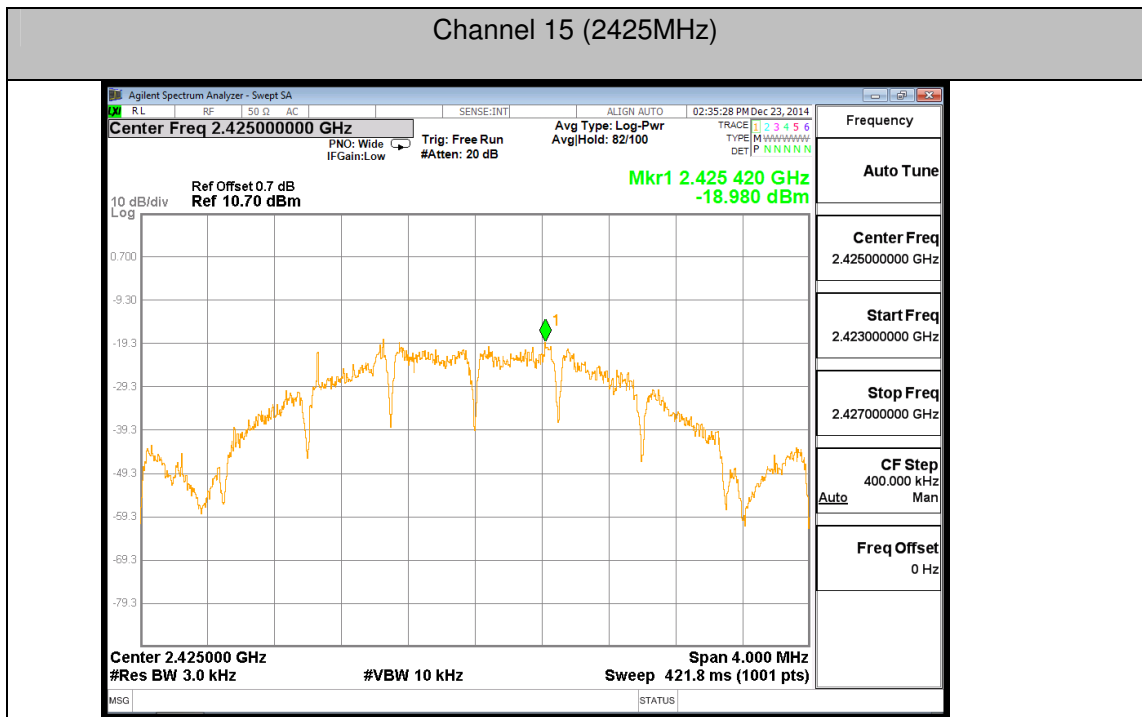



### Channel 20 (2450MHz)

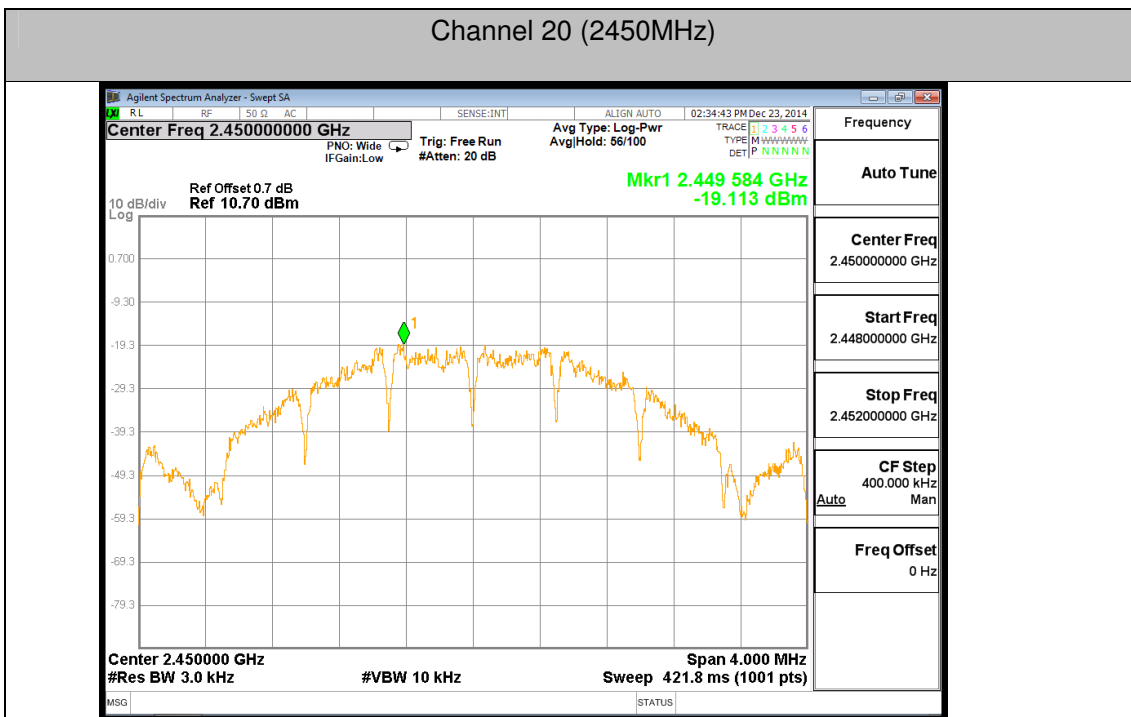

### Channel 25 (2475MHz)

