



International Certification Corp.

No. 3-1, Lane 6, Wen San 3rd St., Kwei Shan Hsiang, Tao Yuan Hsien 333, Taiwan, R.O.C.

Tel: 886-3-271-8666

Fax: 886-3-318-0155

FCC Test Report

FCC ID : VQK-F01F
Equipment : Mobile Phone
Model No. : F-01F
Brand Name : FUJITSU
Applicant : FUJITSU LIMITED
Address : 1-1, Kamikodanaka 4-chome, Nakahara-ku,
Kawasaki 211-8588, Japan
Standard : 47 CFR FCC Part 22 Subpart H
Received Date : Jul. 01, 2013
Tested Date : Aug. 12 ~ Aug. 15, 2013

We, International Certification Corp., would like to declare that the tested sample has been evaluated and in compliance with the requirement of the above standards. The test results contained in this report refer exclusively to the product. It may be duplicated completely for legal use with the approval of the applicant. It shall not be reproduced except in full without the written approval of our laboratory.

Approved & Reviewed by:



Gary Chang / Manager





Table of Contents

1	GENERAL DESCRIPTION	5
1.1	Information.....	5
1.2	Local Support Equipment List	6
1.3	Test Setup Chart	6
1.4	The Equipment List	7
1.5	Test Standards	8
1.6	Measurement Uncertainty	9
2	TEST CONFIGURATION	10
2.1	Testing Condition and Location Information.....	10
2.2	The Worst Test Modes and Channel Details	10
3	TEST RESULTS.....	11
3.1	Effective Radiated Power	11
3.2	Radiated Emissions.....	15
3.3	Conducted Emissions.....	20
3.4	Band Edge.....	23
3.5	Occupied Bandwidth	25
3.6	Peak to Average Ratio	28
3.7	Frequency Stability.....	30



Release Record

Report No.	Version	Description	Issued Date
FG370110-1	Rev. 01	Initial issue	Sep. 03, 2013



Summary of Test Results

FCC Rules	Test Items	Measured	Result
2.1046 / 22.913(a)(2)	Effective Radiated Power	Power[dBm]: GSM: 27.98 WCDMA: 20.02	Pass
2.1053 / 22.917(a)	Radiated Emissions	Meet the requirement of limit	Pass
2.1051 / 22.917(a)	Conducted Emissions	Meet the requirement of limit	Pass
2.1051 / 22.917(a)	Band Edge	Meet the requirement of limit	Pass
2.1049 / 22.917(a)	Occupied Bandwidth	Meet the requirement of limit	Pass
-	Peak to average ratio	Meet the requirement of limit	Pass
2.1055 / 22.355	Frequency Stability	Meet the requirement of limit	Pass



1 General Description

1.1 Information

1.1.1 Specification of the Equipment under Test (EUT)

Operating band(MHz)	GSM: 824.2-848.8 WCDMA: 826.4-846.6
Modulation	GSM / GPRS: GMSK WCDMA / HSDPA / HSUPA: QPSK
Multislot class	33
3GPP release version	6
IMEI Code	357611050019762 & 357611050019747
H/W Version	V2.1.0
S/W Version	R19.8e

1.1.2 Maximum ERP, Frequency Tolerance and Emission Designator

System	Modulation	Maximum ERP(W)	Frequency Tolerance (ppm)	Emission Designator
GSM 850	GMSK	0.628	0.022	246KGXW
WCDMA850	QPSK	0.100	0.029	4M15F9W

1.1.3 Antenna Details

Ant. No.	Type	Gain (dBi)	Connector	Remark
1	$\lambda/4$ Monopole	-2.5	---	---

1.1.4 EUT Operational Condition

Supply Voltage	<input checked="" type="checkbox"/> AC mains	<input checked="" type="checkbox"/> DC	
Type of DC Source	<input type="checkbox"/> Internal DC supply	<input checked="" type="checkbox"/> External DC adapter	<input checked="" type="checkbox"/> Battery

1.1.5 Accessories

Accessories		
No.	Equipment	Description
1	Battery	Brand Name: Fujitsu limited Model Name: CA54310-0052 Power Rating: O/P: 3.75Vdc, 3200mA, 12Wh



1.1.6 Operating Channel List

GSM & GPRS		
	Channel	Frequency (MHz)
Low	128	824.2
Middle	190	836.6
High	251	848.8

WCDMA		
	Channel	Frequency (MHz)
Low	4132	826.4
Middle	4182	836.4
High	4233	846.6

1.2 Local Support Equipment List

Support Equipment List						
No.	Equipment	Brand	Model	S/N	FCC ID	Signal cable / Length (m)
1	Adapter	NTT docomo	AC Adaptor 04	---	---	1m non-shielded with 2 cores
2	Earphone	APPLE	MD827FE/A	---	---	1.2m non-shielded w/o core

Note: Item 1 was provided by client.

1.3 Test Setup Chart

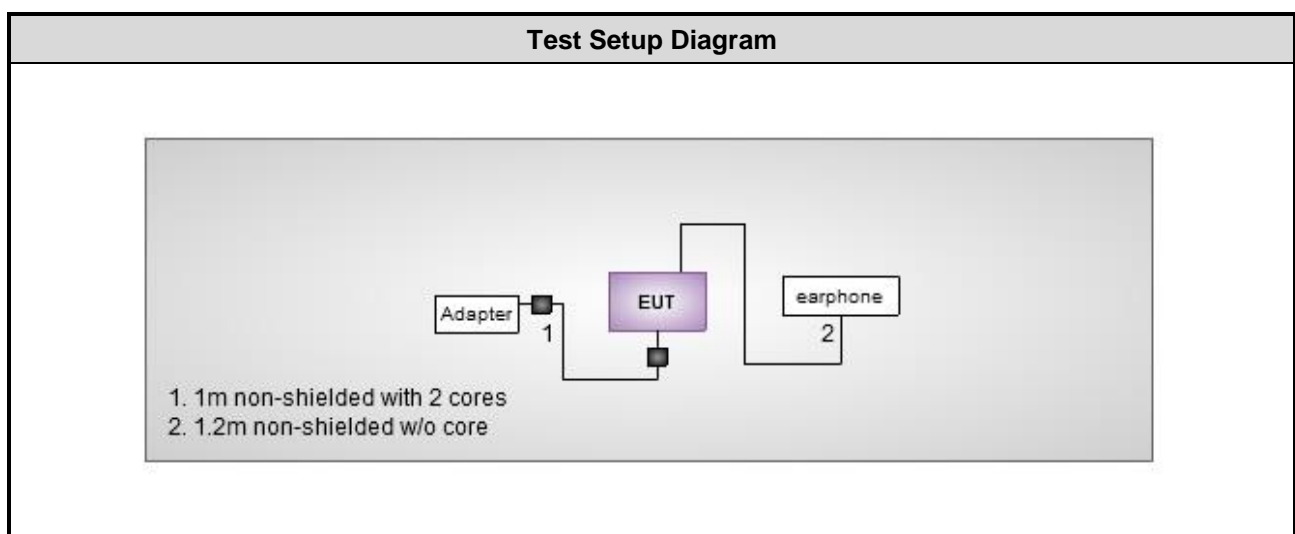



1.4 The Equipment List

Test Item	Radiated Emission above 1GHz				
Test Site	966 chamber1 / (03CH01-WS)				
Instrument	Manufacturer	Model No.	Serial No.	Calibration Date	Calibration Until
3m semi-anechoic chamber	CHAMPRO	SAC-03	03CH01-WS	Jan. 04, 2013	Jan. 03, 2014
Spectrum Analyzer	R&S	FSV40	101498	Jan. 24, 2013	Jan. 23, 2014
Receiver	R&S	ESR3	101658	Jan. 28, 2013	Jan. 27, 2014
Bilog Antenna	SCHWARZBECK	VULB9168	VULB9168-522	Jan. 11, 2013	Jan. 10, 2014
Horn Antenna 1G-18G	SCHWARZBECK	BBHA 9120 D	BBHA 9120 D 1096	Feb. 18, 2013	Feb. 17, 2014
Horn Antenna 18G-40G	SCHWARZBECK	BBHA 9170	BBHA 9170517	Jan. 14, 2013	Jan. 13, 2014
Amplifier	Burgeon	BPA-530	100219	Nov. 28, 2012	Nov. 27, 2013
Amplifier	Agilent	83017A	MY39501308	Dec. 18, 2012	Dec. 17, 2013
RF Cable	HUBER+SUHNER	SUCOFLEX104	MY16014/4	Dec. 25, 2012	Dec. 24, 2013
RF Cable	HUBER+SUHNER	SUCOFLEX104	MY16019/4	Dec. 25, 2012	Dec. 24, 2013
RF Cable	HUBER+SUHNER	SUCOFLEX104	MY16139/4	Dec. 25, 2012	Dec. 24, 2013
RF Cable-R03m	Woken	CFD400NL-LW	CFD400NL-001	Dec. 25, 2012	Dec. 24, 2013
RF Cable-R10m	Woken	CFD400NL-LW	CFD400NL-002	Dec. 25, 2012	Dec. 24, 2013
control	EM Electronics	EM1000	60612	N/A	N/A
Note: Calibration Interval of instruments listed above is one year.					

Loop Antenna	R&S	HFH2-Z2	100330	Nov. 15, 2012	Nov. 14, 2014
Amplifier	MITEQ	AMF-6F-260400	9121372	Apr. 19, 2013	Apr. 18, 2015
Note: Calibration Interval of instruments listed above is two year.					



Test Item	RF Conducted				
Test Site	(TH01-WS)				
Instrument	Manufacturer	Model No.	Serial No.	Calibration Date	Calibration Until
Spectrum Analyzer	R&S	FSV 40	101063	Feb. 18, 2013	Feb. 17, 2014
TEMP&HUMIDITY CHAMBER	GIANT FORCE	GCT-225-40-SP-SD	MAF1212-002	Nov. 29, 2012	Nov. 28, 2013
Power Meter	Anritsu	ML2495A	1241002	Oct. 15, 2012	Oct. 14, 2013
Power Sensor	Anritsu	MA2411B	1027366	Oct. 24, 2012	Oct. 23, 2013
Signal Generator	R&S	SMB100A	175727	Jan. 14, 2013	Jan. 13, 2014
Radio Communication Analyzer	Anritsu	MT8820C	6201240341	Mar. 13, 2013	Mar. 12, 2014
Wideband Radio Communication Tester	R&S	CMW500	106070	Jan. 29, 2013	Jan. 28, 2014
Note: Calibration Interval of instruments listed above is one year.					

1.5 Test Standards

According to the specification of EUT, the EUT must comply with following standards.

47 CFR FCC Part 22 Subpart H

ANSI C63.43-2003

ANSI / TIA / EIA-603-C -2004

Note: The EUT has been tested and complied with FCC part 15B requirement. FCC Part 15B test results are issued to another report.



1.6 Measurement Uncertainty

ISO/IEC 17025 requires that an estimate of the measurement uncertainties associated with the emissions test results be included in the report. The measurement uncertainties given below are based on a 95% confidence level (based on a coverage factor (k=2)).

Measurement Uncertainty	
Parameters	Uncertainty
Bandwidth	±35.286 Hz
Conducted power	±0.536 dB
Frequency error	±35.286 Hz
Temperature	±0.3 °C
Conducted emission	±2.946 dB
AC conducted emission	±2.43 dB
Radiated emission	±2.49 dB



2 Test Configuration

2.1 Testing Condition and Location Information

Test Item	Test Site	Ambient Condition	Tested By
RF conducted	TH01-WS	22°C / 63%	Felix Sung
Radiated Emissions	03CH01-WS	24°C / 63%	Aska Huang

➤ FCC site registration No.: 657002

➤ IC site registration No.: 10807A-1

2.2 The Worst Test Modes and Channel Details

Test item	Mode	Test channel
Effective Radiated Power	GSM WCDMA	128, 190, 251 4132, 4182, 4233
Radiated Emissions	GSM WCDMA	128, 190, 251 4132, 4182, 4233
Conducted Emissions	GSM WCDMA	128, 190, 251 4132, 4182, 4233
Band Edge	GSM WCDMA	128, 251 4132, 4233
Occupied Bandwidth	GSM WCDMA	128, 190, 251 4132, 4182, 4233
Peak to average ratio	GSM WCDMA	128, 190, 251 4132, 4182, 4233
Frequency Stability	GSM WCDMA	190 4182

NOTE:

1. The EUT was pretested with 3 orientations placed on the table for the radiated emission measurement – X, Y, and Z-plane. The **Z-plane** results were found as the worst case and were shown in this report.



3 Test Results

3.1 Effective Radiated Power

3.1.1 Limit of Effective Radiated Power

The ERP of mobile transmitters and auxiliary test transmitters must not exceed 7 Watts.

3.1.2 Test Procedures

For E.R.P measurement

1. The EUT links up with simulator and is set to maximum output power level at low / middle / high channel. Measurement is made at a semi-anechoic chamber that incorporates a turntable allowing a EUT rotation of 360°. A continuously-rotating, remotely-controlled turntable is installed at the test site to support the EUT and facilitate determination of the direction of maximum radiation for each EUT emission frequency. The EUT is placed at a height of 0.8 m test table above the ground plane.
2. Measurement is made with the antenna positioned in both the horizontal and vertical planes of polarization. The measurement antenna is varied in height (1m ~ 4m) above the reference ground plane to obtain the maximum signal strength. Distance between EUT and antenna is 3 m.
3. This investigation is performed with the EUT rotated 360°, the antenna height scanned between 1 m and 4 m, and the antenna rotated to repeat the measurements for both the horizontal and vertical antenna polarizations.
4. After finding the max radiated emission, substitution method will be used for getting effective radiated power. EUT will be removed and substitution antenna will be placed at same position. Signal generator will output CW signal to substitution antenna through a RF cable. Rotate turntable and move antenna to find maximum radiated emission. Adjust output power of signal generator to let the maximum radiated emission is same as step 3. Record the output power level.
5. E.I.R.P = output power of step 4 + gain of substitution antenna – cable loss of RF cable. ERP can be calculated by below formula:
$$E.R.P = E.I.R.P - 2.15dB$$

For Conducted power measurement

1. The EUT links up with simulator and is set to maximum output power level at low / middle / high channel.
2. Measure the output power of low / middle / high channel of the EUT



3.1.3 Test Setup

Effective Radiated Power Measurement

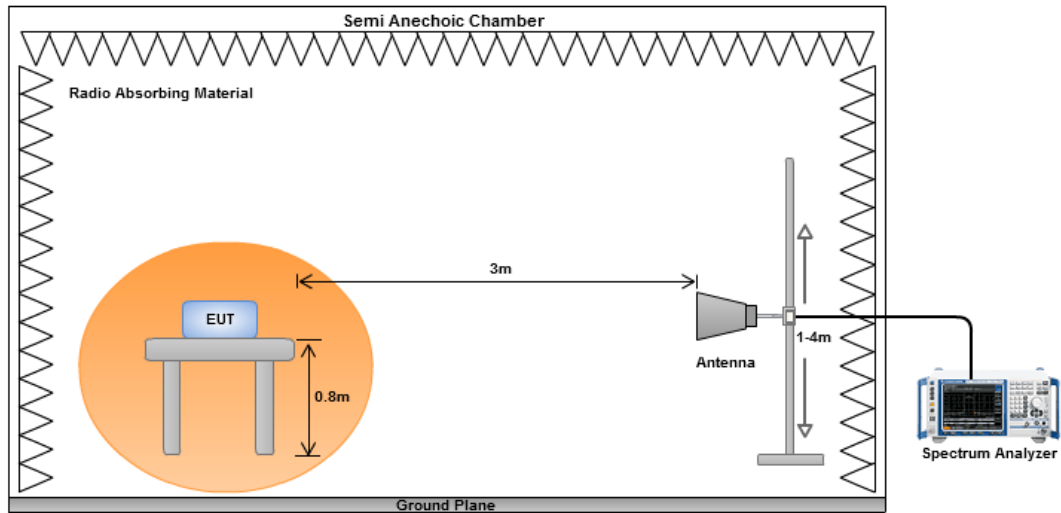

Conducted Power Measurement

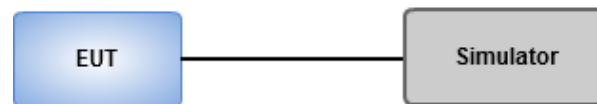



3.1.4 Test Result of Conducted Output Power (dBm)

Mode	GSM					
Channel	Frequency (MHz)	GSM	GPRS 1 Slot	GPRS 2 Slots	GPRS 3 Slots	GPRS 4 Slots
128	824.2	32.47	32.46	30.57	29.34	26.81
190	836.6	32.64	32.63	30.71	29.45	26.86
251	848.8	32.52	32.51	30.69	29.36	26.83

Mode	WCDMA / HSDPA						
Channel	Frequency (MHz)	WCDMA		HSDPA			
		AMR 12.2Kbps	RMC 12.2kbps	Subtest-1	Subtest-2	Subtest-3	Subtest-4
4132	826.4	24.46	24.49	23.51	23.50	22.79	22.75
4182	836.4	24.30	24.32	23.34	23.32	22.66	22.61
4233	846.6	24.74	24.76	23.75	23.68	23.05	23.03

Mode	HSUPA					
Channel	Frequency (MHz)	HSDPA				
		Subtest-1	Subtest-2	Subtest-3	Subtest-4	Subtest-5
4132	826.4	23.49	22.52	22.33	22.83	23.61
4182	836.4	23.34	22.24	22.12	22.59	23.50
4233	846.6	23.66	22.71	22.60	22.95	23.68



3.1.5 Test Result of Effective Radiated Power (dBm)

Mode	GSM						
Channel	Frequency (MHz)	S.A Reading (dBm)	S.G Power Vaule (dBm)	Correction Factor (dB)	ERP (dBm)	Limit (dBm)	Margin (dB)
128	824.2	-2.56	26.25	3.88	27.98	38.45	-10.47
190	836.6	-3.28	25.68	3.9	27.43	39.45	-12.02
251	848.8	-4.49	24.61	3.92	26.38	40.45	-14.07

Mode	WCDMA, AMR 12.2Kbps						
Channel	Frequency (MHz)	S.A Reading (dBm)	S.G Power Vaule (dBm)	Correction Factor (dB)	ERP (dBm)	Limit (dBm)	Margin (dB)
4132	826.4	-10.55	18.29	3.88	20.02	38.45	-18.43
4182	836.4	-11.95	17.01	3.90	18.76	39.45	-20.69
4233	846.6	-12.89	16.19	3.91	17.95	40.45	-22.5

NOTE: ERP = S.G power value + correction factor - 2.15



3.2 Radiated Emissions

3.2.1 Limit of Radiated Emissions

The power of any emission outside of the authorized operating frequency ranges must be attenuated below the transmitting power (P) by a factor of at least $43 + 10 \log(P)$ dB equal to -13dBm.

3.2.2 Test Procedures

1. Measurement is made at a semi-anechoic chamber that incorporates a turntable allowing a EUT rotation of 360°. A continuously-rotating, remotely-controlled turntable is installed at the test site to support the EUT and facilitate determination of the direction of maximum radiation for each EUT emission frequency. The EUT is placed at a height of 0.8 m test table above the ground plane.
2. Measurement is made with the antenna positioned in both the horizontal and vertical planes of polarization. The measurement antenna is varied in height (1m ~ 4m) above the reference ground plane to obtain the maximum signal strength. Distance between EUT and antenna is 3 m.
3. This investigation is performed with the EUT rotated 360°, the antenna height scanned between 1 m and 4 m, and the antenna rotated to repeat the measurements for both the horizontal and vertical antenna polarizations.
4. After finding the max radiated emission, substitution method will be used for getting effective radiated power. EUT will be removed and substitution antenna will be placed at same position. Signal generator will output CW signal to substitution antenna through a RF cable. Rotate turntable and move antenna to find maximum radiated emission. Adjust output power of signal generator to let the maximum radiated emission is same as step 3. Record the output power level.
5. $E.I.R.P = \text{output power of step 4} + \text{gain of substitution antenna} - \text{cable loss of RF cable}$. ERP can be calculated by below formula:
 $E.R.P = E.I.R.P - 2.15\text{dB}$

3.2.3 Test Setup

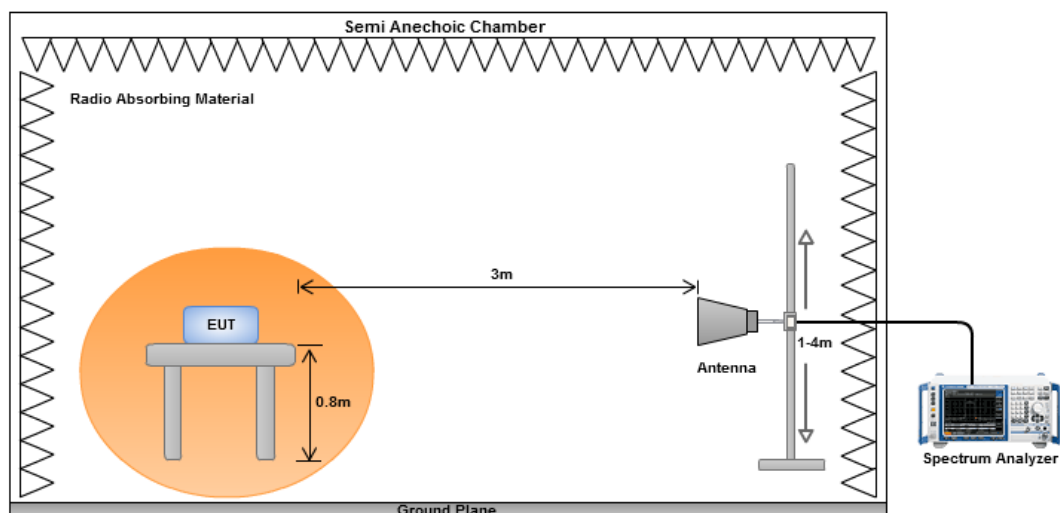



3.2.4 Test Result of Radiated Emissions below 1GHz

Mode	GSM, Channel : 251						
Frequency (MHz)	Antenna Polarity	E.R.P (dBm)	Limit (dBm)	Margin (dB)	S.A Reading (dBm)	S.G Power Vaule (dBm)	Correction Factor (dB)
30	H	-63.26	-13	-50.26	-58.97	-48.76	-12.35
132.82	H	-59.21	-13	-46.21	-47.73	-57.11	0.05
152.22	H	-59.54	-13	-46.54	-49.33	-57.85	0.46
168.71	H	-54.58	-13	-41.58	-43.93	-54.45	2.02
281.23	H	-63.2	-13	-50.2	-52.96	-66.63	5.58
311.3	H	-60.38	-13	-47.38	-50.88	-63.80	5.57
41.64	V	-54.82	-13	-41.82	-44.78	-41.42	-11.25
94.99	V	-56.1	-13	-43.1	-44.47	-54.41	0.46
155.13	V	-58	-13	-45	-53.44	-56.41	0.56
196.84	V	-57.07	-13	-44.07	-48.72	-60.50	5.58
358.83	V	-57.98	-13	-44.98	-50.73	-61.38	5.55
396.66	V	-56.97	-13	-43.97	-50.85	-60.30	5.48

NOTE: ERP = S.G power value + correction factor - 2.15



Mode	WCDMA, Channel : 4182						
Frequency (MHz)	Antenna Polarity	E.R.P (dBm)	Limit (dBm)	Margin (dB)	S.A Reading (dBm)	S.G Power Vaule (dBm)	Correction Factor (dB)
30	H	-67.99	-13	-54.99	-52.18	-53.49	-12.35
136.7	H	-67.93	-13	-54.93	-45.2	-65.82	0.04
167.74	H	-63.92	-13	-50.92	-47.05	-63.65	1.88
267.65	H	-57.59	-13	-44.59	-48.06	-61.03	5.59
305.48	H	-66.02	-13	-53.02	-47.81	-69.44	5.57
392.78	H	-68.33	-13	-55.33	-58.25	-71.66	5.48
41.64	V	-62.22	-13	-49.22	-63.7	-48.82	-11.25
94.99	V	-56.83	-13	-43.83	-57.11	-55.14	0.46
107.6	V	-57.19	-13	-44.19	-53.33	-55.39	0.35
166.77	V	-53.02	-13	-40.02	-46.88	-52.6	1.73
274.44	V	-56.98	-13	-43.98	-56.48	-60.42	5.59
365.62	V	-65.3	-13	-52.3	-59.82	-68.69	5.54

NOTE: ERP = S.G power value + correction factor - 2.15



3.2.5 Test Result of Radiated Emissions above 1GHz

Mode		GSM , Channel : 128					
Frequency (MHz)	Antenna Polarity	E.R.P (dBm)	Limit (dBm)	Margin (dB)	S.A Reading (dBm)	S.G Power Vaule (dBm)	Correction Factor (dB)
1648.4	H	-52.66	-13	-39.66	-53.21	-55.62	5.11
2472.6	H	-38.59	-13	-25.59	-43.52	-42.57	6.13
3296.8	H	-53.87	-13	-40.87	-62.57	-57.45	5.73
1648.4	V	-51.56	-13	-38.56	-51.39	-54.52	5.11
2472.6	V	-34.25	-13	-21.25	-40.68	-38.23	6.13
3296.8	V	-50.17	-13	-37.17	-59.59	-53.75	5.73

Mode		GSM , Channel : 190					
Frequency (MHz)	Antenna Polarity	E.R.P (dBm)	Limit (dBm)	Margin (dB)	S.A Reading (dBm)	S.G Power Vaule (dBm)	Correction Factor (dB)
1673.2	H	-51.6	-13	-38.6	-50.42	-54.49	5.04
2509.8	H	-37.03	-13	-24.03	-42.35	-41.07	6.19
3346.4	H	-54.99	-13	-41.99	-63.69	-58.53	5.69
1673.2	V	-55.23	-13	-42.23	-55.40	-58.12	5.04
2509.8	V	-35.17	-13	-22.17	-41.90	-39.21	6.19
3346.4	V	-51.07	-13	-38.07	-60.72	-54.61	5.69

Mode		GSM , Channel : 251					
Frequency (MHz)	Antenna Polarity.	E.R.P (dBm)	Limit (dBm)	Margin (dB)	S.A Reading (dBm)	S.G Power Vaule (dBm)	Correction Factor (dB)
1697.6	H	-54.42	-13	-41.42	-55.50	-57.25	4.98
2546.4	H	-36.95	-13	-23.95	-42.64	-41.06	6.26
3395.2	H	-54.81	-13	-41.81	-63.51	-58.30	5.64
1697.6	V	-50.55	-13	-37.55	-51.05	-53.38	4.98
2546.4	V	-33.36	-13	-20.36	-40.38	-37.47	6.26
3395.2	V	-50.32	-13	-37.32	-60.21	-53.81	5.64

NOTE: ERP = S.G power value + correction factor - 2.15



Mode		WCDMA , Channel : 4132					
Frequency (MHz)	Antenna Polarity	E.R.P (dBm)	Limit (dBm)	Margin (dB)	S.A Reading (dBm)	S.G Power Vaule (dBm)	Correction Factor (dB)
1652.8	H	-50.19	-13	-37.19	-50.79	-53.14	5.10
2479.2	H	-45.37	-13	-32.37	-50.38	-49.36	6.14
3305.6	H	-46.62	-13	-33.62	-55.32	-50.19	5.72
1652.8	V	-50.39	-13	-37.39	-50.28	-53.34	5.10
2479.2	V	-43.09	-13	-30.09	-49.58	-47.08	6.14
3305.6	V	-33.26	-13	-20.26	-55.71	-36.83	5.72

Mode		WCDMA , Channel : 4182					
Frequency (MHz)	Antenna Polarity	E.R.P (dBm)	Limit (dBm)	Margin (dB)	S.A Reading (dBm)	S.G Power Vaule (dBm)	Correction Factor (dB)
1672.8	H	-49.33	-13	-36.33	-50.15	-52.22	5.04
2509.2	H	-44.61	-13	-31.61	-49.92	-48.65	6.19
3345.6	H	-47.11	-13	-34.11	-55.81	-50.65	5.69
1672.8	V	-50.91	-13	-37.91	-51.08	-53.80	5.04
2509.2	V	-47.72	-13	-34.72	-54.44	-51.76	6.19
3345.6	V	-46.56	-13	-33.56	-56.21	-50.10	5.69

Mode		WCDMA , Channel : 4233					
Frequency (MHz)	Antenna Polarity.	E.R.P (dBm)	Limit (dBm)	Margin (dB)	S.A Reading (dBm)	S.G Power Vaule (dBm)	Correction Factor (dB)
1693.2	H	-48.27	-13	-35.27	-49.31	-51.11	4.99
2539.8	H	-43.75	-13	-30.75	-49.38	-47.84	6.24
3386.4	H	-46.49	-13	-33.49	-55.19	-49.99	5.65
1693.2	V	-50.45	-13	-37.45	-50.9	-53.29	4.99
2539.8	V	-45.99	-13	-32.99	-52.96	-50.08	6.24
3386.4	V	-45.98	-13	-32.98	-55.82	-49.48	5.65

NOTE: ERP = S.G power value + correction factor - 2.15



3.3 Conducted Emissions

3.3.1 Limit of Conducted Emissions

The power of any emission outside of the authorized operating frequency ranges must be attenuated below the transmitting power (P) by a factor of at least $43 + 10 \log(P)$ dB equal to -13dBm.

3.3.2 Test Procedures

1. Lowest, middle and highest operating channels are tested for this item.
2. Scan frequency range is from 30MHz~9GHz.
3. Set RBW = 1MHz, VBW = 3MHz, detector = RMS, sweep time = auto.
4. Record the max trace value and capture the test plot of each sub frequency band.

3.3.3 Test Setup

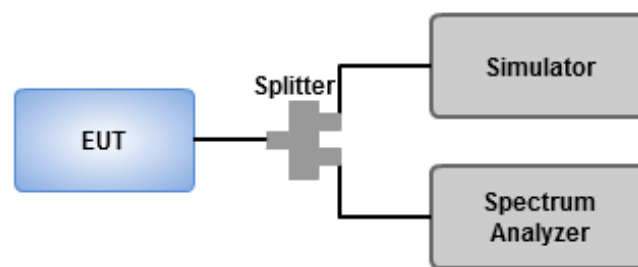



3.3.4 Test Result of Conducted Emissions

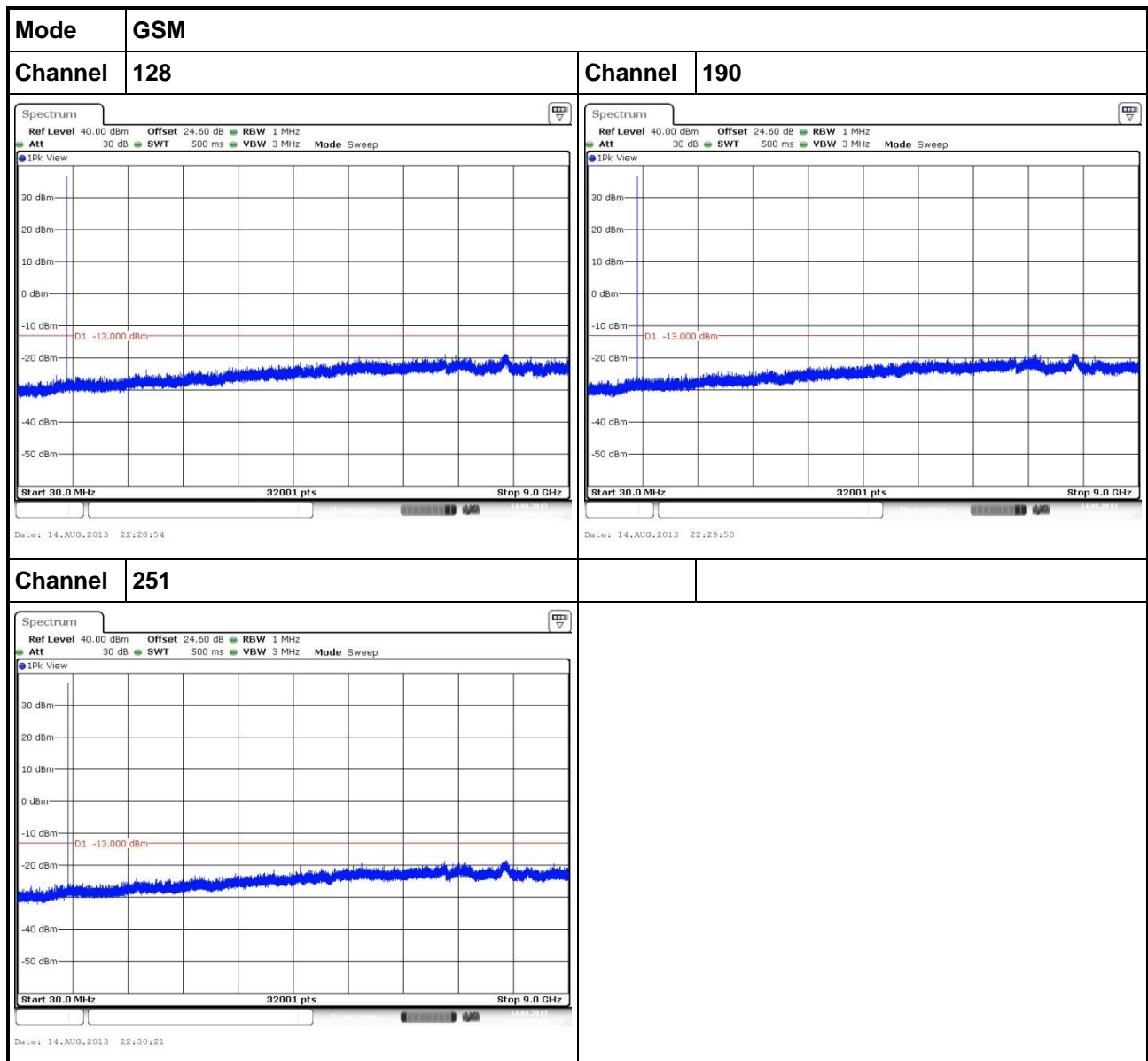

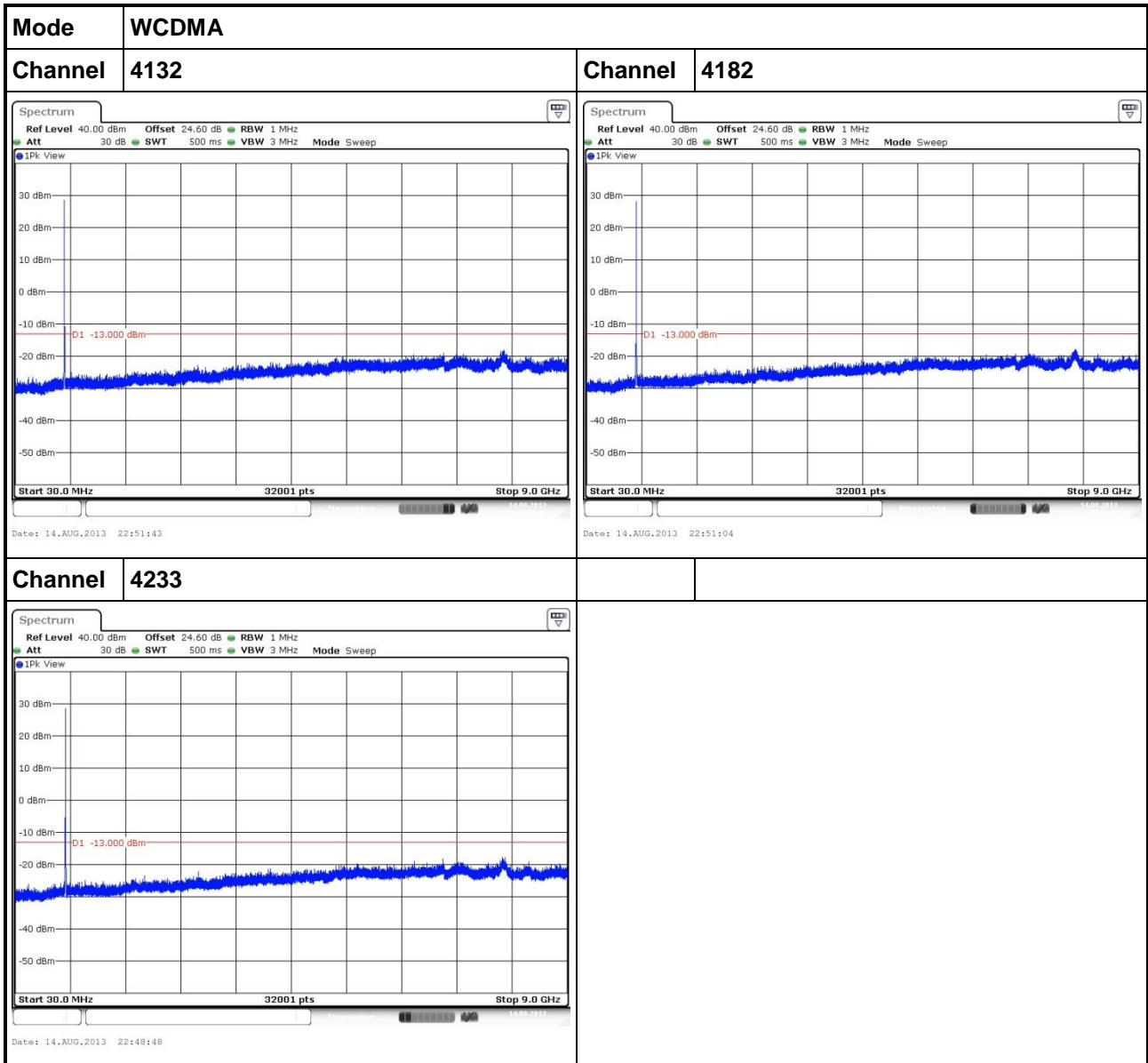



3.4 Band Edge

3.4.1 Limit of Band Edge

The power of any emission outside of the authorized operating frequency ranges must be attenuated below the transmitting power (P) by a factor of at least $43 + 10 \log(P)$ dB equal to -13dBm.

3.4.2 Test Procedures

1. Lowest and highest operating channels are tested for this item.
2. The center frequency of spectrum analyzer will be set to 824 and 849 MHz.
3. Set RBW = VBW=3kHz, span = 1 MHz, detector = RMS, sweep time = auto for GSM
Set RBW = VBW = 100kHz, span = 5 MHz, detector = RMS, sweep time = auto for WCDMA
4. Record the max trace value and capture the test plot.

3.4.3 Test Setup

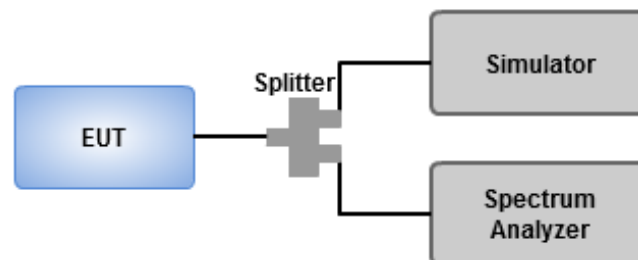



3.4.4 Test Result of Band Edge

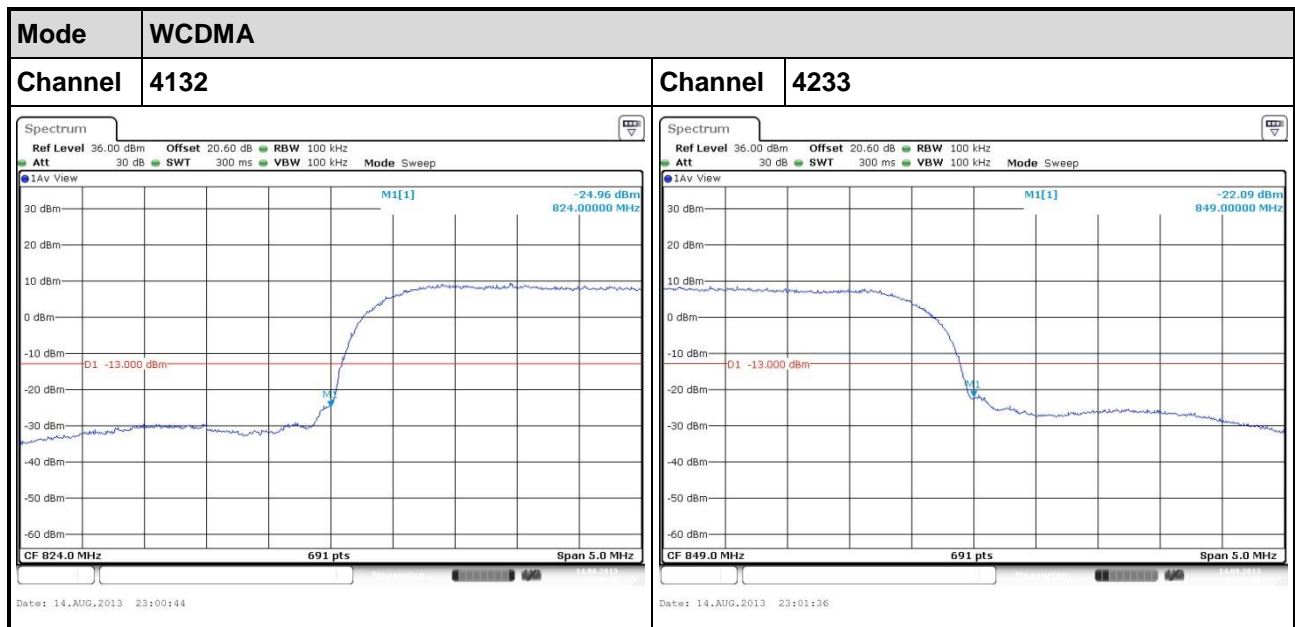
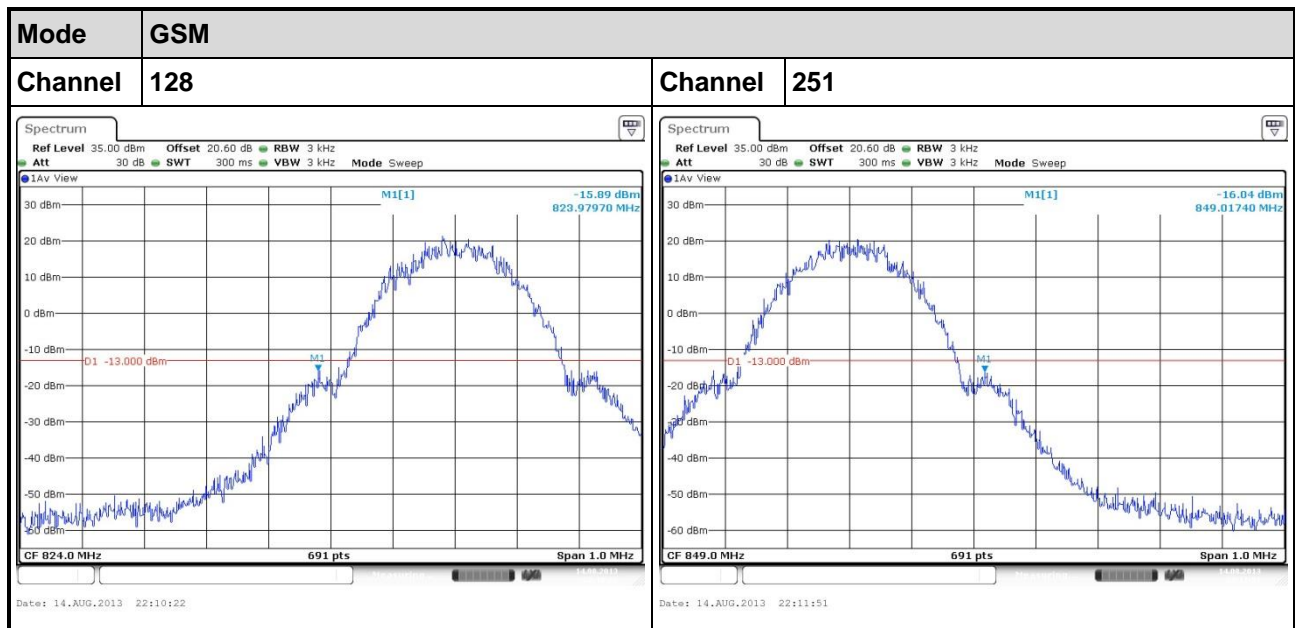



3.5 Occupied Bandwidth

3.5.1 Limit of Band Edge

The power of any emission outside of the authorized operating frequency ranges must be attenuated below the transmitting power (P) by a factor of at least $43 + 10 \log(P)$ dB equal to -13dBm.

3.5.2 Test Procedures

1. Set resolution bandwidth (RBW) = 10 kHz, Video bandwidth = 30 kHz for GSM mode.
Set resolution bandwidth (RBW) = 100 kHz, Video bandwidth = 300 kHz for WCDMA mode.
2. Detector = Sample, Trace mode = max hold.
3. Sweep = auto couple, Allow the trace to stabilize.
4. Using occupied bandwidth measurement function of spectrum analyzer to measure occupied bandwidth

3.5.3 Test Setup

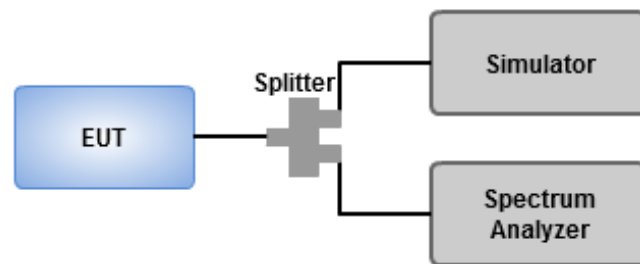



3.5.4 Test Result of Occupied Bandwidth

MODE	Channel	Frequency (MHz)	OBW (kHz)	26dB bandwidth(kHz)
GSM	128	824.2	246.02	317.39
GSM	190	836.6	244.57	311.59
GSM	251	848.8	244.57	315.94

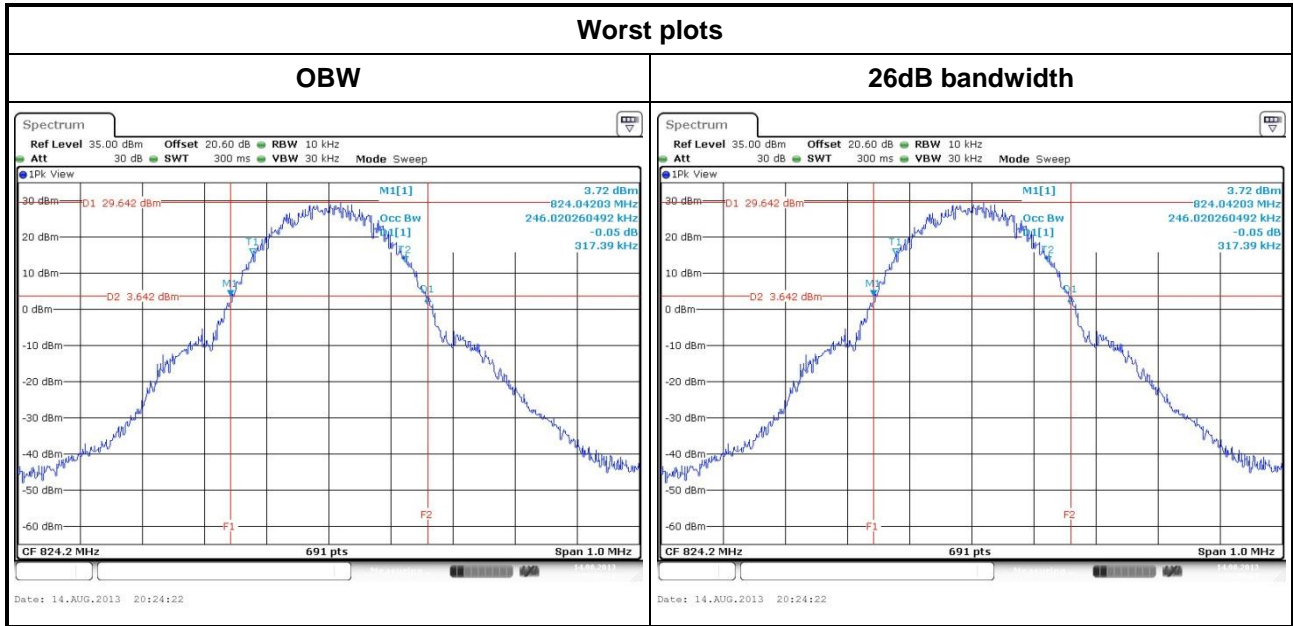



MODE	Channel	Frequency (MHz)	OBW (MHz)	26dB bandwidth(MHz)
WCDMA	4132	826.4	4.15	4.65
WCDMA	4182	836.4	4.14	4.64
WCDMA	4133	846.4	4.15	4.64

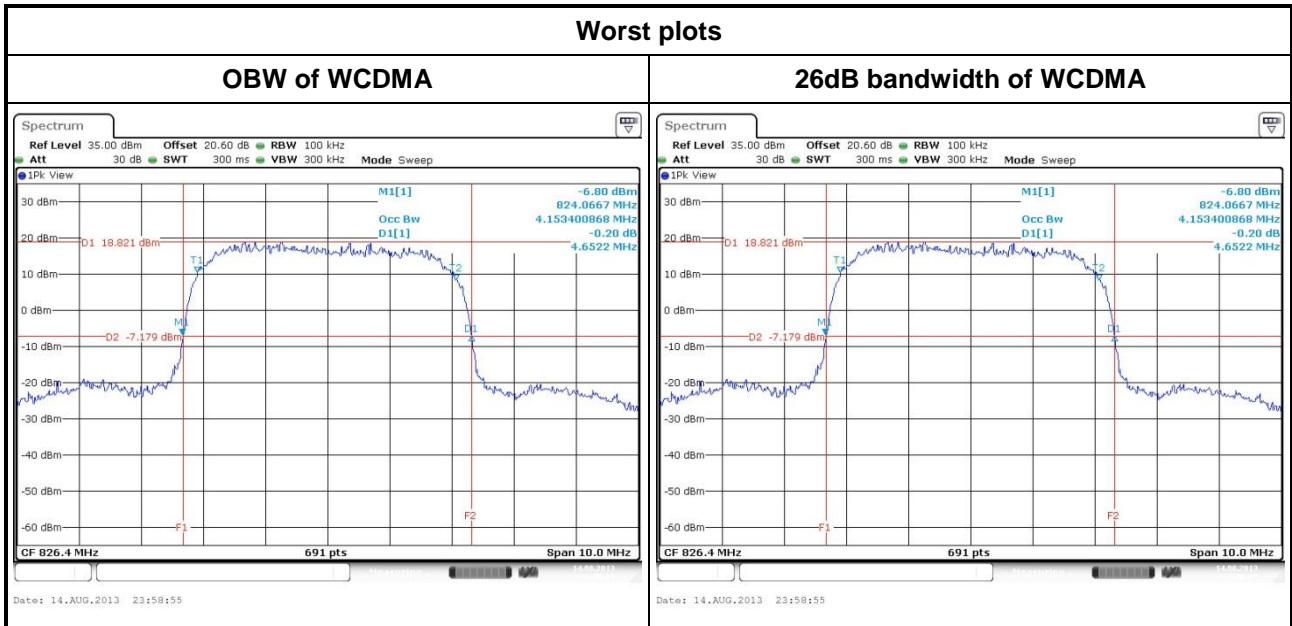



3.6 Peak to Average Ratio

3.6.1 Limit of Peak to Average Ratio

Peak-to-average ratio (PAR) of the transmission may not exceed 13 dB

3.6.2 Test Procedures

For GSM mode

1. Set RBW=1MHz, RBW=3MHz, Peak detector in Trace 1
2. Set RBW=1MHz, RBW=3MHz, RMs detector in Trace 2
3. Trigger function is enabled for measuring signal at burst on time. Measure the difference between trace1 and trace 2.

For WCDMA mode

1. Enable CCDF function of spectrum analyzer and set RBW=10MHz
2. Set the number of counts to a value that stabilizes the measured CCDF curve
3. Record the maximum PAPR level associated with a probability of 0.1%.

3.6.3 Test Setup

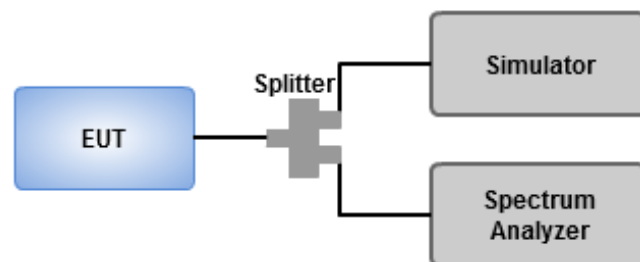



3.6.4 Test Result of Peak to Average Ratio

MODE	Channel	Frequency (MHz)	Peak to Average ratio (dB)
GSM	128	824.2	0.02
GSM	190	836.6	0.01
GSM	251	848.8	0.01
WCDMA	4132	826.4	3.22
WCDMA	4182	836.4	3.01
WCDMA	4133	846.6	3.51

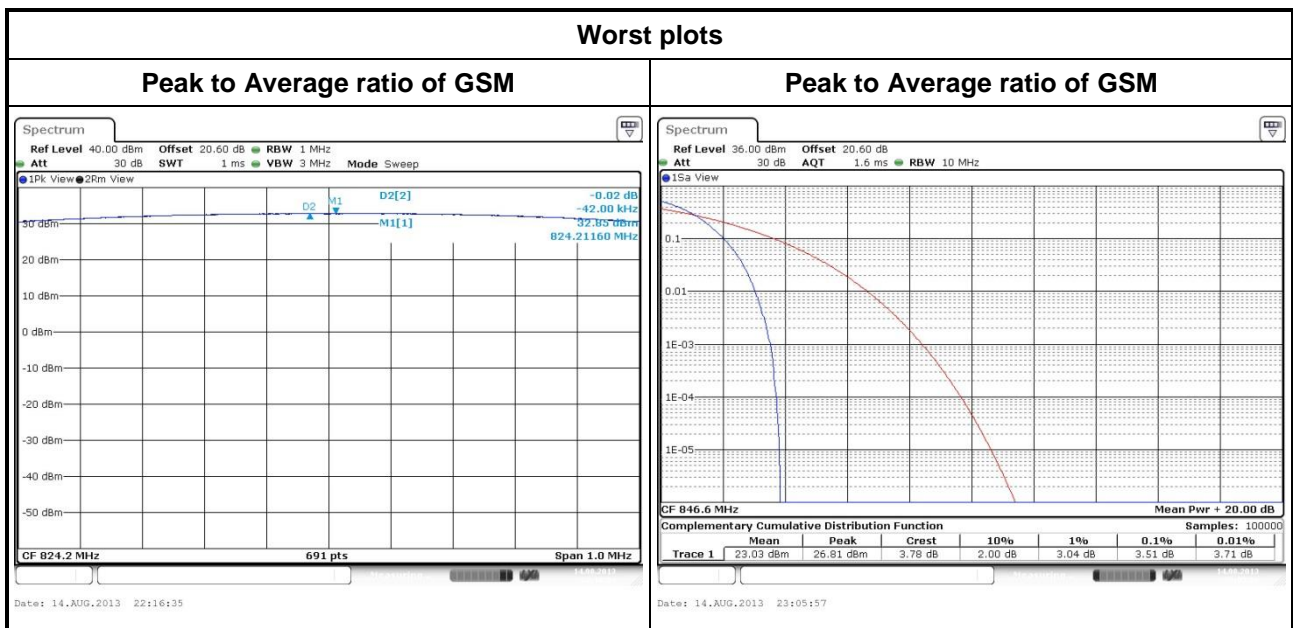



3.7 Frequency Stability

3.7.1 Limit of Frequency Stability

The frequency stability shall be less +/- 2.5ppm.

3.7.2 Test Procedures

1. EUT was placed at temperature chamber and connected to an external power supply.
2. Temperature and voltage condition shall be tested to confirm frequency stability.
3. Temperature range is from -30~50°C and voltage range is from lowest to highest working voltage.
4. Link up EUT and simulator. Confirm frequency drift value of simulator and record it.

3.7.3 Test Setup

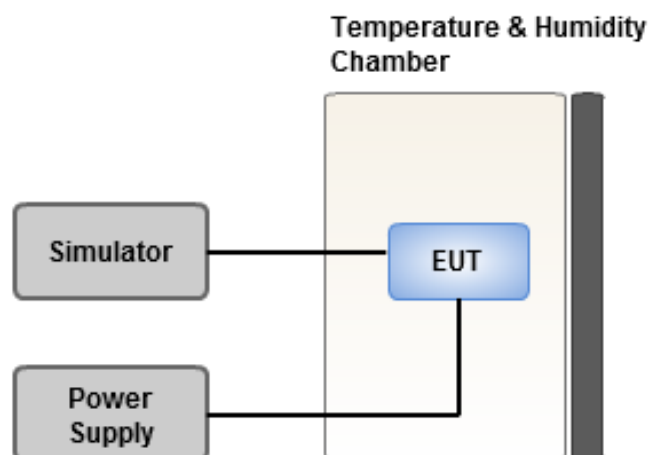



3.7.4 Test Result of Frequency Stability

Temperature (°C)	Voltage (dc)	Frequency Drift (ppm)		Limit (ppm)
		GSM	WCDMA	
55	3.9	0.006	-0.010	2.5
50	3.9	0.008	-0.014	2.5
40	3.9	0.010	-0.016	2.5
30	3.9	0.011	-0.018	2.5
20	3.9	0.011	-0.019	2.5
10	3.9	0.013	-0.022	2.5
0	3.9	0.016	-0.024	2.5
-10	3.9	0.016	-0.025	2.5
-20	3.9	0.018	-0.027	2.5
-30	3.9	0.022	-0.029	2.5
20	4.29	0.010	-0.017	2.5
20	3.51	0.012	-0.014	2.5

==END==