



# FCC Radio Test Report

## FCC ID: VO8-QNINE

*For*

**Bluetooth Headset**

**Model Name: Qnine**

**Brand Name: Bluedio**

**Report No.: ENC111102GZ26F1**

**Date of Issue: Nov.11, 2011**

*Prepared For*

**Guangzhou Liwei Electronics Co., LTD.**

**No.33, Zhenzhongbei Road, Shenshan Industrial Park Baiyuan District**

**Guangzhou 510005 P.R. China**

TEL: +86-20-8606 2626

FAX: +86-20-8606 2626-800

*Prepared By*

**East Notice Certification Service Co., Ltd.**

**317/319, 3/F, HuiCheng Building, XiangPu Street, DongPu,**

**TianHe, GuangZhou, China**

TEL: +86-20-2331 4234

FAX: +86-20-8256 8534

The results shown in this test report refer only to the sample(s) tested unless otherwise stated and the sample(s) are retained for 30 days only. The document is issued by ENC, this document cannot be reproduced except in full with our prior written permission. The document is available on request and the brief information for its validation can be assessable and confirmed at <http://www.enc-lab.com>.



317/319 3/F HuiCheng Building, XiangPu  
Street, DongPu, TianHe, GuangZhou

TEL: +86-020-2331 4234  
E-mail: [enc@enc-lab.com](mailto:enc@enc-lab.com)

Fax: +86-020-8256 8534  
[Http:// www.enc-lab.com](http://www.enc-lab.com)

## TABLE OF CONTENTS

<b>1 . CERTIFICATION.....</b>	<b>3</b>
<b>2 . SUMMARY OF TEST RESULTS.....</b>	<b>4</b>
2.1 TEST FACILITY.....	5
2.2 MEASUREMENT UNCERTAINTY.....	5
<b>3 . GENERAL INFORMATION.....</b>	<b>6</b>
3.1 GENERAL DESCRIPTION OF EUT.....	6
3.2 DESCRIPTION OF TEST MODES.....	8
3.3 TABLE OF PARAMETERS OF TEXT SOFTWARE SETTING.....	8
3.4 BLOCK DIGRAM SHOWING THE CONFIGURATION OF SYSTEM TESTED.....	9
3.5 DESCRIPTION OF SUPPORT UNITS(CONDUCTED MODE) .....	10
<b>4 . EMC EMISSION TEST.....</b>	<b>11</b>
4.1 CONDUCTED EMISSION MEASUREMENT.....	11
4.1.1 POWER LINE CONDUCTED EMISSION LIMITS.....	11
4.1.2 MEASUREMENT INSTRUMENTS LIST AND SETTING.....	11
4.1.3 TEST PROCEDURE.....	12
4.1.4 DEVIATION FROM TEST STANDARD.....	12
4.1.5 TEST SETUP.....	12
4.1.6 EUT OPERATING CONDITIONS.....	13
4.1.7 TEST RESULTS.....	14
<b>4.2 RADIATED EMISSION MEASUREMENT&amp; BAND EDGE.....</b>	<b>16</b>
4.2.1 RADIATED EMISSION LIMITS.....	16
4.2.2 MEASUREMENT INSTRUMENTS LIST ANS SETTING.....	17
4.2.3 TEST PROCEDURE.....	18
4.2.4 DEVIATION FROM TEST STANDARD.....	18
4.2.5 TEST SETUP.....	19
4.2.6 EUT OPERATING CONDITIONS.....	19
4.2.7 TEST RESULTS (BETWEEN30 – 1000 MHZ) .....	20
4.2.8 TEST RESULTS (ABOVE 1000 MHZ) .....	23
4.2.9 BAND EDGE .....	26
<b>5 . NUMBER OF HOPPING CHANNEL.....</b>	<b>31</b>
5.1 APPLIED PROCEDURES / LIMIT.....	31
5.1.1 MEASUREMENT INSTRUMENTS LIST AND SETTING.....	31
5.1.2 TEST PROCEDURE.....	31
5.1.3 DEVIATION FROM STANDARD.....	31
5.1.4 TEST SETUP.....	31
5.1.5 EUT OPERATION CONDITIONS.....	31
5.1.6 TEST RESULTS.....	32
<b>6 . AVERAGE TIME OF OCCUPANCY.....</b>	<b>33</b>
6.1 APPLIED PROCEDURES / LIMIT.....	33

The results shown in this test report refer only to the sample(s) tested unless otherwise stated and the sample(s) are retained for 30 days only. The document is issued by ENC, this document cannot be reproduced except in full with our prior written permission. The document is available on request and the brief information for its validation can be assessable and confirmed at <http://www.enc-lab.com>.



6.1.1 MEASUREMENT INSTRUMENTS LIST.....	33
6.1.2 TEST PROCEDURE.....	33
6.1.3 DEVIATION FROM STANDARD.....	33
6.1.4 TEST SETUP.....	34
6.1.5 EUT OPERATION CONDITIONS.....	34
6.1.6 TEST RESULTS.....	35
<b>7 . HOPPING CHANNEL SEPARATION MEASUREMENT.....</b>	<b>41</b>
7.1 APPLIED PROCEDURES / LIMIT.....	41
7.1.1 MEASUREMENT INSTRUMENTS LIST AND SETTING.....	41
7.1.2 TEST PROCEDURE.....	41
7.1.3 DEVIATION FROM STANDARD.....	41
7.1.4 TEST SETUP.....	41
7.1.5 EUT OPERATION CONDITIONS.....	41
7.1.6 TEST RESULTS.....	42
<b>8 . BANDWIDTH TEST.....</b>	<b>44</b>
8.1 APPLIED PROCEDURES / LIMIT.....	44
8.1.1 MEASUREMENT INSTRUMENTS LIST AND SETTING.....	44
8.1.2 TEST PROCEDURE.....	44
8.1.3 DEVIATION FROM STANDARD.....	44
8.1.4 TEST SETUP.....	44
8.1.5 EUT OPERATION CONDITIONS.....	44
8.1.6 TEST RESULTS.....	44
<b>9 . PEAK OUTPUT POWER TEST.....</b>	<b>47</b>
9.1 APPLIED PROCEDURES / LIMIT.....	47
9.1.1 MEASUREMENT INSTRUMENTS LIST AND SETTING.....	47
9.1.2 TEST PROCEDURE.....	47
9.1.3 DEVIATION FROM STANDARD.....	47
9.1.4 TEST SETUP.....	47
9.1.5 EUT OPERATION CONDITIONS.....	47
9.1.6 TEST RESULTS.....	48
<b>10 . ANTENNA CONDUCTED SPURIOUS EMISSION.....</b>	<b>50</b>
10.1 APPLIED PROCEDURES / LIMIT.....	50
10.1.1 MEASUREMENT INSTRUMENTS LIST AND SETTING.....	50
10.1.2 TEST PROCEDURE.....	50
10.1.3 DEVIATION FROM STANDARD.....	50
10.1.4 TEST SETUP.....	51
10.1.5 EUT OPERATION CONDITIONS.....	51
10.1.6 TEST RESULTS.....	52
<b>APPENDIX I .....</b>	<b>54</b>
<b>PHOTOGRAPHS OF THE TEST SETUP .....</b>	<b>54</b>

The results shown in this test report refer only to the sample(s) tested unless otherwise stated and the sample(s) are retained for 30 days only. The document is issued by ENC, this document cannot be reproduced except in full with our prior written permission. The document is available on request and the brief information for its validation can be assessable and confirmed at <http://www.enc-lab.com>.



## 1. CERTIFICATION

<b>Applicant:</b>	Guangzhou Liwei Electronics Co., LTD.
<b>Address:</b>	No.33, Zhenzhongbei Road, Shenshan Industrial Park Baiyun District, Guangzhou 510005 P.R., china
<b>Product Description:</b>	Bluetooth Headset
<b>Brand Name:</b>	Bluedio
<b>Model Number:</b>	Qnine
<b>FCC ID:</b>	VO8-QNINE
<b>Report Number:</b>	ENC111102GZ26F1
<b>Date of Test:</b>	Nov.2, 2011~Nov.11, 2011
<b>Standards:</b>	FCC Part15, Subpart C(15.247)/ANSI C63.4: 2003

### WE HEREBY CERTIFY THAT:

The above equipment was tested by East Notice Certification Service Co., Ltd. The test data, data evaluation, test procedures, and equipment configurations shown in this report were made in accordance with the procedures given in ANSI C63.4 (2003) and the energy emitted by the sample EUT tested as described in this report is in compliance with radiated emission limits of FCC Rules Part 15.247.

Checked By Yemig

Yemig Nov.11, 2011

Authorized By Ray Zhou

Ray Zhou Nov.11, 2011

The results shown in this test report refer only to the sample(s) tested unless otherwise stated and the sample(s) are retained for 30 days only. The document is issued by ENC, this document cannot be reproduced except in full with our prior written permission. The document is available on request and the brief information for its validation can be assessable and confirmed at <http://www.enc-lab.com>.



## 2. SUMMARY OF TEST RESULTS

Test procedures according to the technical standards:

FCC Part15 (15.247), Subpart C			
Standard Section	Test Item	Judgment	Remark
15.207	Conducted Emission	PASS	
15.247(c)	Antenna conducted Spurious Emission	PASS	
15.247(a)(1)	Hopping Channel Separation	PASS	
15.247 (b)(1)	Peak Output Power	PASS	
15.247 (c)	Radiated Spurious Emission	PASS	
15.247(d)	Band Edge	PASS	
15.247 (a)(1)(iii)	Number of Hopping Frequency	PASS	
15.247(a)(1)(iii)	Dwell Time	PASS	
15.205	Restricted Bands	PASS	
15.203	Antenna Requirement	PASS	
1.1307 1.1310 2.1091 2.1093	RF Exposure Compliance	PASS	

**NOTE:**

(1) "N/A" denotes test is not applicable in this Test Report

The results shown in this test report refer only to the sample(s) tested unless otherwise stated and the sample(s) are retained for 30 days only. The document is issued by ENC, this document cannot be reproduced except in full with our prior written permission. The document is available on request and the brief information for its validation can be assessable and confirmed at <http://www.enc-lab.com>.



## 2.1 TEST FACILITY

The test facilities used to collect the test data in this report is **GZ-C03/ GZ-C02** at the location of CGEL, Cunnan Street, Shayongnan, Sanyuanli District, Guangzhou, Guangdong, China, 510400. FCC register No.: 597719

## 2.2 MEASUREMENT UNCERTAINTY

Where relevant, the following measurement uncertainty levels have been estimated for tests performed on the EUT as specified in CISPR 16-4-2:

The reported uncertainty of measurement  $y \pm U$ , where expanded uncertainty  $U$  is based on a standard uncertainty multiplied by a coverage factor of  $k=2$ , providing a level of confidence of approximately **95 %**.

### A. Conducted Measurement:

Test Site	Method	Measurement Frequency Range	U, (dB)	NOTE
<b>GZ-C03</b>	CISPR	150 KHz ~ 30MHz	1.94	

### B. Radiated Measurement:

Test Site	Method	Measurement Frequency Range	Ant. H / V	U, (dB)	NOTE
<b>GZ-C02</b>	CISPR	30MHz ~ 200MHz	V	3.82	
		30MHz ~ 200MHz	H	3.60	
		200MHz ~ 1,000MHz	V	3.86	
		200MHz ~ 1,000MHz	H	3.94	

The results shown in this test report refer only to the sample(s) tested unless otherwise stated and the sample(s) are retained for 30 days only. The document is issued by ENC, this document cannot be reproduced except in full with our prior written permission. The document is available on request and the brief information for its validation can be assessable and confirmed at <http://www.enc-lab.com>.



### 3. GENERAL INFORMATION

#### 3.1 GENERAL DESCRIPTION OF EUT

<b>Equipment</b>	Bluetooth Headset	
<b>Brand Name</b>	Bluedio	
<b>Model Name</b>	Qnine	
<b>OEM Brand/Model Name</b>	N/A	
<b>Model Difference</b>	N/A	
<b>Product Description</b>	The EUT is a Bluetooth Headset	
	Operation Frequency:	2402~2480 MHz
	Modulation Type:	GFSK(1Mbps)
	Number Of Channel	79 CH
	Antenna Designation:	Please see Note 3.
	Antenna Gain(Peak)	Please see Note 3.
	Output Power:	-2.89 dBm (1Mbps)
Based on the application, features, or specification exhibited in User's Manual, the EUT is considered as an ITE/Computing Device. More details of EUT technical specification, please refer to the User's Manual.		
<b>Channel List</b>	Please refer to the Note 2.	
<b>Power Source</b>	DC Voltage supplied from AC/DC adapter & Li-ion battery	
<b>Power Rating</b>	#AC/DC Adapter :	
	Model name:LW001 I/P AC 100-240V~ 50/60Hz, 0.2A O/P 5.0~5.5V, 130mA # Li-ion battery 3.7Vdc	
<b>Connecting I/O Port(s)</b>	Please refer to the User's Manual	
<b>Products Covered</b>	N/A	

**Note:**

1. For a more detailed features description, please refer to the manufacturer's specifications or the User's Manual.

The results shown in this test report refer only to the sample(s) tested unless otherwise stated and the sample(s) are retained for 30 days only. The document is issued by ENC, this document cannot be reproduced except in full with our prior written permission. The document is available on request and the brief information for its validation can be assessable and confirmed at <http://www.enc-lab.com>.



2.

Channel List					
Channel	Frequency(MHz)	Channel	Frequency(MHz)	Channel	Frequency(MHz)
00	2402	27	2429	54	2456
01	2403	28	2430	55	2457
02	2404	29	2431	56	2458
03	2405	30	2432	57	2459
04	2406	31	2433	58	2460
05	2407	32	2434	59	2461
06	2408	33	2435	60	2462
07	2409	34	2436	61	2463
08	2410	35	2437	62	2464
09	2411	36	2438	63	2465
10	2412	37	2439	64	2466
11	2413	38	2440	65	2467
12	2414	39	2441	66	2468
13	2415	40	2442	67	2469
14	2416	41	2443	68	2470
15	2417	42	2444	69	2471
16	2418	43	2445	70	2472
17	2419	44	2446	71	2473
18	2420	45	2447	72	2474
19	2421	46	2448	73	2475
20	2422	47	2449	74	2476
21	2423	48	2450	75	2477
22	2424	49	2451	76	2478
23	2425	50	2452	77	2479
24	2426	51	2453	78	2480
25	2427	52	2454		
26	2428	53	2455		

3.

Ant.	Brand	Model Name	Antenna Type	Connector	Gain (dBi)	NOTE
-	-	-	PRINTED ANT	N/A	1.90	BT Antenna

The results shown in this test report refer only to the sample(s) tested unless otherwise stated and the sample(s) are retained for 30 days only. The document is issued by ENC, this document cannot be reproduced except in full with our prior written permission. The document is available on request and the brief information for its validation can be assessable and confirmed at <http://www.enc-lab.com>.





### 3.2 DESCRIPTION OF TEST MODES

To investigate the maximum EMI emission characteristics generates from EUT, the test system was pre-scanning tested base on the consideration of following EUT operation mode or test configuration mode which possible have effect on EMI emission level. Each of these EUT operation mode(s) or test configuration mode(s) mentioned above was evaluated respectively.

Pretest Mode	Description
Mode 1	CH00 (1Mbps) EUT only
Mode 2	CH39(1Mbps) EUT only
Mode 3	CH78(1Mbps) EUT only
Mode 4	Charger Mode

The EUT system operated these modes were found to be the worst case during the pre-scanning test as Following:

For Conducted Emission	
Final Test Mode	Description
Mode 4	Charger Mode

For Radiated Emission	
Final Test Mode	Description
Mode 1	CH00 (1Mbps) EUT only
Mode 2	CH39(1Mbps) EUT only
Mode 3	CH78(1Mbps) EUT only

Note:

- (1) The measurements are performed at the highest, middle, lowest available channels.

### 3.3 TABLE OF PARAMETERS OF TEXT SOFTWARE SETTING

During testing channel & power controlling software provided by the customer was used to control the operating channel as well as the output power level. The RF output power selection is for the setting of RF output power expected by the customer and is going to be fixed on the firmware of the final end product power parameters of FHSS

Test software Version	Test program: Bluetest.exe		
Frequency	2402 MHz	2441 MHz	2480 MHz
Parameters-1Mbps	3	3	3

The results shown in this test report refer only to the sample(s) tested unless otherwise stated and the sample(s) are retained for 30 days only. The document is issued by ENC, this document cannot be reproduced except in full with our prior written permission. The document is available on request and the brief information for its validation can be assessable and confirmed at <http://www.enc-lab.com>.



### 3.4 BLOCK DIGRAM SHOWING THE CONFIGURATION OF SYSTEM TESTED

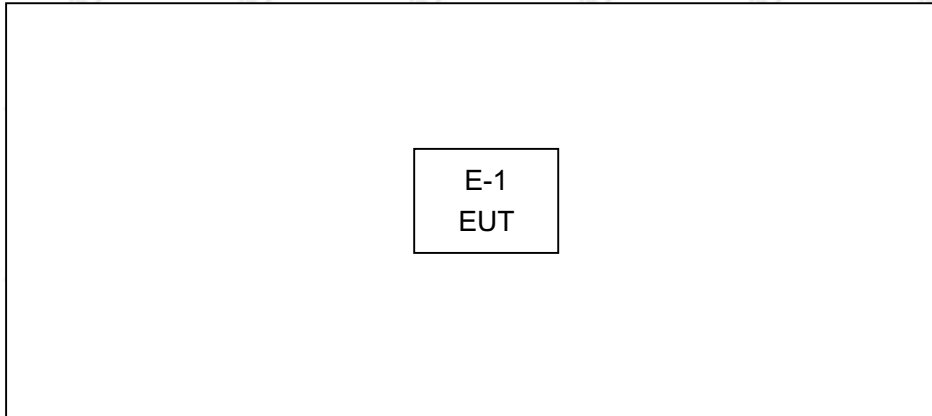

The results shown in this test report refer only to the sample(s) tested unless otherwise stated and the sample(s) are retained for 30 days only. The document is issued by ENC, this document cannot be reproduced except in full with our prior written permission. The document is available on request and the brief information for its validation can be assessable and confirmed at <http://www.enc-lab.com>.



### 3.5 DESCRIPTION OF SUPPORT UNITS (CONDUCTED MODE)

The EUT has been tested as an independent unit together with other necessary accessories or support units. The following support units or accessories were used to form a representative test configuration during the tests.

Item	Equipment	Mfr/Brand	Model/Type No.	FCC ID	Series No.	Note
E-1	Bluetooth Headset	Bluedio	Qnine	VO8-QNINE	N/A	EUT

Item	Shielded Type	Ferrite Core	Length Note	Note

Note:

- (1) The support equipment was authorized by Declaration of Confirmation.
- (2) For detachable type I/O cable should be specified the length in cm in 『Length』 column.

The results shown in this test report refer only to the sample(s) tested unless otherwise stated and the sample(s) are retained for 30 days only. The document is issued by ENC, this document cannot be reproduced except in full with our prior written permission. The document is available on request and the brief information for its validation can be assessable and confirmed at <http://www.enc-lab.com>.



#### 4. EMC EMISSION TEST

##### 4.1 CONDUCTED EMISSION MEASUREMENT

##### 4.1.1 POWER LINE CONDUCTED EMISSION Limits (Frequency Range 150KHz-30MHz)

FREQUENCY (MHz)	Class A (dBuV)		Class B (dBuV)		Standard
	Quasi-peak	Average	Quasi-peak	Average	
0.15-0.5	79.00	66.00	66 - 56 *	56 - 46 *	CISPR
0.50-5.0	73.00	60.00	56.00	46.00	CISPR
5.0-30.0	73.00	60.00	60.00	50.00	CISPR

0.15-0.5	79.00	66.00	66 - 56 *	56 - 46 *	FCC
0.50-5.0	73.00	60.00	56.00	46.00	FCC
5.0-30.0	73.00	60.00	60.00	50.00	FCC

Note:

(1) The tighter limit applies at the band edges.

(2) The limit of " \* " marked band means the limitation decreases linearly with the logarithm of the frequency in the range.

##### 4.1.2 MEASUREMENT INSTRUMENTS LIST AND SETTING

Item	Kind of Equipment	Manufacturer	Type No.	Serial No.	Calibrated until
1	LISN	EMCO	3816/2	00052765	05/29/2012
2	LISN	Rolf Heine	NNB-2-16Z	99044	05/29/2012
3	50Ω Terminator	SHX	TF2-3G-A	08122901	05/29/2012
4	Transient Limiter	Agilent	11947A	3107A03668	05/29/2012
5	Test Cable	N/A	C-06_C03	N/A	05/29/2012
6	Emi Test Receiver	R&S	ESCS30	8333641017	05/29/2012

Remark: " N/A " denotes No Model No. , Serial No. or No Calibration specified.

##### Receiver Parameters Setting

Receiver Parameters	Setting
Attenuation	10 dB
Start Frequency	0.15 MHz
Stop Frequency	30 MHz
IF Bandwidth	9 kHz

The results shown in this test report refer only to the sample(s) tested unless otherwise stated and the sample(s) are retained for 30 days only. The document is issued by ENC, this document cannot be reproduced except in full with our prior written permission. The document is available on request and the brief information for its validation can be assessable and confirmed at <http://www.enc-lab.com>.



#### 4.1.3 TEST PROCEDURE

- a. The EUT was placed 0.8 meters from the horizontal ground plane with EUT being connected to the power mains through a line impedance stabilization network (LISN). All other support equipments powered from additional LISN(s). The LISN provide 50 Ohm/ 50uH of coupling impedance for the measuring instrument.
- b. Interconnecting cables that hang closer than 40 cm to the ground plane shall be folded back and forth in the center forming a bundle 30 to 40 cm long.
- c. I/O cables that are not connected to a peripheral shall be bundled in the center. The end of the cable may be terminated, if required, using the correct terminating impedance. The overall length shall not exceed 1 m.
- d. LISN at least 80 cm from nearest part of EUT chassis.
- e. For the actual test configuration, please refer to the related Item –EUT Test Photos.

#### 4.1.4 DEVIATION FROM TEST STANDARD

No deviation

#### 4.1.5 TEST SETUP

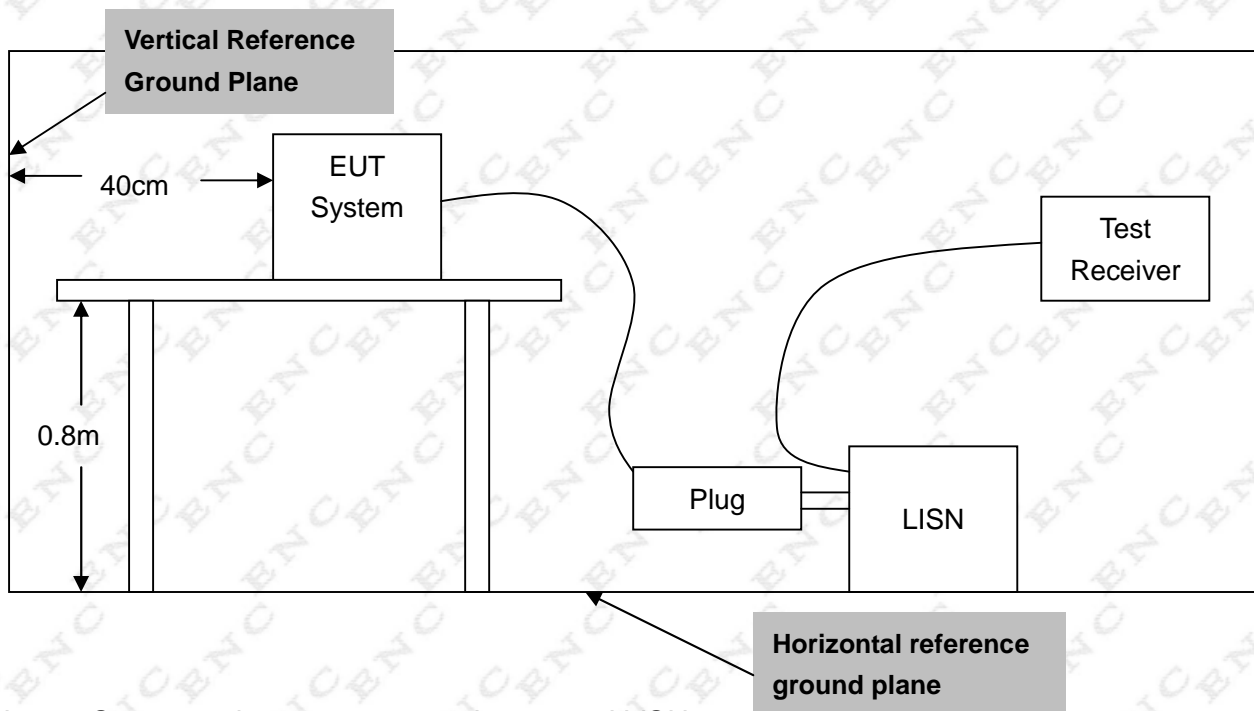

- Note: 1. Support units were connected to second LISN .  
2 .Both of LISNs (AMN ) are 80 cm from EUT and at least 80 cm from other units and other metal planes Vertical Reference Ground Plane*

The results shown in this test report refer only to the sample(s) tested unless otherwise stated and the sample(s) are retained for 30 days only. The document is issued by ENC, this document cannot be reproduced except in full with our prior written permission. The document is available on request and the brief information for its validation can be assessable and confirmed at <http://www.enc-lab.com>.

#### 4.1.6 EUT OPERATING CONDITIONS

The EUT was configured for testing in a typical fashion (as a customer would normally use it). The EUT has been programmed to continuously transmit during test. This operating condition was tested and used to collect the included data.

The results shown in this test report refer only to the sample(s) tested unless otherwise stated and the sample(s) are retained for 30 days only. The document is issued by ENC, this document cannot be reproduced except in full with our prior written permission. The document is available on request and the brief information for its validation can be assessable and confirmed at <http://www.enc-lab.com>.



### 4.1.7 TEST RESULTS

EUT:	Bluetooth Headset	Model Name :	Qnine
Temperature:	23 °C	Relative Humidity:	65 %
Pressure:	1012hPa	Test Voltage :	AC 120V/60Hz
Test Mode:	Charger Mode		

Freq. (MHz)	Terminat I L/N	Measured(dBuV)		Limits(dBuV)		Margin (dB)	Note
		QP-Mode	AV-Mode	QP-Mode	AV-Mode		
0.881	Line	43.15	33.15	56.00	46.00	-12.85	(QP)
2.942	Line	38.30	28.30	56.00	46.00	-17.70	(QP)
11.849	Line	42.75	32.75	60.00	50.00	-17.25	(QP)
0.859	Line	44.04	34.04	56.00	46.00	-11.96	(QP)
0.899	Line	43.94	33.94	56.00	46.00	-12.06	(QP)
2.412	Line	39.39	29.39	56.00	46.00	-16.61	(QP)

Remark:

- (1) All readings are QP Mode value unless otherwise stated AVG in column of 『Note』. If the QP Mode Measured value compliance with the QP Limits and lower than AVG Limits, the EUT shall be deemed to meet both QP & AVG Limits and then only QP Mode was measured, but AVG Mode didn't perform. In this case, a “\*” marked in AVG Mode column of Interference Voltage Measured.
- (2) Measuring frequency range from 150KHz to 30MHz.

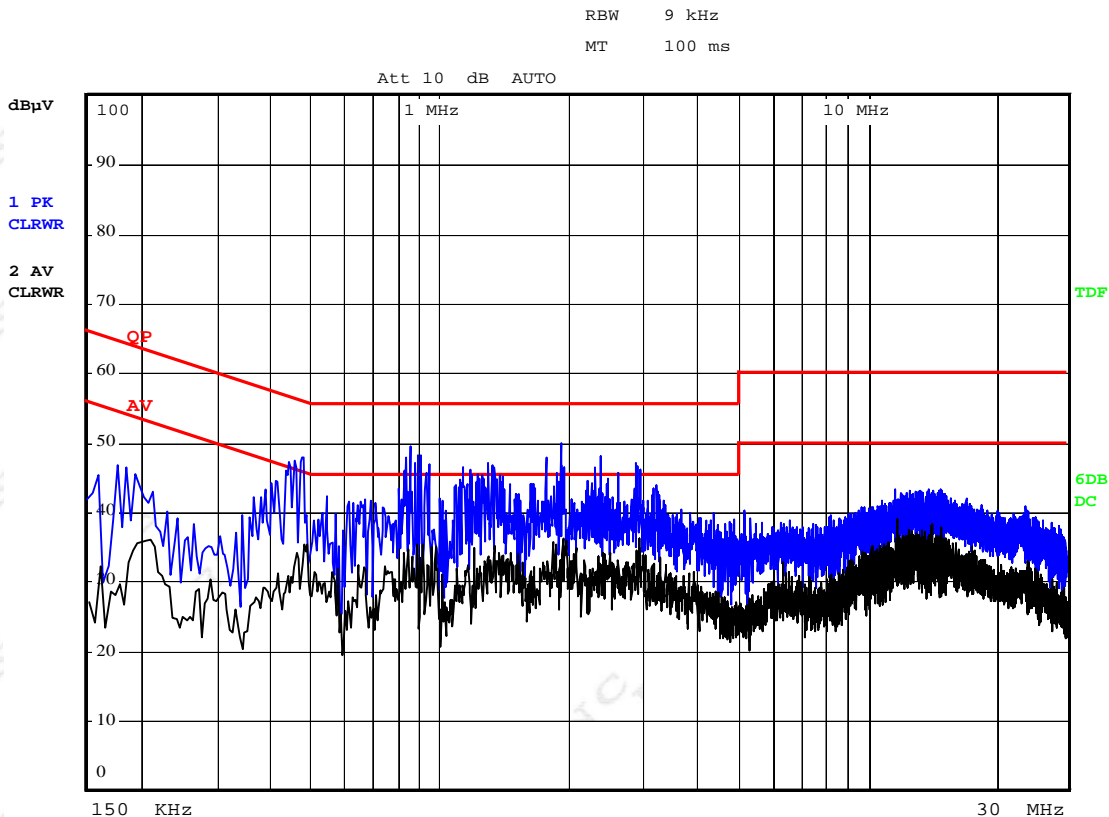

The results shown in this test report refer only to the sample(s) tested unless otherwise stated and the sample(s) are retained for 30 days only. The document is issued by ENC, this document cannot be reproduced except in full with our prior written permission. The document is available on request and the brief information for its validation can be assessable and confirmed at <http://www.enc-lab.com>.



EUT:	Bluetooth Headset	Model Name :	Qnine
Temperature:	23 °C	Relative Humidity:	65 %
Pressure:	1012hPa	Test Voltage :	AC 120V/60Hz
Test Mode:	Charger Mode		

Freq. (MHz)	Terminal L/N	Measured(dBuV)		Limits(dBuV)		Margin (dB)	Note
		QP-Mode	AV-Mode	QP-Mode	AV-Mode		
0.908	Neutral	44.83	34.83	56.00	46.00	-11.17	(QP)
1.649	Neutral	46.42	36.42	56.00	46.00	-9.58	(QP)
2.736	Neutral	44.93	34.93	56.00	46.00	-11.07	(QP)
0.473	Neutral	36.62	26.62	56.00	46.00	-19.38	(QP)
1.447	Neutral	37.51	27.51	56.00	46.00	-18.49	(QP)
2.318	Neutral	42.16	32.16	56.00	46.00	-13.84	(QP)

Remark:

- (1) All readings are QP Mode value unless otherwise stated AVG in column of 『Note』. If the QP Mode Measured value compliance with the QP Limits and lower than AVG Limits, the EUT shall be deemed to meet both QP & AVG Limits and then only QP Mode was measured, but AVG Mode didn't perform. In this case, a “\*” marked in AVG Mode column of Interference Voltage Measured.
- (2) Measuring frequency range from 150KHz to 30MHz.

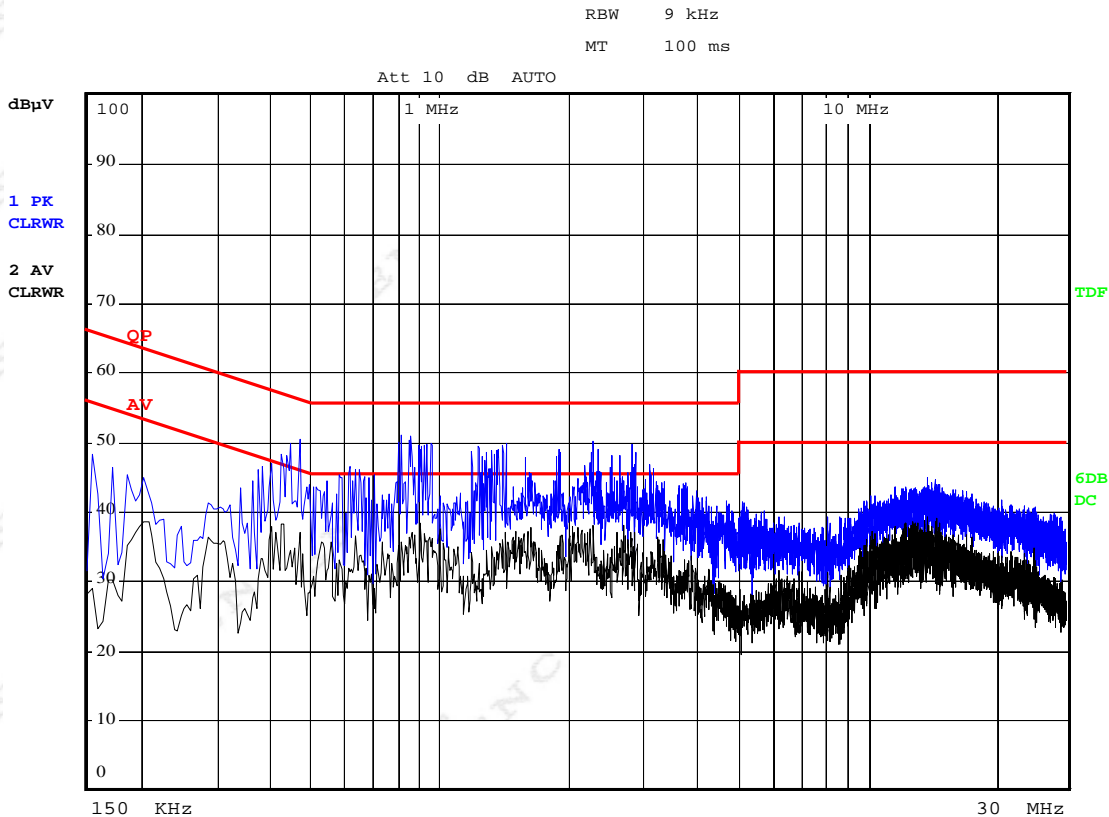

The results shown in this test report refer only to the sample(s) tested unless otherwise stated and the sample(s) are retained for 30 days only. The document is issued by ENC, this document cannot be reproduced except in full with our prior written permission. The document is available on request and the brief information for its validation can be assessable and confirmed at <http://www.enc-lab.com>.





## 4.2 RADIATED EMISSION MEASUREMENT

### 4.2.1 RADIATED EMISSION LIMITS (Frequency Range 9kHz-1000MHz)

20dBc in any 100 kHz bandwidth outside the operating frequency band. In case the emission fall within the restricted band specified on 15.205(a), then the 15.209(a) limit in the table below has to be followed. Frequencies

Frequencies (MHz)	Field Strength (micorvolts/meter)	Measurement Distance (meters)
0.009~0.490	2400/F(KHz)	300
0.490~1.705	24000/F(KHz)	30
1.705~30.0	30	30
30~88	100	3
88~216	150	3
216~960	200	3
Above 960	500	3

### LIMITS OF RADIATED EMISSION MEASUREMENT (Above 1000MHz)

Frequencies (MHz)	Class A (dBuV/m) (at 3M)		Class B (dBuV/m) (at 3M)	
	PEAK	AVERAGE	PEAK	AVERAGE
Above 1000	80	60	74	54

Notes:

- (1) The limit for radiated test was performed according to FCC PART 15C.
- (2) The tighter limit applies at the band edges.
- (3) Emission level (dBuV/m)=20log Emission level (uV/m).

### FREQUENCY RANGE OF RADIATED MEASUREMENT (For unintentional radiators)

Highest frequency generated or Upper frequency of measurement used in the device or on which the device operates or tunes (MHz)	Range (MHz)
Below 1.705	30
1.705 – 108	1000
108 – 500	2000
500 – 1000	5000
Above 1000	5 <sup>th</sup> harmonic of the highest frequency or 40 GHz, whichever is lower

The results shown in this test report refer only to the sample(s) tested unless otherwise stated and the sample(s) are retained for 30 days only. The document is issued by ENC, this document cannot be reproduced except in full with our prior written permission. The document is available on request and the brief information for its validation can be assessable and confirmed at <http://www.enc-lab.com>.



#### 4.2.2 MEASUREMENT INSTRUMENTS LIST AND SETTING

Item	Kind of Equipment	Manufacturer	Type No.	Serial No.	Calibrated until
1	Antenna	ETS	3115	00075789	05/29/2012
2	Amplifier	Agilent	8449B 3	008A02274	05/29/2012
3	Spectrum	Agilent	E4408B	US39240143	05/29/2012
4	Test Cable	HUBER+SUHNER	GZ02 High Fre	N/A	05/29/2012
5	Antenna	Schwarbeck	VULB9160	9160-3232	05/29/2012
6	Amplifier	HP	8447D	2944A09673	05/29/2012
7	Test Receiver	R&S	ESCI	100895	05/29/2012
8	Test Cable	N/A	C-01_GZ02	N/A	05/29/2012
9	Controller	CT	SC100	N/A	N/A

Remark: " N/A" denotes No Model Name / Serial No. and No Calibration specified.

Spectrum Parameter	Setting
Attenuation	Auto
Start Frequency	1000 MHz
Stop Frequency	10th carrier harmonic
RB / VB (emission in restricted band)	1 MHz / 1 MHz for Peak, 1 MHz / 10Hz for Average

Receiver Parameter	Setting
Attenuation	Auto
Start ~ Stop Frequency	9kHz~150kHz / RB 200Hz for QP
Start ~ Stop Frequency	150kHz~30MHz / RB 9kHz for QP
Start ~ Stop Frequency	30MHz~1000MHz / RB 120kHz for QP

The results shown in this test report refer only to the sample(s) tested unless otherwise stated and the sample(s) are retained for 30 days only. The document is issued by ENC, this document cannot be reproduced except in full with our prior written permission. The document is available on request and the brief information for its validation can be assessable and confirmed at <http://www.enc-lab.com>.



#### 4.2.3 TEST PROCEDURE

- a. The measuring distance of at 3 m shall be used for measurements at frequency up to 1GHz. For frequencies above 1GHz, any suitable measuring distance may be used.
- b. The EUT was placed on the top of a rotating table 0.8 meters above the ground at a 3 meter semi-anechoic chamber. The table was rotated 360 degrees to determine the position of the highest radiation.
- c. The height of the equipment or of the substitution antenna shall be 0.8 m; the height of the test antenna shall vary between 1 m to 4 m. Both horizontal and vertical polarizations of the antenna are set to make the measurement.
- d. The initial step in collecting conducted emission data is a spectrum analyzer peak detector mode pre-scanning the measurement frequency range. Significant peaks are then marked and then Quasi Peak detector mode re-measured.
- e. If the Peak Mode measured value compliance with and lower than Quasi Peak Mode Limit, the EUT shall be deemed to meet QP Limits and then no additional QP Mode measurement performed.
- f. For the actual test configuration, please refer to the related Item –EUT Test Photos.

#### 4.2.4 DEVIATION FROM TEST STANDARD

No deviation

The results shown in this test report refer only to the sample(s) tested unless otherwise stated and the sample(s) are retained for 30 days only. The document is issued by ENC, this document cannot be reproduced except in full with our prior written permission. The document is available on request and the brief information for its validation can be assessable and confirmed at <http://www.enc-lab.com>.



#### 4.2.5 TEST SETUP

##### (A) Radiated Emission Test Set-Up Frequency Below 1 GHz

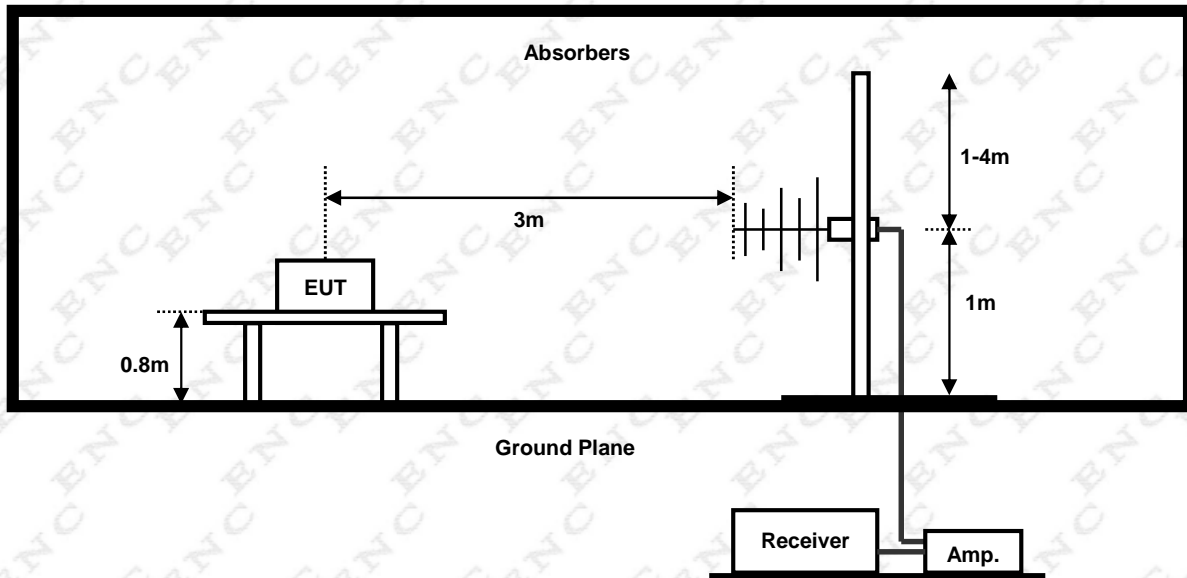

##### (B) Radiated Emission Test Set-Up Frequency Above 1 GHz

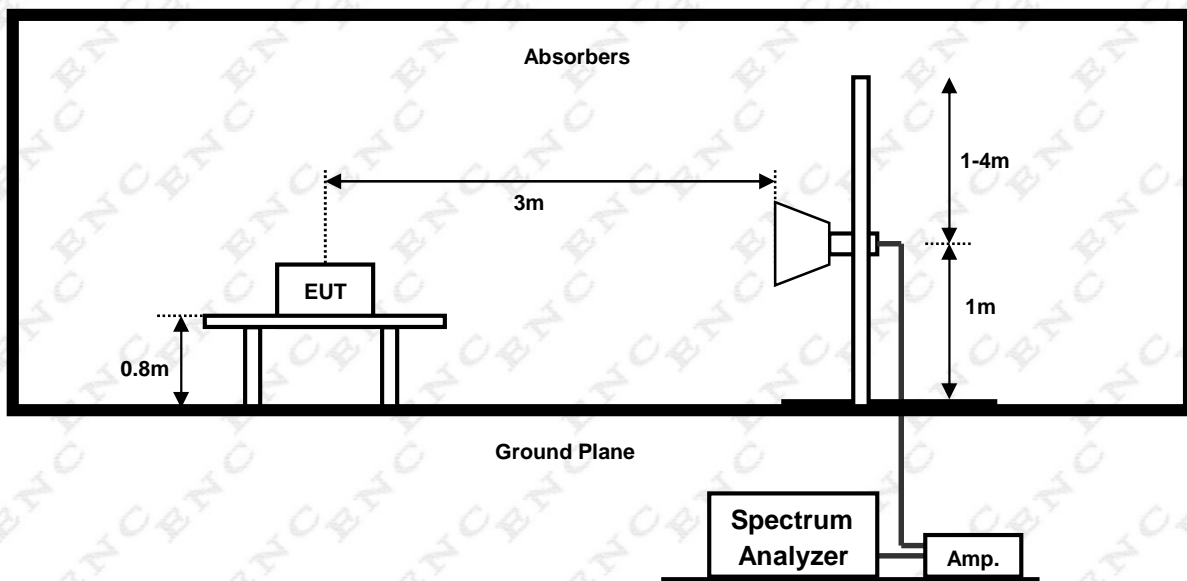

#### 4.2.6 EUT OPERATING CONDITIONS

The EUT tested system was configured as the statements of 4.1.6 Unless otherwise a special operating condition is specified in the follows during the testing.

The results shown in this test report refer only to the sample(s) tested unless otherwise stated and the sample(s) are retained for 30 days only. The document is issued by ENC, this document cannot be reproduced except in full with our prior written permission. The document is available on request and the brief information for its validation can be assessable and confirmed at <http://www.enc-lab.com>.

#### 4.2.7 TEST RESULTS (BETWEEN 30 – 1000 MHZ)

EUT:	Bluetooth Headset	Model Name :	Qnine
Temperature:	23 °C	Relative Humidity:	65 %
Pressure:	1012hPa	Test Voltage :	DC 3.7V
Test Mode:	TX 2402MHz –CH00-1Mbps		

Freq. (MHz)	Ant. H/V	Reading(RA) (dBuV)	Corr.Factor(CF) (dB)	Measured(FS) (dBuV/m)	Limits(QP) (dBuV/m)	Margin (dB)	Note
380.86	H	35.33	-11.26	24.07	46.00	-21.93	
419.23	H	39.96	-10.56	29.40	46.00	-16.60	
597.91	H	33.80	-7.31	26.49	46.00	-19.51	
939.87	H	35.48	-1.09	34.39	46.00	-11.61	
117.83	V	35.28	-16.04	19.24	43.50	-24.26	
180.37	V	35.44	-14.90	20.54	43.50	-22.96	
300.86	V	34.31	-12.71	21.60	46.00	-24.40	
869.13	V	37.32	-2.38	34.94	46.00	-11.06	

Remark:

- (1) Reading in which marked as QP or Peak means measurements by using are Quasi-Peak Mode or Peak Mode with Detector BW=120KHz; SPA setting in RBW=120KHz, VBW =120KHz, Swp. Time = 0.3 sec./MHz.
- (2) All readings are Peak unless otherwise stated QP in column of 『 Note 』 . Peak denotes that the Peak reading compliance with the QP Limits and then QP Mode measurement didn't perform.
- (3) Measuring frequency range from 30MHz to 1000MHz.
- (4) If the peak scan value lower limit more than 20dB, then this signal data does not show in table.

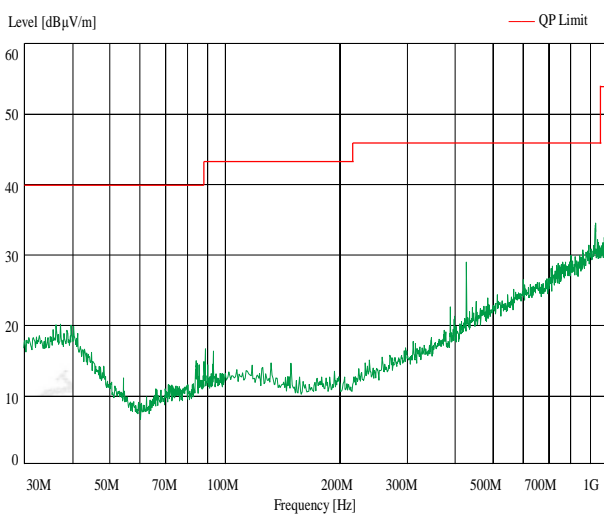

Antenna Horizontal

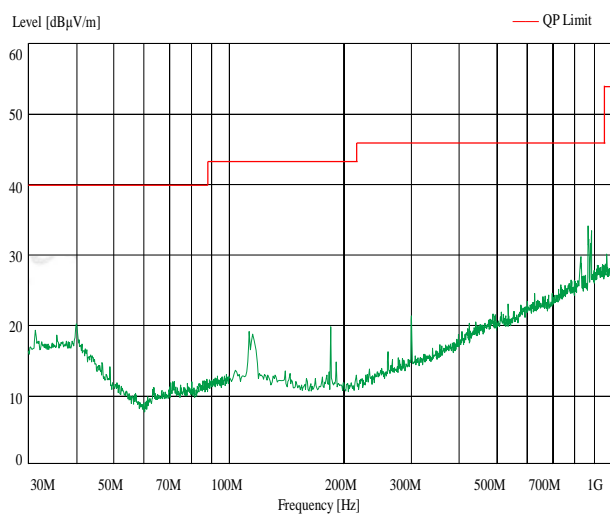

Antenna Vertical

The results shown in this test report refer only to the sample(s) tested unless otherwise stated and the sample(s) are retained for 30 days only. The document is issued by ENC, this document cannot be reproduced except in full with our prior written permission. The document is available on request and the brief information for its validation can be assessable and confirmed at <http://www.enc-lab.com>.



EUT:	Bluetooth Headset	Model Name :	Qnine
Temperature:	23 °C	Relative Humidity:	65 %
Pressure:	1012hPa	Test Voltage :	DC 3.7V
Test Mode:	TX 2441MHz –CH39-1Mbps		

Freq. (MHz)	Ant. H/V	Reading(RA) (dBuV)	Corr.Factor(CF) (dB)	Measured(FS) (dBuV/m)	Limits(QP) (dBuV/m)	Margin (dB)	Note
44.57	H	45.07	-17.37	27.70	40.00	-12.30	
168.79	H	32.91	-15.11	17.80	43.50	-25.70	
435.97	H	32.66	-10.26	22.40	46.00	-23.60	
840.82	H	34.57	-2.89	31.68	46.00	-14.32	
44.92	V	44.57	-17.37	27.20	40.00	-12.80	
161.66	V	36.04	-15.24	20.80	43.50	-22.70	
558.65	V	34.42	-8.02	26.40	46.00	-19.60	
827.50	V	39.06	-3.14	35.92	46.00	-10.08	

**Remark**

- (1) Reading in which marked as QP or Peak means measurements by using are Quasi-Peak Mode or Peak Mode with Detector BW=120KHz; SPA setting in RBW=120KHz, VBW =120KHz, Swp. Time = 0.3 sec./MHz.
- (2) All readings are Peak unless otherwise stated QP in column of 『Note』 . Peak denotes that the Peak reading compliance with the QP Limits and then QP Mode measurement didn't perform.
- (3) Measuring frequency range from 30MHz to 1000MHz.
- (4) If the peak scan value lower limit more than 20dB, then this signal data does not show in table.

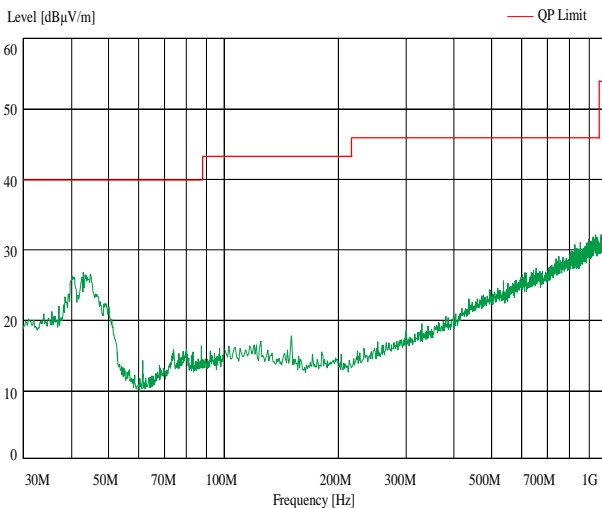

Antenna Horizontal

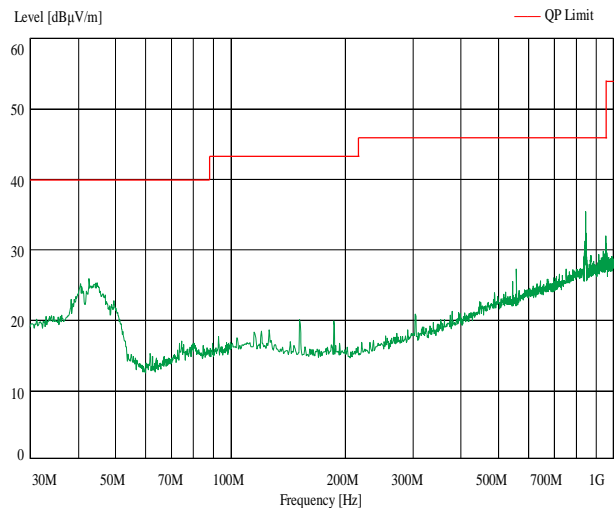

Antenna Vertical

The results shown in this test report refer only to the sample(s) tested unless otherwise stated and the sample(s) are retained for 30 days only. The document is issued by ENC, this document cannot be reproduced except in full with our prior written permission. The document is available on request and the brief information for its validation can be assessable and confirmed at <http://www.enc-lab.com>.



EUT:	Bluetooth Headset	Model Name :	Qnine
Temperature:	23 °C	Relative Humidity:	65 %
Pressure:	1012hPa	Test Voltage :	DC 3.7V
Test Mode:	TX 2480MHz –CH78-1Mbps		

Freq. (MHz)	Ant. H/V	Reading(RA) (dBuV)	Corr.Factor(CF) (dB)	Measured(FS) (dBuV/m)	Limits(QP) (dBuV/m)	Margin (dB)	Note
44.45	H	40.96	-17.37	23.59	40.00	-16.41	
70.86	H	36.96	-16.89	20.07	40.00	-19.93	
189.23	H	38.14	-14.74	23.40	43.50	-20.10	
527.91	H	35.07	-8.58	26.49	46.00	-19.51	
43.47	V	40.96	-17.39	23.57	40.00	-16.43	
69.86	V	36.73	-16.91	19.82	40.00	-20.18	
186.43	V	37.47	-14.79	22.68	43.50	-20.82	
523.02	V	34.43	-8.67	25.76	46.00	-20.24	

**Remark**

- (1) Reading in which marked as QP or Peak means measurements by using are Quasi-Peak Mode or Peak Mode with Detector BW=120KHz; SPA setting in RBW=120KHz, VBW =120KHz, Swp. Time = 0.3 sec./MHz.
- (2) All readings are Peak unless otherwise stated QP in column of 『Note』 . Peak denotes that the Peak reading compliance with the QP Limits and then QP Mode measurement didn't perform.
- (3) Measuring frequency range from 30MHz to 1000MHz.
- (4) If the peak scan value lower limit more than 20dB, then this signal data does not show in table.

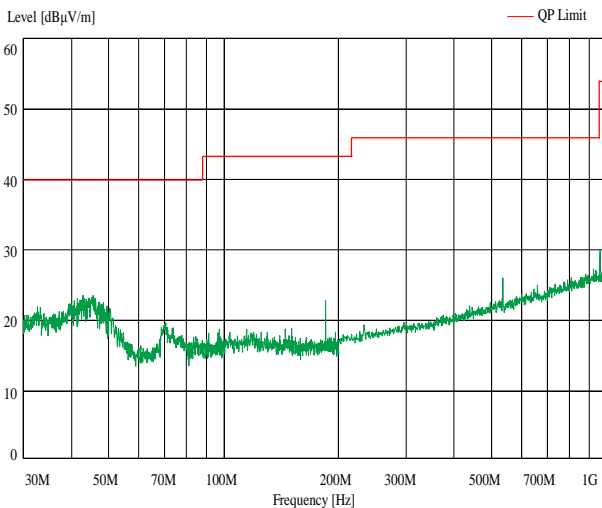

Antenna Horizontal

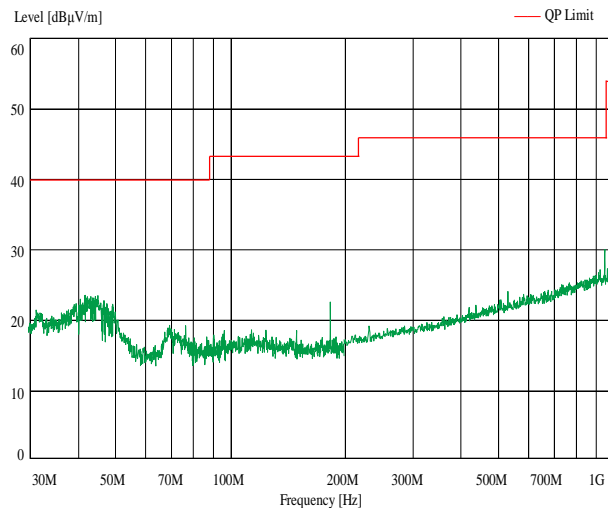

Antenna Vertical

The results shown in this test report refer only to the sample(s) tested unless otherwise stated and the sample(s) are retained for 30 days only. The document is issued by ENC, this document cannot be reproduced except in full with our prior written permission. The document is available on request and the brief information for its validation can be assessable and confirmed at <http://www.enc-lab.com>.



### 4.2.8 TEST RESULTS (ABOVE 1000 MHZ)

EUT:	Bluetooth Headset	Model Name :	Qnine
Temperature:	23 °C	Relative Humidity:	65 %
Pressure:	1012hPa	Test Voltage :	DC 3.7V
Test Mode:	TX 2402MHz – CH00-1Mbps		

Freq. (MHz)	Ant. H/V	Level (dBuV)	Corr.Factor(CF) (dB)	Measured(FS) (dBuV/m)	Limits(QP) (dBuV/m)	Margin (dB)	Note
5652.94	H	52.06	1.18	53.24	74.00	-20.76	Peak
6865.52	H	52.86	1.44	54.30	74.00	-19.70	Peak
7969.81	H	54.48	1.67	56.15	74.00	-17.85	Peak
8299.77	H	56.03	1.74	57.77	74.00	-16.23	Peak
5473.65	V	52.45	1.14	53.59	74.00	-20.41	Peak
6551.59	V	52.95	1.37	54.32	74.00	-19.68	Peak
7637.92	V	54.51	1.60	56.11	74.00	-17.89	Peak
8874.63	V	56.47	1.86	58.33	74.00	-15.67	Peak

Remark:

- (1) Factor = Antenna Factor + Cable Loss – Pre-amplifier.  
No emission detected above 18GHz

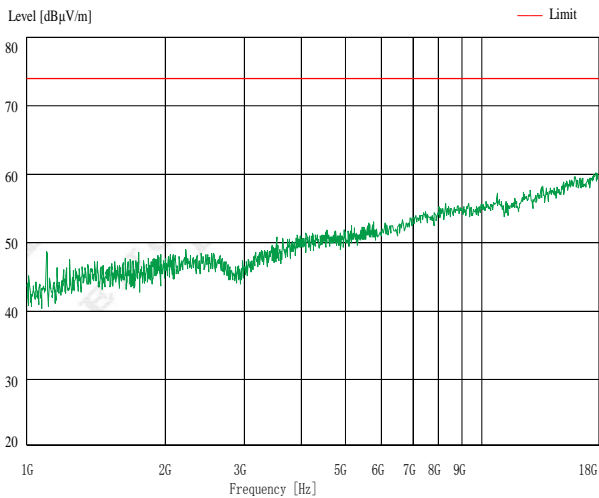

Antenna Horizontal

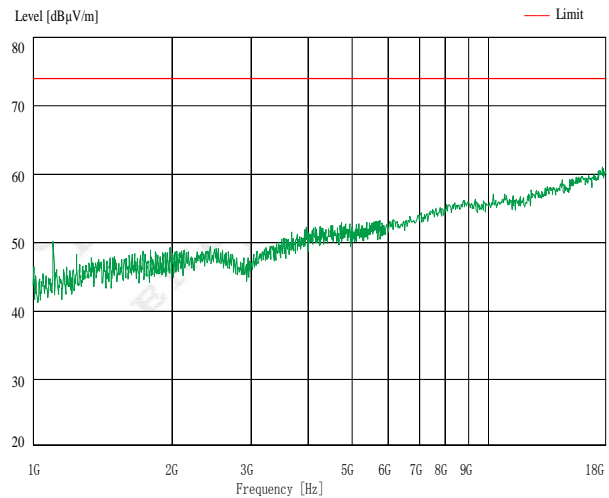

Antenna Vertical

The results shown in this test report refer only to the sample(s) tested unless otherwise stated and the sample(s) are retained for 30 days only. The document is issued by ENC, this document cannot be reproduced except in full with our prior written permission. The document is available on request and the brief information for its validation can be assessable and confirmed at <http://www.enc-lab.com>.





EUT:	Bluetooth Headset	Model Name :	Qnine
Temperature:	23 °C	Relative Humidity:	65 %
Pressure:	1012hPa	Test Voltage :	DC 3.7V
Test Mode:	TX 2441MHz – CH39-1Mbps		

Freq. (MHz)	Ant. H/V	Level (dBuV)	Corr.Factor(CF) (dB)	Measured(FS) (dBuV/m)	Limits(QP) (dBuV/m)	Margin (dB)	Note
5537.74	H	52.71	1.16	53.87	74.00	-20.13	Peak
6887.56	H	52.83	1.44	54.27	74.00	-19.73	Peak
7958.79	H	56.40	1.66	58.06	74.00	-15.94	Peak
8186.79	H	57.87	1.71	59.58	74.00	-14.42	Peak
5368.83	V	52.32	1.12	53.44	74.00	-20.56	Peak
6447.67	V	52.70	1.35	54.05	74.00	-19.95	Peak
7536.34	V	54.45	1.58	56.03	74.00	-17.97	Peak
8782.29	V	55.69	1.84	57.53	74.00	-16.47	Peak

Remark:

- (1) Factor = Antenna Factor + Cable Loss – Pre-amplifier.  
No emission detected above 18GHz

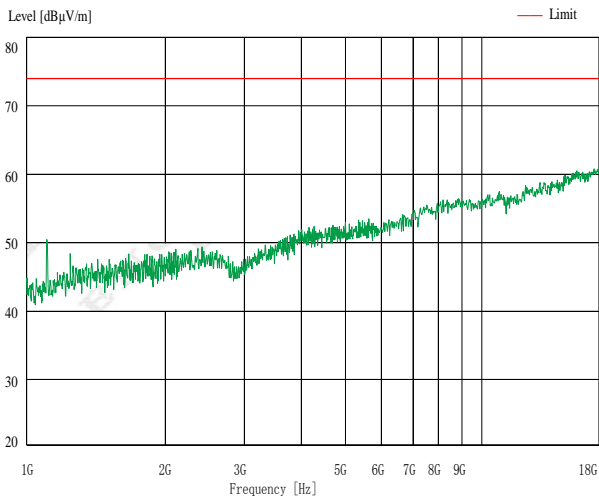

Antenna Horizontal

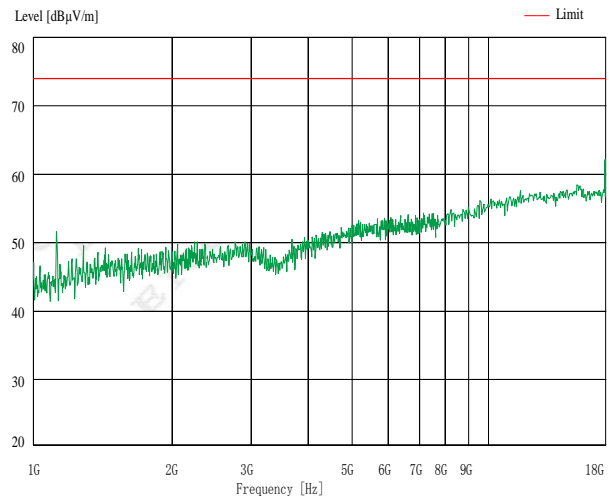

Antenna Vertical

The results shown in this test report refer only to the sample(s) tested unless otherwise stated and the sample(s) are retained for 30 days only. The document is issued by ENC, this document cannot be reproduced except in full with our prior written permission. The document is available on request and the brief information for its validation can be assessable and confirmed at <http://www.enc-lab.com>.



EUT:	Bluetooth Headset	Model Name :	Qnine
Temperature:	23 °C	Relative Humidity:	65 %
Pressure:	1012hPa	Test Voltage :	DC 3.7V
Test Mode:	TX 2480MHz – CH78-1Mbps		

Freq. (MHz)	Ant. H/V	Level (dBuV)	Corr.Factor(CF) (dB)	Measured(FS) (dBuV/m)	Limits(QP) (dBuV/m)	Margin (dB)	Note
5299.91	H	51.53	1.11	52.64	74.00	-21.36	Peak
6426.77	H	52.51	1.34	53.85	74.00	-20.15	Peak
7633.85	H	52.59	1.60	54.19	74.00	-19.81	Peak
8779.26	H	54.46	1.84	56.30	74.00	-17.70	Peak
5817.82	V	48.38	1.22	49.60	74.00	-24.40	Peak
6961.97	V	49.17	1.46	50.63	74.00	-23.37	Peak
7297.65	V	48.86	1.53	50.39	74.00	-23.61	Peak
8499.21	V	52.63	1.78	54.41	74.00	-19.59	Peak

Remark:

- (1) Factor = Antenna Factor + Cable Loss – Pre-amplifier.  
No emission detected above 18GHz

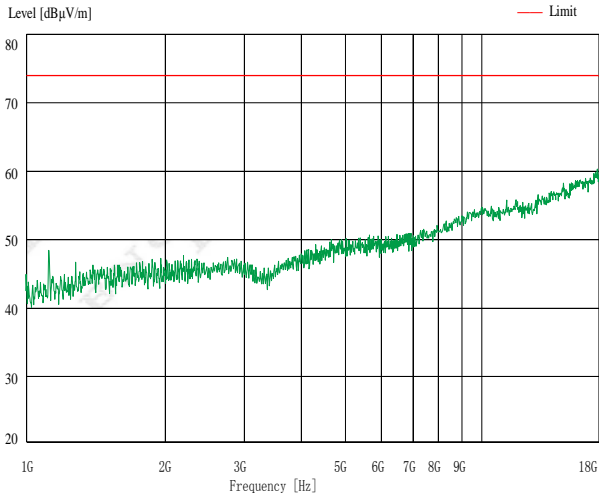

Antenna Horizontal

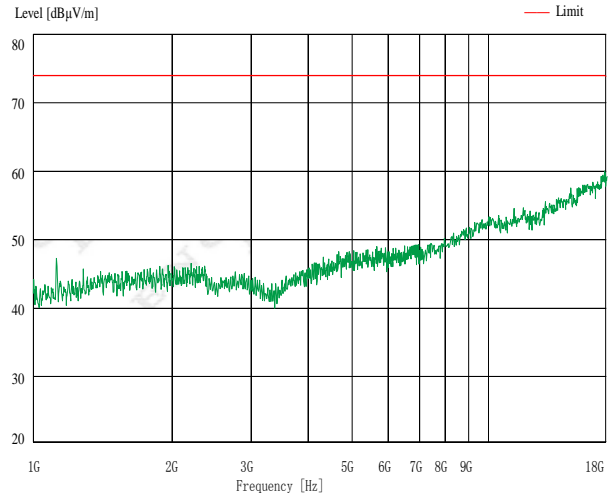

Antenna Vertical

The results shown in this test report refer only to the sample(s) tested unless otherwise stated and the sample(s) are retained for 30 days only. The document is issued by ENC, this document cannot be reproduced except in full with our prior written permission. The document is available on request and the brief information for its validation can be assessable and confirmed at <http://www.enc-lab.com>.



**4.2.9 BAND EDGE**

No.	Frequency	Ant.	Frequency	Result	Limit	Margin	Note
1 *	2390.00	H	CH00	43.51	74.00	-30.49	Peak
2	2400.00	H	CH00	74.06	74.00	0.06	Peak
3	2401.73	H	CH00	93.19	74.00	19.19	Peak

No.	Frequency	Ant.	Frequency	Result	Limit	Margin	Note
1 *	2390.00	V	CH00	44.80	74.00	-29.20	Peak
2	2400.00	V	CH00	78.86	74.00	4.86	Peak
3	2401.73	V	CH00	99.32	74.00	25.32	Peak

No.	Frequency	Ant.	Frequency	Result	Limit	Margin	Note
1 *	2390.00	H	CH00	35.02	54.00	-18.98	Avg
2	2400.00	H	CH00	65.83	54.00	11.83	Avg
3	2401.89	H	CH00	66.87	54.00	12.87	Avg

No.	Frequency	Ant.	Frequency	Result	Limit	Margin	Note
1 *	2390.00	V	CH00	31.63	54.00	-22.37	Avg
2	2400.00	V	CH00	69.08	54.00	15.08	Avg
3	2401.89	V	CH00	92.03	54.00	38.03	Avg

No.	Frequency	Ant.	Frequency	Result	Limit	Margin	Note
1	2479.96	H	CH78	93.67	74.00	19.67	Peak
2 *	2483.50	H	CH78	53.74	74.00	-20.26	Peak

No.	Frequency	Ant.	Frequency	Result	Limit	Margin	Note
1	2479.96	V	CH78	99.72	74.00	25.72	Peak
2 *	2483.50	V	CH78	59.64	74.00	-14.36	Peak

No.	Frequency	Ant.	Frequency	Result	Limit	Margin	Note
1	2479.96	H	CH78	89.32	54.00	35.32	Avg
2 *	2483.50	H	CH78	44.36	54.00	-9.64	Avg

No.	Frequency	Ant.	Frequency	Result	Limit	Margin	Note
1	2479.88	V	CH78	93.48	54.00	39.48	Avg
2 *	2483.50	V	CH78	50.09	54.00	-3.91	Avg

Refer to the attached plots.

The results shown in this test report refer only to the sample(s) tested unless otherwise stated and the sample(s) are retained for 30 days only. The document is issued by ENC, this document cannot be reproduced except in full with our prior written permission. The document is available on request and the brief information for its validation can be assessable and confirmed at <http://www.enc-lab.com>.



### CH00 (Lower) -1Mbps

Horizontal:

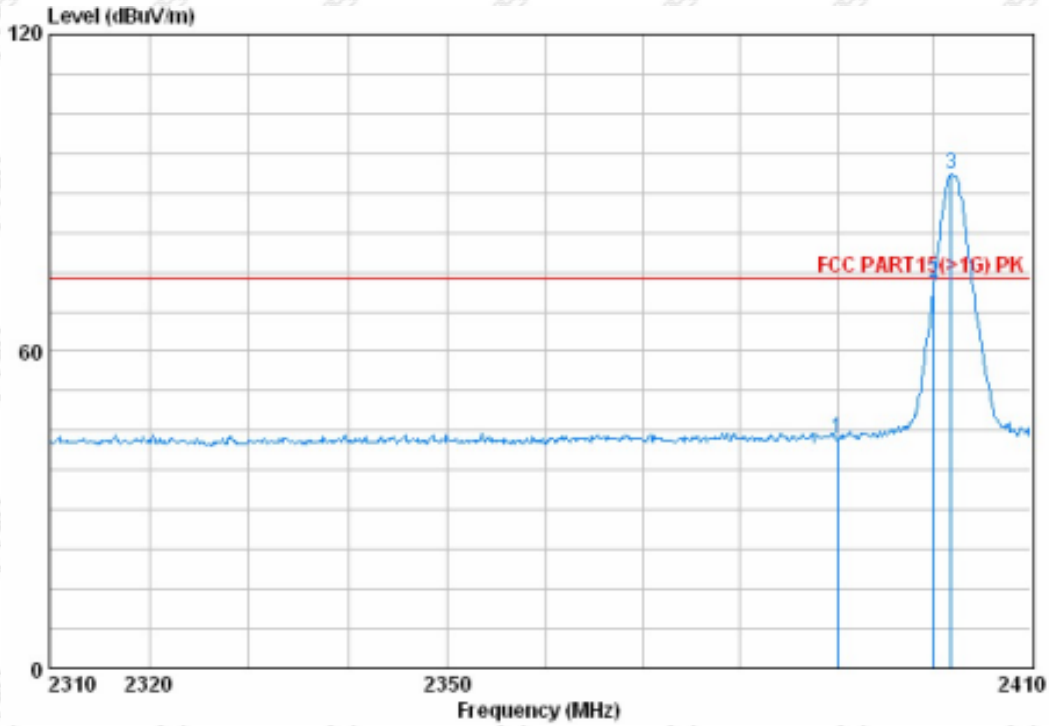

Vertical:

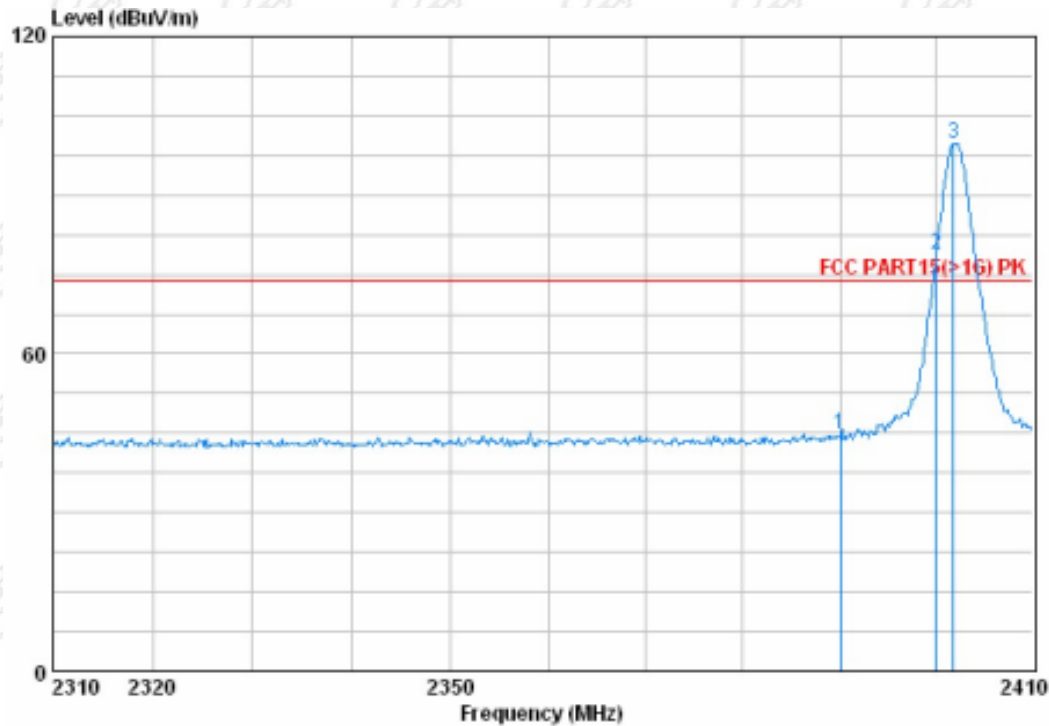

The results shown in this test report refer only to the sample(s) tested unless otherwise stated and the sample(s) are retained for 30 days only. The document is issued by ENC, this document cannot be reproduced except in full with our prior written permission. The document is available on request and the brief information for its validation can be assessable and confirmed at <http://www.enc-lab.com>.



### CH00 (Lower) -1Mbps

Horizontal:

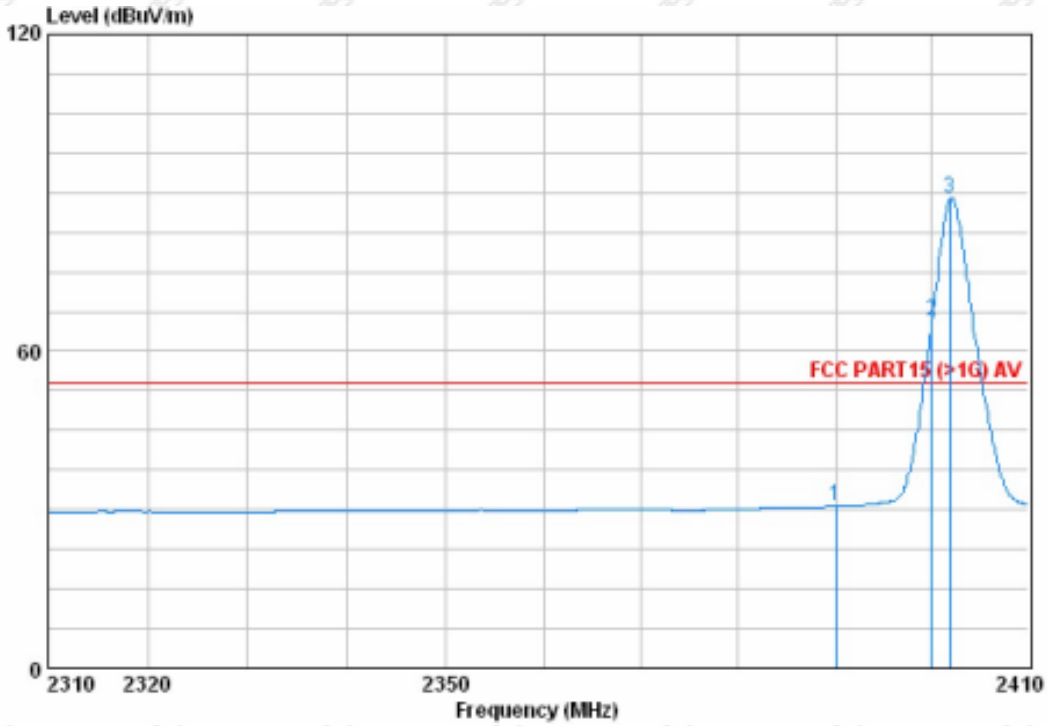

Vertical:

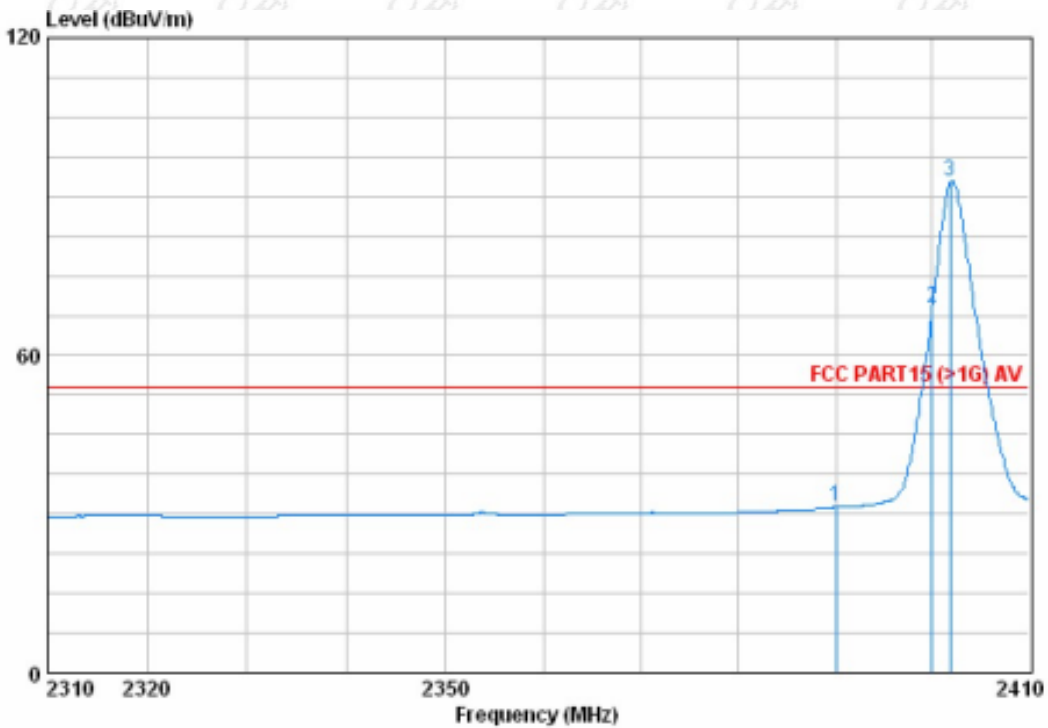

The results shown in this test report refer only to the sample(s) tested unless otherwise stated and the sample(s) are retained for 30 days only. The document is issued by ENC, this document cannot be reproduced except in full with our prior written permission. The document is available on request and the brief information for its validation can be assessable and confirmed at <http://www.enc-lab.com>.

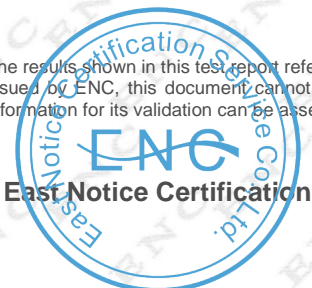

### CH 78 (Upper) -1Mbps

Horizontal:

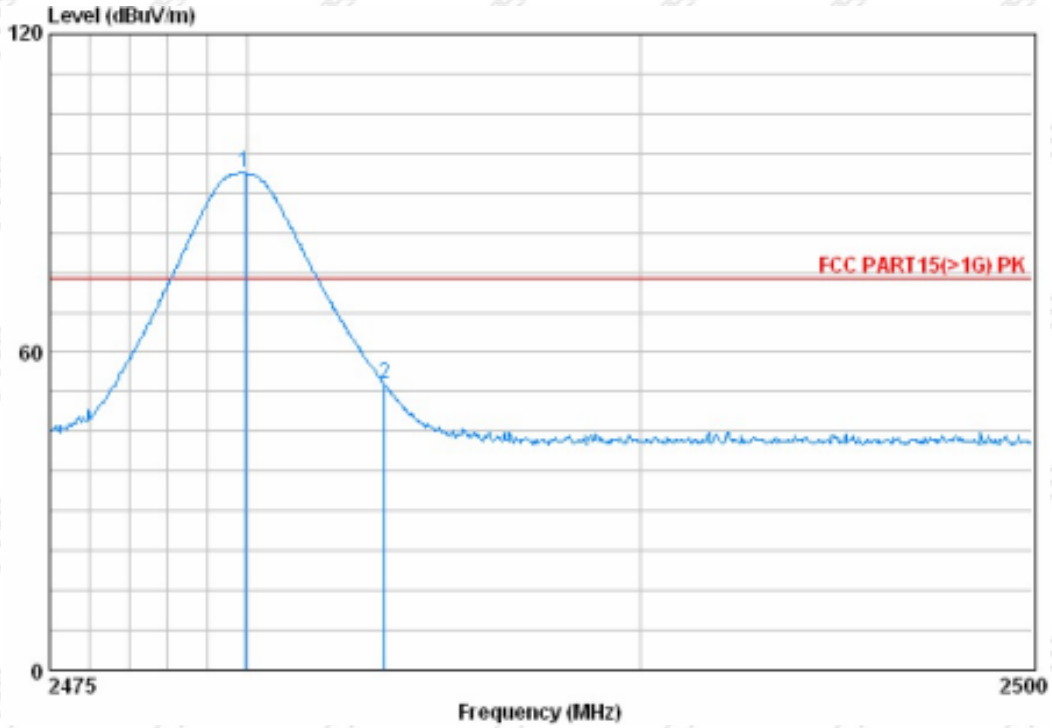

Vertical:

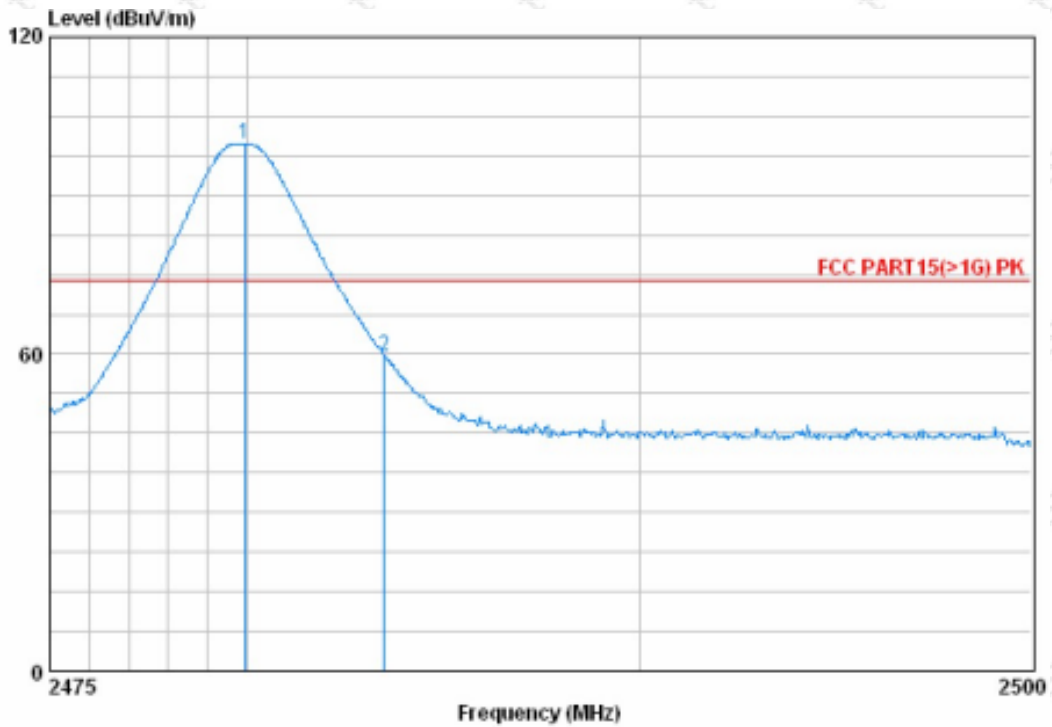

The results shown in this test report refer only to the sample(s) tested unless otherwise stated and the sample(s) are retained for 30 days only. The document is issued by ENC, this document cannot be reproduced except in full with our prior written permission. The document is available on request and the brief information for its validation can be assessable and confirmed at <http://www.enc-lab.com>.



### CH 78 (Upper) -1Mbps

Horizontal:

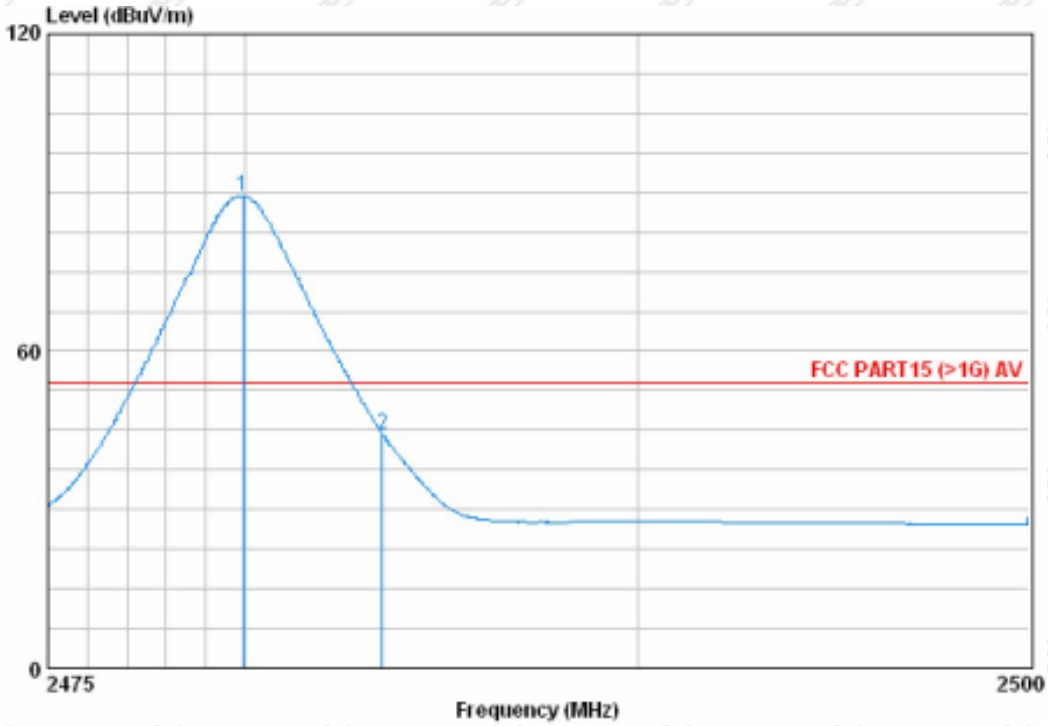

Vertical:

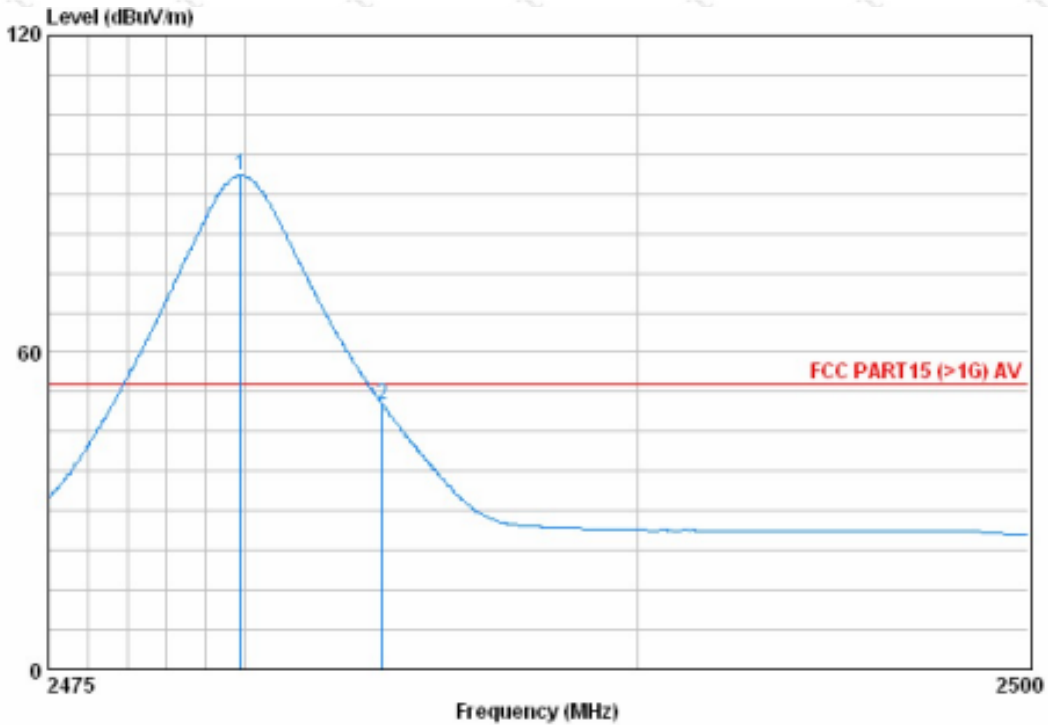

The results shown in this test report refer only to the sample(s) tested unless otherwise stated and the sample(s) are retained for 30 days only. The document is issued by ENC, this document cannot be reproduced except in full with our prior written permission. The document is available on request and the brief information for its validation can be assessable and confirmed at <http://www.enc-lab.com>.



## 5. NUMBER OF HOPPING CHANNEL

### 5.1 APPLIED PROCEDURES / LIMIT

FCC Part15 (15.247) , Subpart C			
Section	Test Item	Frequency Range (MHz)	Result
15.247 (a)(1)(iii)	Number of Hopping Channel	2400-2483.5	PASS

### 5.1.1 MEASUREMENT INSTRUMENTS LIST AND SETTING

Item	Kind of Equipment	Manufacturer	Type No.	Serial No.	Calibrated until
1	Spectrum Analyzer	R&S	FSP 40	100185	05/28/2012

Remark: " N/A" denotes No Model Name , Serial No. or No Calibration specified.

Spectrum Parameters	Setting
Attenuation	Auto
Span Frequency	> Operating Frequency Range
RB	100 kHz
VB	100 kHz
Detector	Peak
Trace	Max Hold
Sweep Time	Auto

### 5.1.2 TEST PROCEDURE

- The EUT was directly connected to the spectrum analyzer and antenna output port as show in the block diagram below,
- Spectrum Setting : RBW= 100KHz, VBW=100KHz, Sweep time = Auto.

### 5.1.3 DEVIATION FROM STANDARD

No deviation.

### 5.1.4 TEST SETUP

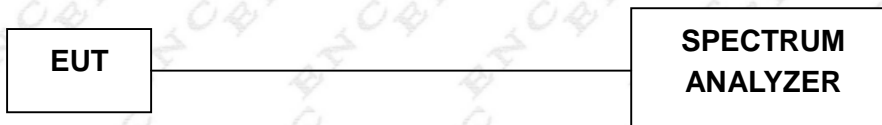

### 5.1.5 EUT OPERATION CONDITIONS

The EUT tested system was configured as the statements of 4.1.6 Unless otherwise a special operating condition is specified in the follows during the testing.

The results shown in this test report refer only to the sample(s) tested unless otherwise stated and the sample(s) are retained for 30 days only. The document is issued by ENC, this document cannot be reproduced except in full with our prior written permission. The document is available on request and the brief information for its validation can be assessable and confirmed at <http://www.enc-lab.com>.



### 5.1.6 TEST RESULTS

EUT:	Bluetooth Headset	Model Name :	Qnine
Temperature:	23 °C	Relative Humidity:	65 %
Pressure:	1015hPa	Test Voltage :	DC 3.7V
Test Mode:	Hopping Mode -1Mbps		
Number of Hopping Channel		79	

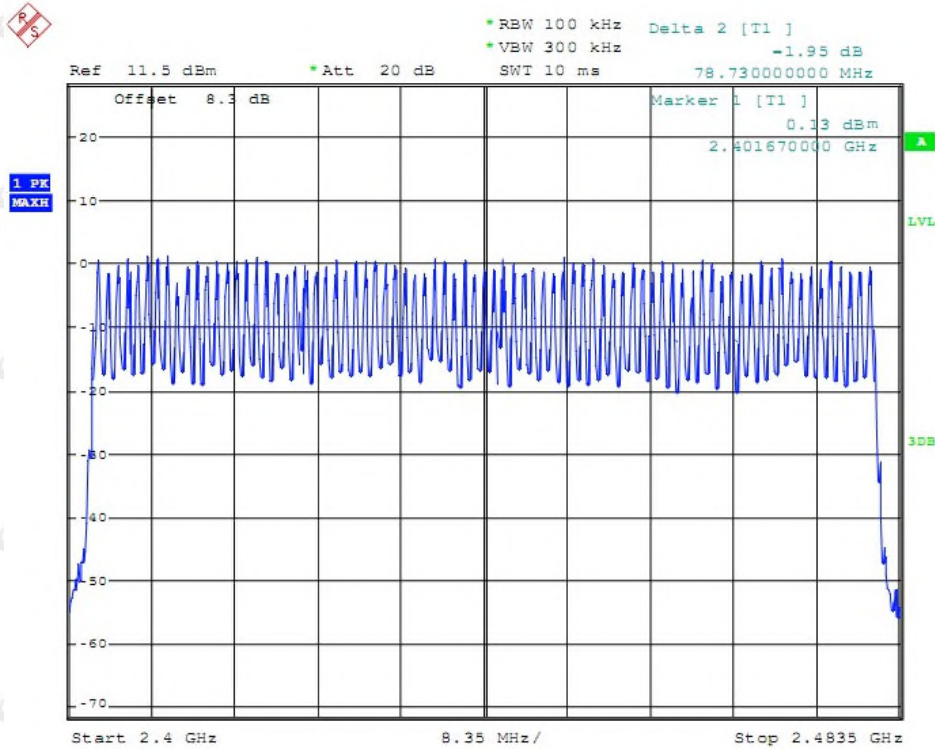

The results shown in this test report refer only to the sample(s) tested unless otherwise stated and the sample(s) are retained for 30 days only. The document is issued by ENC, this document cannot be reproduced except in full with our prior written permission. The document is available on request and the brief information for its validation can be assessable and confirmed at <http://www.enc-lab.com>.



## 6. AVERAGE TIME OF OCCUPANCY

### 6.1 APPLIED PROCEDURES / LIMIT

FCC Part15 (15.247) , Subpart C				
Section	Test Item	Limit	Frequency Range (MHz)	Result
15.247 (a)(1)(iii)	Average Time of Occupancy	0.4sec	2400-2483.5	PASS

### 6.1.1 MEASUREMENT INSTRUMENTS LIST

Item	Kind of Equipment	Manufacturer	Type No.	Serial No.	Calibrated until
1	Spectrum Analyzer	R&S	FSP 40	100185	05/28/2012

Remark: " N/A" denotes No Model Name , Serial No. or No Calibration specified.

### 6.1.2 TEST PROCEDURE

- The transmitter output (antenna port) was connected to the spectrum analyzer
- Set RBW of spectrum analyzer to 1MHz and VBW to 1MHz.
- Use a video trigger with the trigger level set to enable triggering only on full pulses.
- Sweep Time is more than once pulse time.
- Set the center frequency on any frequency would be measure and set the frequency span to zero span.
- Measure the maximum time duration of one single pulse.
- Set the EUT for DH5, DH3 and DH1 packet transmitting.
- Measure the maximum time duration of one single pulse.
- DH5 Packet permit maximum  $1600 / 79 / 6 = 3.37$  hops per second in each channel (5 time slots RX, 1 time slot TX). So, the dwell time is the time duration of the pulse times  $3.37 \times 31.6 = 106.6$  within 31.6 seconds.
- DH3 Packet permit maximum  $1600 / 79 / 4 = 5.06$  hops per second in each channel (3 time slots RX, 1 time slot TX). So, the dwell time is the time duration of the pulse times  $5.06 \times 31.6 = 160$  within 31.6 seconds.
- DH1 Packet permit maximum  $1600 / 79 / 2 = 10.12$  hops per second in each channel (1 time slot RX, 1 time slot TX). So, the dwell time is the time duration of the pulse times  $10.12 \times 31.6 = 320$  within 31.6 seconds.

### 6.1.3 DEVIATION FROM STANDARD

No deviation.

The results shown in this test report refer only to the sample(s) tested unless otherwise stated and the sample(s) are retained for 30 days only. The document is issued by ENC, this document cannot be reproduced except in full with our prior written permission. The document is available on request and the brief information for its validation can be assessable and confirmed at <http://www.enc-lab.com>.



#### 6.1.4 TEST SETUP

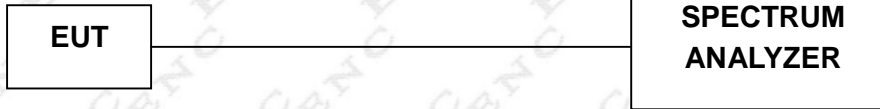

#### 6.1.5 EUT OPERATION CONDITIONS

The EUT tested system was configured as the statements of 4.1.6 Unless otherwise a special operating condition is specified in the follows during the testing.

The results shown in this test report refer only to the sample(s) tested unless otherwise stated and the sample(s) are retained for 30 days only. The document is issued by ENC, this document cannot be reproduced except in full with our prior written permission. The document is available on request and the brief information for its validation can be assessable and confirmed at <http://www.enc-lab.com>.



### 6.1.6 TEST RESULTS

EUT:	Bluetooth Headset	Model Name :	I4S
Temperature:	23 °C	Relative Humidity:	65 %
Pressure:	1012hPa	Test Voltage :	DC 3.7V
Test Mode:	CH00H1/DH3/DH5 -1Mbps		

Data Packet	Frequency	Pulse Duration (ms)	Dwell Time (s)	Limits (s)
DH5	2402MHz	2.915	0.3731	0.4000
DH3	2402MHz	1.670	0.3563	0.4000
DH1	2402MHz	0.410	0.2624	0.4000

#### CH00-DH1

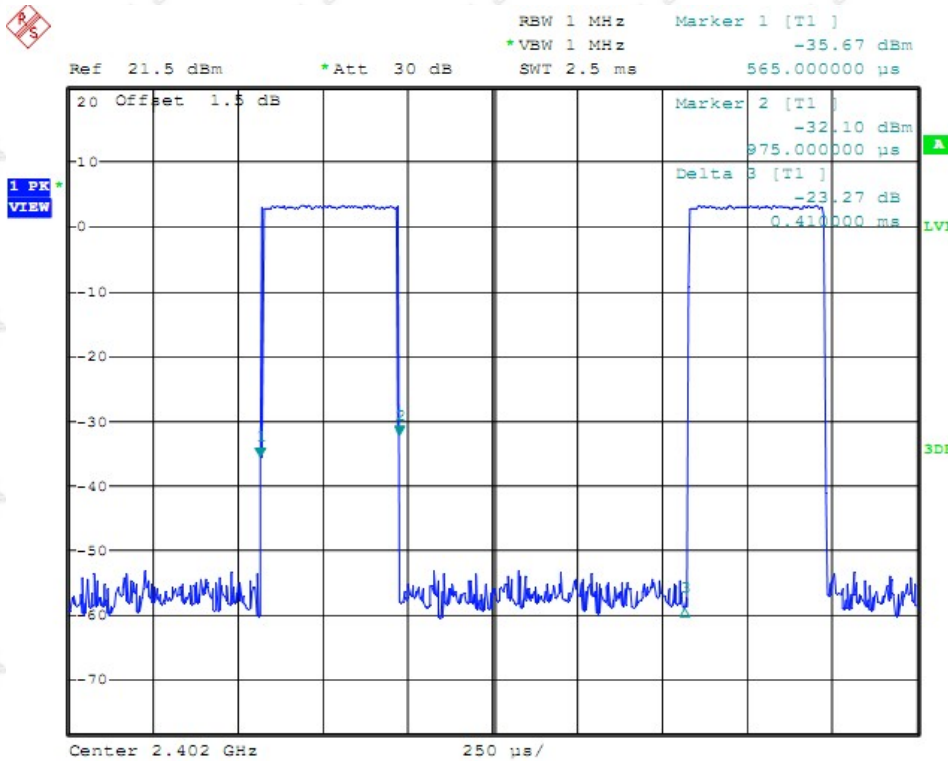

The results shown in this test report refer only to the sample(s) tested unless otherwise stated and the sample(s) are retained for 30 days only. The document is issued by ENC, this document cannot be reproduced except in full with our prior written permission. The document is available on request and the brief information for its validation can be assessable and confirmed at <http://www.enc-lab.com>.



### CH00-DH3

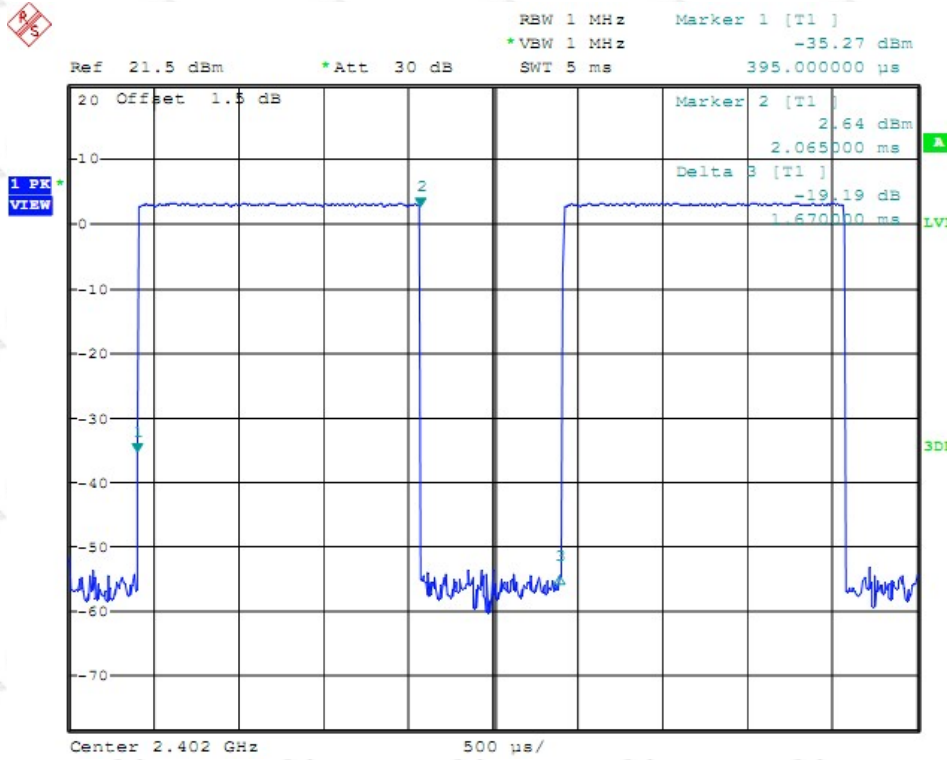

### CH00-DH5

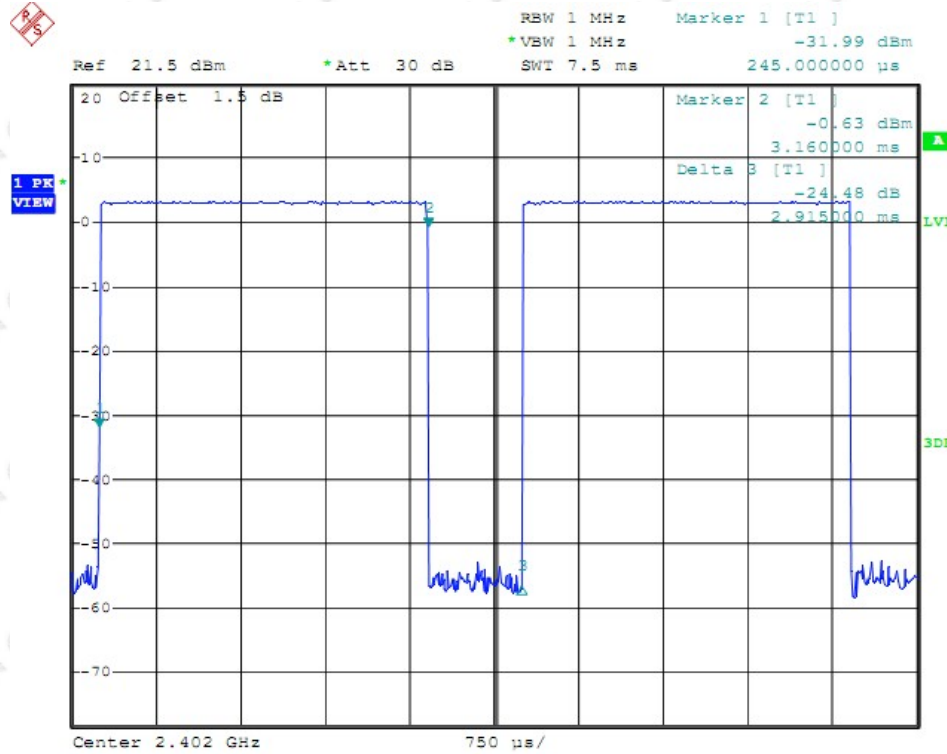

The results shown in this test report refer only to the sample(s) tested unless otherwise stated and the sample(s) are retained for 30 days only. The document is issued by ENC, this document cannot be reproduced except in full with our prior written permission. The document is available on request and the brief information for its validation can be assessable and confirmed at <http://www.enc-lab.com>.

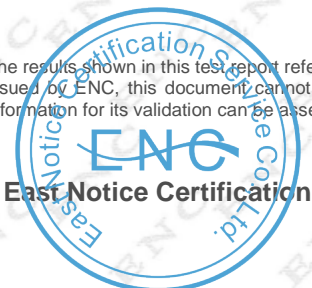

EUT:	Bluetooth Headset	Model Name :	I4S
Temperature:	23 °C	Relative Humidity:	65 %
Pressure:	1012hPa	Test Voltage :	DC 3.7V
Test Mode:	CH39H1/DH3/DH5 -1Mbps		

Data Packet	Frequency	Pulse Duration (ms)	Dwell Time (s)	Limits (s)
DH5	2441MHz	2.945	0.3770	0.4000
DH3	2441MHz	1.680	0.3584	0.4000
DH1	2441MHz	0.425	0.2720	0.4000

### CH39-DH1

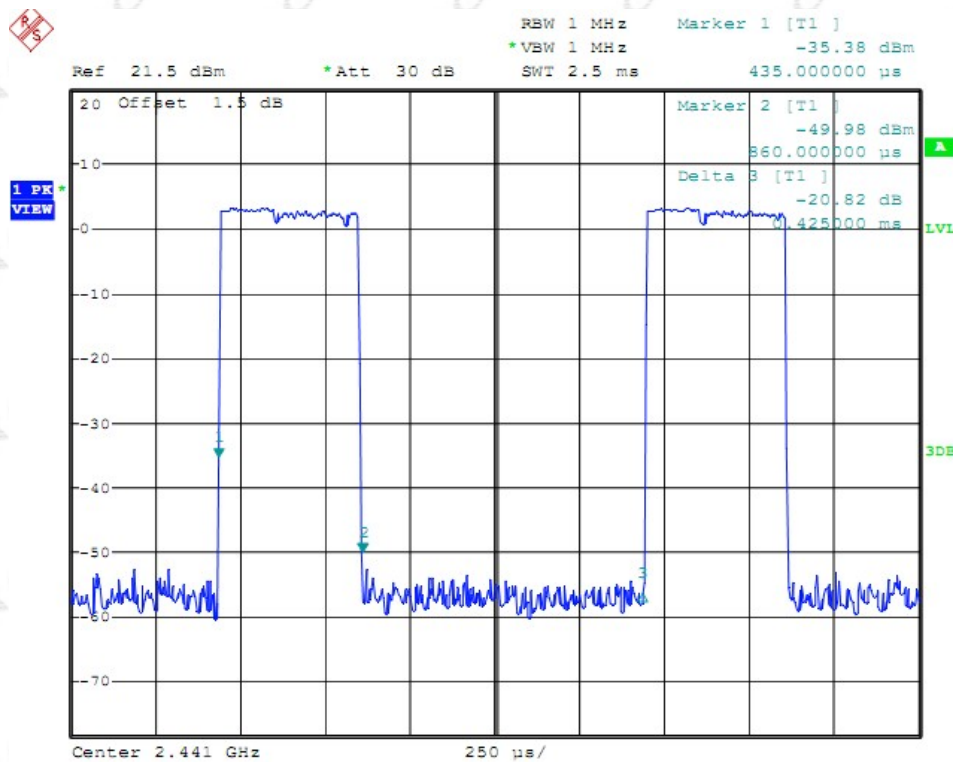

The results shown in this test report refer only to the sample(s) tested unless otherwise stated and the sample(s) are retained for 30 days only. The document is issued by ENC, this document cannot be reproduced except in full with our prior written permission. The document is available on request and the brief information for its validation can be assessable and confirmed at <http://www.enc-lab.com>.



### CH39-DH3

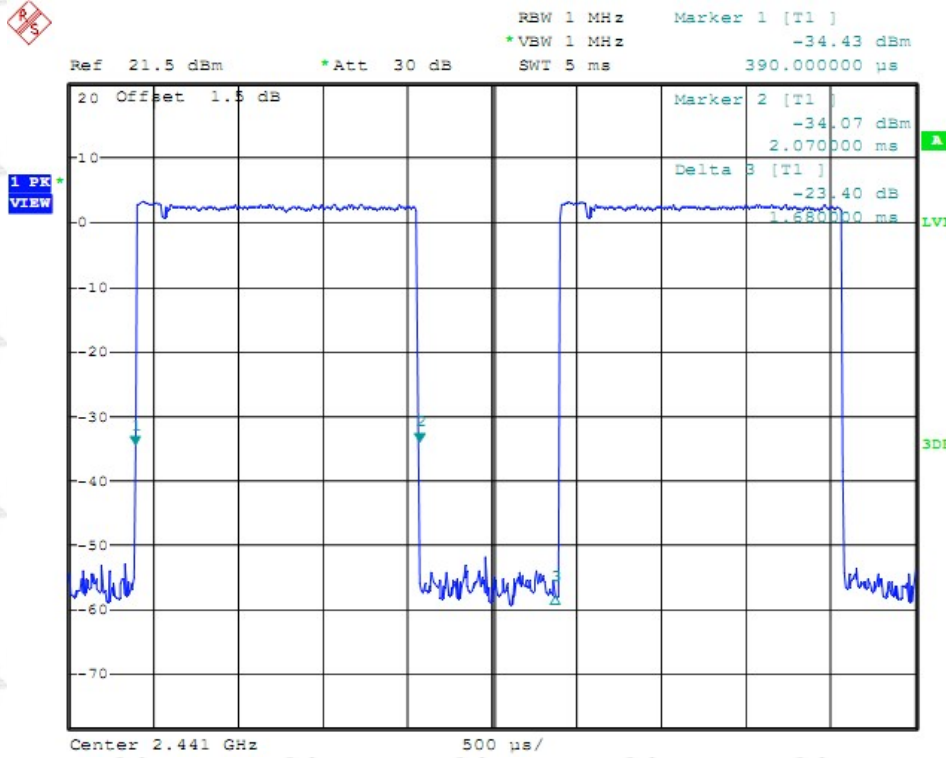

### CH39-DH5

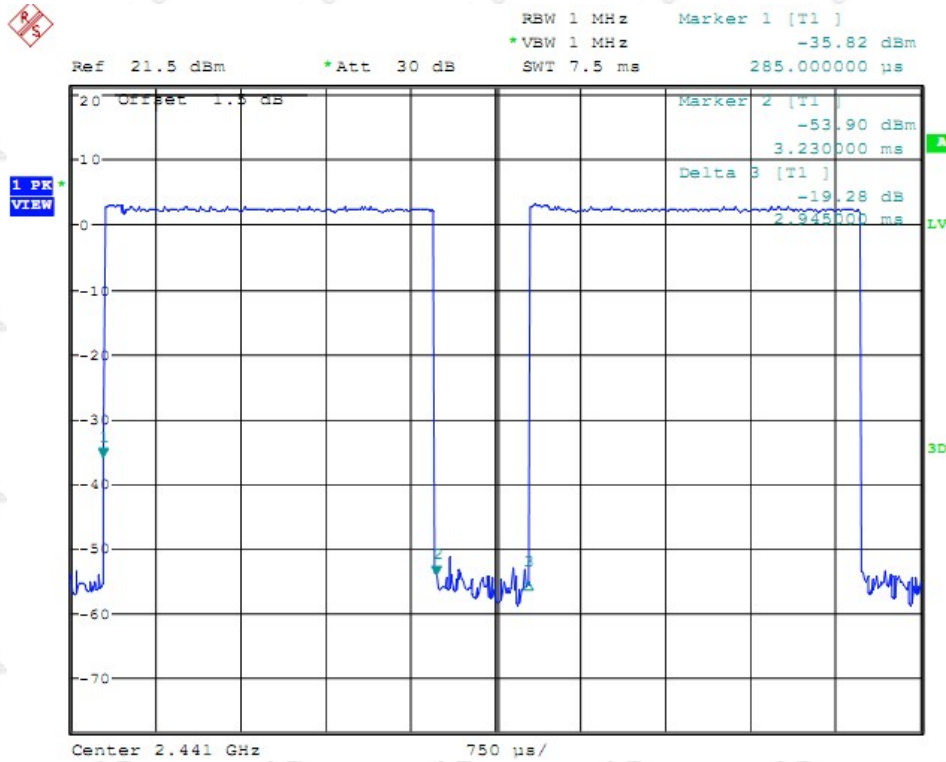

The results shown in this test report refer only to the sample(s) tested unless otherwise stated and the sample(s) are retained for 30 days only. The document is issued by ENC, this document cannot be reproduced except in full with our prior written permission. The document is available on request and the brief information for its validation can be assessable and confirmed at <http://www.enc-lab.com>.



EUT:	Bluetooth Headset	Model Name :	I4S
Temperature:	23 °C	Relative Humidity:	65 %
Pressure:	1012hPa	Test Voltage :	DC 3.7V
Test Mode:	CH78H1/DH3/DH5 -1Mbps		

Data Packet	Frequency	Pulse Duration (ms)	Dwell Time (s)	Limits (s)
DH5	2480MHz	2.915	0.3731	0.4000
DH3	2480MHz	1.685	0.3595	0.4000
DH1	2480MHz	0.425	0.2720	0.4000

### CH78-DH1

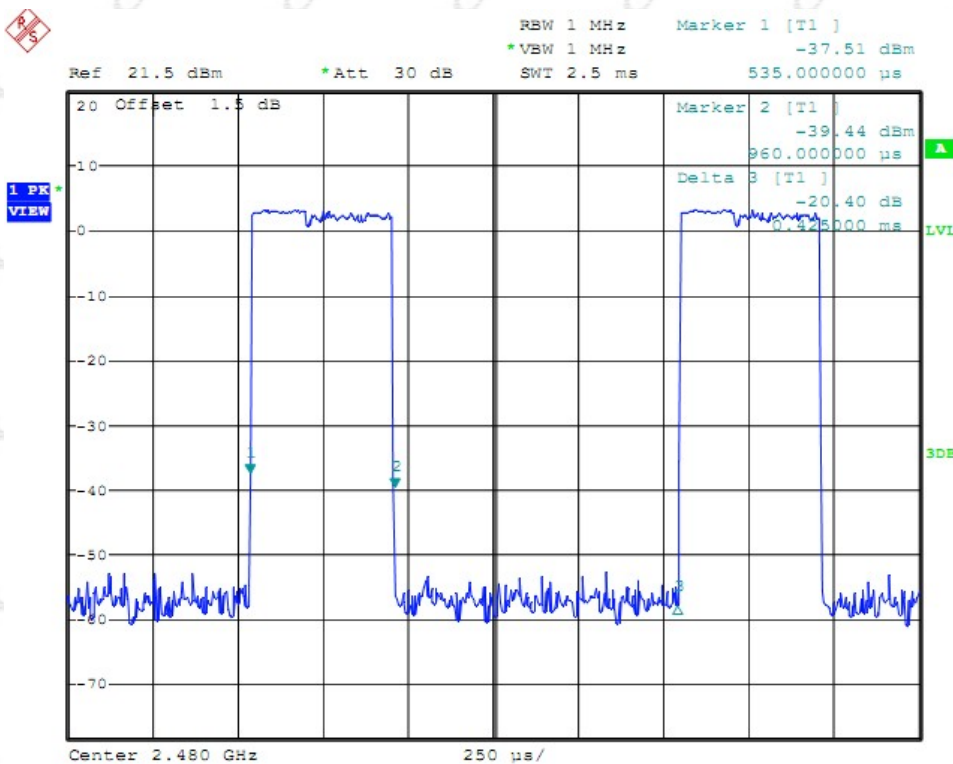

The results shown in this test report refer only to the sample(s) tested unless otherwise stated and the sample(s) are retained for 30 days only. The document is issued by ENC, this document cannot be reproduced except in full with our prior written permission. The document is available on request and the brief information for its validation can be assessable and confirmed at <http://www.enc-lab.com>.





### CH78-DH3

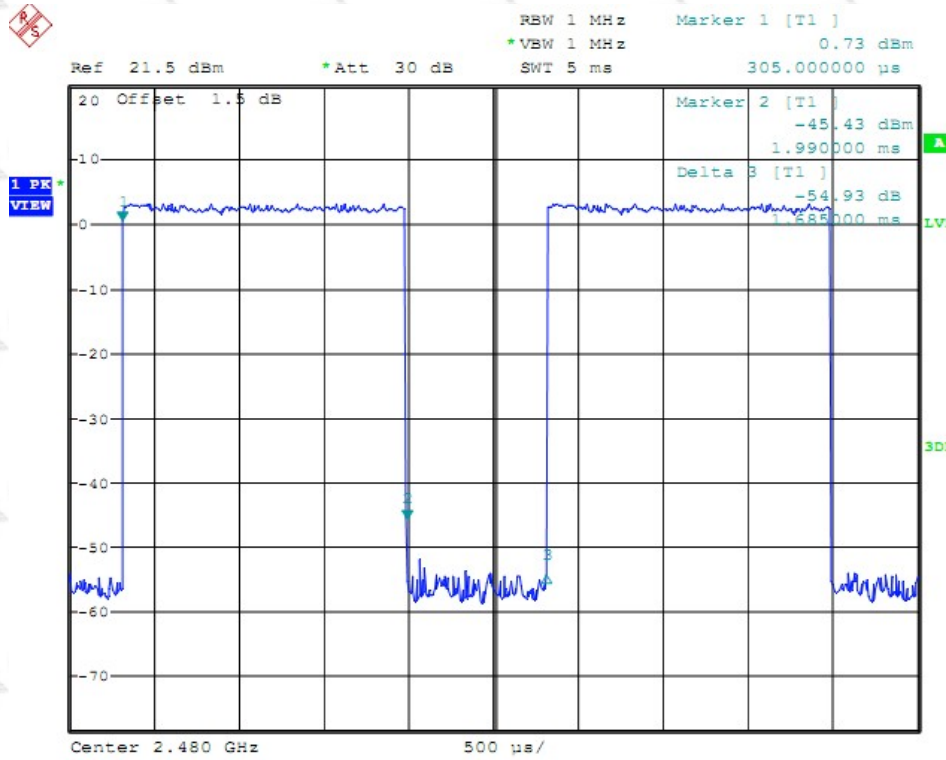

### CH78-DH5

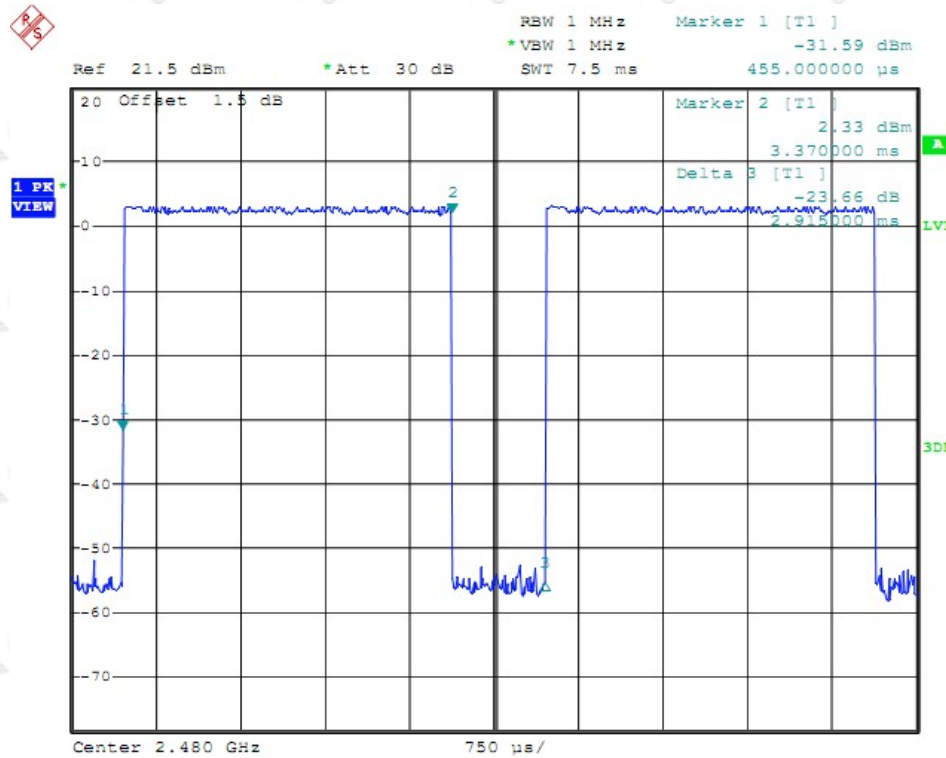

The results shown in this test report refer only to the sample(s) tested unless otherwise stated and the sample(s) are retained for 30 days only. The document is issued by ENC, this document cannot be reproduced except in full with our prior written permission. The document is available on request and the brief information for its validation can be assessable and confirmed at <http://www.enc-lab.com>.



## 7. HOPPING CHANNEL SEPARATION MEASUREMENT

### 7.1 APPLIED PROCEDURES / LIMIT

Frequency hopping systems operating in the 2400-2483.5 MHz band may have hopping channel carrier frequencies that are separated by 25 kHz or two-thirds of the 20 dB bandwidth of the hopping channel, whichever is greater.

#### 7.1.1 MEASUREMENT INSTRUMENTS LIST AND SETTING

Item	Kind of Equipment	Manufacturer	Type No.	Serial No.	Calibrated until
1	Spectrum Analyzer	R&S	FSP 40	100185	05/28/2012

Remark: " N/A" denotes No Model Name , Serial No. or No Calibration specified.

Spectrum Parameter	Setting
Attenuation	Auto
Span Frequency	> Measurement Bandwidth or Channel Separation
RB	30 kHz (20dB Bandwidth) / 100 kHz (Channel Separation)
VB	100 kHz (20dB Bandwidth) / 300 kHz (Channel Separation)
Detector Peak Trace	Max Hold
Sweep Time	Auto

#### 7.1.2 TEST PROCEDURE

- The transmitter output (antenna port) was connected to the spectrum analyser in peak hold mode.
- The resolution bandwidth of 30 kHz and the video bandwidth of 100 kHz were utilised for 20 dB bandwidth measurement.
- The resolution bandwidth of 100 kHz and the video bandwidth of 300 kHz were utilised for channel separation measurement.

#### 7.1.3 DEVIATION FROM STANDARD

No deviation.

#### 7.1.4 TEST SETUP

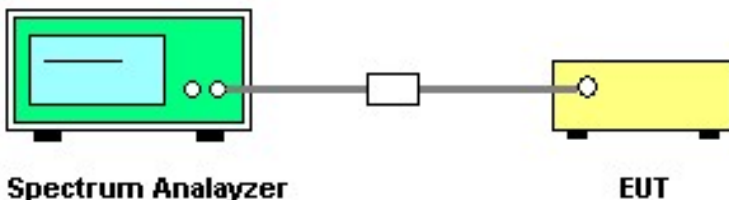

#### 7.1.5 EUT OPERATION CONDITIONS

The EUT was programmed to be in continuously transmitting mode.

The results shown in this test report refer only to the sample(s) tested unless otherwise stated and the sample(s) are retained for 30 days only. The document is issued by ENC, this document cannot be reproduced except in full with our prior written permission. The document is available on request and the brief information for its validation can be assessable and confirmed at <http://www.enc-lab.com>.

### 7.1.6 TEST RESULTS

EUT:	Bluetooth Headset	Model Name :	Qnine
Temperature:	23 °C	Relative Humidity:	65 %
Pressure:	1012hPa	Test Voltage :	DC 3.7V
Test Mode:	CH00 / CH39 /CH78-1Mbps		

Frequency	Ch. Separation (kHz)	20d Bandwidth B (kHz)	Result
2402MHz	1000.00	786.92	Complies
2441MHz	1000.00	786.93	Complies
2480MHz	1000.00	786.93	Complies

**Ch. Separation Limits: >20dB bandwidth or >2/3 of 20dB bandwidth**

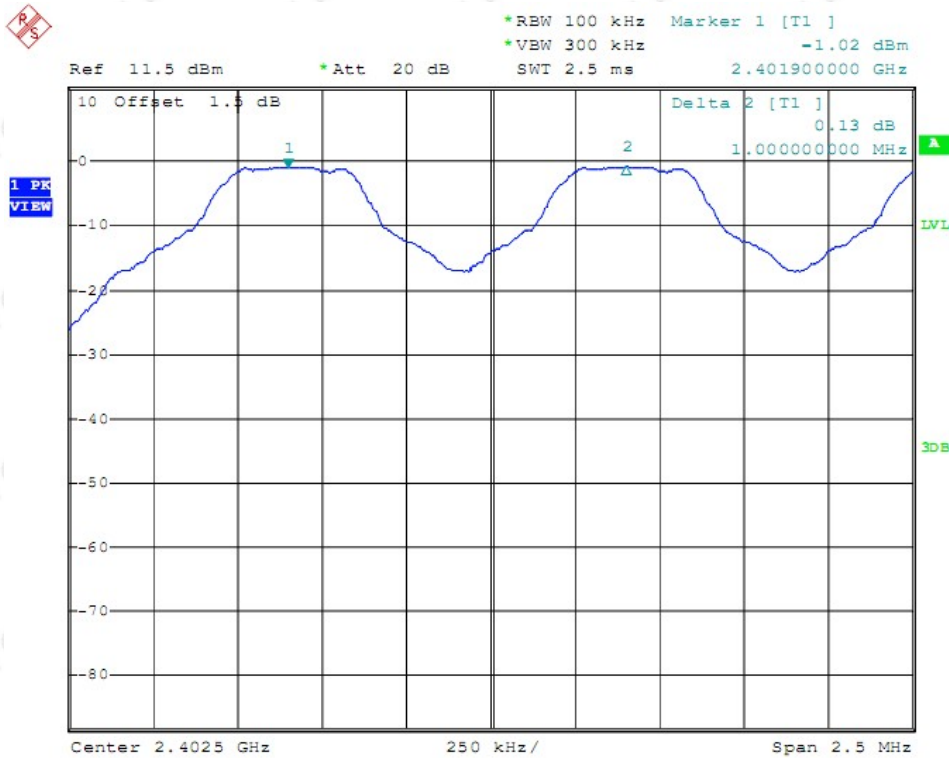

The results shown in this test report refer only to the sample(s) tested unless otherwise stated and the sample(s) are retained for 30 days only. The document is issued by ENC, this document cannot be reproduced except in full with our prior written permission. The document is available on request and the brief information for its validation can be assessable and confirmed at <http://www.enc-lab.com>.



### CH39 -1Mbps

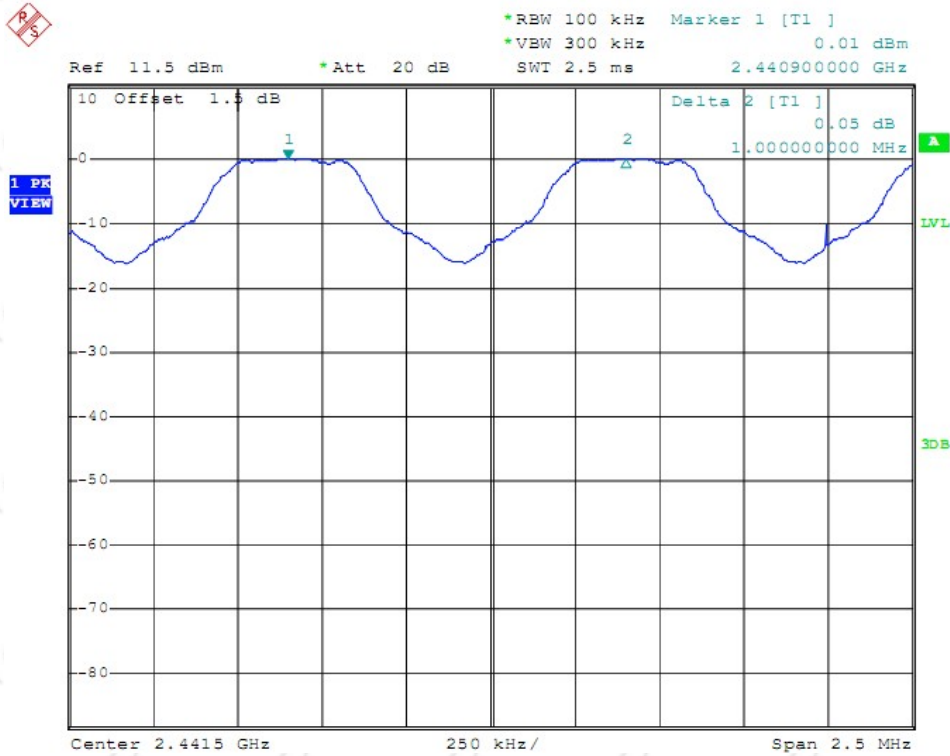

### CH78 -1Mbps

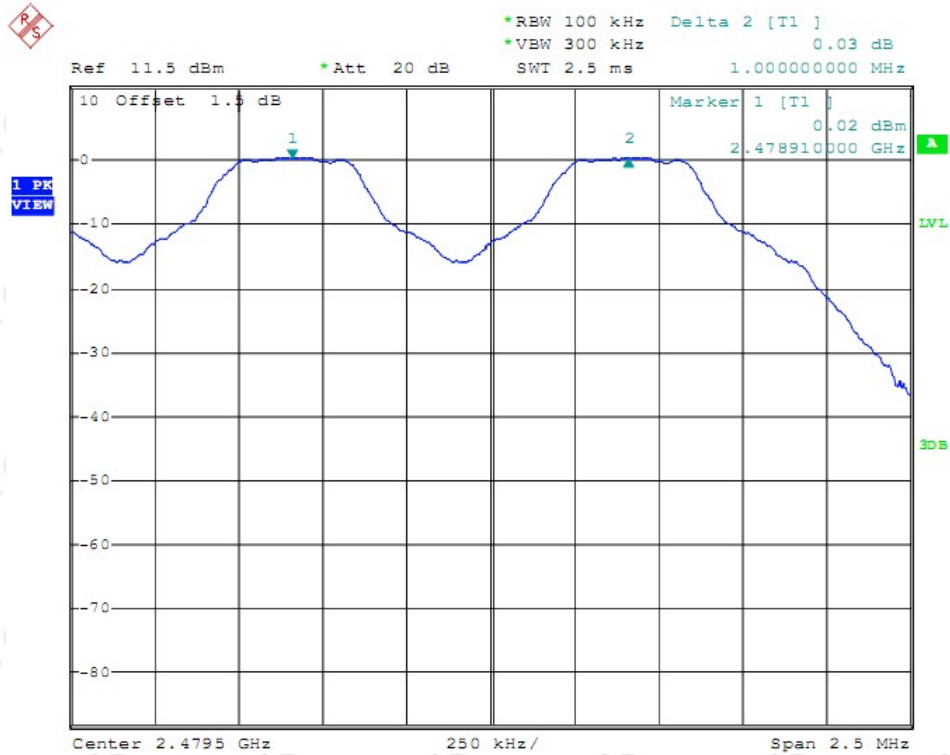

The results shown in this test report refer only to the sample(s) tested unless otherwise stated and the sample(s) are retained for 30 days only. The document is issued by ENC, this document cannot be reproduced except in full with our prior written permission. The document is available on request and the brief information for its validation can be assessable and confirmed at <http://www.enc-lab.com>.



## 8. BANDWIDTH TEST

### 8.1 APPLIED PROCEDURES / LIMIT

FCC Part15 (15.247) , Subpart C				
Section	Test Item	Limit	Frequency Range (MHz)	Result
15.247 (a)(2)	Bandwidth	$\leq 1$ MHz (20dB bandwidth)	2400-2483.5	PASS

### 8.1.1 MEASUREMENT INSTRUMENTS LIST AND SETTING

Item	Kind of Equipment	Manufacturer	Type No.	Serial No.	Calibrated until
1	Spectrum Analyzer	R&S	FSP 40	100185	05/28/2012

Remark: " N/A" denotes No Model Name , Serial No. or No Calibration specified.

Spectrum Parameters	Setting
Attenuation	Auto
Span Frequency	$>$ Measurement Bandwidth or Channel Separation
RB	30 kHz (20dB Bandwidth) / 100 kHz (Channel Separation)
VB	100 kHz (20dB Bandwidth) / 300 kHz (Channel Separation)
Detector	Peak
Trace	Max Hold
Sweep Time	Auto

### 8.1.2 TEST PROCEDURE

- The EUT was directly connected to the spectrum analyzer and antenna output port as show in the block diagram below,
- Spectrum Setting: RBW= 10KHz, VBW=100KHz, Sweep time = Auto.

### 8.1.3 DEVIATION FROM STANDARD

No deviation.

### 8.1.4 TEST SETUP

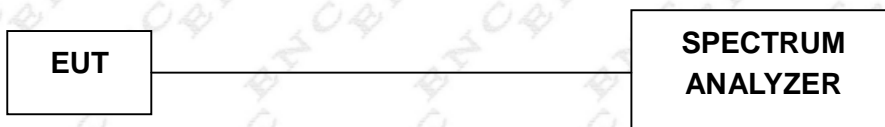

### 8.1.5 EUT OPERATION CONDITIONS

The EUT tested system was configured as the statements of 4.1.6 Unless otherwise a special operating condition is specified in the follows during the testing.

The results shown in this test report refer only to the sample(s) tested unless otherwise stated and the sample(s) are retained for 30 days only. The document is issued by ENC, this document cannot be reproduced except in full with our prior written permission. The document is available on request and the brief information for its validation can be assessable and confirmed at <http://www.enc-lab.com>.

### 8.1.6 TEST RESULTS

EUT:	Bluetooth Headset	Model Name :	Qnine
Temperature:	23 °C	Relative Humidity:	65 %
Pressure:	1012hPa	Test Voltage :	DC 3.7V
Test Mode:	CH00 / CH39 /CH78-1Mbps		

Frequency	20dB Bandwidth (KHz)	Channel Separation (MHz)	Result
2402MHz	1180.38	≤ 1MHz	<b>PASS</b>
2441MHz	1180.39	≤ 1MHz	<b>PASS</b>
2480MHz	1180.39	≤ 1MHz	<b>PASS</b>

**Ch. Separation Limits: >20dB bandwidth or >2/3 of 20dB bandwidth**

#### CH00 -1Mbps

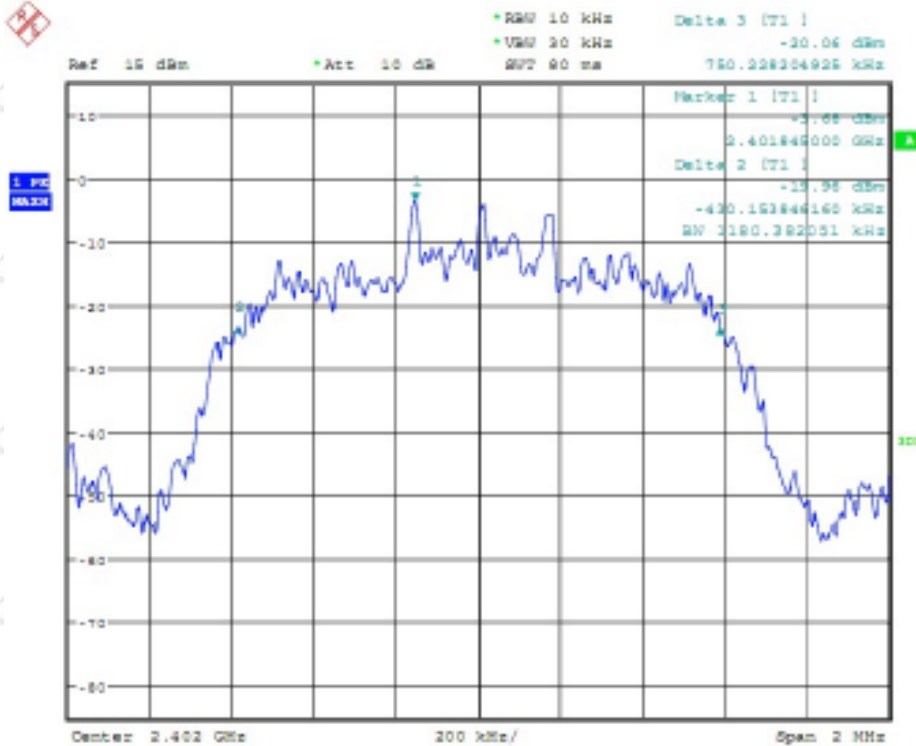

The results shown in this test report refer only to the sample(s) tested unless otherwise stated and the sample(s) are retained for 30 days only. The document is issued by ENC, this document cannot be reproduced except in full with our prior written permission. The document is available on request and the brief information for its validation can be assessable and confirmed at <http://www.enc-lab.com>.



### CH39 -1Mbps

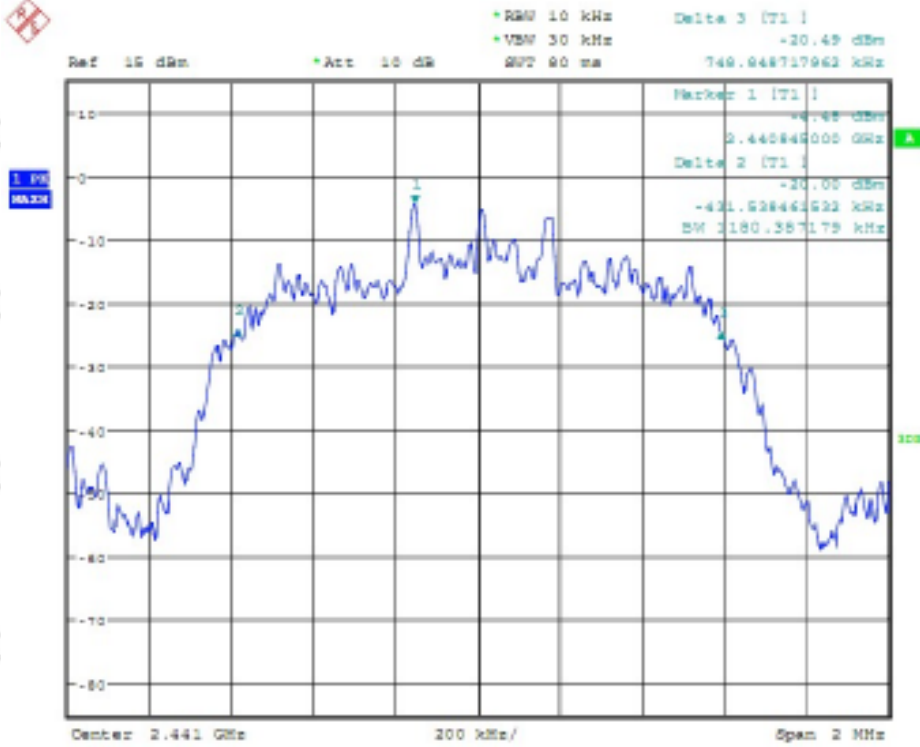

### CH78 -1Mbps

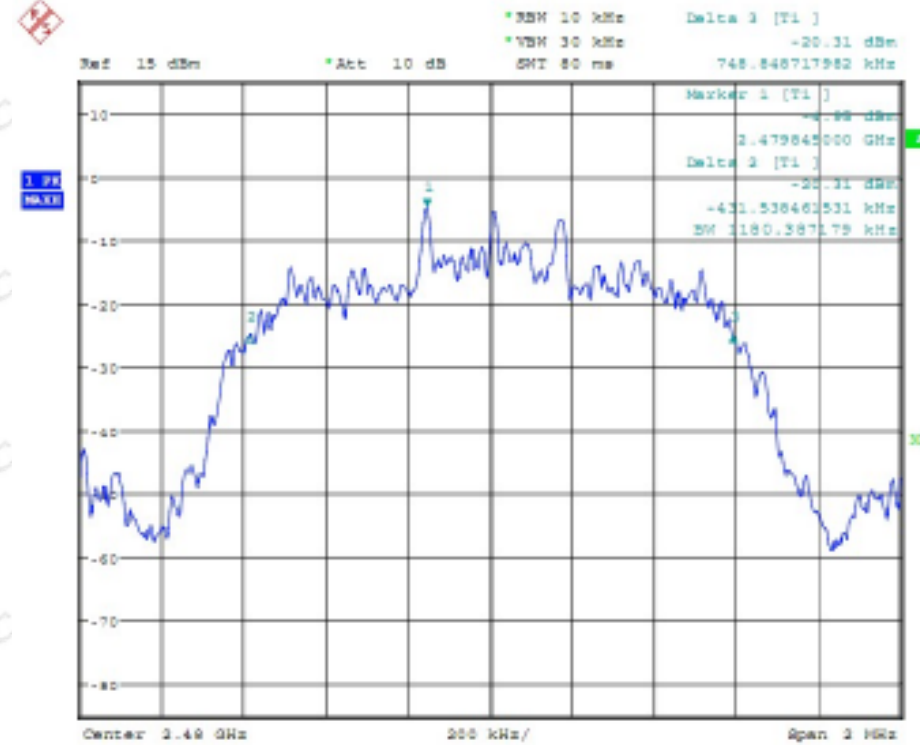

The results shown in this test report refer only to the sample(s) tested unless otherwise stated and the sample(s) are retained for 30 days only. The document is issued by ENC, this document cannot be reproduced except in full with our prior written permission. The document is available on request and the brief information for its validation can be assessable and confirmed at <http://www.enc-lab.com>.

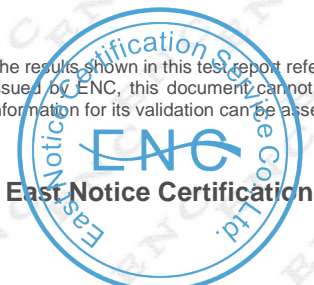

## 9. PEAK OUTPUT POWER TEST

### 9.1 APPLIED PROCEDURES / LIMIT

FCC Part15 (15.247) , Subpart C				
Section	Test Item	Limit	Frequency Range (MHz)	Result
15.247 (b)(1)	Peak Output Power	125 mW or 21dBm	2400-2483.5	PASS

### 9.1.1 MEASUREMENT INSTRUMENTS LIST AND SETTING

Item	Kind of Equipment	Manufacturer	Type No.	Serial No.	Calibrated until
1	Spectrum Analyzer	R&S	FSP 40	100185	05/28/2012

Remark: " N/A" denotes No Model Name , Serial No. or No Calibration specified.

### 9.1.2 TEST PROCEDURE

- The EUT was directly connected to the spectrum analyzer and antenna output port as show in the block diagram below,
- Spectrum Setting: RBW= 1MHz, VBW= 1MHz, Sweep time = Auto.

### 9.1.3 DEVIATION FROM STANDARD

No deviation.

### 9.1.4 TEST SETUP

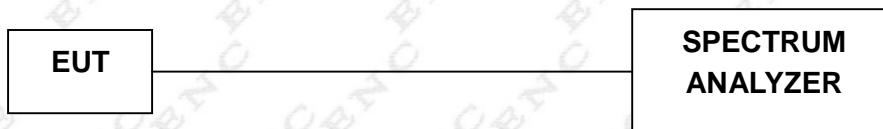

### 9.1.5 EUT OPERATION CONDITIONS

The EUT tested system was configured as the statements of 4.1.6 Unless otherwise a special operating condition is specified in the follows during the testing.

The results shown in this test report refer only to the sample(s) tested unless otherwise stated and the sample(s) are retained for 30 days only. The document is issued by ENC, this document cannot be reproduced except in full with our prior written permission. The document is available on request and the brief information for its validation can be assessable and confirmed at <http://www.enc-lab.com>.



### 9.1.6 TEST RESULTS

EUT:	Bluetooth Headset	Model Name :	Qnine
Temperature:	23 °C	Relative Humidity:	65 %
Pressure:	1012hPa	Test Voltage :	DC 3.7V
Test Mode:	CH00/ CH39 /CH78 -1Mbps		

Test Channel	Frequency (MHz)	Peak Output Power (dBm)	LIMIT (dBm)	LIMIT (mW)
CH00	2402	-2.89	21	125
CH39	2441	-3.23	21	125
CH78	2480	-3.67	21	125

#### CH00 -1Mbps

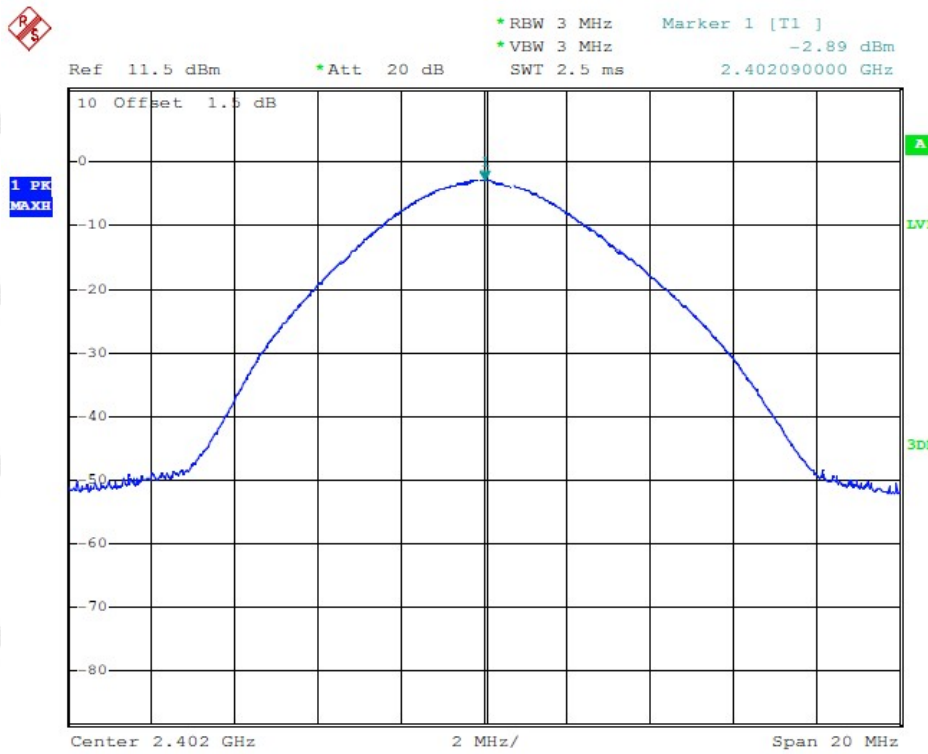

The results shown in this test report refer only to the sample(s) tested unless otherwise stated and the sample(s) are retained for 30 days only. The document is issued by ENC, this document cannot be reproduced except in full with our prior written permission. The document is available on request and the brief information for its validation can be assessable and confirmed at <http://www.enc-lab.com>.



### CH39 -1Mbps

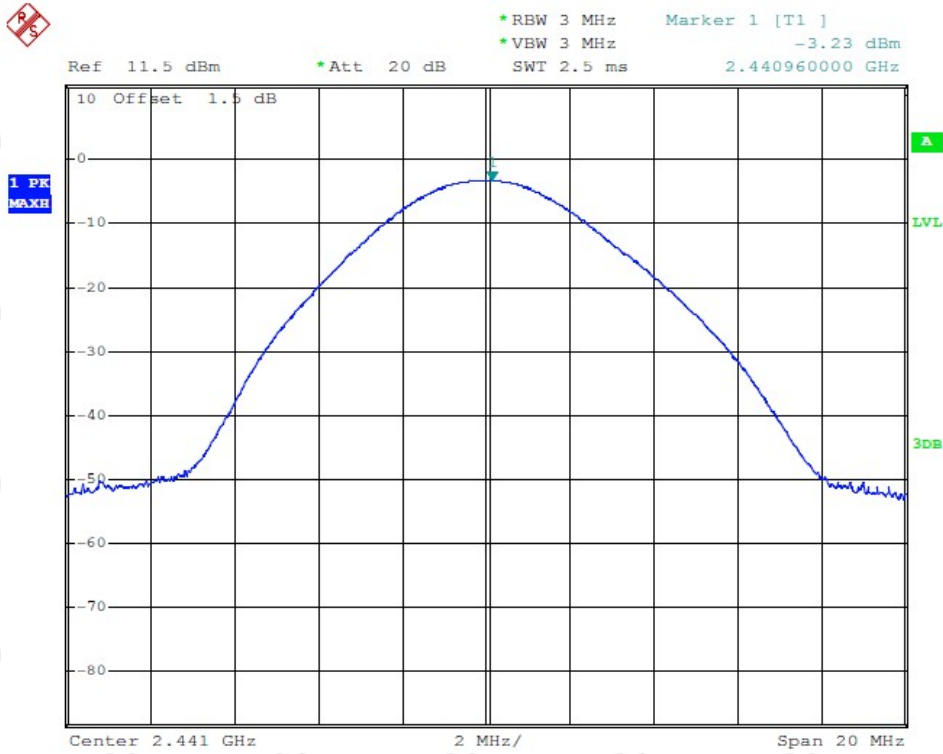

### CH78 -1Mbps

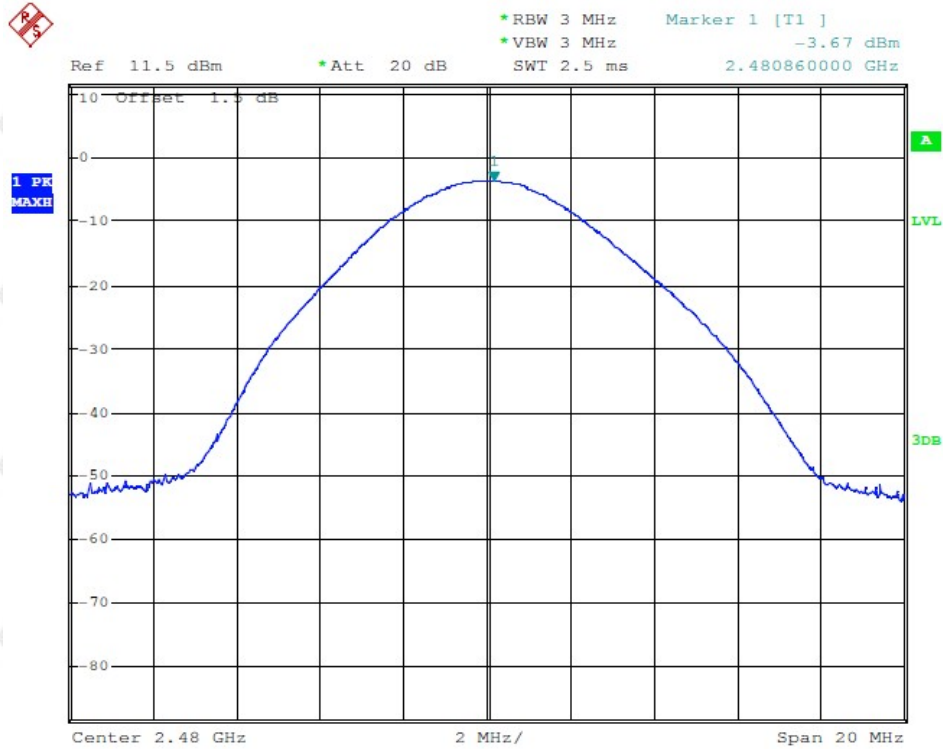

The results shown in this test report refer only to the sample(s) tested unless otherwise stated and the sample(s) are retained for 30 days only. The document is issued by ENC, this document cannot be reproduced except in full with our prior written permission. The document is available on request and the brief information for its validation can be assessable and confirmed at <http://www.enc-lab.com>.



## 10. ANTENNA CONDUCTED SPURIOUS EMISSION

### 10.1 APPLIED PROCEDURES / LIMIT

20dBc in any 100 kHz bandwidth outside the operating frequency band. In case the emission fall within the restricted band specified on 15.205(a), then the 15.209(a) limit in the table below has to be followed.

Frequencies (MHz)	Field Strength (microrvolts/meter)	Measurement Distance (meters)
0.009~0.490	2400/F(KHz)	300
0.490~1.705	24000/F(KHz)	30
1.705~30.0	30	30
30~88	100	3
88~216	150	3
216~960	200	3
Above 960	500	3

#### 10.1.1 MEASUREMENT INSTRUMENTS LIST AND SETTING

Item	Kind of Equipment	Manufacturer	Type No.	Serial No.	Calibrated until
1	Spectrum Analyzer	R&S	FSP 40	100185	05/28/2012

Remark: " N/A" denotes No Model Name , Serial No. or No Calibration specified.

The following table is the setting of the spectrum analyzer.

Spectrum Parameter	Setting
Attenuation	Auto
Span Frequency	100 MHz
RB / VB (emission in restricted band)	1MHz / 1MHz for Peak, 1 MHz / 10Hz for Average
RB / VB (other emission)	100 KHz /100 KHz for Peak

#### 10.1.2 TEST PROCEDURE

- The EUT was directly connected to the spectrum analyzer and antenna output port as show in the block diagram below,
- Spectrum Setting: RBW= 100KHz, VBW=100KHz, Sweep time = Auto.

#### 10.1.3 DEVIATION FROM STANDARD

No deviation.

The results shown in this test report refer only to the sample(s) tested unless otherwise stated and the sample(s) are retained for 30 days only. The document is issued by ENC, this document cannot be reproduced except in full with our prior written permission. The document is available on request and the brief information for its validation can be assessable and confirmed at <http://www.enc-lab.com>.



#### 10.1.4 TEST SETUP

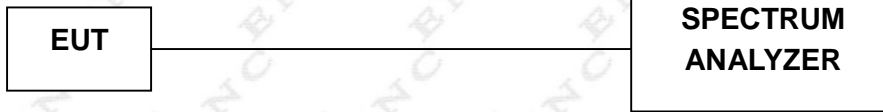

#### 10.1.5 EUT OPERATION CONDITIONS

The EUT tested system was configured as the statements of 4.1.6 Unless otherwise a special operating condition is specified in the follows during the testing.

The results shown in this test report refer only to the sample(s) tested unless otherwise stated and the sample(s) are retained for 30 days only. The document is issued by ENC, this document cannot be reproduced except in full with our prior written permission. The document is available on request and the brief information for its validation can be assessable and confirmed at <http://www.enc-lab.com>.



### 10.1.6 TEST RESULTS

EUT:	Bluetooth Headset	Model Name :	Qnine
Temperature:	23 °C	Relative Humidity:	65 %
Pressure:	1012hPa	Test Voltage :	DC 3.7V
Test Mode:	CH00 / CH78-1Mbps		

The max. radio frequency power in any 100kHz bandwidth outside the frequency band		The max. radio frequency power in any 100 kHz bandwidth within the frequency band.	
FREQUENCY(MHz)	POWER(dBm)	FREQUENCY(MHz)	POWER(dBm)
2400.00	-50.19	2483.50	-56.85
<b>Result</b>			
In any 100kHz bandwidth outside the frequency band, the radio frequency power is at least 20dB below that in the 100kHz bandwidth within the band that contains the highest level of the desired power.			

The results shown in this test report refer only to the sample(s) tested unless otherwise stated and the sample(s) are retained for 30 days only. The document is issued by ENC, this document cannot be reproduced except in full with our prior written permission. The document is available on request and the brief information for its validation can be assessable and confirmed at <http://www.enc-lab.com>.



### CH00 (Lower) -1Mbps

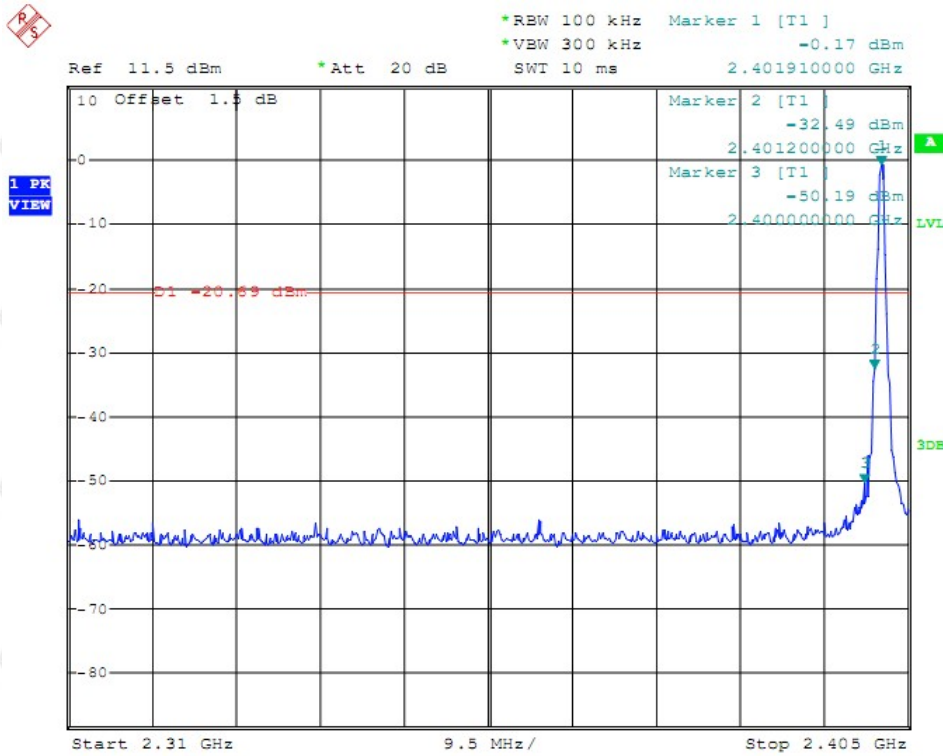

### CH 78 (Upper) -1Mbps

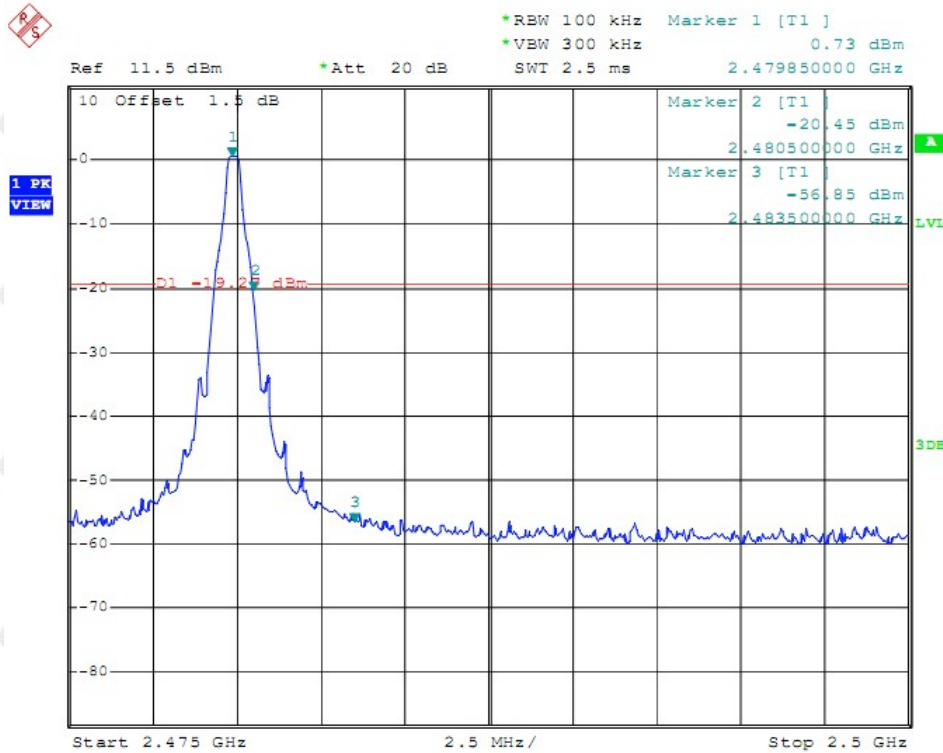

The results shown in this test report refer only to the sample(s) tested unless otherwise stated and the sample(s) are retained for 30 days only. The document is issued by ENC, this document cannot be reproduced except in full with our prior written permission. The document is available on request and the brief information for its validation can be assessable and confirmed at <http://www.enc-lab.com>.



## 11 . PHOTOGRAPHS OF TEST SETUP

### CONDUCTED EMISSION TEST SETUP



### RADIATED EMISSION TEST SETUP

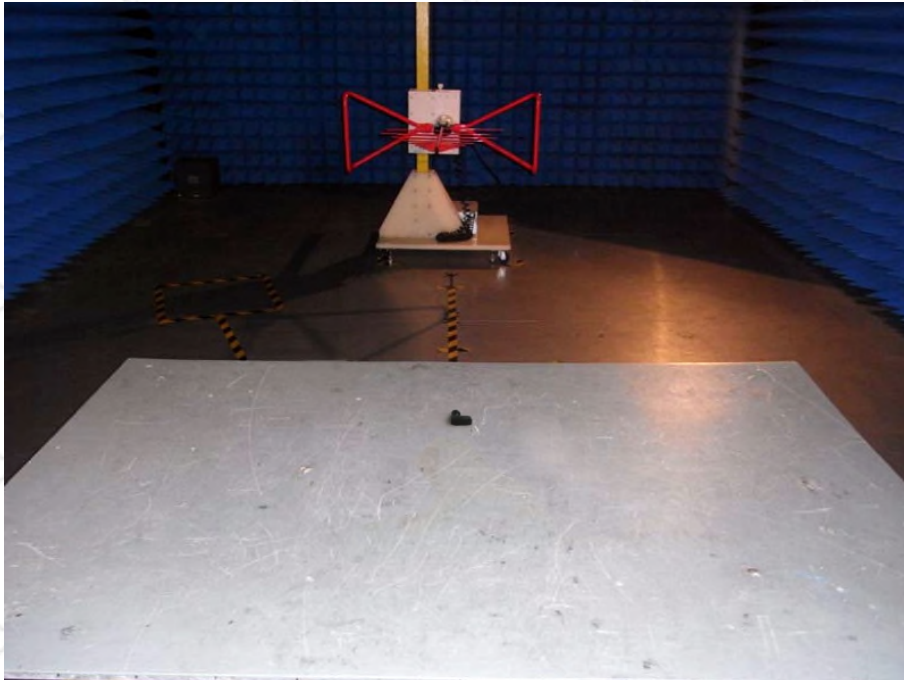

The results shown in this test report refer only to the sample(s) tested unless otherwise stated and the sample(s) are retained for 30 days only. The document is issued by ENC, this document cannot be reproduced except in full with our prior written permission. The document is available on request and the brief information for its validation can be assessable and confirmed at <http://www.enc-lab.com>.

### RADIATED EMISSION TEST SETUP

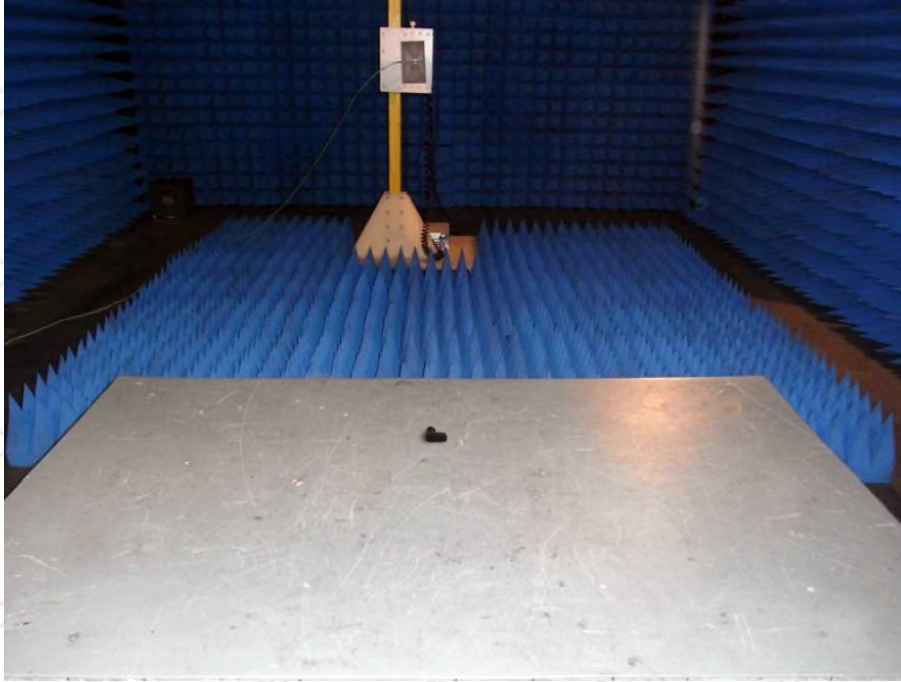

----END OF REPORT----

The results shown in this test report refer only to the sample(s) tested unless otherwise stated and the sample(s) are retained for 30 days only. The document is issued by ENC, this document cannot be reproduced except in full with our prior written permission. The document is available on request and the brief information for its validation can be assessable and confirmed at <http://www.enc-lab.com>.

