

---

# WHITESTAR SIGNATURE™

---



## OWNER'S AND OPERATOR'S MANUAL



**Manufactured By:**  
Advanced Medical Optics, Inc.  
1700 E. St. Andrew Place  
Santa Ana, CA 92705  
USA

1-800-449-3060  
[www.amo-inc.com](http://www.amo-inc.com)

**CE**  
0050



AMO Ireland  
Block B  
Liffey Valley Office Campus  
Quarryvale Co., Dublin Ireland

### For Order Placement of Surgical Products

(IOLs and Phaco Supplies)  
Call 1-877-AMO-4LIFE (USA)  
1-877-266-4543

### For Phaco Returns or Technical Service

Call 1-877-AMO-4LIFE (USA)  
1-877-266-4543

All returns must be accompanied by a  
RGA#  
(Returned Goods Authorization)



Rx Only – Z370147 Rev C 1008  
© 2008 Advanced Medical Optics, Inc.

## **Trademarks**

AMO, the AMO ADVANCED MEDICAL OPTICS logo and WHITESTAR are registered trademarks. ELLIPS, FUSION, LAMINAR, PHACOFIT, OCCLUSION MODE, and WHITESTAR SIGNATURE are trademarks of Advanced Medical Optics, Inc.

DUET and SOLO are trademarks of Micro-Surgical Technology, Inc.

The Bluetooth word mark, figure mark (stylized “B Design”), and combination mark (Bluetooth word mark and “B Design”) are registered trademarks of the Bluetooth SIG.

All brand names and products and company names mentioned in this document are the trade name, service mark, or registered trademarks of their respective owners.

## **Compliance**

In accordance with:

- IEC/EN 60601-1

---

# TABLE OF CONTENTS

<b>Introduction</b> .....	<b>1-1</b>
About this Manual .....	1-2
About Phacoemulsification .....	1-2
Intended Use .....	1-2
WHITESTAR SIGNATURE™ System Description & Features .....	1-2
WHITESTAR® Technology .....	1-3
FUSION™ Fluidics System .....	1-4
Accessories .....	1-4
WHITESTAR SIGNATURE™ System Console .....	1-5
WHITESTAR SIGNATURE™ System Operating Modes .....	1-6
<b>System Components</b> .....	<b>2-1</b>
Receipt and Inspection Instructions .....	2-2
WHITESTAR SIGNATURE™ System Components .....	2-2
WHITESTAR SIGNATURE™ System with FUSION™ Tubing Pack .....	2-4
<b>System Setup</b> .....	<b>3-1</b>
Safety Precautions .....	3-2
Warnings .....	3-5
Symbol Definitions .....	3-9
System Disposal .....	3-12
Setup Sequence – Anterior Segment Surgery .....	3-15
Footpedal .....	3-22
Programmable IV Pole .....	3-25
Wireless Remote Control (Optional) .....	3-26
Surgical Media Center (SMC) (Optional) .....	3-28
Shutdown Sequence – Anterior Segment Surgery .....	3-30
<b>Equipment Operation</b> .....	<b>4-1</b>
Display Screens and Controls .....	4-2
Language Selection .....	4-3
Startup .....	4-4
Select Program and Install the FUSION™ Tubing Cassette .....	4-6
Prime/Tune .....	4-7
Verify Irrigation/Aspiration Balance .....	4-10
Priming for Vitrectomy .....	4-11
Selecting and Changing Mode Parameters .....	4-12

---

<b>Anterior Segment Surgery Operating Modes</b> .....	<b>5-1</b>
Operating Mode Descriptions .....	5-2
Fusion™ Fluidics Phaco .....	5-16
Programming the Modes and Settings .....	5-22
Anterior Segment – Recommended Settings .....	5-38
OCCLUSION MODE™ Phaco Settings .....	5-42
Passive Reflux .....	5-49
Ellips™ Technology .....	5-49
<b>Surgeon Programs</b> .....	<b>6-1</b>
Select Surgeon/Program .....	6-2
Add a New Surgeon .....	6-3
Edit a Surgeon .....	6-5
Select a Preferred Program .....	6-6
Create a New Program .....	6-8
Edit a Surgeon Program .....	6-9
Copy a Surgeon Program .....	6-10
Delete a Surgeon .....	6-11
Delete a Program .....	6-12
Delete a Database .....	6-13
Lock a Program .....	6-13
Program – Assign Order .....	6-14
<b>Diagnostics</b> .....	<b>7-1</b>
Diagnostics .....	7-2
Wireless Footpedal Setup .....	7-3
Wireless Foot Pedal Calibration .....	7-5
Wireless Remote Control Setup .....	7-6
Calibrate Touch Screen .....	7-7
<b>Check-out Precautions</b> .....	<b>8-1</b>
System Check-out .....	8-2
<b>Care and Cleaning</b> .....	<b>9-1</b>
Cleaning Procedures .....	9-2
Sterilization Procedures .....	9-4
WHITESTAR SIGNATURE™ System Cleaning and Care .....	9-5

---

<b>Error Messages Troubleshooting and Diagnostics</b> .....	<b>10-1</b>
Error Message Display .....	10-2
Fuse Replacement Procedure .....	10-2
Wireless Foot Pedal Battery Replacement Procedure .....	10-3
Most Common User-Correctable Problems .....	10-5
Status, Warning and Error Messages .....	10-5
System Operation (Error) Messages .....	10-5
Troubleshooting .....	10-16
 <b>Warranty and Maintenance</b> .....	 <b>11-1</b>
Warranty Statement .....	11-2
 <b>Specifications</b> .....	 <b>12-1</b>
Physical Specifications .....	12-2
Environmental Specifications .....	12-3
Electrical Specifications .....	12-3
Diathermy Specifications .....	12-3
Irrigation and Aspiration Specifications .....	12-3
Phacoemulsification Specifications .....	12-4
Vitrectomy Specifications .....	12-4
Diathermy Power Graphs .....	12-5
Diathermy Power versus Load Impedance .....	12-10
Phaco Power Graphs .....	12-13
 <b>Accessories and Parts Reordering</b> .....	 <b>13-1</b>
List of Accessories with Part Numbers .....	13-2
 <b>Glossary</b> .....	 <b>Glossary-1</b>
 <b>Index</b> .....	 <b>Index-1</b>



# 1 INTRODUCTION

---

About this Manual

---

About Phacoemulsification

---

Intended Use

---

WHITESTAR SIGNATURE™ System Description & Features

---

WHITESTAR® Technology

---

FUSION™ Fluidics System

---

Accessories

---

WHITESTAR SIGNATURE™ System Console

---

WHITESTAR SIGNATURE™ System Operating Modes

---

**About this Manual**

This manual includes information about the WHITESTAR SIGNATURE™ System which is designed for anterior segment (phacoemulsification) surgical procedures.

This manual includes information regarding optional System enhancements. The availability of these features in your System configuration and availability in your area can be confirmed by your AMO representative.

**About Phacoemulsification**

Over thirty years ago, Dr. Charles Kelman conceived and developed phacoemulsification, a method of cataract removal using ultrasonic emulsification and aspiration of the cataractous lens through a small incision. Phacoemulsification is advantageous for both patient and surgeon:

- Greater intraoperative control.
- The smaller incision requires fewer or no sutures, poses less risk of infection and induced astigmatism, and gives better long-term and short-term predictability of vision.
- Patients are able to resume normal activity much sooner and with fewer restrictions than with traditional cataract extraction surgeries.

Advanced Medical Optics, Inc. (AMO) supports phacoemulsification with sophisticated instrumentation that optimizes the benefits of this surgical procedure.

**Intended Use**

The WHITESTAR SIGNATURE™ System is a modular ophthalmic microsurgical system that facilitates anterior segment (cataract) surgery. The modular design allows the users to configure the system to meet their surgical requirements.

This HIGH FREQUENCY (HF) SURGICAL EQUIPMENT is specified for use without a NEUTRAL ELECTRODE.

**WHITESTAR SIGNATURE™ System Description & Features**

The WHITESTAR SIGNATURE™ System is a multi-functional tool for use in anterior segment surgery and procedures. The WHITESTAR SIGNATURE™ System represents the latest generation of AMO™ phacoemulsification technology. Safety, ease-of-use, and reliability are designed and manufactured into every WHITESTAR SIGNATURE™ System. The WHITESTAR SIGNATURE™ System meets applicable United States and International safety requirements for this type of device.

The WHITESTAR SIGNATURE™ System contains a number of features based on extensive research and clinical trials with highly-trained and noted ophthalmologists who are experienced phacoemulsification surgeons.



**WHITESTAR®  
Technology**

The WHITESTAR® Technology represents the many enhancements to the power modulation for the WHITESTAR SIGNATURE™ System. The WHITESTAR® Technology enhancement was the first to deliver finely modulated pulses of energy, interrupted by extremely brief cooling periods. This allows the WHITESTAR SIGNATURE™ System to achieve full ultrasound cutting efficiency and magnetic followability, while introducing less energy into the eye. Ultrasound time is minimized or eliminated to reduce the risk of thermal damage.

**WHITESTAR® ICE Technology**

The WHITESTAR® ICE Technology was the next micro-pulse advance in phacoemulsification technology, which combined modulated ultrasonic power (pulse shaping) with vacuum control through the application of the Chamber Stabilization Environment (CASE).

This pulse shaping technology modified the standard “square” wave pulse, by increasing the amplitude of the first millisecond of the On Time “kick”, and then setting the remaining part of the On Time to the standard power setting. This is repeated for each On Time period, resulting in increased control and efficiency in phacoemulsification.

**OCCLUSION MODE™ Phaco**

The OCCLUSION MODE™ Phaco is used to regulate the vacuum rise time experiences following occlusion of the phaco tip, without limiting the choice of aspiration rate through an unoccluded needle. In order to independently control the aspiration rate and vacuum rise time, you can have a different aspiration rate when the needle is occluded than when the needle is not occluded.

The OCCLUSION MODE™ Phaco is also used to regulate ultrasound power modulation. The power modulation of the phaco handpiece (continuous, pulse, burst) can be programmed to automatically change when the phaco tip changes from an unoccluded condition to an occluded condition.

The FUSION™ Mode allows the user to access the settings and variables for both CASE and OCCLUSION MODE™ Phaco. The CASE and OCCLUSION MODE™ Phaco can be used together or independently.

**FUSION™ Fluidics System**

The WHITESTAR SIGNATURE™ System has both a flow-based peristaltic pump system and a vacuum based Venturi pump system. The patented microprocessor-based system continuously monitors and controls intraocular conditions of the flow and vacuum in the eye.

**Chamber Stability Environmental (CASE)**

CASE is an intelligent vacuum monitoring system used to regulate the maximum allowable vacuum that is experienced following the occlusion of the phaco tip. When the phaco tip becomes occluded, the vacuum rises. Clearing of the occlusion while the vacuum is at a high level can lead to a post-occlusion surge. With CASE enabled, the System monitors the actual vacuum levels and when the vacuum exceeds a specific threshold for a specified duration, the System automatically adjusts the maximum allowable vacuum setting to a lower predefined CASE maximum vacuum level. When the occlusion is cleared, the System is automatically restored to the original programmed maximum vacuum setting. This function makes it possible to have a different maximum vacuum setting when the needle is occluded than when the needle is not occluded.

**Accessories****WHITESTAR® Handpiece**

The Phaco Handpiece has been designed with a straight-through aspiration channel for more efficient removal of nuclear fragments, to minimize clogging and to facilitate cleaning. The hand piece is lightweight, slim, and well-balanced, making it comfortable to use and easy to manipulate.

**Ellips™ Handpiece**

An Ellips™ phaco handpiece is available for use with the WHITESTAR SIGNATURE™ System. The Ellips™ handpiece provides both longitudinal and transversal movement. The Ellips™ handpiece provides great followability and can be used with either a straight or a curved tip.

**Footpedal**

The footpedal controls the various operating modes of the instrument, and all settings are programmed through the user interface. The WHITESTAR SIGNATURE™ Single Linear footpedal or the wireless Advanced Control Pedal (dual linear) can be used with the system.

The footpedal design offers control through the use of increased linearity and uniform pressure throughout the footpedal movement, easing foot and leg fatigue. The degrees of movement for each footpedal position can be selected and saved in memory for each surgeon/mode, pitch for the single linear footpedal only and pitch and yaw for the Advanced Control Pedal giving the pedal dual linear functionality. Reflux is activated by programmable switches, giving immediate response. The footpedal is connected to the rear of the console by a cable or can be wireless as with the Advanced Control Pedal.

### **Wireless Remote Control (Optional)**

The WHITESTAR SIGNATURE™ System can be controlled from the wireless remote control keypad. All modes can be remotely accessed, and all settings can be adjusted with the use of the wireless remote control, including full programming and priming capabilities. Backlighting supports low light operating room conditions.

### **WHITESTAR SIGNATURE™ System Console**

Operating Room teams contributed significantly to the successful design of the WHITESTAR SIGNATURE™ System Cart. The solid wheel base and locking wheels make the cart stable and smooth rolling. An adjustable height Mayo tray accommodates the handpieces and tubing. The remote control is wireless and recharges when the remote control is placed in the storage bay. An open bin and footpedal platform are available for storage.

### **WHITESTAR SIGNATURE™ System Display (Graphic User Interface-GUI)**

The WHITESTAR SIGNATURE™ System graphic screen display is easy to read and easy to operate. You can see at a glance the status of the system. The screen gives you visual indication of operating modes, settings, and system status. Messages cue you through the procedure, and error messages indicate improper connections or selections. Help information is available from the touch screen controls.

### **Prime/Tune**

Before the start of each surgical case, the system requires Prime, Tune or Prime/Tune to be executed. The Prime mode incorporates the function of tubing purge, and fills and completes the fluid aspiration and vacuum check. The Tune mode incorporates the ultrasonic power calibration and safety check for the connected phaco handpiece. The Prime/Tune mode allows the system to prime and tune the handpiece at the same time.

### **Dual Pump**

The WHITESTAR SIGNATURE™ System provides a fluid aspiration system using either a peristaltic (flow-based) pump or a Venturi (vacuum-based) pump system. The surgeon can utilize the Venturi pump in the Phaco, IA, and Vitrectomy surgical modes.

### **Continuous Irrigation**

Continuous Irrigation is immediately available via dedicated keys on the touch screen and the wireless remote control. Surgeon control of Continuous Irrigation with the footpedal is also available. Continuous Irrigation can be used to fill cups prior to Prime/Tune. The Cup Fill feature can be used in place of Continuous Irrigation when you fill a cup. The Cup Fill feature is only available from the Prime/Tune screen. (See Chapter 4 Equipment Operation, Prime/Tune for Detailed information.)

## **Programmable Operating Parameters**

The WHITESTAR SIGNATURE™ System is programmable through the screens on the touch screen monitor. You can select your desired settings for each portion of the anterior surgical procedure. Up to 50 surgeon names with a maximum of 20 different setups, plus the AMO™ default settings program can be stored in the instrument program memory. This allows different users to preset their preferences, or an individual user to select setups for different procedures, including a personalized initial operating mode.

## **MMP – Multiple Mode Programming**

Multiple submodes are available within the WHITESTAR SIGNATURE™ System operating modes. This allows you to preset your settings for specific techniques such as phaco chop or viscoelastic removal.

## **Programmable IV Pole**

The WHITESTAR SIGNATURE™ System is equipped with a programmable IV pole. The programmable IV pole height settings can be entered independently for each of the PHACO modes plus settings for Diathermy, IA and Vitrectomy. During surgery, the programmable IV pole height changes to the preprogrammed height when you switch modes.

The automated and programmable IV pole allows adjustment of the bottle height to provide gravity infusion through each procedural phase. Two adjustment keys on the touch screen or the wireless remote control are used to raise and lower the bottled balanced salt solution, while maintaining the sterility of the operating field. A separate up and down switch allows IV pole adjustment from the side of the system.

## **WHITESTAR SIGNATURE™ System Operating Modes**

The WHITESTAR SIGNATURE™ System was designed to provide all the Operating Modes and surgical capabilities required by the anterior segment or cataract surgeon. These capabilities include:

### **Diathermy (DIA)**

The Diathermy mode is used by most surgeons to coagulate blood vessels during the procedure and by some surgeons to “coag” the conjunctiva at the end of the procedure. An isolated output frequency allows non-contact tissue coagulation, eliminating adhesion and traction. Also, the depth of penetration of the energy field is less than that of lower frequency units, which minimizes tissue shrinkage or charring. The gentleness of the diathermy mode allows the surgeon to stop “bleeders” within the incision with only minimal scleral shrinkage.

### **Phacoemulsification (PHACO)**

The Phacoemulsification mode is used to break up (emulsify) the nucleus of the lens and then allows the nucleus of the lens to be aspirated from the eye through a small incision. The continuous autotuning circuitry maximizes the emulsification efficiency for each lens density, even varying densities within the same lens. Phaco time is displayed in minutes and seconds. The convenient selection of linear or panel preset phaco power, in a variety of power delivery options (pulsed, burst, transversal), provides increased precision and control.

The WHITESTAR<sup>®</sup> Technology allows you to safely remove all lens types through small incisions with single-mode, single-instrument convenience.

The WHITESTAR<sup>®</sup> Technology is a patented software application proven to change the characteristics of phacoemulsification using little or no ultrasound. This is done by changing the thermal properties and improving control of the lens without reducing the cutting power or changing technique or efficiency.

### **CASE One Touch**

The One Touch button simplifies the programming of the CASE function and allows you to easily define the basic CASE settings once. The CASE function can then be adjusted quickly with the CASE One Touch settings on the surgical screens. When these controls are used, the CASE functionality can be changed to provide enhanced control or improved efficiency to suit any particular combination of cataract density, surgical technique or personal preferences.

### **Irrigation/Aspiration (IA)**

The Irrigation and Aspiration mode allows for controlled aspiration of cortical material from the eye, while maintaining intraocular stability, by replacing the aspirated material with a balanced salt solution. A peristaltic pump provides a predictable and stable aspiration rate. Complete control is achieved with “Aspiration Rate” and “Vacuum”. Irrigation is gravity-fed.

The gravity-fed mode is regulated by adjusting the height of the balanced salt solution bottle. This mode gives you flexible control of each case with independently adjustable vacuum level and flow rate settings.

### **Vitrectomy (VIT)**

The Vitrectomy mode is used to remove vitreous from the eye during surgery. The WHITESTAR SIGNATURE<sup>™</sup> System uses air pressure to drive the vitreous cutter. The wide range of user-controlled, programmable cut rates supports both anterior segment and posterior segment surgeries.



# 2

## SYSTEM COMPONENTS

---

Receipt and Inspection Instructions

---

WHITESTAR SIGNATURE™ System Components

---

WHITESTAR SIGNATURE™ System with FUSION™ Tubing Pack

**Receipt and  
Inspection  
Instructions**

When you receive your WHITESTAR SIGNATURE™ System inspect the exterior packaging for any signs of damage that might have occurred during shipping and record this damage on the shipping documents. If there are any signs of damage, carefully unpack the WHITESTAR SIGNATURE™ System and inspect the System for damage. If any damage to the package contents has occurred, you must immediately file a claim with the transporter. The transporters accept claims only from the recipient (you), not from the shipper (AMO).

Your AMO Representative will have contacted you to schedule both the Installation and the In-Service Training when you receive your new WHITESTAR SIGNATURE™ System. **We suggest that you leave the WHITESTAR SIGNATURE™ System in the original packaging and store the package in a cool, dry environment** until the AMO installation personnel arrive to assemble, install and test your equipment. Extreme heat, cold or moisture can damage any electronic equipment.

**WHITESTAR  
SIGNATURE™  
System Components**

Your WHITESTAR SIGNATURE™ System consists of some or all of the following components:

- WHITESTAR SIGNATURE™ System console with an integral cart, mayo tray on an adjustable arm and a Programmable IV Pole
- FUSION™ Tubing Pack (disposable)
- Footpedal and Power Cord (Single or Advanced Control Pedal (Dual Linear))
- Power Cord (detachable)
- Wireless Remote Control Module
- WHITESTAR SIGNATURE™ System Owner's Manual



Figure 2.1 – WHITESTAR SIGNATURE™ System

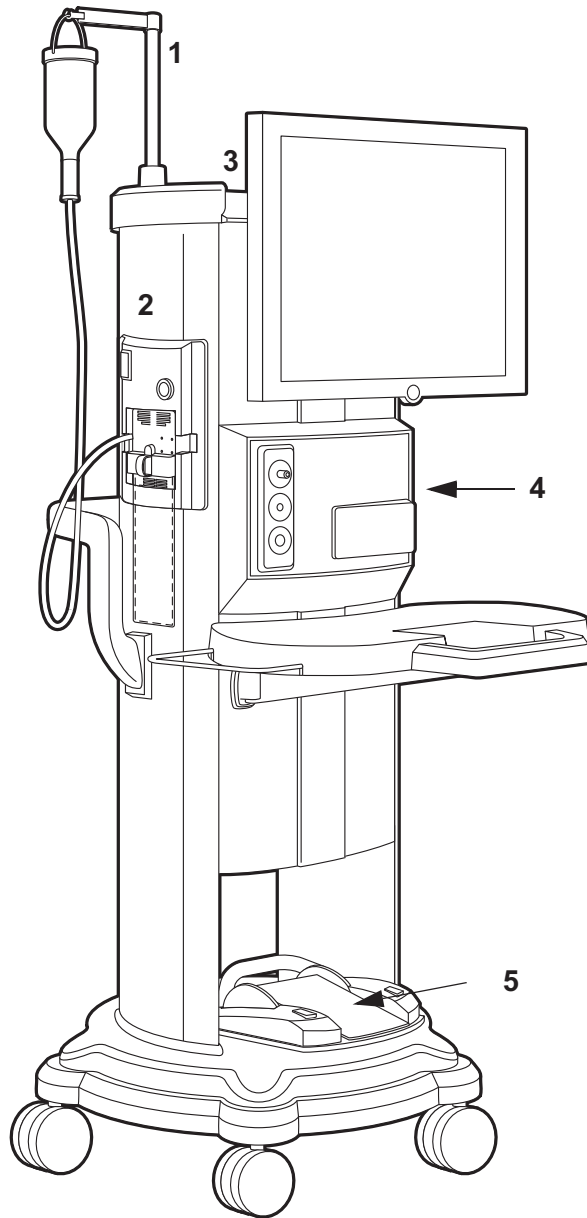

- |  |   |
|--|---|
| 1. Programmable IV Pole  | 4. WHITESTAR SIGNATURE™ System console with Integral Cart and Mayo Tray |
| 2. FUSION™ Tubing Cassette   |   |
| 3. Wireless Remote Control Module (Storage bay on top of the system) | 5. Footpedal  |

**WHITESTAR  
SIGNATURE™  
System with  
FUSION™ Tubing  
Pack**

Each surgical procedure requires a disposable FUSION™ Tubing Cassette for either the peristaltic pump or the Venturi pump. The FUSION™ Tubing Cassette only works with the peristaltic pump, which is used in anterior/cataract surgeries. The Dual Pump Tubing Cassette works with both the peristaltic pump and the Venturi pump. With the Fusion™ Dual Pump Pack you can select either pump while you are in a surgical case.

The tubing pack contains the following components:

- Tubing cassette with irrigation and aspiration tubing (administration set) with an attached, sealed drain bag
- Infusion Sleeve
- Test Chamber – to test and prime/tune the phaco handpiece
- Mayo Stand Drape – to cover the Mayo tray and arm
- Monitor Drape – to cover the front of the touch screen

**Figure 2.2 – FUSION™ Tubing Cassette**

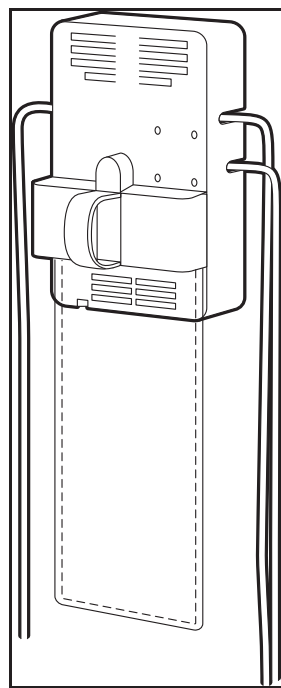

Proper handling and disposal methods for biohazards must be used when you dispose of the tubing cassette, Mayo stand drape and monitor drape.

# 3

## SYSTEM SETUP

---

Safety Precautions

---

Warnings

---

Symbol Definitions

---

System Disposal

---

Setup Sequence – Anterior Segment Surgery

---

Footpedal

---

Programmable IV Pole

---

Wireless Remote Control (Optional)

---

Surgical Media Center (SMC) (Optional)

---

Shutdown Sequence – Anterior Segment Surgery

---

## Safety Precautions

Now that the system is set up and you have verified that all of the functions are operating properly, you are almost ready to use your WHITESTAR SIGNATURE™ System.

Read the following Safety Precautions and Warnings carefully before you use the WHITESTAR SIGNATURE™ System in surgery.

1. The WHITESTAR SIGNATURE™ System is equipped with 3-prong power plug which must be plugged into an outlet with a ground receptacle.  
  
If the plug does not fit the outlet, contact an electrician. DO NOT modify or remove the ground pin.
2. Do not use extension cords with your system.
3. Do not overload your electrical receptacle (outlet).
4. If the cord or plug is damaged, do not use the instrument. An electric shock or fire hazard can result. Call AMO customer service to order a new cord.
5. The instrument has ventilation openings at the rear of the console to allow ambient air intake and the release of heat generated during operation. If the openings are blocked, heat build-up can cause system failures which can result in a fire hazard.
6. Do not try to move the WHITESTAR SIGNATURE™ System cart on deep pile carpets or over objects on the floor such as cables and power cords.
7. Take care not to trip over power and footpedal cords.
8. Do not try to lift the WHITESTAR SIGNATURE™ System cart.
9. Do not place the instrument on uneven or sloped surfaces.
10. Do not use disposables, accessories or other surgical instruments that are not designed for this system. Use only parts recommended by AMO to achieve optimum performance and safety.
11. Do not operate the WHITESTAR SIGNATURE™ System in a condensing environment. Take care to protect the instrument from fluid sprays or fluid buildup.
12. To protect the patient from contaminated fluids or handpieces, use only:
  - sterile tubing cassettes
  - sterile irrigation fluid
  - sterile handpieces
13. Use caution when you extend, retract or swivel the Mayo stand articulating arm. Stay clear of the hinged hardware.
14. Use caution when you use handpieces with sharp edges or pointed tips.

15. Always replace the tubing cassette between cases.
16. Wrap the excess power cord neatly around the cord wrap on the back of the console.

### **Changing Irrigation Flow**

Use extreme caution when you lower or raise the balanced salt solution bottle to decrease or increase fluid flow and pressure. If you lower the bottle too much it can cause the anterior chamber to collapse. If you raise the bottle too high it can cause the anterior chamber to deepen. To make sure that the bottle height does not go too high, you can set the maximum bottle height on the Diagnostics screen.

Note: Use a new bottle of balanced salt solution at the start of each case.

### **Phacoemulsification without Adequate Irrigation**

Operating phacoemulsification without an adequate irrigation flow can result in an elevated temperature of the tip and subsequent damage to the eye tissue or could cause the chamber to collapse. Confirm that there is irrigation flow before you initiate phacoemulsification. A tight wound or the angle of the needle next to the wound can also constrict the irrigation flow by pinching the coaxial irrigation sleeve assembly on the needle of the phaco handpiece.

### **Power Failure during Surgery**

If there is a loss of power during a procedure, you need to:

- Withdraw the handpiece from the eye
- Release the footpedal to Position 0

When power is restored:

- Select Prime/Tune to reprime the fluids and tune the phaco handpiece. Use **Bypass** to reduce the length of prime time.
- Select the mode that was in use when power was lost (PHACO, IA, Vitrectomy or Diathermy)

### **Connecting Handpieces**

It is very important that the electrical connectors on the handpieces are completely dry before they are connected to the WHITESTAR SIGNATURE™ System receptacles. You can receive a “Handpiece Ground Fault Error” message if the connector is wet.

### **Handling the Phaco Handpiece**

The phaco handpiece is a very delicate instrument and must be handled with EXTREME care. If the handpiece is dropped or receives any other significant impact, the handpiece will not work properly. The ultrasonic titanium phaco tip must never touch any solid material while in use.

Always flush the handpiece immediately following surgery.

See cleaning instructions given in Chapter 9, “Care and Cleaning”.

Handpieces can be extremely hot immediately after sterilization. Use care and caution when handling.

### **Phaco and Vitrectomy Operation**

The phaco handpiece and the vitrectomy cutter must never be activated with the tips exposed to air. If the tips are activated in the air, the useful life of the handpiece and the cutter is reduced. If power is to be introduced to the phaco handpiece or the vitrectomy cutter, the tips must be in a test chamber filled with a balanced salt solution, in a container of balanced salt solution, or in the patient's eye.

### **Vitrectomy**

Failure to properly attach the tubing to the appropriate vacuum or pressure source can affect the vitrectomy cutter operation. Be sure to read the vitrectomy cutter package insert for correct assembly and connection procedures.

### **Diathermy**

When you enter the Diathermy mode, an audible tone should be heard. Also, whenever diathermy power is applied, an audible tone should be heard.

The diathermy cable must be checked periodically for damage. If the cable shows signs of damage, replace the cable immediately with the same type of cable. Use of other types of cables can affect the diathermy performance.

During surgery, the diathermy output power must be as low as possible for the intended purpose. AMO recommends the 30% setting to start.

The diathermy cable must be positioned in such a way that contact with the patient or other leads is avoided. Grounded or ungrounded metal parts must not come in contact with the patient when diathermy is used.

For proper operation of the diathermy, replace the handpiece with the same type.

### **Programmable IV Pole**

Do not exceed the maximum weight of two 500 ml balanced salt solution bottles on the IV pole bottle holder.

### **Wireless Remote Control and Wireless Foot Pedal**

These devices comply with part 15 of the FCC (Federal Communications Commission) Rules. Operation is subject to the following two conditions:

1. This device may not cause harmful interference.
2. This device must accept any interference received, including interference that may cause undesired operation.

Any changes or modifications not expressly approved by Advanced Medical Optics, Inc. can void the user's authority to operate the equipment.

Note: This equipment has been tested and found to comply with the limits for a Class A digital device, pursuant to part 15 of the FCC Rules. These limits are designed to provide reasonable protection against harmful interference when the equipment is operated in a commercial environment. This equipment generates, uses, and can radiate radio frequency energy and, if not installed and used in accordance with the instruction manual, may cause harmful interference to radio communications. Operation of this equipment in a residential area is likely to cause harmful interference in which case the user will be required to correct the interference at his own expense.

## Warnings



**WARNING:** All personnel who might operate this equipment must read and understand the instructions in this manual before the system is used. Failure to do so might result in the improper operation of the system. This device is only to be used by a trained licensed physician.



**WARNING:** The fluid level in the balanced salt solution bottle must be monitored by the surgical nursing staff. The result of a low bottle or an empty bottle affects the fluid balance and the intra-ocular pressure (IOP) while aspirating. The low or empty bottle can result in:

- The inadvertent chamber shallowing or collapse
- The Aspiration of tissue
- An ultrasonic wound heating commonly called wound burn (extreme case)

The surgical staff must monitor the fluid level at all times.



**WARNING:** DO NOT attempt to use the system if the system fails to perform properly as stated in this manual.



**WARNING:** DO NOT use the System in the presence of flammable anesthetics, or other flammable gases, near flammable fluids or objects, or in the presence of oxidizing agents, as a fire could result.



**WARNING:** This unit might interfere with any cardiac pacemaker fitted to the patient; therefore qualified advice must be obtained prior to such use.



**WARNING:** The patient must not come into contact with metal parts which are grounded or have appreciable capacitance to ground. The use of an antistatic mat for this purpose is recommended.



**WARNING:** Proper handling and disposal methods for biohazards must be used when you dispose of the tubing cassette, mayo stand drape and monitor drape.



**WARNING:** Monitoring electrodes or other types of equipment must be placed as far from those of the WHITESTAR SIGNATURE™ System as possible. High current limiting devices are recommended for the protection of such systems. Needle monitoring electrodes are not recommended.



**WARNING:** Keep the diathermy cord away from the patient and other handpieces or leads (for example, monitoring electrodes).



**WARNING:** The output power selected must be as low as possible for the intended purpose.



**WARNING:** Although this unit complies with all Electromagnetic Interference (EMI) standards and requirements, it is possible that interference provided by the operation of the HIGH FREQUENCY (HF) SURGICAL EQUIPMENT can adversely influence the operation of other electronic equipment.





**WARNING:** Skin to skin contact on the patient, for example, between the arms and the torso is not recommended. Insert dry gauze to avoid contact, as appropriate.

Note: The unit does not contain any neutral electrode.

Note: The diathermy output is bipolar.

Note: It is recommended that the condition of all inter-connecting and handpiece cables be checked on a regular basis.



**WARNING:** Risk of burns and fire. Do not use the system near conductive materials such as metal bed parts, inner spring mattresses, or similar items. Replace electrode cables on evidence of deterioration.



**WARNING:** Hazardous electrical output. This equipment is for use only by qualified personnel.



**WARNING:** Disconnect the power before you service the equipment.



**WARNING:** Remove the power cord from the power outlet when the equipment is not in use.



**WARNING:** Do not obstruct the power outlet so that the power cord can be readily removed, as needed.



**WARNING:** Not recommended for use in condensing environments. If exposed to a condensing environment, allow the system to equilibrate to typical operating room conditions prior to use.



**WARNING:** This HIGH FREQUENCY (HF) SURGICAL EQUIPMENT is specified for use without a NEUTRAL ELECTRODE.



**WARNING:** Failure of the HIGH FREQUENCY (HF) SURGICAL EQUIPMENT could result in an unintended increase of output power.



**WARNING:** DO NOT try to replace the Wireless Remote Control batteries. Call your AMO Technical Service representative to replace the batteries.



**WARNING:** Sterility assurance is the responsibility of the user. All non-sterile accessories must be sterilized prior to use.



**WARNING:** Prior to using any invasive portions of the handpiece assembly, examine under the microscope for any obvious damage, oxidation, or the presence of foreign material. If any questionable characteristics are noted, use a backup handpiece for surgery. Use of contaminated or damaged system accessories can cause patient injury.















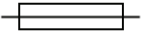



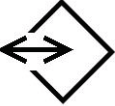

**WARNING:** Use of non-AMO approved products with the WHITESTAR SIGNATURE™ System, can affect overall system performance and is not recommended. AMO cannot be responsible for system surgical performance if these products are utilized in surgery.









**Symbol Definitions**

The following symbols appear on the WHITESTAR SIGNATURE™ System front and back panels and in the software:

**Table 3.1 – Symbol Definitions**

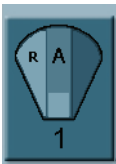
Symbol	Definition
	Symbol on power switch indicates Power is On.
	Symbol on power switch indicates Power is Off.
	Indicates that there are important operating and maintenance instructions included in the Owner's and Operator's Manual.
	Indicates the presence of uninsulated high voltage inside the instrument. Risk of electric shock. Do not remove the instrument cover.
	Indicates fuse.
	Single phase alternating current.
	Patient applied part is isolated from earth ground.
	Patient applied part is grounded OR no direct electrical energy is involved.
	Footpedal connection.
	Communications Port

Symbol	Definition
	Programmable IV Pole
	Diathermy Receptacle
	Phaco Handpiece Receptacle
	Vitreotomy Cutter Connection
	Potential Equalizer
	Indicates compliance with the Medical Device Directive.
	Separate Disposal/Collection Required
	Environment Friendly Use Period in Years (RoHS)
	Indicates compliance with IEC 60601-1-2:2001, “Electromagnetic Compatibility Requirements and Tests for Medical Electrical Equipment.”
	ETL Listed Mark issued to those products that have met the requirements of product safety standards for the United States and Canada. (ETL formerly Edison Testing Laboratory)

Symbol	Definition
	Universal Serial Bus (USB) Port  Note: Use only AMO recommended USB stick drives.
	Federal Communications Commission (FCC)  The FCC regulates interstate and international communications by radio, television, wire, satellite and cable under the FCC's jurisdiction.
	FUSION™ Mode button used to open the CASE settings screen.
	Single Linear Foot Pedal Icon. Shows the position of the footpedal when the footpedal is pressed. The number shown changes when the position is changed.
	Advanced Control Pedal (Dual Linear) Icon. Shows the position of the footpedal when the footpedal is pressed. The number shown changes when the position is changed. The letters indicate the location of Aspiration (A), Irrigation (I), Phaco (P), Reflux (R), Whitestar Increment/Decrement (WS) and Switch (S).
	WHITESTAR® Technology is <b>On</b> .
	WHITESTAR® Technology is <b>On</b> and ICE Pulse Shaping is <b>On</b> .
	Ellips™ Technology is <b>On</b> .
	Reload button is used to cycle through the surgeon's programs.

## System Disposal

### WEEE

The electronic components of the WHITESTAR SIGNATURE™ System are subject to the European Union Directive 2002/96/EC on Waste Electrical and Electronic Equipment. This directive applies to all electronic equipment in the European Union only.

The disposal to municipal waste is prohibited for electronic equipment subject to this directive; this equipment must be treated or recycled. Each component that is subject to this regulation is marked on the component itself with the following symbol:



In some cases where the component's size prohibits marking (such as handpieces) the marking can be found on the directions for use and the warranty. Treatment and/or recycling of the electronic equipment are provided at no cost to you. Please see the contact information below for disposition of unwanted AMO electronic equipment.

For disposal of your unit, contact your local AMO subsidiary or the AMO service center nearest you.

<p><b>Belgium</b></p> <p><i>Contact</i> De Ceunynck Medical nv/sa Kontichsesteenweg 36 B-2630 AARTSELAAR Belgium</p>	<p><b>Denmark</b></p> <p><i>Distributor</i> AMO Denmark ApS c/o Advanced Medical Optics Norden AB Kanalvagen 3A SE 194 61 Upplands Vasby Sweden</p>
<p><b>Finland</b></p> <p>AMO Norden AB Vantaa/Finland Rajatorpantie 41 C, 3. krs FIN-01640 Vantaa Finland Phone: +358 9 8520 2192</p>	<p><b>France</b></p> <p>AMO France SAS Greenside 15, 750 Avenue de Roumanille 06410 Biot France Phone: +33 4 93 00 11 95</p>

<p><b>Germany</b></p> <p>AMO Germany GmbH Rudolf-Plank Strasse 31 D-76275 Ettlingen Germany Phone: +49 7243 729 444 (Hotline)</p>	<p><b>Greece</b></p> <p><i>Distributor</i> Nexus Medicals s.a. 12th km Nat. Road Ave Athens- Lamia &amp; Zakynthou str. 14451 Metamorfoosi Athens Greece</p>
<p><b>Ireland</b></p> <p>AMO Ireland Block B Liffy Valley Office Campus Quarryvale, Co. Dublin Ireland</p>	<p><b>Italy</b></p> <p>AMO Italy Srl Via Pio Emmanuelli, n.1 00143 Rome Italy Phone: +39 06 51 29 61</p>
<p><b>Netherlands</b></p> <p>AMO Netherlands B.V. Kantoorgebouw La Residence Weverstede 25 3431 JS Nieuwegein The Netherlands Phone: +31 (0)30 600 8787</p>	<p><b>Norway</b></p> <p><i>Distributor</i> Advanced Medical Optics Norway AS c/o Advanced Medical Optics Norden AB Kanalvagen 3A SE 194 61 Upplands Vasby Sweden</p>
<p><b>Poland</b></p> <p><i>Distributor</i> Oko-Vita Polska sp.z.o., ul Marywilska 34, 03-228 Warsaw, Poland</p>	<p><b>Portugal</b></p> <p>Advanced Medical Optics Spain S.L. sucursal em Portugal Praca Nuno Rodreguez dos Santos nº 7, 1600-171 Lisboa Portugal</p>
<p><b>Russia</b></p> <p><i>Distributor</i> Tradomed Ltd., Marksistskaya Str. 3, Bld 1, Moscow, 109147, Russia</p>	<p><b>Spain</b></p> <p>Advanced Medical Optics Spain, S.L. c/Dr. Zamenhof, n. 22, 4B 28027 Madrid Spain Phone: +34 9176 88 000</p>

<b>Sweden</b> Advanced Medical Optics Norden AB Kanalvagen 3A SE 194 61 Upplands Vasby Sweden	<b>Switzerland</b> <i>Distributor</i> AMO Switzerland GmbH, Churerstrasse 160 B, CH-8808 Pfäffikon, Switzerland
<b>United Kingdom</b> AMO United Kingdom Ltd Jupiter House Mercury Park Wooburn Green High Wycombe Buckinghamshire HP10 0HH United Kingdom Phone: +44 1628 551600	

### RoHS (Restriction of Hazardous Substances)

For Chinese Regulation: Administrative Measure on the Control of Pollution Caused by Electronic Information Products

**Table 3.2 – Names and Content of Toxic and Hazardous Substances or Elements**

Parts Name	Toxic and Hazardous Substances or Elements					
	Pb	Hg	Cd	Cr6+	PBB	PBDE
Housing	x	o	o	x	o	o
Power Supply	x	o	o	x	x	x
Motherboard	x	o	o	o	x	x
Rear Panel Assembly Board	x	o	o	x	x	x
Pneumatics	x	o	o	x	o	o
LCD	x	x	o	o	x	x
Base Unit	x	o	o	o	x	x
Fluidics	x	o	o	x	o	o
o: Indicates that this toxic or hazardous substance contained in all of the homogeneous materials for this part is below the limit requirement in SJ/T11363-2006						
x: Indicates that this toxic or hazardous substance contained in at least one of the homogeneous materials used for this part is above the limit requirement in SJ/T11363-2006 (Enterprises may further provide in this box technical explanation for marking "X" based on their actual conditions.)						



---

**Setup Sequence –  
Anterior Segment  
Surgery**

The following is a general overview of the steps to be taken to prepare the WHITESTAR SIGNATURE™ System for surgery:

1. Connect the WHITESTAR SIGNATURE™ System power cord to the rear of system. Plug the power cord into a grounded power outlet.
2. Connect the footpedal to the rear panel receptacle.
3. Connect the compressed air line to the compressed air receptacle (optional).
4. Turn the system On at the back of the console.
5. Press the On/Off button on the Touch Screen monitor.
6. After completion of the Start Up Self Test, select the surgeon and program.
7. Install the tubing cassette, attach the required accessories (phaco, vitrectomy or diathermy handpieces) and set up the tubing.
8. Prime and tune the handpieces. (Refer to Chapter 4, Equipment Operation, *Prime/Tune.*)
9. Perform the final test of the fluidics and the handpiece integrity with the footpedal. (Refer to Chapter 4, Equipment Operation, *Verify Irrigation/Aspiration Balance.*)

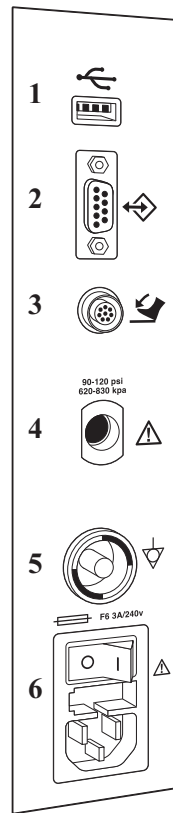
**Figure 3.1 – Rear Panel Connections**

1. USB Port
2. Communications Port
3. Foot Pedal Connector

4. Compressed Air
5. Potential Equalizer
6. Power Switch and Power Cord Connection

### Phacoemulsification Ultrasonic Handpiece



**WARNING:** Sterility assurance is the responsibility of the user. All non-sterile accessories must be sterilized prior to use.



**WARNING:** Prior to using any invasive portions of the handpiece assembly, examine under the microscope for any obvious damage, oxidation, or the presence of foreign material. If any questionable characteristics are noted, use a backup handpiece for surgery. Use of contaminated or damaged system accessories can cause patient injury.

1. Use caution to prevent burns when handling the handpiece directly from sterilization.
2. Remove the tubing cassette and accessories from the tubing pack and place them in the sterile area.

3. Assemble the phaco handpiece as shown below. You need the handpiece, titanium phaco tip, the appropriate tip wrench, one of the infusion sleeves and the test chamber.



**CAUTION: NEVER ATTEMPT TO STRAIGHTEN A BENT NEEDLE. THIS MIGHT PRODUCE A BROKEN TIP WHEN ULTRASOUND IS APPLIED.**

**Figure 3.2 – Phaco Handpiece Assembly**

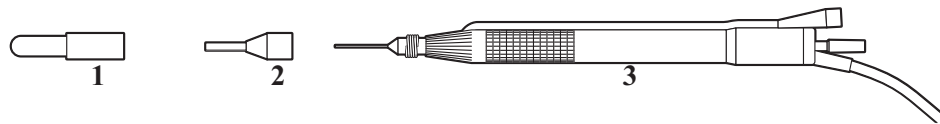

1. Test Chamber
2. Infusion Sleeve
3. Handpiece with Tip

4. Attach the connector end of the handpiece to the phaco receptacle on the front of the WHITESTAR SIGNATURE™ System. **Make sure there is no moisture on the connectors prior to connecting. Moisture prevents the handpiece from operating properly.**

**Figure 3.3 – Ellips™ Handpiece**

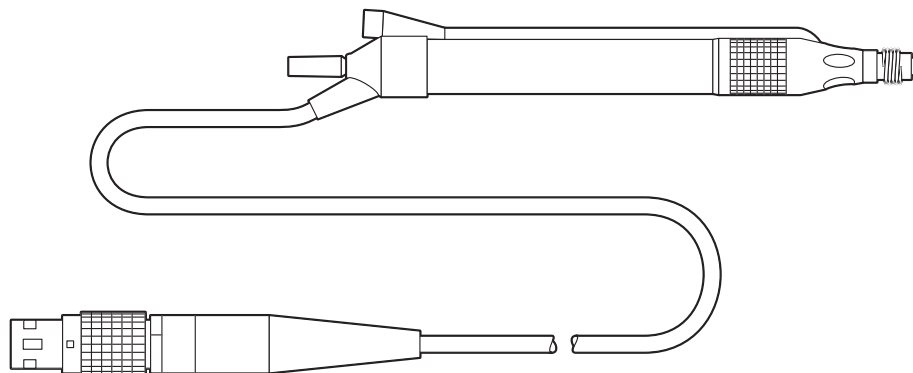

Note: The Ellips™ handpiece can be used with WHITESTAR® Technology and Ellips™ Technology phaco settings.

## Irrigation/Aspiration Handpiece

1. Assemble the SOLO™ Irrigation/Aspiration (IA) Handpiece by attaching the infusion sleeve.

Note: The infusion sleeve and the test chamber are provided in the FUSION™ Tubing Pack. The LAMINAR™ Flow 20 ga. infusion sleeves can also be used and are available with the OPOS20L or any 20 ga. LAMINAR™ Phaco Tip.

**Figure 3.4 – IA Handpiece Assembly**

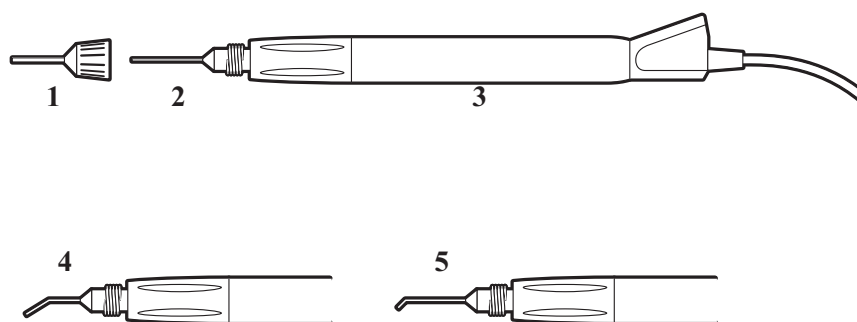

- |                       |                                  |
|-----------------------|----------------------------------|
| 1. Infusion Sleeve    | 4. SOLO™ Curved Tip              |
| 2. SOLO™ Straight Tip | 5. SOLO™ 45° Silicone Sleeve Tip |
| 3. Handpiece          |                                  |

## Load the FUSION™ Tubing Cassette

1. Open the tubing pack packaging.
2. Install the FUSION™ cassette into the side receptacle, as shown below.
3. Make sure that the drainage bag is properly attached to the cassette.

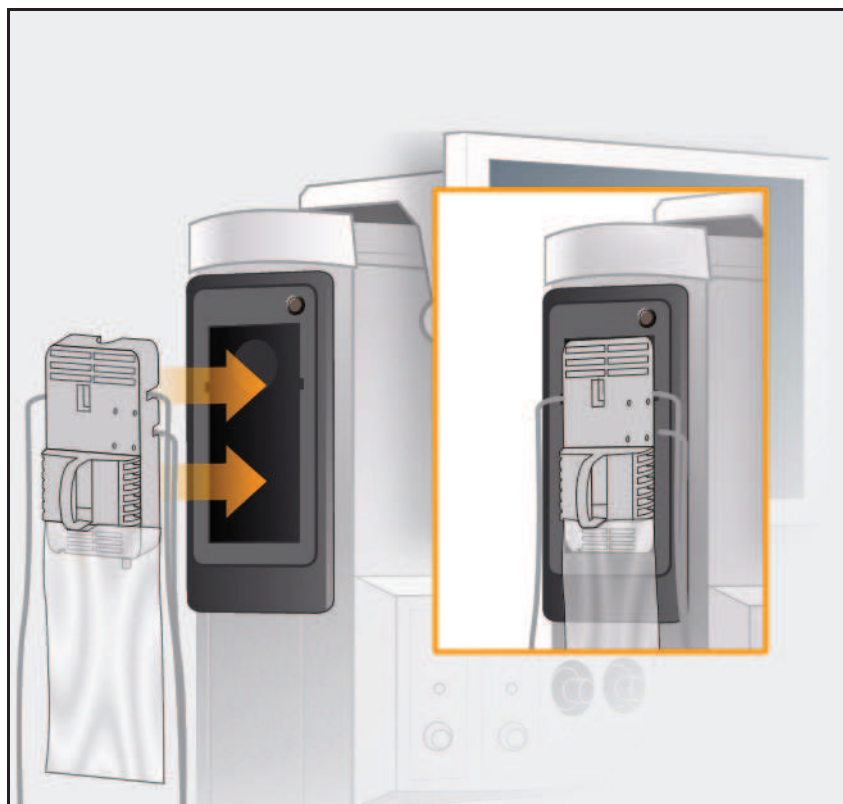
**Figure 3.5 – Loading the FUSION™ Tubing Cassette**

Note: Press the button above the cassette to remove the cassette.

### Setup Completion

**IMPORTANT!** Before you insert the spike into the bottle, shake the irrigation drip chamber at the end of the irrigation tubing to confirm that the irrigation valve moves. If the valve does not rattle, the valve cannot operate properly and irrigation cannot flow.

1. Place a new bottle of balanced salt solution on the top of the system console.
2. Insert the drip chamber spike into the balanced salt solution bottle.
3. Hang the balanced salt solution bottle from the Programmable IV Pole and squeeze the drip chamber.
4. Fill the drip chamber with fluid to the half-full level. The Programmable IV Pole moves to the appropriate height automatically.
5. Raise or lower the pole if needed. Use the IV pole **Up** and **Down** arrows on upper right of the touch screen. You can also use the Up/Down switch on the console.

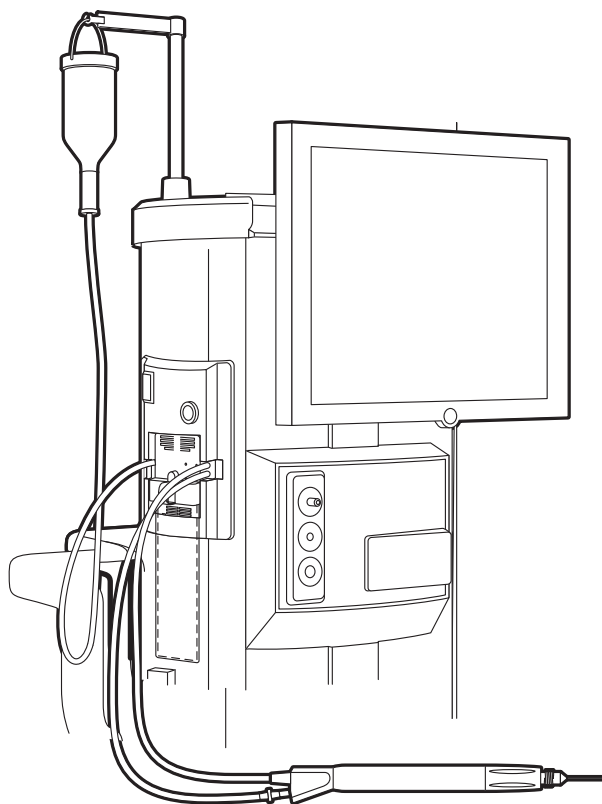
**Figure 3.6 – System Setup**

6. Connect the IA tubing to the desired handpiece.
7. Insert the male luer end of the irrigation tubing into the phaco handpiece.
8. Attach the female luer fitting end of the aspiration tubing to the phaco handpiece.

Note: To protect the patient from contamination, use only:

- sterile tubing sets
- sterile irrigation fluid
- sterile handpieces

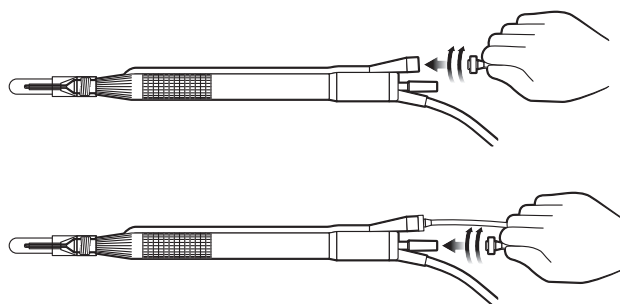
**Figure 3.7 – Phaco Handpiece Connections**

## Diathermy

1. Connect the diathermy cord to the Diathermy Forceps or Pencil Probe.
2. Connect the diathermy cord to the diathermy receptacle on the front panel.

**Figure 3.8 – Diathermy Forceps**

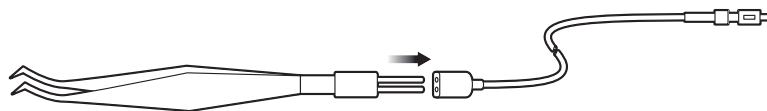

**Figure 3.9 – Diathermy Pencil**



Note: Other diathermy accessories are regionally available. Contact your AMO representative.

## Vitrectomy

If vitrectomy is indicated during surgery:

1. Connect the AMO™ Vitrectomy Cutter as shown below. Vitrectomy requires the following components:
  - IA Tubing (from FUSION™ Tubing Cassette)
  - Vitrectomy Cutter
  - Vitrectomy Infusion Sleeve, or a 23 Gauge Limbal Infusion Needle, if desired.
2. Assemble the handpiece using the instructions provided with the vitrectomy cutter.

**Figure 3.10 – Vitrectomy Cutter**

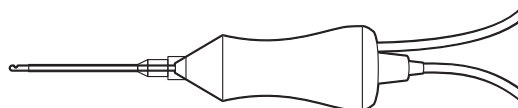

3. Attach the connector end of the vitrectomy cord to the vitrectomy receptacle on the front panel.

## Pre-Operative Sterilization

The Instrument Sterilization Procedures in Chapter 9, “Care and Cleaning” identify the WHITESTAR SIGNATURE™ System instruments that must be sterilized prior to each surgical case. The recommended sterilization techniques, times and temperatures are given in Chapter 9, “Care and Cleaning”. AMO recommends that you follow the sterilization guidelines to maximize the life of your WHITESTAR SIGNATURE™ System instruments.

## Footpedal

The footpedal controls all of the WHITESTAR SIGNATURE™ System functions, therefore, it is essential that you understand the footpedal operation.

The System software automatically detects if a footpedal and what type of footpedal is connected during power up.

The footpedal settings and adjustments can be selected and preset for the footpedal in the Configuration screen. Instructions for the footpedal settings are given in Chapter 5, “Anterior Segment Surgery Operating Modes”. The footpedal housing incorporates a handle, making the footpedal easy to grip for repositioning and storage.

The Footpedal cable attaches to the footpedal connector on the rear of the console. The Advanced Control Pedal (dual linear) can also be setup with a wireless connection.

Note: You must **NEVER** handle the footpedal by the cable.



**WARNING:** Use only NiMH type batteries in the wireless Advanced Control Pedal.

**Figure 3.11 – Footpedal - Single Linear**

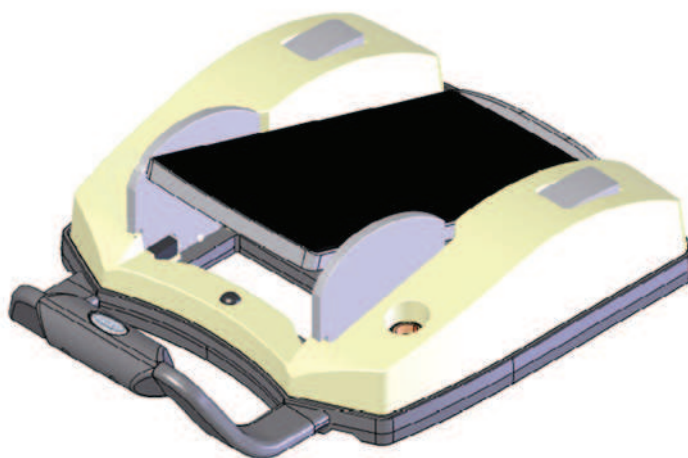

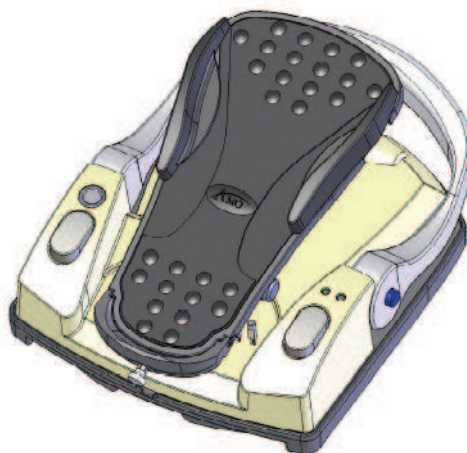

**Figure 3.12 – Footpedal - Advanced Control Pedal (Dual Linear)****Footpedal Operation**

The footpedal has three active “PITCH” ranges, which are referred to as Positions 1, 2 and 3. Position 0 is the Off position, and Position 3 is the fully pressed position. The ranges are shown below. The Advanced Control Pedal has two Yaw switches.

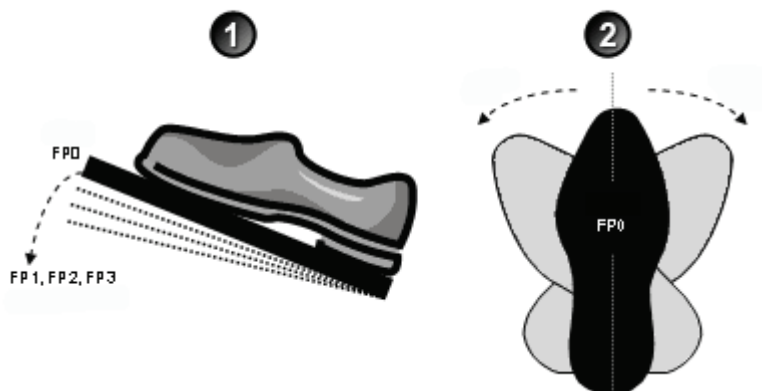
**Figure 3.13 – Footpedal “Pitch” and “Yaw” Positions**

1. Pitch  
Toe Down/Up  
Configurable Ranges

2. Yaw  
Toe Right/Left  
Configurable Ranges

The footpedal position determines the function that is delivered by the handpiece, which depends on the mode selected on the touch screen. When the footpedal has been connected, place your foot on the pedal and press to the desired position. The footpedal settings and programming are addressed in Chapter 5, “Anterior Segment Surgery Operating Modes”.

Note: Four to six minutes after the system is shutdown and power is turned off, the wireless footpedal goes into a power-save mode. To turn on the Wireless Footpedal after you start up the system, touch the **Wake-up** button.

### **Reflux**

Reflux is the controlled backflow of fluid through the aspiration port of the handpiece. Reflux is used to gently release or dislodge unwanted material from the handpiece tip. Reflux can also be used to “tent” the incision site to allow easier tip insertion. Reflux pressure depends on bottle head pressure (IV pole height and gravity) for the FUSION™ Fluidics pack (OPO70), and as such, is not intended to clear a clogged handpiece. However, reflux can be used to identify a blockage.

The reflux action can be programmed on any available footpedal switch. When Reflux is activated, the system reverses the peristaltic pump. This causes fluid to be expelled from the aspiration line into or towards the eye.

The reflux is active until the footpedal switch is released.

The FUSION™ Fluidics pack (OPO70):

- allows an inter-connection of the irrigation line to the aspiration line, so that sterile balanced salt solution can enter the aspiration line.
- has no time restriction for Reflux as there is no pump reversal

The DP pack (OPO71):

- includes support for the vacuum tank used in the Venturi vacuum system
- does not support inter-connecting the irrigation line to the aspiration line. Therefore, only previously aspirated fluid is being refluxed.

## Programmable IV Pole

The Programmable IV Pole is controlled by the **Up** and **Down** arrows on the upper right of the touch screen, next to the bottle height indicator. The buttons on the remote control and the switch on the side of the console can also be used to control the IV Pole. These controls are used to raise and lower the pole, and the height is indicated in the Programmable IV Pole screen. The Programmable IV Pole moves at a rate of approximately 6 cm (2 inches) per second.

The Programmable IV Pole is adjustable from 0 to 104 centimeters, and can be set for either inches or centimeters. The height measurement is relative to the distance from the irrigation valve to the center of the drip chamber. The Programmable IV Pole height for each fluidic mode or submode (PHACO, IA, VIT) is saved in the WHITESTAR SIGNATURE™ System memory. A Maximum IV Pole height can be set on the Diagnostics screen.

When a surgery mode is selected, the Programmable Power IV Pole automatically moves to the preset height. To manually adjust the IV pole height, use the **Up** and **Down** arrows on the touch screen. Manual adjustments to the IV pole can also be made by pressing the rocker switch located on the side of the console. If a maximum height has been set, the IV pole will not move above that height.

## Wireless Remote Control (Optional)

The wireless remote control keypad can be used to operate the WHITESTAR SIGNATURE™ System. All Modes, Programs, Diagnostics and End Case can be accessed and adjustments to the settings can be made with the remote control. The buttons on the remote keypad work the same as the controls on the WHITESTAR SIGNATURE™ System touch screen.

**Figure 3.14 – Wireless Remote Control Module**

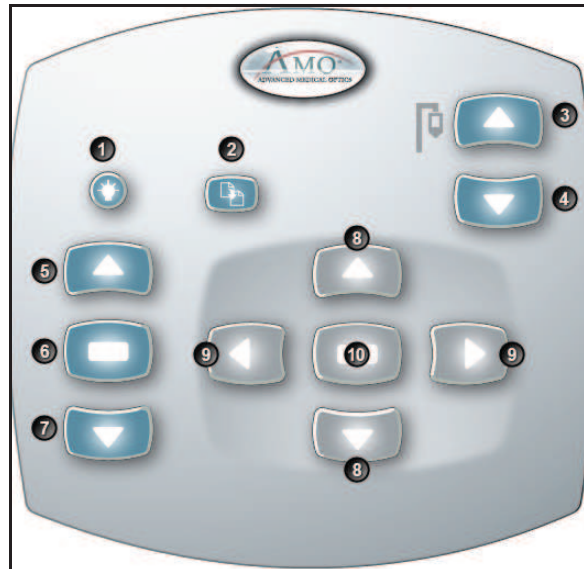

- |                        |                          |
|------------------------|--------------------------|
| 1. Remote Backlight On | 6. Mode Select           |
| 2. Reload              | 7. Mode Down             |
| 3. IV Pole Up          | 8. Navigation Up/Down    |
| 4. IV Pole Down        | 9. Navigation Left/Right |
| 5. Mode Up             | 10. Select               |

When not in use, store the Wireless Remote Control on the top of the system to charge the batteries.

After you turn the system On, press the Remote Control Backlight button to activate the Remote Control. When the system is Off the Remote Control is in a power save mode.

**Note:** After four to six minutes of idle time, the Remote Control goes into a power-save mode. To turn the Remote Control on, press the Backlight button.

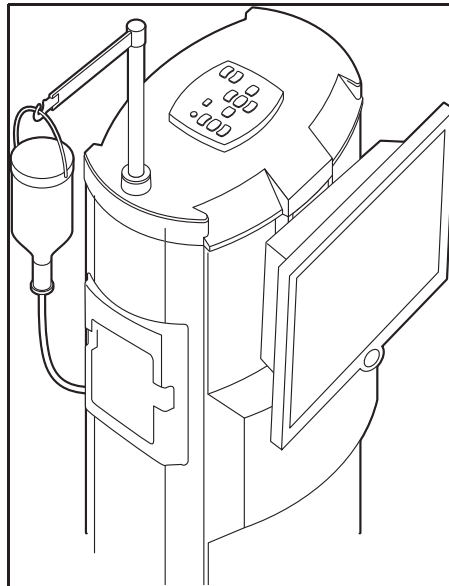

**WARNING:** DO NOT try to replace the Wireless Remote Control batteries. Call your AMO Technical Service representative to replace the batteries.

**Figure 3.15 – Wireless Remote Control Module Storage****Surgical Media Center (SMC) (Optional)**

The Surgical Media Center (SMC) is used to record the surgery and the instrument settings to be viewed at a later date and time. The surgery is displayed on a monitor with the instrument settings. The SMC hardware is connected to your WHITESTAR SIGNATURE™ System Communications port on the rear panel. (See Figure 3.1 Rear Panel Connections.)

1. To configure the Surgical Media Center, select:
  - **Configuration**
  - **System Configuration**
  - **SMC**

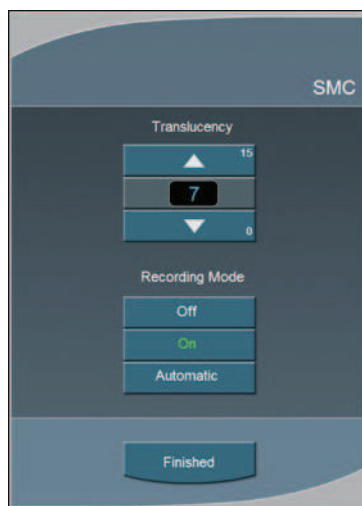
**Figure 3.16 – Surgical Media Center Pop-up Window**

- Use the **Up** and **Down** arrows to adjust the settings. **Translucency** is used to make the overlay (instrument settings) more or less opaque.

Note: Press on the number in the control panel to open a numeric keypad and enter the required value. Press **Enter** on the Keypad pop-up window when you are finished.

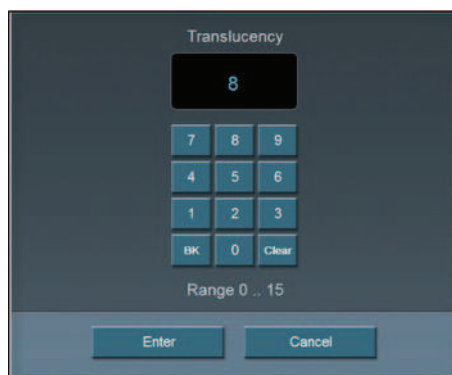
**Figure 3.17 – Numeric Keypad Pop-up Window**

- Select the **Recording Mode**. **Off**, **On**, or **Automatic**. If the **Recording Mode** is **On**, the recording continues between cases. **Automatic** stops recording between cases.

Note: The Footpedal Switch can be set up to activate the SMC Record function.

- Press **Finished** to close the pop-up window.

**Shutdown Sequence  
– Anterior Segment  
Surgery**

The following is a general overview of the steps to be taken to shut the System down after surgery:

1. Select **End Case**.
2. Select **Shutdown**. At the prompt, select **Yes**.
3. Wait for shutdown sequence to complete.
4. Turn the system Off at the back of the console.
5. Remove the power cord from the power outlet.
6. Wrap the excess power cord neatly around the cord wrap on the back of the console.
7. Place the footpedal in the storage area on the console.
8. Place the Wireless Remote Control on top of the console to charge.
9. Refer to Chapter 9, “Care and Cleaning”, *Cleaning Procedures* for additional information.





# 4

## EQUIPMENT OPERATION

---

Display Screens and Controls

---

Language Selection

---

Startup

---

Select Program and Install the FUSION™ Tubing Cassette

---

Prime/Tune

---

Verify Irrigation/Aspiration Balance

---

Priming for Vitrectomy

---

Selecting and Changing Mode Parameters

---

## Display Screens and Controls

The touch screen is designed to give you visual indication of the status of the control systems at all times. When a mode (DIA, PHACO, IA, or VIT) is selected, the current settings are shown on the screen. As adjustments to settings are made, the screen shows the changes. The screens and controls are shown below.

Each Anterior segment surgery mode and submode has their own distinct screen setup:

- Irrigation/Aspiration
- Phaco without OCCLUSION MODE™
- Phaco with OCCLUSION MODE™ and/or CASE (FUSION™ MODE)
- Phaco with Ellips™ technology
- Vitrectomy
- Diathermy

**Figure 4.1 – PHACO Screen**

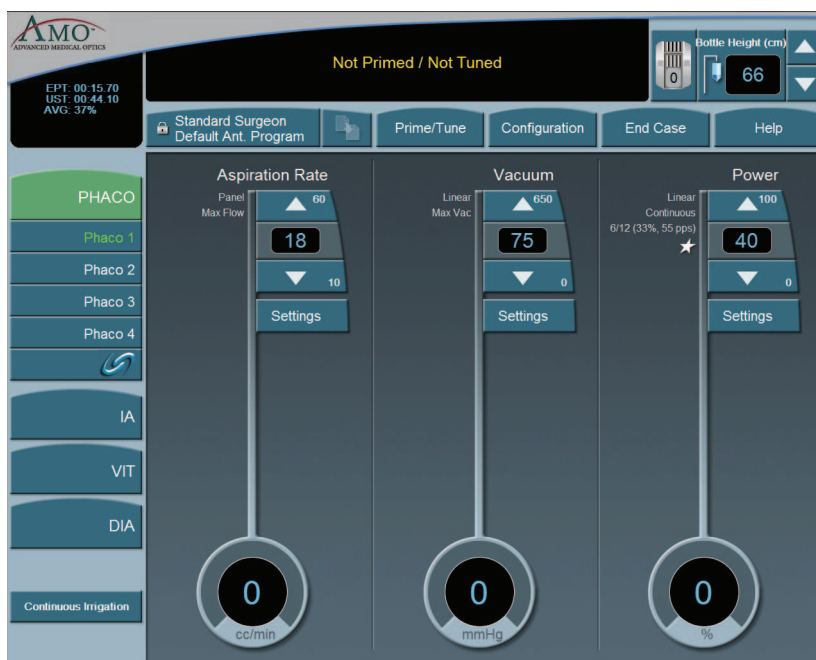

Additionally, there are screens or sub-screens for:

- Prime/Tune
- End Case
- Program
- Sounds
- Footpedal
- Database
- Diagnostics

## Language Selection

The WHITESTAR SIGNATURE™ System features a 17-language user interface. Before you proceed, select one of the languages for your touch screen and controls. (English is the default language).

1. To access the **Select Language** screen, from the main screen, select:
  - **Configuration**
  - **System Configuration**
  - **Language**
2. Select the desired language from the listing.
3. Press **Yes** at the confirmation pop-up. The screen automatically changes to the selected language.
4. Press **Exit Settings** to proceed with the selected language.

**Figure 4.2 – Language Screen**



Note: On any screen, if you press the screen about 25 times, the System changes to the default language (English). You must press the same spot on the screen.

## Startup

After you have turned on the WHITESTAR SIGNATURE™ System, the system performs a series of Self Tests.

**Figure 4.3 – Self Test**

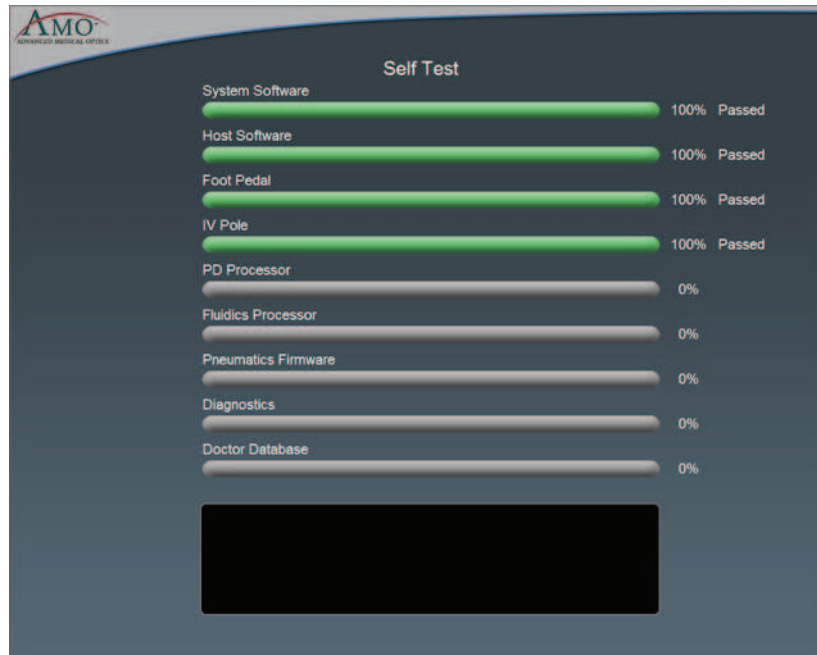

After start up, the screen shows the available Surgeons and Programs that can be selected.

You can now select a Surgeon and a Program. A Program (or Surgeon Name) is a set of pre-established operating settings for each operating mode. The WHITESTAR SIGNATURE™ System allows you program up to a maximum of 50 Surgeon names, and 20 customized surgeon setups (programs) for each surgeon.

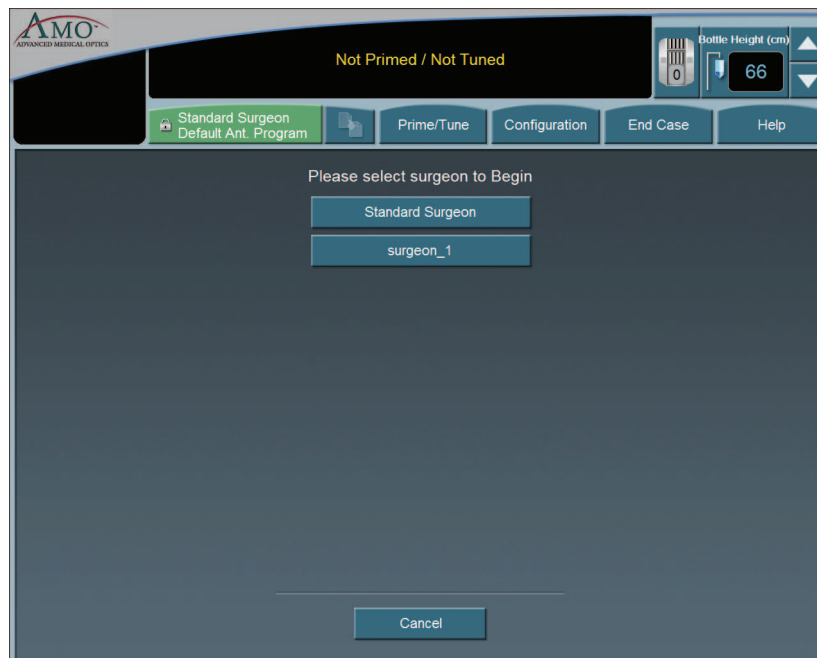
**Figure 4.4 – Select Surgeon Screen**

If Standard Surgeon is the only surgeon set up, this screen is not shown, and the System proceeds immediately to the tubing cassette installation screen.

From the Main Menu you can:

- Select a **Surgeon/Program** and begin surgery based on the values of that program
- Enter the **Settings** (Configuration) page, where you can edit, add, or delete programs and setup operating parameters
- Enter the **End Case** screen (Refer to Chapter 5, Anterior Segment surgery Operating Modes, *End Case*.)

## Select Program and Install the FUSION™ Tubing Cassette

After you select a surgeon, you must select a program from the surgeon's available programs. If this is the first time the system has been used, **AMO Default Program** is the only program that appears on the screen. The first program you create uses the **AMO Default Program** settings as a starting point. You can modify the settings and **Save As** a specific program or surgeon name. The system does not let you overwrite the **AMO Default Program** when you press **SAVE**.

If a surgeon only has one program set up, this screen is not shown, and the System proceeds immediately to the tubing cassette installation screen for the type of program that is set up for that surgeon. The System automatically recognizes the type of tubing cassette that is installed.

Note: An asterisk next to a program name indicates that the surgeon as selected that program as their default program.

**Figure 4.5 – Select Program Screen**

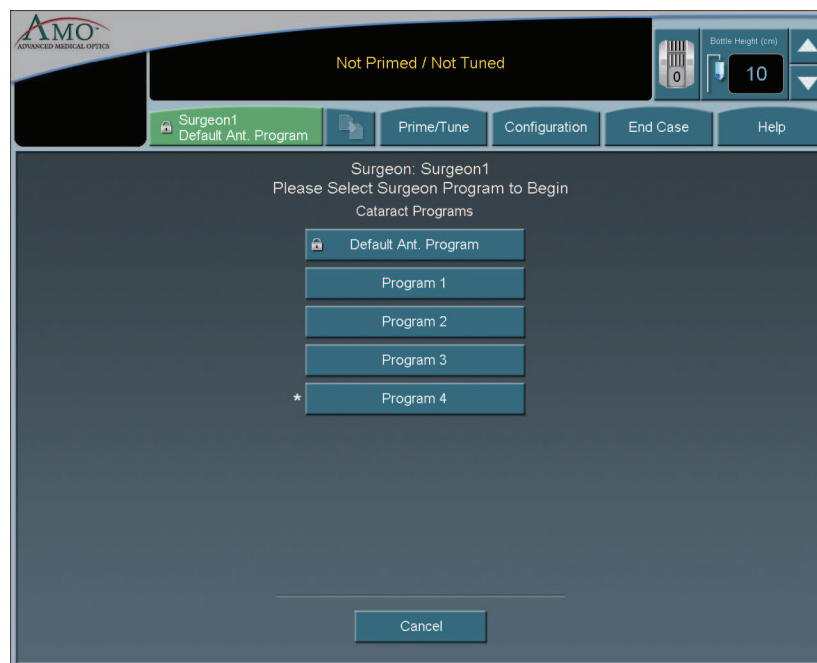
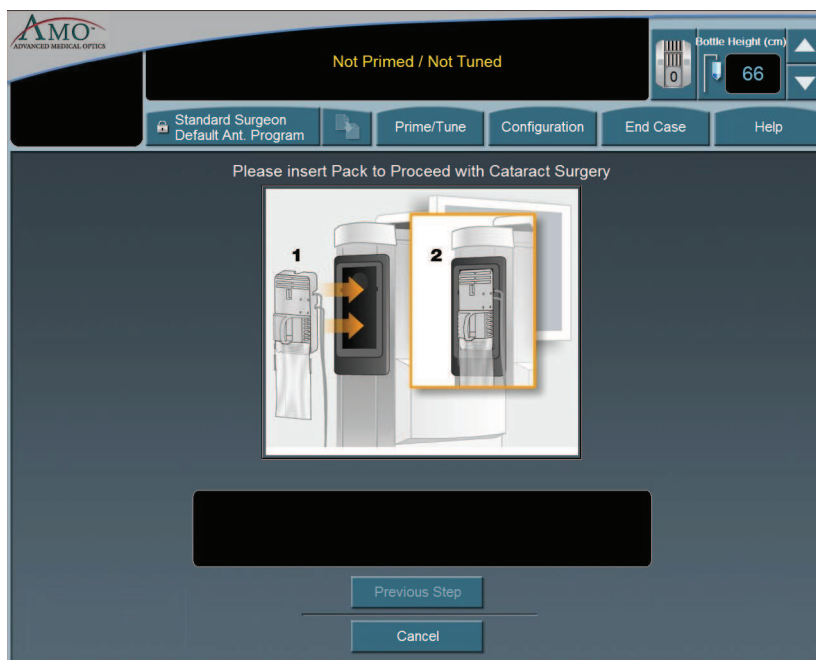

Figure 4.6 – Install Cassette Screen



## Prime/Tune

**Prime/Tune** is required before surgery is performed to fill the IA tubing with fluid, perform a vacuum check and to test and characterize the phaco handpiece. You must Prime and Tune:

- before each procedure
- anytime the handpiece is reconnected
- after you have inserted or replaced a tubing cassette

**Continuous Irrigation** can be selected to allow fluid to free flow from the bottle in order to collect fluid.

Note: Before you Prime and Tune, the Cup Fill feature can be used to fill cups. Use the **Up** and **Down** arrows to set the amount needed, either 30, 60 or 90 cc, to fill the cup and then press **Start**. The Cup Fill stops when the selected amount is dispensed or **Stop** is pressed. You can still use Continuous Irrigation to fill cups.

IA Prime is designed for a procedure that does not require a phaco handpiece. Tune is designed for a quick tune of the phaco handpiece with an IA tubing set. Tune can be used if a phaco tip is replaced during a procedure.

When you **Bypass** prime the overall fluidics prime sequence is shortened and the time to prime the WHITESTAR SIGNATURE™ System is reduced. **Bypass** can be used if **Continuous Irrigation** has been used or the I/A tubing was primed. If the I/A tubing was not properly primed, errors can occur.

To access the Prime/Tune routines, press the **Prime/Tune** button. The main console shows the Prime/Tune screen with all prime and tune options.

Note: Prime/Tune is a combination of Tune followed by IA Prime.

**Figure 4.7 – Prime and Tune Screen**

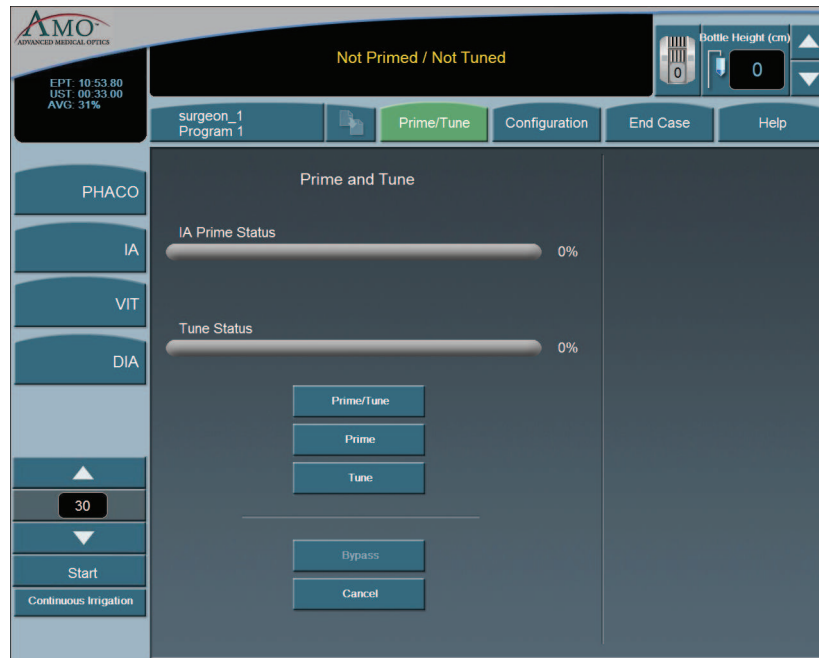

The WHITESTAR SIGNATURE™ System tracks the successful completion of the Prime and Tune cycle independently. In the event a retune is required (new tip, failed tune), only the **Tune** needs to be selected and run.



**CAUTION: THE PHACO HANDPIECE AND VITRECTOMY CUTTER MUST NEVER BE ACTIVATED WITH THE TIP IN THE AIR. EXPOSURE OF THE TIP TO AIR DRASTICALLY REDUCES THE USEFUL LIFE OF THE HANDPIECE. IF POWER IS TO BE INTRODUCED TO THE PHACO HANDPIECE OR VITRECTOMY CUTTER, THE TIP MUST BE IN A TEST CHAMBER FILLED WITH BALANCED SALT SOLUTION, IN A CONTAINER OF BALANCED SALT SOLUTION OR IN THE PATIENT'S EYE.**

#### **Suggestions for Priming the Handpieces**

Always fill the test chamber completely prior to running the Prime/Tune Cycle.

Do not lay the handpiece and the empty test chamber down and have the system fill the test chamber. This allows air to collect in the test chamber and can produce an error.

To collect the balanced salt solution:

1. Use the test chamber, a medicine cup, or similar container.



2. Use the **Up** and **Down** arrows to increase or decrease the amount of the fluid needed.
3. Press **Start** to turn on Cup Fill.
4. Use **Stop** to turn off Cup Fill before the requested amount of fluid is dispensed.
5. Perform a full Phaco Prime/Tune.

The **Prime/Tune** screen indicates the progress of the priming process.

1. Use the Cup Fill feature to fill the test chamber with fluid and to eliminate all air. If the test chamber is attached to the handpiece, remove the test chamber before you start the Cup Fill process.
2. Place the test chamber over the handpiece tip and the sleeve hub.
3. Press the **Prime/Tune** button, this starts the Prime and Tune sequences.
  - To perform a Prime only, press the **Prime** button.
  - To perform a Tune only, press the **Tune** button.
4. Make sure the movement of the IV pole is not blocked by low ceilings.
5. Watch the fluid fill the drip chamber. The fluid moves toward the handpiece and fills the test chamber.
6. The touch screen indicates the progress of the Prime and Tune process.
7. As the tubing lines are filled, the system software performs functional checks. The checks include:
  - Monitoring for the presence of irrigation flow (bottle height)
  - Leaks (via vacuum rise checks)
8. If the phaco handpiece is plugged in and **Prime/Tune** or **Tune** was selected, the system automatically includes a handpiece tuning test concurrently with the prime cycle.
  - At the end of the priming sequence, the WHITESTAR SIGNATURE™ System makes an audible sound to indicate that Prime process is complete.
  - At the end of the phaco tuning test, the WHITESTAR SIGNATURE™ System makes an audible alert sound to indicate that tune process is complete.
9. To discontinue Prime or Tune during the process, select **Cancel**.
10. When Prime and Tune are complete, the system automatically proceeds to the preprogrammed submode or Phaco 1 operating mode. It is important that you verify the IA balance prior to operating.

## Verify Irrigation/ Aspiration Balance

We strongly recommend verifying that Irrigation/Aspiration is balanced properly for the settings to be used in surgery.

**Figure 4.8 – Irrigation/Aspiration Balance Procedure**

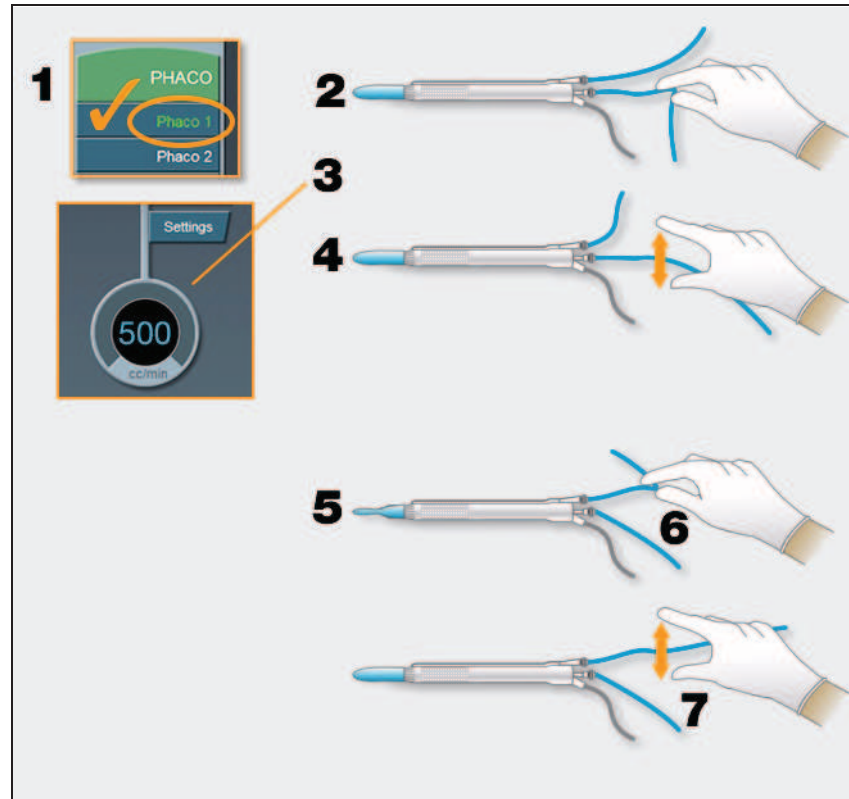

To verify Irrigation/Aspiration balance:

1. In PHACO 1 mode, hold the handpiece at approximate patient eye level.
2. Occlude the aspiration line just below the handpiece, while you press and hold the footpedal in position 2. Make sure the footpedal is connected. (Refer to Chapter 3, System Setup, *Footpedal*.)
3. The actual vacuum level should rise to the preset level.
4. Release the aspiration line and watch the test chamber to make sure that the test chamber does not collapse. A slight shallowing of the test chamber is normal.
5. If the test chamber collapses, raise the IV bottle height or lower the vacuum setting.
6. Pinch the irrigation tubing at the handpiece and watch for the test chamber to collapse.
7. Release the irrigation line and the test chamber should fill.
8. Press **Reset** in the upper left corner of the screen to open the Reset Timers pop-up window. Press **Yes** to rest the timers. You are now ready to begin surgery.

## Priming for Vitrectomy

Before you perform vitrectomy, we recommend you prime the handpiece in order to reduce the chance of errors. Each time you select vitrectomy mode you are prompted to prime the vitrectomy handpiece. If you do not need to prime, press **Bypass**.

To prime the handpiece:

1. Attach the irrigation and aspiration cassette pack tubing together.
2. Press **Prime** on the Prime/Tune screen.
3. Press the **VIT** button to enter **VIT** mode.
4. Follow the instructions on the screen.
5. Press **Start Vit Prime**. The screen closes automatically when the handpiece is primed.

Note: If you must perform vitrectomy in the middle of phaco surgery, perform steps 3 through 5.

**Figure 4.9 – Vitrectomy Prime Procedure**

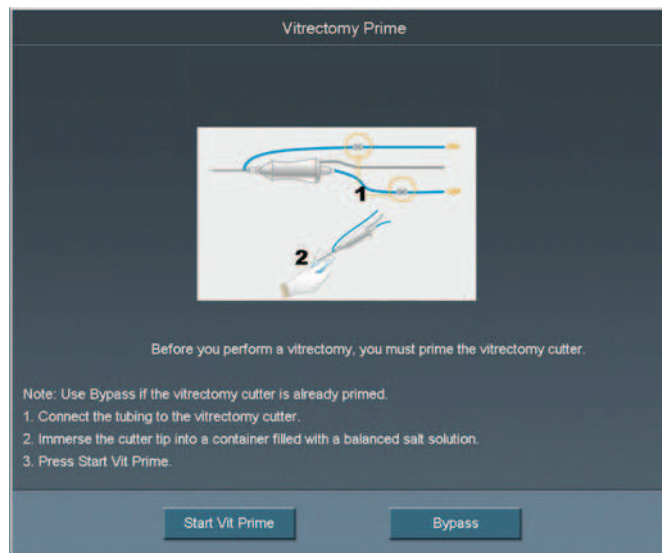

## Selecting and Changing Mode Parameters

The system's graphical user interface (GUI) and touch screen is designed for ease-of-use, consistent application and maximum informational display during all operating modes.

Your interface with the system requires only three basic steps, which apply to all of the selections, settings and operations. Once this basic organization is understood, you can move quickly and easily through all of the system functions and operations.

The touch screen is organized into panels. The top panel shows current status, configuration options, the bottle height, and the footpedal icon. The left-side column lists the operating modes and submodes. The main panel that dominates the screen shows current operating levels for aspiration, vacuum and power.

- To switch operating modes or submodes, press a button in the left panel. The control panels in the main panel show the operating levels for that mode.
- To make basic changes to the settings, press the **Up** and **Down** arrows to increase or decrease a value.

**Note:** Press on the number in the **Settings** control panel to open a numeric keypad and enter the required value. Refer to Figure 3.17 Numeric Keypad Pop-up Window. Press **Enter** to close the Keypad window.

- To change other control panel settings, such as **Panel** or **Linear** power, press the **Settings** button on that control panel. A **Settings** window opens, and you can make your selections.

**Figure 4.10 – PHACO Mode Screen**

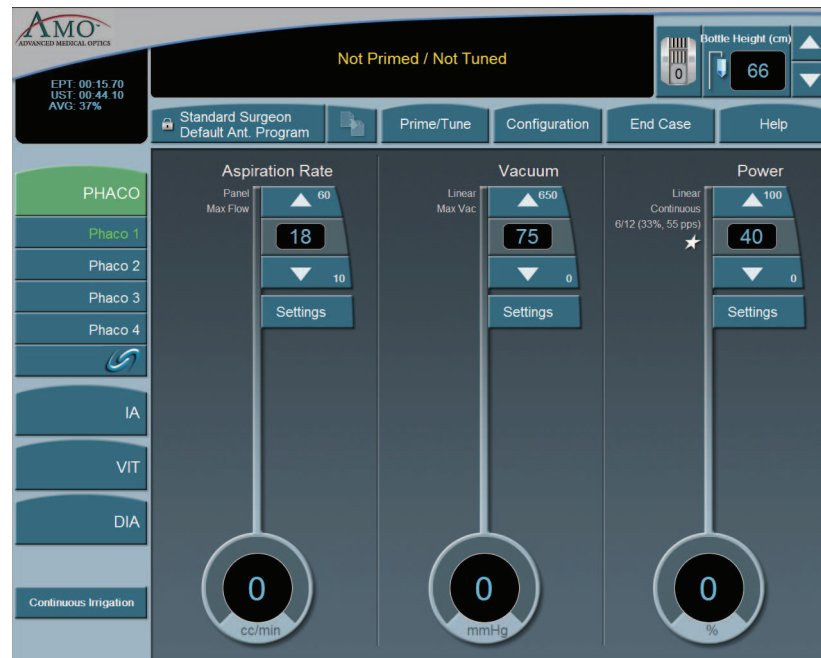

- To make overall changes to a program, press **Configuration** on the top panel.

Figure 4.11 – Configuration Pop-up Window

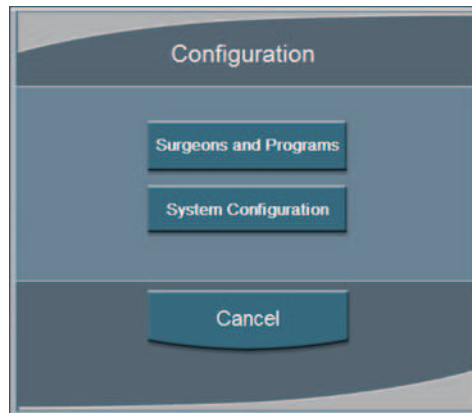

- Press **Surgeons and Programs** to access surgeon names and their associated program setups.

Figure 4.12 – PHACO Submode Configuration Screen





# 5

## ANTERIOR SEGMENT SURGERY OPERATING MODES

---

Operating Mode Descriptions

---

Fusion™ Fluidics Phaco

---

Programming the Modes and Settings

---

Anterior Segment – Recommended Settings

---

OCCLUSION MODE™ Phaco Settings

---

Passive Reflux

---

Ellips™ Technology

---

## Operating Mode Descriptions

### Diathermy

While the system is priming, you can select the Diathermy (**DIA**) mode (a function which does not require irrigation and aspiration flow) and perform Diathermy procedures. This process is referred to as a Diathermy during Prime.

**Figure 5.1 – Diathermy Mode Screen**



If Diathermy is selected during Prime, the screen indicates the Prime/Tune status and any messages associated with the prime and/or tune.

The WHITESTAR SIGNATURE™ System provides power for bipolar coagulation or diathermy. The amount of diathermy power is shown on the Diathermy screen. If **Panel** power is selected, you can increase or decrease power by pressing the **Up** or **Down** arrows on the Power control panel. If the **Linear** mode is selected, the power is controlled with the footpedal up to the maximum preset value.

**Note:** Press on the number in the **Settings** control panel to open a numeric keypad and enter the required value. Refer to Figure 3.17 Numeric Keypad Pop-up Window. Press **Enter** when you are finished.



Figure 5.2 – Prime/Tune in Diathermy Mode

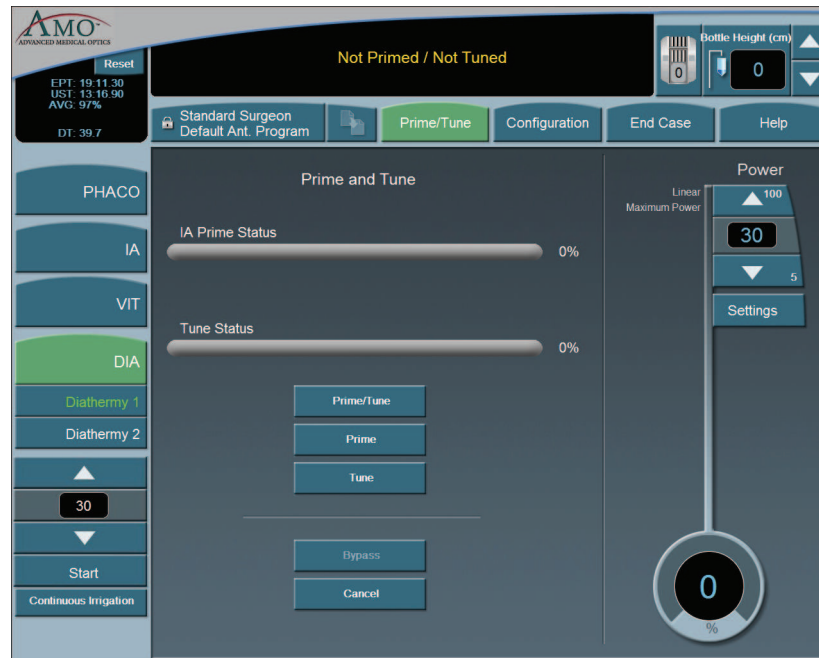

### Using Diathermy

To begin Diathermy:

1. On the left panel press **DIA**.
2. Press the desired DIA submode button (**DIA 1** is selected by default).

The elapsed DIA time is displayed in the upper left corner as “DT”.

In the main panel, you can increase or decrease the power by pressing the diathermy **Power Up** or **Down** arrows. If **Linear** power is selected, you can use the footpedal to increase or decrease the power up to the maximum preset value.

To change the power delivery, press **Settings**. The **Settings** window opens. Set the power delivery to **Panel**, **Linear** or **Burst**. Linear delivery is the default.

- **Panel** – Diathermy power is delivered consistently at the power level (%) selected and indicated on the screen as Panel Maximum Power.
- **Linear** – Diathermy power is delivered from 5% to the maximum selected value (Maximum Power) as the footpedal is pressed.
- **Burst** – Diathermy is delivered as a single 150 ms pulse, at the selected power, as the footpedal is pressed.

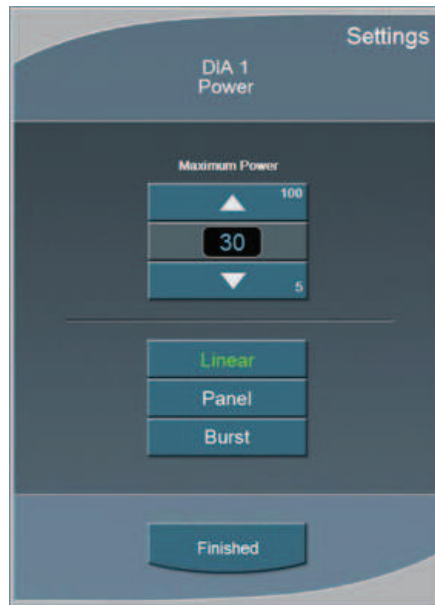
**Figure 5.3 – Diathermy Power Submode**

To set the submode parameters:

1. Make the desired settings to the **DIA 1** values
2. Press the **DIA 2** button to set the parameter values.
3. Change the parameter values for **DIA 2**.
4. After the submode (Program submode DIA 1, DIA 2) parameters are set, you can press another mode button in the left panel to program **PHACO**, **IA**, or **VIT** modes.
5. To access the **SAVE** buttons and save the submode settings, press **End Case** in the top panel if no other changes are needed and save the settings.

### **Irrigation/Aspiration**

Aspiration flow is necessary to remove the emulsified cataract material from the eye. An irrigation supply is necessary to replace fluid removed by aspiration of cortical material and fluid lost to leakage from the incision.

This fluid balance maintains the anterior chamber during surgery. Irrigation is controlled by gravity.

The flow rate of irrigation solution through the irrigation sleeve on the phaco tip is determined by the height of the drip chamber (head pressure). The drip chamber hangs from the bottle on the Programmable IV Pole. AMO recommends that at the start of a procedure, the irrigation solution level in the drip chamber be located approximately 65–70 cm above the patient's eye level. To increase irrigation pressure, the IV bottle is raised. To decrease pressure, the bottle is lowered.

The irrigation tubing runs through the tubing cassette and irrigation is controlled by the footpedal. When the footpedal is pressed, the pinch valve is opened and the irrigation fluid flows. Irrigation runs in footpedal Positions 1, 2 and 3.

To program IA submodes:

1. On the left panel, press **IA**.
2. Select the desired IA submode. **IA 1** is selected by default.
3. Press the **Up** or **Down** arrows in the control panels on the main panel to increase or decrease Aspiration Rate or Vacuum.

Note: If the Venturi pump is **On**, only the Vacuum Settings are shown. To turn the Venturi pump setting on, use the **IA Submode Configuration** screen.

4. Press the **Settings** button in the control panels on the main panel to change Aspiration Mode or Vacuum Mode,
5. Press **Finished** to close the **Settings** window.
6. After all the submodes are programmed, select another mode.
7. If no other changes are needed press **End Case** to access the **SAVE** buttons and save the settings.

**Figure 5.4 – Irrigation/Aspiration Mode**

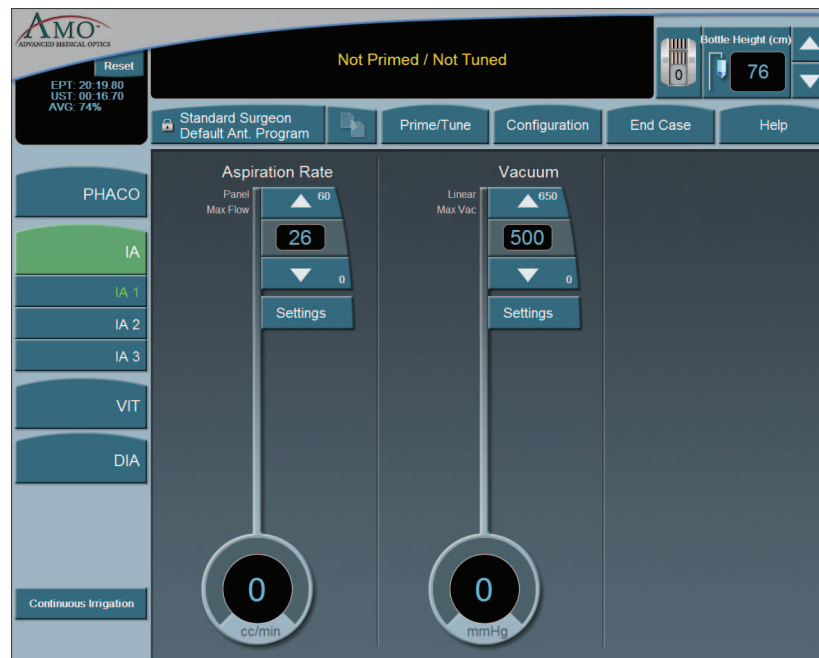

## Continuous Irrigation

Continuous Irrigation is designed for collection of balanced salt solution for use during the case. This function opens the irrigation valve for fluid collection independent of the footpedal or prime cycle.

To activate Continuous Irrigation:

1. On the side panel, press the **Continuous Irrigation** button. This opens the valve and starts the flow of irrigation fluid.
2. Press **Continuous Irrigation** again to deactivate the continuous irrigation.

**Figure 5.5 – Continuous Irrigation**



## Phacoemulsification

The purpose of phacoemulsification or PHACO is to emulsify the lens material. The phacoemulsification (phaco) handpiece provides ultrasonic energy, irrigation and aspiration simultaneously so that the lens material is extracted as it is emulsified. The phacoemulsification handpiece has a hollow needle that vibrates longitudinally at an ultrasonic frequency or a blend of longitudinal and transversal, if using the Ellips™. The rapid movement of the needle and the resulting cavitation energy disintegrates the cataract on contact. The debris is removed by suction through the hollow needle (aspiration). The resulting loss in volume of the anterior chamber is compensated by incoming balanced salt solution (irrigation).

## PHACO Submodes

There are four PHACO submodes. Within each submode, there are programmable parameters for Unoccluded Phaco, and Occluded Phaco, and CASE settings.

Phaco Power is a combination of stroke length, frequency and handpiece efficiency. A preset power setting of 30% using linear control allows you the ultimate control during phaco. Adjustments to phaco power depend on factors that include nuclear density, your preferences and your experience.

Phacoemulsification mode lets you set four submodes with different settings. You can adjust the individual parameters of each submode.

**Figure 5.6 – PHACO Submodes**



For each PHACO submode, you can change the following settings:

- Aspiration Rate
- Vacuum
- Power

Before phacoemulsification, you must complete the steps to verify the Irrigation and Aspiration balance, as recommended in the Irrigation/Aspiration section in this chapter.

## Using PHACO

1. Press **PHACO**.
2. Press **Phaco 1**, **Phaco 2**, **Phaco 3**, or **Phaco 4** to select the submode. The main panel shows all of the settings for Aspiration Rate, Vacuum and Power. Each submode has different default settings.
3. Press the footpedal to activate phacoemulsification. The Aspiration Rate, Vacuum and Power control panels indicate the associated levels throughout the procedure. The Footpedal icon in the upper right corner of the screen shows the position of the footpedal.

## How to Program PHACO

1. Press the **PHACO** button.
  2. Press the desired submode button. **Phaco 1** is selected by default.
- Note: You can set your Initial Mode/Submode on the Phaco Configuration screen. The Initial Mode/Submode is then your default setting. (Refer to Program Configuration, in this chapter.)
3. In the control panels in the main panel, click the **Up** or **Down** arrows to increase or decrease Aspiration Rate, Vacuum, or Power.
- Note: If the Venturi pump is On, only the Vacuum and Power Settings are shown. CASE is not accessible when the Venturi pump is On.
4. Repeat for each submode you want to program.
  5. If OCCLUSION MODE™ Phaco or CASE is desired, press  in the left column to activate the FUSION™ Mode screen. When OCCLUSION MODE™ Phaco is active, the **On** button is green.

**Figure 5.7 – Fusion™ Fluidics Screen**

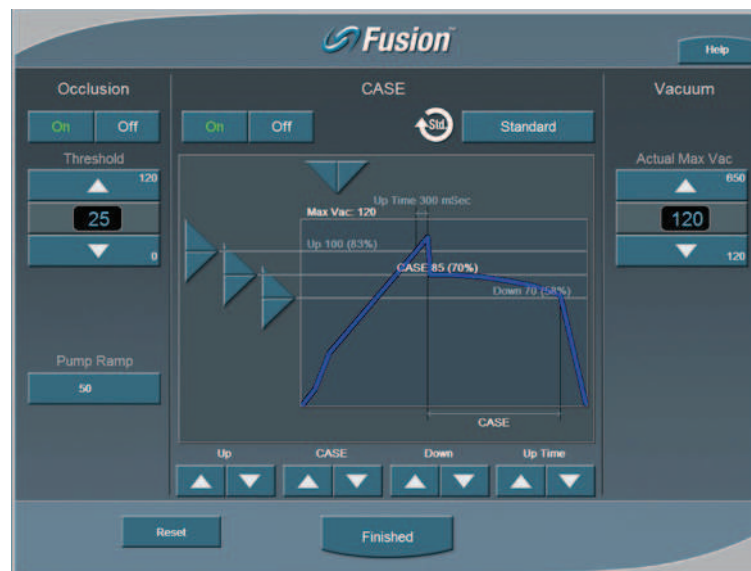



If you use CASE or OCCLUSION MODE™ Phaco, you can set different values for both Occlusion Threshold and Max Vacuum. Refer to Fusion™ Fluidics Phaco for programming CASE and OCCLUSION MODE™ Phaco modes.

After all four PHACO submodes are programmed; press a mode button to select another mode.

If no other changes are needed press **End Case** to access the **SAVE** buttons and save the settings.

## WHITESTAR® Technology

The WHITESTAR® Technology can be applied in any phaco power delivery mode. This technology is an advanced phacoemulsification power mode that delivers finely modulated pulses of energy interrupted by extremely brief cooling periods. This technology is available in Linear or Panel mode. When the

WHITESTAR® delivery mode is turned on, either  or  appears on the touch screen, along with the WHITESTAR® Duty Cycle.

**Figure 5.8 – WHITESTAR® Technology**



WHITESTAR® Duty Cycles are expressed as Pulse Time On/Pulse Time Off, to achieve a desired Duty Cycle. For example, the Duty Cycle setting 6/12 means that the pulse time **On** is 6 ms, and the pulse time **Off** is 12 ms, resulting in a 33% duty cycle.



**Table 5.1 – WHITESTAR® Technology Parameter Settings**

Setting	Pulse On Time (ms)	Pulse Off Time (ms)	Duty Cycle	Pulse Rate (pps)
6/12	6	12	33%	55
4/8	4	8	33%	83
6/4	6	4	60%	100
6/8	6	8	43%	71
8/4	8	4	67%	83
4/24	4	24	14%	35
6/28	6	28	18%	29
6/24	6	24	20%	33
8/24	8	24	25%	31
6/18	6	18	25%	41

**Figure 5.9 – Duty Cycle**



When the Variable WHITESTAR® Technology is used, different duty cycles are applied as the footpedal moves through the power delivery zone. The zone is divided into four equal size quadrants, and a different duty cycle can be applied in each quadrant.



**Figure 5.10 – Variable WHITESTAR® Technology Footpedal Positions and Duty Cycles**

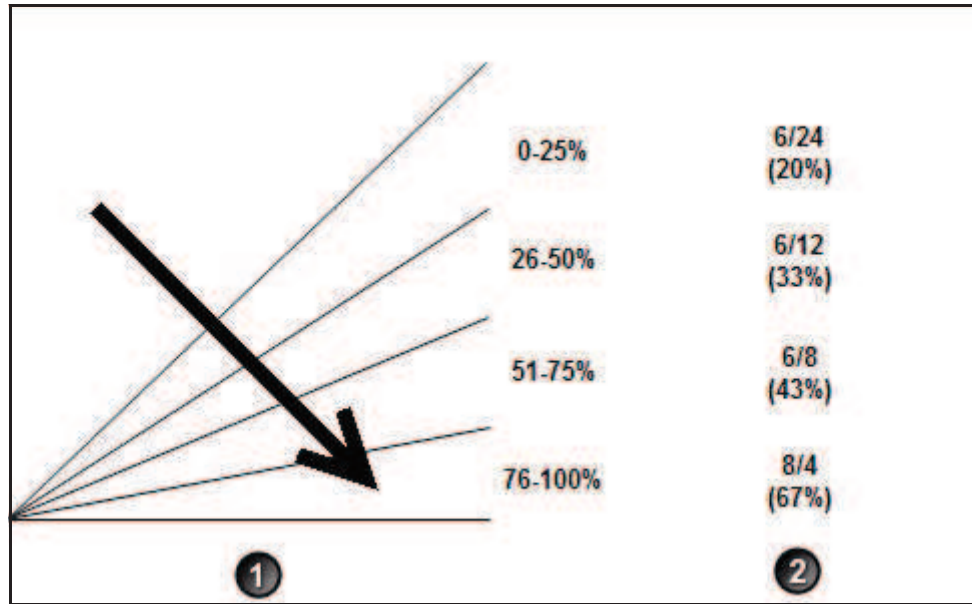

- 1. Footpedal Position 3
- 2. WHITESTAR® Duty Cycle

The WHITESTAR SIGNATURE™ System maintains duty cycles to be used with Variable WHITESTAR® – Variable WS. Variable WS contains the four duty cycles that are used in the different quadrants. You can also use the sliding adjustments to create Custom WHITESTAR® duty cycles for WS.

**Figure 5.11 – Duty Cycles for Variable WS**

### WHITESTAR<sup>®</sup> ICE Technology Pulse Shaping

The WHITESTAR<sup>®</sup> ICE Technology was the next micro-pulse advance in phacoemulsification technology, which combined modulated ultrasonic power (pulse shaping) with vacuum control through the application of the Chamber Stabilization Environment (CASE).

This pulse shaping technology modified the standard “square” wave pulse, by increasing the amplitude of the first millisecond of the On Time “kick”, and then setting the remaining part of the On Time to the standard power setting. This is repeated for each On Time period, resulting in increased control and efficiency in phacoemulsification.

**Figure 5.12 – WHITESTAR<sup>®</sup> ICE Technology Pulse Shaping**

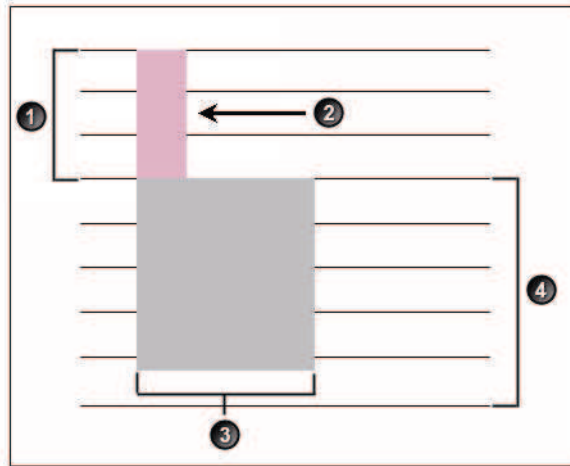

- |                       |                      |
|-----------------------|----------------------|
| 1. Kick Amplitude     | 3. Burst Width       |
| 2. 1 Millisecond Kick | 4. Phaco Power Level |

To access the WHITESTAR<sup>®</sup> ICE Technology settings:

1. Press the **Power Settings** button.
2. Press the **WHITESTAR** mode button.
3. Press **On** for Pulse Shaping.
4. Press **Edit** to access the Pulse Shaping parameter settings.
5. Press **Finished** to close the screen. Continue to press **Finished** to return to the main screen.

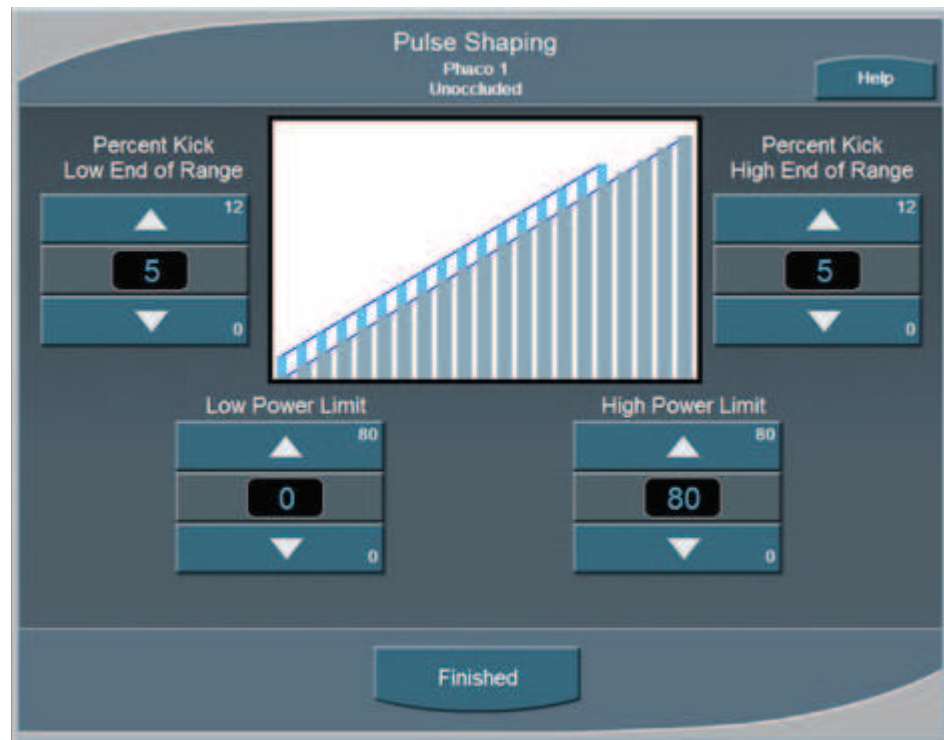
**Figure 5.13 – Pulse Shaping Screen**

There are four settings for WHITESTAR<sup>®</sup> ICE Pulse Shaping:

- Low Power Limit
- High Power Limit
- Percent Kick Low End of Range
- Percent Kick High End of Range

The Low and High Power Limit settings define the range over which pulse shaping is applied. When the applied Phaco Power is outside of these limits, no pulse shaping is applied.

The Percent Kick settings determine the amplitude, or amount of Phaco Power “kick” that is applied in the first millisecond of Phaco Power application, either in the low end or the high end of the power range. As the Phaco power increases from the Low Power limit to the High Power Limit, the percentage of kick is interpolated for the power ranges in between the two limits.

As an example, if a small kick setting is established for the Low End of the range and a large kick setting is established for the High End of the range, the kick percentage gradually increases as the Phaco Power increases. When the Percent Kick at the Low End is the same as the High End, then the kick remains constant throughout the Low to High range.

## Fusion™ Fluidics Phaco

Fusion™ Fluidics Phaco is an intelligent vacuum monitoring system used to regulate the maximum allowable vacuum that is experienced following an occlusion of the phaco tip. When the phaco tip becomes occluded, the vacuum rises. Clearing of the occlusion while the vacuum is at a high level can cause a post-occlusion surge. With CASE enabled, the System monitors the actual vacuum levels and when the vacuum exceeds a specific threshold for a specified duration, the System automatically adjusts the maximum allowable vacuum setting to a lower predefined CASE maximum vacuum level. When the occlusion is cleared, the System is automatically restored to the original programmed maximum vacuum setting. It is possible to have a different maximum vacuum setting when the needle is occluded than when the needle is not occluded.

The power modulation of the phaco handpiece can be programmed to automatically change when the phaco tip changes from an unoccluded condition to an occluded condition.

**Figure 5.14 – Fusion™ Fluidics Phaco**

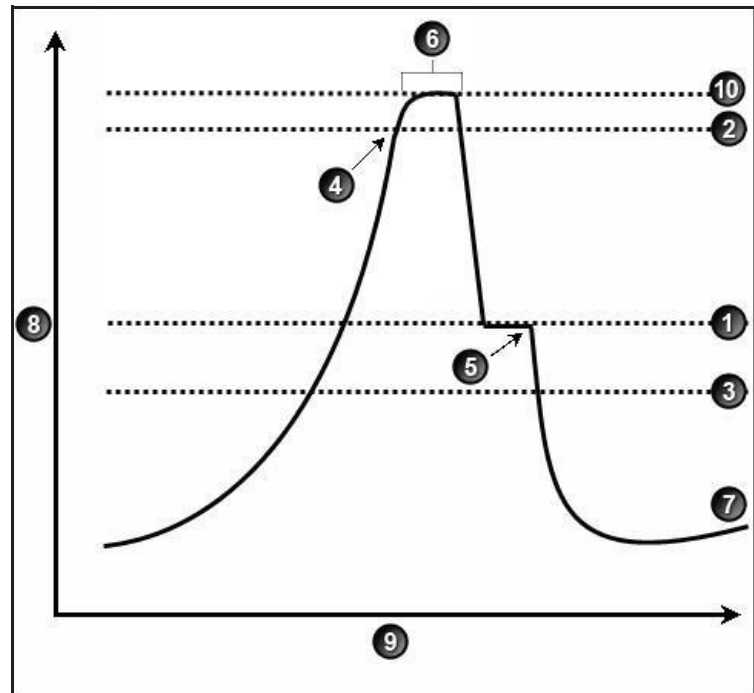

- |  |                 |
|--|-----------------|
| 1. CASE Vacuum                           | 6. Up Time      |
| 2. Upper Threshold                       | 7. Vacuum Level |
| 3. Lower Threshold                       | 8. Vacuum.      |
| 4. Vacuum Level crosses Upper Threshold. | 9. Time.        |
| 5. Phaco activated.                      | 10. Max Vac     |

The CASE screen shows the settings as a graph. To access the OCCLUSION MODE™ Phaco and CASE settings:

1. Press the  button from the **PHACO** mode screen.

Figure 5.15 – Fusion™ Fluidics Phaco Screen



2. Press the **On** button to turn CASE mode on.

Note: If the Venturi pump option is On, you cannot access the Fusion™ Fluidics screen. There is no Occlusion Mode or CASE Mode with Venturi.

3. Use the **Up** and **Down** arrows at the bottom of the screen to adjust the:

- **CASE Vacuum (CASE)** – This is the optimum occlusion vacuum setting
- **Upper Threshold (Up)** – This is the maximum threshold vacuum setting, which is maintained for the amount of time defined by the Up Time Threshold.
- **Lower Threshold (Down)** – After the occlusion is cleared, the vacuum is reduced to the lower vacuum threshold setting to allow the occlusion to be safely cleared, and then gradually returned to the previous levels.

4. Use the **Right** and **Left** arrows in the graphic to change the **Up Time Threshold**. The Up Time Threshold is the maximum time that the maximum threshold vacuum is maintained.

5. Press **Finished** to close the screen

Use the Fusion™ Fluidics screen to turn OCCLUSION MODE™ Phaco Off or On. When OCCLUSION MODE™ Phaco is **On**, the main PHACO operating screen provides for alternative Aspiration, Vacuum and Phaco Power settings that are used when an occlusion is detected.

Figure 5.16 – PHACO Screen



### Vitrectomy

The WHITESTAR SIGNATURE™ System uses a pneumatic guillotine vitrectomy cutter. The handpieces are designed for cutting vitreous during anterior segment surgery and operate in conjunction with the Irrigation/Aspiration mode. The cutting speed can be changed on the touch screen. There are four adjustments related to the Vitrectomy mode:

- Aspiration Rate
- Vacuum
- Cut Rate
- Footpedal



**CAUTION: THE PHACO HANDPIECE AND VITRECTOMY CUTTER MUST NEVER BE ACTIVATED WITH THE TIPS IN THE AIR. EXPOSING THE TIP TO AIR DRASTICALLY REDUCES THE USEFUL LIFE OF THE HANDPIECE. IF POWER IS TO BE INTRODUCED TO THE PHACO HANDPIECE OR VITRECTOMY CUTTER, THE TIPS MUST BE IN A TEST CHAMBER FILLED WITH A BALANCED SALT SOLUTION, IN A CONTAINER OF BALANCED SALT SOLUTION OR IN THE PATIENT'S EYE.**

### Using Vitrectomy

In the left panel, press **VIT 1** or **VIT 2** to select a submode. **VIT 1** is selected by default.

Note: Each time you select the vitrectomy mode you are prompted to prime the vitrectomy handpiece. Refer to Chapter 4, *Equipment Operation*, Priming for Vitrectomy for detailed information.

**Figure 5.17 – Vitrectomy Mode Screen**



1. In the main panel, press the **Up** or **Down** arrows to increase or decrease the Aspiration Rate, Vacuum, or Cut Rate.

Note: If the Venturi pump is On, only the Vacuum and Cut Rate Settings are shown.

2. To program the footpedal, go to **Configuration, Surgeons and Programs, Foot Pedal, Configuration, VIT**.
3. Select a **Submode** to program.
4. Edit the footpedal settings as needed.



Figure 5.18 – Single Linear Foot Pedal Settings Screen



Figure 5.19 – Dual Linear Foot Pedal Settings Screen



5. When finished, press **Exit Settings**.
6. If no other changes are needed, press **End Case** to access the **SAVE** buttons and save the settings

### Footpedal Vitrectomy Modes

The footpedal mode selection must be made for ICA, IAC, or Side vitrectomy (VIT), which determines how the vitrectomy cutter is activated as the footpedal is pressed from Positions 1 through 3. Use the left side switch to activate the cutter at the panel rate for Side VIT only.

**Table 5.2 Vitrectomy Single Linear Footpedal Modes**

Footpedal Positions	Vitrectomy Footpedal Modes		
	ICA	IAC	Side VIT
1	Irrigation	Irrigation	Irrigation
2	Irrigation/Cut	Irrigation/ Aspiration	Irrigation/ Aspiration
3	Irrigation/Cut/ Aspiration	Irrigation/ Aspiration/Cut	Irrigation/ Aspiration

**Table 5.3 Vitrectomy Advanced Control Pedal (Dual Linear) Modes**

Footpedal Positions	Vitrectomy Footpedal Modes		
	ICA	IAC	Side VIT
1	Irrigation	Irrigation	N/A
2	Irrigation/Cut	Irrigation/ Aspiration	N/A
Yaw	Aspiration	Cut	N/A

## Programming the Modes and Settings

### Program Configuration

These programmed settings allow for the selection of operational features and options pertinent to general operation for each mode and submode, the footpedal, system sounds and the system database.

When the **AMO Default Program** is selected, all of the modes and submodes are preset. Although these settings can be changed, they cannot be saved. Use the defaults as a source to your system settings. All default settings can be easily viewed on the Mode Configuration screens.

**Figure 5.20 – PHACO Program Screen**

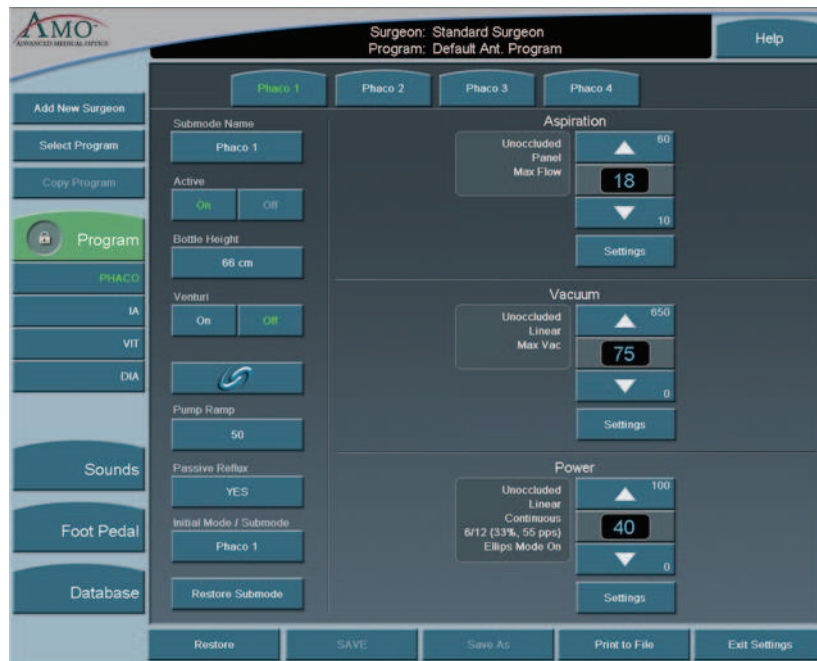

**AMO Default Setups****Sounds****Table 5.4 – WHITESTAR SIGNATURE™ System Default Settings**

<b>Specific to each surgeon program/setup</b>		
<b>Sounds</b>	<b>Available Settings</b>	<b>AMO Default Settings</b>
High Vacuum	On, Off	On
Mode Change	Off, Tone, Voice	Voice On
Submode Change	Off, Tone, Voice	Voice On
Value Change	On, Off	Voice On
Activity Confirmation	On, Off	Voice On
Vacuum	Off–10	6
Diathermy	5–10	6
Phaco Power	Off–10	Off
Error	5–10	6
Irrigation	Off-10	3
Key Press	Off–10	6
Speech	Off–10	6
CASE Activation	0–10	5
Master Volume	0–10	10

### Footpedal – AMO Default Settings

The AMO Default footpedal settings for each operating mode are shown on the System's Summary Screen.

**Figure 5.21 – Single Linear Footpedal Summary Settings**



**Table 5.5 – Footpedal Threshold AMO Default Settings**

Footpedal Type	Parameter	Available Settings	AMO Default Settings
Single Linear	Pitch Regions	1–100%	P1=5% P2=30% P3=60%
	Switch Position	Switch 1= * Switch 2= *	Switch 1=Off Switch 2=Off
		Right= * Left= *	Right=Off Left=Off
	Feedback	On, Off	Off
Advanced Control Pedal (Dual Linear)	Primary Yaw	*	Reflux
	Pitch Region	1-100%	P1=5% P2=30% P3=60%
	Yaw Position	5-100%	Left=50%
			Right=50%
	Switch Position	Switch 1= * Switch 2= *	Switch 1=Off Switch 2=Off
	Yaw Threshold	5% - 100%	5%
	Feedback	On, Off	Off

\*Switch Assignments

Surgeon Program Up	Surgeon Program Down	Previous Major Mode	Next Major Mode	Previous Active Mode
Next Active Mode	Previous Sub Mode	Next Sub Mode	Toggle SMC Record	Bottle Up
Bottle Down	Reflux	Continuous Irrigation	1-Touch Up (Phaco Only)	1-Touch Down (Phaco Only)
Toggle Case (Phaco Only)	Single Vit Cut (Vitrectomy Only)			

**Table 5.6 – Diathermy – AMO Default Settings**

Parameter	Available Settings	AMO Default Settings	
		DIA 1	DIA 2
Max Power	5–100%	30%	30%
Power Delivery Type	Linear, Burst, Panel	Linear	Burst
Initial Mode/ Submode	Any of the Submode Names	Phaco 1	Phaco 1

**Table 5.7 – I/A – AMO Default Settings**

Parameter	Available Settings	AMO Default Settings		
		IA1	IA2	IA3
Continuous Irrigation	On, Off	Off	Off	Off
Pump Selection	Venturi Peristaltic	Peristaltic	Peristaltic	Peristaltic
Bottle Height	0–104 cm 0–42 inches	76 cm 30 inches	50 cm 20 inches	50 cm 20 inches
Max Vacuum	0–650 mmHg	500 mmHg	500 mmHg	15 mmHg
Max Aspiration/ Mode (Peristaltic)	0–60 cc/min	26 cc/min Panel	26 cc/min Linear	6 cc/min Panel
Peristaltic Pump Ramp Threshold	10–100%	80%	80%	80%
Venturi Pump	On, Off	Off	Off	Off
Passive Reflux (Fusion™ Fluidics Pack)	Yes, No	Yes	Yes	Yes
Passive Reflux (Fusion™ Dual Pump Pack)	Yes, No	Yes	Yes	Yes
Initial Mode/ Submode	Any of the Submode Names	Phaco 1	Phaco 1	Phaco 1
Fluidic Mode	Panel, Linear	Panel Aspiration  Linear Vacuum	Linear Aspiration  Panel Vacuum	Panel Aspiration  Linear Vacuum

**Table 5.8 – PHACO – AMO Default Settings**

Parameter	Available Settings	AMO Default Settings			
		Phaco 1	Phaco 2	Phaco 3	Phaco 4
Bottle Height	0–104cm 0–42 inches	66 cm 26 inches	76 cm 30 inches	76 cm 30 inches	76 cm 30 inches
Continuous Irrigation	On, Off	Off	Off	Off	Off
Pump Selection	Venturi Peristaltic	Peristaltic	Peristaltic	Peristaltic	Peristaltic
Max Vacuum Peristaltic	0–650 mmHg	75 mmHg	300 mmHg	400 mmHg	350 mmHg
Max Vacuum Venturi	0–600 mmHg	75 mmHg	300 mmHg	400 mmHg	350 mmHg
Venturi Pump	On, Off	Off	Off	Off	Off
Passive Reflux	Yes, No				
Fusion™ Fluidics Pack		Yes	Yes	Yes	Yes
Fusion™ Dual Pump Pack		Yes	Yes	Yes	Yes
Initial Mode/ Submode	Any of the Submode Names	Phaco 1	Phaco 1	Phaco 1	Phaco 1
Max Flow/ Aspiration Rate, Unoccluded (Peristaltic)	10–60 cc/min	18 cc/min	24 cc/min	18 cc/min	24 cc/min
Fluidics Mode	Panel, Linear	Panel Aspiration, Linear Vacuum	Panel Aspiration, Panel Vacuum	Panel Aspiration, Linear Vacuum	Panel Aspiration, Linear Vacuum
Occlusion Threshold	0–Max Vac.	25 mmHg	140 mmHg	60 mmHg	80 mmHg
OCCLUSION MODE™ Phaco	On, Off	Off	On	On	Off
CASE Mode	On, Off	Off	Off	On	On
CASE Upper Threshold.	0–Max Vac.	100 mmHg	250 mmHg	325 mmHg	300 mmHg
CASE Lower Threshold.	0–Max Vac.	70 mmHg	175 mmHg	200 mmHg	200 mmHg
Up Time	0–2000 ms	300 ms	300 ms	300 ms	300 ms
CASE Vac	120–650 mmHg	85 mmHg	225 mmHg	250 mmHg	250 mmHg
CASE One-Touch	-2, -1, STD, +1, +2	STD	STD	STD	STD
Peristaltic Pump Ramp	10–100%	50%	60%	50%	70%
Power Delivery Mode (Unoccluded and Occluded)	Continuous Short Pulse Long Pulse Low Power Pulse High Power Pulse Single Burst Multi-Burst Continuous Burst	Continuous	Continuous	Continuous	Continuous
Short Pulse Rate	1–14 pps	6 pps	6 pps	6 pps	6 pps
Long Pulse Rate	1–6 pps	4 pps	4 pps	4 pps	4 pps



Parameter	Available Settings	AMO Default Settings			
WHITESTAR® Technology Duty Cycles	2–30 On Time 2–30 Off Time  Predefined: 6/12, 4/8, 6/4, 6/8, 8/4, 4/24, 6/28, 6/24, 8/24, 6/18	6/12 (33%)	6/12 (33%)	6/12 (33%)	6/12 (33%)
Max Aspiration Rate Occluded	10–60 cc/min	18 cc/min	28 cc/min	14 cc/min	24 cc/min
Max Phaco Power Occluded	0–100%	40%	30%	10%	40%
Max Ellips™ Phaco Power Occluded	On, Off	Off	Off	Off	Off
Max Phaco Power Unoccluded	0–100%	40%	20%	5%	30%
Max Ellips™ Phaco Power Unoccluded	On, Off	Off	Off	Off	Off
Power Delivery Type Occluded	Linear, Panel	Linear	Linear	Linear	Linear

**Table 5.9 – Vitrectomy – AMO Default Settings**

Customized to Each Surgeon Program/Setup AMO Default Settings			
Parameter	Available Settings	VIT 1	VIT 2
Bottle Height	0–104 cm 0–42 inches	30 cm 12 inches	30 cm 12 inches
Continuous Irrigation	On, Off	Off	Off
Pump Selection	Venturi Peristaltic	Peristaltic	Peristaltic
Max Vacuum/Mode (Peristaltic)	0–650 mmHg Panel, Linear	225 mmHg Panel	225 mmHg Panel
Max Aspiration Rate/ Mode	0–60 cc/min Panel, Linear	18 cc/min Panel	12 cc/min Panel
Fluidic Mode	Panel, Linear	Panel Aspiration  Panel Vacuum	Panel Aspiration  Panel Vacuum
Cut Rate	50–2500 cpm	250 cpm	450 cpm
Footpedal Mode	ICA, IAC	ICA	IAC
Pump Ramp Threshold	10 - 100%	100%	100%
Venturi Pump	On, Off	Off	Off

<b>Customized to Each Surgeon Program/Setup AMO Default Settings</b>			
<b>Parameter</b>	<b>Available Settings</b>	<b>VIT 1</b>	<b>VIT 2</b>
Passive Reflux (Fusion™ Fluidics Pack)	Yes, No	Yes	Yes
Passive Reflux (Fusion™ Dual Pump Pack)	Yes, No	Yes	Yes
Initial Mode/ Submode	Any of the Submode Names	Phaco 1	Phaco 1

### **Aspiration Rate**

The Aspiration Flow Rate is the speed at which material is removed from the eye through the aspiration tubing. A pump provides the necessary aspiration flow to withdraw fluid and lens material from the eye chamber through the handpiece. With this aspiration flow system, the vacuum builds when the aspiration port is blocked or occluded. The vacuum reduces as the occlusion clears.

You can adjust the rate in 1 cc increments from 0 to 60 cc per minute. You can also choose Panel or Linear flow.

The flow rate decreases as the vacuum approaches maximum.

To adjust the flow rate:

1. On the Aspiration Rate control panel, press the **Up** or **Down** arrows to increase or decrease the aspiration rate from 0 to 60 cc per minute.
2. Press the **Settings** button to select **Linear** or **Panel** aspiration flow.

The Settings panel appears.

3. Press the **Linear** or **Panel** button.

The Linear vacuum rate is linear with respect to the footpedal position. As the footpedal is pressed through Position 2, the vacuum level travels between 0 mmHg and the maximum preset level as occlusions at the aspiration port occur. The actual vacuum level is indicated by the vacuum progress shown on the screen.

The Panel vacuum rate provides a continuous evacuation at the established vacuum rate. The vacuum builds only when the footpedal is in Position 2 and an occlusion in the aspiration port is created.

4. Press **Finished** to close the window.

## Vitreotomy Cutting Rates

Note: Each time you select the vitrectomy mode you are prompted to prime the vitrectomy handpiece. Refer to Chapter 4, *Equipment Operation*, Priming for Vitrectomy for detailed information.

You can vary the Vitrectomy Cut Rate of the vitrectomy cutter from 50-2500 CPM (cuts per minute) in increments of 50 CPM between 100–1000, and 100 CPM between 1000–2500 CPM.

Some surgeons prefer a higher rate, which allows the surgeon to perform the same amount of cutting with smaller “bites” of vitreous. This minimizes motion and is gentle on the tissue.

To adjust the cut rate

1. On the **Cut Rate** panel, press the **Up** or **Down** arrows to increase or decrease the cut rate.
2. Press **Settings** to select either Linear or Panel cutting methods. The **Settings** window opens.

Note: Side Vit is only available for use with a single linear foot pedal.

3. Press **Linear** or **Panel** button.
4. Press **Finished** to close the window.

**Figure 5.22 – VIT Cut Rate**



## Footpedal Settings

The System accommodates multiple configurations for setting footpedal operation. Each surgeon has one set of footpedal settings for all programs.

The **Switch Assignment** screen opens when you select **On** for any of the switches on the **Foot Pedal** selection screens. The **Switch Assignment** screen allows you to make a selection for that switch.

## Footpedal Settings

From the top panel of any operating screen, press **Configuration**. The program highlighted on the Main Menu is used.

1. Press **Surgeons and Programs** in the pop-up window.
2. In the side panel press **Foot Pedal**.

**Figure 5.23 – Foot Pedal Pitch Thresholds - Single Linear**



**Figure 5.24 – Foot Pedal Pitch Thresholds - Advanced Control Pedal (Dual Linear)**



3. Adjust the Yaw Threshold percentage if the Advanced Control Pedal is used.
4. Adjust the Foot Pedal **Pitch Threshold** settings.
5. Turn the Foot Pedal **Feedback On** or **Off**. You can use the **Foot Pedal Test** button to test your settings.
6. Press **Configuration**. The **Foot Pedal Settings** options are shown.

**Figure 5.25 – VIT Foot Pedal Settings Advanced Control Pedal (Dual Linear)**

7. Select the type of foot pedal.
8. Select the Primary Yaw. Each time you select the **Assign Primary Yaw** button, the selection is changed from left-to-right or right-to-left.
9. Select the operating modes for that surgery using the top Mode tabs and complete the footpedal setup for each mode (PHACO, IA, VIT, or DIA). The footpedal settings are shown in the center of the screen. Select **Summary** to view the footpedal settings for all of the modes.
10. Press each of the switches in any of the four modes. A pop-up window is shown for each switch.
11. Select the **Switch Assignment** from the list.

Note: WHITESTAR Increment/Decrement is used to increase or decrease the Duty Cycles during surgery.

**Figure 5.26 – Vitrectomy Switch Assignment Pop-up Window**

12. Press **Finished** to close the window.

13. Press **SAVE** to retain the settings.

Note: If you entered **Configuration** while in an Operating mode, press **Exit Settings** to return to the previous mode.

## Vacuum

The vacuum is the force exerted on the aspirated fluid in the aspiration tubing. To make sure you have fluidic balance while in phacoemulsification, you can adjust the Max Vac from 0 to 650 mmHg (Peristaltic pump), as indicated on the Vacuum panel.

1. To adjust the vacuum settings:
  - To increase or decrease vacuum force, press the **Up** and **Down** arrows on the Vacuum panel.
2. To select **Linear** or **Panel** flow, press **Settings**. The Vacuum **Settings** pop-up window appears.
3. Press the **Linear** or **Panel** button.
4. Press **Finished**.

The Linear flow increases from the minimum (0 cc per min) to the maximum preset flow rate as the surgeon presses the footpedal through Position 2. A higher flow rate (as delivered from the footpedal) results in a quicker vacuum rise time. A slower flow rate results in a slower vacuum rise time.

The Panel flow provides a constant evacuation at the preset flow rate when the footpedal enters Position 2.

## End Case

**End Case** is available in the top panel from any programming or surgical mode. **End Case** allows you terminate the programming session or surgical case. If changes were made to the program settings, you are prompted to **SAVE** the settings.

Note: For ease of viewing, the EPT, Ellips EPT, UST and AVG times are shown in a large font size on the **End Case** window. The Ellips EPT is shown only when Ellips™ Technology is On.

## Program

Note: **SAVE**, **Save As**, and **Restore** have the same functions on the Program Configuration screens.

**SAVE** – Saves the changes to the existing Surgeon Name/Program.

**Save As** – Saves the program changes (made to an existing program) to a new program name when you enter a program name.

**Restore** – Erases any program changes and resets the values back to the last saved values.



## End Case

**Purge** – Select **Purge** to remove all of the fluid from the irrigation and aspiration tubing before you remove the tubing cassette.

**Next Case** – Select **Next Case** to install a new tubing cassette.

Note: Use a new bottle of balanced salt solution at the start of each case.

**Figure 5.27 – End Case Screen**

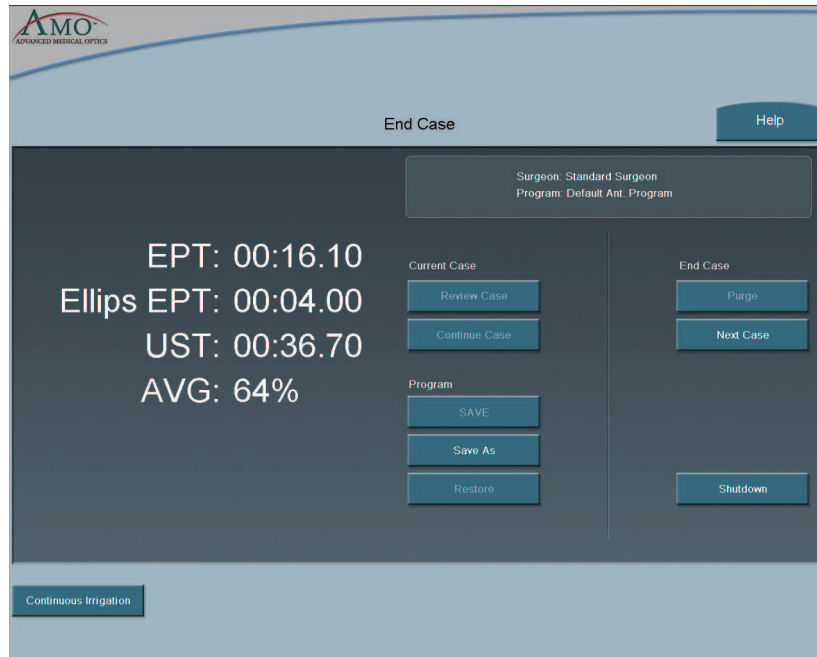

The timers in the upper left corner indicate Effective Phaco Time (EPT), Ultrasonic (U/S) Time in Footpedal Position 3, and Ellips EPT if Ellips™ Technology is On. Effective Phaco Time is ultrasound time as a weighted total that takes into account the amount of power being used:

- at 100% power: 1 sec. U/S Time = 1 sec. EPT
- at 50% power: 1 sec. U/S Time = .5 sec. EPT

## Current Case

**Review Case** – shows the graphical history of the surgery. (Refer to Figure 5.28 Review Case Screen.)

1. Select a shorter time interval to adjust the Time Line Duration and to see greater case details. For example, 10 Sec shows more detail than 15 Min.
2. Select a longer time interval for an overview of the surgery or sessions, such as 1 hour or 2 hours. This view provides less detail, but gives you a better indication of the trends over a period of time. Use the << or >> buttons to change the time intervals. You cannot use the arrow buttons when you view an active case.

3. Press the **Select Review Case** to select and view a specific surgical case.
4. Press **Export** to name and save the record to a USB device. Enter a name for the **Case History**.

Note: Use only AMO recommended USB stick drives.

5. Use the **Print to File** to save the data to a file format. The **Delete Record** button removes the case from the **Record** database.
6. Select **Finished** to close the window.

**Figure 5.28 – Review Case Screen**



**Continue Case** – Select **Continue Case** to return to the current case, after you selected **Review Case** or **Restore**.

**Shutdown** – Select the **Shutdown** button to turn the System **Off**. At the prompt, press **Yes** to complete the process.

## Anterior Segment – Recommended Settings

### Phaco Power

You can adjust power from 0% to 100% in 5% increments for both Occluded and Unoccluded phaco tips. The large number in the power panel indicates the selected maximum Phaco Power. The phaco power can be either Linear or Panel.

1. **Linear** – Power is controlled with the footpedal, the power increases from 0%–100% to the maximum preset level. When the footpedal is fully pressed, the power level is at the maximum preset level. The power increase is indicated by the power display bar.
2. **Panel** – Power is delivered consistently at the power level (%) indicated on the screen. The power level does not change when you press the footpedal.

There are eight choices for delivery of phaco power:

- **Continuous**
- **Short Pulse**
- **Long Pulse**
- **Low Power Pulse**
- **High Power Pulse**
- **Single Burst** (Panel only)
- **Multiple Burst** (Panel only)
- **Continuous Burst** (Panel only)

From the PHACO operating screen, press **Settings** and the Phaco Power selection screen appears.

**Figure 5.29 – Phaco Power Settings**



In addition to the eight Phaco Power modes, you can also select the **WHITESTAR Mode**. The WHITESTAR® Technology and Ellips™ Technology are discussed later in this section.

### Continuous Phaco Power

Continuous Phaco Power delivers continuous, uninterrupted phaco power to the handpiece and requires no pulse rate setting.

**Figure 5.30 – AMO™ Phaco Power Modes**

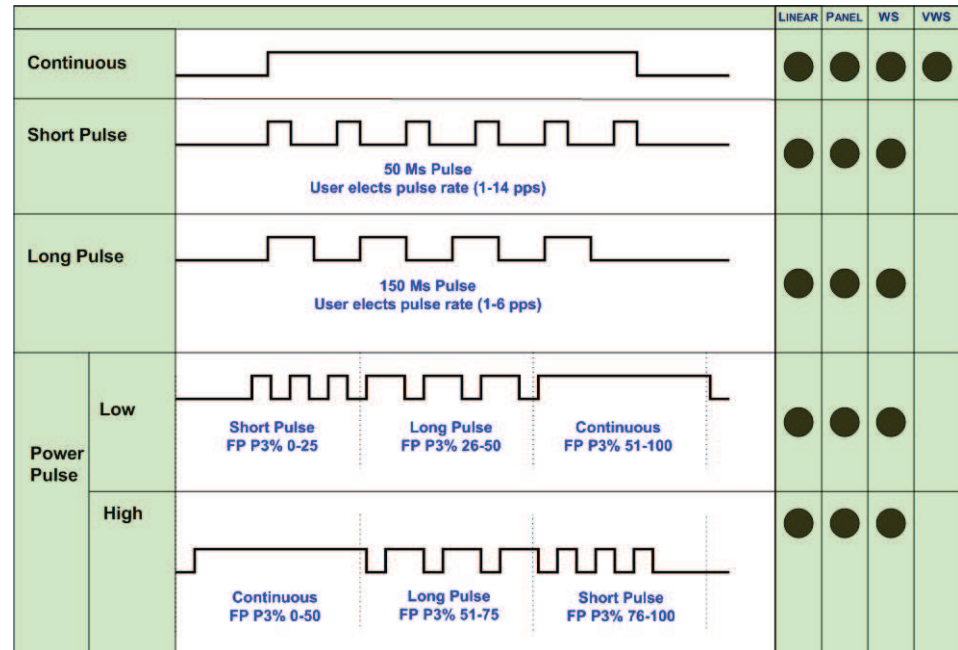

### Short Pulse Phaco Power

Short Pulse delivers Phaco in pulses of 50 ms when the footpedal is in Position 3. You can set this in a range of 1 to 14 pulses per second (pps). The actual number of pps is shown on the button to the right of the **Short Pulse** button.

To set the Short Pulse range:

1. Press the button to the right of the **Short Pulse** button. A **Settings** pop-up window appears.
2. Press the **Up** or **Down** arrow to increase or decrease the pps from 1 to 14.
3. Press **Finished** to close the window.

### Long Pulse Phaco Power

Long Pulse delivers Phaco in pulses of 150 ms when the footpedal is in Position 3. You can set this in a range of 1 to 6 pulses per second (pps). The actual number of pps is displayed on the button to the right of the Long Pulse button.

To set the Long Pulse range:

1. Press the button to the right of the **Long Pulse** button. A **Settings** pop-up window appears.
2. Press the **Up** or **Down** arrow to increase or decrease the pps from 1 to 6.