

RBH-BFR-FACE

INSTALLATION HW 1.0

A. Package content

- Controller x 1, wall hanger x 1, user manual x 1, screwdriver x 1, kit pack x 1
- Kit pack : screw x 4, screw anchors x 4, diode (1N4004) x 1
- 4 pin cable x 1, 8 pin cable x 1, 9 pin cable x 1

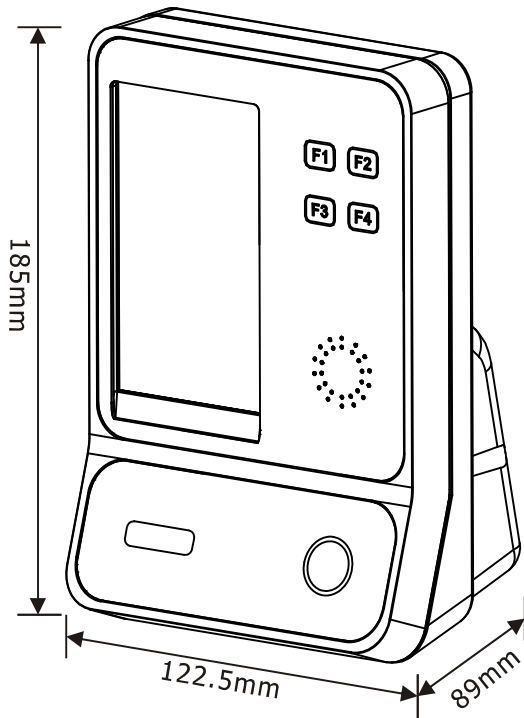

B. Wall-hanger size

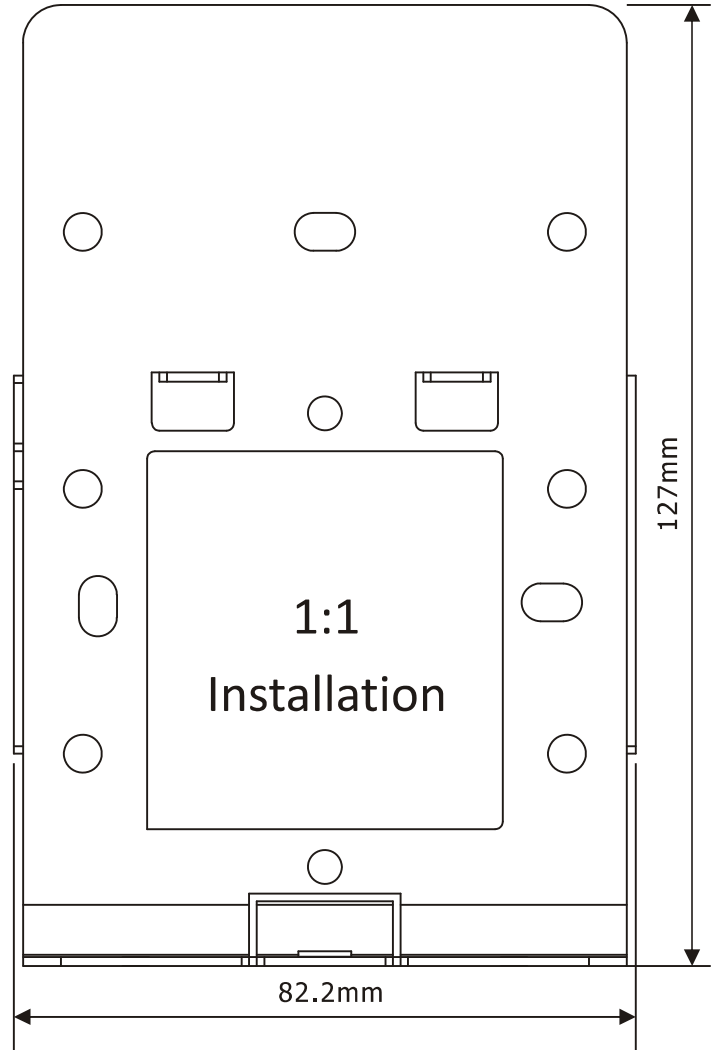

C. Specifications

- Dimension : 122.5 x 185 x 89(mm)
- Power : 9~24 VDC/ 1A
- Wiegand communication : Max to 100 meters
- RS485 communication : Max to 1000 meters
- Face recognition distance : 50 ~ 100 cm
- Install Wall : recommend installation height 115~125 cm

D. Installation instructions

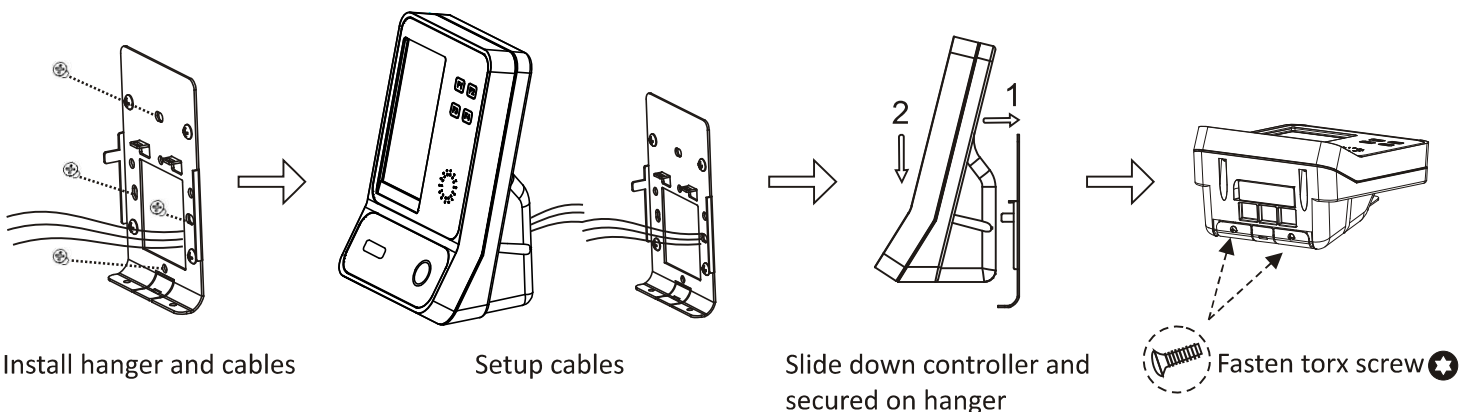

Install hanger and cables

Setup cables

Slide down controller and secured on hanger

Fasten torx screw

E. Application structure

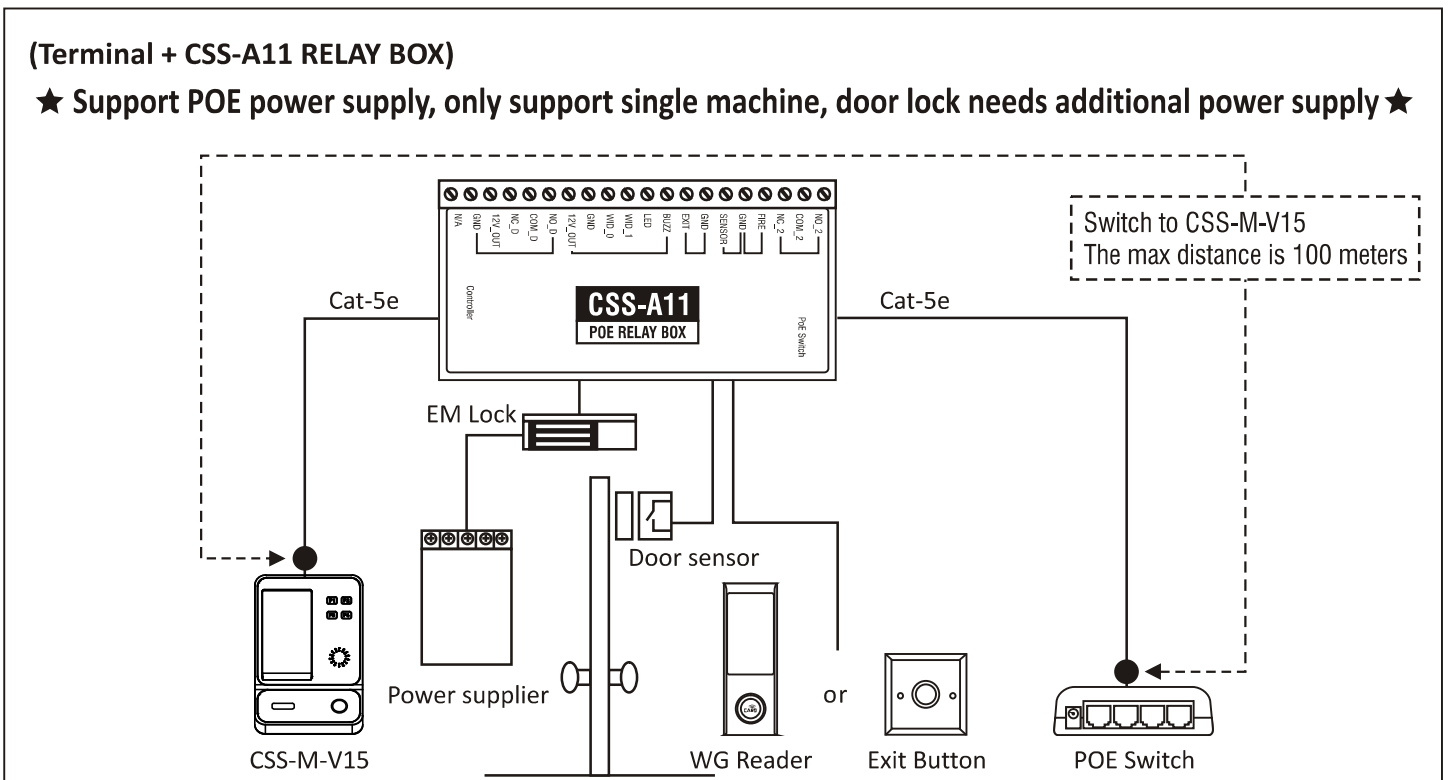
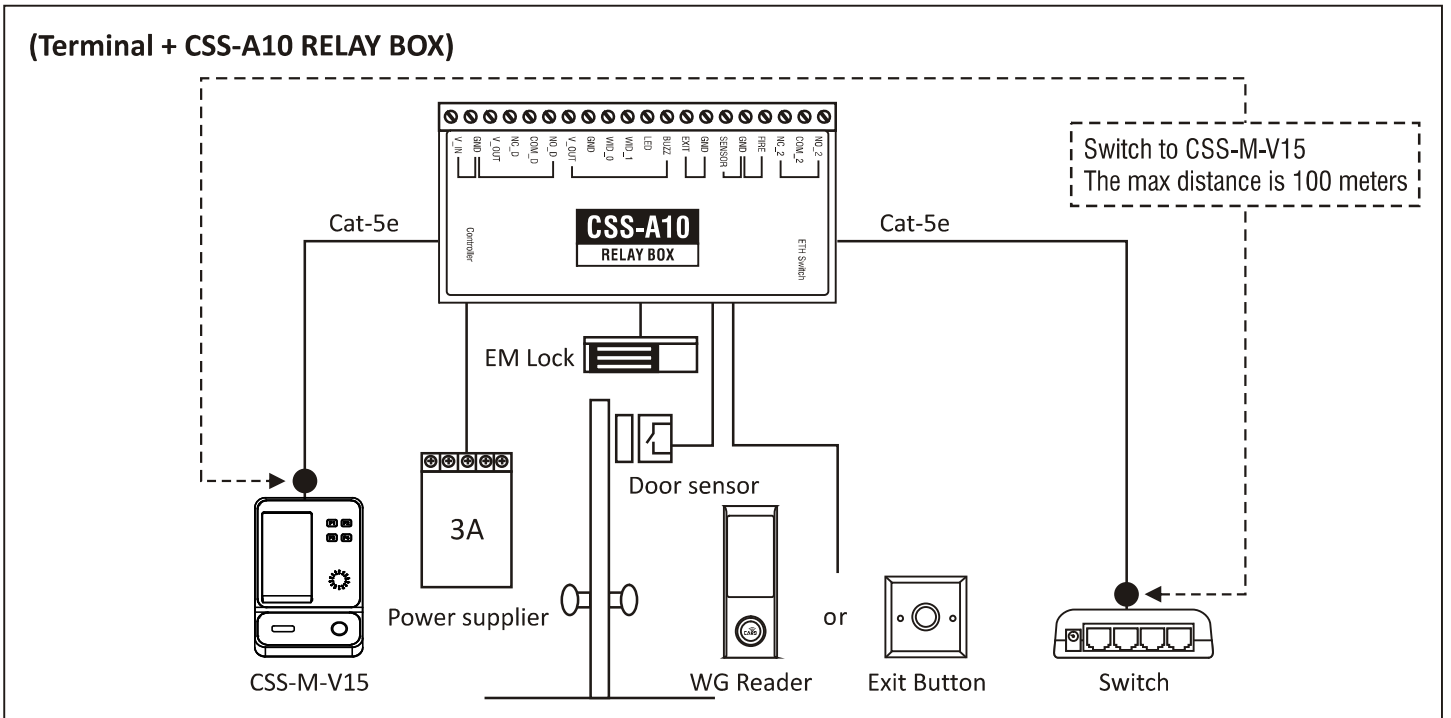
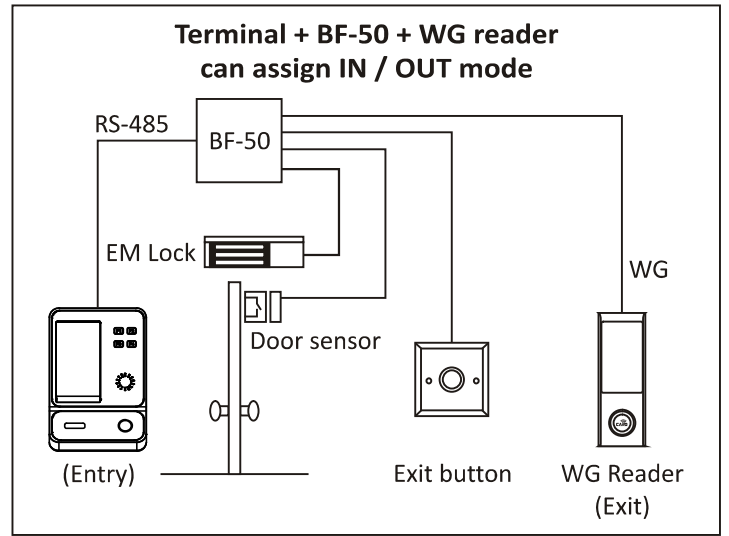
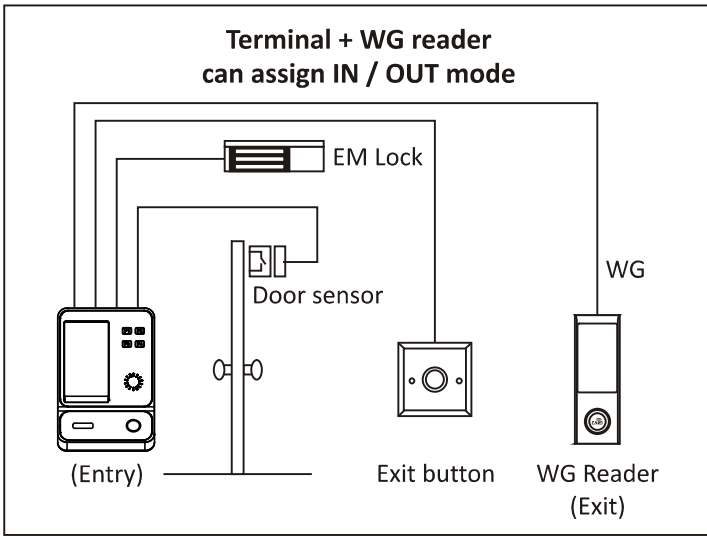

F. Terminal Front Description

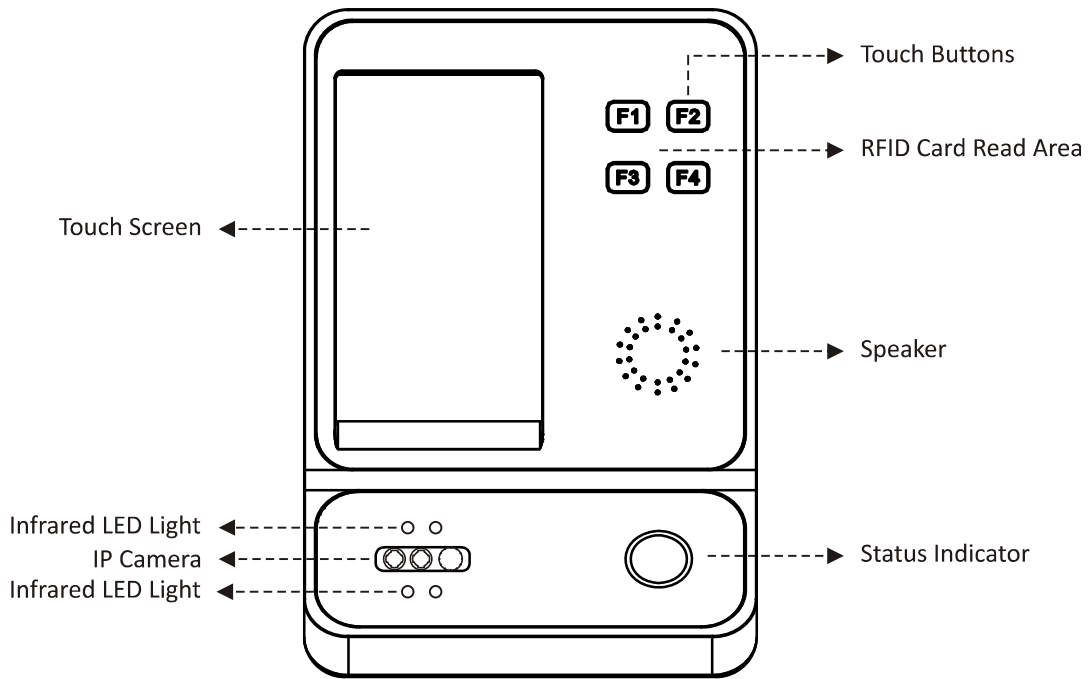

G. Installation

Recommended installation height	
Installed height CM (Bottom of the machine)	Identify users Height CM
115	153~190
117	155~195
119	157~200
121	159~205
123	161~210
125	163~215

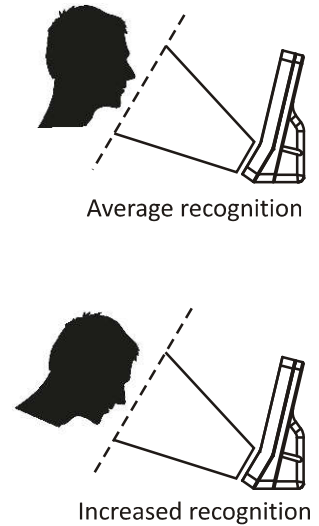
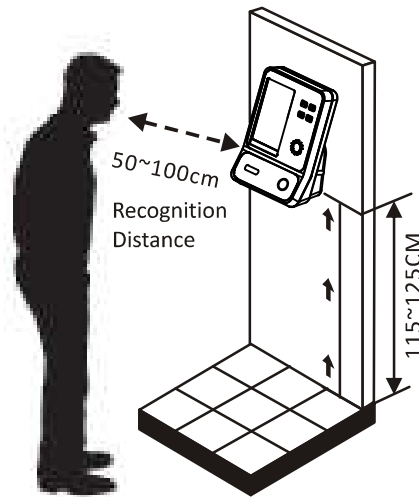

The installation height is mainly for shorter person
The face is aligned to the lower edge of the display frame

The installation height is mainly for shorter person
Recognition distance is about 50~100cm
Recommended installation height form the bottom of the machine to ground is about 115~125cm

Please bow your head slightly when recognizing to improve recognition success rate

H. installation environment

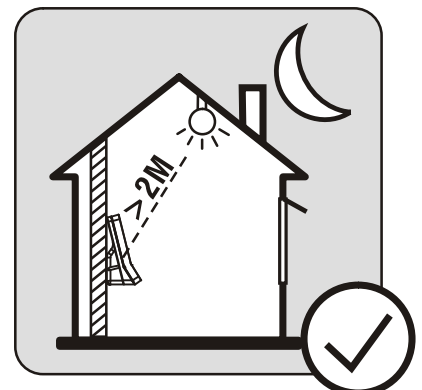
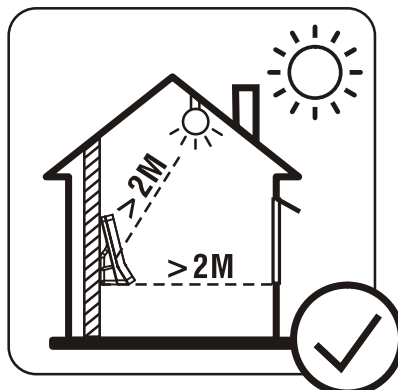
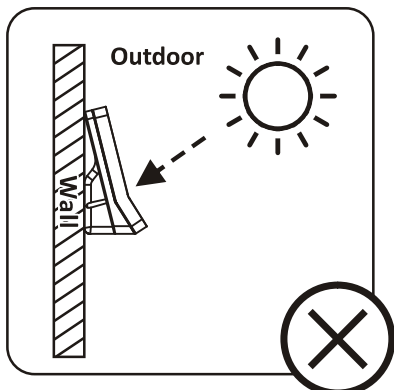

When installing outdoors, direct sunlight equipment, oblique sunlight equipment or direct sunlight equipment through window are prohibited
When installing indoors, make sure that the place must be installed away from windows / doors / lamp more than 2 meters away equipment

I. Terminal Back Explanation

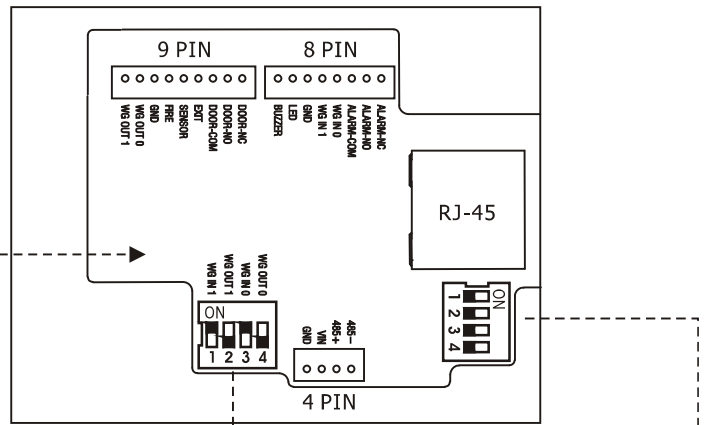
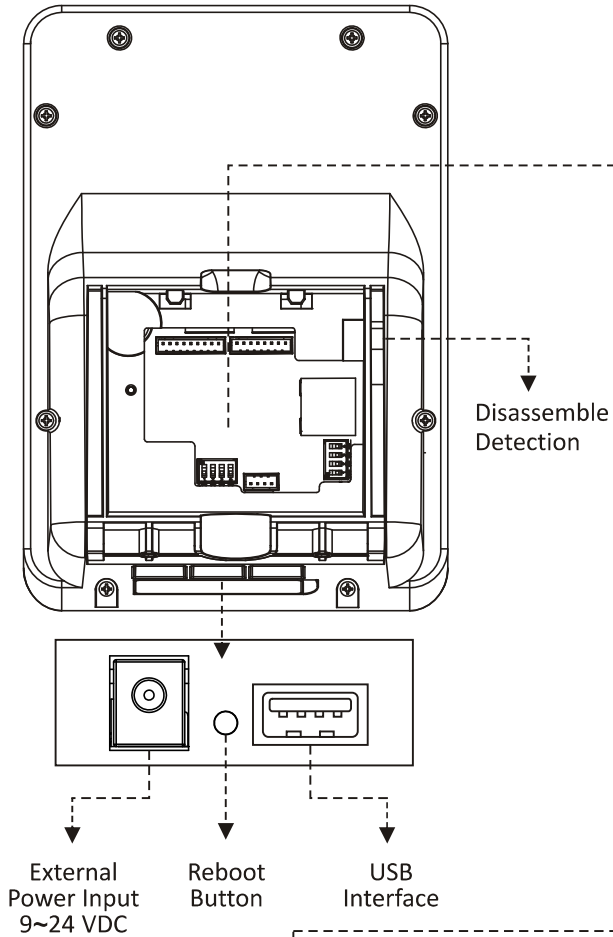

WG Setting Description
(input and output select one only)

WG Input (Default Setting) For connect WG Reader		
WG Output (Needs to use web setting)		

External BF-50/ CSS-A10/ A11 setting instructions

External BF-50 (Default Setting)		
External CSS-A10/ A11		

J. Cable diagram

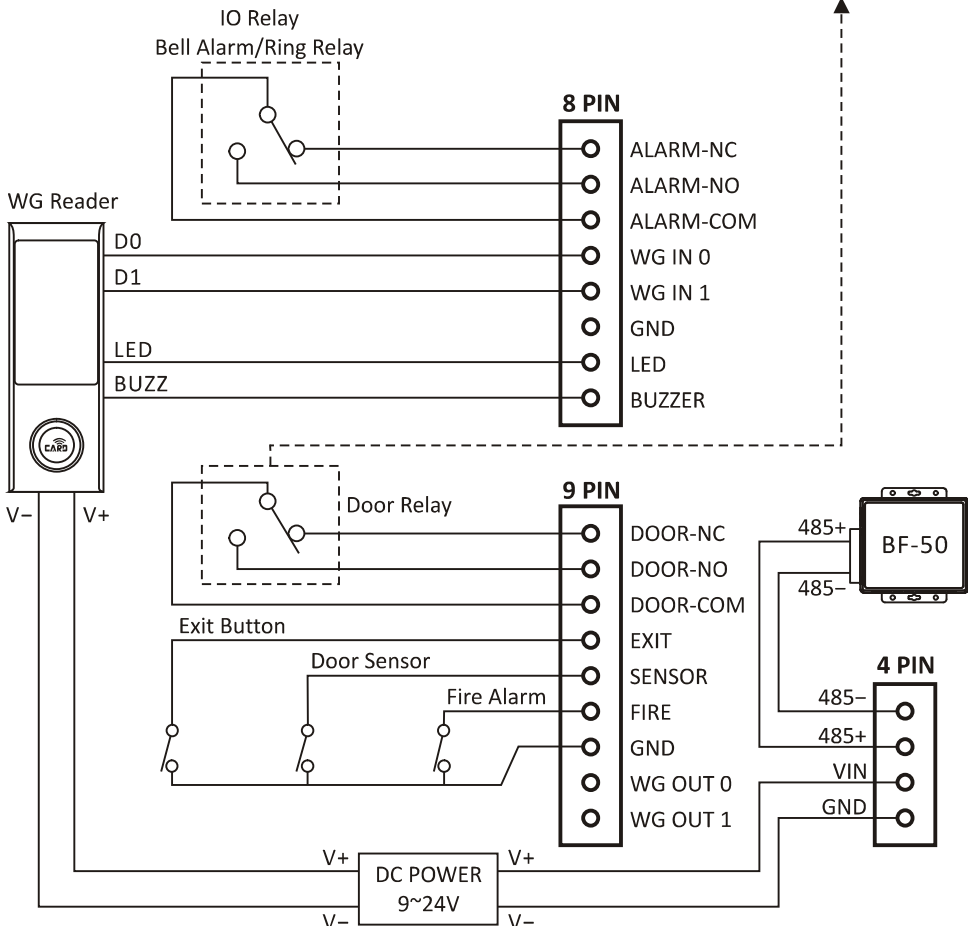
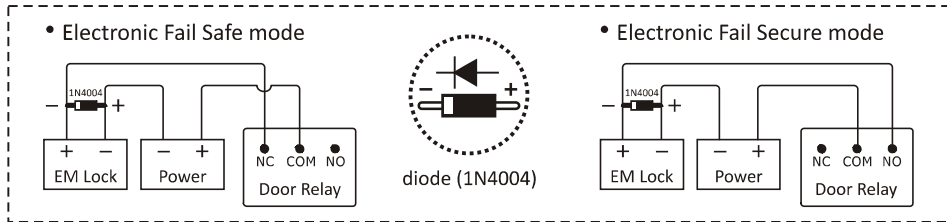

K. Cable description

4 PIN

485-	GRAY	For Relay Box BF-50
485+	BROWN	
VIN	RED	DC 9~24V (1A)
GND	BLACK	

8 PIN

ALARM-NC	YELLOW BLACK	IO Relay Bell Alarm/ Ring Relay
ALARM-NO	WHITE BLACK	
ALARM-COM	GREEN BLACK	
WG IN 0	RED WHITE	WG Input Connect WG Reader
WG IN 1	BLACK WHITE	
GND	BLACK	GND
LED	ORANGE	Control WG Reader LED/ Buzzer Action
BUZZER	PINK BLACK	

9 PIN

DOOR-NC	YELLOW	Door Relay
DOOR-NO	WHITE	
DOOR-COM	GREEN	
EXIT	VIOLET	Exit Button
SENSOR	BLUE	Door Sensor
FIRE	PINK	Fire Alarm
GND	BLACK	GND
WG OUT 0	GRAY BLUE	WG Output
WG OUT 1	ORANGE BLACK	

FCC Warning

This device complies with part 15 of the FCC rules. Operation is subject to the following two conditions: (1) this device may not cause harmful interference, and (2) this device must accept any interference received, including interference that may cause undesired operation.

Changes or modifications not expressly approved by the party responsible for compliance could void the user's authority to operate the equipment.

NOTE: This equipment has been tested and found to comply with the limits for a Class B digital device, pursuant to part 15 of the FCC Rules. These limits are designed to provide reasonable protection against harmful interference in a residential installation. This equipment generates uses and can radiate radio frequency energy and, if not installed and used in accordance with the instructions, may cause harmful interference to radio communications. However, there is no guarantee that interference will not occur in a particular installation. If this equipment does cause harmful interference to radio or television reception, which can be determined by turning the equipment off and on, the user is encouraged to try to correct the interference by one or more of the following measures:

- Reorient or relocate the receiving antenna.
- Increase the separation between the equipment and receiver.
- Connect the equipment into an outlet on a circuit different from that to which the receiver is connected.
- Consult the dealer or an experienced radio/TV technician for help.

Radiation Exposure Statement

This equipment complies with FCC radiation exposure limits set forth for an uncontrolled environment. This equipment should be installed and operated with minimum distance 20cm between the radiator and your body.