



# FCC RF Test Report

**APPLICANT** : PAX Technology Limited  
**EQUIPMENT** : Smart Tablet  
**BRAND NAME** : PAX  
**MODEL NAME** : Aries6  
**FCC ID** : V5PAR6  
**STANDARD** : FCC Part 15 Subpart C §15.247  
**CLASSIFICATION** : (DTS) Digital Transmission System

The product was received on Apr. 11, 2019 and testing was completed on Jun. 14, 2019. We, Sporton International (Shenzhen) Inc., would like to declare that the tested sample has been evaluated in accordance with the test procedures and has been in compliance with the applicable technical standards.

The test results in this report apply exclusively to the tested model / sample. Without written approval of Sporton International (Shenzhen) Inc., the test report shall not be reproduced except in full.

*Derreck Chen*

Reviewed by: Derreck Chen / Supervisor

*Eric Shih*

Approved by: Eric Shih / Manager



**Sporton International (ShenZhen) Inc.**

**1/F, 2/F, Bldg 5, Shiling Industrial Zone, Xinwei Village, Xili, Nanshan, Shenzhen, 518055**

**People's Republic of China**



# TABLE OF CONTENTS

**REVISION HISTORY..... 3**

**SUMMARY OF TEST RESULT ..... 4**

**1 GENERAL DESCRIPTION..... 5**

    1.1 Applicant ..... 5

    1.2 Manufacturer ..... 5

    1.3 Product Feature of Equipment Under Test..... 5

    1.4 Product Specification of Equipment Under Test..... 5

    1.5 Modification of EUT ..... 6

    1.6 Testing Location ..... 6

    1.7 Applicable Standards..... 6

**2 TEST CONFIGURATION OF EQUIPMENT UNDER TEST..... 7**

    2.1 Carrier Frequency Channel ..... 7

    2.2 Test Mode ..... 8

    2.3 Connection Diagram of Test System..... 9

    2.4 Support Unit used in test configuration and system ..... 10

    2.5 EUT Operation Test Setup ..... 10

    2.6 Measurement Results Explanation Example..... 10

**3 TEST RESULT ..... 11**

    3.1 6dB and 99% Bandwidth Measurement ..... 11

    3.2 Output Power Measurement..... 16

    3.3 Power Spectral Density Measurement ..... 17

    3.4 Conducted Band Edges and Spurious Emission Measurement ..... 22

    3.5 Radiated Band Edges and Spurious Emission Measurement ..... 27

    3.6 AC Conducted Emission Measurement..... 31

    3.7 Antenna Requirements ..... 33

**4 LIST OF MEASURING EQUIPMENT..... 34**

**5 UNCERTAINTY OF EVALUATION..... 35**

**APPENDIX A. CONDUCTED TEST RESULTS**

**APPENDIX B. AC CONDUCTED EMISSION TEST RESULT**

**APPENDIX C. RADIATED SPURIOUS EMISSION**

**APPENDIX D. DUTY CYCLE PLOTS**

**APPENDIX E. SETUP PHOTOGRAPHS**



### REVISION HISTORY

| REPORT NO. | VERSION | DESCRIPTION             | ISSUED DATE   |
|------------|---------|-------------------------|---------------|
| FR941109B  | Rev. 01 | Initial issue of report | Aug. 02, 2019 |
|            |         |                         |               |
|            |         |                         |               |
|            |         |                         |               |
|            |         |                         |               |
|            |         |                         |               |
|            |         |                         |               |
|            |         |                         |               |
|            |         |                         |               |
|            |         |                         |               |
|            |         |                         |               |
|            |         |                         |               |
|            |         |                         |               |
|            |         |                         |               |
|            |         |                         |               |
|            |         |                         |               |
|            |         |                         |               |
|            |         |                         |               |
|            |         |                         |               |
|            |         |                         |               |



### SUMMARY OF TEST RESULT

| Report Section | FCC Rule           | Description                                | Limit                          | Result | Remark  |
|----------------|--------------------|--|--------------------------------|--------|---|
| 3.1            | 15.247(a)(2)       | 6dB Bandwidth                              | $\geq 0.5\text{MHz}$           | Pass   | -   |
| 3.1            | -                  | 99% Bandwidth                              | -                              | Pass   | -   |
| 3.2            | 15.247(b)(3)       | Peak Output Power                          | $\leq 30\text{dBm}$            | Pass   | -   |
| 3.3            | 15.247(e)          | Power Spectral Density                     | $\leq 8\text{dBm}/3\text{kHz}$ | Pass   | -   |
| 3.4            | 15.247(d)          | Conducted Band Edges and Spurious Emission | $\leq 20\text{dBc}$            | Pass   | -   |
| 3.5            | 15.247(d)          | Radiated Band Edges and Spurious Emission  | 15.209(a) & 15.247(d)          | Pass   | Under limit<br>3.54 dB at<br>30.000 MHz<br>for Quasi-Peak |
| 3.6            | 15.207             | AC Conducted Emission                      | 15.207(a)                      | Pass   | Under limit<br>5.90 dB at<br>0.640 MHz                    |
| 3.7            | 15.203 & 15.247(b) | Antenna Requirement                        | N/A                            | Pass   | -   |



# 1 General Description

## 1.1 Applicant

**PAX Technology Limited**

Room 2416, 24/F., Sun Hung Kai Centre, 30 Harbour Road, Wanchai, Hong Kong

## 1.2 Manufacturer

**PAX Computer Technology (Shenzhen) Co., Ltd.**

4/F, No.3 Building, Software Park, Second Central Science-Tech Road, High-Tech industrial Park, Shenzhen, Guangdong, P.R.C.

## 1.3 Product Feature of Equipment Under Test

| Product Feature                        |  |
|--|--|
| <b>Equipment</b>                       | Smart Tablet   |
| <b>Brand Name</b>                      | PAX  |
| <b>Model Name</b>                      | Aries6   |
| <b>FCC ID</b>                          | V5PAR6   |
| <b>EUT supports Radios application</b> | WCDMA/HSPA/DC-HSDPA/HSPA+(16QAM uplink is not supported)/LTE/GPS/NFC<br>WLAN 2.4GHz 802.11b/g/n HT20<br>WLAN 5GHz 802.11a/n HT20/HT40<br>WLAN 5GHz 802.11ac VHT20/VHT40/VHT80<br>Bluetooth BR/EDR/LE |
| <b>IMEI Code</b>                       | Conducted: 866732039393476<br>Conduction: 866732039389946<br>Radiation: 866732039389581  |
| <b>HW Version</b>                      | N/A  |
| <b>SW Version</b>                      | N/A  |
| <b>EUT Stage</b>                       | Production Unit  |

**Remark:** The above EUT's information was declared by manufacturer. Please refer to the specifications or user's manual for more detailed description.

## 1.4 Product Specification of Equipment Under Test

| Standards-related Product Specification  |  |
|--|--|
| <b>Tx/Rx Frequency Range</b>             | 2402 MHz ~ 2480 MHz                            |
| <b>Number of Channels</b>                | 40   |
| <b>Carrier Frequency of Each Channel</b> | 40 Channel(37 hopping + 3 advertising channel) |
| <b>Maximum Output Power to Antenna</b>   | 3.70 dBm (0.0023 W)                            |
| <b>99% Occupied Bandwidth</b>            | 1.051MHz                                       |
| <b>Antenna Type / Gain</b>               | Internal Antenna with gain 1.50 dBi            |
| <b>Type of Modulation</b>                | Bluetooth LE : GFSK                            |



### 1.5 Modification of EUT

No modifications are made to the EUT during all test items.

### 1.6 Testing Location

Sporton International (Shenzhen) Inc. is accredited to ISO/IEC 17025:2017 by American Association for Laboratory Accreditation with Certificate Number 5145.01.

|                           |   |                            |                                       |
|---------------------------|---|----------------------------|---------------------------------------|
| <b>Test Firm</b>          | Sporton International (Shenzhen) Inc.   |                            |                                       |
| <b>Test Site Location</b> | 1/F, 2/F, Bldg 5, Shiling Industrial Zone, Xinwei Village, Xili, Nanshan, Shenzhen, 518055 People's Republic of China<br>TEL: +86-755-86379589<br>FAX: +86-755-86379595 |                            |                                       |
| <b>Test Site No.</b>      | <b>Sporton Site No.</b>   | <b>FCC Designation No.</b> | <b>FCC Test Firm Registration No.</b> |
|                           | CO01-SZ<br>TH01-SZ  | CN1256                     | 421272                                |

|                           |   |                            |                                       |
|---------------------------|---|----------------------------|---------------------------------------|
| <b>Test Firm</b>          | Sporton International (Shenzhen) Inc.   |                            |                                       |
| <b>Test Site Location</b> | No. 3 Bldg the third floor of south, Shahe River west, Fengzeyuan Warehouse, Nanshan Shenzhen, 518055 People's Republic of China<br>TEL: +86-755-33202398 |                            |                                       |
| <b>Test Site No.</b>      | <b>Sporton Site No.</b>   | <b>FCC Designation No.</b> | <b>FCC Test Firm Registration No.</b> |
|                           | 03CH03-SZ   | CN1256                     | 421272                                |

### 1.7 Applicable Standards

According to the specifications of the manufacturer, the EUT must comply with the requirements of the following standards:

- 47 CFR Part 15 Subpart C §15.247
- FCC KDB 558074 D01 15.247 Meas Guidance v05r02
- ANSI C63.10-2013

**Remark:**

1. All test items were verified and recorded according to the standards and without any deviation during the test.
2. This EUT has also been tested and complied with the requirements of FCC Part 15, Subpart B, recorded in a separate test report.



## 2 Test Configuration of Equipment Under Test

### 2.1 Carrier Frequency Channel

| Frequency Band  | Channel | Freq. (MHz) | Channel | Freq. (MHz) |
|-----------------|---------|-------------|---------|-------------|
| 2400-2483.5 MHz | 0       | 2402        | 21      | 2444        |
|                 | 1       | 2404        | 22      | 2446        |
|                 | 2       | 2406        | 23      | 2448        |
|                 | 3       | 2408        | 24      | 2450        |
|                 | 4       | 2410        | 25      | 2452        |
|                 | 5       | 2412        | 26      | 2454        |
|                 | 6       | 2414        | 27      | 2456        |
|                 | 7       | 2416        | 28      | 2458        |
|                 | 8       | 2418        | 29      | 2460        |
|                 | 9       | 2420        | 30      | 2462        |
|                 | 10      | 2422        | 31      | 2464        |
|                 | 11      | 2424        | 32      | 2466        |
|                 | 12      | 2426        | 33      | 2468        |
|                 | 13      | 2428        | 34      | 2470        |
|                 | 14      | 2430        | 35      | 2472        |
|                 | 15      | 2432        | 36      | 2474        |
|                 | 16      | 2434        | 37      | 2476        |
|                 | 17      | 2436        | 38      | 2478        |
|                 | 18      | 2438        | 39      | 2480        |
|                 | 19      | 2440        | -       | -           |
| 20              | 2442    | -           | -       |             |

## 2.2 Test Mode

- a. The EUT has been associated with peripherals and configuration operated in a manner tended to maximize its emission characteristics in a typical application. Frequency range investigated: conduction emission (150 kHz to 30 MHz), radiation emission (9 kHz to the 10th harmonic of the highest fundamental frequency or to 40 GHz, whichever is lower). For radiated measurement, pre-scanned in three orthogonal panels, X, Y, Z. The worst cases (Y plane) were recorded in this report.
  
- b. AC power line Conducted Emission was tested under maximum output power.

The following summary table is showing all test modes to demonstrate in compliance with the standard.

| Summary table of Test Cases  |  |
|--|--|
| Test Item  | Data Rate / Modulation   |
|  | Bluetooth – LE / GFSK  |
| <b>Conducted TCs</b>   | Mode 1: Bluetooth Tx CH00_2402 MHz_1Mbps<br>Mode 2: Bluetooth Tx CH19_2440 MHz_1Mbps<br>Mode 3: Bluetooth Tx CH39_2480 MHz_1Mbps |
| <b>Radiated TCs</b>  | Mode 1: Bluetooth Tx CH00_2402 MHz_1Mbps<br>Mode 2: Bluetooth Tx CH19_2440 MHz_1Mbps<br>Mode 3: Bluetooth Tx CH39_2480 MHz_1Mbps |
| <b>AC Conducted Emission</b>   | Mode 1: WCDMA Band II Idle + Bluetooth Link + WLAN Link (2.4G) + USB Cable(Charging from Adapter) + Earphone                     |
| <b>Remark:</b> For Radiated Test Cases, The tests were performed with Adapter, Earphone and USB Cable. |  |



## 2.3 Connection Diagram of Test System

For Radiation

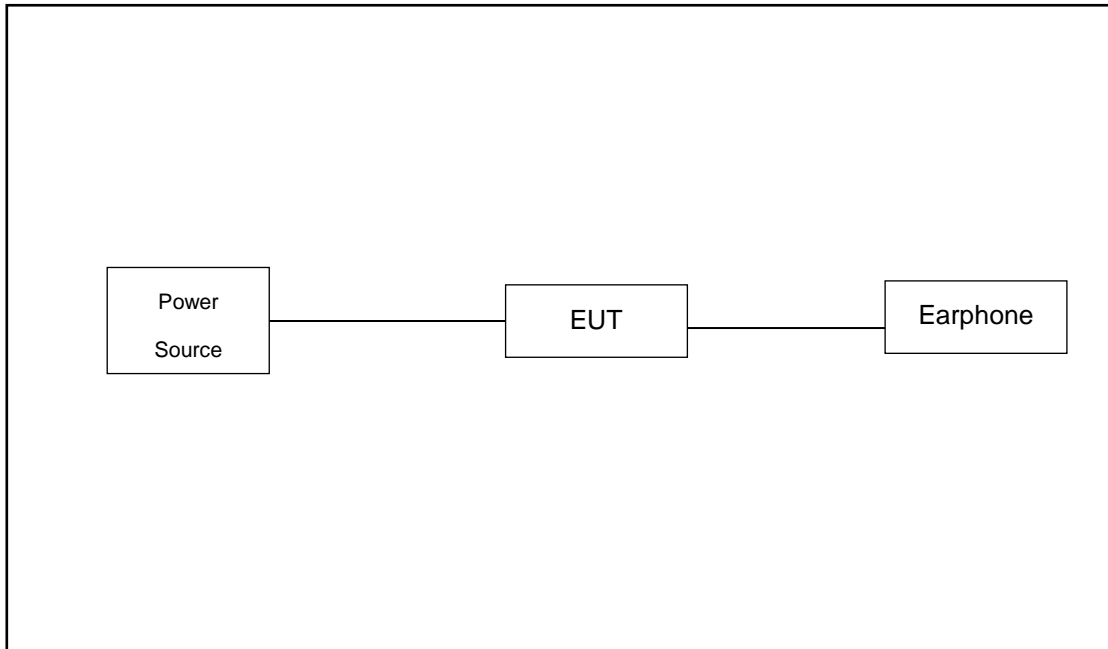

For Conducted Emission

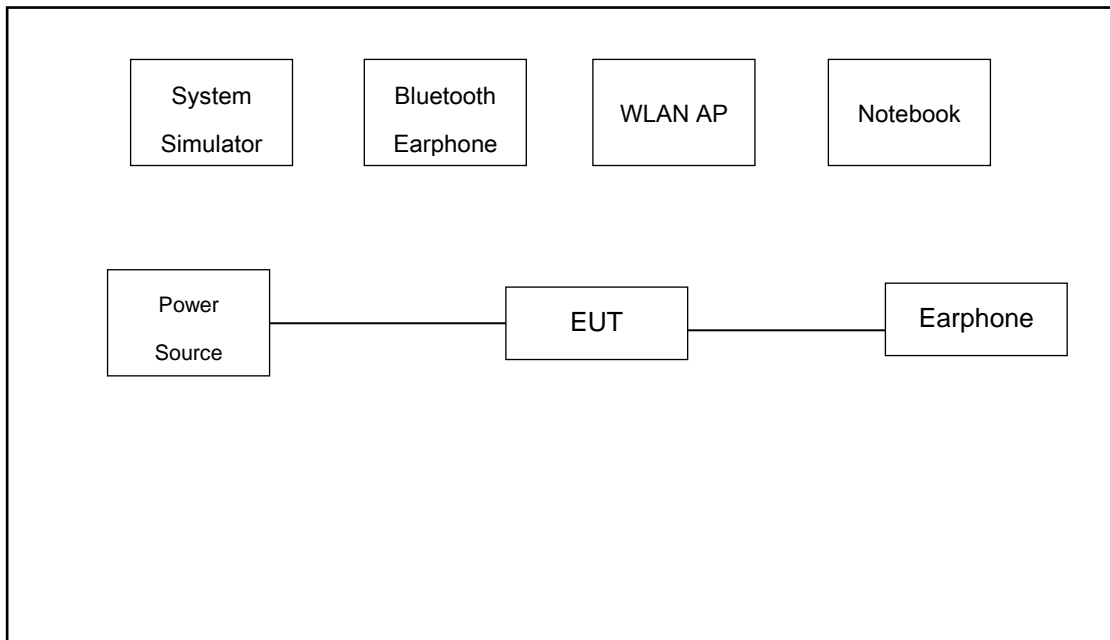

## 2.4 Support Unit used in test configuration and system

| Item | Equipment          | Trade Name | Model Name | FCC ID      | Data Cable     | Power Cord   |
|------|--------------------|------------|------------|-------------|----------------|--|
| 1.   | System Simulator   | Anritsu    | MT8820C    | N/A         | N/A            | Unshielded, 1.8m   |
| 2.   | WLAN AP            | D-Link     | DIR-820L   | KA21R820LA1 | N/A            | Unshielded, 1.8m   |
| 3.   | Notebook           | Lenovo     | E540       | FCC DoC     | N/A            | AC I/P:<br>Unshielded, 1.2 m<br>DC O/P:<br>Shielded, 1.8 m |
| 4.   | Earphone           | Apple      | MC690ZP/A  | N/A         | Shielded, 1.0m | N/A  |
| 5.   | Bluetooth Earphone | Samsung    | EO-MG900   | N/A         | N/A            | N/A  |

## 2.5 EUT Operation Test Setup

For BLE function, the engineering test program was provided and enabled to make EUT continuous transmit/receive.

For AC power line conducted emissions, the EUT was set to connect with the WLAN AP under large package sizes transmission.

## 2.6 Measurement Results Explanation Example

**For all conducted test items:**

The offset level is set in the spectrum analyzer to compensate the RF cable loss and attenuator factor between EUT conducted output port and spectrum analyzer. With the offset compensation, the spectrum analyzer reading level is exactly the EUT RF output level.

Example :

The spectrum analyzer offset is derived from RF cable loss and attenuator factor.

*Offset = RF cable loss + attenuator factor.*

Following shows an offset computation example with cable loss 5.0 dB and 10dB attenuator.

$$\begin{aligned}
 \text{Offset(dB)} &= \text{RF cable loss(dB)} + \text{attenuator factor(dB)}. \\
 &= 5.0 + 10 = 15.0 \text{ (dB)}
 \end{aligned}$$

### 3 Test Result

#### 3.1 6dB and 99% Bandwidth Measurement

##### 3.1.1 Limit of 6dB and 99% Bandwidth

The minimum 6 dB bandwidth shall be at least 500 kHz.

##### 3.1.2 Measuring Instruments

The section 4.0 of List of Measuring Equipment of this test report is used for test.

##### 3.1.3 Test Procedures

1. The testing follows ANSI C63.10-2013 clause 11.8
2. The RF output of EUT was connected to the spectrum analyzer by RF cable and attenuator. The path loss was compensated to the results for each measurement.
3. Set to the maximum power setting and enable the EUT transmit continuously.
4. Make the measurement with the spectrum analyzer's resolution bandwidth (RBW) = 100 kHz. Set the Video bandwidth (VBW) = 300 kHz. In order to make an accurate measurement. The 6 dB bandwidth must be greater than 500 kHz.
5. For 99% Bandwidth Measurement, the spectrum analyzer's resolution bandwidth (RBW) is set 30kHz and set the Video bandwidth (VBW) = 100kHz.
6. Measure and record the results in the test report.

##### 3.1.4 Test Setup





### 3.1.5 Test Result of 6dB Bandwidth

Please refer to Appendix A.

6 dB Bandwidth Plot on Channel 00

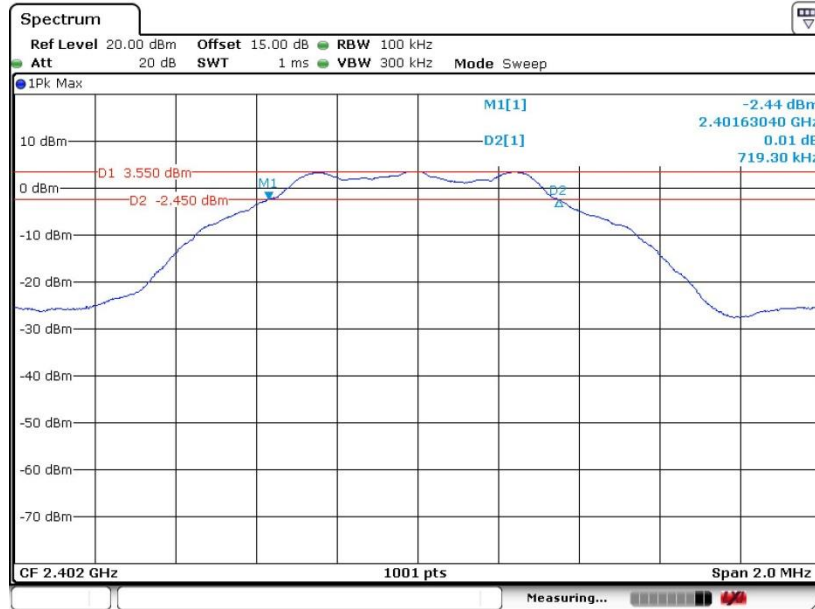

Date: 6 JUN.2019 23:01:42

6 dB Bandwidth Plot on Channel 19

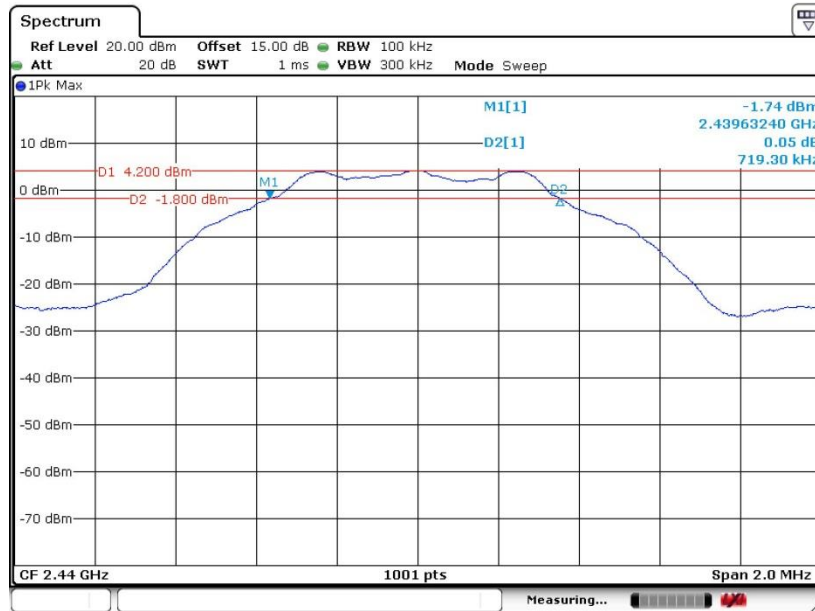

Date: 6 JUN.2019 23:06:08



6 dB Bandwidth Plot on Channel 39

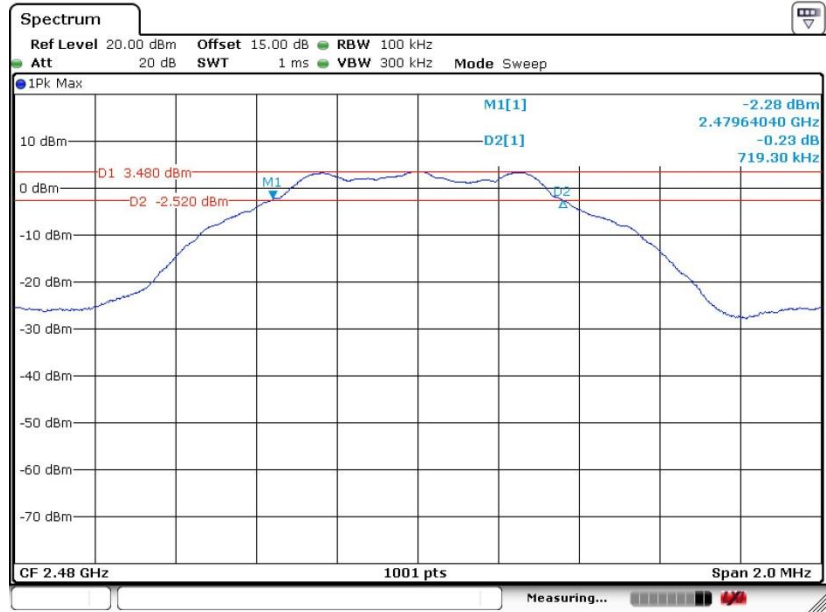

Date: 6 JUN 2019 23:09:40



### 3.1.6 Test Result of 99% Occupied Bandwidth

Please refer to Appendix A.

#### 99% Bandwidth Plot on Channel 00

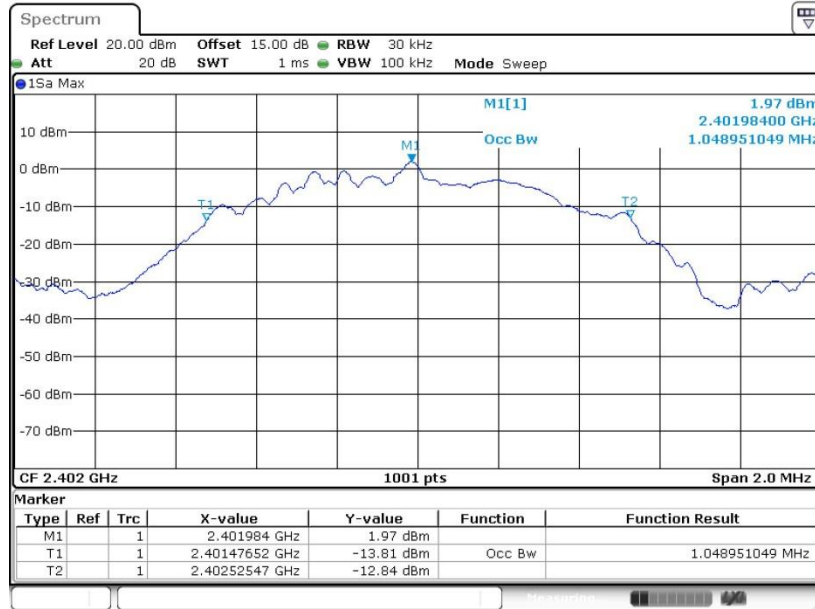

Date: 6 JUN.2019 23:04:11

#### 99% Occupied Bandwidth Plot on Channel 19

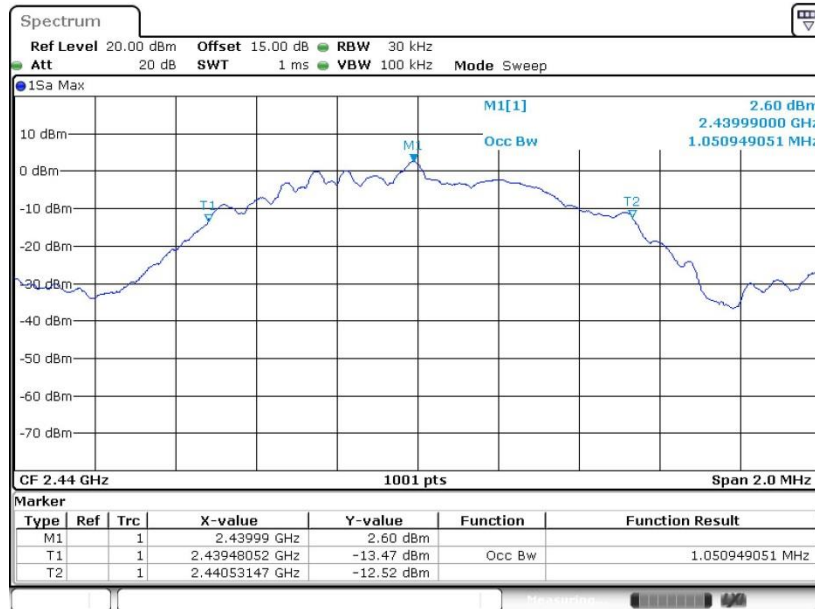

Date: 6 JUN.2019 23:08:08



99% Occupied Bandwidth Plot on Channel 39

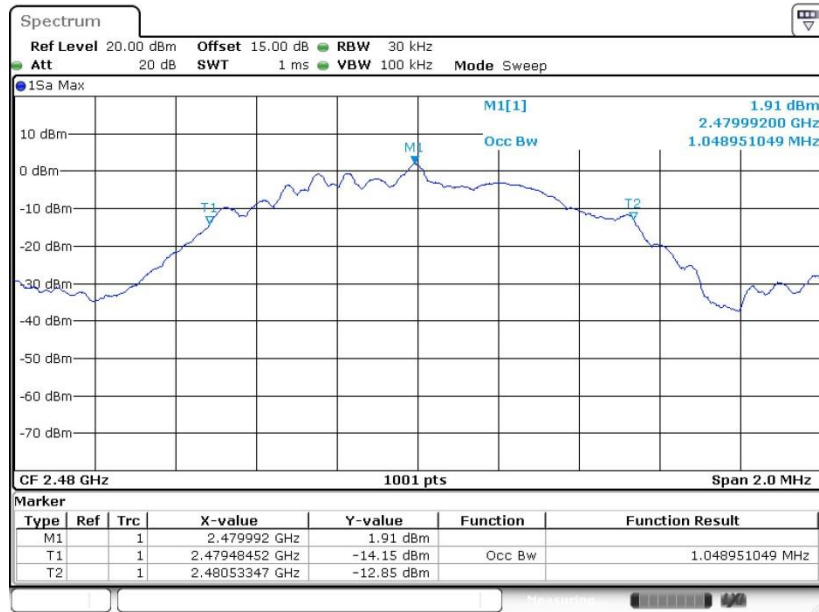

Date: 6 JUN.2019 23:11:54

Note : The occupied channel bandwidth is maintained within the band of operation for all of the modulations.

## 3.2 Output Power Measurement

### 3.2.1 Limit of Output Power

For systems using digital modulation in the 2400-2483.5MHz, the limit for output power is 30dBm. If transmitting antenna of directional gain greater than 6dBi is used, the output power from the intentional radiator shall be reduced below the above stated value by the amount in dB that the directional gain of the antenna exceeds 6 dBi. In case of point-to-point operation, the limit has to be reduced by 1dB for every 3dB that the directional gain of the antenna exceeds 6dBi.

### 3.2.2 Measuring Instruments

The section 4.0 of List of Measuring Equipment of this test report is used for test.

### 3.2.3 Test Procedures

1. The testing follows the Measurement Procedure of ANSI C63.10-2013 clause 11.9.1.3 PKPM1 Peak power meter or ANSI C63.10-2013 clause 11.9.2.3.2 Method AVGPM-G method.
2. The RF output of EUT was connected to the power meter by RF cable and attenuator. The path loss was compensated to the results for each measurement.
3. Set to the maximum power setting and enable the EUT transmit continuously.
4. Measure the conducted output power and record the results in the test report.

### 3.2.4 Test Setup

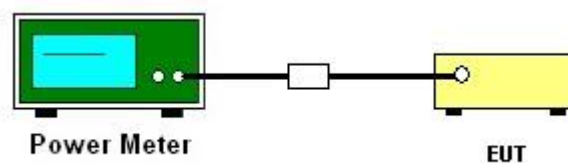

### 3.2.5 Test Result of Average Output Power

Please refer to Appendix A.



### 3.3 Power Spectral Density Measurement

#### 3.3.1 Limit of Power Spectral Density

The power spectral density shall not be greater than 8dBm in any 3kHz band at any time interval of continuous transmission.

#### 3.3.2 Measuring Instruments

The section 4.0 of List of Measuring Equipment of this test report is used for test.

#### 3.3.3 Test Procedures

1. The testing follows Measurement Procedure of ANSI C63.10-2013 clause 11.10.2 Method PKPSD.
2. The RF output of EUT was connected to the spectrum analyzer by RF cable and attenuator. The path loss was compensated to the results for each measurement.
3. Set to the maximum power setting and enable the EUT transmit continuously.
4. Make the measurement with the spectrum analyzer's resolution bandwidth (RBW) = 3 kHz. Video bandwidth VBW = 10 kHz In order to make an accurate measurement, set the span to 1.5 times DTS Channel Bandwidth. (6dB BW)
5. Detector = peak, Sweep time = auto couple, Trace mode = max hold, Allow trace to fully stabilize. Use the peak marker function to determine the maximum power level.
6. Measure and record the results in the test report.
7. The Measured power density (dBm)/ 100kHz is a reference level and used as 20dBc down limit line for Conducted Band Edges and Conducted Spurious Emission.

#### 3.3.4 Test Setup

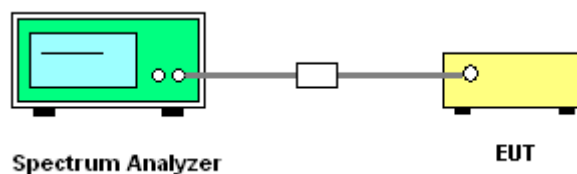

#### 3.3.5 Test Result of Power Spectral Density

Please refer to Appendix A.



### 3.3.6 Test Result of Power Spectral Density Plots (100kHz)

PSD 100kHz Plot on Channel 00

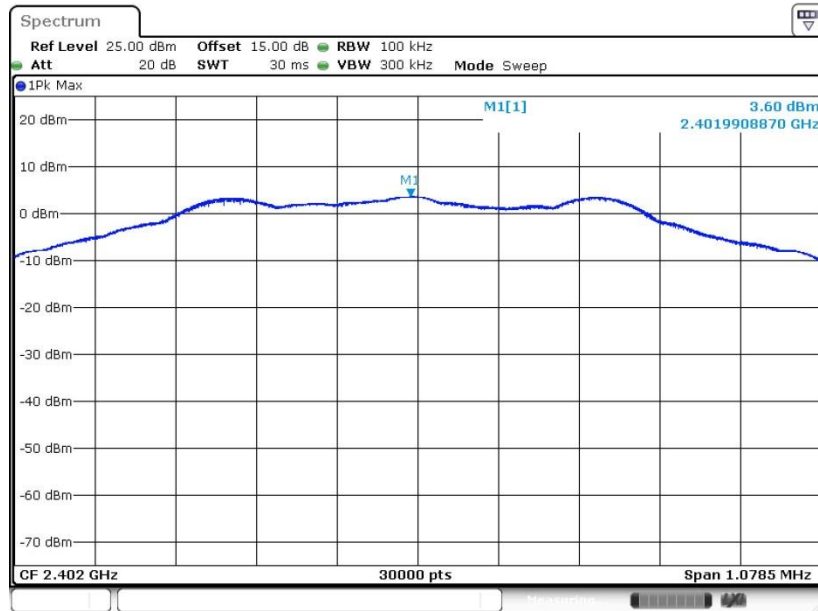

Date: 6 JUN.2019 23:02:34

PSD 100kHz Plot on Channel 19

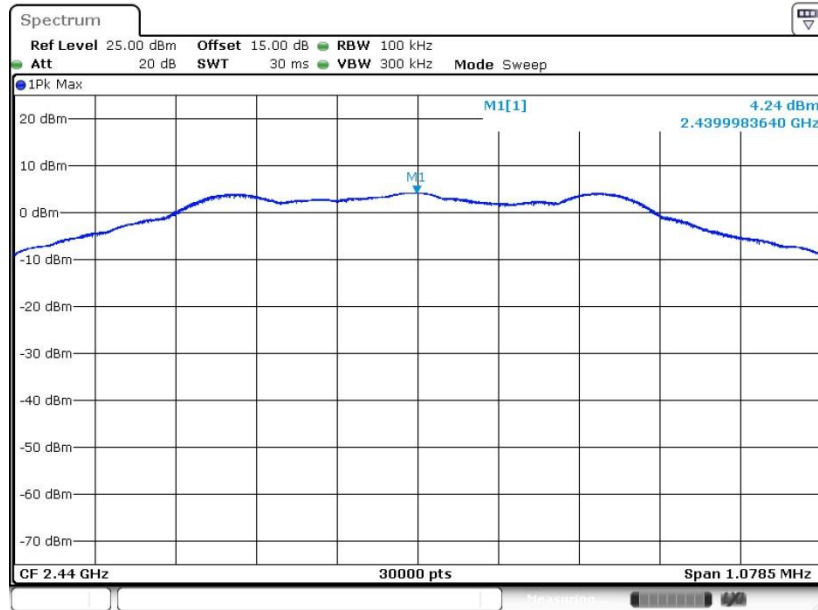

Date: 6 JUN.2019 23:07:07



PSD 100kHz Plot on Channel 39

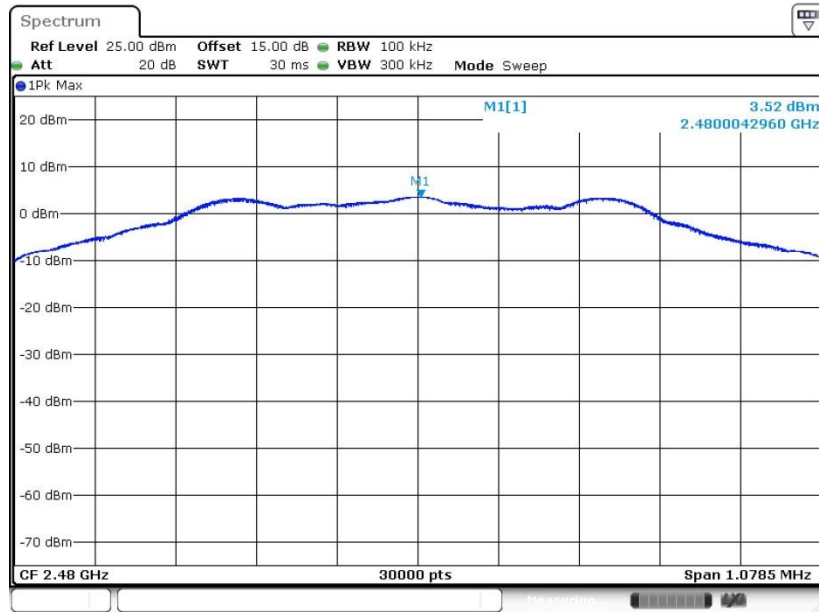

Date: 6 JUN.2019 23:10:43



### 3.3.7 Test Result of Power Spectral Density Plots (3kHz)

PSD 3kHz Plot on Channel 00

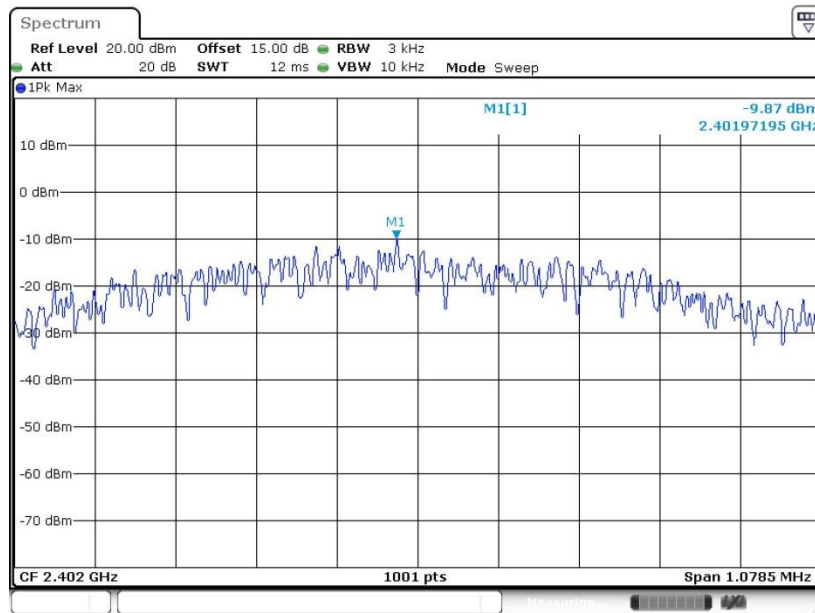

Date: 6 JUN.2019 23:02:09

PSD 3kHz Plot on Channel 19

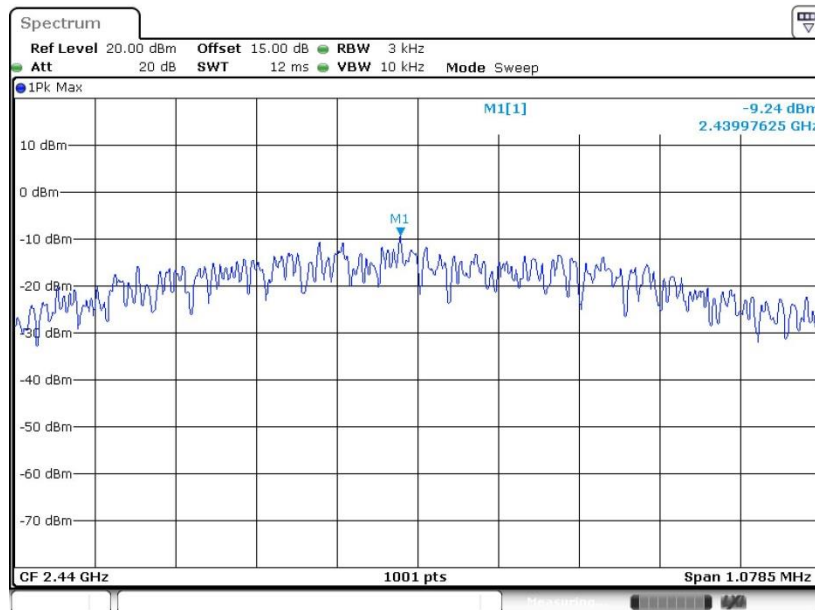

Date: 6 JUN.2019 23:06:33



PSD 3kHz Plot on Channel 39

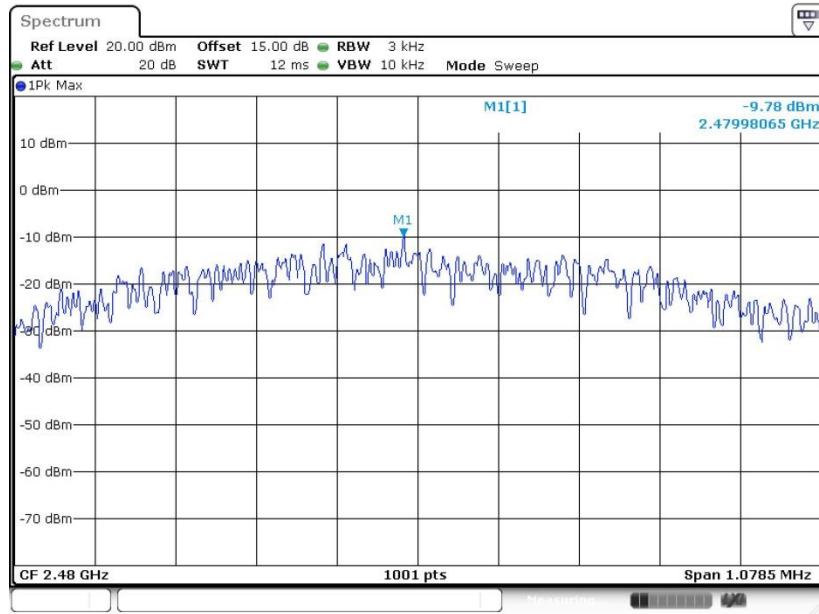

Date: 6 JUN.2019 23:10:11

## 3.4 Conducted Band Edges and Spurious Emission Measurement

### 3.4.1 Limit of Conducted Band Edges and Spurious Emission

All harmonics/spurious must be at least 20 dB down from the highest emission level within the authorized band.

### 3.4.2 Measuring Instruments

The section 4.0 of List of Measuring Equipment of this test report is used for test.

### 3.4.3 Test Procedure

1. The testing follows ANSI C63.10-2013 clause 11.13
2. The RF output of EUT was connected to the spectrum analyzer by RF cable and attenuator. The path loss was compensated to the results for each measurement.
3. Set to the maximum power setting and enable the EUT transmit continuously.
4. Set RBW = 100 kHz, VBW=300 kHz, Peak Detector. Unwanted Emissions measured in any 100 kHz bandwidth outside of the authorized frequency band shall be attenuated by at least 20 dB relative to the maximum in-band peak PSD level in 100 kHz when maximum peak conducted output power procedure is used. If the transmitter complies with the conducted power limits based on the use of RMS averaging over a time interval, the attenuation required under this paragraph shall be 30 dB instead of 20 dB.
5. Measure and record the results in the test report.
6. The RF fundamental frequency should be excluded against the limit line in the operating frequency band.

### 3.4.4 Test Setup

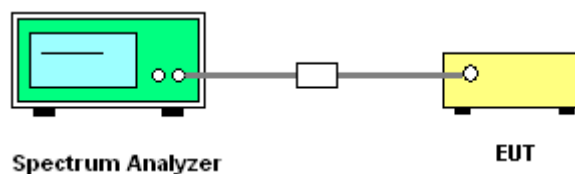



### 3.4.5 Test Result of Conducted Band Edges Plots

Low Band Edge Plot on Channel 00

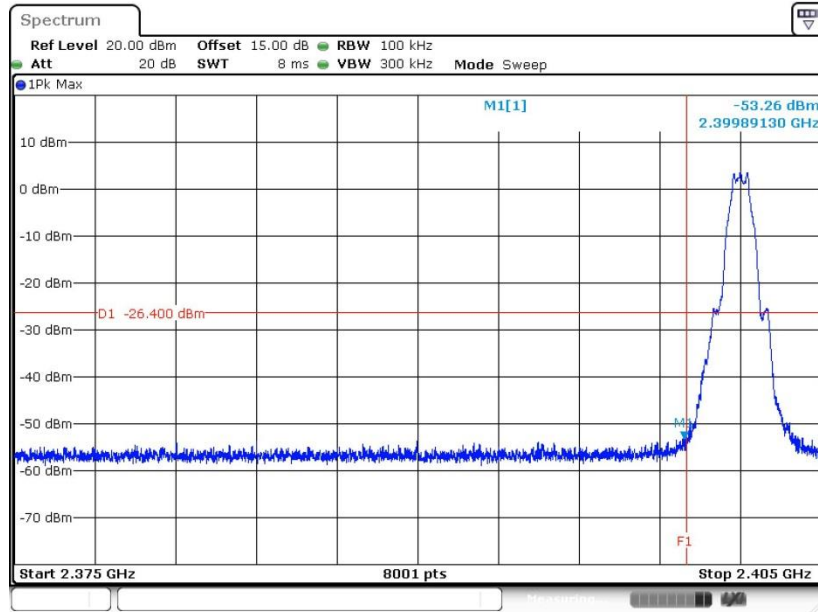

Date: 6 JUN 2019 23:03:25

High Band Edge Plot on Channel 39

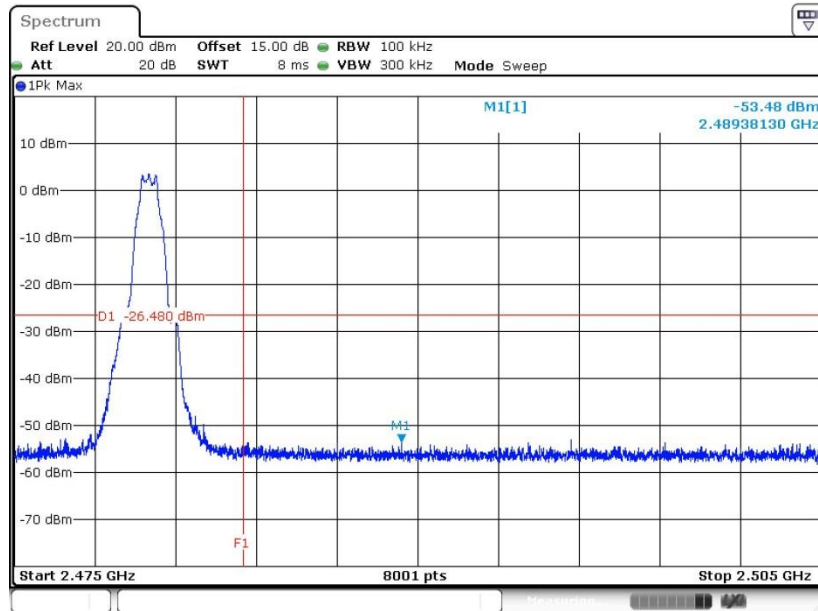

Date: 6 JUN 2019 23:11:06



### 3.4.6 Test Result of Conducted Spurious Emission Plots

#### Conducted Spurious Emission Plot on Bluetooth LE 1Mbps GFSK Channel 00

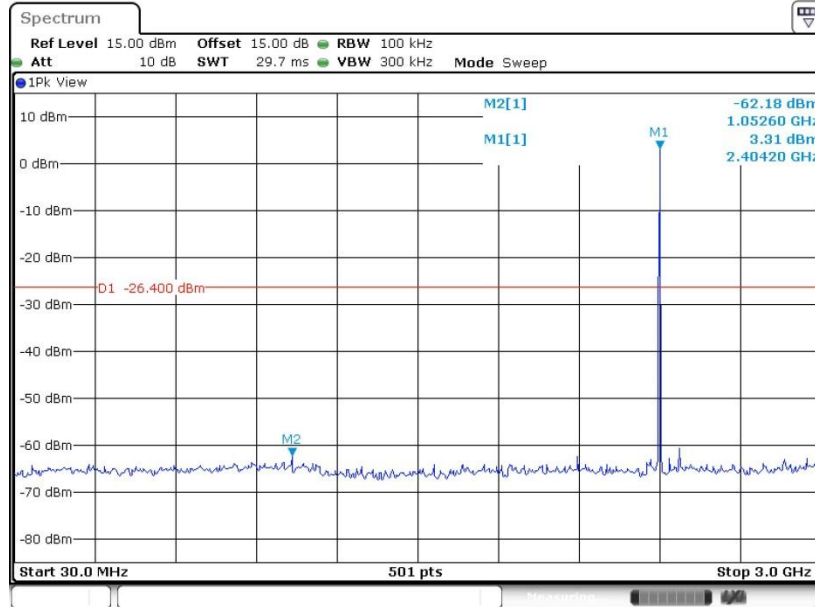

Date: 6 JUN 2019 23:03:42

#### Conducted Spurious Emission Plot on Bluetooth LE 1Mbps GFSK Channel 00

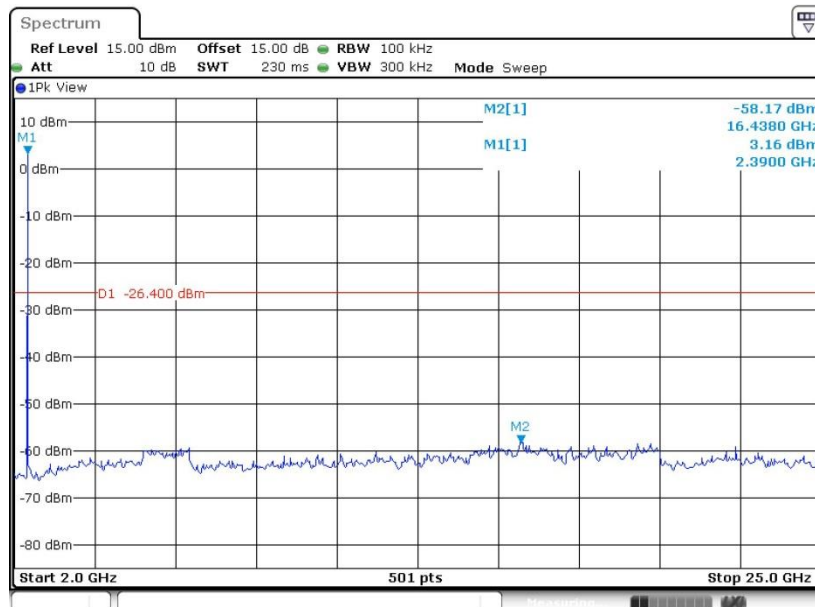

Date: 6 JUN 2019 23:03:54





Conducted Spurious Emission Plot on Bluetooth LE 1Mbps GFSK Channel 19

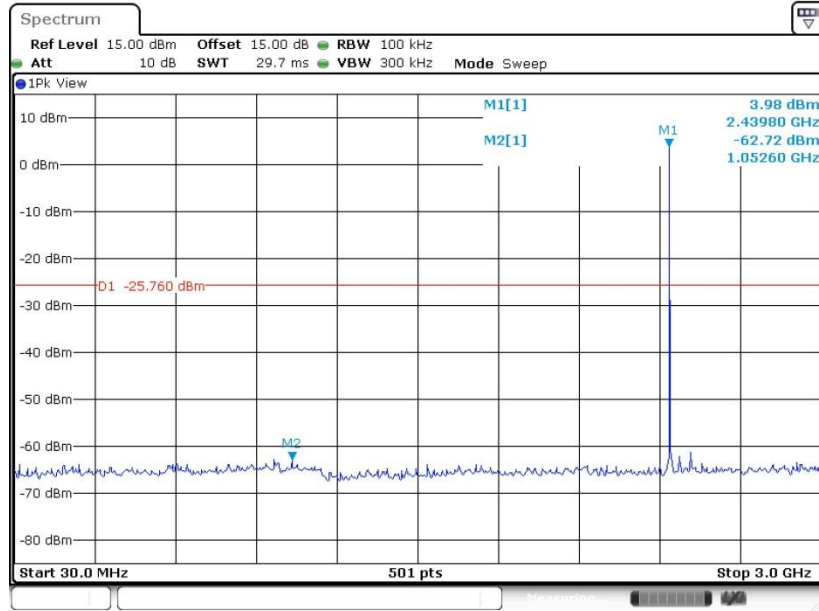

Date: 6 JUN, 2019 23:07:27

Conducted Spurious Emission Plot on Bluetooth LE 1Mbps GFSK Channel 19

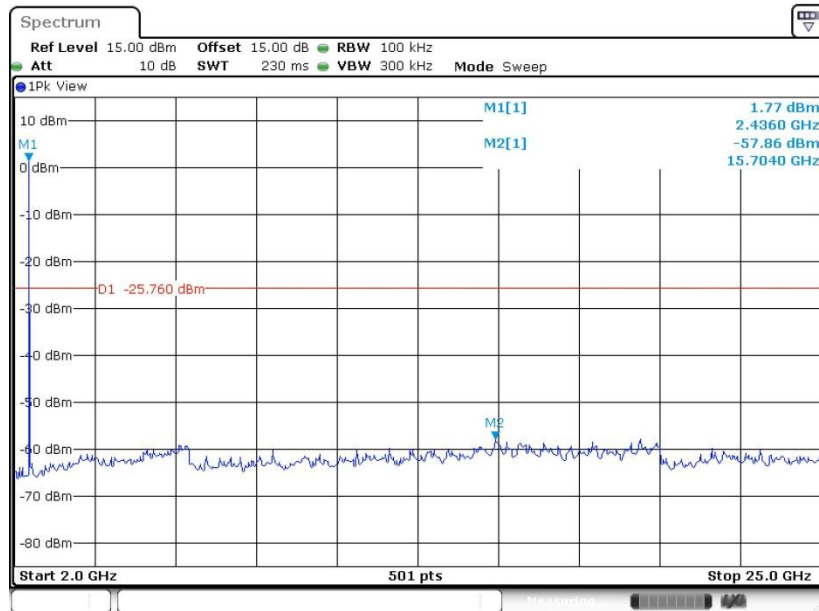

Date: 6 JUN, 2019 23:07:39



Conducted Spurious Emission Plot on Bluetooth LE 1Mbps GFSK Channel 39

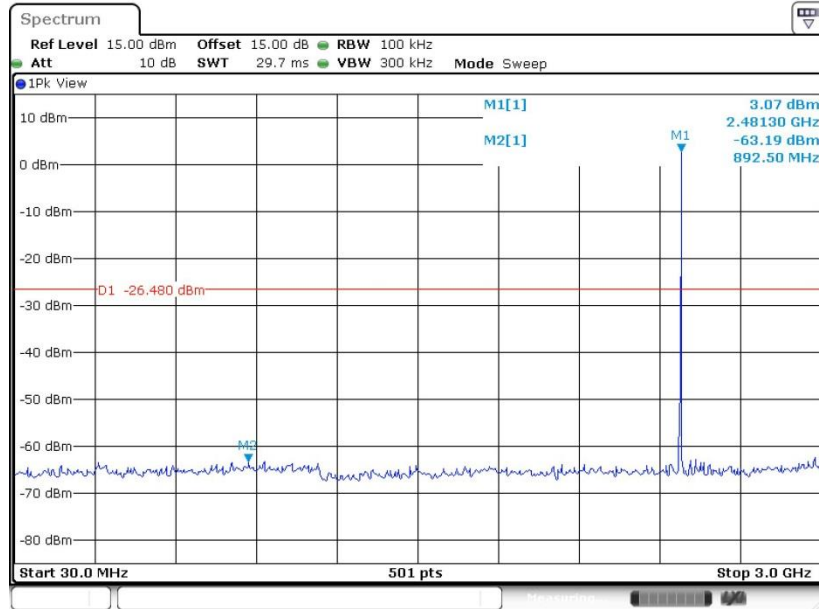

Date: 6 JUN 2019 23:11:20

Conducted Spurious Emission Plot on Bluetooth LE 1Mbps GFSK Channel 39

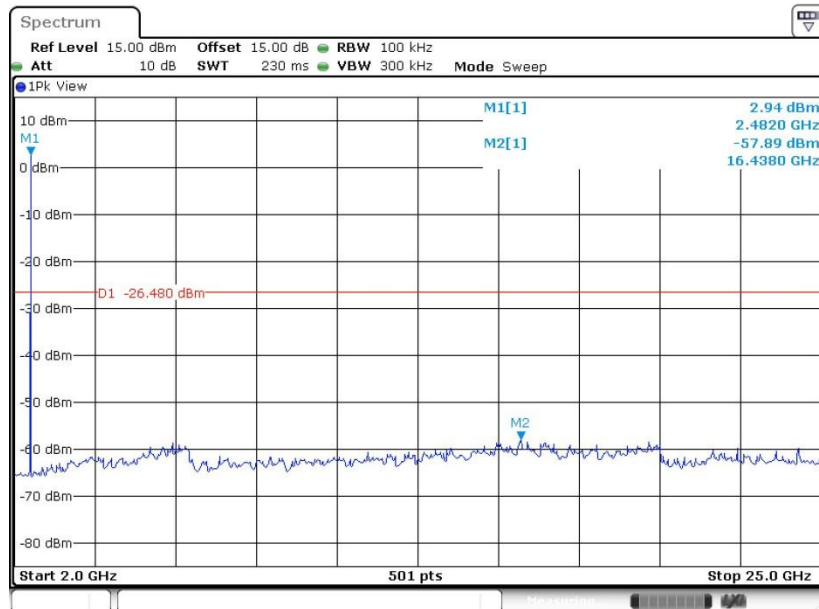

Date: 6 JUN 2019 23:11:34



### 3.5 Radiated Band Edges and Spurious Emission Measurement

#### 3.5.1 Limit of Radiated Band Edges and Spurious Emission

In any 100 kHz bandwidth outside the intentional radiator frequency band, all harmonics/spurious must be at least 20 dB below the highest emission level within the authorized band. If the output power of this device was measured by spectrum analyzer, the attenuation under this paragraph shall be 30 dB instead of 20 dB. In addition, radiated emissions which fall in the restricted bands must also comply with the limits as below.

| Frequency (MHz) | Field Strength (microvolts/meter) | Measurement Distance (meters) |
|-----------------|-----------------------------------|-------------------------------|
| 0.009 – 0.490   | 2400/F(kHz)                       | 300                           |
| 0.490 – 1.705   | 24000/F(kHz)                      | 30                            |
| 1.705 – 30.0    | 30                                | 30                            |
| 30 – 88         | 100                               | 3                             |
| 88 – 216        | 150                               | 3                             |
| 216 - 960       | 200                               | 3                             |
| Above 960       | 500                               | 3                             |

#### 3.5.2 Measuring Instruments

The section 4.0 of List of Measuring Equipment of this test report is used for test.



### 3.5.3 Test Procedures

1. The testing follows ANSI C63.10-2013 clause 11.11 & 11.12
2. The EUT was arranged to its worst case and then tune the antenna tower (from 1 m to 4 m) and turntable (from 0 degree to 360 degrees) to find the maximum reading. A pre-amp and a high pass filter are used for the test in order to get better signal level.
3. The EUT was placed on a turntable with 0.8 meter for frequency below 1GHz and 1.5 meter for frequency above 1GHz respectively above ground.
4. The EUT was set 3 meters from the interference receiving antenna, which was mounted on the top of a variable height antenna tower.
5. Corrected Reading: Antenna Factor + Cable Loss + Read Level - Preamp Factor = Level
6. For testing below 1GHz, if the emission level of the EUT in peak mode was 3 dB lower than the limit specified, then peak values of EUT will be reported, otherwise, the emissions will be repeated one by one using the CISPR quasi-peak method and reported.
7. For testing above 1GHz, the emission level of the EUT in peak mode was 20dB lower than average limit (that means the emission level in average mode also complies with the limit in average mode), then peak values of EUT will be reported, otherwise, the emissions will be measured in average mode again and reported.
8. Use the following spectrum analyzer settings:
  - (1) Span shall wide enough to fully capture the emission being measured;
  - (2) Set RBW=100 kHz for  $f < 1$  GHz;  $VBW \geq RBW$ ; Sweep = auto; Detector function = peak; Trace = max hold;
  - (3) Set RBW = 1 MHz, VBW= 3MHz for  $f \geq 1$  GHz for peak measurement.  
For average measurement:
    - $VBW = 10$  Hz, when duty cycle is no less than 98 percent.
    - $VBW \geq 1/T$ , when duty cycle is less than 98 percent where T is the minimum transmission duration over which the transmitter is on and is transmitting at its maximum power control level for the tested mode of operation.

### 3.5.4 Test Setup

For radiated emissions below 30MHz

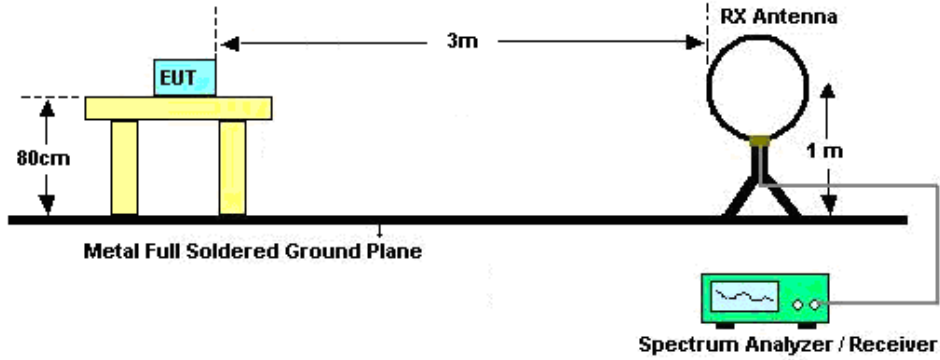

For radiated emissions from 30MHz to 1GHz

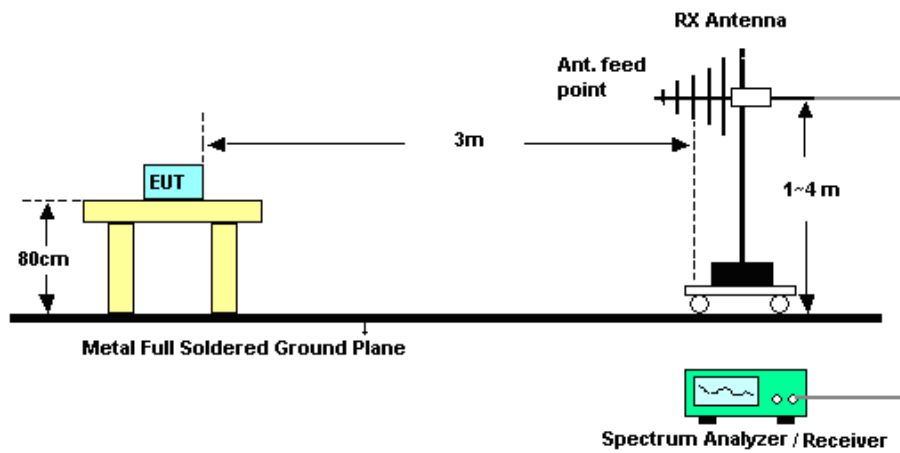

For radiated emissions above 1GHz

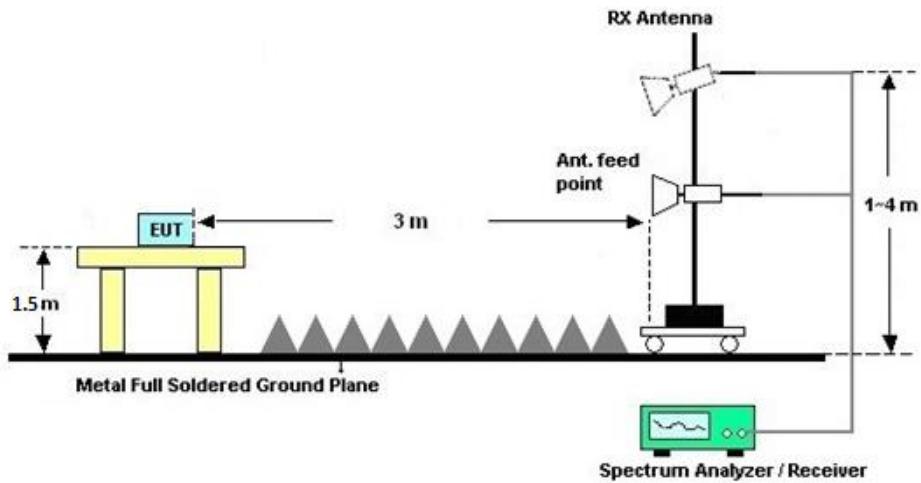



### **3.5.5 Test Results of Radiated Spurious Emissions (9 kHz ~ 30 MHz)**

The low frequency, which started from 9 kHz to 30MHz, was pre-scanned and the result which was 20dB lower than the limit line was not reported.

There is a comparison data of both open-field test site and semi-Anechoic chamber, and the result came out very similar.

### **3.5.6 Test Result of Radiated Spurious at Band Edges**

Please refer to Appendix C.

### **3.5.7 Duty Cycle**

Please refer to Appendix D.

### **3.5.8 Test Result of Radiated Spurious Emission (30MHz ~ 10th Harmonic)**

Please refer to Appendix C.



### 3.6 AC Conducted Emission Measurement

#### 3.6.1 Limit of AC Conducted Emission

For equipment that is designed to be connected to the public utility (AC) power line, the radio frequency voltage that is conducted back onto the AC power line on any frequency or frequencies within the band 150 kHz to 30 MHz shall not exceed the limits in the following table.

| Frequency of emission (MHz) | Conducted limit (dBµV) |           |
|-----------------------------|------------------------|-----------|
|                             | Quasi-peak             | Average   |
| 0.15-0.5                    | 66 to 56*              | 56 to 46* |
| 0.5-5                       | 56                     | 46        |
| 5-30                        | 60                     | 50        |

\*Decreases with the logarithm of the frequency.

#### 3.6.2 Measuring Instruments

The section 4.0 of List of Measuring Equipment of this test report is used for test.

#### 3.6.3 Test Procedures

1. The EUT was placed 0.4 meter from the conducting wall of the shielding room was kept at least 80 centimeters from any other grounded conducting surface.
2. Connect EUT to the power mains through a line impedance stabilization network (LISN).
3. All the support units are connecting to the other LISN.
4. The LISN provides 50 ohm coupling impedance for the measuring instrument.
5. The FCC states that a 50 ohm, 50 microhenry LISN should be used.
6. Both sides of AC line were checked for maximum conducted interference.
7. The frequency range from 150 kHz to 30 MHz was searched.
8. Set the test-receiver system to Peak Detect Function and specified bandwidth (IF Bandwidth = 9kHz) with Maximum Hold Mode. Then measurement is also conducted by Average Detector and Quasi-Peak Detector Function respectively.

### 3.6.4 Test Setup

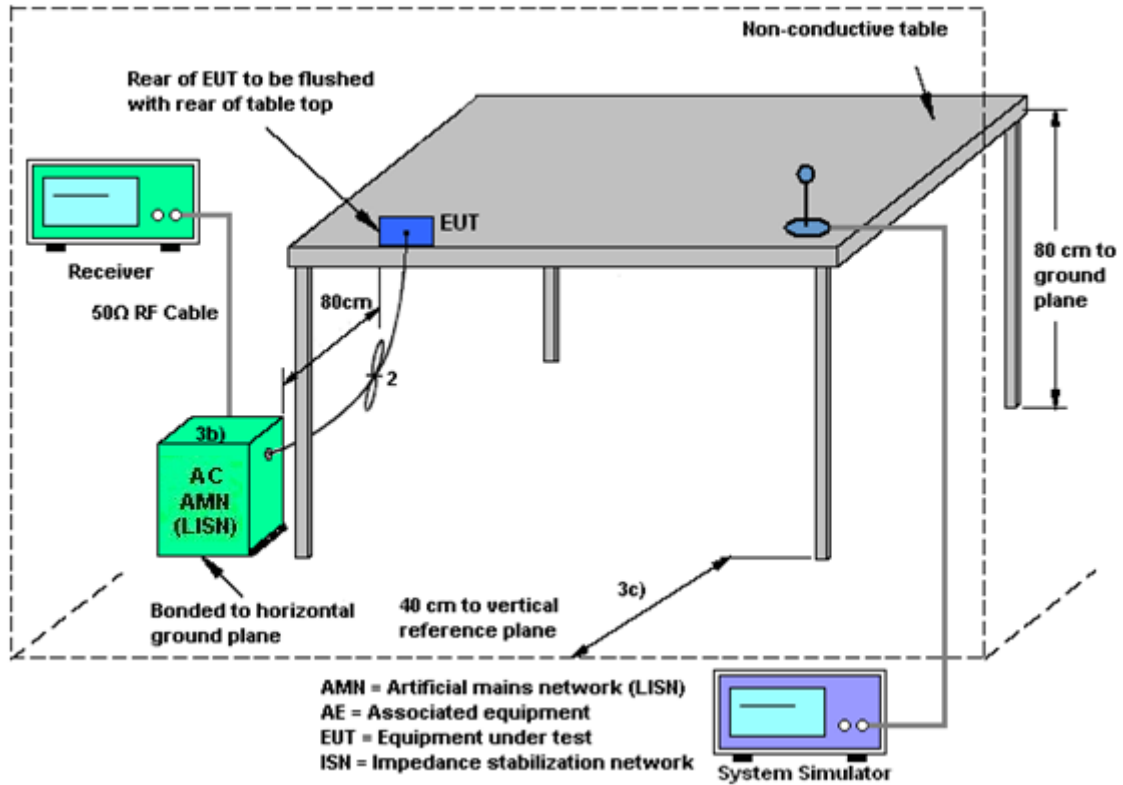

### 3.6.5 Test Result of AC Conducted Emission

Please refer to Appendix B.





## **3.7 Antenna Requirements**

### **3.7.1 Standard Applicable**

If directional gain of transmitting antennas is greater than 6dBi, the power shall be reduced by the same level in dB comparing to gain minus 6dBi. The use of a permanently attached antenna or of an antenna that uses a unique coupling to the intentional radiator shall be considered sufficient to comply with the rule.

### **3.7.2 Antenna Anti-Replacement Construction**

An embedded-in antenna design is used.

### **3.7.3 Antenna Gain**

The antenna peak gain of EUT is less than 6 dBi. Therefore, it is not necessary to reduce maximum peak output power limit.



## 4 List of Measuring Equipment

| Instrument                        | Manufacturer | Model No.                | Serial No.   | Characteristics | Calibration Date | Test Date     | Due Date      | Remark                |
|-----------------------------------|--------------|--------------------------|--------------|-----------------|------------------|---------------|---------------|-----------------------|
| Spectrum Analyzer                 | R&S          | FSV40                    | 101078       | 10Hz~40GHz      | Apr. 18, 2019    | Jun. 06, 2019 | Apr. 17, 2020 | Conducted (TH01-SZ)   |
| Pulse Power Sensor                | Anritsu      | MA2411B                  | 1207253      | 30MHz~40GHz     | Dec. 22, 2018    | Jun. 06, 2019 | Dec. 21, 2019 | Conducted (TH01-SZ)   |
| Power Meter                       | Anritsu      | ML2495A                  | 1218010      | 50MHz Bandwidth | Dec. 22, 2018    | Jun. 06, 2019 | Dec. 21, 2019 | Conducted (TH01-SZ)   |
| EMI Test Receiver&SA              | KEYSIGHT     | N9038A                   | MY54450083   | 20Hz~8.4GHz     | Apr. 18, 2019    | Jun. 14, 2019 | Apr. 17, 2020 | Radiation (03CH03-SZ) |
| EXA Spectrum Analyzer             | KEYSIGHT     | N9010A                   | MY55150246   | 10Hz~44GHz;     | Apr. 18, 2019    | Jun. 14, 2019 | Apr. 17, 2020 | Radiation (03CH03-SZ) |
| Loop Antenna                      | R&S          | HFH2-Z2                  | 100354       | 9kHz~30MHz      | May 29, 2019     | Jun. 14, 2019 | May 28, 2020  | Radiation (03CH03-SZ) |
| Bilog Antenna                     | TeseQ        | CBL6112D                 | 35408        | 30MHz-2GHz      | Apr. 19, 2019    | Jun. 14, 2019 | Apr. 18, 2020 | Radiation (03CH03-SZ) |
| Double Ridge Horn Antenna         | SCHWARZBECK  | BBHA9120D                | 9120D-1355   | 1GHz~18GHz      | Apr. 01, 2019    | Jun. 14, 2019 | Mar. 31, 2020 | Radiation (03CH03-SZ) |
| SHF-EHF Horn                      | com-power    | AH-840                   | 101071       | 18Ghz-40GHz     | Apr. 18, 2019    | Jun. 14, 2019 | Apr. 17, 2020 | Radiation (03CH03-SZ) |
| Amplifier                         | Burgeon      | BPA-530                  | 102210       | 0.01Hz~3000MHz  | Oct. 18, 2018    | Jun. 14, 2019 | Oct. 17, 2019 | Radiation (03CH03-SZ) |
| HF Amplifier                      | MITEQ        | AMF-7D-00101800-30-10P-R | 1943528      | 1GHz~18GHz      | Oct. 18, 2018    | Jun. 14, 2019 | Oct. 17, 2019 | Radiation (03CH03-SZ) |
| HF Amplifier                      | MITEQ        | TTA1840-35-HG            | 1871923      | 18GHz~40GHz     | Jul. 30, 2018    | Jun. 14, 2019 | Jul. 29, 2019 | Radiation (03CH03-SZ) |
| AC Power Source                   | Chroma       | 61601                    | 616010001985 | N/A             | NCR              | Jun. 14, 2019 | NCR           | Radiation (03CH03-SZ) |
| Turn Table                        | EM           | EM1000                   | N/A          | 0~360 degree    | NCR              | Jun. 14, 2019 | NCR           | Radiation (03CH03-SZ) |
| Antenna Mast                      | EM           | EM1000                   | N/A          | 1 m~4 m         | NCR              | Jun. 14, 2019 | NCR           | Radiation (03CH03-SZ) |
| EMI Receiver                      | R&S          | ESR7                     | 101630       | 9kHz~7GHz;      | Dec. 23, 2018    | Jun. 03, 2019 | Dec. 22, 2019 | Conduction (CO01-SZ)  |
| AC LISN                           | EMCO         | 3816/2SH                 | 00103912     | 9kHz~30MHz      | Oct. 18, 2018    | Jun. 03, 2019 | Oct. 17, 2019 | Conduction (CO01-SZ)  |
| AC LISN (for auxiliary equipment) | EMCO         | 3816/2SH                 | 00103892     | 9kHz~30MHz      | Dec. 23, 2018    | Jun. 03, 2019 | Dec. 22, 2019 | Conduction (CO01-SZ)  |
| AC Power Source                   | Chroma       | 61602                    | 616020000891 | 100Vac~250Vac   | Jul. 18, 2018    | Jun. 03, 2019 | Jul. 17, 2019 | Conduction (CO01-SZ)  |

NCR: No Calibration Required



## 5 Uncertainty of Evaluation

The measurement uncertainties shown below were calculated in accordance with the requirements of ANSI 63.10-2013. All the measurement uncertainty value were shown with a coverage K=2 to indicate 95% level of confidence. The measurement data show herein meets or exceeds the CISPR measurement uncertainty values specified in CISPR 16-4-2 and can be compared directly to specified limit to determine compliance.

### Uncertainty of Conducted Emission Measurement (150 kHz ~ 30 MHz)

|   |        |
|---|--------|
| Measuring Uncertainty for a Level of Confidence of 95% (U = 2Uc(y)) | 2.6 dB |
|---|--------|

### Uncertainty of Radiated Emission Measurement (30 MHz ~ 1000 MHz)

|   |        |
|---|--------|
| Measuring Uncertainty for a Level of Confidence of 95% (U = 2Uc(y)) | 5.0 dB |
|---|--------|

### Uncertainty of Radiated Emission Measurement (1000 MHz ~ 18000 MHz)

|   |        |
|---|--------|
| Measuring Uncertainty for a Level of Confidence of 95% (U = 2Uc(y)) | 4.8 dB |
|---|--------|

### Uncertainty of Radiated Emission Measurement (18000 MHz ~ 40000 MHz)

|   |        |
|---|--------|
| Measuring Uncertainty for a Level of Confidence of 95% (U = 2Uc(y)) | 4.6 dB |
|---|--------|

## Appendix A. Test Result of Conducted Test Items

|                |             |                    |       |    |
|----------------|-------------|--------------------|-------|----|
| Test Engineer: | Zhang Jiang | Temperature:       | 21~25 | °C |
| Test Date:     | 2019/6/6    | Relative Humidity: | 51~54 | %  |

### **TEST RESULTS DATA** **6dB and 99% Occupied Bandwidth**

| Mod. | Data Rate | NTX | CH. | Freq. (MHz) | 99% Occupied BW (MHz) | 6dB BW (MHz) | 6dB BW Limit (MHz) | Pass/Fail |
|------|-----------|-----|-----|-------------|-----------------------|--------------|--------------------|-----------|
| BLE  | 1Mbps     | 1   | 0   | 2402        | 1.049                 | 0.719        | 0.50               | Pass      |
| BLE  | 1Mbps     | 1   | 19  | 2440        | 1.051                 | 0.719        | 0.50               | Pass      |
| BLE  | 1Mbps     | 1   | 39  | 2480        | 1.049                 | 0.719        | 0.50               | Pass      |

### **TEST RESULTS DATA** **Average Power Table**

| Mod. | Data Rate | NTX | CH. | Freq. (MHz) | Duty Factor (dB) | Average Conducted Power (dBm) |
|------|-----------|-----|-----|-------------|------------------|-------------------------------|
| BLE  | 1Mbps     | 1   | 0   | 2402        | 2.07             | 3.10                          |
| BLE  | 1Mbps     | 1   | 19  | 2440        | 2.07             | 3.70                          |
| BLE  | 1Mbps     | 1   | 39  | 2480        | 2.07             | 3.20                          |

### **TEST RESULTS DATA** **Power Density**

| Mod. | Data Rate | NTX | CH. | Freq. (MHz) | Peak PSD (dBm /100kHz) | Peak PSD (dBm /3kHz) | DG (dBi) | Peak PSD Limit (dBm /3kHz) | Pass/Fail |
|------|-----------|-----|-----|-------------|------------------------|----------------------|----------|----------------------------|-----------|
| BLE  | 1Mbps     | 1   | 0   | 2402        | 3.60                   | -9.87                | 1.50     | 8.00                       | Pass      |
| BLE  | 1Mbps     | 1   | 19  | 2440        | 4.24                   | -9.24                | 1.50     | 8.00                       | Pass      |
| BLE  | 1Mbps     | 1   | 39  | 2480        | 3.52                   | -9.78                | 1.50     | 8.00                       | Pass      |

Note: PSD (dBm/ 100kHz) is a reference level used for Conducted Band Edges and Conducted Spurious Emission 20dBc limit.



## Appendix B. AC Conducted Emission Test Results

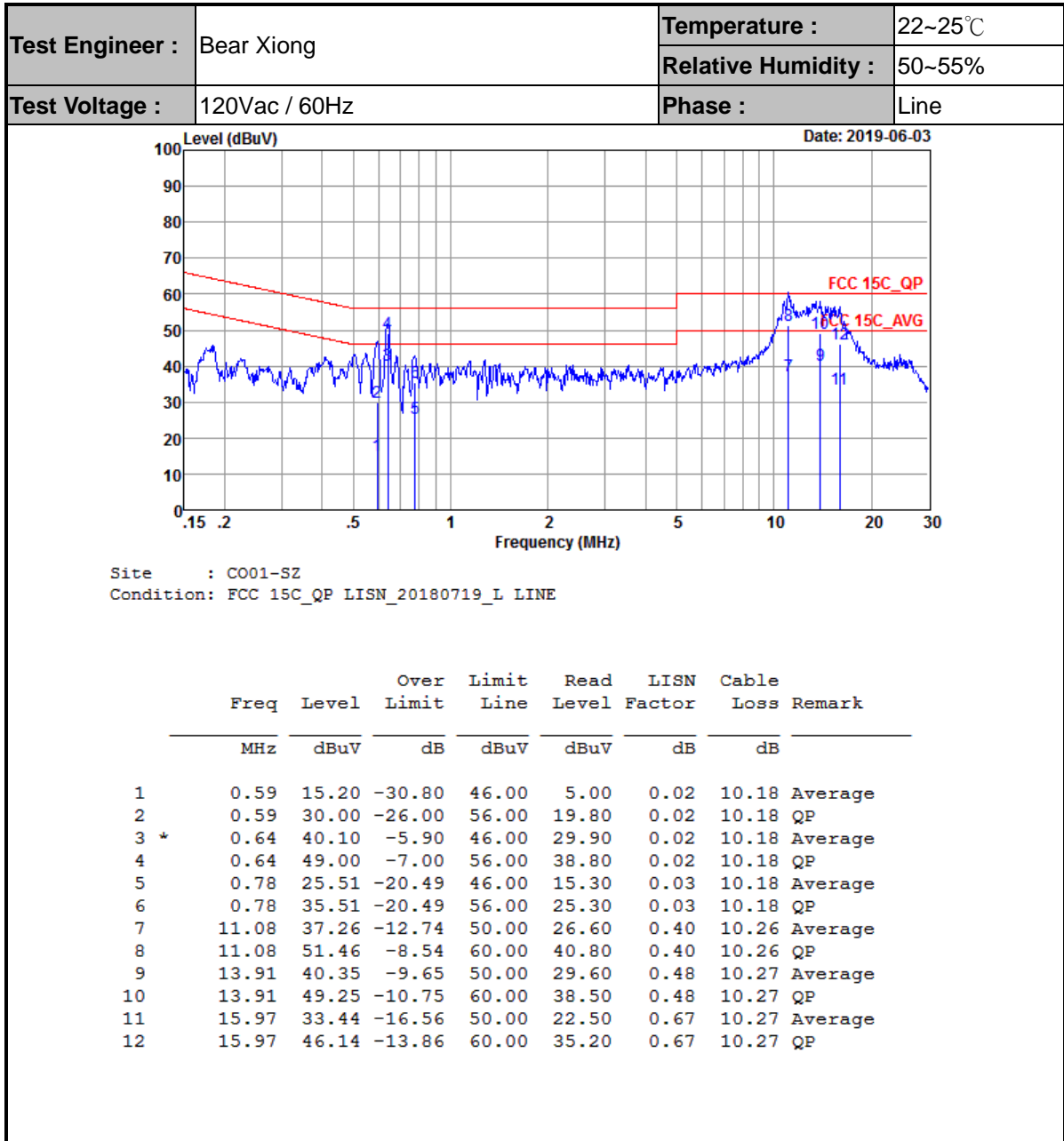



|                 |               |                     |         |
|-----------------|---------------|---------------------|---------|
| Test Engineer : | Bear Xiong    | Temperature :       | 22~25°C |
|                 |               | Relative Humidity : | 50~55%  |
| Test Voltage :  | 120Vac / 60Hz | Phase :             | Neutral |

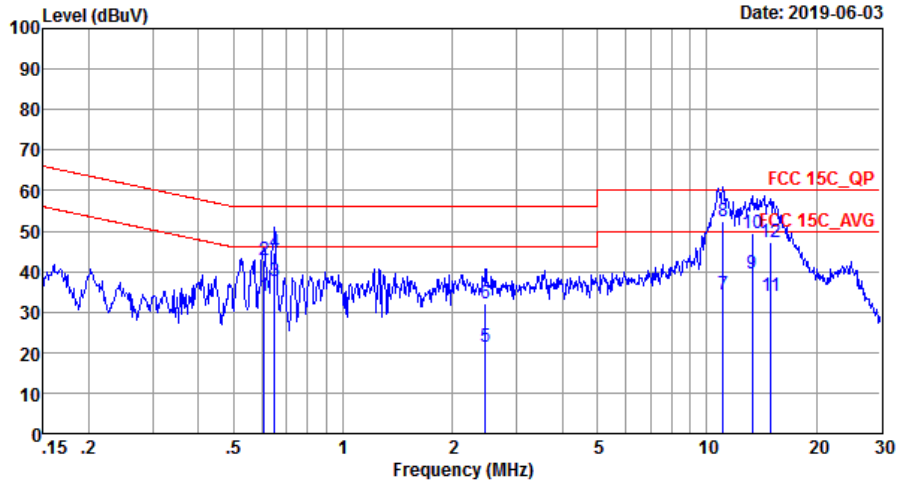

Site : C001-SZ  
 Condition: FCC 15C\_QP LISN\_20180719\_N NEUTRAL

|     | Freq  | Level | Over Limit | Limit Line | Read Level | LISN Factor | Cable Loss | Remark  |
|-----|-------|-------|------------|------------|------------|-------------|------------|---------|
|     | MHz   | dBuV  | dB         | dBuV       | dBuV       | dB          | dB         |         |
| 1   | 0.61  | 33.80 | -12.20     | 46.00      | 23.60      | 0.02        | 10.18      | Average |
| 2   | 0.61  | 42.90 | -13.10     | 56.00      | 32.70      | 0.02        | 10.18      | QP      |
| 3   | 0.65  | 37.50 | -8.50      | 46.00      | 27.30      | 0.02        | 10.18      | Average |
| 4   | 0.65  | 44.70 | -11.30     | 56.00      | 34.50      | 0.02        | 10.18      | QP      |
| 5   | 2.46  | 21.33 | -24.67     | 46.00      | 11.10      | 0.04        | 10.19      | Average |
| 6   | 2.46  | 32.23 | -23.77     | 56.00      | 22.00      | 0.04        | 10.19      | QP      |
| 7   | 11.08 | 34.46 | -15.54     | 50.00      | 24.00      | 0.20        | 10.26      | Average |
| 8 * | 11.08 | 52.56 | -7.44      | 60.00      | 42.10      | 0.20        | 10.26      | QP      |
| 9   | 13.34 | 39.45 | -10.55     | 50.00      | 28.90      | 0.28        | 10.27      | Average |
| 10  | 13.34 | 49.55 | -10.45     | 60.00      | 39.00      | 0.28        | 10.27      | QP      |
| 11  | 14.99 | 33.80 | -16.20     | 50.00      | 23.20      | 0.33        | 10.27      | Average |
| 12  | 14.99 | 47.40 | -12.60     | 60.00      | 36.80      | 0.33        | 10.27      | QP      |



## Appendix C. Radiated Spurious Emission

### 2.4GHz 2400~2483.5MHz

#### BLE (Band Edge @ 3m)

| BLE                     | Note    | Frequency | Level      | Over Limit | Limit Line | Read Level | Antenna Factor | Cable Loss | Preamp Factor | Ant Pos | Table Pos | Peak Avg. | Pol.    |
|-------------------------|---------|-----------|------------|------------|------------|------------|----------------|------------|---------------|---------|-----------|-----------|---------|
|                         |         | ( MHz )   | ( dBμV/m ) | ( dB )     | ( dBμV/m ) | ( dBμV )   | ( dB/m )       | ( dB )     | ( dB )        | ( cm )  | ( deg )   | ( P/A )   | ( H/V ) |
| BLE<br>CH 00<br>2402MHz |         | 2356.83   | 49.49      | -24.51     | 74         | 50.85      | 27.85          | 6.81       | 36.02         | 135     | 221       | P         | H       |
|                         |         | 2346.33   | 40.5       | -13.5      | 54         | 41.83      | 27.88          | 6.81       | 36.02         | 135     | 221       | A         | H       |
|                         | *       | 2402      | 90.26      | -          | -          | 91.55      | 27.8           | 6.89       | 35.98         | 135     | 221       | P         | H       |
|                         | *       | 2402      | 89.2       | -          | -          | 90.49      | 27.8           | 6.89       | 35.98         | 135     | 221       | A         | H       |
|                         |         | 2362.92   | 49.53      | -24.47     | 74         | 50.87      | 27.85          | 6.81       | 36            | 108     | 344       | P         | V       |
|                         |         | 2386.34   | 40.27      | -13.73     | 54         | 41.58      | 27.8           | 6.89       | 36            | 108     | 344       | A         | V       |
|                         | *       | 2402      | 93.06      | -          | -          | 94.35      | 27.8           | 6.89       | 35.98         | 108     | 344       | P         | V       |
|                         | *       | 2402      | 90.04      | -          | -          | 91.33      | 27.8           | 6.89       | 35.98         | 108     | 344       | A         | V       |
| BLE<br>CH 19<br>2440MHz |         | 2328.2    | 49.55      | -24.45     | 74         | 50.95      | 27.91          | 6.73       | 36.04         | 132     | 205       | P         | H       |
|                         |         | 2346.68   | 40.01      | -13.99     | 54         | 41.34      | 27.88          | 6.81       | 36.02         | 132     | 205       | A         | H       |
|                         | *       | 2440      | 91.4       | -          | -          | 92.66      | 27.71          | 6.97       | 35.94         | 132     | 205       | P         | H       |
|                         | *       | 2440      | 90.79      | -          | -          | 92.05      | 27.71          | 6.97       | 35.94         | 132     | 205       | A         | H       |
|                         |         | 2496.85   | 49.44      | -24.56     | 74         | 50.66      | 27.63          | 7.05       | 35.9          | 132     | 205       | P         | H       |
|                         |         | 2496.01   | 41.24      | -12.76     | 54         | 42.46      | 27.63          | 7.05       | 35.9          | 132     | 205       | A         | H       |
|                         |         | 2362.5    | 49.41      | -24.59     | 74         | 50.77      | 27.85          | 6.81       | 36.02         | 104     | 343       | P         | V       |
|                         |         | 2329.6    | 39.99      | -14.01     | 54         | 41.39      | 27.91          | 6.73       | 36.04         | 104     | 343       | A         | V       |
|                         | *       | 2440      | 93.21      | -          | -          | 94.47      | 27.71          | 6.97       | 35.94         | 104     | 343       | P         | V       |
|                         | *       | 2440      | 92.28      | -          | -          | 93.54      | 27.71          | 6.97       | 35.94         | 104     | 343       | A         | V       |
|                         |         | 2496.43   | 50.05      | -23.95     | 74         | 51.27      | 27.63          | 7.05       | 35.9          | 104     | 343       | P         | V       |
|                         | 2496.29 | 40.01     | -13.99     | 54         | 41.23      | 27.63      | 7.05           | 35.9       | 104           | 343     | A         | V         |         |



|                                  |   |         |       |        |    |       |       |      |       |     |     |   |   |
|----------------------------------|---|---------|-------|--------|----|-------|-------|------|-------|-----|-----|---|---|
| <b>BLE<br/>CH 39<br/>2480MHz</b> | *   | 2480    | 91.53 | -      | -  | 92.74 | 27.66 | 7.05 | 35.92 | 130 | 202 | P | H |
|                                  | *   | 2480    | 90.82 | -      | -  | 92.03 | 27.66 | 7.05 | 35.92 | 130 | 202 | A | H |
|                                  |   | 2499.2  | 48.54 | -25.46 | 74 | 49.76 | 27.63 | 7.05 | 35.9  | 130 | 202 | P | H |
|                                  |   | 2495.92 | 40.63 | -13.37 | 54 | 41.85 | 27.63 | 7.05 | 35.9  | 130 | 202 | A | H |
|                                  | *   | 2480    | 93.13 | -      | -  | 94.34 | 27.66 | 7.05 | 35.92 | 156 | 345 | P | V |
|                                  | *   | 2480    | 91.97 | -      | -  | 93.18 | 27.66 | 7.05 | 35.92 | 156 | 345 | A | V |
|                                  |   | 2496.44 | 50.09 | -23.91 | 74 | 51.31 | 27.63 | 7.05 | 35.9  | 156 | 345 | P | V |
|                                  |   | 2495.8  | 41    | -13    | 54 | 42.22 | 27.63 | 7.05 | 35.9  | 156 | 345 | A | V |
| <b>Remark</b>                    | 1. No other spurious found.<br>2. All results are PASS against Peak and Average limit line. |         |       |        |    |       |       |      |       |     |     |   |   |





2.4GHz 2400~2483.5MHz
BLE (Harmonic @ 3m)

Table with 14 columns: BLE, Note, Frequency (MHz), Level (dBµV/m), Over Limit (dB), Limit Line (dBµV/m), Read Level (dBµV), Antenna Factor (dB/m), Cable Loss (dB), Preamp Factor (dB), Ant Pos (cm), Table Pos (deg), Peak Avg. (P/A), Pol. (H/V). Rows include data for BLE CH 00 (2402MHz) and BLE CH 19 (2440MHz) and BLE CH 39 (2480MHz).



Emission below 1GHz

2.4GHz BLE (LF)

| BLE                 | Note   | Frequency | Level      | Over   | Limit      | Read     | Antenna  | Cable  | Preamp | Ant    | Table   | Peak    | Pol.    |
|---------------------|--|-----------|------------|--------|------------|----------|----------|--------|--------|--------|---------|---------|---------|
|                     |  | ( MHz )   | ( dBμV/m ) | ( dB ) | ( dBμV/m ) | ( dBμV ) | ( dB/m ) | ( dB ) | ( dB ) | ( cm ) | ( deg ) | ( P/A ) | ( H/V ) |
| 2.4GHz<br>BLE<br>LF |  | 30        | 24.82      | -15.18 | 40         | 32.46    | 24.3     | 0.56   | 32.5   | -      | -       | P       | H       |
|                     |  | 51.34     | 23.63      | -16.37 | 40         | 41.76    | 13.74    | 0.73   | 32.6   | -      | -       | P       | H       |
|                     |  | 93.05     | 20.2       | -23.3  | 43.5       | 36       | 15.26    | 0.99   | 32.05  | -      | -       | P       | H       |
|                     |  | 151.25    | 25.76      | -17.74 | 43.5       | 39.77    | 16.6     | 1.28   | 31.89  | -      | -       | P       | H       |
|                     |  | 192.96    | 31.29      | -12.21 | 43.5       | 46.21    | 15.46    | 1.43   | 31.81  | 103    | 20      | P       | H       |
|                     |  | 804.06    | 28.24      | -17.76 | 46         | 31.02    | 26.22    | 3.11   | 32.11  | -      | -       | P       | H       |
|                     |  | 30        | 36.46      | -3.54  | 40         | 44.1     | 24.3     | 0.56   | 32.5   | 100    | 320     | QP      | V       |
|                     |  | 50.37     | 35.54      | -4.46  | 40         | 53.52    | 13.9     | 0.72   | 32.6   | -      | -       | P       | V       |
|                     |  | 93.05     | 22.67      | -20.83 | 43.5       | 38.47    | 15.26    | 0.99   | 32.05  | -      | -       | P       | V       |
|                     |  | 191.99    | 24.91      | -18.59 | 43.5       | 39.85    | 15.44    | 1.43   | 31.81  | -      | -       | P       | V       |
|                     |  | 599.39    | 25.82      | -20.18 | 46         | 29.75    | 24.69    | 2.68   | 31.3   | -      | -       | P       | V       |
|                     |  | 940.83    | 29.43      | -16.57 | 46         | 30.44    | 26.94    | 3.38   | 31.33  | -      | -       | P       | V       |
| Remark              | 1. No other spurious found.<br>2. All results are PASS against limit line. |           |            |        |            |          |          |        |        |        |         |         |         |



**Note symbol**

|     |  |
|-----|--|
| *   | <b>Fundamental Frequency</b> which can be ignored. However, the level of any unwanted emissions shall not exceed the level of the fundamental frequency. |
| !   | Test result is <b>over limit</b> line.   |
| P/A | <b>Peak</b> or <b>Average</b>  |
| H/V | <b>Horizontal</b> or <b>Vertical</b>   |



A calculation example for radiated spurious emission is shown as below:

| WIFI    | Note | Frequency | Level      | Over   | Limit      | Read     | Antenna  | Cable  | Preamp | Ant    | Table   | Peak    | Pol.    |
|---------|------|-----------|------------|--------|------------|----------|----------|--------|--------|--------|---------|---------|---------|
| Ant.    |      |           |            | Limit  | Line       | Level    | Factor   | Loss   | Factor | Pos    | Pos     | Avg.    |         |
| 1+2     |      | ( MHz )   | ( dBμV/m ) | ( dB ) | ( dBμV/m ) | ( dBμV ) | ( dB/m ) | ( dB ) | ( dB ) | ( cm ) | ( deg ) | ( P/A ) | ( H/V ) |
| 802.11b |      | 2390      | 55.45      | -18.55 | 74         | 54.51    | 32.22    | 4.58   | 35.86  | 103    | 308     | P       | H       |
| CH 01   |      |           |            |        |            |          |          |        |        |        |         |         |         |
| 2412MHz |      | 2390      | 43.54      | -10.46 | 54         | 42.6     | 32.22    | 4.58   | 35.86  | 103    | 308     | A       | H       |

- Level(dBμV/m) =  
Antenna Factor(dB/m) + Cable Loss(dB) + Read Level(dBμV) - Preamp Factor(dB)
- Over Limit(dB) = Level(dBμV/m) – Limit Line(dBμV/m)

**For Peak Limit @ 2390MHz:**

- Level(dBμV/m)  
= Antenna Factor(dB/m) + Cable Loss(dB) + Read Level(dBμV) - Preamp Factor(dB)  
= 32.22(dB/m) + 4.58(dB) + 54.51(dBμV) – 35.86 (dB)  
= 55.45 (dBμV/m)
- Over Limit(dB)  
= Level(dBμV/m) – Limit Line(dBμV/m)  
= 55.45(dBμV/m) – 74(dBμV/m)  
= -18.55(dB)

**For Average Limit @ 2390MHz:**

- Level(dBμV/m)  
= Antenna Factor(dB/m) + Cable Loss(dB) + Read Level(dBμV) - Preamp Factor(dB)  
= 32.22(dB/m) + 4.58(dB) + 42.6(dBμV) – 35.86 (dB)  
= 43.54 (dBμV/m)
- Over Limit(dB)  
= Level(dBμV/m) – Limit Line(dBμV/m)  
= 43.54(dBμV/m) – 54(dBμV/m)  
= -10.46(dB)

Both peak and average measured complies with the limit line, so test result is “PASS”.



### Appendix D. Duty Cycle Plots

| Band         | Duty Cycle(%) | T(ms)  | 1/T(KHz) | VBW Setting |
|--------------|---------------|--------|----------|-------------|
| Bluetooth LE | 62.04         | 0.3884 | 2.5746   | 3kHz        |

#### Bluetooth LE

