



FCC RF Test Report

APPLICANT : PAX Technology Limited
EQUIPMENT : Smart Mini Payment Terminal
BRAND NAME : PAX
MODEL NAME : A50
FCC ID : V5PA50
STANDARD : 47 CFR Part 2, 22(H), 24(E), 27(L)
CLASSIFICATION : PCS Licensed Transmitter (PCB)

The product was received on Feb. 26, 2020 and completely tested on Mar. 21, 2020. We, Sporton International (ShenZhen) Inc., would like to declare that the tested sample has been evaluated in accordance with the procedures given in ANSI C63.26-2015 and shown compliance with the applicable technical standards.

The test results in this report apply exclusively to the tested model / sample. Without written approval of Sporton International (ShenZhen) Inc., the test report shall not be reproduced except in full.

Reviewed by: Derreck Chen / Supervisor

Approved by: Eric Shih / Manager



Sporton International (ShenZhen) Inc.

1/F, 2/F, Bldg 5, Shiling Industrial Zone, Xinwei Village, Xili, Nanshan, Shenzhen, 518055

People's Republic of China



TABLE OF CONTENTS

REVISION HISTORY3

SUMMARY OF TEST RESULT4

1 GENERAL DESCRIPTION.....5

1.1 Applicant5

1.2 Manufacturer5

1.3 Product Feature of Equipment Under Test5

1.4 Product Specification of Equipment Under Test6

1.5 Modification of EUT.....6

1.6 Maximum ERP/EIRP Power, Frequency Tolerance, and Emission Designator7

1.7 Testing Location7

1.8 Test Software7

1.9 Applicable Standards8

2 TEST CONFIGURATION OF EQUIPMENT UNDER TEST9

2.1 Test Mode9

2.2 Connection Diagram of Test System 10

2.3 Support Unit used in test configuration 10

2.4 Measurement Results Explanation Example 10

2.5 Frequency List of Low/Middle/High Channels 11

3 CONDUCTED TEST RESULT.....12

3.1 Measuring Instruments 12

3.2 Test Setup 12

3.3 Test Result of Conducted Test..... 12

3.4 Conducted Output Power and ERP/EIRP 13

3.5 Peak-to-Average Ratio 14

3.6 99% Occupied Bandwidth and 26dB Bandwidth Measurement 15

3.7 Conducted Band Edge 16

3.8 Conducted Spurious Emission 17

3.9 Frequency Stability 18

4 RADIATED TEST ITEMS19

4.1 Measuring Instruments 19

4.2 Test Setup 19

4.3 Test Result of Radiated Test 19

4.4 Field Strength of Spurious Radiation Measurement 20

5 LIST OF MEASURING EQUIPMENT21

6 UNCERTAINTY OF EVALUATION.....22

APPENDIX A. TEST RESULTS OF CONDUCTED TEST

APPENDIX B. TEST RESULTS OF RADIATED TEST

APPENDIX C. TEST SETUP PHOTOGRAPHS



REVISION HISTORY

REPORT NO.	VERSION	DESCRIPTION	ISSUED DATE
FG022603A	Rev. 01	Initial issue of report	Apr. 26, 2020



SUMMARY OF TEST RESULT

Table with 6 columns: Report Section, FCC Rule, Description, Limit, Result, Remark. Rows include tests for Conducted Output Power, Effective Radiated Power, Peak-to-Average Ratio, Occupied Bandwidth, Band Edge Measurement, Conducted Emission, Frequency Stability, and Field Strength of Spurious Radiation.

Declaration of Conformity:

The test results with all measurement uncertainty excluded are presented in accordance with the regulation limits or requirements declared by manufacturers.

Comments and Explanations:

The declared of product specification for EUT presented in the report are provided by the manufacturer, and the manufacturer takes all the responsibilities for the accuracy of product specification.



1 General Description

1.1 Applicant

PAX Technology Limited

Room 2416, 24/F., Sun Hung Kai Centre, 30 Harbour Road, Wanchai, Hong Kong

1.2 Manufacturer

PAX Computer Technology (Shenzhen) Co., Ltd.

4/F, No.3 Building, Software Park, Second Central Science-Tech Road, High-Tech industrial Park, Shenzhen, Guangdong, P.R.C.

1.3 Product Feature of Equipment Under Test

Product Feature	
Equipment	Smart Mini Payment Terminal
Brand Name	PAX
Model Name	A50
FCC ID	V5PA50
EUT supports Radios application	WCDMA/LTE WLAN 2.4GHz 802.11b/g/n HT20 Bluetooth BR/EDR/LE GNSS/NFC
IMEI Code	Conducted: 357369100001393 Radiation: 357369100001351
HW Version	N/A
SW Version	N/A
EUT Stage	Production Unit

Remark: The above EUT's information was declared by manufacturer. Please refer to the specifications or user's manual for more detailed description.



1.4 Product Specification of Equipment Under Test

Standards-related Product Specification	
Tx Frequency	WCDMA: Band V: 826.4 MHz ~ 846.6 MHz Band II: 1852.4 MHz ~ 1907.6 MHz Band IV: 1712.4 MHz ~ 1752.6 MHz
Rx Frequency	WCDMA: Band V: 871.4 MHz ~ 891.6 MHz Band II: 1932.4 MHz ~ 1987.6 MHz Band IV: 2112.4 MHz ~ 2152.6 MHz
Maximum Output Power to Antenna	WCDMA: Band V: 22.29 dBm Band II: 22.34 dBm Band IV: 22.35 dBm
Antenna Type	FPC Antenna
Antenna Gain	Cellular Band: 1.5 dBi PCS Band: 1.0 dBi AWS Band: 1.0 dBi
Type of Modulation	WCDMA : BPSK HSDPA/DC-HSDPA : QPSK HSUPA : QPSK HSPA+ : 16QAM(uplink is not supported) DC-HSDPA : 64QAM

1.5 Modification of EUT

No modifications are made to the EUT during all test items.



1.6 Maximum ERP/EIRP Power, Frequency Tolerance, and Emission Designator

FCC Rule	System	Type of Modulation	Maximum ERP/EIRP (W)	Frequency Tolerance (ppm)	Emission Designator
Part 22H	WCDMA Band V RMC 12.2Kbps	BPSK	0.1459	0.0099 ppm	4M15F9W
Part 24E	WCDMA Band II RMC 12.2Kbps	BPSK	0.2158	0.0036 ppm	4M14F9W
Part 27L	WCDMA Band IV RMC 12.2Kbps	BPSK	0.2163	0.0048 ppm	4M15F9W

1.7 Testing Location

Sporton International (Shenzhen) Inc. is accredited to ISO/IEC 17025:2017 by American Association for Laboratory Accreditation with Certificate Number 5145.01.

Test Firm	Sporton International (Shenzhen) Inc.		
Test Site Location	1/F, 2/F, Bldg 5, Shiling Industrial Zone, Xinwei Village, Xili, Nanshan, Shenzhen, 518055 People's Republic of China TEL: +86-755-86379589 FAX: +86-755-86379595		
Test Site No.	Sporton Site No.	FCC Designation No.	FCC Test Firm Registration No.
	TH01-SZ	CN1256	421272

Test Firm	Sporton International (Shenzhen) Inc.		
Test Site Location	No. 3 Bldg the third floor of south, Shahe River west, Fengzeyuan Warehouse, Nanshan Shenzhen, 518055 People's Republic of China TEL: +86-755-33202398		
Test Site No.	Sporton Site No.	FCC Designation No.	FCC Test Firm Registration No.
	03CH04-SZ	CN1256	421272

1.8 Test Software

Item	Site	Manufacture	Name	Version
1.	03CH04-SZ	AUDIX	E3	6.2009-8-24



1.9 Applicable Standards

According to the specifications of the manufacturer, the EUT must comply with the requirements of the following standards:

- ♦ 47 CFR Part 2, 22(H), 24(E), 27(L)
- ♦ ANSI C63.26-2015
- ♦ FCC KDB 971168 D01 Power Meas. License Digital Systems v03r01
- ♦ FCC KDB 412172 D01 Determining ERP and EIRP v01r01

Remark:

1. All test items were verified and recorded according to the standards and without any deviation during the test.
2. This EUT has also been tested and complied with the requirements of FCC Part 15, Subpart B, recorded in a separate test report.



2 Test Configuration of Equipment Under Test

2.1 Test Mode

Antenna port conducted and radiated test items were performed according to KDB 971168 D01 Power Meas. License Digital Systems v03r01 with maximum output power.

Radiated measurements were performed with rotating EUT in different three orthogonal test planes to find the maximum emission.

Radiated emissions were investigated as following frequency range:

1. 30 MHz to 10th harmonic for WCDMA Band V.
2. 30 MHz to 10th harmonic for WCDMA Band IV.
3. 30 MHz to 10th harmonic for WCDMA Band II.

All modes and data rates and positions were investigated.

Test modes are chosen to be reported as the worst case configuration below:

Test Modes		
Band	Radiated TCs	Conducted TCs
WCDMA Band V	■ RMC 12.2Kbps Link	■ RMC 12.2Kbps Link
WCDMA Band II	■ RMC 12.2Kbps Link	■ RMC 12.2Kbps Link
WCDMA Band IV	■ RMC 12.2Kbps Link	■ RMC 12.2Kbps Link

2.2 Connection Diagram of Test System

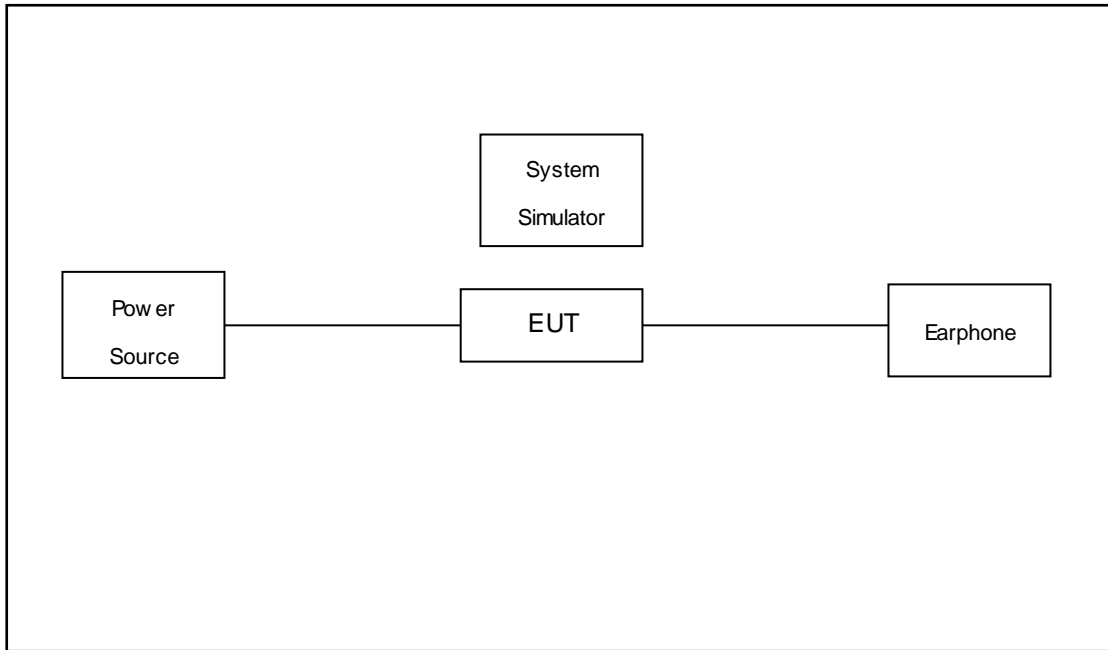

2.3 Support Unit used in test configuration

Item	Equipment	Trade Name	Model No.	FCC ID	Data Cable	Power Cord
1.	System Simulator	R&S	CMU 200	N/A	N/A	Unshielded, 1.8m
2.	Earphone	apple	DCAY1V-A9007ZJW3-000	N/A	Shielded, 1.2m	N/A

2.4 Measurement Results Explanation Example

For all conducted test items:

The offset level is set in the spectrum analyzer to compensate the RF cable loss and attenuator factor between RF conducted output port and spectrum analyzer. With the offset compensation, the spectrum analyzer reading level will be exactly the RF output level.

The spectrum analyzer offset is derived from RF cable loss and attenuator factor.

Offset = RF cable loss + attenuator factor.

The following shows an offset computation example with RF cable loss 4.50 dB and a 10dB attenuator.

Example :

$$\begin{aligned}
 \text{Offset(dB)} &= \text{RF cable loss(dB)} + \text{attenuator factor(dB)} \\
 &= 4.50 + 10 = 14.50 \text{ (dB)}
 \end{aligned}$$



2.5 Frequency List of Low/Middle/High Channels

Frequency List				
Band	Channel/Frequency(MHz)	Lowest	Middle	Highest
WCDMA Band V	Channel	4132	4182	4233
	Frequency	826.4	836.4	846.6
WCDMA Band II	Channel	9262	9400	9538
	Frequency	1852.4	1880.0	1907.6
WCDMA Band IV	Channel	1312	1413	1513
	Frequency	1712.4	1732.6	1752.6

3 Conducted Test Result

3.1 Measuring Instruments

See list of measuring instruments of this test report.

3.2 Test Setup

3.2.1 Conducted Output Power

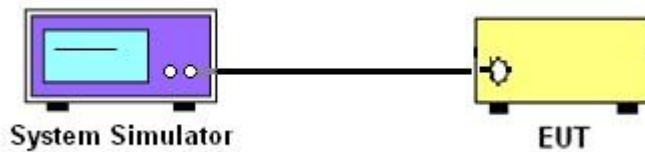

3.2.2 Peak-to-Average Ratio, Occupied Bandwidth, Conducted Band-Edge and Conducted Spurious Emission

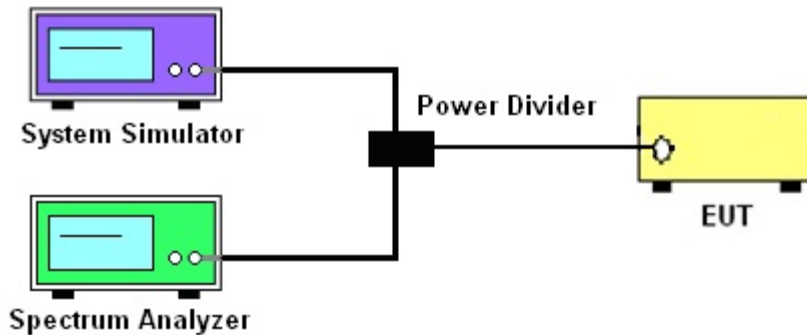

3.2.3 Frequency Stability

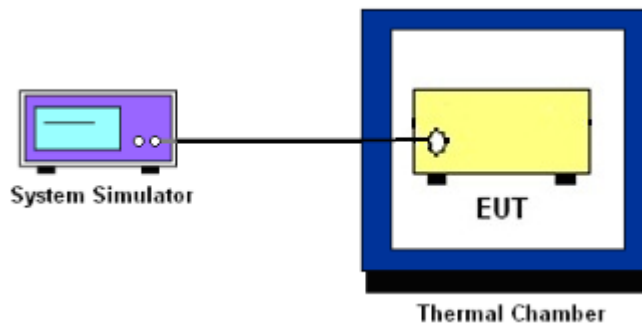

3.3 Test Result of Conducted Test

Please refer to Appendix A.



3.4 Conducted Output Power and ERP/EIRP

3.4.1 Description of the Conducted Output Power and ERP/EIRP

A system simulator was used to establish communication with the EUT. Its parameters were set to enforce EUT transmitting at the maximum power. The measured power in the radio frequency on the transmitter output terminals shall be reported.

The ERP of mobile transmitters must not exceed 7 Watts for WCDMA Band V.

The EIRP of mobile transmitters must not exceed 2 Watts for WCDMA Band II.

The EIRP of mobile transmitters must not exceed 1 Watts for WCDMA Band IV.

According to KDB 412172 D01 Power Approach,

$EIRP = P_T + G_T - L_C$, $ERP = EIRP - 2.15$, where

P_T = transmitter output power in dBm

G_T = gain of the transmitting antenna in dBi

L_C = signal attenuation in the connecting cable between the transmitter and antenna in dB

3.4.2 Test Procedures

1. The testing follows ANSI C63.26 Section 5.2
2. The transmitter output port was connected to the system simulator.
3. Set EUT at maximum power through the system simulator.
4. Select lowest, middle, and highest channels for each band and different modulation.
5. Measure and record the power level from the system simulator.



3.5 Peak-to-Average Ratio

3.5.1 Description of the PAR Measurement

The peak-to-average ratio (PAR) of the transmission may not exceed 13 dB.

3.5.2 Test Procedures

1. The testing follows ANSI C63.26 Section 5.2.3.4 (CCDF).
2. The EUT was connected to spectrum and system simulator via a power divider.
3. Set the CCDF (Complementary Cumulative Distribution Function) option in spectrum analyzer.
4. The highest RF powers were measured and recorded the maximum PAPR level associated with a probability of 0.1 %.
5. Record the deviation as Peak to Average Ratio.



3.6 99% Occupied Bandwidth and 26dB Bandwidth Measurement

3.6.1 Description of 99% Occupied Bandwidth and 26dB Bandwidth Measurement

The occupied bandwidth is the width of a frequency band such that, below the lower and above the upper frequency limits, the mean powers emitted are each equal to a specified percentage 0.5% of the total mean transmitted power.

The 26 dB emission bandwidth is defined as the frequency range between two points, one above and one below the carrier frequency, at which the spectral density of the emission is attenuated 26 dB below the maximum in-band spectral density of the modulated signal. Spectral density (power per unit bandwidth) is to be measured with a detector of resolution bandwidth equal to approximately 1.0% of the emission bandwidth.

3.6.2 Test Procedures

1. The testing follows ANSI C63.26 Section 5.4
2. The EUT was connected to spectrum analyzer and system simulator via a power divider.
3. The spectrum analyzer center frequency is set to the nominal EUT channel center frequency. The span range for the spectrum analyzer shall be between two and five times the anticipated OBW.
4. The nominal resolution bandwidth (RBW) shall be in the range of 1 to 5 % of the anticipated OBW, and the VBW shall be at least 3 times the RBW.
5. Set the detection mode to peak, and the trace mode to max hold.
6. Determine the reference value: Set the EUT to transmit a modulated signal. Allow the trace to stabilize. Set the spectrum analyzer marker to the highest level of the displayed trace.
(this is the reference value)
7. Determine the “-26 dB down amplitude” as equal to (Reference Value – X).
8. Place two markers, one at the lowest and the other at the highest frequency of the envelope of the spectral display such that each marker is at or slightly below the “-X dB down amplitude” determined in step 6. If a marker is below this “-X dB down amplitude” value it shall be placed as close as possible to this value. The OBW is the positive frequency difference between the two markers.
9. Use the 99 % power bandwidth function of the spectrum analyzer and report the measured bandwidth.



3.7 Conducted Band Edge

3.7.1 Description of Conducted Band Edge Measurement

The power of any emission outside of the authorized operating frequency ranges must be lower than the transmitter power (P) by a factor of at least $43 + 10 \log (P)$ dB.

3.7.2 Test Procedures

1. The testing follows ANSI C63.26 section 5.7
2. The EUT was connected to the spectrum analyzer and system simulator via a power divider.
3. The RF output of EUT was connected to the spectrum analyzer by an RF cable and attenuator. The path loss was compensated to the results for each measurement.
4. The band edges of low and high channels for the highest RF powers were measured.
5. The RF fundamental frequency should be excluded against the limit line in the operating frequency band.
6. The limit line is derived from $43 + 10\log(P)$ dB below the transmitter power P(Watts)



3.8 Conducted Spurious Emission

3.8.1 Description of Conducted Spurious Emission Measurement

The power of any emission outside of the authorized operating frequency ranges must be lower than the transmitter power (P) by a factor of at least $43 + 10 \log (P)$ dB.

It is measured by means of a calibrated spectrum analyzer and scanned from 30 MHz up to a frequency including its 10th harmonic.

3.8.2 Test Procedures

1. The testing follows ANSI C63.26 section 5.7
2. The EUT was connected to the spectrum analyzer and system simulator via a power divider.
3. The RF output of EUT was connected to the spectrum analyzer by an RF cable and attenuator. The path loss was compensated to the results for each measurement.
4. The middle channel for the highest RF power within the transmitting frequency was measured.
5. The conducted spurious emission for the whole frequency range was taken.
6. The RF fundamental frequency should be excluded against the limit line in the operating frequency band.
7. The limit line is derived from $43 + 10\log(P)$ dB below the transmitter power P(Watts)



3.9 Frequency Stability

3.9.1 Description of Frequency Stability Measurement

The frequency stability shall be measured by variation of ambient temperature and variation of primary supply voltage to ensure that the fundamental emission stays within the authorized frequency block. The frequency stability of the transmitter shall be maintained within $\pm 0.00025\%$ ($\pm 2.5\text{ppm}$) of the center frequency.

3.9.2 Test Procedures for Temperature Variation

1. The testing follows ANSI C63.26 section 5.6.4
2. The EUT was set up in the thermal chamber and connected with the system simulator.
3. With power OFF, the temperature was decreased to -30°C and the EUT was stabilized before testing. Power was applied and the maximum change in frequency was recorded within one minute.
4. With power OFF, the temperature was raised in 10°C step up to 50°C . The EUT was stabilized at each step for at least half an hour. Power was applied and the maximum frequency change was recorded within one minute.

3.9.3 Test Procedures for Voltage Variation

1. The testing follows ANSI C63.26 section 5.6.5
2. The EUT was placed in a temperature chamber at $20\pm 5^{\circ}\text{C}$ and connected with the system simulator.
3. The power supply voltage to the EUT was varied from 85% to 115% of the nominal value for other than hand carried battery equipment.
4. For hand carried, battery powered equipment, reduce the primary ac or dc supply voltage to the battery operating end point, which shall be specified by the manufacturer.
5. The variation in frequency was measured for the worst case.

4 Radiated Test Items

4.1 Measuring Instruments

See list of measuring instruments of this test report.

4.2 Test Setup

4.2.1 For radiated test from 30MHz to 1GHz

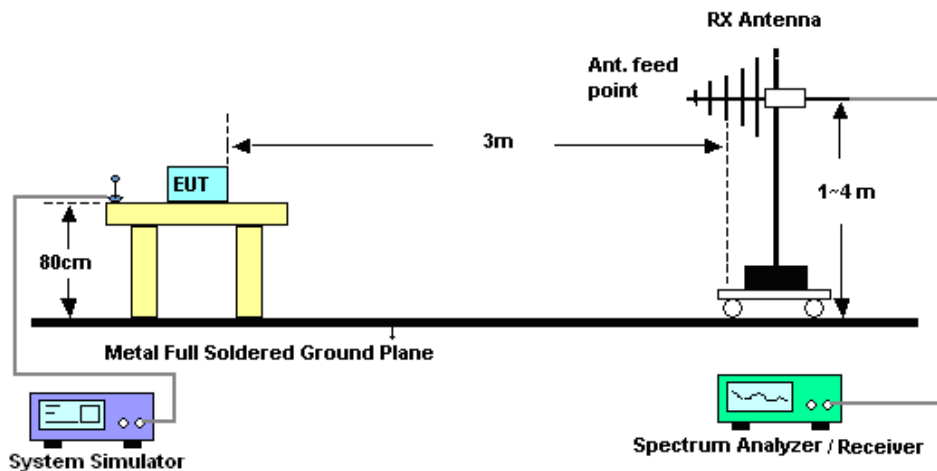

4.2.2 For radiated test above 1GHz

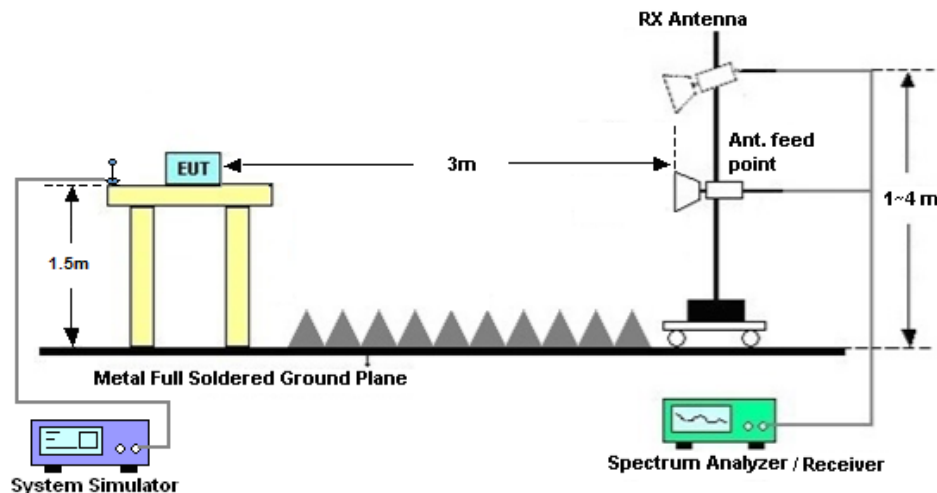

4.3 Test Result of Radiated Test

Please refer to Appendix B.



4.4 Field Strength of Spurious Radiation Measurement

4.4.1 Description of Field Strength of Spurious Radiated Measurement

The power of any emission outside of the authorized operating frequency ranges must be attenuated below the transmitter power (P) by a factor of at least $43 + 10 \log (P)$ dB. The spectrum is scanned from 30 MHz up to a frequency including its 10th harmonic.

4.4.2 Test Procedures

1. The testing follows ANSI C63.26 Section 5.5
2. The EUT was placed on a rotatable wooden table 0.8 meters for frequency below 1GHz and 1.5 meter for frequency above 1GHz above the ground.
3. The EUT was set 3 meters from the receiving antenna, which was mounted on the antenna tower.
4. The table was rotated 360 degrees to determine the position of the highest spurious emission.
5. The height of the receiving antenna is varied between one meter and four meters to search for the maximum spurious emission for both horizontal and vertical polarizations.
6. Make the measurement with the spectrum analyzer's RBW = 1MHz, VBW = 3MHz, taking record of maximum spurious emission.
7. A horn antenna was substituted in place of the EUT and was driven by a signal generator.
8. Tune the output power of signal generator to the same emission level with EUT maximum spurious emission.
9. Taking the record of output power at antenna port.
10. Repeat step 7 to step 8 for another polarization.
11. $EIRP \text{ (dBm)} = S.G. \text{ Power} - Tx \text{ Cable Loss} + Tx \text{ Antenna Gain}$
12. $ERP \text{ (dBm)} = EIRP - 2.15$
13. The RF fundamental frequency should be excluded against the limit line in the operating frequency band.
14. The limit line is derived from $43 + 10\log(P)$ dB below the transmitter power P(Watts)



5 List of Measuring Equipment

Instrument	Manufacturer	Model No.	Serial No.	Characteristics	Calibration Date	Test Date	Due Date	Remark
Spectrum Analyzer	R&S	FSV40	101078	10Hz~40GHz	Apr. 18, 2019	Mar. 21, 2020	Apr. 17, 2020	Conducted (TH01-SZ)
Thermal Chamber	Ten Billion Hongzhangroup	LP-150U	H2014081803	-40~+150°C	Dec. 26, 2019	Mar. 21, 2020	Dec. 25, 2020	Conducted (TH01-SZ)
EXA Spectrum Analyzer	KEYSIGHT	N9010A	MY55150213	10Hz~44GHz	Apr. 18, 2019	Mar. 08, 2020	Apr. 17, 2020	Radiation (03CH04-SZ)
Bilog Antenna	TeseQ	CBL6111D	41909	30MHz~1GHz	Aug. 27, 2019	Mar. 08, 2020	Aug. 26, 2020	Radiation (03CH04-SZ)
Double Ridge Horn Antenna	SCHWARZBECK	BBHA9120D	9120D-1474	1GHz~18GHz	Apr. 01, 2019	Mar. 08, 2020	Mar. 31, 2020	Radiation (03CH04-SZ)
Horn Antenna	SCHWARZBECK	BBHA9170	9170#679	15GHz~40GHz	Apr. 19, 2019	Mar. 08, 2020	Apr. 18, 2020	Radiation (03CH04-SZ)
Amplifier	Burgeon	BPA-530	102211	0.01Hz ~3000MHz	Oct. 18, 2019	Mar. 08, 2020	Oct. 17, 2020	Radiation (03CH04-SZ)
HF Amplifier	MITEQ	AMF-7D-00 101800-30-1 0P-R	1943528	1GHz~18GHz	Oct. 18, 2019	Mar. 08, 2020	Oct. 17, 2020	Radiation (03CH04-SZ)
HF Amplifier	MITEQ	TTA1840-35 -HG	1871923	18GHz~40GHz	Jul. 22, 2019	Mar. 08, 2020	Jul. 21, 2020	Radiation (03CH04-SZ)
Amplifier	Agilent Technologies	83017A	MY53270156	500MHz~26.5GHz	Aug. 26 2019	Mar. 08, 2020	Aug. 25, 2020	Radiation (03CH04-SZ)
AC Power Source	Chroma	61601	N/A	N/A	NCR	Mar. 08, 2020	NCR	Radiation (03CH04-SZ)
Turn Table	EM	EM1000	N/A	0~360 degree	NCR	Mar. 08, 2020	NCR	Radiation (03CH04-SZ)
Antenna Mast	EM	EM1000	N/A	1 m~4 m	NCR	Mar. 08, 2020	NCR	Radiation (03CH04-SZ)

NCR: No Calibration Required



6 Uncertainty of Evaluation

The measurement uncertainties shown below were calculated in accordance with the requirements of ANSI 63.26-2015. All the measurement uncertainty value were shown with a coverage $K=2$ to indicate 95% level of confidence. The measurement data show herein meets or exceeds the CISPR measurement uncertainty values specified in CISPR 16-4-2 and can be compared directly to specified limit to determine compliance.

Uncertainty of Radiated Emission Measurement (30 MHz ~ 1000 MHz)

Measuring Uncertainty for a Level of Confidence of 95% ($U = 2Uc(y)$)	2.8dB
---	-------

Uncertainty of Radiated Emission Measurement (1 GHz ~ 18 GHz)

Measuring Uncertainty for a Level of Confidence of 95% ($U = 2Uc(y)$)	3.1dB
---	-------

Uncertainty of Radiated Emission Measurement (18 GHz ~ 40 GHz)

Measuring Uncertainty for a Level of Confidence of 95% ($U = 2Uc(y)$)	3.9dB
---	-------



Appendix A. Test Results of Conducted Test

Conducted Output Power(Average power)

Conducted Power (*Unit: dBm)									
Band	WCDMA Band V			WCDMA Band II			WCDMA Band IV		
Channel	4132	4182	4233	9262	9400	9538	1312	1413	1513
Frequency	826.4	836.4	846.6	1852.4	1880	1907.6	1712.4	1732.6	1752.6
RMC 12.2K	22.25	22.27	22.29	22.34	22.24	22.21	22.28	22.34	22.35
HSDPA Subtest-1	21.15	21.13	20.91	21.24	21.70	21.63	21.38	21.38	21.45
HSDPA Subtest-2	20.93	20.87	20.71	20.95	21.44	21.27	21.24	21.25	21.23
HSDPA Subtest-3	20.61	20.56	20.42	21.14	21.57	21.51	20.39	20.44	20.48
HSDPA Subtest-4	20.50	20.65	20.38	21.17	21.28	21.12	20.21	20.18	20.22
DC-HSDPA Subtest-1	21.09	21.08	20.87	21.20	21.66	21.58	21.34	21.34	21.40
DC-HSDPA Subtest-2	20.87	20.82	20.67	20.91	21.39	21.21	21.20	21.20	21.17
DC-HSDPA Subtest-3	20.55	20.51	20.38	21.10	21.52	21.45	20.35	20.39	20.42
DC-HSDPA Subtest-4	20.45	20.61	20.34	21.12	21.22	21.06	20.16	20.12	20.16
HSUPA Subtest-1	19.64	19.27	19.28	18.97	19.00	18.97	18.77	18.81	18.86
HSUPA Subtest-2	19.53	19.73	19.62	19.77	19.84	19.80	19.16	19.33	19.37
HSUPA Subtest-3	19.60	19.88	19.48	19.36	19.58	19.34	19.03	19.26	19.30
HSUPA Subtest-4	19.16	19.23	19.13	19.59	19.65	19.84	19.27	19.45	19.67
HSUPA Subtest-5	20.90	21.00	20.80	21.50	21.70	21.80	21.50	21.50	21.50



ERP/EIRP

WCDMA Band V ($G_T - L_C = 1.50$ dB)			
Channel	4132	4182	4233
	(Low)	(Mid)	(High)
Frequency	826.4	836.4	846.6
(MHz)			
Conducted Power (dBm)	22.25	22.27	22.29
Conducted Power (Watts)	0.1679	0.1687	0.1694
ERP(dBm)	21.60	21.62	21.64
ERP(Watts)	0.1445	0.1452	0.1459

WCDMA Band II ($G_T - L_C = 1.00$ dB)			
Channel	9262	9400	9538
	(Low)	(Mid)	(High)
Frequency	1852.4	1880	1907.6
(MHz)			
Conducted Power (dBm)	22.34	22.24	22.21
Conducted Power (Watts)	0.1714	0.1675	0.1663
EIRP(dBm)	23.34	23.24	23.21
EIRP(Watts)	0.2158	0.2109	0.2094

WCDMA Band IV ($G_T - L_C = 1.00$ dB)			
Channel	1312	1413	1513
	(Low)	(Mid)	(High)
Frequency	1712.4	1732.6	1752.6
(MHz)			
Conducted Power (dBm)	22.28	22.34	22.35
Conducted Power (Watts)	0.1690	0.1714	0.1718
EIRP(dBm)	23.28	23.34	23.35
EIRP(Watts)	0.2128	0.2158	0.2163



Peak-to-Average Ratio

Mode	WCDMA Band V(dB)	WCDMA Band II(dB)	WCDMA Band IV(dB)	Limit: 13dB
Mod.	RMC 12.2Kbps	RMC 12.2Kbps	RMC 12.2Kbps	Result
Lowest CH	3.04	3.07	2.99	PASS
Middle CH	3.04	3.07	2.99	
Highest CH	3.16	3.01	2.99	



WCDMA Band V (RMC 12.2Kbps)

Lowest Channel

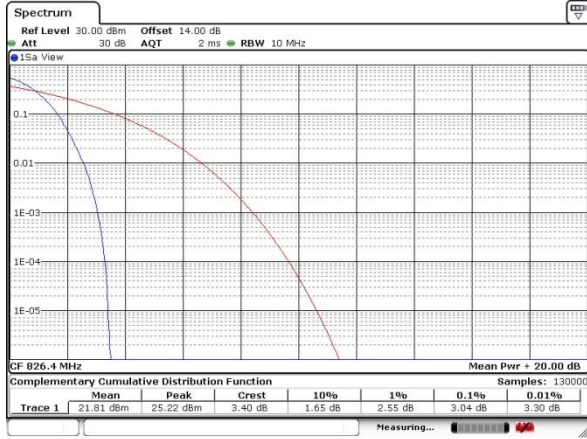

Date: 21.MAR.2020 22:01:21

WCDMA Band II (RMC 12.2Kbps)

Lowest Channel

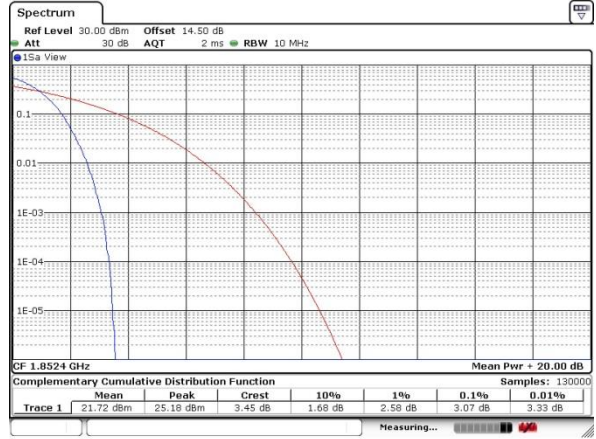

Date: 21.MAR.2020 21:47:04

Middle Channel

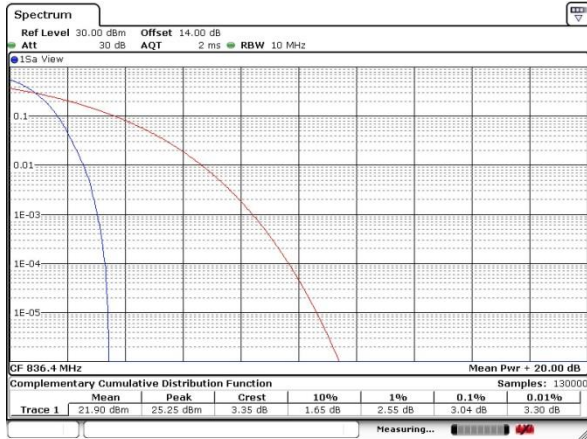

Date: 21.MAR.2020 22:01:37

Middle Channel

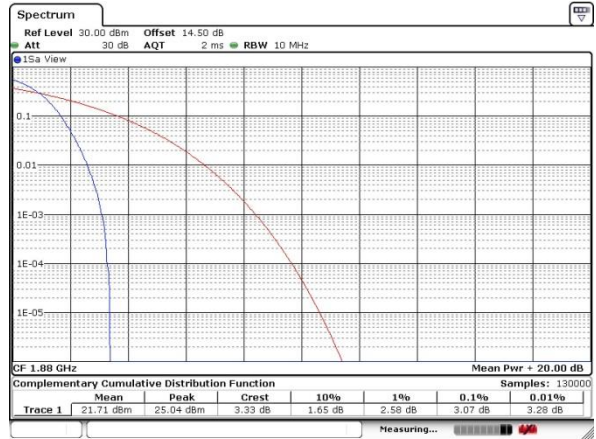

Date: 21.MAR.2020 21:47:19

Highest Channel

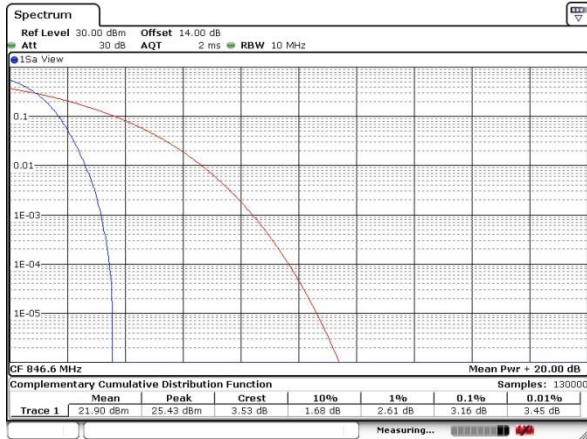

Date: 21.MAR.2020 22:01:54

Highest Channel

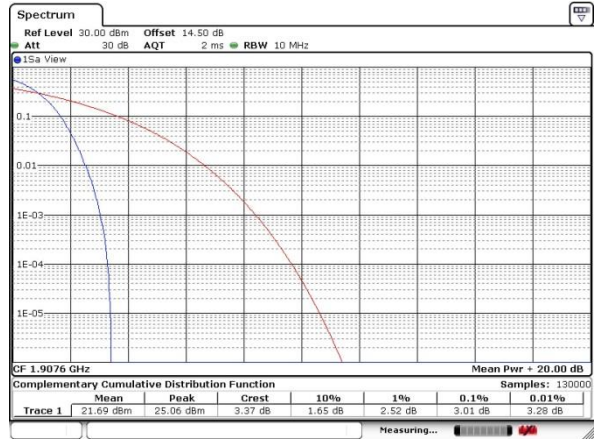

Date: 21.MAR.2020 21:47:32

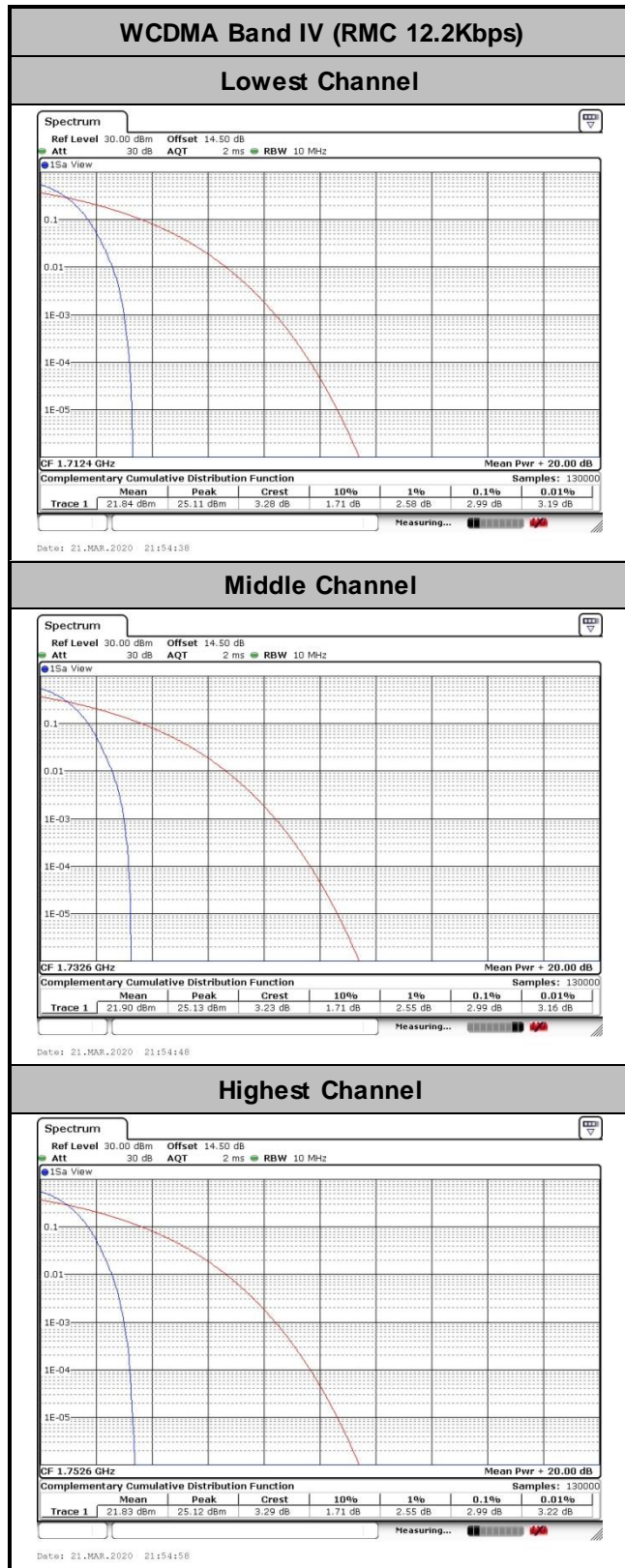



26dB Bandwidth

Mode	WCDMA Band V(MHz)	WCDMA Band II(MHz)	WCDMA Band IV(MHz)
Mod.	RMC 12.2Kbps	RMC 12.2Kbps	RMC 12.2Kbps
Lowest CH	4.675	4.675	4.665
Middle CH	4.665	4.675	4.655
Highest CH	4.665	4.655	4.675



WCDMA Band V (RMC 12.2Kbps)

Lowest Channel

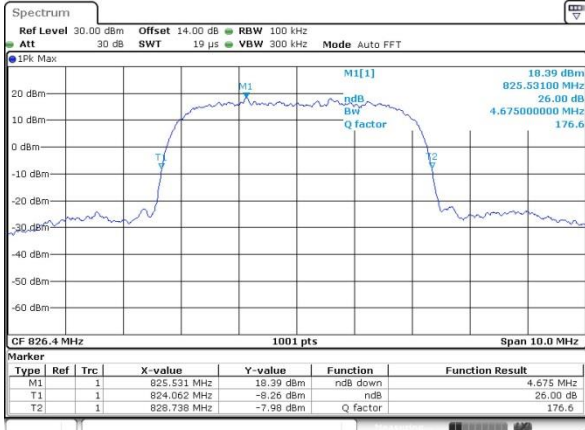

Date: 21.MAR.2020 21:55:35

WCDMA Band II (RMC 12.2Kbps)

Lowest Channel

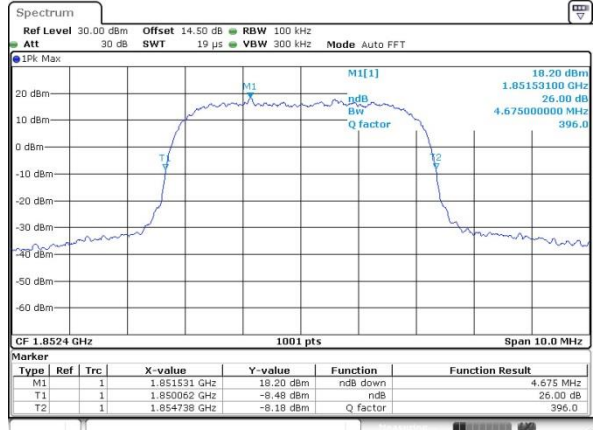

Date: 21.MAR.2020 21:37:48

Middle Channel

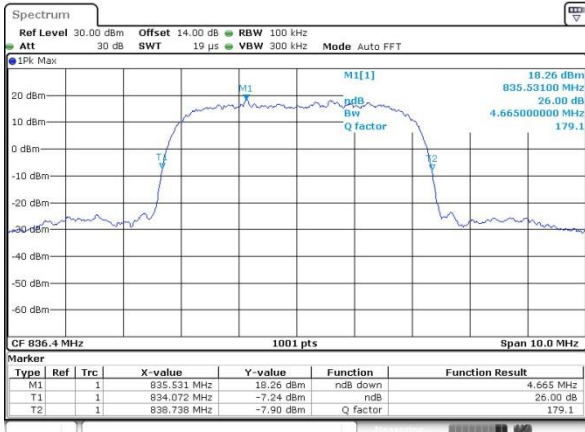

Date: 21.MAR.2020 21:55:57

Middle Channel

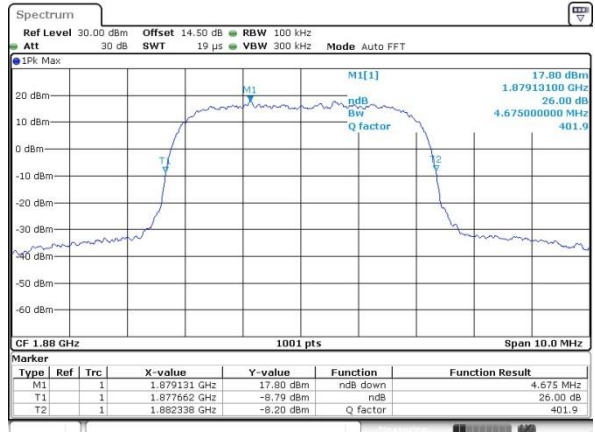

Date: 21.MAR.2020 21:38:12

Highest Channel

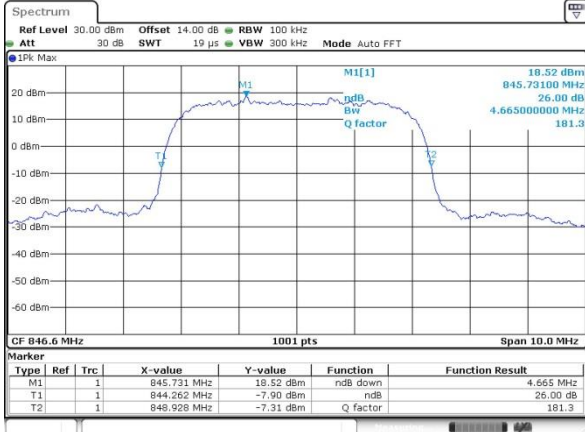

Date: 21.MAR.2020 21:56:19

Highest Channel

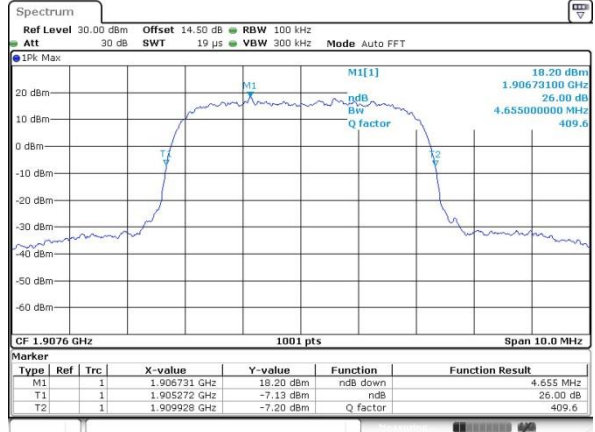

Date: 21.MAR.2020 21:38:36

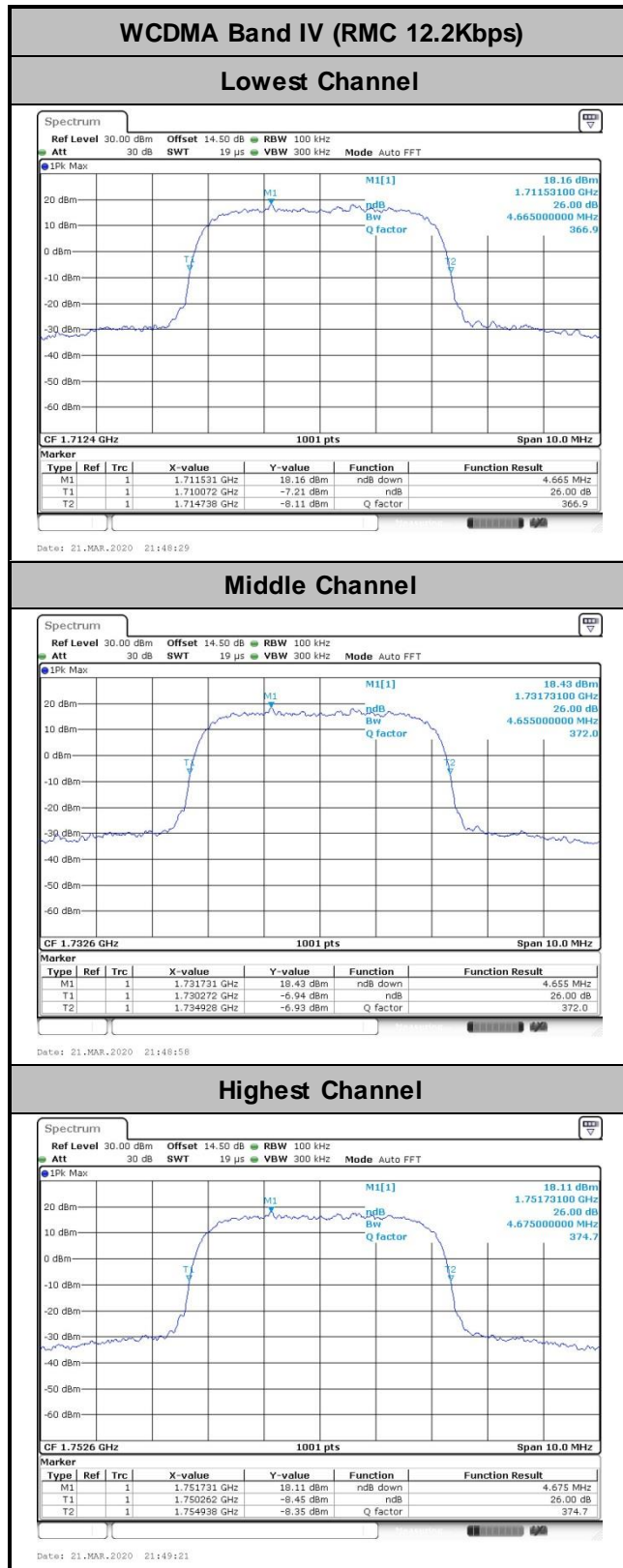



Occupied Bandwidth

Mode	WCDMA Band V(MHz)	WCDMA Band II(MHz)	WCDMA Band IV(MHz)
Mod.	RMC 12.2Kbps	RMC 12.2Kbps	RMC 12.2Kbps
Lowest CH	4.14	4.14	4.15
Middle CH	4.15	4.13	4.14
Highest CH	4.14	4.13	4.14



WCDMA Band V (RMC 12.2Kbps)

Lowest Channel

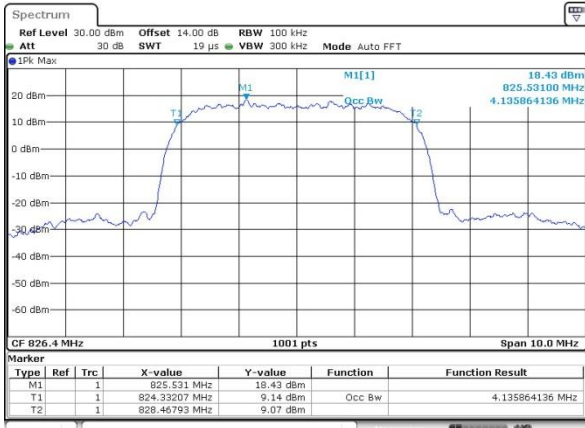

Date: 21.MAR.2020 21:56:50

WCDMA Band II (RMC 12.2Kbps)

Lowest Channel

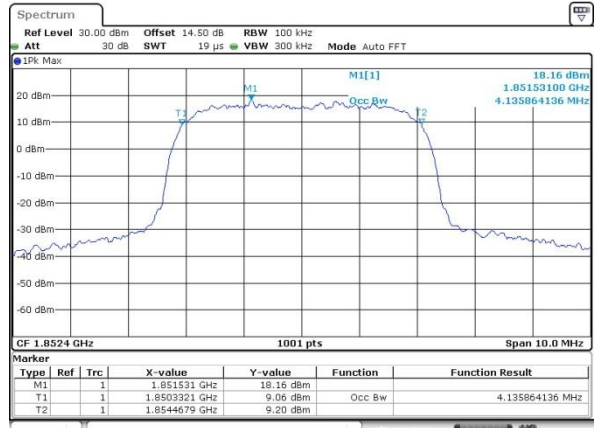

Date: 21.MAR.2020 21:39:03

Middle Channel

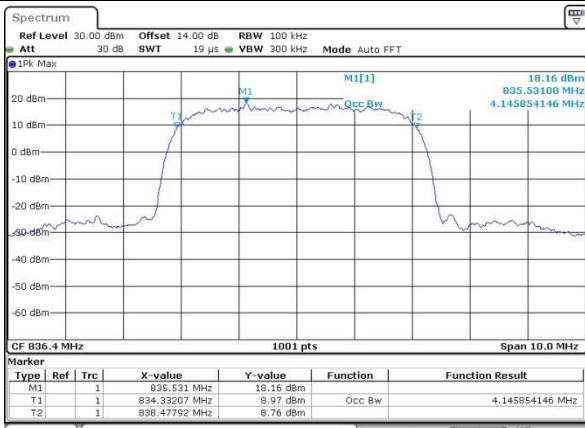

Date: 21.MAR.2020 21:57:11

Middle Channel

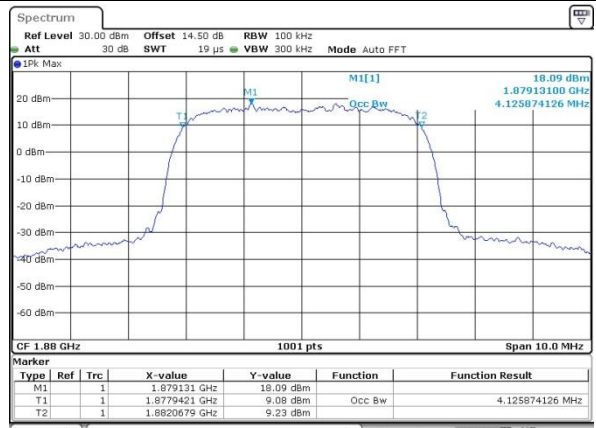

Date: 21.MAR.2020 21:39:23

Highest Channel

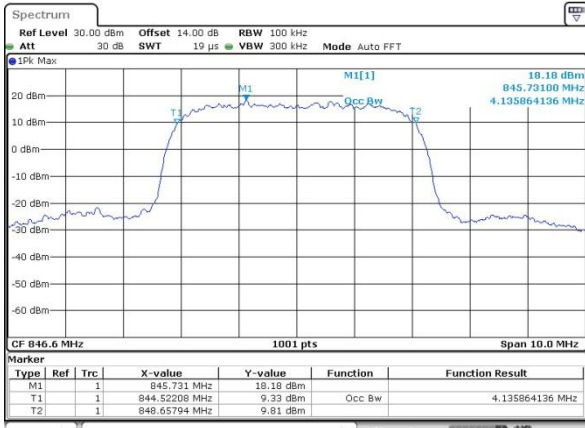

Date: 21.MAR.2020 21:57:32

Highest Channel

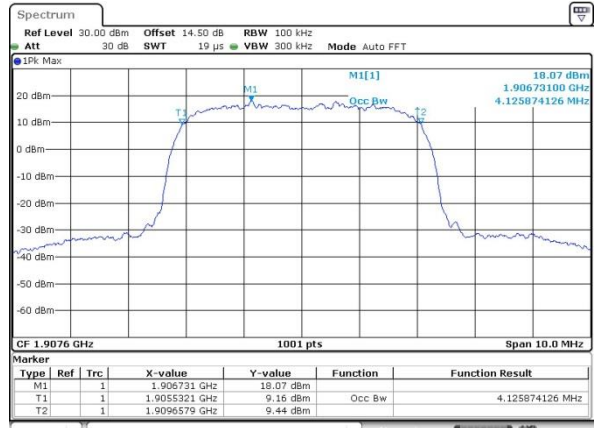

Date: 21.MAR.2020 21:39:51

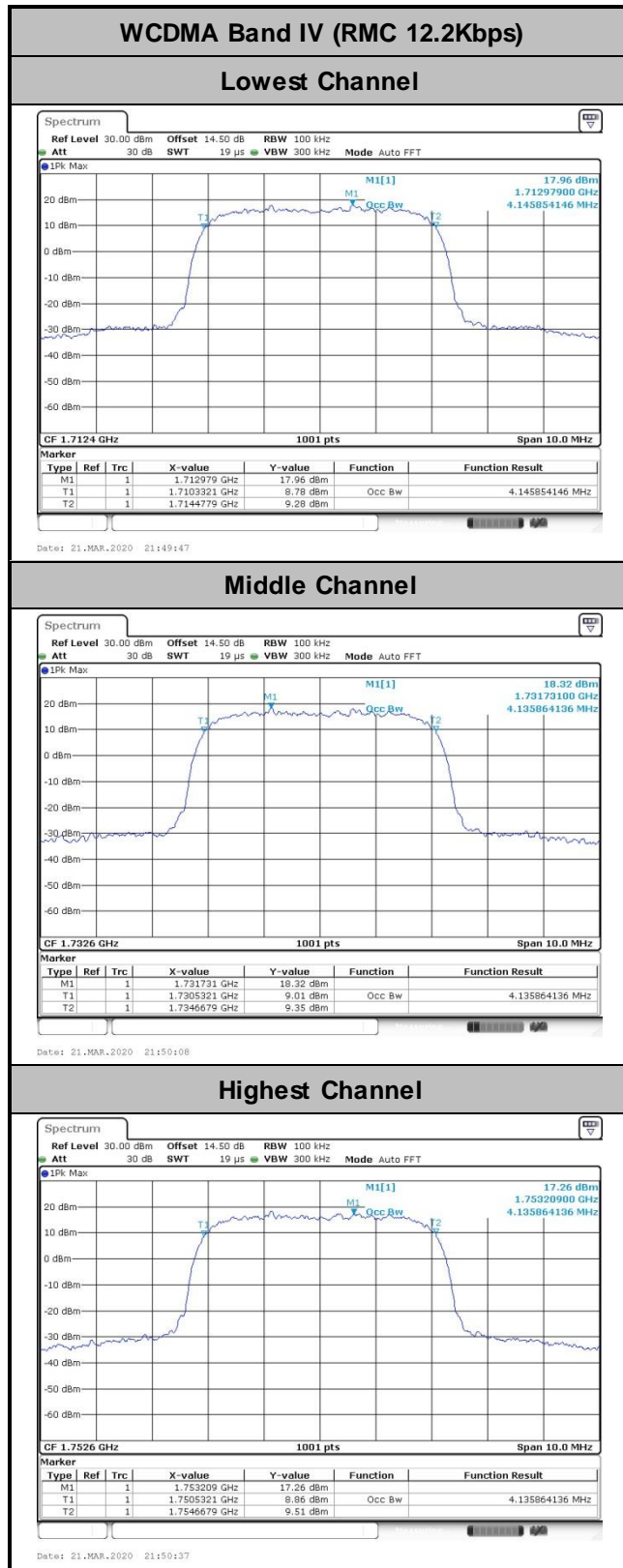



Conducted Band Edge

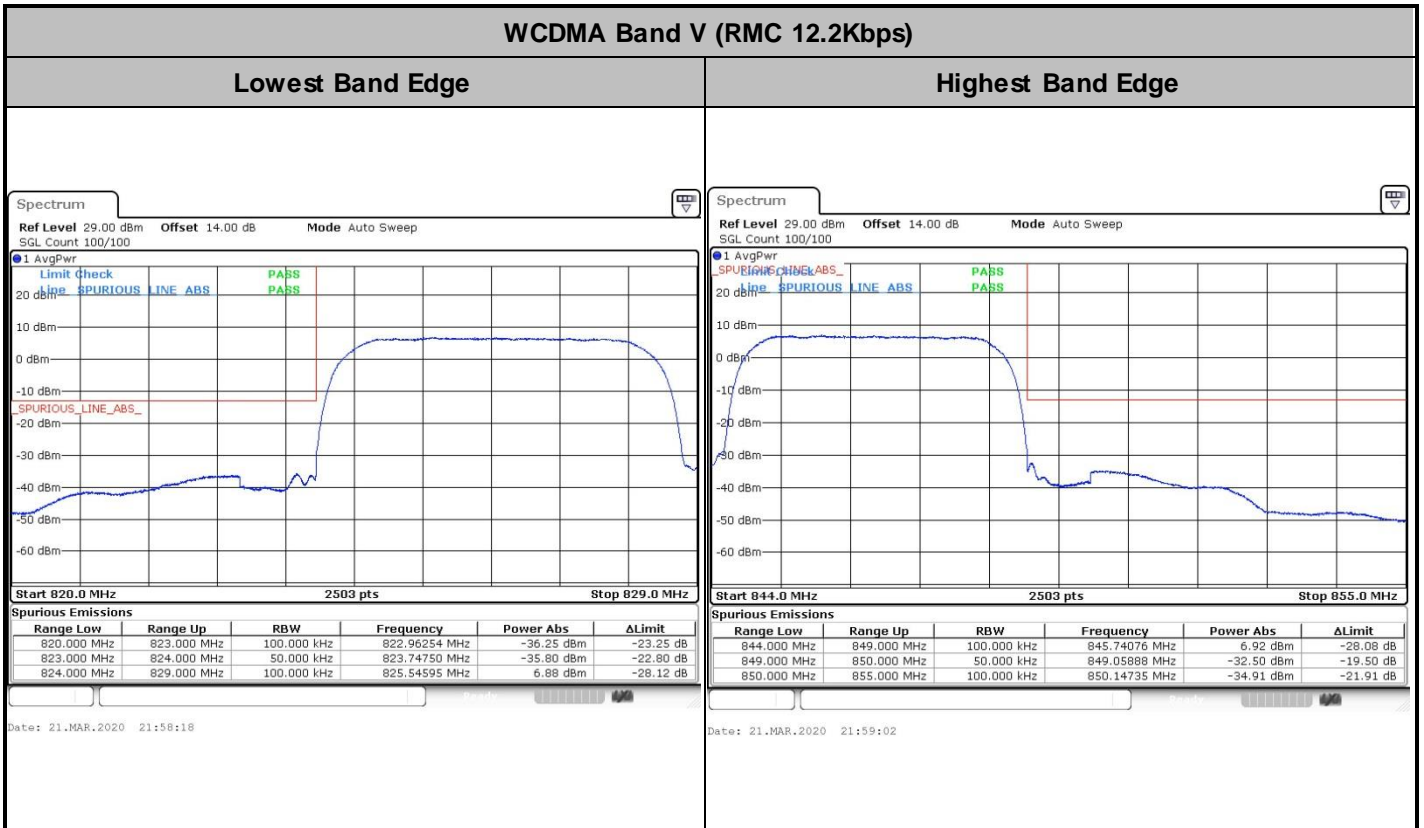

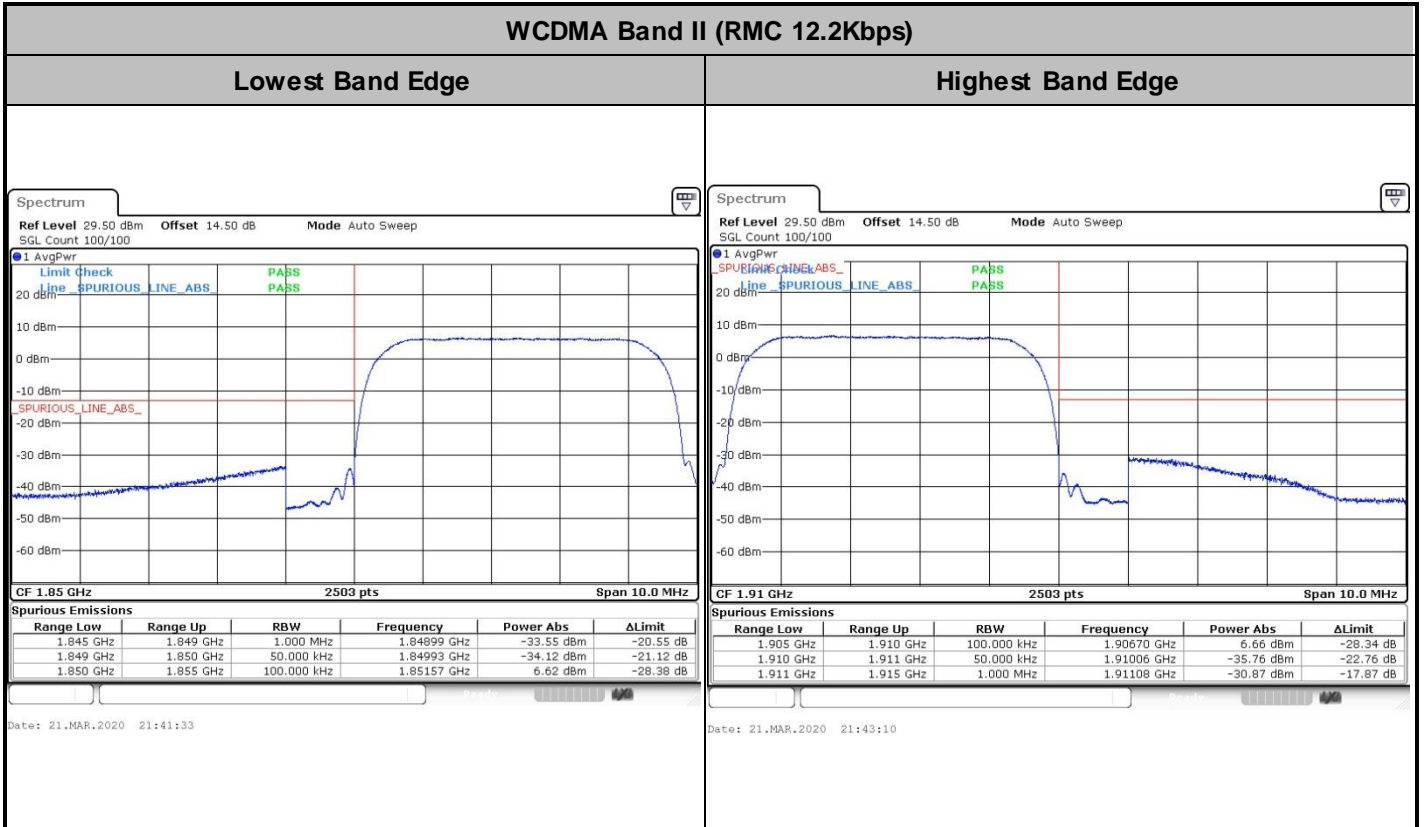

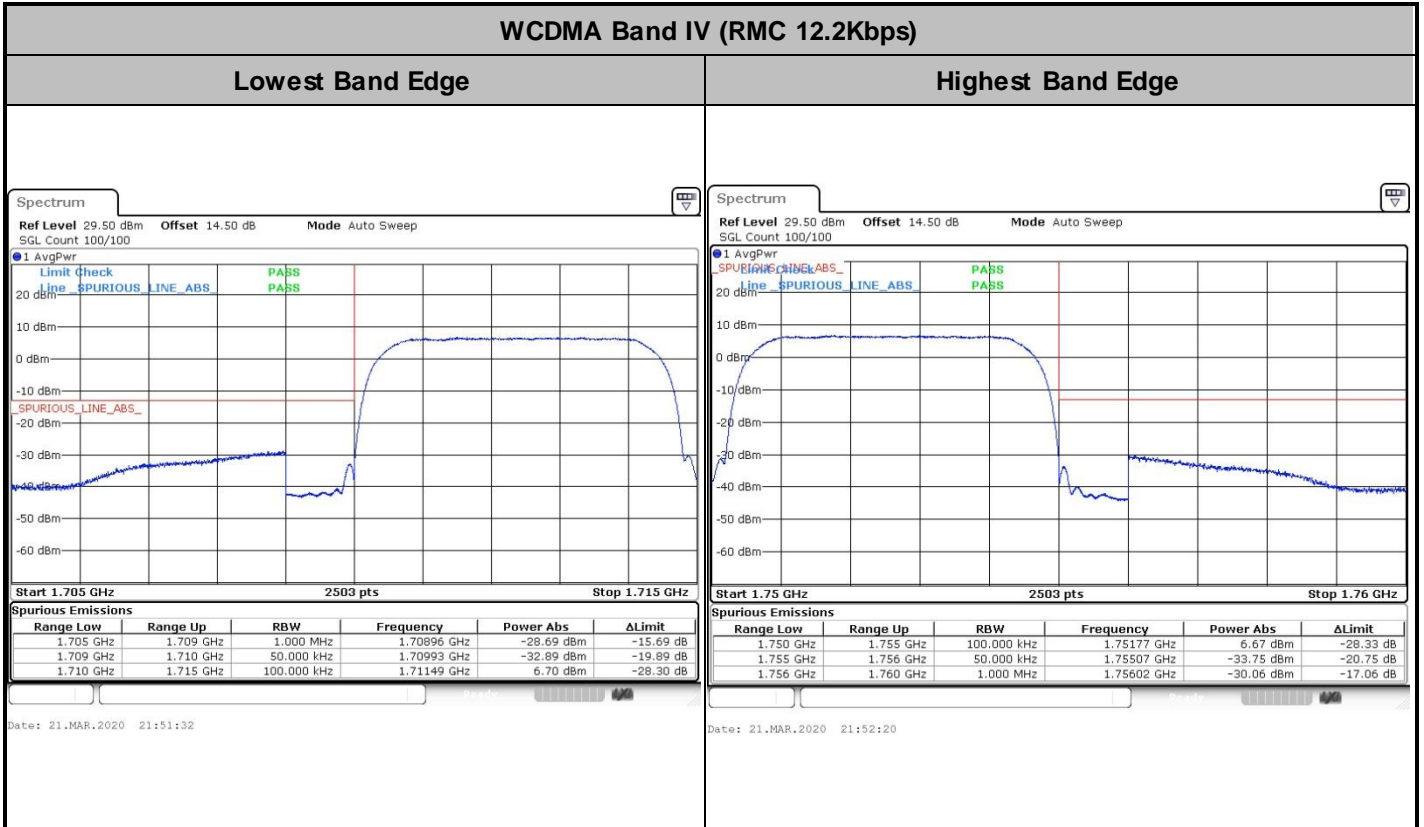



Conducted Spurious Emission

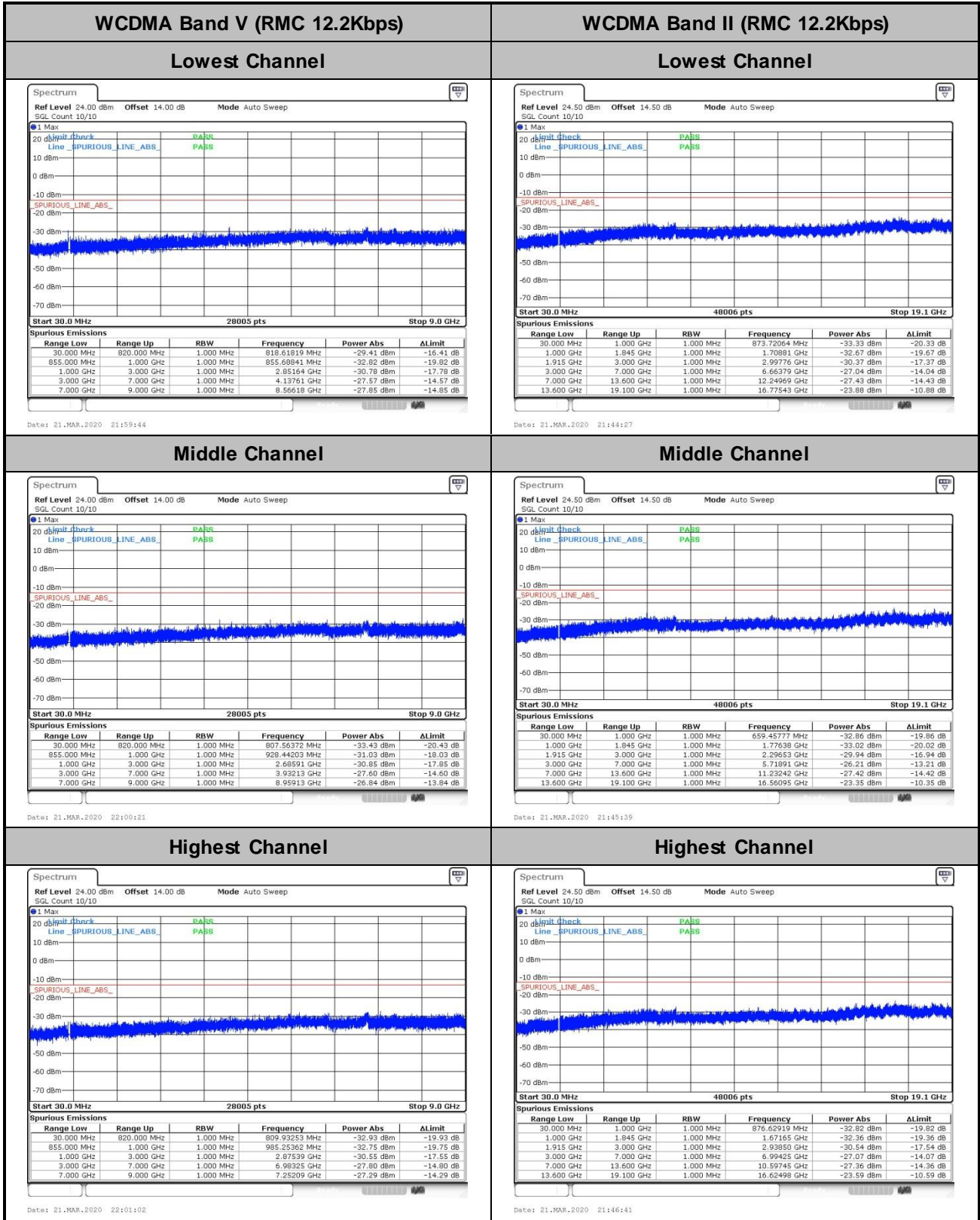

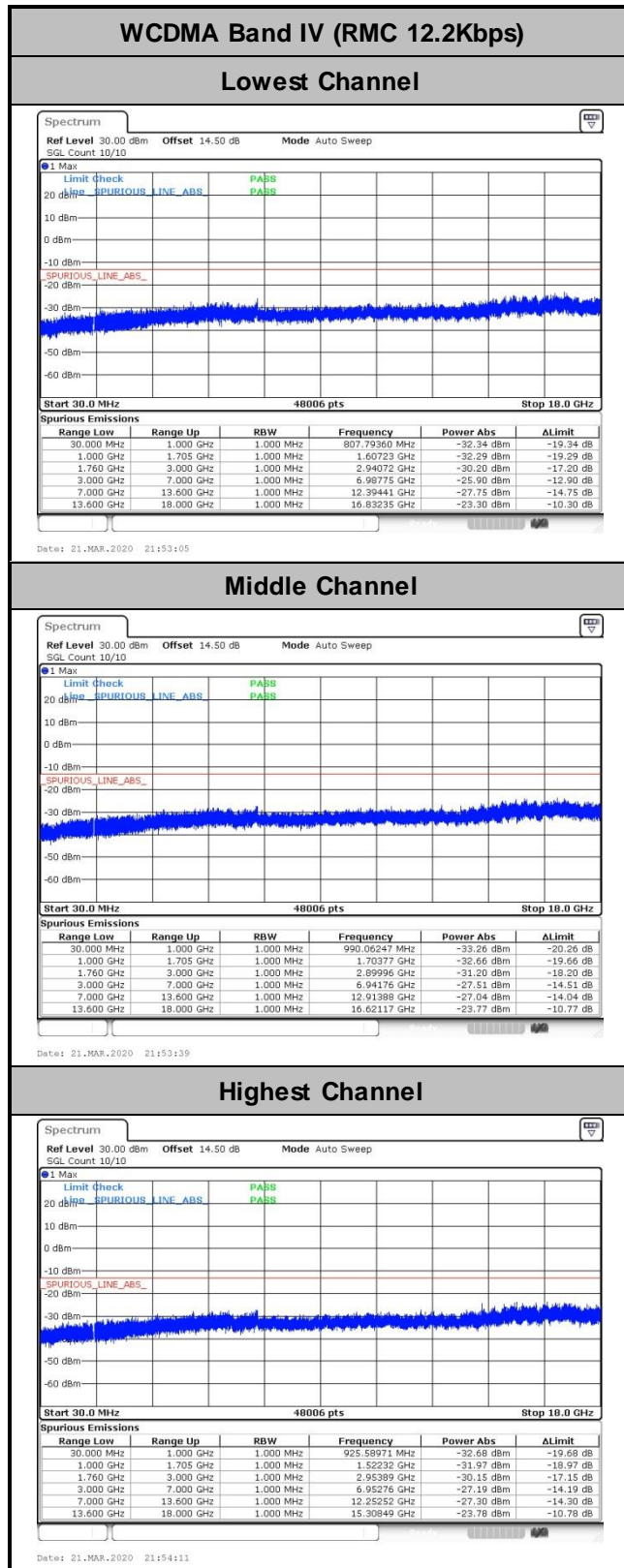



Frequency Stability

Test Conditions	Middle Channel	WCDMA Band V (RMC 12.2Kbps)	Limit 2.5ppm
Temperature (°C)	Voltage (Volt)	Deviation (ppm)	Result
50	Normal Voltage	0.0012	PASS
40	Normal Voltage	0.0081	
30	Normal Voltage	0.0007	
20(Ref.)	Normal Voltage	0.0000	
10	Normal Voltage	0.0011	
0	Normal Voltage	0.0014	
-10	Normal Voltage	0.0020	
-20	Normal Voltage	0.0099	
-30	Normal Voltage	0.0020	
20	Maximum Voltage	0.0011	
20	Normal Voltage	0.0000	
20	Battery End Point	0.0017	

Note: Normal Voltage = 3.8V. ; Battery End Point (BEP) = 3.6 V. ; Maximum Voltage =4.35 V



Test Conditions	Middle Channel	WCDMA Band II (RMC 12.2Kbps)	Limit
			Note 2.
Temperature (°C)	Voltage (Volt)	Deviation (ppm)	Result
50	Normal Voltage	0.0007	PASS
40	Normal Voltage	0.0030	
30	Normal Voltage	0.0003	
20(Ref.)	Normal Voltage	0.0000	
10	Normal Voltage	0.0036	
0	Normal Voltage	0.0031	
-10	Normal Voltage	0.0007	
-20	Normal Voltage	0.0000	
-30	Normal Voltage	0.0034	
20	Maximum Voltage	0.0035	
20	Normal Voltage	0.0000	
20	Battery End Point	0.0030	

Note:

1. Normal Voltage = 3.8V. ; Battery End Point (BEP) = 3.6 V. ; Maximum Voltage =4.35 V
2. The frequency fundamental emissions stay within the authorized frequency block based on the frequency deviation measured is small.



Test Conditions	Middle Channel	WCDMA Band IV (RMC 12.2Kbps)	Limit
			Note 2.
Temperature (°C)	Voltage (Volt)	Deviation (ppm)	Result
50	Normal Voltage	0.0006	PASS
40	Normal Voltage	0.0048	
30	Normal Voltage	0.0044	
20(Ref.)	Normal Voltage	0.0000	
10	Normal Voltage	0.0040	
0	Normal Voltage	0.0040	
-10	Normal Voltage	0.0043	
-20	Normal Voltage	0.0000	
-30	Normal Voltage	0.0008	
20	Maximum Voltage	0.0043	
20	Normal Voltage	0.0000	
20	Battery End Point	0.0003	

Note:

1. Normal Voltage = 3.8V. ; Battery End Point (BEP) = 3.6 V. ; Maximum Voltage =4.35 V
2. The frequency fundamental emissions stay within the authorized frequency block based on the frequency deviation measured is small.



Radiated Spurious Emission

WCDMA Band V(RMC 12.2Kbps)									
Channel	Frequency (MHz)	ERP (dBm)	Limit (dBm)	Over Limit (dB)	SPA Reading (dBm)	S.G. Power (dBm)	TX Cable loss (dB)	TX Antenna Gain (dBi)	Polarization (H/V)
Lowest	1652.8	-53.38	-13	-40.38	-62.93	-56.61	3.98	9.36	H
	2479.2	-57.38	-13	-44.38	-70.80	-60.93	4.85	10.55	H
	3305.6	-52.18	-13	-39.18	-67.69	-57.11	5.50	12.58	H
	4132	-41.65	-13	-28.65	-60.60	-46.12	5.98	12.60	H
	1652.8	-60.99	-13	-47.99	-70.02	-64.22	3.98	9.36	V
	2479.2	-62.17	-13	-49.17	-75.39	-65.72	4.85	10.55	V
	3305.6	-59.42	-13	-46.42	-74.52	-64.35	5.50	12.58	V
	4132	-49.81	-13	-36.81	-67.84	-54.28	5.98	12.60	V
Middle	1672.8	-49.44	-13	-36.44	-59.34	-52.69	4.00	9.40	H
	2509.2	-57.80	-13	-44.80	-71.20	-61.37	4.88	10.60	H
	3345.6	-46.29	-13	-33.29	-61.73	-51.22	5.52	12.60	H
	4182	-38.00	-13	-25.00	-56.90	-42.47	6.00	12.62	H
	1672.8	-57.69	-13	-44.69	-67.08	-60.94	4.00	9.40	V
	2509.2	-62.21	-13	-49.21	-75.44	-65.78	4.88	10.60	V
	3345.6	-57.10	-13	-44.10	-72.10	-62.03	5.52	12.60	V
	4182	-47.57	-13	-34.57	-65.47	-52.04	6.00	12.62	V
Highest	1693.2	-46.96	-13	-33.96	-57.04	-50.13	4.10	9.42	H
	2539.8	-61.11	-13	-48.11	-74.52	-64.69	4.90	10.63	H
	3386.4	-45.57	-13	-32.57	-60.46	-50.49	5.55	12.62	H
	4233	-39.34	-13	-26.34	-58.27	-43.82	6.02	12.65	H
	1693.2	-55.55	-13	-42.55	-65.13	-58.72	4.10	9.42	V
	2539.8	-62.40	-13	-49.40	-75.55	-65.98	4.90	10.63	V
	3386.4	-56.02	-13	-43.02	-70.43	-60.94	5.55	12.62	V
	4233	-48.55	-13	-35.55	-66.49	-53.03	6.02	12.65	V

Remark: Spurious emissions within 30-1000MHz were found more than 20dB below limit line.



WCDMA Band II(RMC 12.2Kbps)									
Channel	Frequency (MHz)	EIRP (dBm)	Limit (dBm)	Over Limit (dB)	SPA Reading (dBm)	S.G. Power (dBm)	TX Cable loss (dB)	TX Antenna Gain (dBi)	Polarization (H/V)
Lowest	3704.8	-45.07	-13	-32.07	-62.74	-51.83	5.82	12.58	H
	5557.2	-56.87	-13	-43.87	-78.41	-62.59	7.28	13.00	H
	7409.6	-53.03	-13	-40.03	-79.19	-56.19	8.32	11.48	H
	3704.8	-54.39	-13	-41.39	-71.39	-61.15	5.82	12.58	V
	5557.2	-58.08	-13	-45.08	-78.86	-63.80	7.28	13.00	V
	7409.6	-53.83	-13	-40.83	-79.28	-56.99	8.32	11.48	V
Middle	3760	-44.27	-13	-31.27	-62.12	-51.02	5.85	12.60	H
	5640	-56.50	-13	-43.50	-77.96	-62.30	7.30	13.10	H
	7520	-54.01	-13	-41.01	-79.30	-57.16	8.35	11.50	H
	3760	-53.95	-13	-40.95	-71.03	-60.70	5.85	12.60	V
	5640	-58.21	-13	-45.21	-78.61	-64.01	7.30	13.10	V
	7520	-54.39	-13	-41.39	-79.1	-57.54	8.35	11.50	V
Highest	3815.2	-43.25	-13	-30.25	-61.37	-49.99	5.88	12.62	H
	5722.8	-57.35	-13	-44.35	-79.22	-63.16	7.32	13.13	H
	7630.4	-54.36	-13	-41.36	-79.24	-57.52	8.38	11.54	H
	3815.2	-51.83	-13	-38.83	-69.1	-58.57	5.88	12.62	V
	5722.8	-58.28	-13	-45.28	-79.22	-64.09	7.32	13.13	V
	7630.4	-54.52	-13	-41.52	-78.89	-57.68	8.38	11.54	V

Remark: Spurious emissions within 30-1000MHz were found more than 20dB below limit line.



WCDMA Band IV(RMC 12.2Kbps)									
Channel	Frequency (MHz)	EIRP (dBm)	Limit (dBm)	Over Limit (dB)	SPA Reading (dBm)	S.G. Power (dBm)	TX Cable loss (dB)	TX Antenna Gain (dBi)	Polarization (H/V)
Lowest	3424.8	-58.18	-13	-45.18	-73.24	-65.06	5.60	12.48	H
	5137.2	-56.45	-13	-43.45	-78.16	-62.13	7.10	12.78	H
	6849.6	-55.38	-13	-42.38	-79.29	-58.77	8.38	11.77	H
	3424.8	-60.99	-13	-47.99	-75.55	-67.87	5.60	12.48	V
	5137.2	-57.90	-13	-44.90	-78.83	-63.58	7.10	12.78	V
	6849.6	-56.46	-13	-43.46	-79.49	-59.85	8.38	11.77	V
Middle	3465.2	-59.32	-13	-46.32	-74.84	-66.17	5.65	12.50	H
	5197.8	-57.26	-13	-44.26	-79.08	-62.93	7.13	12.80	H
	6930.4	-55.74	-13	-42.74	-79.41	-59.14	8.40	11.80	H
	3465.2	-59.22	-13	-46.22	-74.25	-66.07	5.65	12.50	V
	5197.8	-58.55	-13	-45.55	-79.3	-64.22	7.13	12.80	V
	6930.4	-56.00	-13	-43.00	-79.29	-59.40	8.40	11.80	V
Highest	3505.2	-59.18	-13	-46.18	-75.15	-66.02	5.68	12.52	H
	5257.8	-58.56	-13	-45.56	-79.06	-64.23	7.15	12.82	H
	7010.4	-55.69	-13	-42.69	-79.42	-59.12	8.42	11.85	H
	3505.2	-58.93	-13	-45.93	-74.42	-65.77	5.68	12.52	V
	5257.8	-59.72	-13	-46.72	-79.16	-65.39	7.15	12.82	V
	7010.4	-55.77	-13	-42.77	-79.46	-59.20	8.42	11.85	V

Remark: Spurious emissions within 30-1000MHz were found more than 20dB below limit line.