

FCC PART 15.225  
EMI MEASUREMENT AND TEST REPORT

For

**Advanced Card Systems Ltd.**

Units 2010-2013, 20th Floor, Chevalier Commercial Centre,  
8 Wang Hoi Road, Kowloon Bay, Hong Kong

**FCC ID: V5MACR1222U**

<b>Report Type:</b> Original Report	<b>Product Type:</b> Contactless Smart Card Reader and Writer
<b>Test Engineer:</b> <u>Wayne Cheng</u>	<i>Wayne Cheng</i>
<b>Report Number:</b> <u>RSZ10090605</u>	
<b>Report Date:</b> <u>2010-10-28</u>	
<b>Reviewed By:</b> <u>Merry Zhao</u> EMC Manager	<i>Merry Zhao</i>
<b>Prepared By:</b> Bay Area Compliance Laboratories Corp. (Shenzhen) 6/F, the 3rd Phase of WanLi Industrial Building, ShiHua Road, FuTian Free Trade Zone Shenzhen, Guangdong, China Tel: +86-755-33320018 Fax: +86-755-33320008	

**Note:** This test report is prepared for the customer shown above and for the device described herein. It may not be duplicated or used in part without prior written consent from Bay Area Compliance Laboratories Corp. This report **must not** be used by the customer to claim product certification, approval, or endorsement by NVLAP\*, NIST, or any agency of the Federal Government.

\* This report may contain data that are not covered by the NVLAP accreditation and are marked with an asterisk "\*" (Rev.2)

## TABLE OF CONTENTS

<b>GENERAL INFORMATION.....</b>	<b>4</b>
PRODUCT DESCRIPTION FOR EQUIPMENT UNDER TEST (EUT).....	4
OBJECTIVE .....	4
RELATED SUBMITTAL(S)/GRANT(S).....	4
TEST METHODOLOGY .....	4
TEST FACILITY .....	4
<b>SYSTEM TEST CONFIGURATION.....</b>	<b>6</b>
JUSTIFICATION .....	6
EUT EXERCISE SOFTWARE .....	6
EQUIPMENT MODIFICATIONS .....	6
HOST SYSTEM CONFIGURATION LIST AND DETAILS .....	6
LOCAL SUPPORT EQUIPMENT LIST AND DETAILS .....	6
EXTERNAL I/O CABLE.....	7
CONFIGURATION OF TEST SETUP .....	7
BLOCK DIAGRAM OF TEST SETUP .....	8
<b>SUMMARY OF TEST RESULTS .....</b>	<b>9</b>
<b>FCC §15.203 - ANTENNA REQUIREMENT.....</b>	<b>10</b>
APPLICABLE STANDARD .....	10
ANTENNA CONNECTED CONSTRUCTION .....	10
<b>FCC §15.207 – AC LINE CONDUCTED EMISSION .....</b>	<b>11</b>
MEASUREMENT UNCERTAINTY .....	11
EUT SETUP .....	11
EMI TEST RECEIVER SETUP.....	12
TEST EQUIPMENT LIST AND DETAILS.....	12
TEST PROCEDURE .....	12
TEST RESULTS SUMMARY.....	12
TEST DATA .....	12
<b>FCC §15.205 &amp; §15.209 - RADIATED EMISSIONS TEST .....</b>	<b>15</b>
MEASUREMENT UNCERTAINTY .....	15
EUT SETUP.....	15
EMI TEST RECEIVER SETUP.....	16
TEST EQUIPMENT LIST AND DETAILS.....	16
CORRECTED AMPLITUDE & MARGIN CALCULATION .....	16
TEST RESULTS SUMMARY.....	16
TEST DATA .....	16
<b>FCC §15.225(A)(B)(C) – FIELD STRENGTH OF RADIATED EMISSIONS.....</b>	<b>18</b>
APPLICABLE STANDARD .....	18
TEST EQUIPMENT LIST AND DETAILS.....	18
EUT SETUP.....	18
TEST DATA .....	18
<b>FCC §15.225(D) &amp; §15.209 - OUT OF BAND EMISSION.....</b>	<b>22</b>
APPLICABLE STANDARD .....	22
TEST EQUIPMENT LIST AND DETAILS.....	22
EUT SETUP.....	22

---

TEST DATA .....	22
<b>FCC §15.225(E) - FREQUENCY STABILITY.....</b>	<b>25</b>
APPLICABLE STANDARD .....	25
TEST EQUIPMENT LIST AND DETAILS.....	25
TEST PROCEDURE .....	25
TEST DATA .....	25
<b>FCC §15.215(C) – 20 DB BANDWIDTH TESTING.....</b>	<b>27</b>
REQUIREMENT .....	27
TEST EQUIPMENT LIST AND DETAILS.....	27
TEST PROCEDURE .....	27
TEST DATA .....	27

---

## GENERAL INFORMATION

---

### Product Description for Equipment under Test (EUT)

The *Advanced Card Systems Ltd.*'s product, model number: *ACR1222U* (FCC ID: *V5MACR1222U*) or the "EUT" as referred to in this report is a *Contactless Smart Card Reader and Writer*. The EUT is measured approximately 11.8 cm (L) x 7.6 cm (W) x 2.0 cm (H), rated input voltage: DC 5.0 V from host PC.

*\* All measurement and test data in this report was gathered from production sample serial number: 1009024 (Assigned by BACL, Shenzhen). The EUT was received on 2010-09-06.*

### Objective

This Type approval report is prepared on behalf of *Advanced Card Systems Ltd.* in accordance with Part 2, Subpart J, and Part 15, Subparts A, B and C of the Federal Communication Commissions rules.

The objective is to determine compliance with FCC rules, sec 15.203, 15.205, 15.207, 15.209 and 15.225.

### Related Submittal(s)/Grant(s)

No Related Submittals.

### Test Methodology

All measurements contained in this report were conducted with ANSI C63.4-2003, American National Standard for Methods of Measurement of Radio-Noise Emissions from Low-Voltage Electrical and Electronic Equipment in the range of 9 kHz to 40 GHz.

All radiated and conducted emissions measurement was performed at Bay Area Compliance Lab Corp. (Shenzhen). The radiated testing was performed at an antenna-to-EUT distance of 3 meters.

### Test Facility

The Test site used by Bay Area Compliance Laboratories Corp.(Shenzhen) to collect test data is located in the 6/F, the 3rd Phase of WanLi Industrial Building, ShiHua Road, FuTian Free Trade Zone Shenzhen, Guangdong, China.

Test site at Bay Area Compliance Laboratories Corp. (Shenzhen) has been fully described in reports submitted to the Federal Communication Commission (FCC). The details of these reports have been found to be in compliance with the requirements of Section 2.948 of the FCC Rules on November 21, 2007. The facility also complies with the radiated and AC line conducted test site criteria set forth in ANSI C63.4-2003.

The Federal Communications Commission has the reports on file and is listed under FCC Registration No.: 382179. The test site has been approved by the FCC for public use and is listed in the FCC Public Access Link (PAL) database.

Additionally, Bay Area Compliance Laboratories Corp. (Shenzhen) is a National Institute of Standards and Technology (NIST) accredited laboratory, under the National Voluntary Laboratory Accredited Program (Lab Code 200707-0).



The current scope of accreditations can be found at <http://ts.nist.gov/Standards/scopes/2007070.htm>

## SYSTEM TEST CONFIGURATION

### Justification

The system was configured for testing in a typical fashion (as normally used by a typical user).

### EUT Exercise Software

APDU.exe. The software was provided by the manufacture.

### Equipment Modifications

Bay Area Compliance Lab Corp. (Shenzhen) has not done any modification on the EUT.

### Host System Configuration List and Details

Manufacturer	Description	Model	Serial Number	FCC ID
DELL	Motherboard	OWC297	CN-OWC297-70821-566-02BR	DoC
DELL	Power	NPS-250KB D	CN-0H2678-17972-56E8NBM	DoC
Seagate	Hard Disk	ST340014A	5JXK3NAD	DoC
DELL	3.5' Floppy	N/A	CN-0N8893-69802-54Q-02OZ	DoC
Lite-ON	CD-Rom	LTN-489S	N/A	DoC
Intel	CPU	Celeron D-2533	N/A	N/A
ProMOS	Memory	V826632K24SATG-C0	0525-K1933700	N/A
Intel	Ethernet	PRO 10/100 VE	N/A	DoC

### Local Support Equipment List and Details

Manufacturer	Description	Model	Serial Number	FCC ID
DELL	PC	DELL 170L	CN-0TC670-70821-560-F4WQ	DoC
DELL	Keyboard	L100	CNORH656658907BL04TY	DoC
DELL	Mouse	MOC5UO	G1B0096D	DoC
DELL	LCD Monitor	E178WFPC	CN-OWY564-64180-7C4-2SQH	DoC

## External I/O Cable

Cable Description	Length (m)	From/Port	To
Shielded Detachable K/B Cable	1.5	K/B Port	K/B
Shielded Detachable Mouse Cable	1.5	Mouse Port	Mouse
Shielded Detachable VGA Cable	1.5	VGA Port	Monitor
Unshielded Undetachable USB Cable with a Core	2.0	EUT	Host PC
Unshielded Detachable Power Cable	1.8	Host PC	LISN

## Configuration of Test Setup

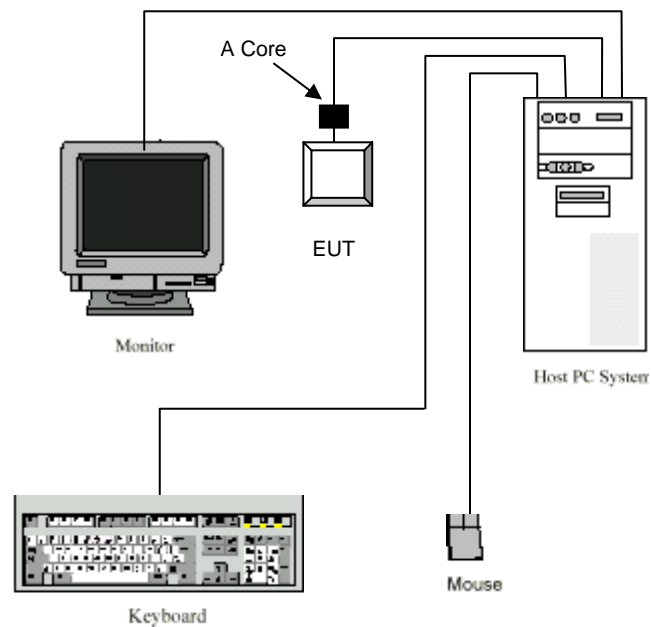

### Block Diagram of Test Setup

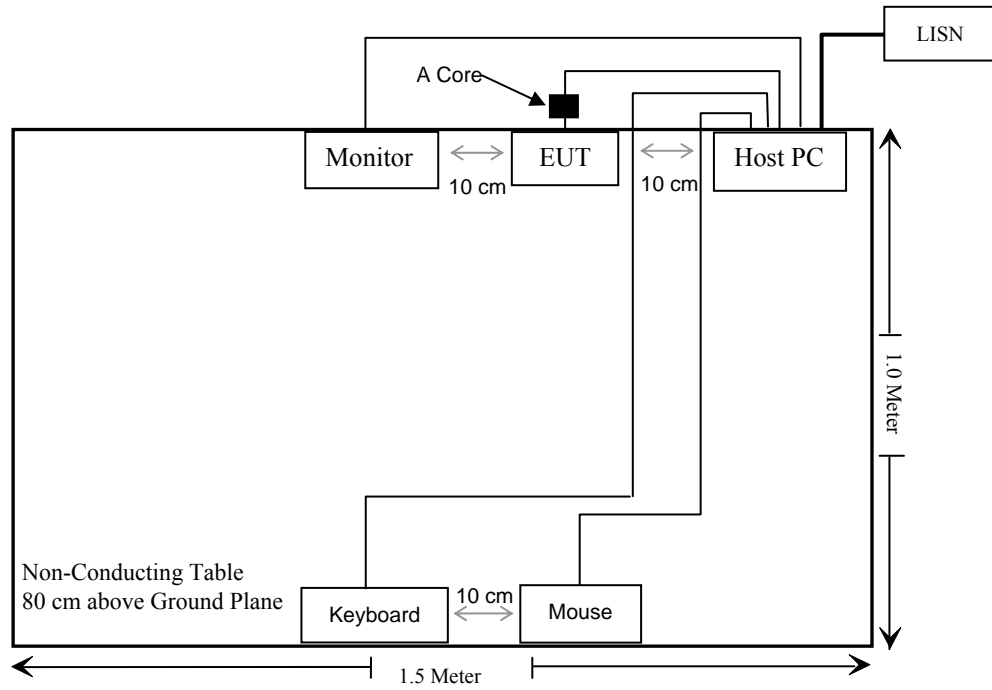



---

**SUMMARY OF TEST RESULTS**

---

<b>FCC Rules</b>	<b>Description of Test</b>	<b>Result</b>
§15.203	Antenna Requirement	Compliance
§15.205	Restricted Band of operation	Compliance
§15.207	Conducted Emission	Compliance
§15.209	Radiated Emission Test	Compliance
§15.225(a) (b) (c) §15.31(f)	Field Strength of Radiated Emissions	Compliance
§15.225(d) §15.209§15.31(f)	Out of Band Emission	Compliance
§15.225(e)	Frequency Stability	Compliance
§15.215(c)	20dB Bandwidth Testing	Compliance

---

## **FCC §15.203 - ANTENNA REQUIREMENT**

---

### **Applicable Standard**

An intentional radiator shall be designed to ensure that no antenna other than that furnished by the responsible party shall be used with the device. The use of a permanently attached antenna or of an antenna that uses a unique coupling to the intentional radiator shall be considered sufficient to comply with the provisions of this section.

### **Antenna Connected Construction**

The EUT has a printed loop antenna on PCB, which complies with the Part 15.203. Please see EUT photo for details.

## FCC §15.207 – AC LINE CONDUCTED EMISSION

### Measurement Uncertainty

All measurements involve certain levels of uncertainties, especially in field of EMC. The factors contributing to uncertainties are spectrum analyzer, cable loss, and LISN.

Based on NIS 81, The Treatment of Uncertainty in EMC Measurements, the best estimate of the uncertainty of any conducted emissions measurement at Bay Area Compliance Lab Corp. (Shenzhen) is  $\pm 2.4$  dB.

### EUT Setup

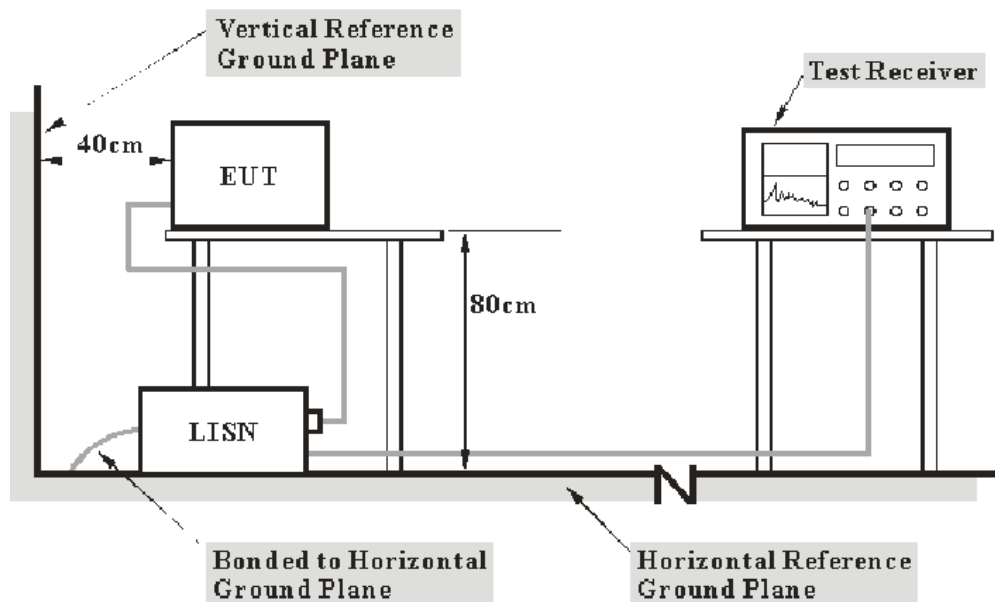

- Note:**
1. Support units were connected to second LISN.
  2. Both of LISNs (AMN) 80 cm from EUT and at the least 80 cm from other units and other metal planes support units.

The setup of EUT is according with per ANSI C63.4-2003 measurement procedure. The specification used was with the FCC Part 15.207.

The external I/O cables were draped along the test table and formed a bundle 30 to 40 cm long in the middle.

The spacing between the peripherals was 10 cm.

The host PC was connected to a 120 VAC/60 Hz power source.

## EMI Test Receiver Setup

The EMI test receiver was set to investigate the spectrum from 150 kHz to 30 MHz.

During the conducted emission test, the EMI test receiver was set with the following configurations:

<i>Frequency Range</i>	<i>IF B/W</i>
150 kHz – 30 MHz	9 kHz

## Test Equipment List and Details

Manufacturer	Description	Model	Serial Number	Calibration Date	Calibration Due Date
Rohde & Schwarz	EMI Test Receiver	ESCS30	830245/006	2010-03-03	2011-03-02
Rohde & Schwarz	L.I.S.N.	ESH2-Z5	892107/021	2010-03-09	2011-03-08

\* **Statement of Traceability:** Bay Area Compliance Lab Corp. (Shenzhen) attests that all calibrations have been performed in accordance to NVLAP requirements, traceable to the NIST.

## Test Procedure

During the conducted emission test, the host PC was connected to the outlet of the LISN.

Maximizing procedure was performed on the six (6) highest emissions of the EUT.

All data was recorded in the Quasi-peak and average detection mode.

## Test Results Summary

According to the recorded data in following table, the EUT complied with the FCC Part 15.207, with the worst margin reading of:

**11.89 dB at 0.600 MHz** in the **Line** conductor mode

## Test Data

### Environmental Conditions

<b>Temperature:</b>	25 °C
<b>Relative Humidity:</b>	56 %
<b>ATM Pressure:</b>	100.0 kPa

*The testing was performed by Wayne Cheng on 2010-09-13.*

*Test Mode: Transmitting*

**AC 120 V/ 60 Hz, Line:**



Frequency (MHz)	Correction Factor (dB)	Cord. Result (dBµV)	Limit (dBµV)	Margin (dB)	Remark (PK/QP/Ave)
0.600	10.20	34.11	46.00	11.89	Ave.
11.320	10.10	35.19	50.00	14.81	Ave.
3.205	10.20	30.88	46.00	15.12	Ave.
8.015	10.10	34.63	50.00	15.37	Ave.
28.065	10.20	33.88	50.00	16.12	Ave.
0.200	10.10	37.11	54.57	17.46	Ave.
0.600	10.20	34.99	56.00	21.01	QP
8.020	10.10	38.79	60.00	21.21	QP
28.065	10.20	37.68	60.00	22.32	QP
0.200	10.10	41.41	64.57	23.16	QP
11.320	10.10	36.10	60.00	23.90	QP
3.205	10.20	31.36	56.00	24.64	QP

**AC 120 V/ 60 Hz, Neutral:**

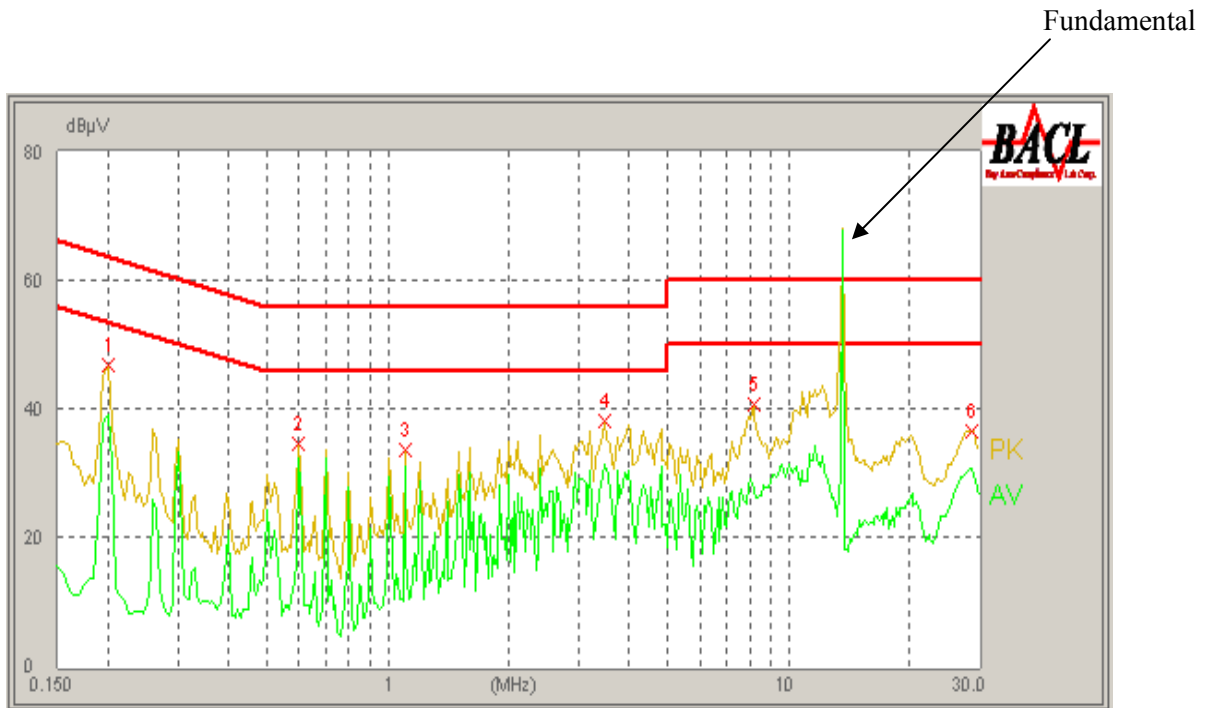

Frequency (MHz)	Correction Factor (dB)	Cord. Result (dBµV)	Limit (dBµV)	Margin (dB)	Remark (PK/QP/Ave.)
0.600	10.20	32.51	46.00	13.49	Ave.
3.475	10.20	31.44	46.00	14.56	Ave.
1.100	10.10	31.16	46.00	14.84	Ave.
0.200	10.10	39.26	54.57	15.31	Ave.
28.565	10.20	31.01	50.00	18.99	Ave.
3.475	10.20	36.70	56.00	19.30	QP
0.200	10.10	44.11	64.57	20.46	QP
8.030	10.10	29.12	50.00	20.88	Ave.
0.600	10.20	33.83	56.00	22.17	QP
8.160	10.10	37.33	60.00	22.67	QP
1.105	10.10	32.25	56.00	23.75	QP
28.560	10.20	33.92	60.00	26.08	QP

## FCC §15.205 & §15.209 - RADIATED EMISSIONS TEST

### Measurement Uncertainty

All measurements involve certain levels of uncertainties, especially in field of EMC. The factors contributing to uncertainties are spectrum analyzer, cable loss, antenna factor calibration, antenna directivity, antenna factor variation with height, antenna phase center variation, antenna factor frequency interpolation, measurement distance variation, site imperfections, mismatch (average), and system repeatability.

Based on NIS 81, The Treatment of Uncertainty in EMC Measurements, the best estimate of the uncertainty of a radiation emissions measurement at Bay Area Compliance Lab Corp. (Shenzhen) is  $\pm 4.0$  dB.

The fundamental data was recorded in average detection mode: set the VBW AVE on, and then record the data.

### EUT Setup

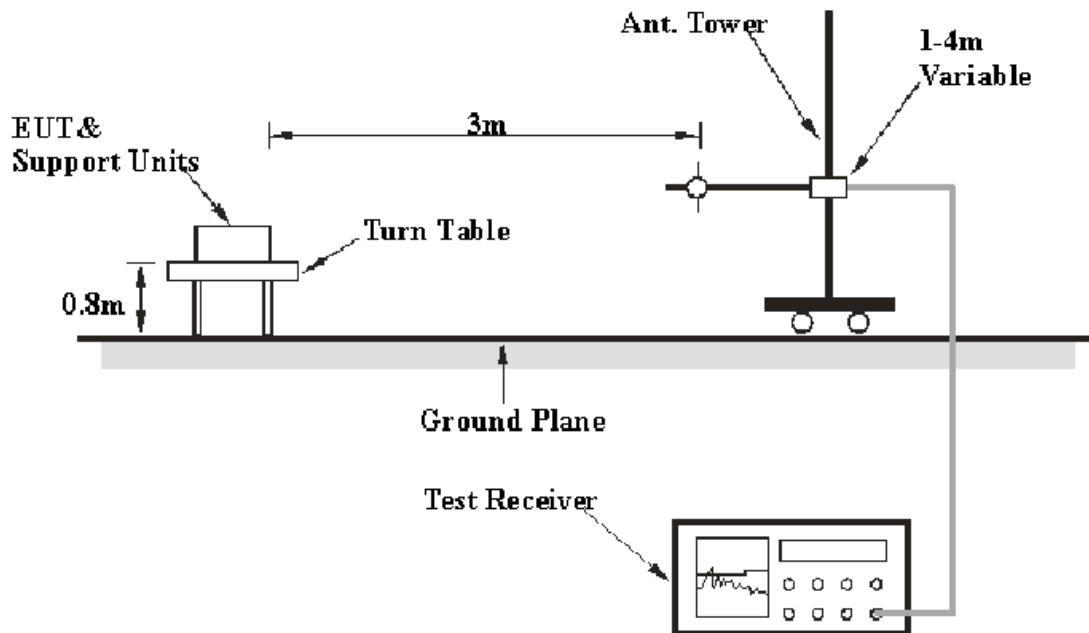

The radiated emission tests were performed in the 3-meter chamber “A” test site, using the setup accordance with the ANSI C63.4-2003. The specification used was the FCC Part Subpart C limits.

The spacing between the peripherals was 10 cm.

The host PC was connected to a 120 VAC/60 Hz power source.

## EMI Test Receiver Setup

According to FCC Rules, 47 CFR 15.33, the EUT emissions were investigated up to 1000 MHz.

During the radiated emission test, the EMI test Receiver was set with the following configurations:

<i>Frequency Range</i>	<i>RBW</i>	<i>Video B/W</i>
30 – 1000 MHz	100 kHz	300 kHz

## Test Equipment List and Details

Manufacturer	Description	Model	Serial Number	Calibration Date	Calibration Due Date
Rohde & Schwarz	EMI Test Receiver	ESCI	100035	2009-11-24	2010-11-23
Sunol Sciences	Broadband Antenna	JB1	A040904-1	2010-03-11	2011-03-10

\* **Statement of Traceability:** Bay Area Compliance Lab Corp. (Shenzhen) attests that all calibrations have been performed per the NVLAP requirements, traceable to NIST.

## Corrected Amplitude & Margin Calculation

The Corrected Amplitude is calculated by adding the Antenna Loss and Cable Loss, and subtracting the Amplifier Gain from the Amplitude reading. The basic equation is as follows:

$$\text{Corrected Amplitude} = \text{Meter Reading} + \text{Antenna Loss} + \text{Cable Loss} - \text{Amplifier Gain}$$

The “**Margin**” column of the following data tables indicates the degree of compliance with the applicable limit. For example, a margin of 7 dB means the emission is 7 dB below the maximum limit. The equation for margin calculation is as follows:

$$\text{Margin} = \text{Limit} - \text{Corrected Amplitude}$$

## Test Results Summary

According to the data in the following table, the EUT complied with the FCC Part 15.209 with the worst margin reading of:

**7.5 dB at 162.606750 MHz in the Horizontal polarization**

## Test Data

### Environmental Conditions

<b>Temperature:</b>	25 °C
<b>Relative Humidity:</b>	56 %
<b>ATM Pressure:</b>	100.9 kPa

*The testing was performed by Wayne Cheng on 2010-09-10.*



Test mode: Transmitting

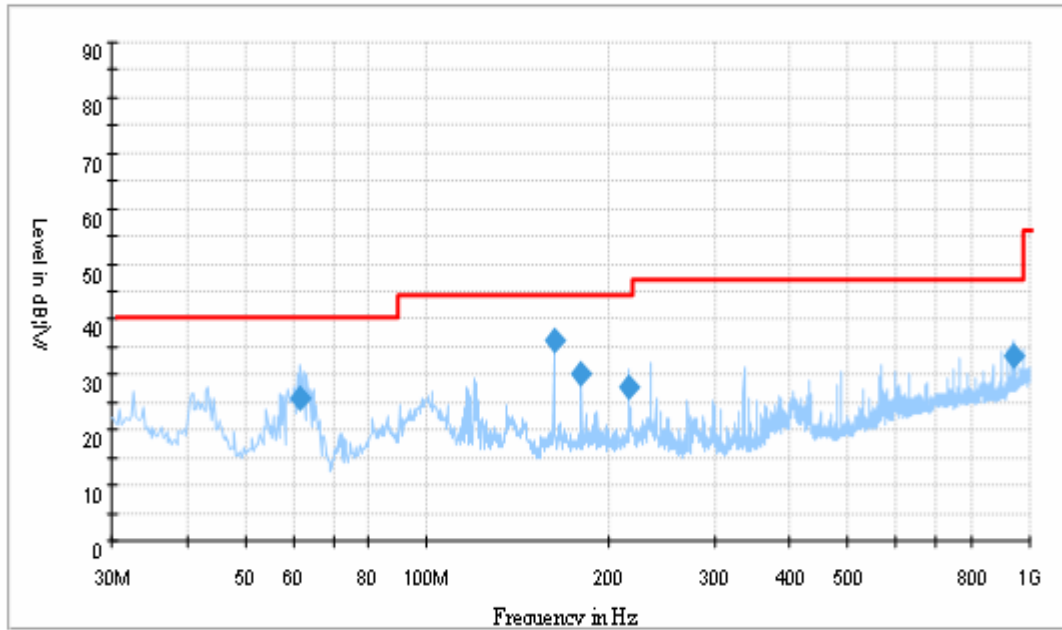

Frequency (MHz)	Corrected Amplitude (dBµV)	Test Antenna		Turntable Position (deg)	Correction Factor (dB)	Limit (dBµV/m)	Margin (dB)
		Height (cm)	Polarity (H/V)				
162.606750	36.0	204.0	H	0.0	-14.5	43.5	7.5
937.088500	33.4	126.0	H	0.0	0.3	46.0	12.6
180.624750	30.0	170.0	H	0.0	-15.3	43.5	13.5
61.832500	25.9	362.0	H	248.0	-18.6	40.0	14.1
216.808000	27.6	129.0	H	132.0	-14.1	43.5	15.9

Note: The data which below 20 dB to the limit was not recorded.

## FCC §15.225(a)(b)(c) – FIELD STRENGTH OF RADIATED EMISSIONS

### Applicable Standard

As per FCC Part 15.225

(a) The field strength of any emissions within the band 13.553-13.567 MHz shall not exceed 15,848 microvolts/meter at 30 meters.

(b) Within the bands 13.410-13.553 MHz and 13.567-13.710 MHz, the field strength of any emissions shall not exceed 334 microvolts/meter at 30 meters.

(c) Within the bands 13.110-13.410 MHz and 13.710-14.010 MHz the field strength of any emissions shall not exceed 106 microvolts/meter at 30 meters.

### Test Equipment List and Details

Manufacturer	Description	Model	Serial Number	Calibration Date	Calibration Due Date
HP	Amplifier	8447E	1937A01046	2010-08-02	2011-08-01
Rohde & Schwarz	EMI Test Receiver	ESCI	100035	2009-11-24	2010-11-23
ETS	Passive Loop Antenna	6512	00029604	2010-04-27	2011-04-26

\* **Statement of Traceability:** Bay Area Compliance Lab Corp. (Shenzhen) attests that all calibrations have been performed per the NVLAP requirements, traceable to NIST.

### EUT Setup

The field strength of radiated emissions tests were performed in the 3-meter chamber “A” test site, using the setup accordance with the ANSI C63.4-2003. The specification used was the FCC Part Subpart C limits.

### Test Data

#### Environmental Conditions

<b>Temperature:</b>	25 °C
<b>Relative Humidity:</b>	56 %
<b>ATM Pressure:</b>	100.9 kPa

*The testing was performed by Wayne Cheng on 2010-09-11.*

*Test Mode: Transmitting*

Test Result: Pass

Indicated			Table Angle Degree	Antenna Height (m)	Detector PK/QP/Ave	Correction Factor			Cord. Amp. (dBµV/m) @3m	FCC Part 15.225	
Frequency Range (MHz)	Mark point (MHz)	Maximum Reading (dBµV) @3m				Ant. Factor (dB)	Cable Loss (dB)	Pre-Amp. Gain (dB)		Limit (dBµV/m) @3m	Result
13.110-13.410	13.350	1.00	183	1.26	QP	32.1	0.20	0.0	33.30	80.5	Pass
13.410-13.553	13.553	7.5	177	1.38	QP	32.1	0.20	0.0	39.80	90.5	Pass
13.553-13.567	13.561	27.1	180	1.30	QP	32.1	0.20	0.0	59.40	124	Pass
13.567-13.710	13.567	17.4	184	1.33	QP	32.1	0.20	0.0	49.70	90.5	Pass
13.710-14.010	13.7712	-1	178	1.36	QP	32.1	0.20	0.0	31.30	80.5	Pass



Att 10 dB RBW 9 kHz  
MT 10 ms  
PREAMP OFF

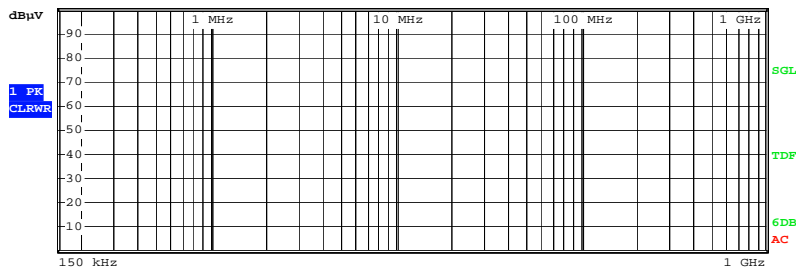
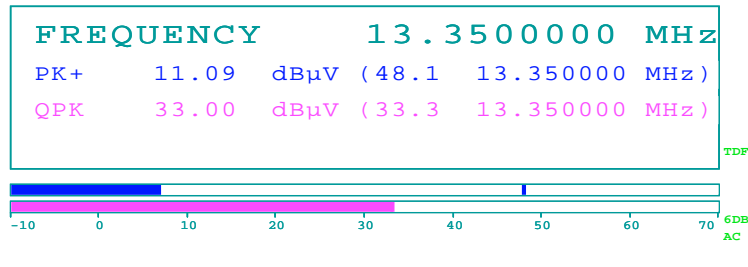



Att 10 dB

RBW 9 kHz  
MT 10 ms  
PREAMP OFF

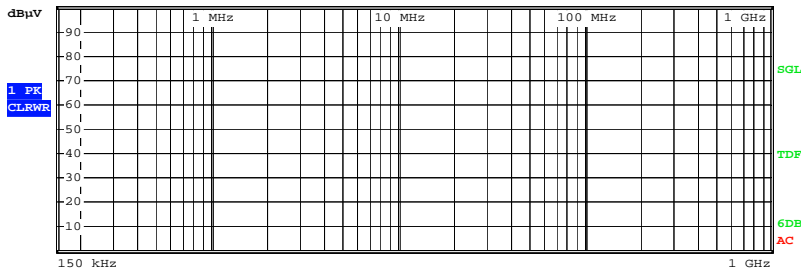
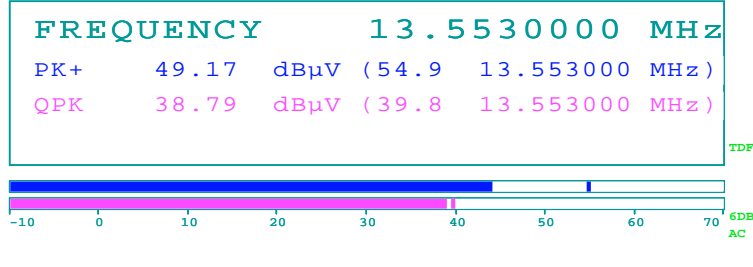

Att 10 dB

RBW 9 kHz  
MT 10 ms  
PREAMP OFF

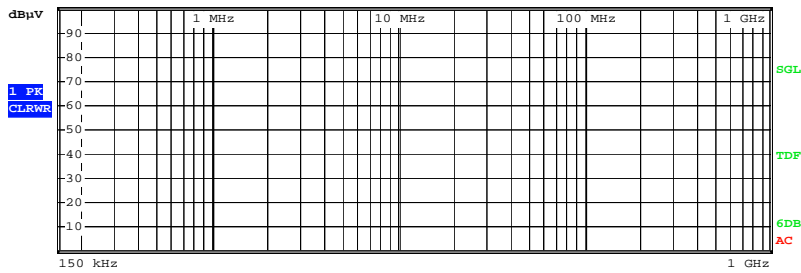
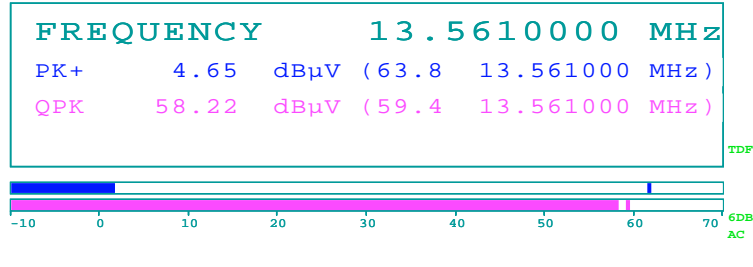



Att 10 dB

RBW 9 kHz  
MT 10 ms  
PREAMP OFF

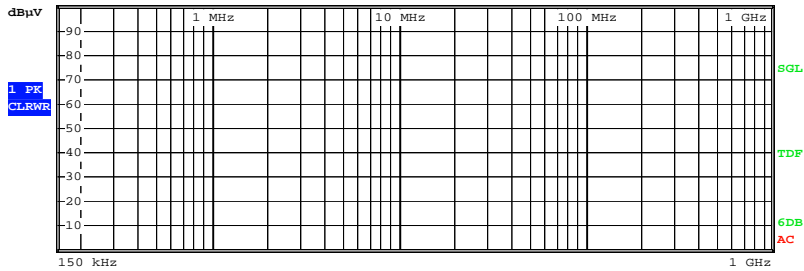
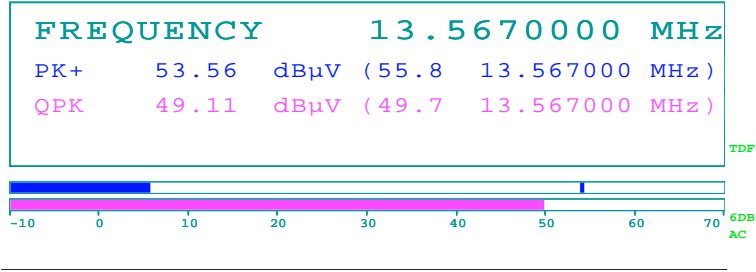

Att 10 dB

RBW 9 kHz  
MT 10 ms  
PREAMP OFF

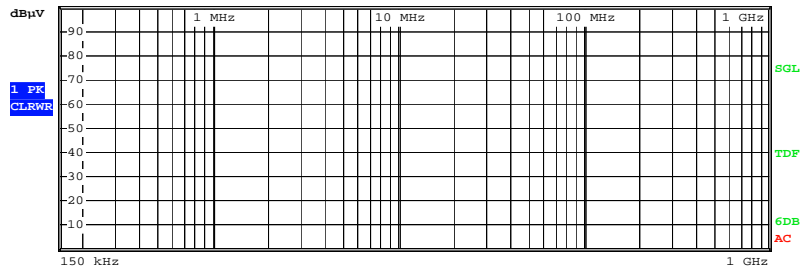
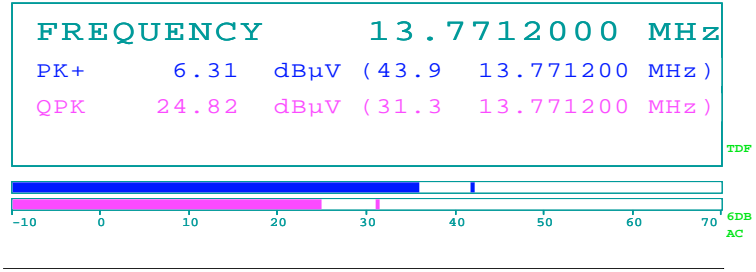

## FCC §15.225(d) & §15.209 - OUT OF BAND EMISSION

### Applicable Standard

As per FCC §15.225(d) §15.31(f) The field strength of any emissions appearing outside of the 13.110–14.010 MHz band shall not exceed the general radiated emission limits in §15.209.

### Test Equipment List and Details

Manufacturer	Description	Model	Serial Number	Calibration Date	Calibration Due Date
HP	Amplifier	8447E	1937A01046	2010-08-02	2011-08-01
Rohde & Schwarz	EMI Test Receiver	ESCI	100035	2009-11-24	2010-11-23
ETS	Passive Loop Antenna	6512	00029604	2010-04-27	2011-04-26

\* **Statement of Traceability:** Bay Area Compliance Lab Corp. (Shenzhen) attests that all calibrations have been performed per the NVLAP requirements, traceable to NIST.

### EUT Setup

The out of band emission tests were performed in the 3-meter chamber “A” test site, using the setup accordance with the ANSI C63.4-2003. The specification used was the FCC Part Subpart C limits.

### Test Data

#### Environmental Conditions

<b>Temperature:</b>	25 °C
<b>Relative Humidity:</b>	56 %
<b>ATM Pressure:</b>	100.9 kPa

*The testing was performed by Wayne Cheng on 2010-09-11.*

*Test Mode: Transmitting*

Indicated		Table Angle Degree	Antenna Height (m)	Detector PK/QP/Ave	Correction Factor			Corrected Amplitude (dB $\mu$ V/m) @3m	FCC Part 15.225	
Frequency (MHz)	Maximum Reading (dB $\mu$ V) @3m				Ant. Factor (dB)	Cable Loss (dB)	Pre-Amp. Gain (dB)		Limit (dB $\mu$ V/m) @3m	Result
0.009000	-6.16	172	1.45	PK	87.8	0.05	0.0	82.14	128.52	Pass
0.435120	16.7	188	1.54	PK	63.5	0.06	0.0	80.26	94.8	Pass
19.98802	7.4	185	1.60	PK	31.7	0.20	0.0	39.33	69.5	Pass
20.36000	28.04	182	1.64	PK	31.2	0.27	0.0	59.51	69.5	Pass

Test Result: Pass

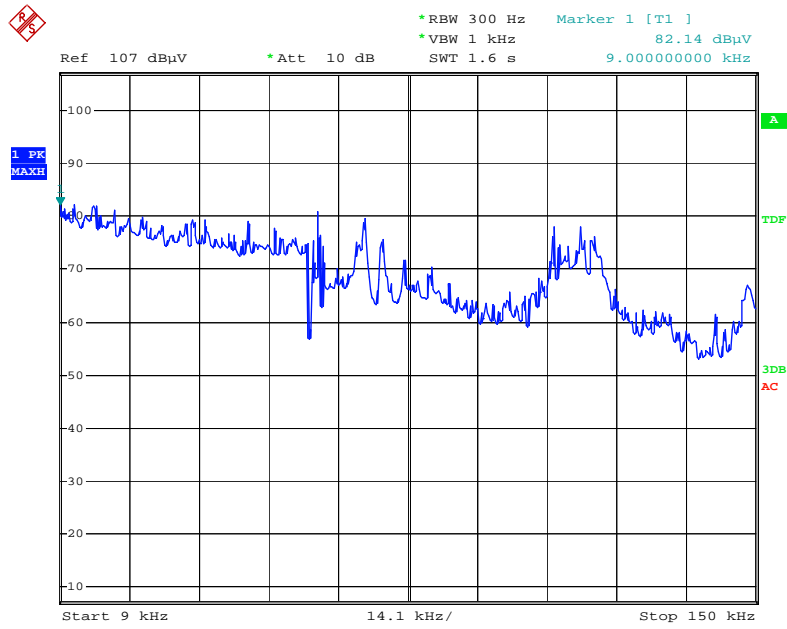

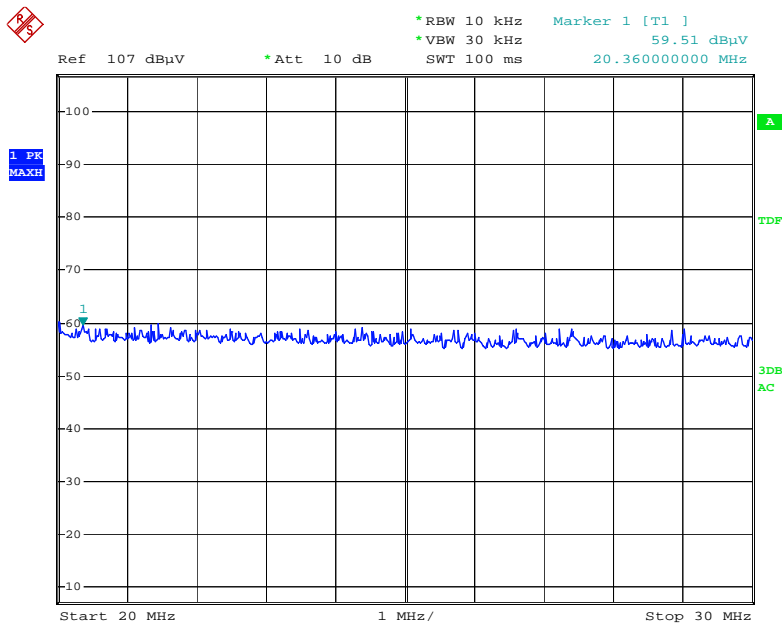
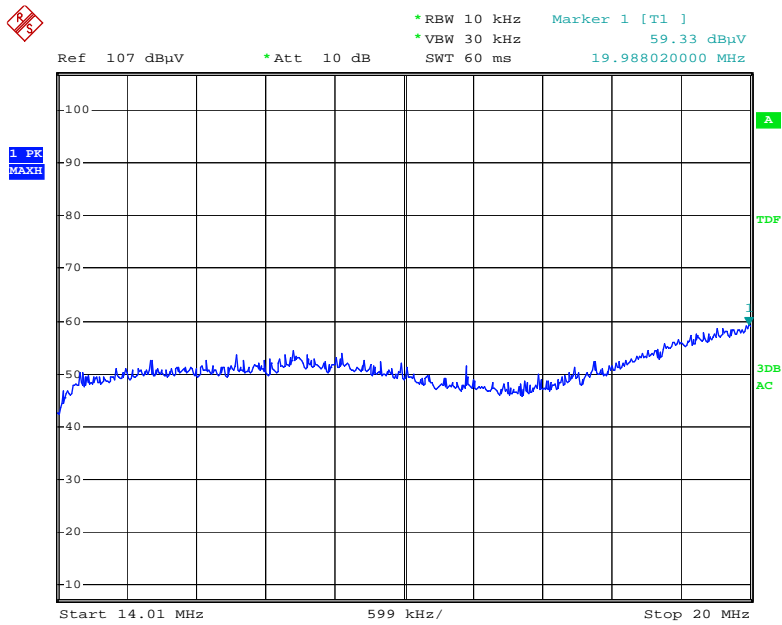



## FCC §15.225(e) - FREQUENCY STABILITY

### Applicable Standard

The frequency tolerance of the carrier signal shall be maintained within  $\pm 0.01\%$  of the operating frequency over a temperature variation of  $-20$  degrees to  $+50$  degrees C at normal supply voltage, and for a variation in the primary supply voltage from 85% to 115% of the rated supply voltage at a temperature of 20 degrees C. For battery operated equipment, the equipment tests shall be performed using a new battery.

### Test Equipment List and Details

Manufacturer	Description	Model	Serial Number	Calibration Date	Calibration Due Date
Rohde & Schwarz	EMI Test Receiver	ESCI	100035	2009-11-24	2010-11-23
WUHUAN	Temperature & Humidity Chamber	HTP205	20021115	2010-06-04	2011-06-03

\* **Statement of Traceability:** Bay Area Compliance Lab Corp. (Shenzhen) attests that all calibrations have been performed in accordance to NVLAP requirements, traceable to the NIST.

### Test Procedure

Frequency Stability vs. Temperature: The equipment under test was connected to PC, than to an external AC power supply and loop antenna was connected to an f Spectrum Analyzer. The EUT was placed inside the temperature chamber.

After the temperature stabilized for approximately 20 minutes, the frequency output was recorded from the Spectrum Analyzer.

Frequency Stability vs. Voltage: An external variable AC power supply Source. The voltage was set to 115% of the nominal value and was then decreased until the transmitter light no longer illuminated; i.e., the end point. The output frequency was recorded for each voltage.

### Test Data

#### Environmental Conditions

Temperature:	20 °C
Relative Humidity:	56 %
ATM Pressure:	100.9 kPa

*The testing was performed by Wayne Cheng on 2010-09-11.*

Test Result: Pass

*Test Mode: Transmitting*

Power Supply	Temperature (°C)	Measured Frequency (MHz)	Frequency Error	Part 15.225 Limit
AC 120 V	0	13.56065	0.004794%	±0.01%
	10	13.56086	0.0063425	±0.01%
	20	13.56076	0.005605%	±0.01%
	25	13.56085	0.006268%	±0.01%
	30	13.56086	0.006342%	±0.01%
	40	13.56096	0.00708%	±0.01%
	50	13.56085	0.006268%	±0.01%
Max. = AC 138 V	25	13.56106	0.007817%	±0.01%
Min. = AC 102 V	25	13.56112	0.008265%	±0.01%

## FCC §15.215(c) – 20 dB BANDWIDTH TESTING

### Requirement

Per FCC §15.215(c) Intentional radiators operating under the alternative provisions to the general emission limits, as contained in §§ 15.217 through 15.257 and in Subpart E of this part, must be designed to ensure that the 20 dB bandwidth of the emission, or whatever bandwidth may otherwise be specified in the specific rule section under which the equipment operates, is contained within the frequency band designated in the rule section under which the equipment is operated. The requirement to contain the designated bandwidth of the emission within the specified frequency band includes the effects from frequency sweeping, frequency hopping and other modulation techniques that may be employed as well as the frequency stability of the transmitter over expected variations in temperature and supply voltage. If frequency stability is not specified in the regulations, it is recommended that the fundamental emission be kept within at least the central 80% of the permitted band in order to minimize the possibility of out-of-band operation.

### Test Equipment List and Details

Manufacturer	Description	Model	Serial Number	Calibration Date	Calibration Due Date
HP	Amplifier	8447E	1937A01046	2010-08-02	2011-08-01
Rohde & Schwarz	EMI Test Receiver	ESCI	100035	2009-11-24	2010-11-23
ETS	Passive Loop Antenna	6512	00029604	2010-04-27	2011-04-26

\* **Statement of Traceability:** Bay Area Compliance Laboratories Corp. (Shenzhen) attests that all calibrations have been performed per the NVLAP requirements, traceable to NIST.

### Test Procedure

1. Check the calibration of the measuring instrument using either an internal calibrator or a known signal from an external generator.
2. Position the EUT without connection to measurement instrument. Turn on the EUT and connect it to measurement instrument. Then set it to any one convenient frequency within its operating range. Set a reference level on the measuring instrument equal to the highest peak value.
3. Measure the frequency difference of two frequencies that were attenuated 20 dB from the reference level. Record the frequency difference as the emission bandwidth.

### Test Data

#### Environmental Conditions

Temperature:	25 °C
Relative Humidity:	56 %
ATM Pressure:	100.9 kPa

*The testing was performed by Wayne Cheng on 2010-09-11.*

*Test Mode: Transmitting*

### 20 dB Bandwidth

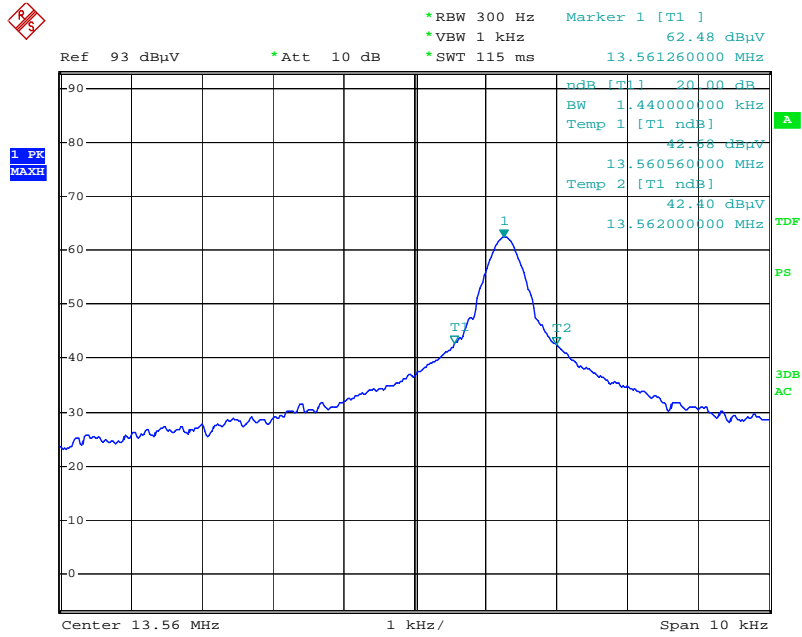

\*\*\*\*\* END OF REPORT \*\*\*\*\*