

SAR Plots

- Verification Plots
- SAR Test Plots

DT&C Co., Ltd.

DUT: Dipole 2450 MHz; Type: D2450V2; Serial: D2450V2 - SN:726

Communication System: CW (0); Frequency: 2450 MHz; Duty Cycle: 1:1
Medium parameters used: $f = 2450$ MHz; $\sigma = 1.84$ S/m; $\epsilon_r = 38.05$; $\rho = 1000$ kg/m³
Phantom section: Flat Section

DASY5 Configuration:

Probe: EX3DV4 - SN3930; ConvF(7.56, 7.56, 7.56); Calibrated: 2014-07-22; Electronics: DAE4 Sn1394
Phantom: SAM with CRP_20120521; Type: SAM; Serial: 1679
Measurement SW: DASY52, Version 52.8 (7); SEMCAD X Version 14.6.10 (7164)

Test Date: 2014-10-03; Ambient Temp: 20.4; Tissue Temp: 21.0

2450 MHz System Verification

Area Scan (61x91x1): Interpolated grid: dx=12mm, dy=12mm

Zoom Scan (7x7x7)/Cube 0: Measurement grid: dx=5mm, dy=5mm, dz=5mm

Power Drift = 0.02 dB

Peak SAR (extrapolated) = 22.5 W/kg

SAR(1 g) = 12.2 W/kg; SAR(10 g) = 6.4 W/kg

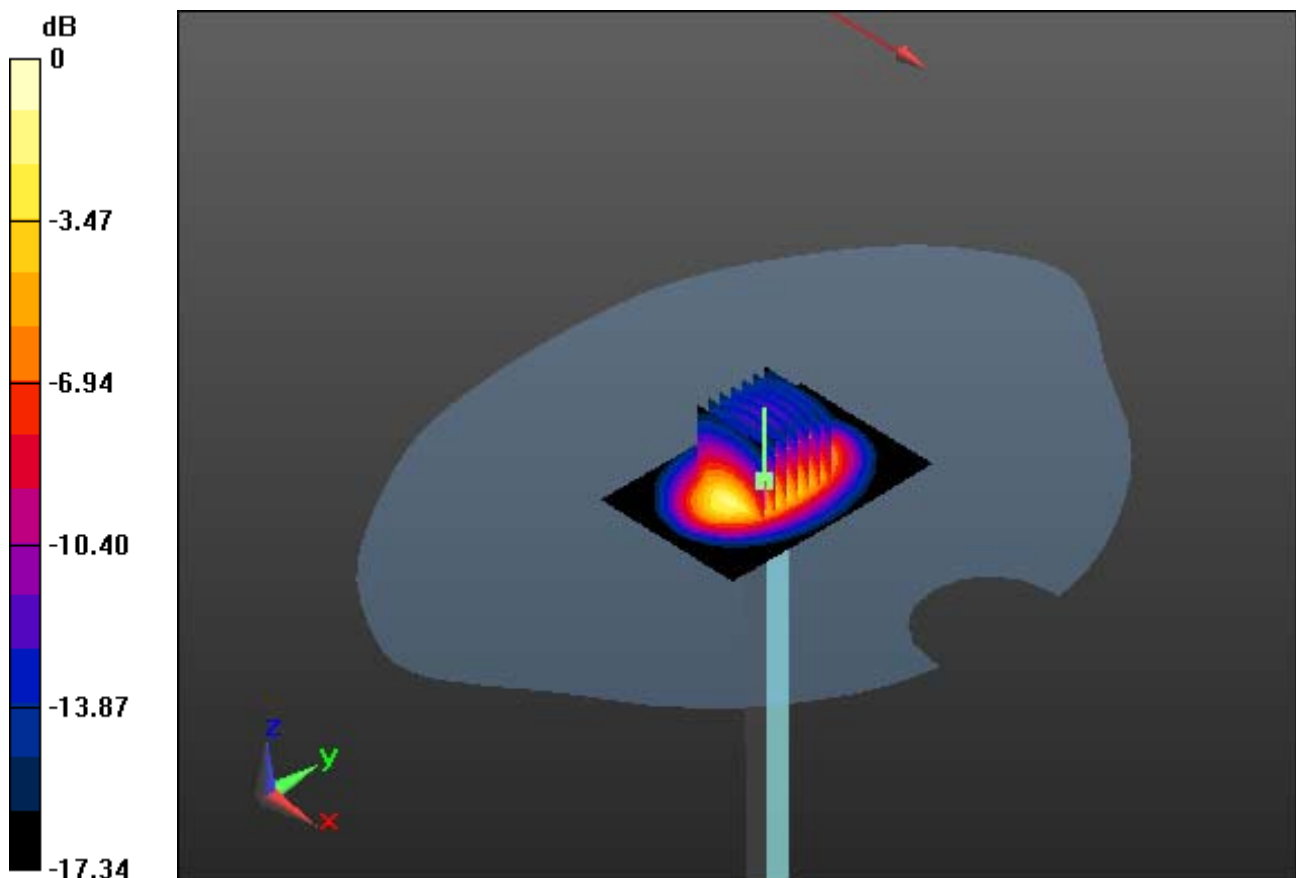

0 dB = 16.6 W/kg

DT&C Co., Ltd.

DUT: Dipole 2450 MHz; Type: D2450V2; Serial: D2450V2 - SN:726

Communication System: CW (0); Frequency: 2450 MHz; Duty Cycle: 1:1
Medium parameters used: $f = 2450$ MHz; $\sigma = 1.84$ S/m; $\epsilon_r = 38.05$; $\rho = 1000$ kg/m³
Phantom section: Flat Section

DASY5 Configuration:

Probe: EX3DV4 - SN3930; ConvF(7.56, 7.56, 7.56); Calibrated: 2014-07-22; Electronics: DAE4 Sn1394
Phantom: SAM with CRP_20120521; Type: SAM; Serial: 1679
Measurement SW: DASY52, Version 52.8 (7); SEMCAD X Version 14.6.10 (7164)

Test Date: 2014-10-03; Ambient Temp: 20.4; Tissue Temp: 21.0

2450 MHz System Verification

Area Scan (61x91x1): Interpolated grid: dx=12mm, dy=12mm

Zoom Scan (7x7x7)/Cube 0: Measurement grid: dx=5mm, dy=5mm, dz=5mm

Power Drift = 0.02 dB

Peak SAR (extrapolated) = 22.5 W/kg

SAR(1 g) = 12.2 W/kg; SAR(10 g) = 6.4 W/kg

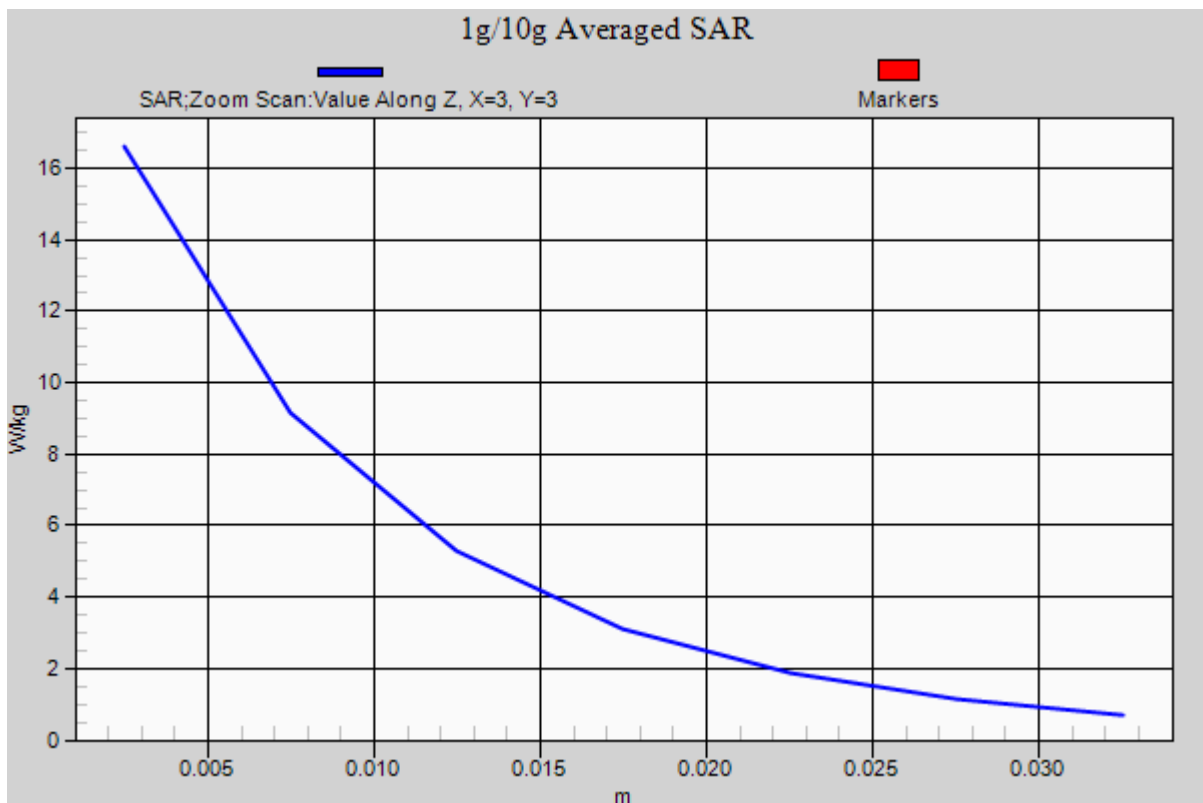

DT&C Co., Ltd.

DUT: Dipole 2450 MHz; Type: D2450V2; Serial: D2450V2 - SN:726

Communication System: CW (0); Frequency: 2450 MHz; Duty Cycle: 1:1
Medium parameters used: $f = 2450$ MHz; $\sigma = 1.991$ S/m; $\epsilon_r = 51.349$; $\rho = 1000$ kg/m³
Phantom section: Flat Section

DASY5 Configuration:

Probe: EX3DV4 - SN3930; ConvF(7.12, 7.12, 7.12); Calibrated: 2014-07-22; Electronics: DAE4 Sn1394
Phantom: ELI v5.0; Type: QDOVA002AA; Serial: 1166
Measurement SW: DASY52, Version 52.8 (7); SEMCAD X Version 14.6.10 (7164)

Test Date: 2014-10-03; Ambient Temp: 20.4; Tissue Temp: 21.0

2450 MHz System Verification

Area Scan (61x81x1): Interpolated grid: dx=12mm, dy=12mm

Zoom Scan (7x7x7)/Cube 0: Measurement grid: dx=5mm, dy=5mm, dz=5mm
Power Drift = 0.04 dB

Peak SAR (extrapolated) = 29.8 W/kg

SAR(1 g) = 12.6 W/kg; SAR(10 g) = 5.53 W/kg

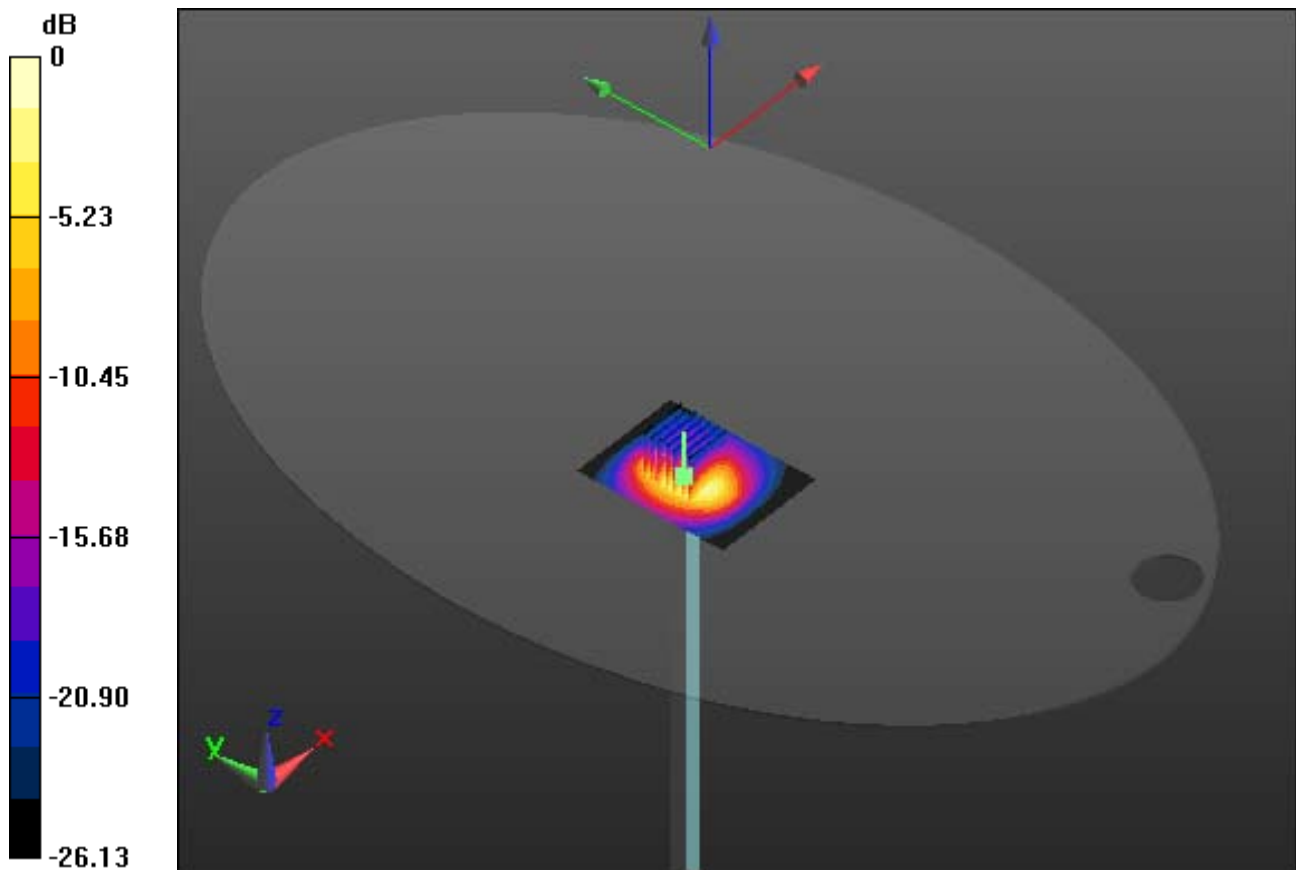

0 dB = 18.6 W/kg

DT&C Co., Ltd.

DUT: Dipole 2450 MHz; Type: D2450V2; Serial: D2450V2 - SN:726

Communication System: CW (0); Frequency: 2450 MHz; Duty Cycle: 1:1
Medium parameters used: $f = 2450$ MHz; $\sigma = 1.991$ S/m; $\epsilon_r = 51.349$; $\rho = 1000$ kg/m³
Phantom section: Flat Section

DASY5 Configuration:

Probe: EX3DV4 - SN3930; ConvF(7.12, 7.12, 7.12); Calibrated: 2014-07-22; Electronics: DAE4 Sn1394
Phantom: ELI v5.0; Type: QDOVA002AA; Serial: 1166
Measurement SW: DASY52, Version 52.8 (7); SEMCAD X Version 14.6.10 (7164)

Test Date: 2014-10-03; Ambient Temp: 20.4; Tissue Temp: 21.0

2450 MHz System Verification

Area Scan (61x81x1): Interpolated grid: dx=12mm, dy=12mm

Zoom Scan (7x7x7)/Cube 0: Measurement grid: dx=5mm, dy=5mm, dz=5mm

Power Drift = 0.04 dB

Peak SAR (extrapolated) = 29.8 W/kg

SAR(1 g) = 12.6 W/kg; SAR(10 g) = 5.53 W/kg

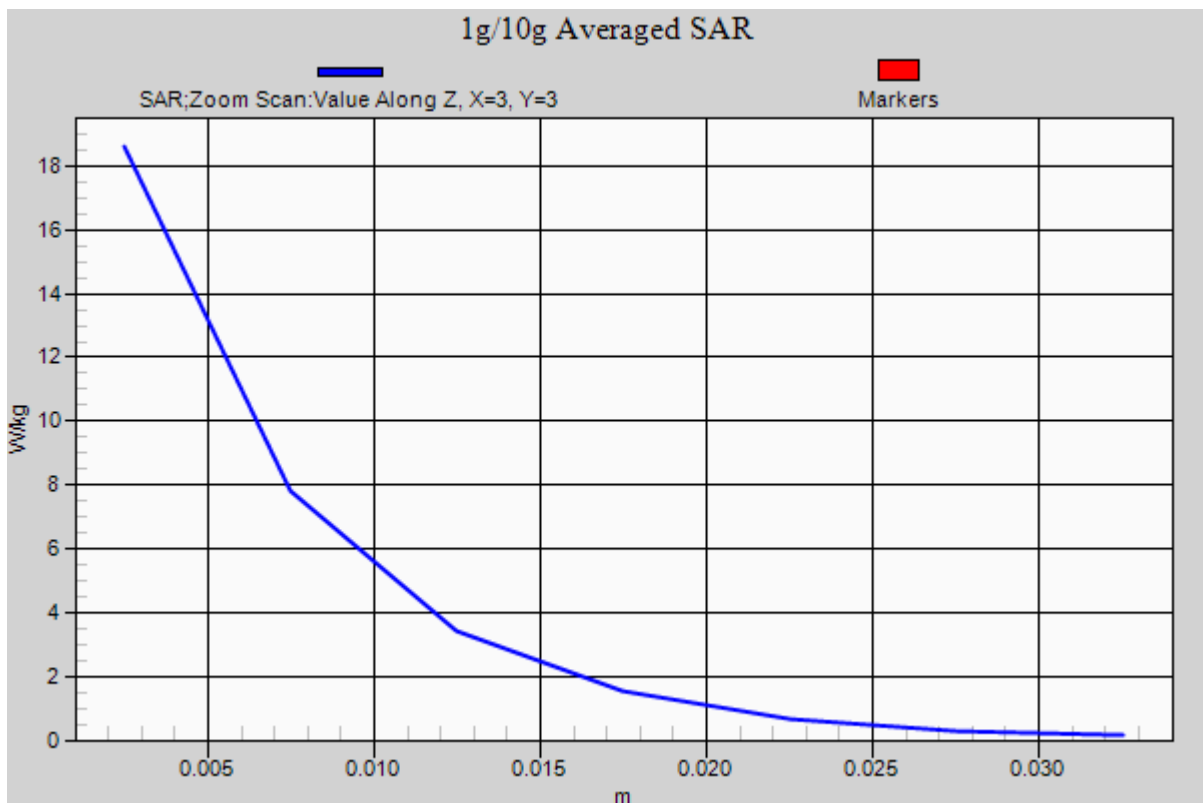

DT&C Co., Ltd.

DUT: Dipole 5000 MHz; Type: D5GHzV2; Serial: D5GHzV2 - SN:1103

Communication System: CW; Frequency: 5200 MHz; Duty Cycle: 1:1

Medium parameters used: $f = 5200$ MHz; $\sigma = 4.563$ S/m; $\epsilon_r = 34.759$; $\rho = 1000$ kg/m³

Phantom section: Flat Section

DASY5 Configuration:

Probe: EX3DV4 - SN3930; ConvF(5.14, 5.14, 5.14); Calibrated: 2014-07-22; Electronics: DAE4 Sn1394

Phantom: SAM with CRP_20120521; Type: SAM; Serial: 1679

Measurement SW: DASY52, Version 52.8 (7); SEMCAD X Version 14.6.10 (7164)

Test Date: 2014-10-07; Ambient Temp: 20.5; Tissue Temp: 20.8

5200 MHz System Verification

Area Scan (61x91x1): Interpolated grid: dx=10mm, dy=10mm

Zoom Scan (7x7x11)/Cube 0: Measurement grid: dx=4mm, dy=4mm, dz=2mm

Power Drift = 0.10 dB

Peak SAR (extrapolated) = 31.4 W/kg

SAR(1 g) = 7.47 W/kg; SAR(10 g) = 2.14 W/kg

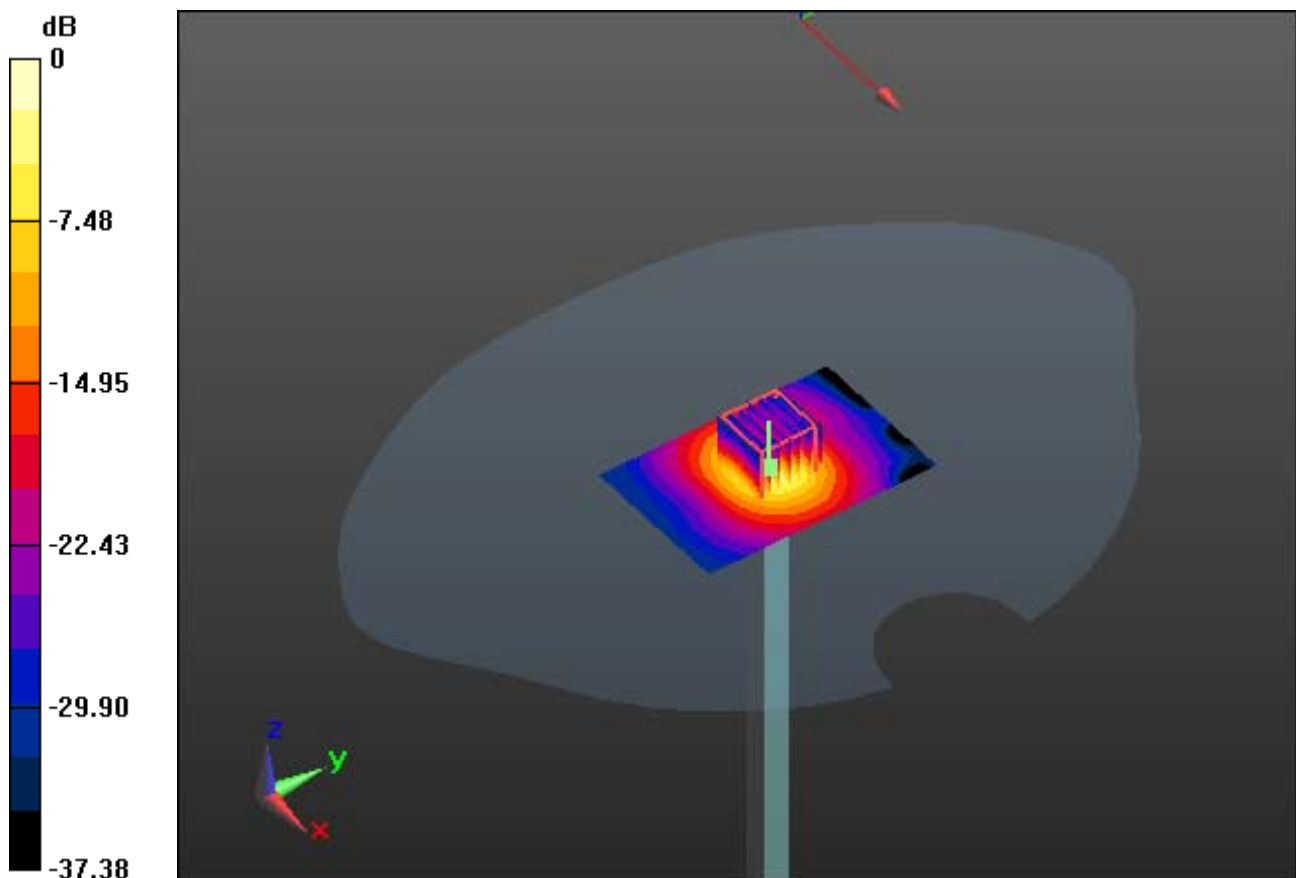

0 dB = 15.5 W/kg

DT&C Co., Ltd.

DUT: Dipole 5000 MHz; Type: D5GHzV2; Serial: D5GHzV2 - SN:1103

Communication System: CW; Frequency: 5200 MHz; Duty Cycle: 1:1

Medium parameters used: $f = 5200$ MHz; $\sigma = 4.563$ S/m; $\epsilon_r = 34.759$; $\rho = 1000$ kg/m³

Phantom section: Flat Section

DASY5 Configuration:

Probe: EX3DV4 - SN3930; ConvF(5.14, 5.14, 5.14); Calibrated: 2014-07-22; Electronics: DAE4 Sn1394

Phantom: SAM with CRP_20120521; Type: SAM; Serial: 1679

Measurement SW: DASY52, Version 52.8 (7); SEMCAD X Version 14.6.10 (7164)

Test Date: 2014-10-07; Ambient Temp: 20.5; Tissue Temp: 20.8

5200 MHz System Verification

Area Scan (61x91x1): Interpolated grid: dx=10mm, dy=10mm

Zoom Scan (7x7x11)/Cube 0: Measurement grid: dx=4mm, dy=4mm, dz=2mm

Power Drift = 0.10 dB

Peak SAR (extrapolated) = 31.4 W/kg

SAR(1 g) = 7.47 W/kg; SAR(10 g) = 2.14 W/kg

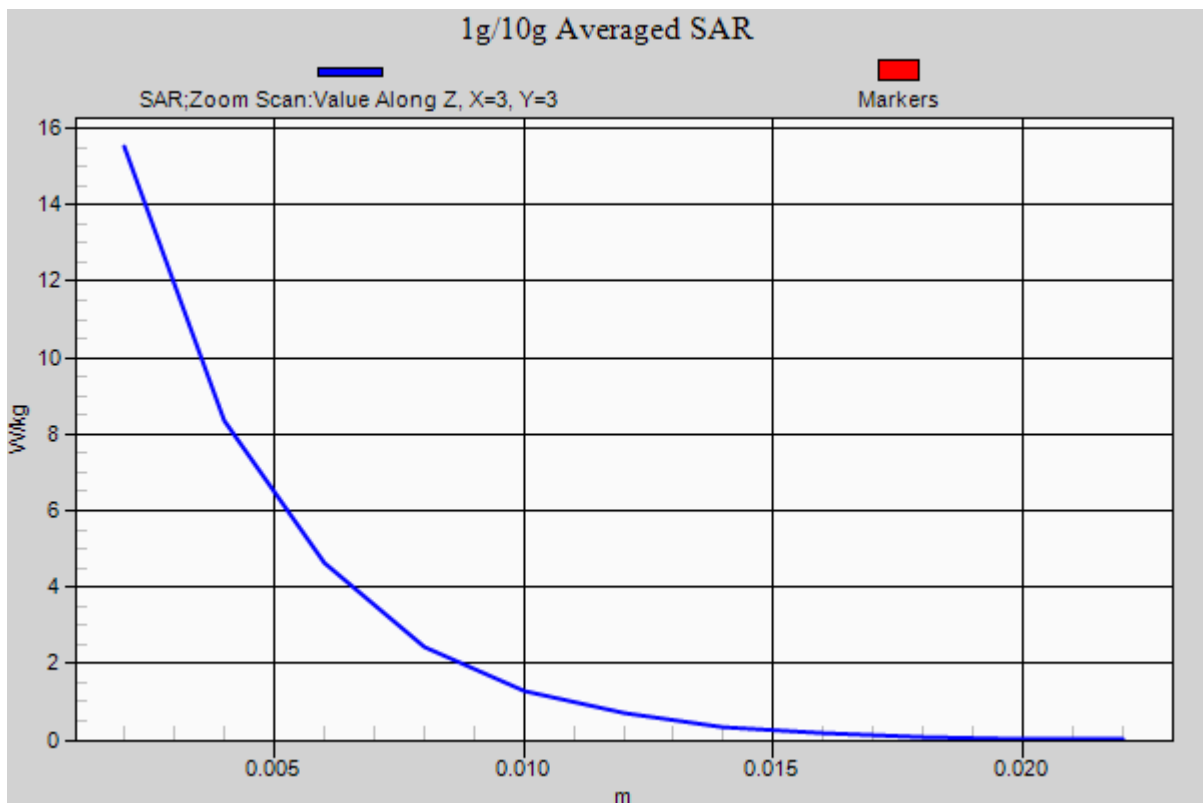

DT&C Co., Ltd.

DUT: Dipole 5000 MHz; Type: D5GHzV2; Serial: D5GHzV2 - SN:1103

Communication System: CW (0); Frequency: 5200 MHz; Duty Cycle: 1:1
Medium parameters used: $f = 5200$ MHz; $\sigma = 5.242$ S/m; $\epsilon_r = 47.891$; $\rho = 1000$ kg/m³
Phantom section: Flat Section

DASY5 Configuration:

Probe: EX3DV4 - SN3930; ConvF(4.67, 4.67, 4.67); Calibrated: 2014-07-22; Electronics: DAE4 Sn1394
Phantom: ELI v5.0; Type: QDOVA002AA; Serial: 1166
Measurement SW: DASY52, Version 52.8 (7); SEMCAD X Version 14.6.10 (7164)

Test Date: 2014-10-02; Ambient Temp: 20.1; Tissue Temp: 20.5

5200 MHz System Verification

Area Scan (61x91x1): Interpolated grid: dx=10mm, dy=10mm

Zoom Scan (7x7x11)/Cube 0: Measurement grid: dx=4mm, dy=4mm, dz=2mm

Power Drift = 0.08 dB

Peak SAR (extrapolated) = 32.4 W/kg

SAR(1 g) = 7.09 W/kg; SAR(10 g) = 1.97 W/kg

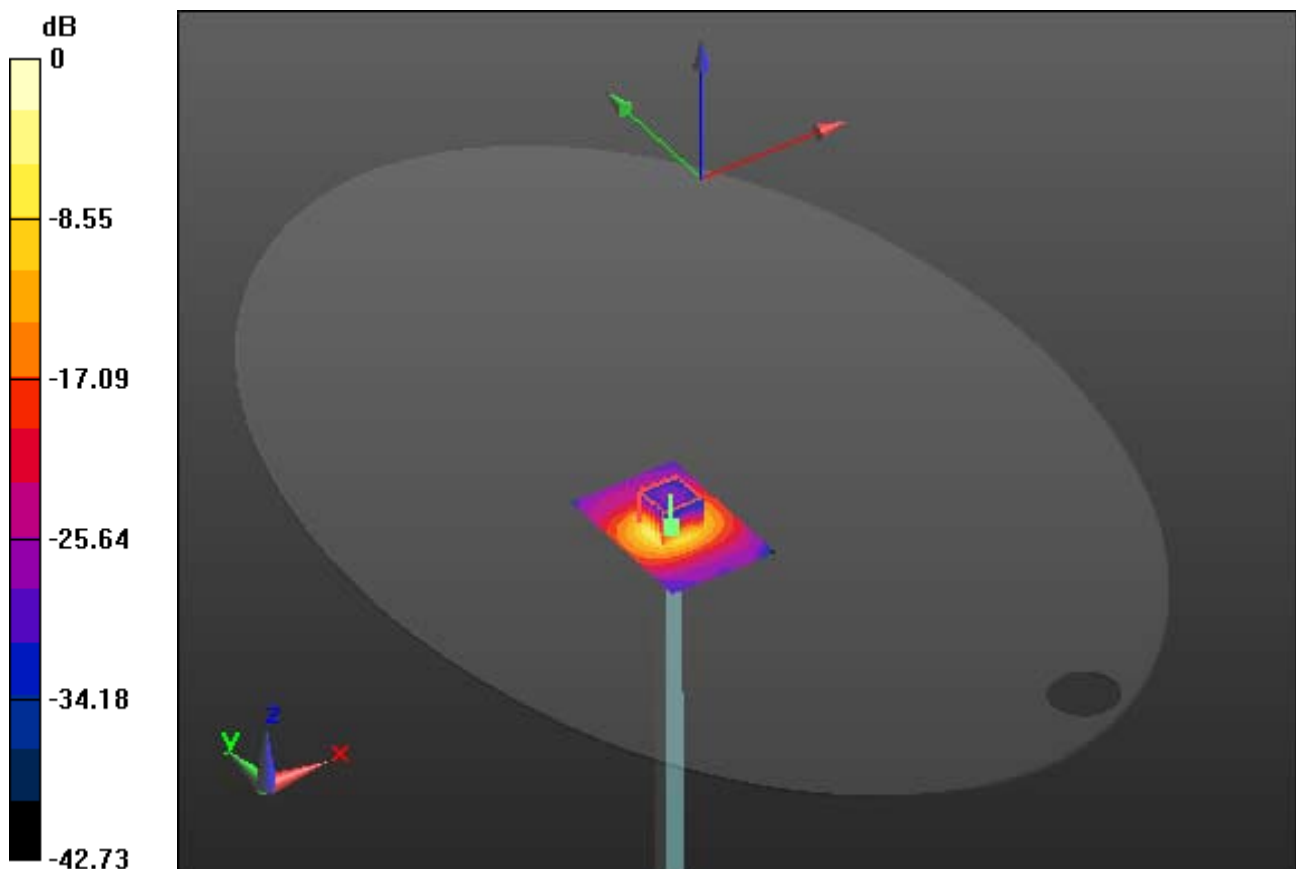

0 dB = 15.1 W/kg

DT&C Co., Ltd.

DUT: Dipole 5000 MHz; Type: D5GHzV2; Serial: D5GHzV2 - SN:1103

Communication System: CW (0); Frequency: 5200 MHz; Duty Cycle: 1:1
Medium parameters used: $f = 5200$ MHz; $\sigma = 5.242$ S/m; $\epsilon_r = 47.891$; $\rho = 1000$ kg/m³
Phantom section: Flat Section

DASY5 Configuration:

Probe: EX3DV4 - SN3930; ConvF(4.67, 4.67, 4.67); Calibrated: 2014-07-22; Electronics: DAE4 Sn1394
Phantom: ELI v5.0; Type: QDOVA002AA; Serial: 1166
Measurement SW: DASY52, Version 52.8 (7); SEMCAD X Version 14.6.10 (7164)

Test Date: 2014-10-02; Ambient Temp: 20.1; Tissue Temp: 20.5

5200 MHz System Verification

Area Scan (61x91x1): Interpolated grid: dx=10mm, dy=10mm

Zoom Scan (7x7x11)/Cube 0: Measurement grid: dx=4mm, dy=4mm, dz=2mm

Power Drift = 0.08 dB

Peak SAR (extrapolated) = 32.4 W/kg

SAR(1 g) = 7.09 W/kg; SAR(10 g) = 1.97 W/kg

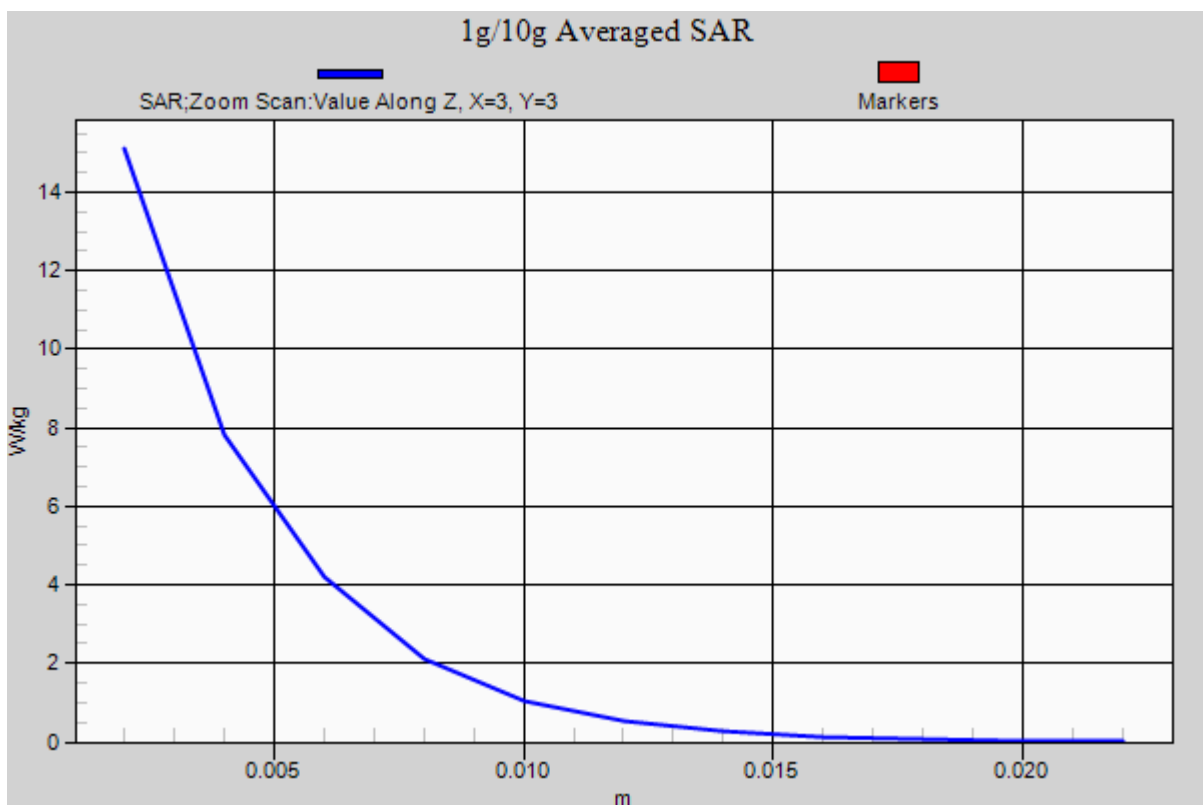

DT&C Co., Ltd.

DUT: Dipole 5000 MHz; Type: D5GHzV2; Serial: D5GHzV2 - SN:1103

Communication System: CW (0); Frequency: 5300 MHz; Duty Cycle: 1:1
Medium parameters used: $f = 5300$ MHz; $\sigma = 4.67$ S/m; $\epsilon_r = 34.589$; $\rho = 1000$ kg/m³
Phantom section: Flat Section

DASY5 Configuration:

Probe: EX3DV4 - SN3930; ConvF(4.81, 4.81, 4.81); Calibrated: 2014-07-22; Electronics: DAE4 Sn1394
Phantom: SAM with CRP_20120521; Type: SAM; Serial: 1679
Measurement SW: DASY52, Version 52.8 (7); SEMCAD X Version 14.6.10 (7164)

Test Date: 2014-10-07; Ambient Temp: 20.5; Tissue Temp: 20.8

5300 MHz System Verification

Area Scan (61x91x1): Interpolated grid: dx=10mm, dy=10mm
Zoom Scan (7x7x11)/Cube 0: Measurement grid: dx=4mm, dy=4mm, dz=2mm
Power Drift = 0.12 dB
Peak SAR (extrapolated) = 36.2 W/kg
SAR(1 g) = 9.04 W/kg; SAR(10 g) = 2.61 W/kg

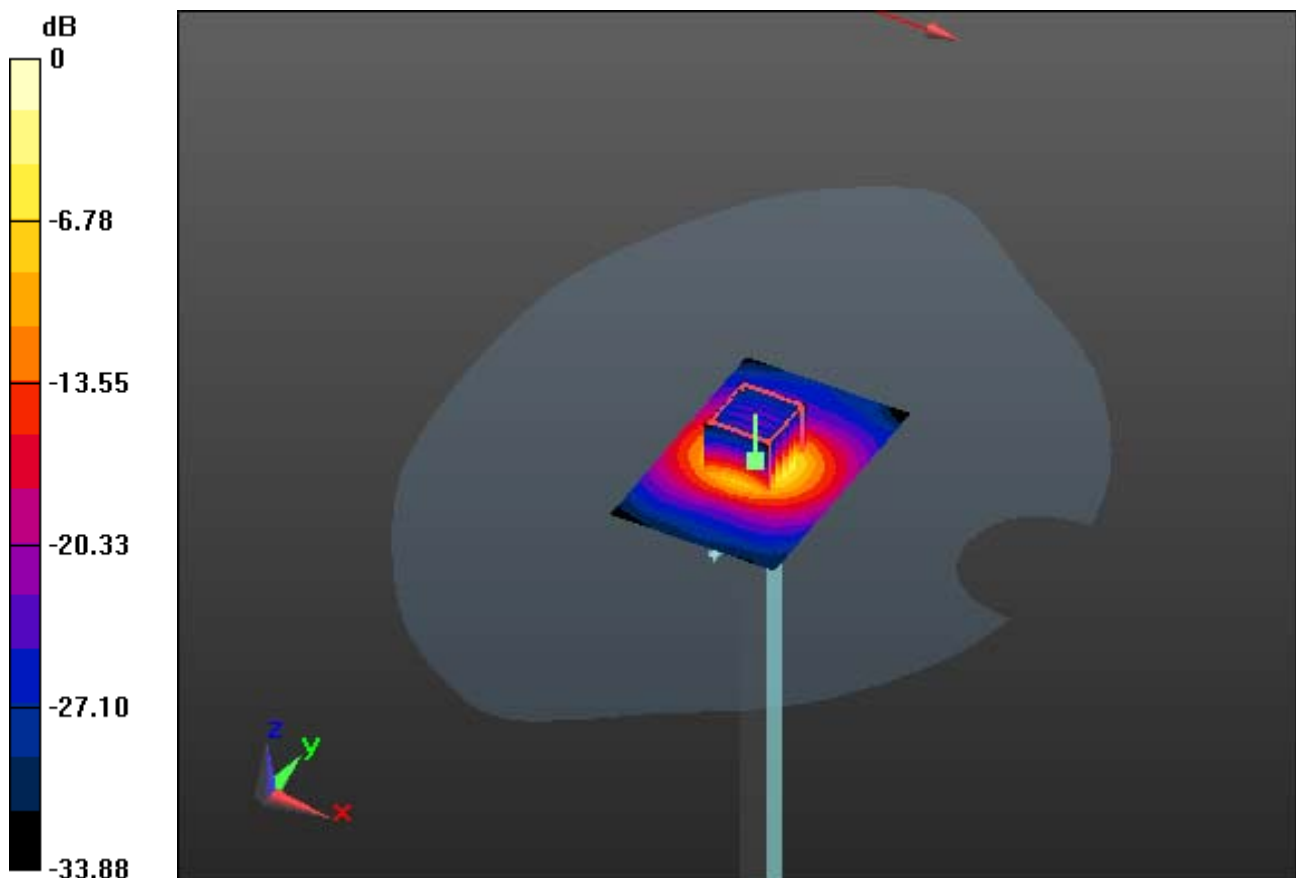

0 dB = 18.7 W/kg

DT&C Co., Ltd.

DUT: Dipole 5000 MHz; Type: D5GHzV2; Serial: D5GHzV2 - SN:1103

Communication System: CW (0); Frequency: 5300 MHz; Duty Cycle: 1:1
Medium parameters used: $f = 5300$ MHz; $\sigma = 4.67$ S/m; $\epsilon_r = 34.589$; $\rho = 1000$ kg/m³
Phantom section: Flat Section

DASY5 Configuration:

Probe: EX3DV4 - SN3930; ConvF(4.81, 4.81, 4.81); Calibrated: 2014-07-22; Electronics: DAE4 Sn1394
Phantom: SAM with CRP_20120521; Type: SAM; Serial: 1679
Measurement SW: DASY52, Version 52.8 (7); SEMCAD X Version 14.6.10 (7164)

Test Date: 2014-10-07; Ambient Temp: 20.5; Tissue Temp: 20.8

5300 MHz System Verification

Area Scan (61x91x1): Interpolated grid: dx=10mm, dy=10mm
Zoom Scan (7x7x11)/Cube 0: Measurement grid: dx=4mm, dy=4mm, dz=2mm
Power Drift = 0.12 dB
Peak SAR (extrapolated) = 36.2 W/kg
SAR(1 g) = 9.04 W/kg; SAR(10 g) = 2.61 W/kg

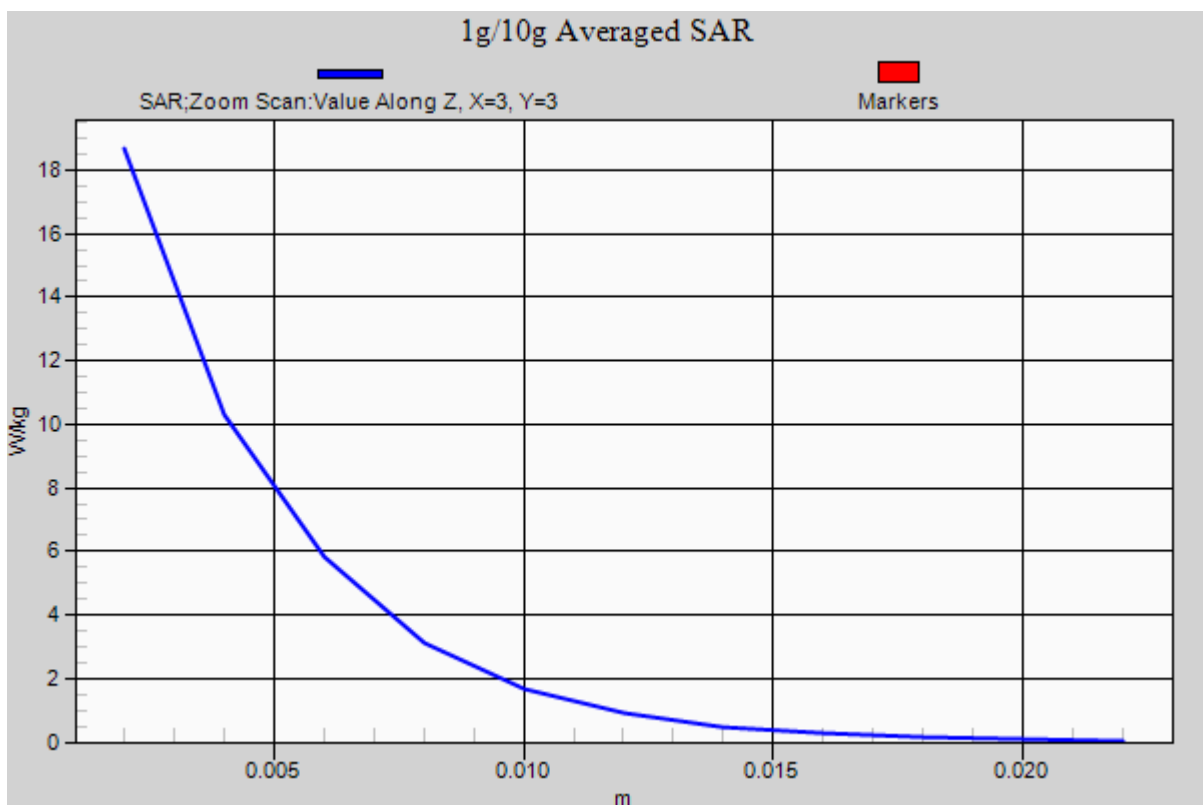

DT&C Co., Ltd.

DUT: Dipole 5000 MHz; Type: D5GHzV2; Serial: D5GHzV2 - SN:1103

Communication System: CW (0); Frequency: 5300 MHz; Duty Cycle: 1:1
Medium parameters used: $f = 5300$ MHz; $\sigma = 5.371$ S/m; $\epsilon_r = 47.719$; $\rho = 1000$ kg/m³
Phantom section: Flat Section

DASY5 Configuration:

Probe: EX3DV4 - SN3930; ConvF(4.49, 4.49, 4.49); Calibrated: 2014-07-22; Electronics: DAE4 Sn1394
Phantom: ELI v5.0; Type: QDOVA002AA; Serial: 1166
Measurement SW: DASY52, Version 52.8 (7); SEMCAD X Version 14.6.10 (7164)

Test Date: 2014-10-02; Ambient Temp: 20.1; Tissue Temp: 20.5

5300 MHz System Verification

Area Scan (61x91x1): Interpolated grid: dx=10mm, dy=10mm

Zoom Scan (7x7x11)/Cube 0: Measurement grid: dx=4mm, dy=4mm, dz=2mm

Power Drift = -0.02 dB

Peak SAR (extrapolated) = 34.3 W/kg

SAR(1 g) = 7.48 W/kg; SAR(10 g) = 2.11 W/kg

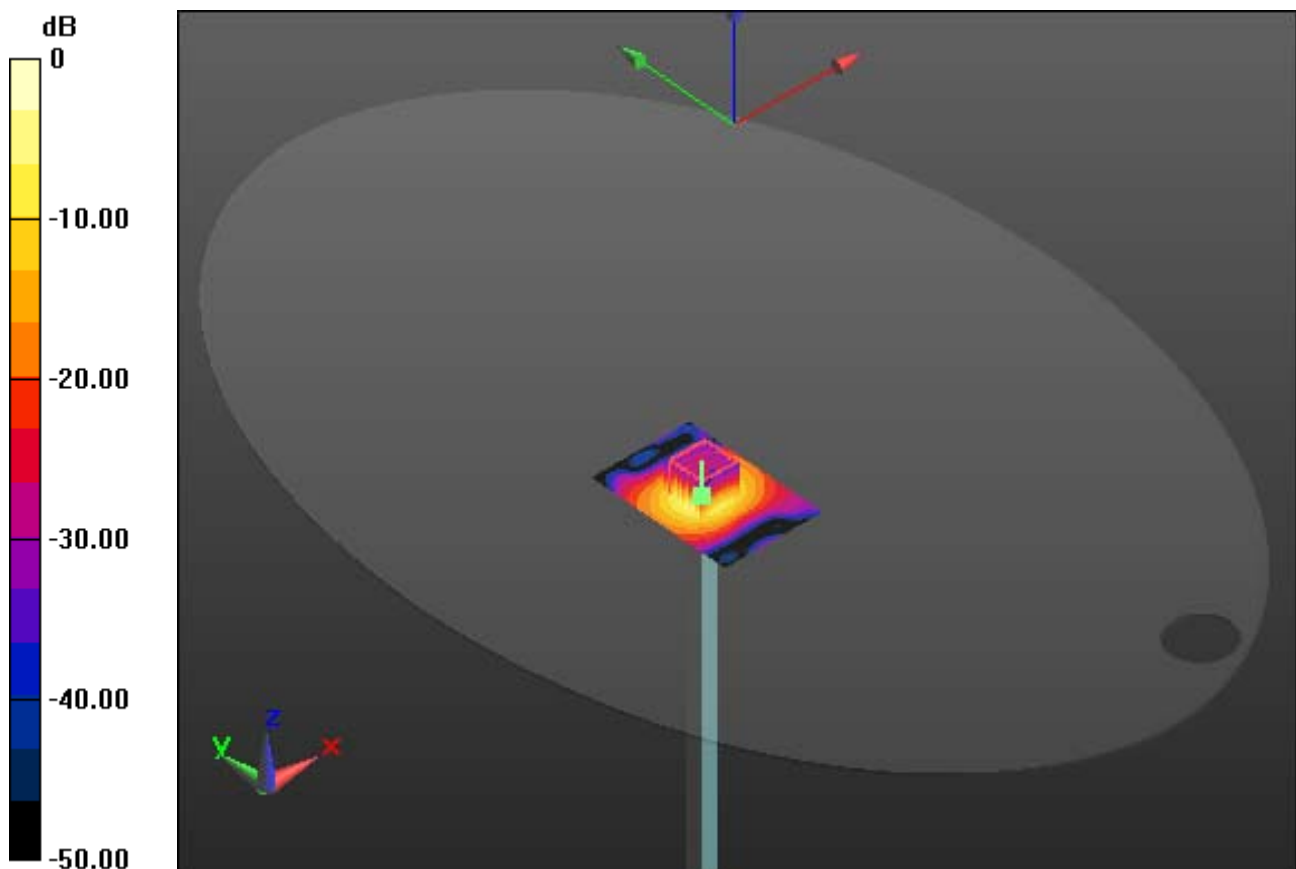

0 dB = 15.9 W/kg

DT&C Co., Ltd.

DUT: Dipole 5000 MHz; Type: D5GHzV2; Serial: D5GHzV2 - SN:1103

Communication System: CW (0); Frequency: 5300 MHz; Duty Cycle: 1:1
Medium parameters used: $f = 5300$ MHz; $\sigma = 5.371$ S/m; $\epsilon_r = 47.719$; $\rho = 1000$ kg/m³
Phantom section: Flat Section

DASY5 Configuration:

Probe: EX3DV4 - SN3930; ConvF(4.49, 4.49, 4.49); Calibrated: 2014-07-22; Electronics: DAE4 Sn1394
Phantom: ELI v5.0; Type: QDOVA002AA; Serial: 1166
Measurement SW: DASY52, Version 52.8 (7); SEMCAD X Version 14.6.10 (7164)

Test Date: 2014-10-02; Ambient Temp: 20.1; Tissue Temp: 20.5

5300 MHz System Verification

Area Scan (61x91x1): Interpolated grid: dx=10mm, dy=10mm
Zoom Scan (7x7x11)/Cube 0: Measurement grid: dx=4mm, dy=4mm, dz=2mm
Power Drift = -0.02 dB
Peak SAR (extrapolated) = 34.3 W/kg
SAR(1 g) = 7.48 W/kg; SAR(10 g) = 2.11 W/kg

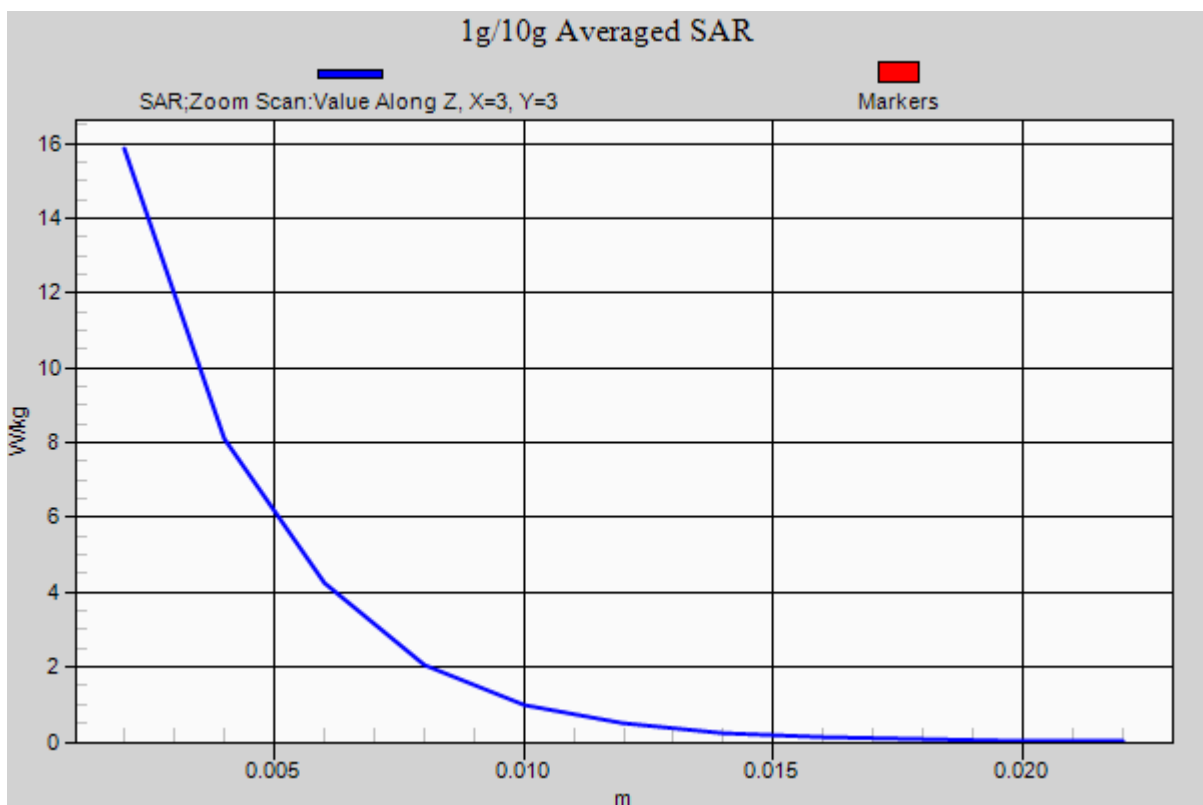

DT&C Co., Ltd.

DUT: Dipole 5000 MHz; Type: D5GHzV2; Serial: D5GHzV2 - SN:1103

Communication System: CW (0); Frequency: 5600 MHz; Duty Cycle: 1:1
Medium parameters used: $f = 5600$ MHz; $\sigma = 4.988$ S/m; $\epsilon_r = 34.9$; $\rho = 1000$ kg/m³
Phantom section: Flat Section

DASY5 Configuration:

Probe: EX3DV4 - SN3930; ConvF(4.76, 4.76, 4.76); Calibrated: 2014-07-22; Electronics: DAE4 Sn1394
Phantom: SAM with CRP_20120521; Type: SAM; Serial: 1679
Measurement SW: DASY52, Version 52.8 (8); SEMCAD X Version 14.6.10 (7331)

Test Date: 2014-10-07; Ambient Temp: 20.5; Tissue Temp: 20.8

5600 MHz System Verification

Area Scan (61x71x1): Interpolated grid: dx=10mm, dy=10mm

Zoom Scan (7x7x11)/Cube 0: Measurement grid: dx=4mm, dy=4mm, dz=2mm
Power Drift = 0.00 dB

Peak SAR (extrapolated) = 36.5 W/kg

SAR(1 g) = 8.49 W/kg; SAR(10 g) = 2.39 W/kg

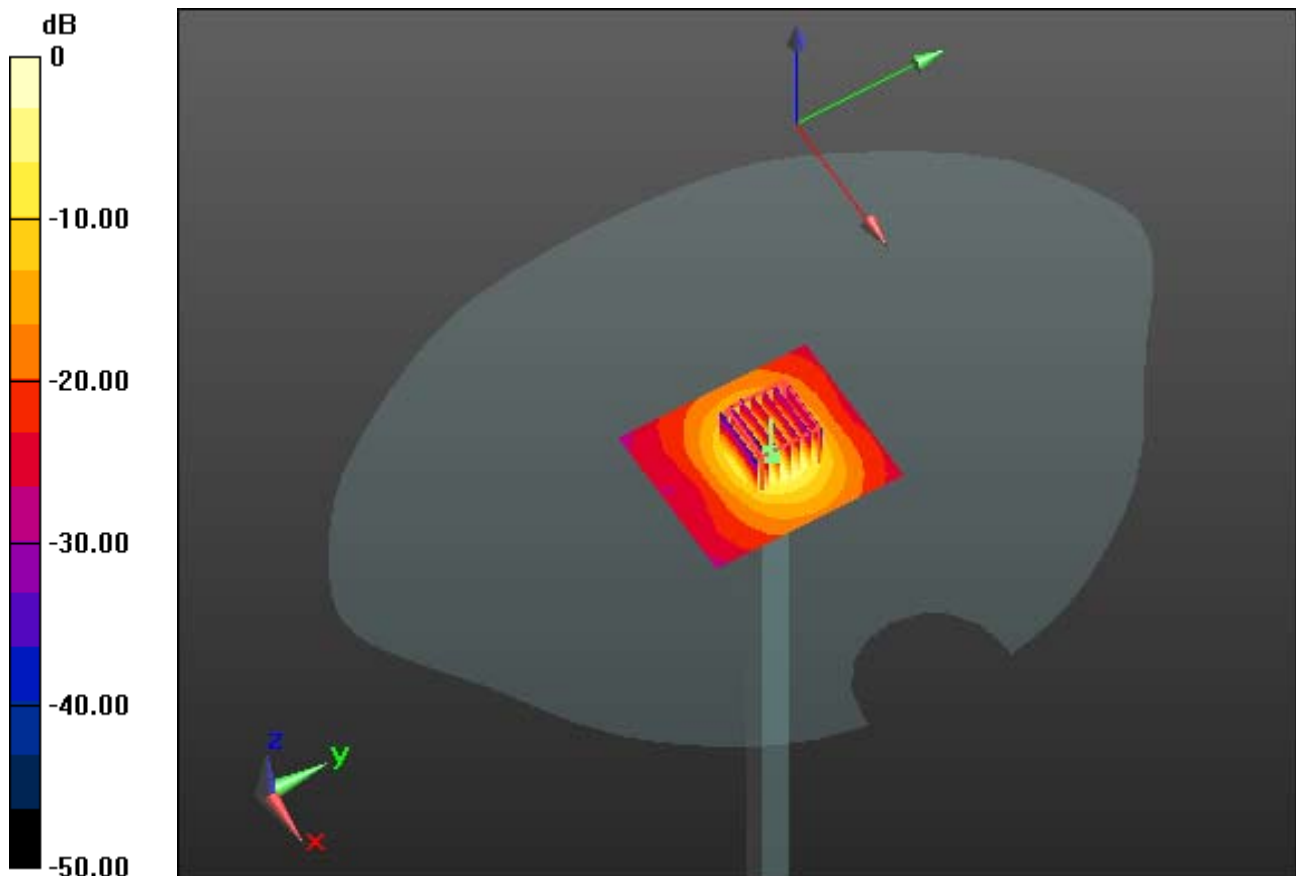

0 dB = 17.7 W/kg

DT&C Co., Ltd.

DUT: Dipole 5000 MHz; Type: D5GHzV2; Serial: D5GHzV2 - SN:1103

Communication System: CW (0); Frequency: 5600 MHz; Duty Cycle: 1:1
Medium parameters used: $f = 5600$ MHz; $\sigma = 4.988$ S/m; $\epsilon_r = 34.9$; $\rho = 1000$ kg/m³
Phantom section: Flat Section

DASY5 Configuration:

Probe: EX3DV4 - SN3930; ConvF(4.76, 4.76, 4.76); Calibrated: 2014-07-22; Electronics: DAE4 Sn1394
Phantom: SAM with CRP_20120521; Type: SAM; Serial: 1679
Measurement SW: DASY52, Version 52.8 (8); SEMCAD X Version 14.6.10 (7331)

Test Date: 2014-10-07; Ambient Temp: 20.5; Tissue Temp: 20.8

5600 MHz System Verification

Area Scan (61x71x1): Interpolated grid: dx=10mm, dy=10mm
Zoom Scan (7x7x11)/Cube 0: Measurement grid: dx=4mm, dy=4mm, dz=2mm
Power Drift = 0.00 dB
Peak SAR (extrapolated) = 36.5 W/kg
SAR(1 g) = 8.49 W/kg; SAR(10 g) = 2.39 W/kg

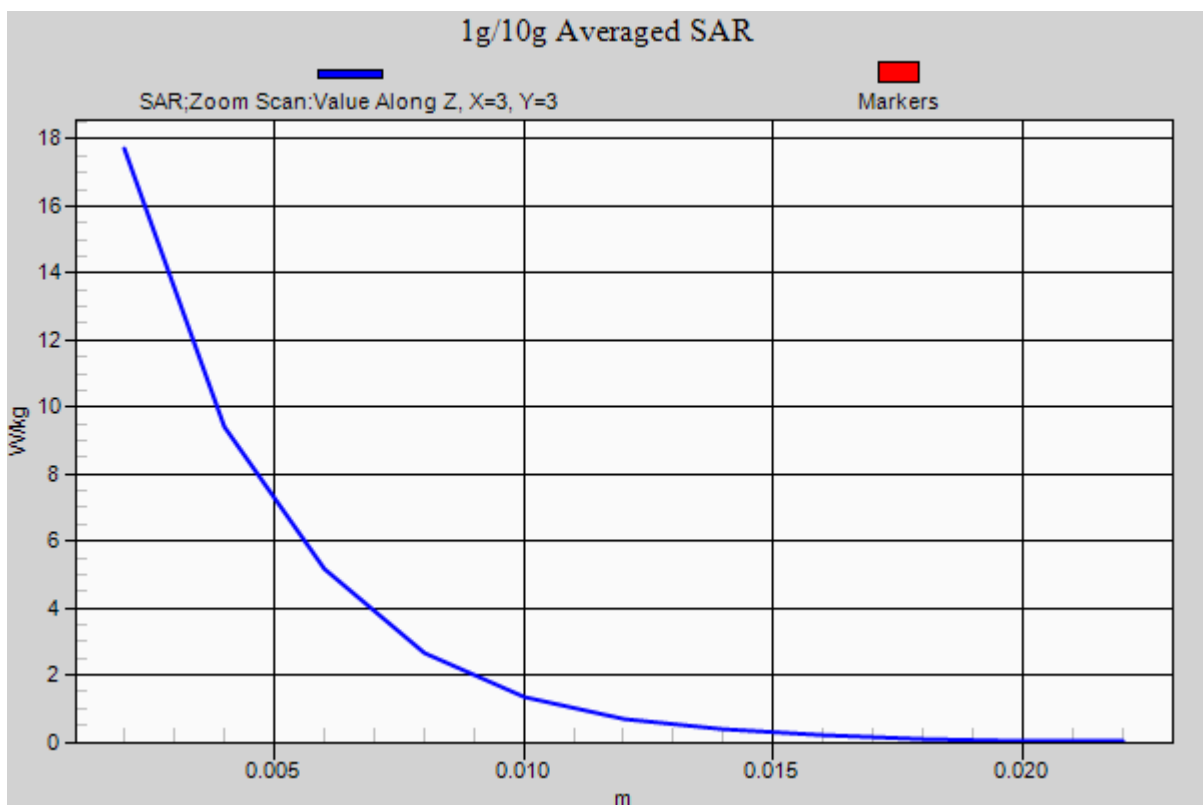

DT&C Co., Ltd.

DUT: Dipole 5000 MHz; Type: D5GHzV2; Serial: D5GHzV2 - SN:1103

Communication System: CW (0); Frequency: 5600 MHz; Duty Cycle: 1:1
Medium parameters used: $f = 5600$ MHz; $\sigma = 5.758$ S/m; $\epsilon_r = 47.216$; $\rho = 1000$ kg/m³
Phantom section: Flat Section

DASY5 Configuration:

Probe: EX3DV4 - SN3930; ConvF(4.06, 4.06, 4.06); Calibrated: 2014-07-22; Electronics: DAE4 Sn1394
Phantom: ELI v5.0; Type: QDOVA002AA; Serial: 1166
Measurement SW: DASY52, Version 52.8 (7); SEMCAD X Version 14.6.10 (7164)

Test Date: 2014-10-02; Ambient Temp: 20.1; Tissue Temp: 20.5

5600 MHz System Verification

Area Scan (61x71x1): Interpolated grid: dx=10mm, dy=10mm

Zoom Scan (7x7x11)/Cube 0: Measurement grid: dx=4mm, dy=4mm, dz=2mm

Power Drift = 0.05 dB

Peak SAR (extrapolated) = 36.6 W/kg

SAR(1 g) = 8.56 W/kg; SAR(10 g) = 2.38 W/kg

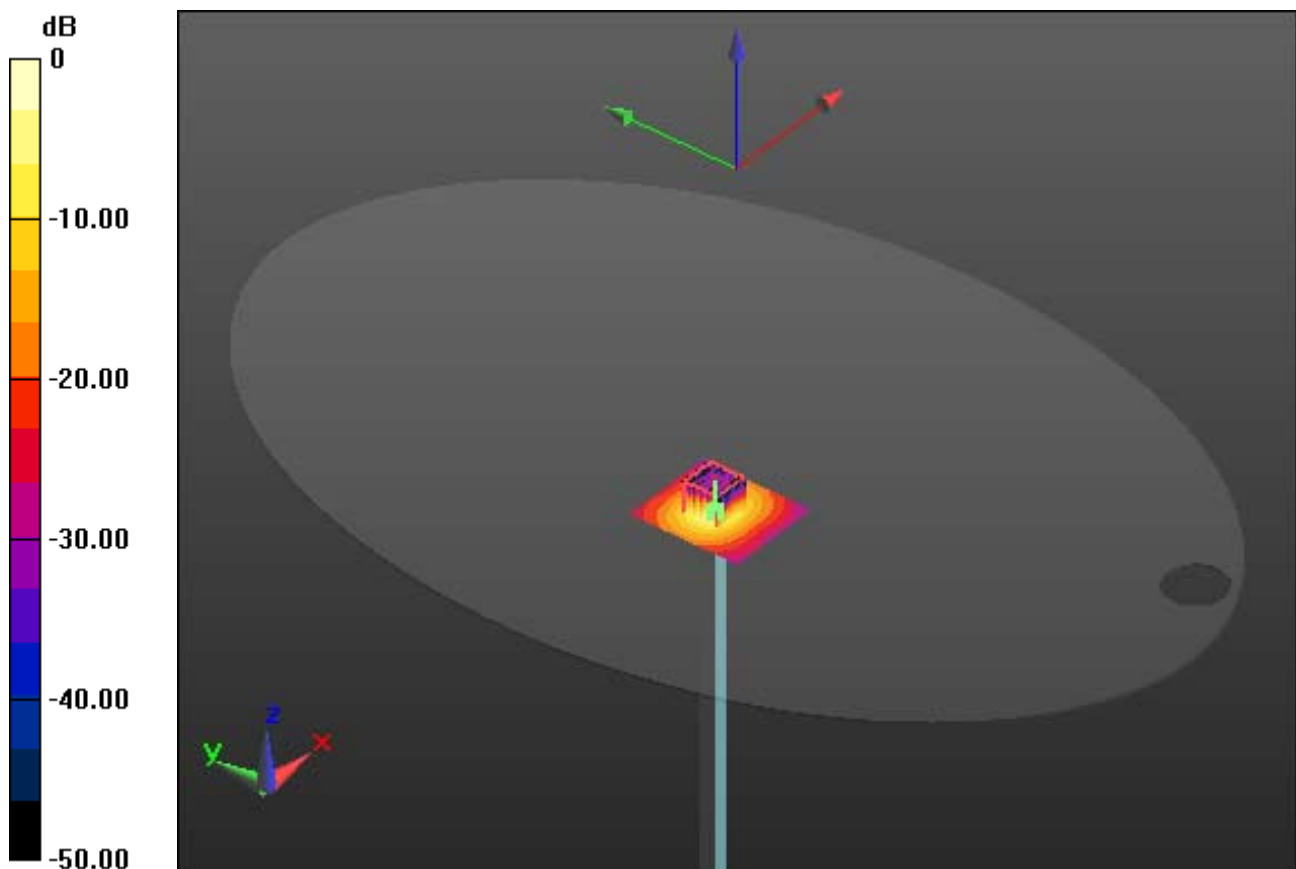

0 dB = 18.2 W/kg

DT&C Co., Ltd.

DUT: Dipole 5000 MHz; Type: D5GHzV2; Serial: D5GHzV2 - SN:1103

Communication System: CW (0); Frequency: 5600 MHz; Duty Cycle: 1:1
Medium parameters used: $f = 5600$ MHz; $\sigma = 5.758$ S/m; $\epsilon_r = 47.216$; $\rho = 1000$ kg/m³
Phantom section: Flat Section

DASY5 Configuration:

Probe: EX3DV4 - SN3930; ConvF(4.06, 4.06, 4.06); Calibrated: 2014-07-22; Electronics: DAE4 Sn1394
Phantom: ELI v5.0; Type: QDOVA002AA; Serial: 1166
Measurement SW: DASY52, Version 52.8 (7); SEMCAD X Version 14.6.10 (7164)

Test Date: 2014-10-02; Ambient Temp: 20.1; Tissue Temp: 20.5

5600 MHz System Verification

Area Scan (61x71x1): Interpolated grid: dx=10mm, dy=10mm
Zoom Scan (7x7x11)/Cube 0: Measurement grid: dx=4mm, dy=4mm, dz=2mm
Power Drift = 0.05 dB
Peak SAR (extrapolated) = 36.6 W/kg
SAR(1 g) = 8.56 W/kg; SAR(10 g) = 2.38 W/kg

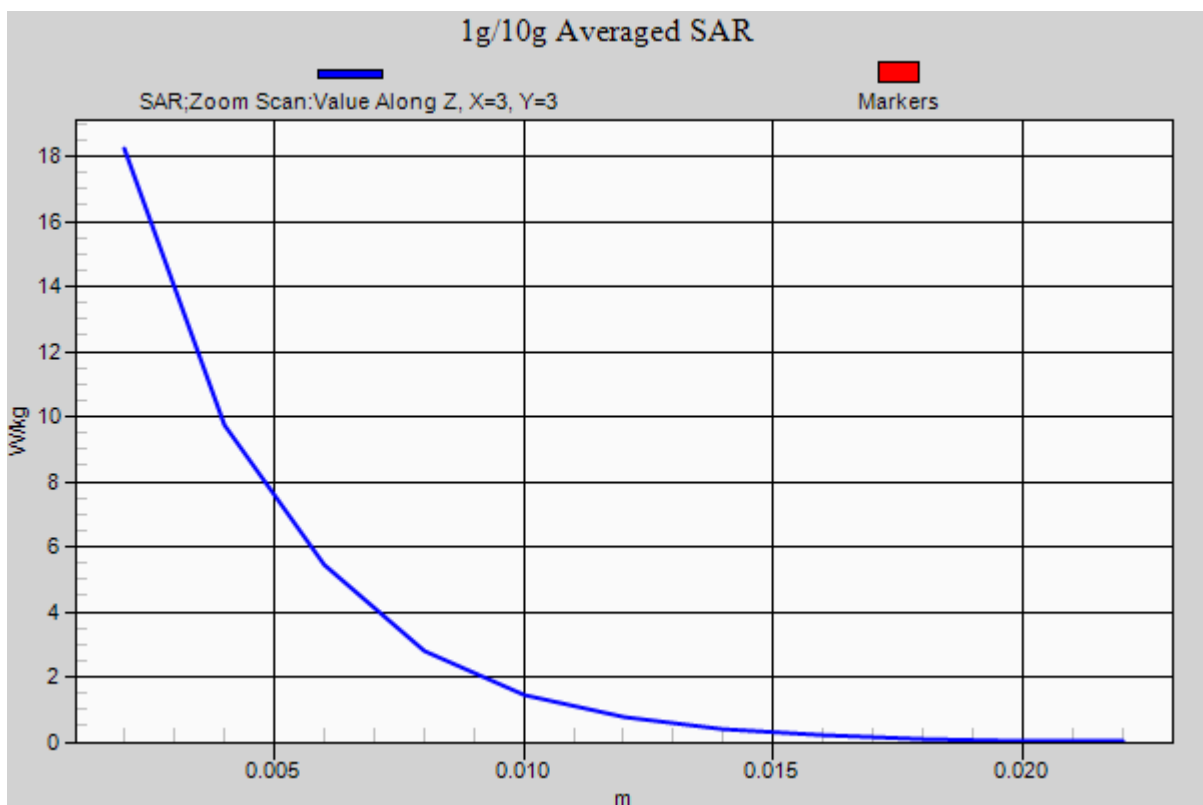

DT&C Co., Ltd.

DUT: Dipole 5000 MHz; Type: D5GHzV2; Serial: D5GHzV2 - SN:1103

Communication System: CW (0); Frequency: 5800 MHz; Duty Cycle: 1:1
Medium parameters used: $f = 5800$ MHz; $\sigma = 5.221$ S/m; $\epsilon_r = 34.553$; $\rho = 1000$ kg/m³
Phantom section: Flat Section

DASY5 Configuration:

Probe: EX3DV4 - SN3930; ConvF(4.71, 4.71, 4.71); Calibrated: 2014-07-22; Electronics: DAE4 Sn1394
Phantom: SAM with CRP_20120521; Type: SAM; Serial: 1679
Measurement SW: DASY52, Version 52.8 (8); SEMCAD X Version 14.6.10 (7331)

Test Date: 2014-10-07; Ambient Temp: 20.5; Tissue Temp: 20.8

5800 MHz System Verification

Area Scan (61x71x1): Interpolated grid: dx=10mm, dy=10mm

Zoom Scan (7x7x11)/Cube 0: Measurement grid: dx=4mm, dy=4mm, dz=2mm

Power Drift = 0.05 dB

Peak SAR (extrapolated) = 36.8 W/kg

SAR(1 g) = 8.04 W/kg; SAR(10 g) = 2.21 W/kg

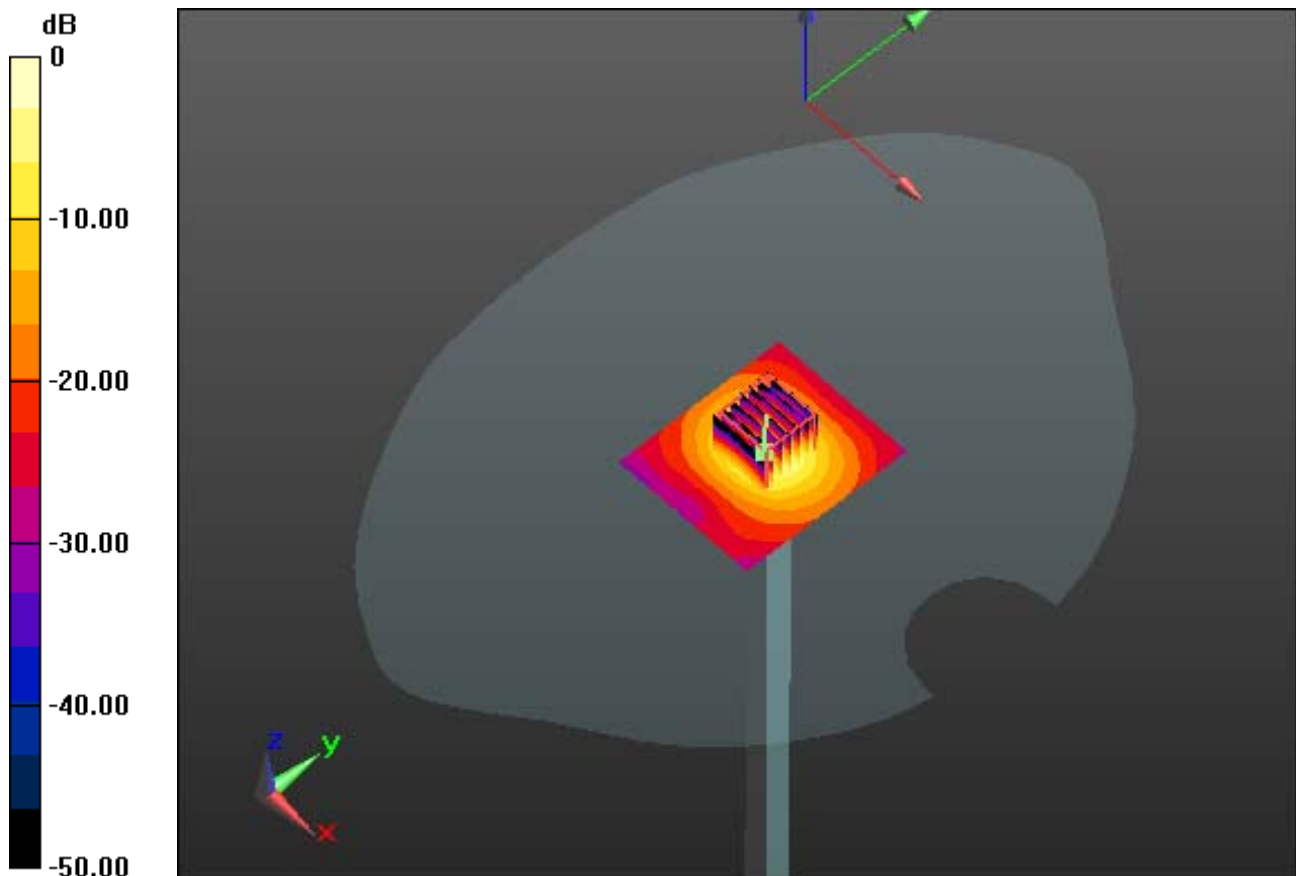

0 dB = 16.9 W/kg

DT&C Co., Ltd.

DUT: Dipole 5000 MHz; Type: D5GHzV2; Serial: D5GHzV2 - SN:1103

Communication System: CW (0); Frequency: 5800 MHz; Duty Cycle: 1:1
Medium parameters used: $f = 5800$ MHz; $\sigma = 5.221$ S/m; $\epsilon_r = 34.553$; $\rho = 1000$ kg/m³
Phantom section: Flat Section

DASY5 Configuration:

Probe: EX3DV4 - SN3930; ConvF(4.71, 4.71, 4.71); Calibrated: 2014-07-22; Electronics: DAE4 Sn1394
Phantom: SAM with CRP_20120521; Type: SAM; Serial: 1679
Measurement SW: DASY52, Version 52.8 (8); SEMCAD X Version 14.6.10 (7331)

Test Date: 2014-10-07; Ambient Temp: 20.5; Tissue Temp: 20.8

5800 MHz System Verification

Area Scan (61x71x1): Interpolated grid: dx=10mm, dy=10mm
Zoom Scan (7x7x11)/Cube 0: Measurement grid: dx=4mm, dy=4mm, dz=2mm
Power Drift = 0.05 dB
Peak SAR (extrapolated) = 36.8 W/kg
SAR(1 g) = 8.04 W/kg; SAR(10 g) = 2.21 W/kg

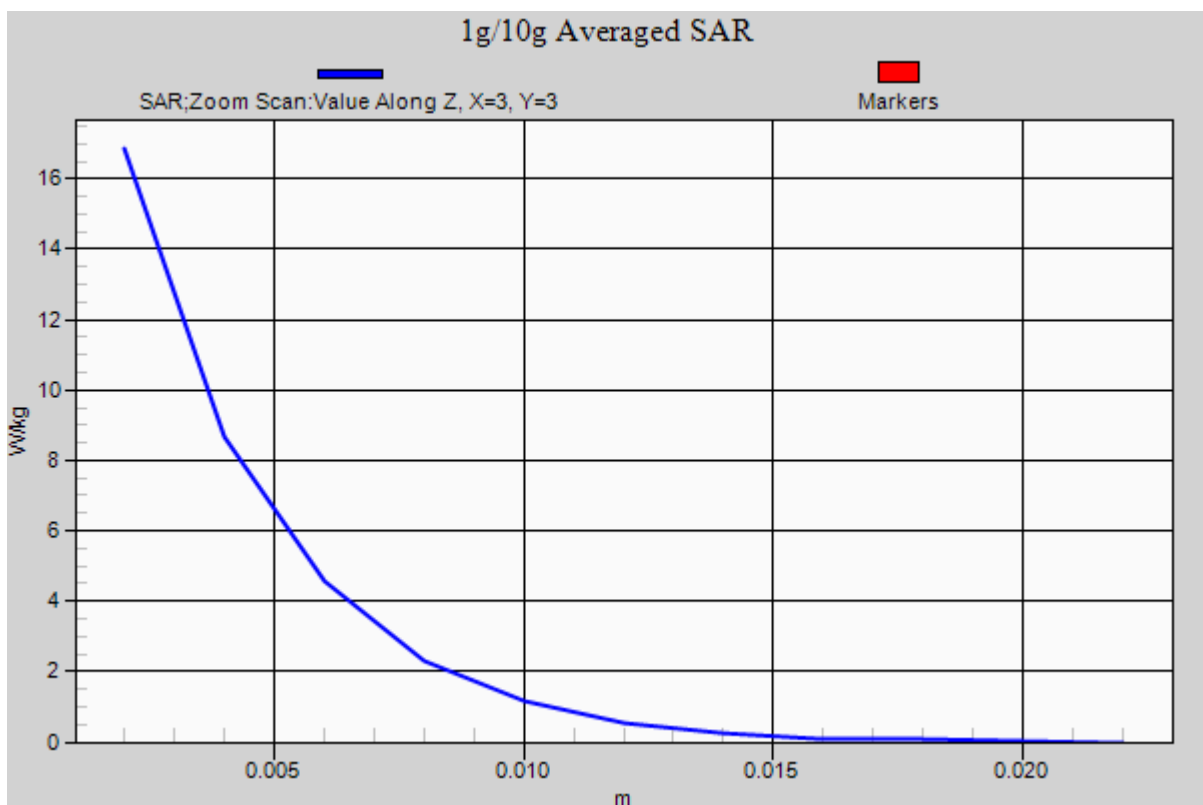

DT&C Co., Ltd.

DUT: Dipole 5000 MHz; Type: D5GHzV2; Serial: D5GHzV2 - SN:1103

Communication System: CW (0); Frequency: 5800 MHz; Duty Cycle: 1:1
Medium parameters used: $f = 5800$ MHz; $\sigma = 6.025$ S/m; $\epsilon_r = 46.89$; $\rho = 1000$ kg/m³
Phantom section: Flat Section

DASY5 Configuration:

Probe: EX3DV4 - SN3930; ConvF(4.21, 4.21, 4.21); Calibrated: 2014-07-22; Electronics: DAE4 Sn1394
Phantom: ELI v5.0; Type: QDOVA002AA; Serial: 1166
Measurement SW: DASY52, Version 52.8 (7); SEMCAD X Version 14.6.10 (7164)

Test Date: 2014-10-02; Ambient Temp: 20.1; Tissue Temp: 20.5

5800 MHz System Verification

Area Scan (61x71x1): Interpolated grid: dx=10mm, dy=10mm
Zoom Scan (7x7x11)/Cube 0: Measurement grid: dx=4mm, dy=4mm, dz=2mm
Power Drift = 0.01 dB
Peak SAR (extrapolated) = 34.2 W/kg
SAR(1 g) = 8.24 W/kg; SAR(10 g) = 2.26 W/kg

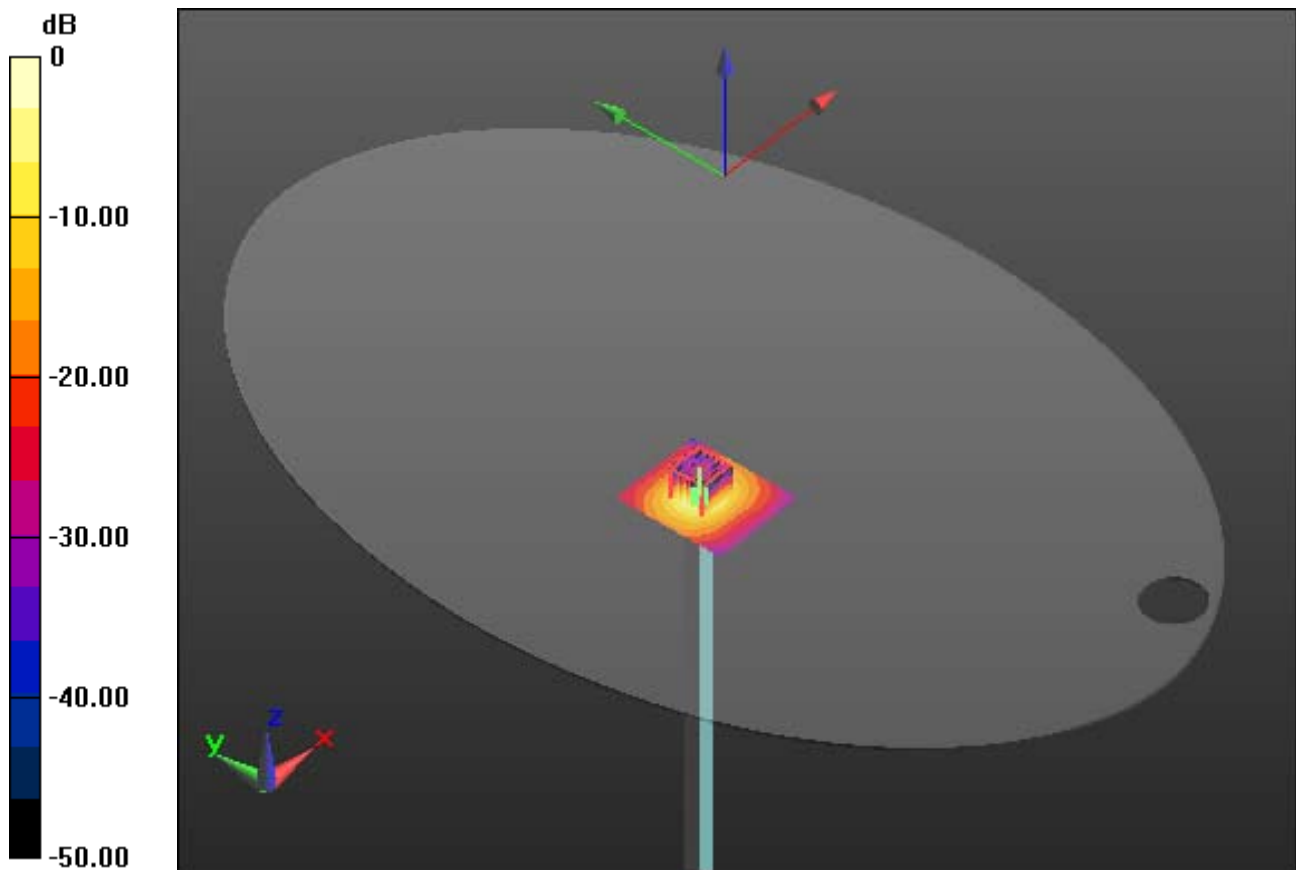

0 dB = 17.4 W/kg

DT&C Co., Ltd.

DUT: Dipole 5000 MHz; Type: D5GHzV2; Serial: D5GHzV2 - SN:1103

Communication System: CW (0); Frequency: 5800 MHz; Duty Cycle: 1:1
Medium parameters used: $f = 5800$ MHz; $\sigma = 6.025$ S/m; $\epsilon_r = 46.89$; $\rho = 1000$ kg/m³
Phantom section: Flat Section

DASY5 Configuration:

Probe: EX3DV4 - SN3930; ConvF(4.21, 4.21, 4.21); Calibrated: 2014-07-22; Electronics: DAE4 Sn1394
Phantom: ELI v5.0; Type: QDOVA002AA; Serial: 1166
Measurement SW: DASY52, Version 52.8 (7); SEMCAD X Version 14.6.10 (7164)

Test Date: 2014-10-02; Ambient Temp: 20.1; Tissue Temp: 20.5

5800 MHz System Verification

Area Scan (61x71x1): Interpolated grid: dx=10mm, dy=10mm
Zoom Scan (7x7x11)/Cube 0: Measurement grid: dx=4mm, dy=4mm, dz=2mm
Power Drift = 0.01 dB
Peak SAR (extrapolated) = 34.2 W/kg
SAR(1 g) = 8.24 W/kg; SAR(10 g) = 2.26 W/kg

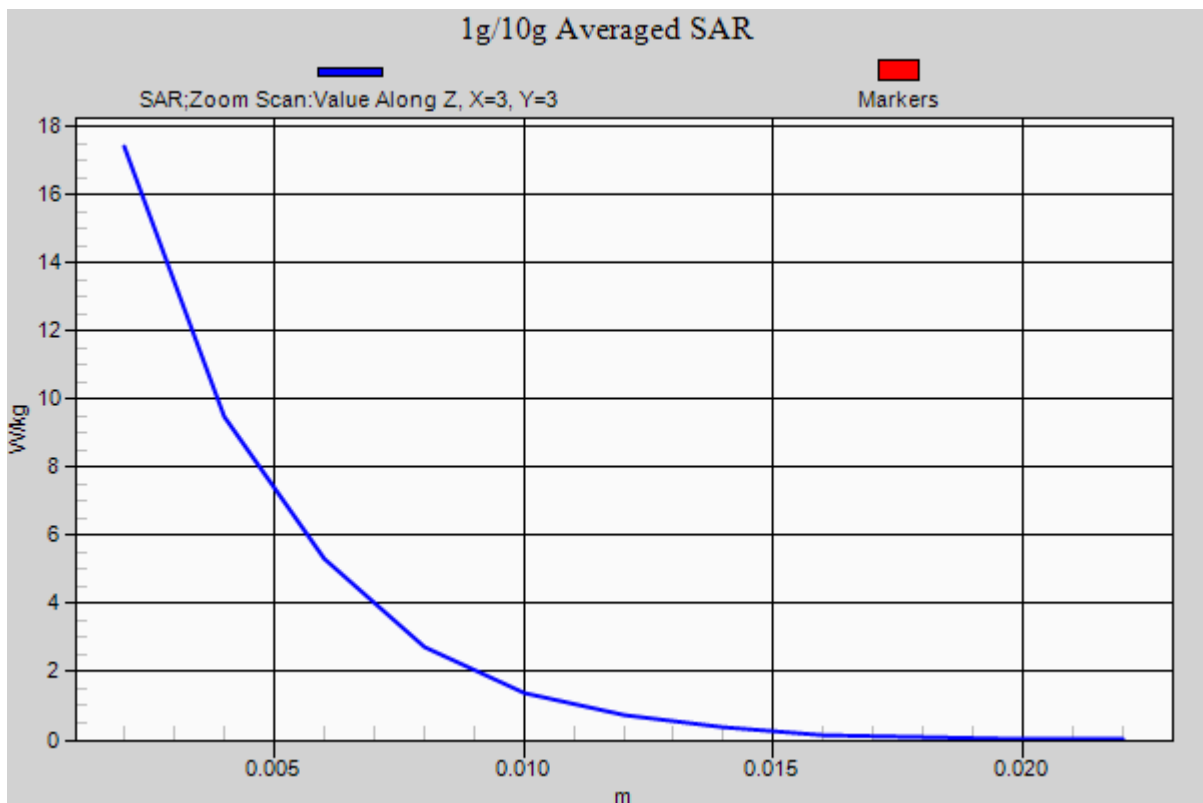

DT&C Co., Ltd.

DUT: PM450; Type: PDA

Communication System: W-LAN (0); Frequency: 2412 MHz; Duty Cycle: 1:1
Medium parameters used: $f = 2412$ MHz; $\sigma = 1.797$ S/m; $\epsilon_r = 38.181$; $\rho = 1000$ kg/m³
Phantom section: Left Section

DASY5 Configuration:

Probe: EX3DV4 - SN3930; ConvF(7.56, 7.56, 7.56); Calibrated: 2014-07-22; Electronics: DAE4 Sn1394
Phantom: SAM with CRP_20120521; Type: SAM; Serial: 1679
Measurement SW: DASY52, Version 52.8 (7); SEMCAD X Version 14.6.10 (7164)

Test Date: 2014-10-03; Ambient Temp: 20.4; Tissue Temp: 21.0

Left Touch, W-LAN(802.11b) Ch. 1, Ant Internal, Standard Battery

Area Scan (111x231x1): Interpolated grid: dx=12mm, dy=12mm

Zoom Scan (7x7x7)/Cube 0: Measurement grid: dx=5mm, dy=5mm, dz=5mm
Power Drift = 0.02 dB

Peak SAR (extrapolated) = 0.135 W/kg

SAR(1 g) = 0.069 W/kg; SAR(10 g) = 0.035 W/kg

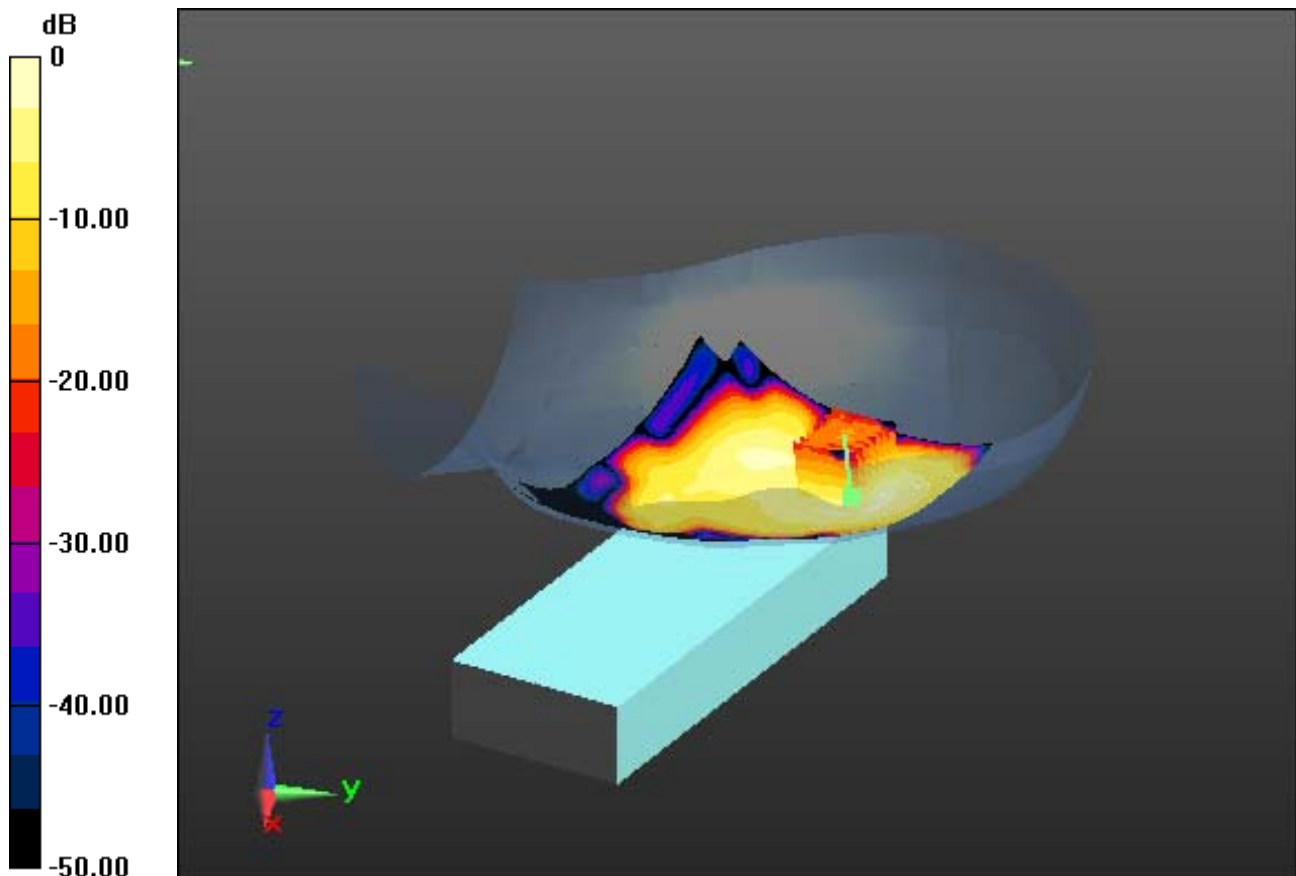

0 dB = 0.102 W/kg

DT&C Co., Ltd.

DUT: PM450; Type: PDA

Communication System: W-LAN (0); Frequency: 2412 MHz; Duty Cycle: 1:1
Medium parameters used: $f = 2412$ MHz; $\sigma = 1.797$ S/m; $\epsilon_r = 38.181$; $\rho = 1000$ kg/m³
Phantom section: Left Section

DASY5 Configuration:

Probe: EX3DV4 - SN3930; ConvF(7.56, 7.56, 7.56); Calibrated: 2014-07-22; Electronics: DAE4 Sn1394
Phantom: SAM with CRP_20120521; Type: SAM; Serial: 1679
Measurement SW: DASY52, Version 52.8 (7); SEMCAD X Version 14.6.10 (7164)

Test Date: 2014-10-03; Ambient Temp: 20.4; Tissue Temp: 21.0

Left Touch, W-LAN(802.11b) Ch. 1, Ant Internal, Standard Battery

With Enlarge plot image

Area Scan (111x231x1): Interpolated grid: dx=12mm, dy=12mm

Zoom Scan (7x7x7)/Cube 0: Measurement grid: dx=5mm, dy=5mm, dz=5mm

Power Drift = 0.02 dB

Peak SAR (extrapolated) = 0.135 W/kg

SAR(1 g) = 0.069 W/kg; SAR(10 g) = 0.035 W/kg

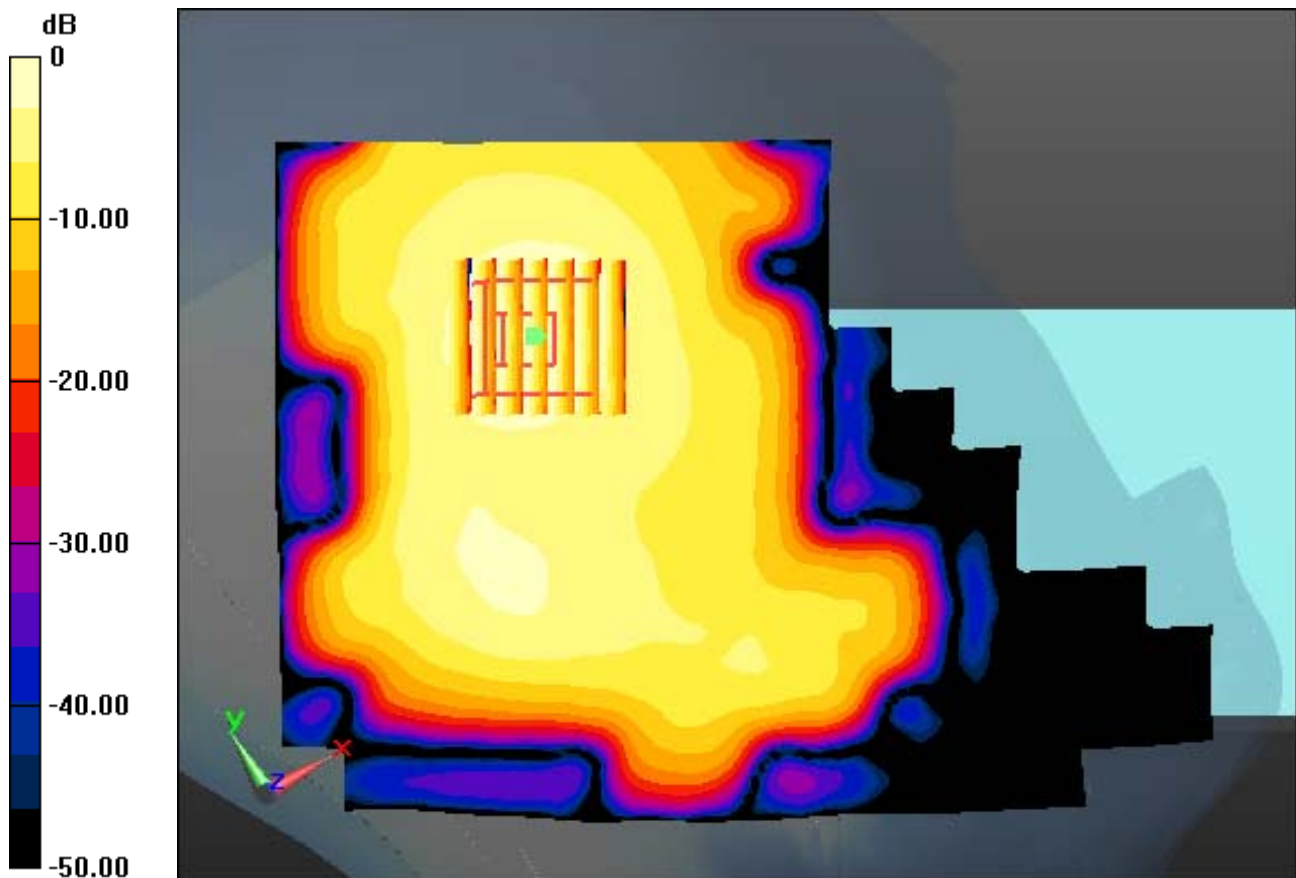

0 dB = 0.102 W/kg

DT&C Co., Ltd.

DUT: PM450; Type: PDA

Communication System: W-LAN (0); Frequency: 2412 MHz; Duty Cycle: 1:1
Medium parameters used: $f = 2412$ MHz; $\sigma = 1.797$ S/m; $\epsilon_r = 38.181$; $\rho = 1000$ kg/m³
Phantom section: Left Section

DASY5 Configuration:

Probe: EX3DV4 - SN3930; ConvF(7.56, 7.56, 7.56); Calibrated: 2014-07-22; Electronics: DAE4 Sn1394
Phantom: SAM with CRP_20120521; Type: SAM; Serial: 1679
Measurement SW: DASY52, Version 52.8 (7); SEMCAD X Version 14.6.10 (7164)

Test Date: 2014-10-03; Ambient Temp: 20.4; Tissue Temp: 21.0

Left Touch, W-LAN(802.11b) Ch. 1, Ant Internal, Standard Battery

Area Scan (111x231x1): Interpolated grid: dx=12mm, dy=12mm
Zoom Scan (7x7x7)/Cube 0: Measurement grid: dx=5mm, dy=5mm, dz=5mm
Power Drift = 0.02 dB
Peak SAR (extrapolated) = 0.135 W/kg
SAR(1 g) = 0.069 W/kg; SAR(10 g) = 0.035 W/kg

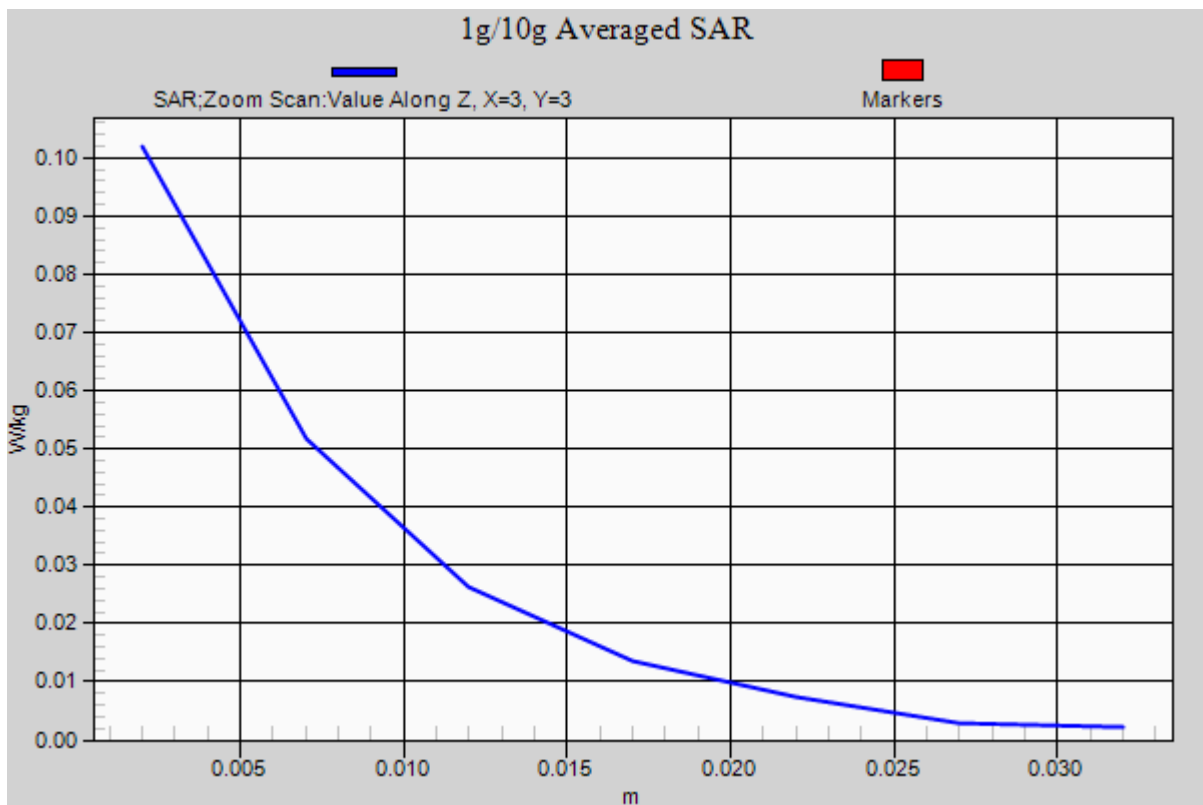

DT&C Co., Ltd.

DUT: PM450; Type: PDA

Communication System: W-LAN_5200 (0); Frequency: 5180 MHz; Duty Cycle: 1:1
Medium parameters used: $f = 5180$ MHz; $\sigma = 4.537$ S/m; $\epsilon_r = 34.803$; $\rho = 1000$ kg/m³
Phantom section: Left Section

DASY5 Configuration:

Probe: EX3DV4 - SN3930; ConvF(5.14, 5.14, 5.14); Calibrated: 2014-07-22; Electronics: DAE4 Sn1394
Phantom: SAM with CRP_20120521; Type: SAM; Serial: 1679
Measurement SW: DASY52, Version 52.8 (9); SEMCAD X Version 14.6.10 (7164)

Test Date: 2014-10-07; Ambient Temp: 20.5; Tissue Temp: 20.8

Left Touch, W-LAN(802.11a 5.2G) Ch. 36, Ant Internal, Standard Battery

Area Scan (141x281x1): Interpolated grid: dx=10mm, dy=10mm

Zoom Scan (7x7x11)/Cube 0: Measurement grid: dx=4mm, dy=4mm, dz=2mm
Power Drift = 0.16 dB

Peak SAR (extrapolated) = 0.257 W/kg

SAR(1 g) = 0.120 W/kg; SAR(10 g) = 0.060 W/kg

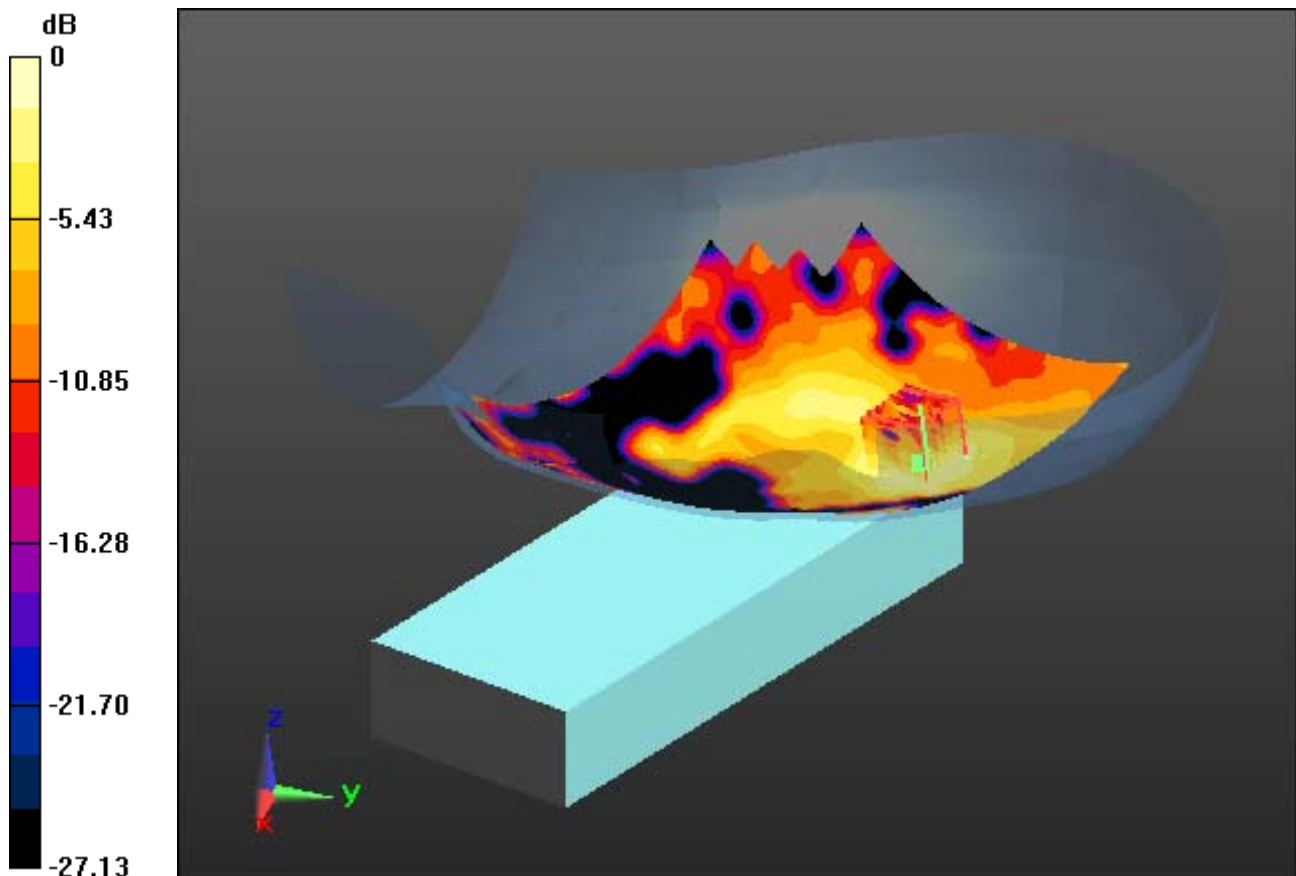

0 dB = 0.179 W/kg

DT&C Co., Ltd.

DUT: PM450; Type: PDA

Communication System: W-LAN_5200 (0); Frequency: 5180 MHz; Duty Cycle: 1:1
Medium parameters used: $f = 5180$ MHz; $\sigma = 4.537$ S/m; $\epsilon_r = 34.803$; $\rho = 1000$ kg/m³
Phantom section: Left Section

DASY5 Configuration:

Probe: EX3DV4 - SN3930; ConvF(5.14, 5.14, 5.14); Calibrated: 2014-07-22; Electronics: DAE4 Sn1394
Phantom: SAM with CRP_20120521; Type: SAM; Serial: 1679
Measurement SW: DASY52, Version 52.8 (7); SEMCAD X Version 14.6.10 (7164)

Test Date: 2014-10-07; Ambient Temp: 20.5; Tissue Temp: 20.8

Left Touch, W-LAN(802.11a 5.2G) Ch. 36, Ant Internal, Standard Battery

With Enlarge plot image

Area Scan (141x281x1): Interpolated grid: dx=10mm, dy=10mm
Zoom Scan (7x7x11)/Cube 0: Measurement grid: dx=4mm, dy=4mm, dz=2mm
Power Drift = 0.16 dB
Peak SAR (extrapolated) = 0.257 W/kg
SAR(1 g) = 0.120 W/kg; SAR(10 g) = 0.060 W/kg

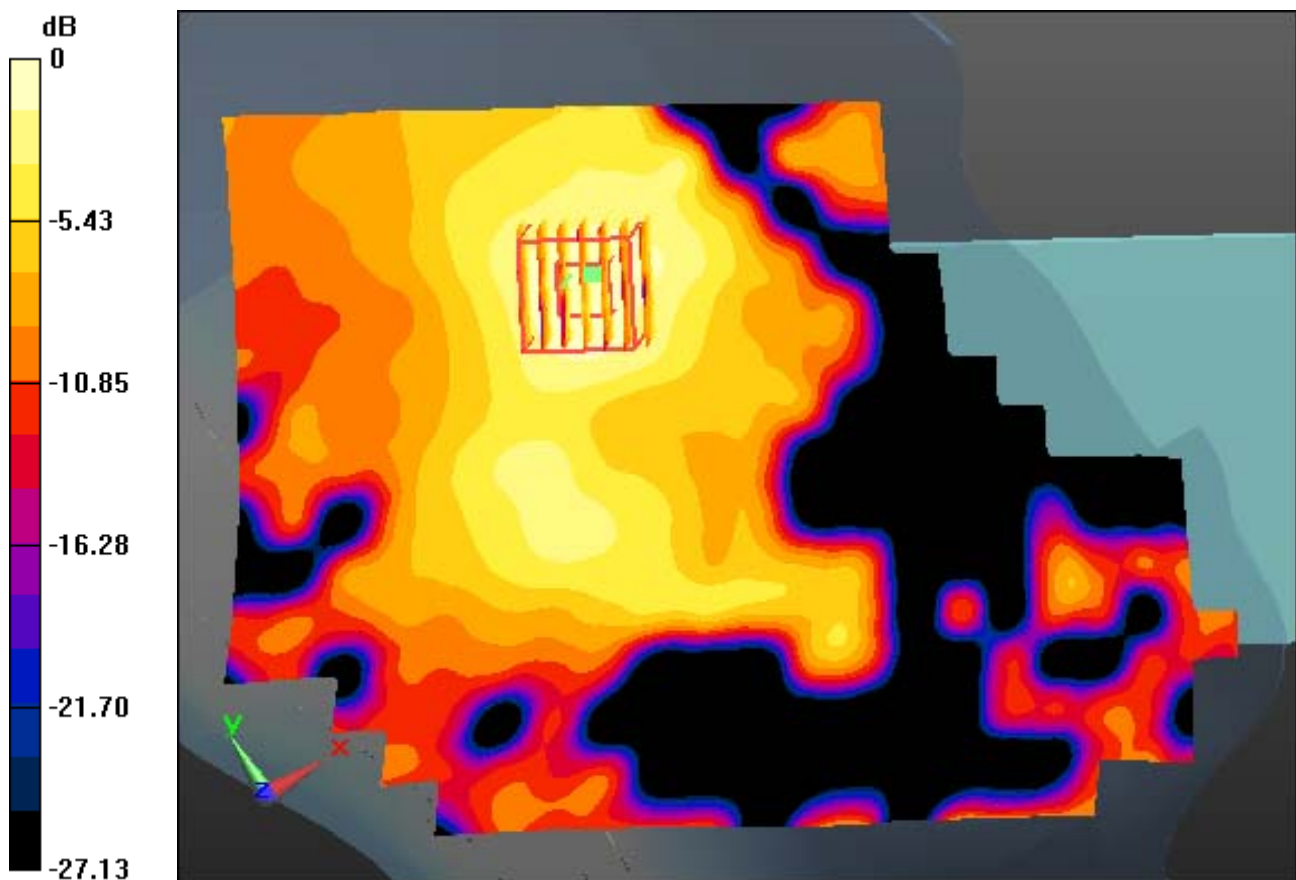

0 dB = 0.179 W/kg

DT&C Co., Ltd.

DUT: PM450; Type: PDA

Communication System: W-LAN_5200 (0); Frequency: 5180 MHz; Duty Cycle: 1:1
Medium parameters used: $f = 5180$ MHz; $\sigma = 4.537$ S/m; $\epsilon_r = 34.803$; $\rho = 1000$ kg/m³
Phantom section: Left Section

DASY5 Configuration:

Probe: EX3DV4 - SN3930; ConvF(5.14, 5.14, 5.14); Calibrated: 2014-07-22; Electronics: DAE4 Sn1394
Phantom: SAM with CRP_20120521; Type: SAM; Serial: 1679
Measurement SW: DASY52, Version 52.8 (7); SEMCAD X Version 14.6.10 (7164)

Test Date: 2014-10-07; Ambient Temp: 20.5; Tissue Temp: 20.8

Left Touch, W-LAN(802.11a 5.2G) Ch. 36, Ant Internal, Standard Battery

Area Scan (141x281x1): Interpolated grid: dx=10mm, dy=10mm
Zoom Scan (7x7x11)/Cube 0: Measurement grid: dx=4mm, dy=4mm, dz=2mm
Power Drift = 0.16 dB
Peak SAR (extrapolated) = 0.257 W/kg
SAR(1 g) = 0.120 W/kg; SAR(10 g) = 0.060 W/kg

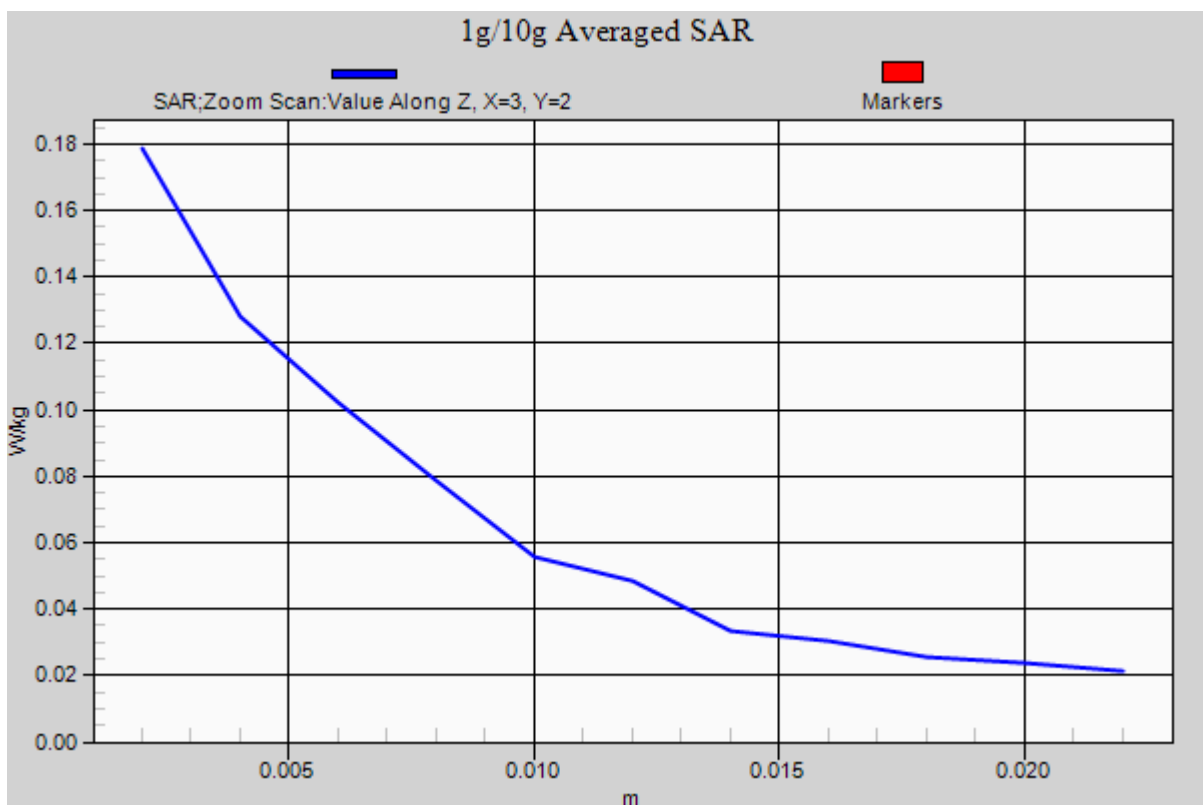

DT&C Co., Ltd.

DUT: PM450; Type: PDA

Communication System: W-LAN_5200 (0); Frequency: 5260 MHz; Duty Cycle: 1:1
Medium parameters used: $f = 5260$ MHz; $\sigma = 4.631$ S/m; $\epsilon_r = 34.658$; $\rho = 1000$ kg/m³
Phantom section: Left Section

DASY5 Configuration:

Probe: EX3DV4 - SN3930; ConvF(4.81, 4.81, 4.81); Calibrated: 2014-07-22; Electronics: DAE4 Sn1394
Phantom: SAM with CRP_20120521; Type: SAM; Serial: 1679
Measurement SW: DASY52, Version 52.8 (7); SEMCAD X Version 14.6.10 (7164)

Test Date: 2014-10-07; Ambient Temp: 20.5; Tissue Temp: 20.8

Left Touch, W-LAN(802.11a 5.3G) Ch. 52, Ant Internal, Standard Battery

Area Scan (141x281x1): Interpolated grid: dx=10mm, dy=10mm

Zoom Scan (7x7x11)/Cube 0: Measurement grid: dx=4mm, dy=4mm, dz=2mm

Power Drift = -0.17 dB

Peak SAR (extrapolated) = 0.213 W/kg

SAR(1 g) = 0.115 W/kg; SAR(10 g) = 0.060 W/kg

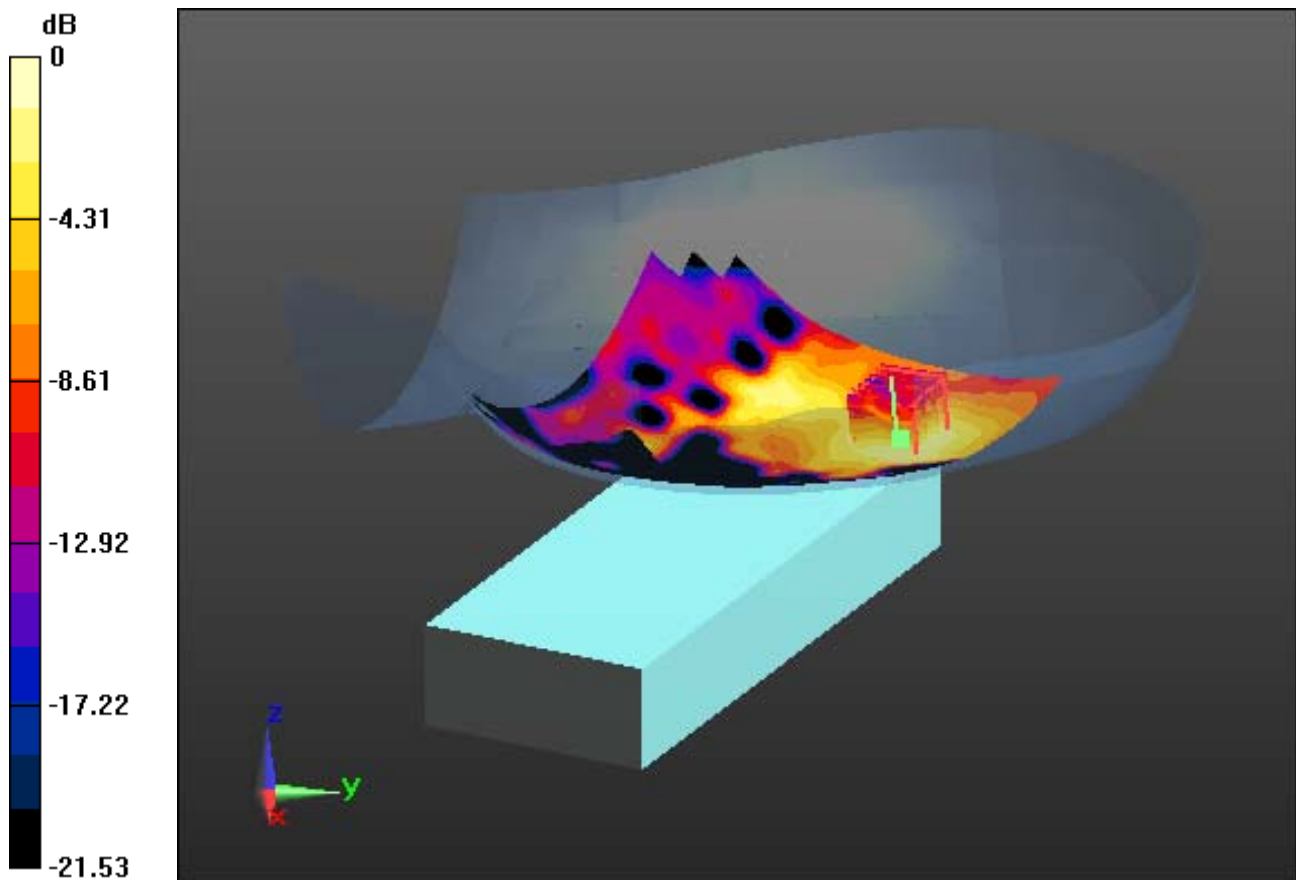

0 dB = 0.174 W/kg

DT&C Co., Ltd.

DUT: PM450; Type: PDA

Communication System: W-LAN_5200 (0); Frequency: 5260 MHz; Duty Cycle: 1:1
Medium parameters used: $f = 5260$ MHz; $\sigma = 4.631$ S/m; $\epsilon_r = 34.658$; $\rho = 1000$ kg/m³
Phantom section: Left Section

DASY5 Configuration:

Probe: EX3DV4 - SN3930; ConvF(4.81, 4.81, 4.81); Calibrated: 2014-07-22; Electronics: DAE4 Sn1394
Phantom: SAM with CRP_20120521; Type: SAM; Serial: 1679
Measurement SW: DASY52, Version 52.8 (7); SEMCAD X Version 14.6.10 (7164)

Test Date: 2014-10-07; Ambient Temp: 20.5; Tissue Temp: 20.8

Left Touch, W-LAN(802.11a 5.3G) Ch. 52, Ant Internal, Standard Battery

With Enlarge plot image

Area Scan (141x281x1): Interpolated grid: dx=10mm, dy=10mm
Zoom Scan (7x7x11)/Cube 0: Measurement grid: dx=4mm, dy=4mm, dz=2mm
Power Drift = -0.17 dB
Peak SAR (extrapolated) = 0.213 W/kg
SAR(1 g) = 0.115 W/kg; SAR(10 g) = 0.060 W/kg

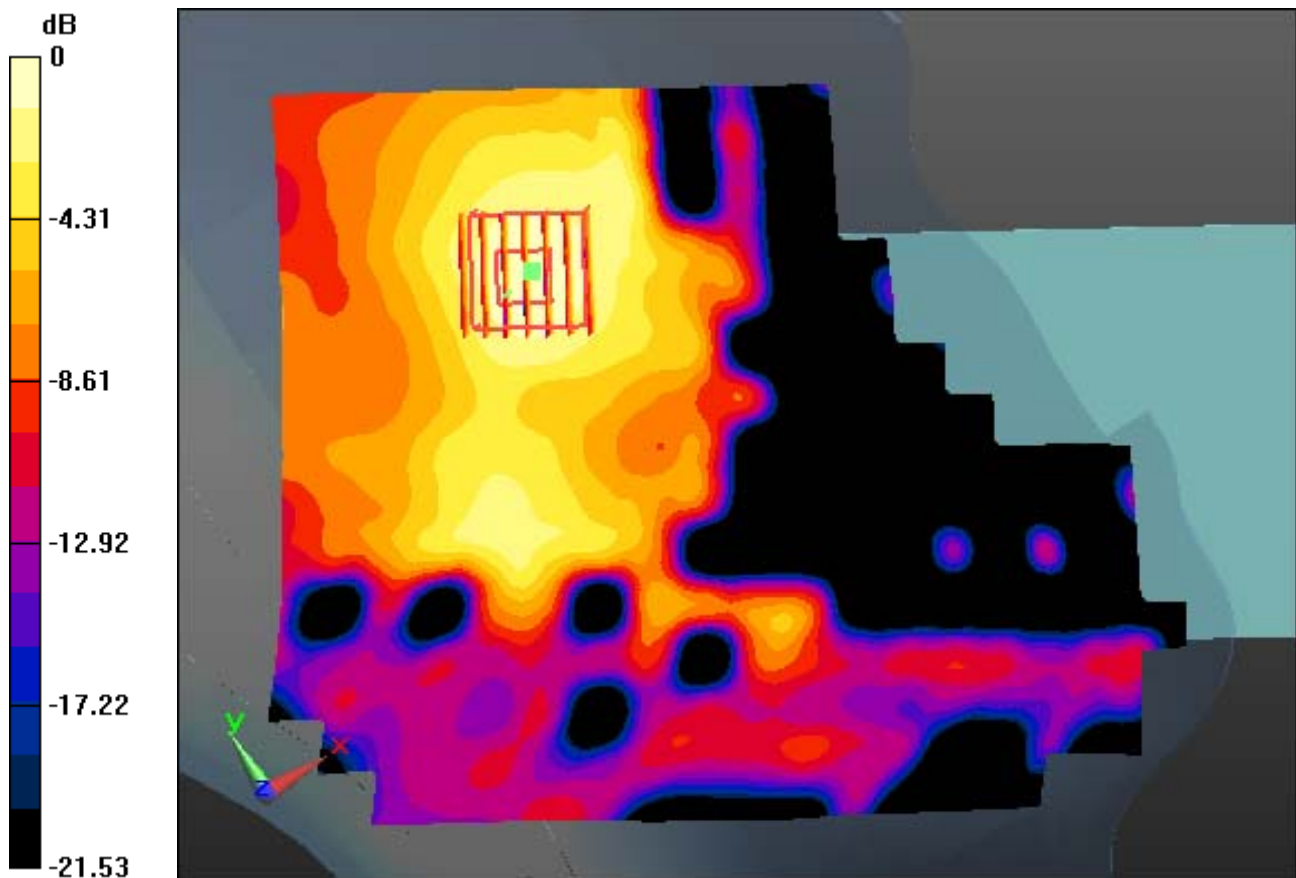

0 dB = 0.174 W/kg

DT&C Co., Ltd.

DUT: PM450; Type: PDA

Communication System: W-LAN_5200 (0); Frequency: 5260 MHz; Duty Cycle: 1:1
Medium parameters used: $f = 5260$ MHz; $\sigma = 4.631$ S/m; $\epsilon_r = 34.658$; $\rho = 1000$ kg/m³
Phantom section: Left Section

DASY5 Configuration:

Probe: EX3DV4 - SN3930; ConvF(4.81, 4.81, 4.81); Calibrated: 2014-07-22; Electronics: DAE4 Sn1394
Phantom: SAM with CRP_20120521; Type: SAM; Serial: 1679
Measurement SW: DASY52, Version 52.8 (7); SEMCAD X Version 14.6.10 (7164)

Test Date: 2014-10-07; Ambient Temp: 20.5; Tissue Temp: 20.8

Left Touch, W-LAN(802.11a 5.3G) Ch. 52, Ant Internal, Standard Battery

Area Scan (141x281x1): Interpolated grid: dx=10mm, dy=10mm
Zoom Scan (7x7x11)/Cube 0: Measurement grid: dx=4mm, dy=4mm, dz=2mm
Power Drift = -0.17 dB
Peak SAR (extrapolated) = 0.213 W/kg
SAR(1 g) = 0.115 W/kg; SAR(10 g) = 0.060 W/kg

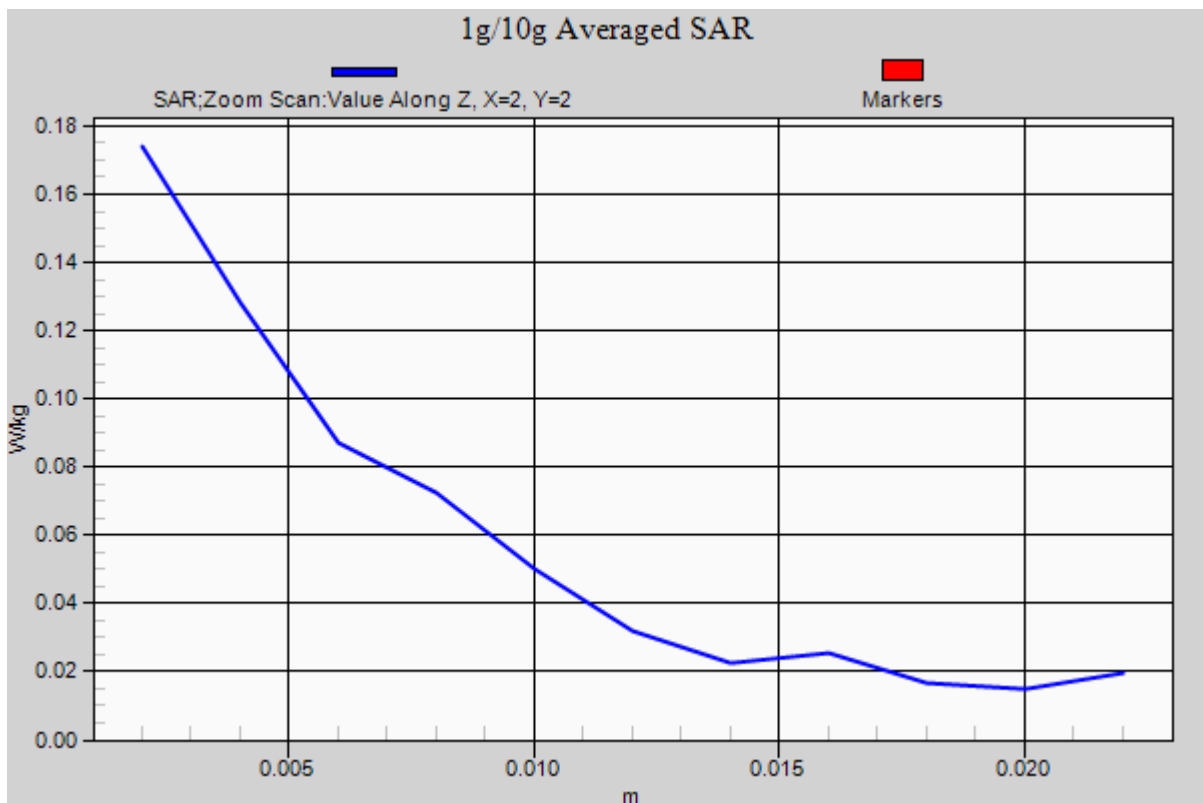

DT&C Co., Ltd.

DUT: PM450; Type: PDA

Communication System: W-LAN_5500 (0); Frequency: 5580 MHz; Duty Cycle: 1:1
Medium parameters used: $f = 5580$ MHz; $\sigma = 4.968$ S/m; $\epsilon_r = 34.912$; $\rho = 1000$ kg/m³
Phantom section: Left Section

DASY5 Configuration:

Probe: EX3DV4 - SN3930; ConvF(4.76, 4.76, 4.76); Calibrated: 2014-07-22; Electronics: DAE4 Sn1394
Phantom: SAM with CRP_20120521; Type: SAM; Serial: 1679
Measurement SW: DASY52, Version 52.8 (7); SEMCAD X Version 14.6.10 (7164)

Test Date: 2014-10-07; Ambient Temp: 20.5; Tissue Temp: 20.8

Left Touch, W-LAN(802.11a 5.6G) Ch. 116, Ant Internal, Standard Battery

Area Scan (141x281x1): Interpolated grid: dx=10mm, dy=10mm

Zoom Scan (7x7x11)/Cube 0: Measurement grid: dx=4mm, dy=4mm, dz=2mm

Power Drift = 0.01 dB

Peak SAR (extrapolated) = 0.223 W/kg

SAR(1 g) = 0.106 W/kg; SAR(10 g) = 0.051 W/kg

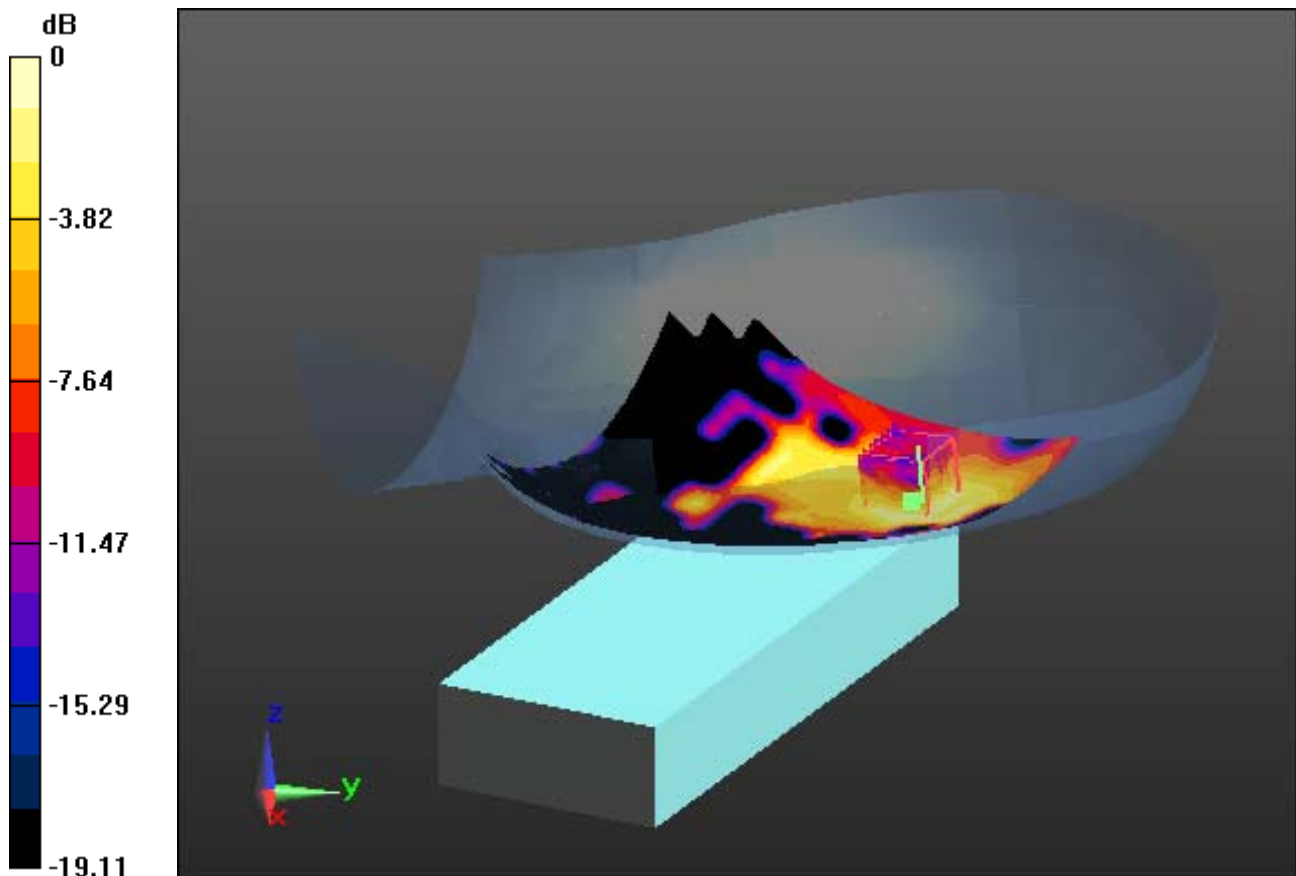

0 dB = 0.155 W/kg

DT&C Co., Ltd.

DUT: PM450; Type: PDA

Communication System: W-LAN_5500 (0); Frequency: 5580 MHz; Duty Cycle: 1:1
Medium parameters used: $f = 5580$ MHz; $\sigma = 4.968$ S/m; $\epsilon_r = 34.912$; $\rho = 1000$ kg/m³
Phantom section: Left Section

DASY5 Configuration:

Probe: EX3DV4 - SN3930; ConvF(4.76, 4.76, 4.76); Calibrated: 2014-07-22; Electronics: DAE4 Sn1394
Phantom: SAM with CRP_20120521; Type: SAM; Serial: 1679
Measurement SW: DASY52, Version 52.8 (7); SEMCAD X Version 14.6.10 (7164)

Test Date: 2014-10-07; Ambient Temp: 20.5; Tissue Temp: 20.8

Left Touch, W-LAN(802.11a 5.6G) Ch. 116, Ant Internal, Standard Battery

With Enlarge Plot image

Area Scan (141x281x1): Interpolated grid: dx=10mm, dy=10mm

Zoom Scan (7x7x11)/Cube 0: Measurement grid: dx=4mm, dy=4mm, dz=2mm

Power Drift = 0.01 dB

Peak SAR (extrapolated) = 0.223 W/kg

SAR(1 g) = 0.106 W/kg; SAR(10 g) = 0.051 W/kg

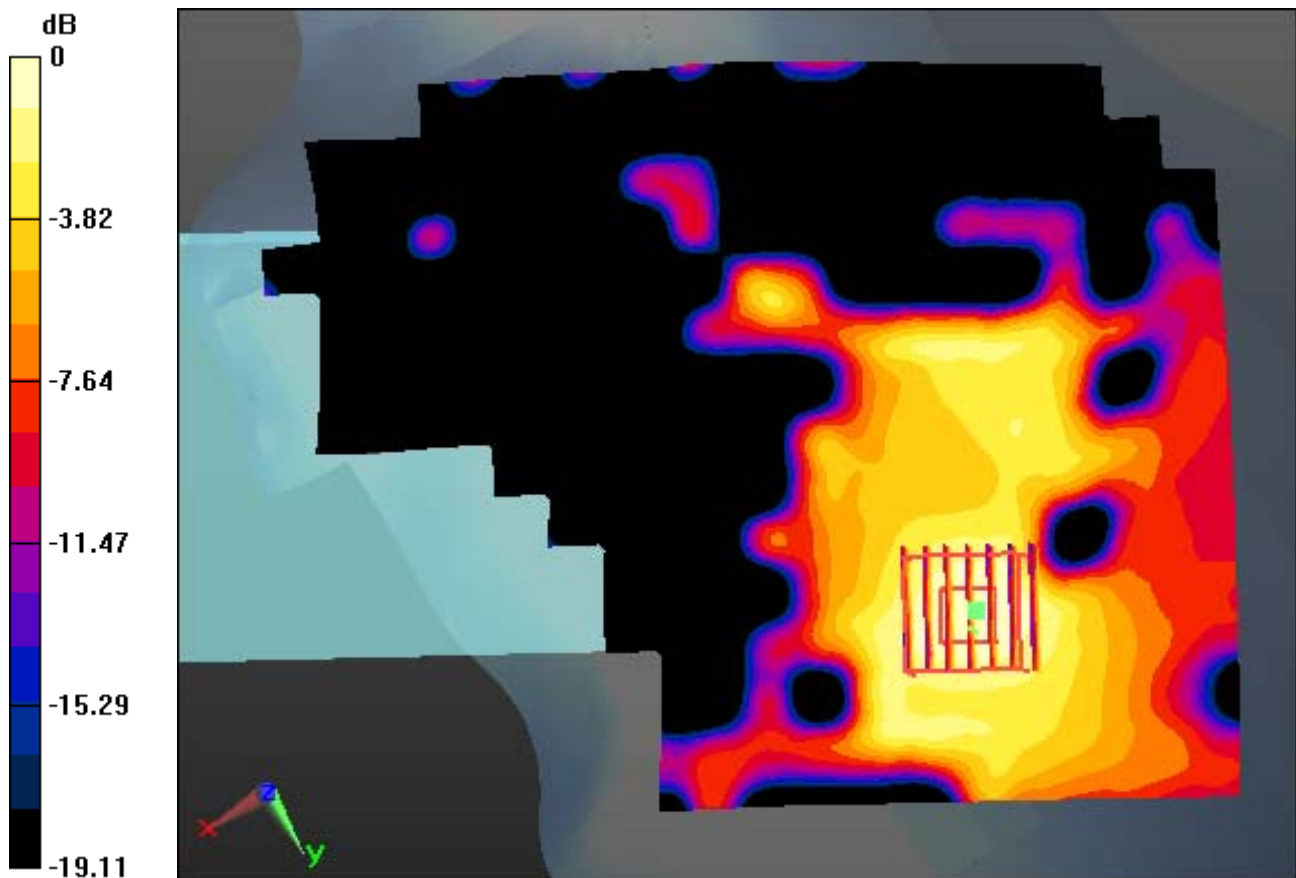

0 dB = 0.155 W/kg

DT&C Co., Ltd.

DUT: PM450; Type: PDA

Communication System: W-LAN_5500 (0); Frequency: 5580 MHz; Duty Cycle: 1:1
Medium parameters used: $f = 5580$ MHz; $\sigma = 4.968$ S/m; $\epsilon_r = 34.912$; $\rho = 1000$ kg/m³
Phantom section: Left Section

DASY5 Configuration:

Probe: EX3DV4 - SN3930; ConvF(4.76, 4.76, 4.76); Calibrated: 2014-07-22; Electronics: DAE4 Sn1394
Phantom: SAM with CRP_20120521; Type: SAM; Serial: 1679
Measurement SW: DASY52, Version 52.8 (7); SEMCAD X Version 14.6.10 (7164)

Test Date: 2014-10-07; Ambient Temp: 20.5; Tissue Temp: 20.8

Left Touch, W-LAN(802.11a 5.6G) Ch. 116, Ant Internal, Standard Battery

Area Scan (141x281x1): Interpolated grid: dx=10mm, dy=10mm
Zoom Scan (7x7x11)/Cube 0: Measurement grid: dx=4mm, dy=4mm, dz=2mm
Power Drift = 0.01 dB
Peak SAR (extrapolated) = 0.223 W/kg
SAR(1 g) = 0.106 W/kg; SAR(10 g) = 0.051 W/kg

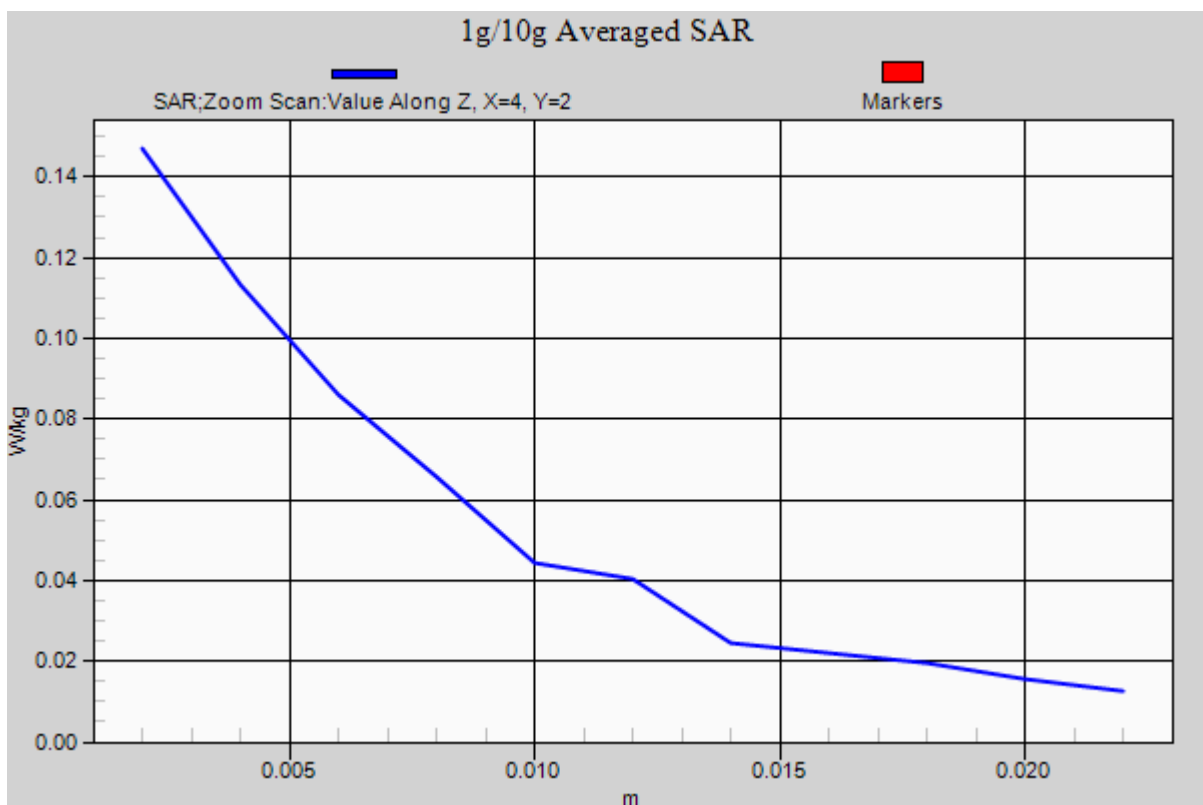

DT&C Co., Ltd.

DUT: PM450; Type: PDA

Communication System: W-LAN_5800 (0); Frequency: 5745 MHz; Duty Cycle: 1:1
Medium parameters used: $f = 5745$ MHz; $\sigma = 5.155$ S/m; $\epsilon_r = 34.65$; $\rho = 1000$ kg/m³

Phantom section: Left Section

DASY5 Configuration:

Probe: EX3DV4 - SN3930; ConvF(4.71, 4.71, 4.71); Calibrated: 2014-07-22; Electronics: DAE4 Sn1394
Phantom: SAM with CRP_20120521; Type: SAM; Serial: 1679
Measurement SW: DASY52, Version 52.8 (7); SEMCAD X Version 14.6.10 (7164)

Test Date: 2014-10-07; Ambient Temp: 20.5; Tissue Temp: 20.8

Left Touch, W-LAN(802.11a 5.8G) Ch. 149, Ant Internal, Standard Battery

Area Scan (141x281x1): Interpolated grid: dx=10mm, dy=10mm

Zoom Scan (7x7x11)/Cube 0: Measurement grid: dx=4mm, dy=4mm, dz=2mm

Power Drift = 0.19 dB

Peak SAR (extrapolated) = 0.207 W/kg

SAR(1 g) = 0.108 W/kg; SAR(10 g) = 0.056 W/kg

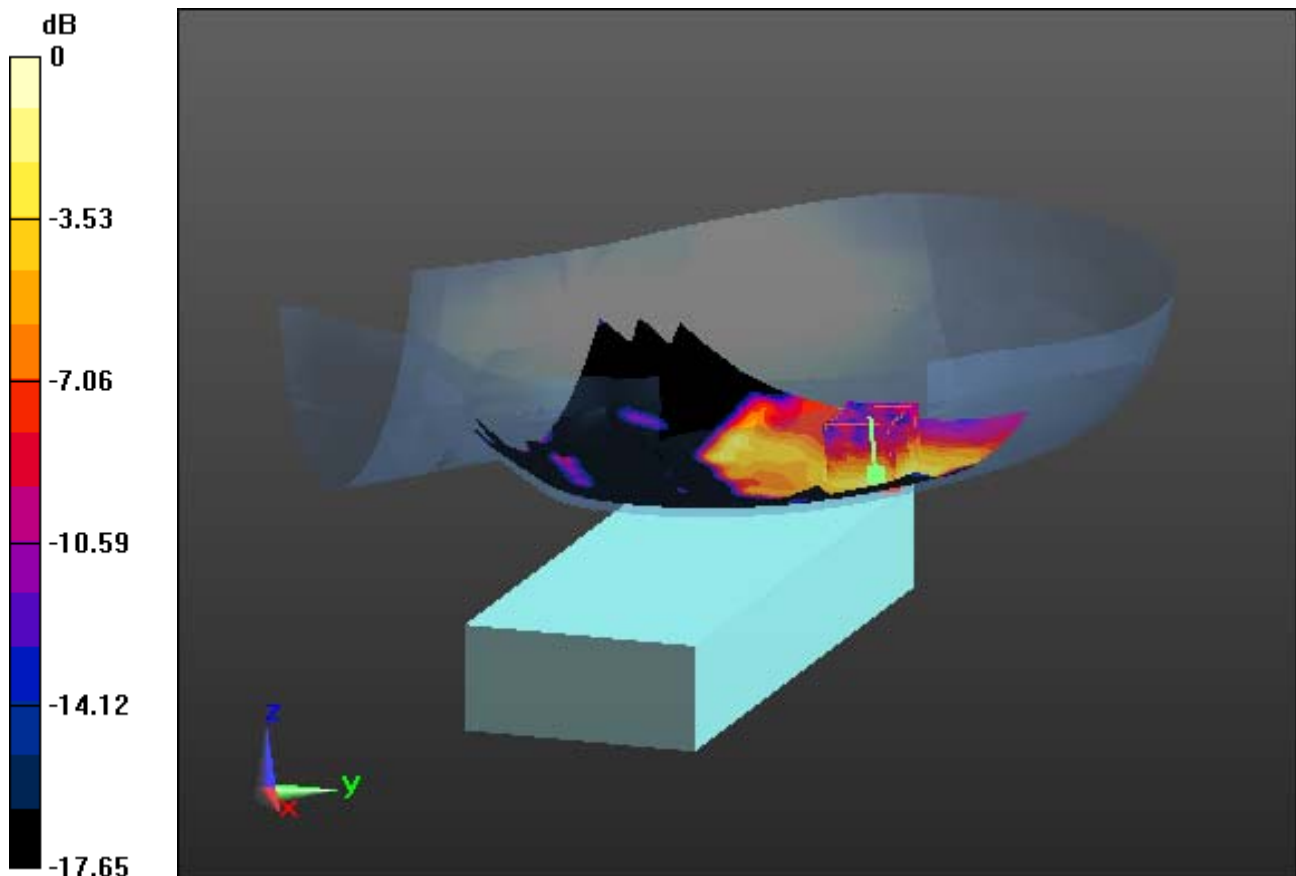

0 dB = 0.172 W/kg

DT&C Co., Ltd.

DUT: PM450; Type: PDA

Communication System: W-LAN_5800 (0); Frequency: 5745 MHz; Duty Cycle: 1:1
Medium parameters used: $f = 5745$ MHz; $\sigma = 5.155$ S/m; $\epsilon_r = 34.65$; $\rho = 1000$ kg/m³
Phantom section: Left Section

DASY5 Configuration:

Probe: EX3DV4 - SN3930; ConvF(4.71, 4.71, 4.71); Calibrated: 2014-07-22; Electronics: DAE4 Sn1394
Phantom: SAM with CRP_20120521; Type: SAM; Serial: 1679
Measurement SW: DASY52, Version 52.8 (7); SEMCAD X Version 14.6.10 (7164)

Test Date: 2014-10-07; Ambient Temp: 20.5; Tissue Temp: 20.8

Left Touch, W-LAN(802.11a 5.8G) Ch. 149, Ant Internal, Standard Battery

With Enlarge Plot image

Area Scan (141x281x1): Interpolated grid: dx=10mm, dy=10mm

Zoom Scan (7x7x11)/Cube 0: Measurement grid: dx=4mm, dy=4mm, dz=2mm

Power Drift = 0.19 dB

Peak SAR (extrapolated) = 0.207 W/kg

SAR(1 g) = 0.108 W/kg; SAR(10 g) = 0.056 W/kg

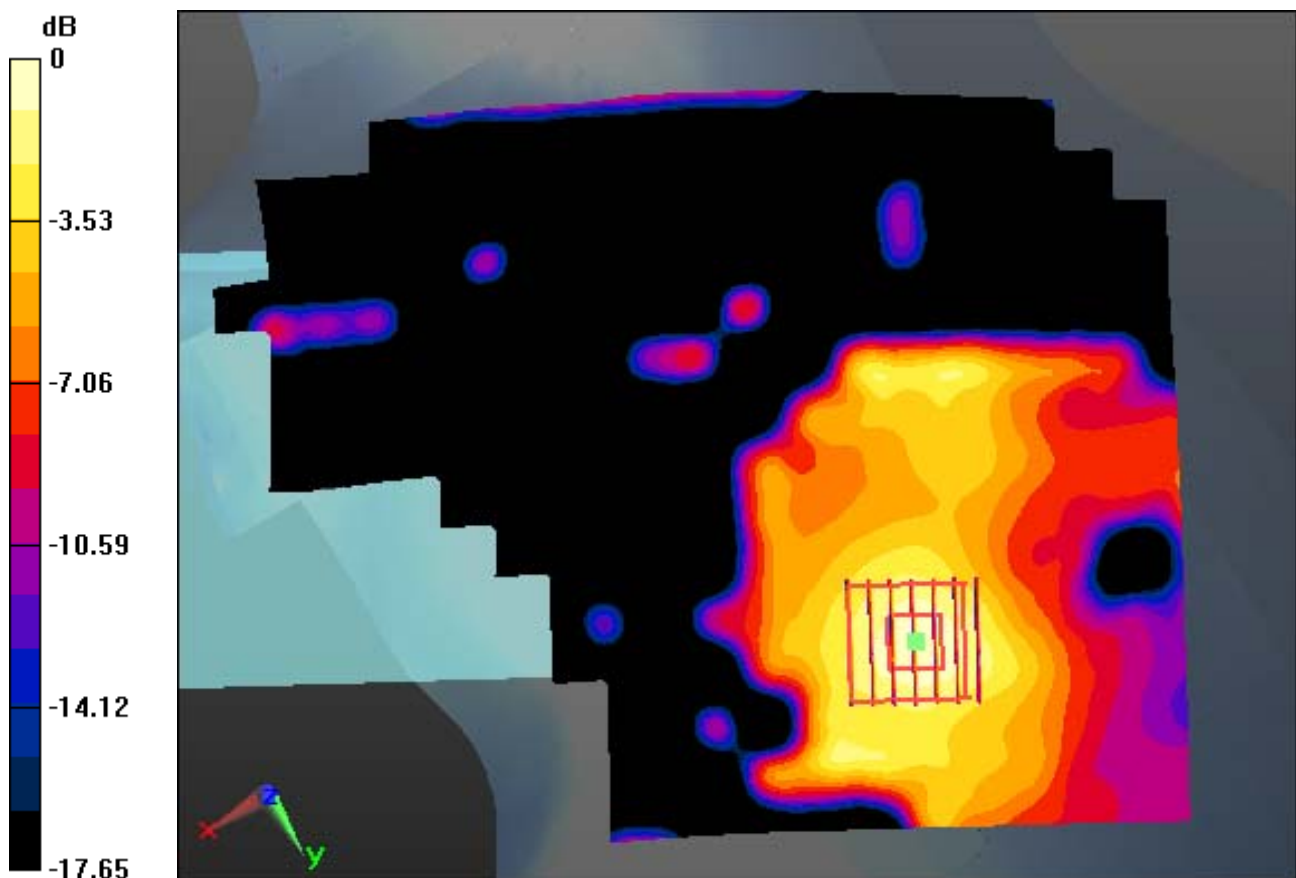

0 dB = 0.172 W/kg

DT&C Co., Ltd.

DUT: PM450; Type: PDA

Communication System: W-LAN_5800 (0); Frequency: 5745 MHz; Duty Cycle: 1:1
Medium parameters used: $f = 5745$ MHz; $\sigma = 5.155$ S/m; $\epsilon_r = 34.65$; $\rho = 1000$ kg/m³
Phantom section: Left Section

DASY5 Configuration:

Probe: EX3DV4 - SN3930; ConvF(4.71, 4.71, 4.71); Calibrated: 2014-07-22; Electronics: DAE4 Sn1394
Phantom: SAM with CRP_20120521; Type: SAM; Serial: 1679
Measurement SW: DASY52, Version 52.8 (7); SEMCAD X Version 14.6.10 (7164)

Test Date: 2014-10-07; Ambient Temp: 20.5; Tissue Temp: 20.8

Left Touch, W-LAN(802.11a 5.8G) Ch. 149, Ant Internal, Standard Battery

Area Scan (141x281x1): Interpolated grid: dx=10mm, dy=10mm
Zoom Scan (7x7x11)/Cube 0: Measurement grid: dx=4mm, dy=4mm, dz=2mm
Power Drift = 0.19 dB
Peak SAR (extrapolated) = 0.207 W/kg
SAR(1 g) = 0.108 W/kg; SAR(10 g) = 0.056 W/kg

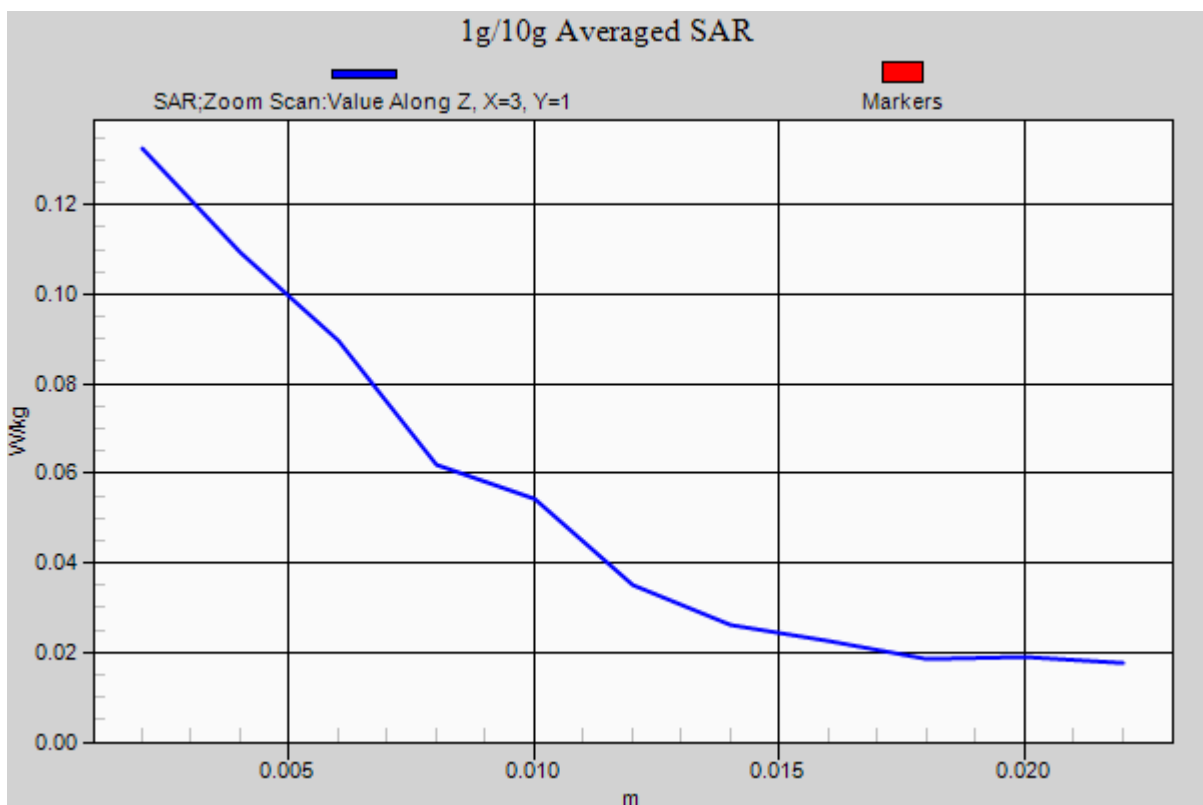

DT&C Co., Ltd.

DUT: PM450; Type: PDA

Communication System: W-LAN (0); Frequency: 2412 MHz; Duty Cycle: 1:1
Medium parameters used: $f = 2412$ MHz; $\sigma = 1.945$ S/m; $\epsilon_r = 51.449$; $\rho = 1000$ kg/m³
Phantom section: Flat Section

DASY5 Configuration:

Probe: EX3DV4 - SN3930; ConvF(7.12, 7.12, 7.12); Calibrated: 2014-07-22; Electronics: DAE4 Sn1394
Phantom: ELI v5.0; Type: QDOVA002AA; Serial: TP:1166
Measurement SW: DASY52, Version 52.8 (7); SEMCAD X Version 14.6.10 (7164)

Test Date: 2014-10-03; Ambient Temp: 20.4; Tissue Temp: 21.0

1cm space from Body, Front, W-LAN(802.11b) Ch. 1, Ant Internal

Area Scan (111x261x1): Interpolated grid: dx=12mm, dy=12mm

Zoom Scan (7x7x7)/Cube 0: Measurement grid: dx=5mm, dy=5mm, dz=5mm
Power Drift = 0.00 dB

Peak SAR (extrapolated) = 0.0580 W/kg

SAR(1 g) = 0.030 W/kg; SAR(10 g) = 0.015 W/kg

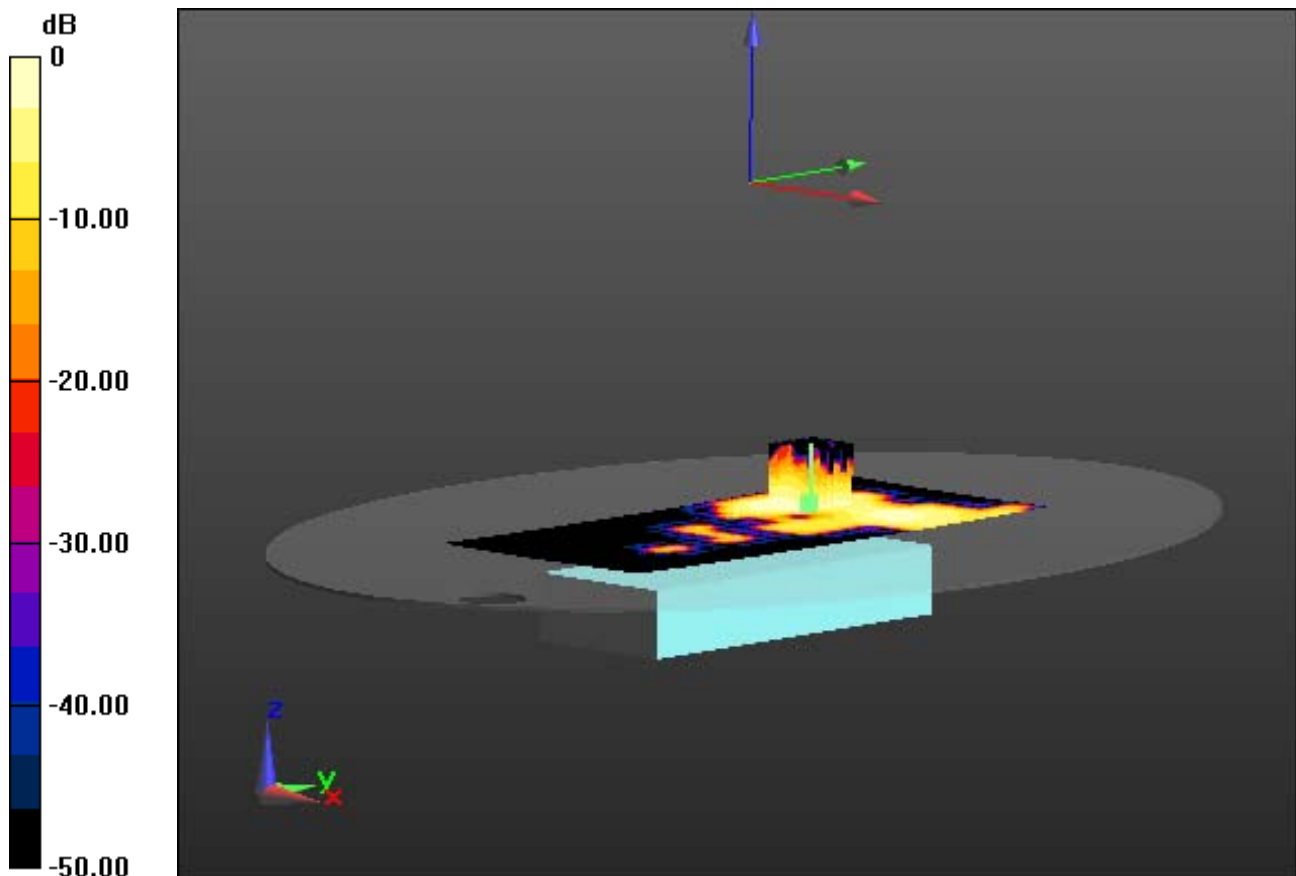

0 dB = 0.0431 W/kg

DT&C Co., Ltd.

DUT: PM450; Type: PDA

Communication System: W-LAN (0); Frequency: 2412 MHz; Duty Cycle: 1:1
Medium parameters used: $f = 2412$ MHz; $\sigma = 1.945$ S/m; $\epsilon_r = 51.449$; $\rho = 1000$ kg/m³
Phantom section: Flat Section

DASY5 Configuration:

Probe: EX3DV4 - SN3930; ConvF(7.12, 7.12, 7.12); Calibrated: 2014-07-22; Electronics: DAE4 Sn1394
Phantom: ELI v5.0; Type: QDOVA002AA; Serial: TP:1166
Measurement SW: DASY52, Version 52.8 (7); SEMCAD X Version 14.6.10 (7164)

Test Date: 2014-10-03; Ambient Temp: 20.4; Tissue Temp: 21.0

1cm space from Body, Front, W-LAN(802.11b) Ch. 1, Ant Internal

With Enlarge plot image

Area Scan (111x261x1): Interpolated grid: dx=12mm, dy=12mm

Zoom Scan (7x7x7)/Cube 0: Measurement grid: dx=5mm, dy=5mm, dz=5mm

Power Drift = 0.00 dB

Peak SAR (extrapolated) = 0.0580 W/kg

SAR(1 g) = 0.030 W/kg; SAR(10 g) = 0.015 W/kg

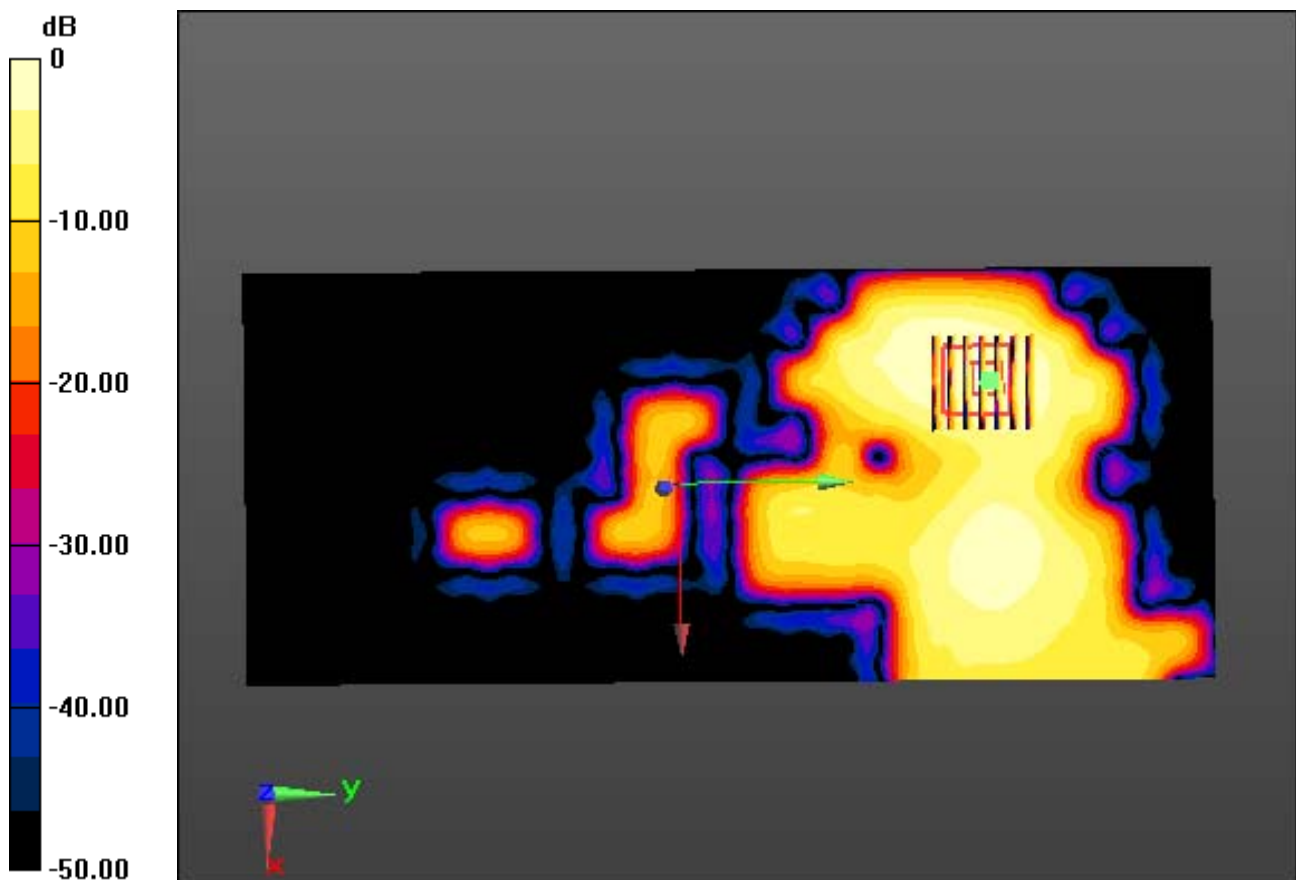

0 dB = 0.0431 W/kg

DT&C Co., Ltd.

DUT: PM450; Type: PDA

Communication System: W-LAN (0); Frequency: 2412 MHz; Duty Cycle: 1:1
Medium parameters used: $f = 2412$ MHz; $\sigma = 1.945$ S/m; $\epsilon_r = 51.449$; $\rho = 1000$ kg/m³
Phantom section: Flat Section

DASY5 Configuration:

Probe: EX3DV4 - SN3930; ConvF(7.12, 7.12, 7.12); Calibrated: 2014-07-22; Electronics: DAE4 Sn1394
Phantom: ELI v5.0; Type: QDOVA002AA; Serial: TP:1166
Measurement SW: DASY52, Version 52.8 (7); SEMCAD X Version 14.6.10 (7164)

Test Date: 2014-10-03; Ambient Temp: 20.4; Tissue Temp: 21.0

1cm space from Body, Front, W-LAN(802.11b) Ch. 1, Ant Internal

Area Scan (111x261x1): Interpolated grid: dx=12mm, dy=12mm
Zoom Scan (7x7x7)/Cube 0: Measurement grid: dx=5mm, dy=5mm, dz=5mm
Power Drift = 0.00 dB
Peak SAR (extrapolated) = 0.0580 W/kg
SAR(1 g) = 0.030 W/kg; SAR(10 g) = 0.015 W/kg

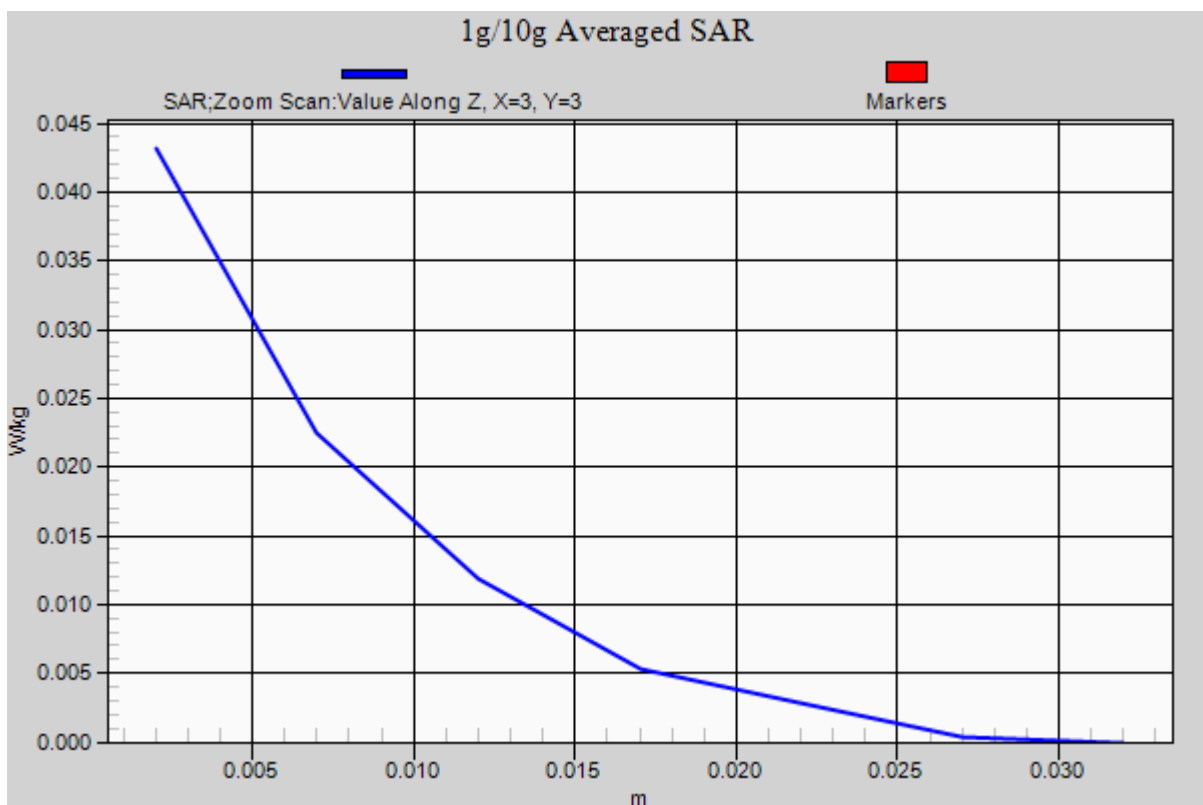

DT&C Co., Ltd.

DUT: PM450; Type: PDA

Communication System: W-LAN_5200 (0); Frequency: 5180 MHz; Duty Cycle: 1:1
Medium parameters used: $f = 5180$ MHz; $\sigma = 5.215$ S/m; $\epsilon_r = 47.938$; $\rho = 1000$ kg/m³
Phantom section: Flat Section

DASY5 Configuration:

Probe: EX3DV4 - SN3930; ConvF(4.67, 4.67, 4.67); Calibrated: 2014-07-22; Electronics: DAE4 Sn1394
Phantom: ELI v5.0; Type: QDOVA002AA; Serial: TP:1166
Measurement SW: DASY52, Version 52.8 (7); SEMCAD X Version 14.6.10 (7164)

Test Date: 2014-10-02; Ambient Temp: 20.1; Tissue Temp: 20.5

1cm space from Body, Front, W-LAN(802.11a 5.2G) Ch. 36, Ant Internal

Area Scan (141x321x1): Interpolated grid: dx=10mm, dy=10mm

Zoom Scan (7x7x11)/Cube 0: Measurement grid: dx=4mm, dy=4mm, dz=2mm
Power Drift = 0.00 dB

Peak SAR (extrapolated) = 0.200 W/kg

SAR(1 g) = 0.015 W/kg; SAR(10 g) = 0.00288 W/kg

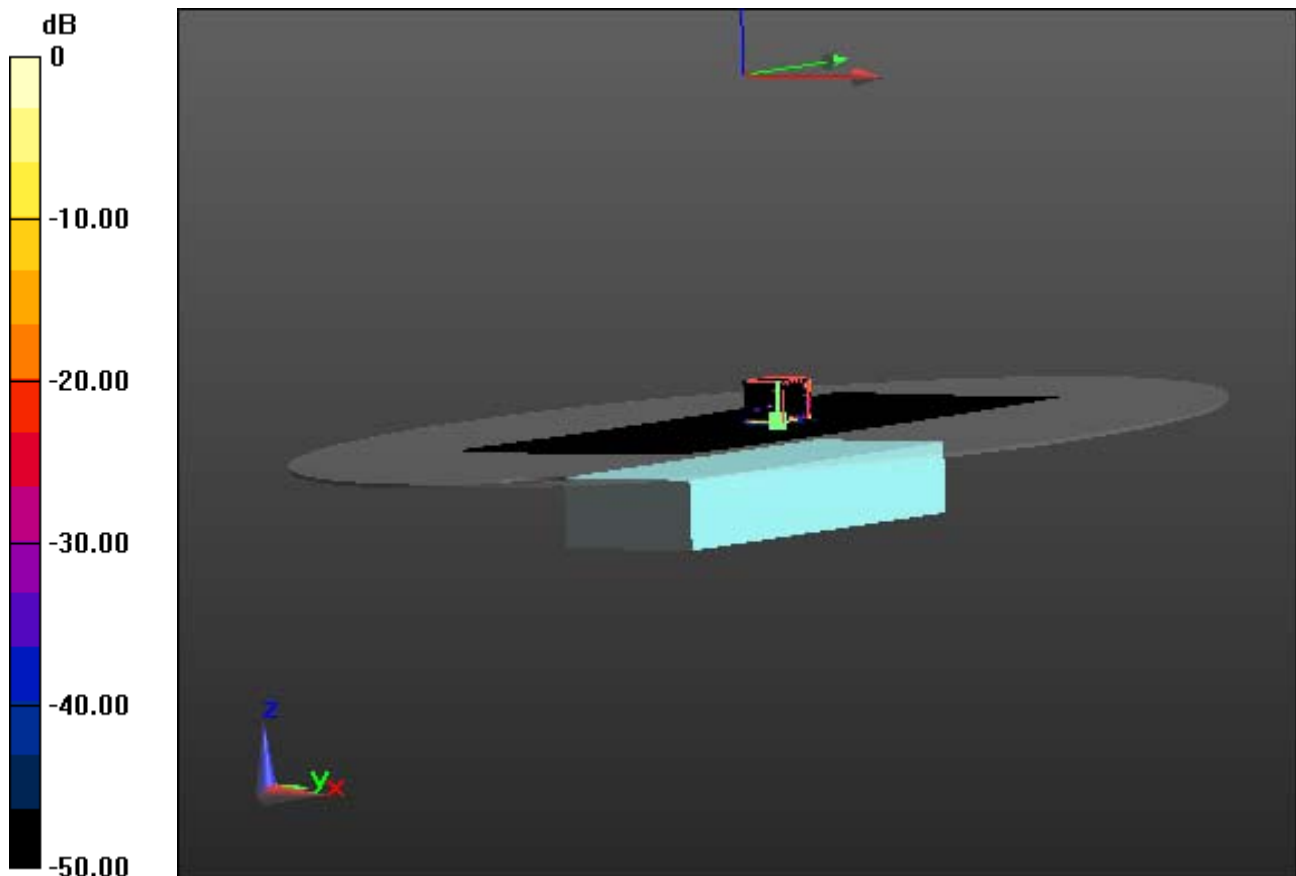

0 dB = 0.0242 W/kg

DT&C Co., Ltd.

DUT: PM450; Type: PDA

Communication System: W-LAN_5200 (0); Frequency: 5180 MHz; Duty Cycle: 1:1
Medium parameters used: $f = 5180$ MHz; $\sigma = 5.215$ S/m; $\epsilon_r = 47.938$; $\rho = 1000$ kg/m³
Phantom section: Flat Section

DASY5 Configuration:

Probe: EX3DV4 - SN3930; ConvF(4.67, 4.67, 4.67); Calibrated: 2014-07-22; Electronics: DAE4 Sn1394
Phantom: ELI v5.0; Type: QDOVA002AA; Serial: TP:1166
Measurement SW: DASY52, Version 52.8 (7); SEMCAD X Version 14.6.10 (7164)

Test Date: 2014-10-02; Ambient Temp: 20.1; Tissue Temp: 20.5

1cm sapce from Body, Front, W-LAN(802.11a 5.2G) Ch. 36, Ant Internal

With Enlarge plot image

Area Scan (141x321x1): Interpolated grid: dx=10mm, dy=10mm
Zoom Scan (7x7x11)/Cube 0: Measurement grid: dx=4mm, dy=4mm, dz=2mm
Power Drift = 0.00 dB
Peak SAR (extrapolated) = 0.200 W/kg
SAR(1 g) = 0.015 W/kg; SAR(10 g) = 0.00288 W/kg

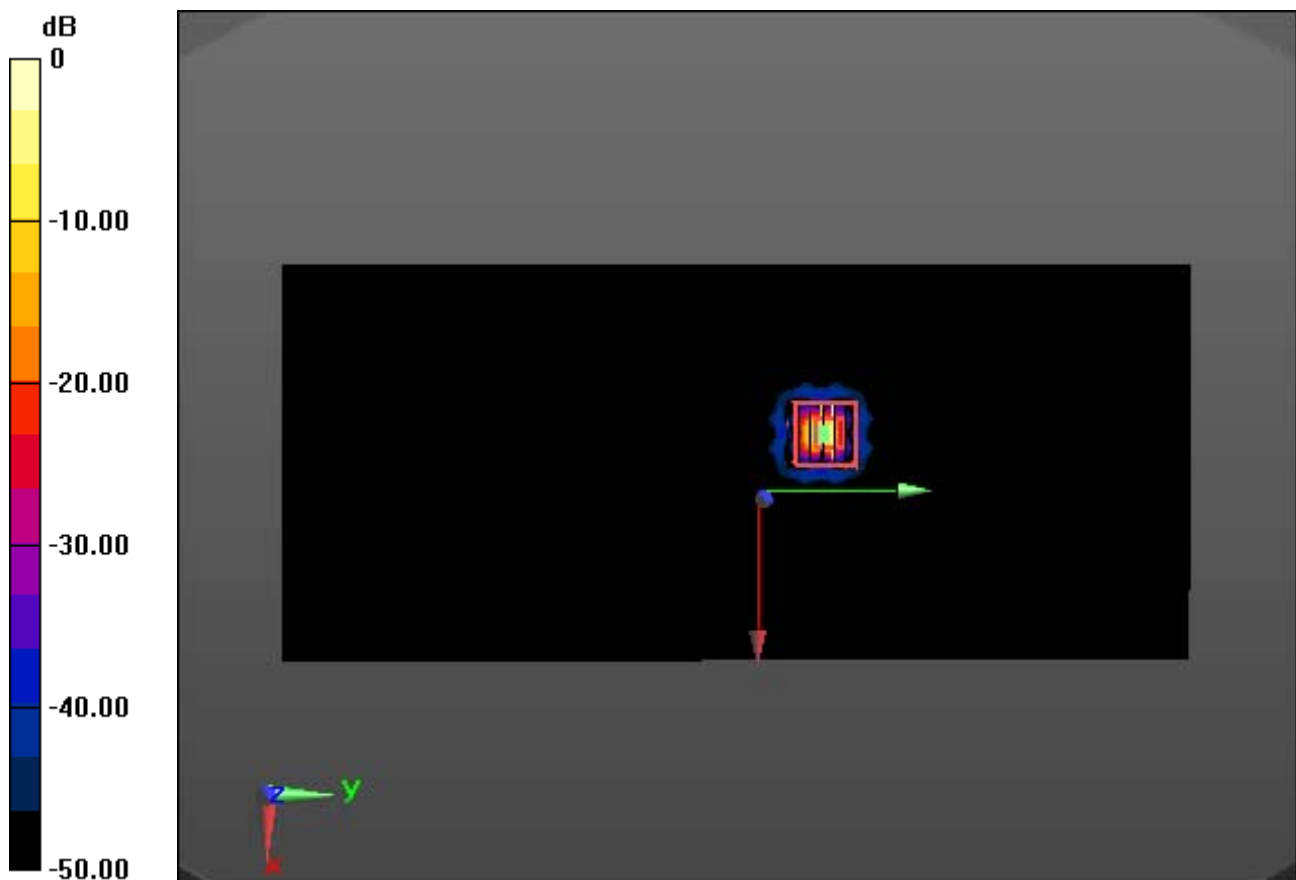

0 dB = 0.0242 W/kg

DT&C Co., Ltd.

DUT: PM450; Type: PDA

Communication System: W-LAN_5200 (0); Frequency: 5180 MHz; Duty Cycle: 1:1
Medium parameters used: $f = 5180$ MHz; $\sigma = 5.215$ S/m; $\epsilon_r = 47.938$; $\rho = 1000$ kg/m³
Phantom section: Flat Section

DASY5 Configuration:

Probe: EX3DV4 - SN3930; ConvF(4.67, 4.67, 4.67); Calibrated: 2014-07-22; Electronics: DAE4 Sn1394
Phantom: ELI v5.0; Type: QDOVA002AA; Serial: TP:1166
Measurement SW: DASY52, Version 52.8 (7); SEMCAD X Version 14.6.10 (7164)

Test Date: 2014-10-02; Ambient Temp: 20.1; Tissue Temp: 20.5

1cm space from Body, Front, W-LAN(802.11a 5.2G) Ch. 36, Ant Internal

Area Scan (141x321x1): Interpolated grid: dx=10mm, dy=10mm
Zoom Scan (7x7x11)/Cube 0: Measurement grid: dx=4mm, dy=4mm, dz=2mm
Power Drift = 0.00 dB
Peak SAR (extrapolated) = 0.200 W/kg
SAR(1 g) = 0.015 W/kg; SAR(10 g) = 0.00288 W/kg

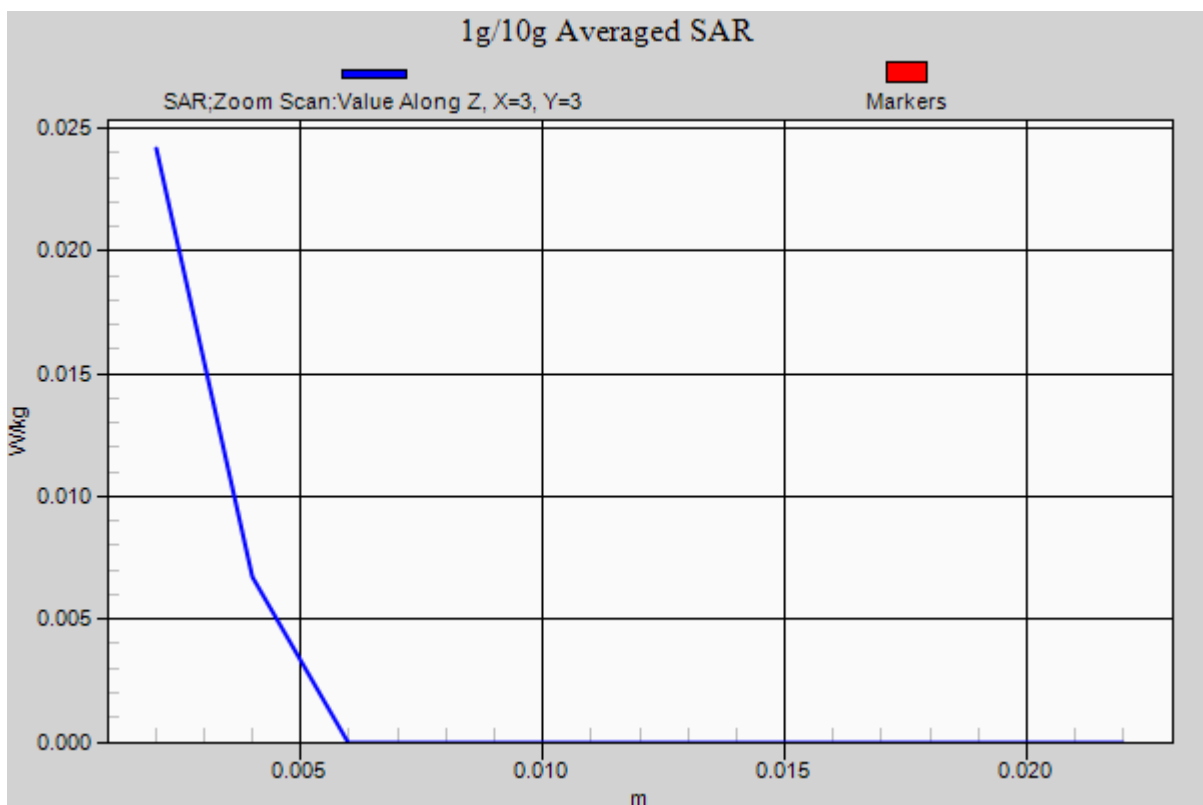

DT&C Co., Ltd.

DUT: PM450; Type: PDA

Communication System: W-LAN_5200 (0); Frequency: 5260 MHz; Duty Cycle: 1:1
Medium parameters used: $f = 5260$ MHz; $\sigma = 5.322$ S/m; $\epsilon_r = 47.787$; $\rho = 1000$ kg/m³
Phantom section: Flat Section

DASY5 Configuration:

Probe: EX3DV4 - SN3930; ConvF(4.49, 4.49, 4.49); Calibrated: 2014-07-22; Electronics: DAE4 Sn1394
Phantom: ELI v5.0; Type: QDOVA002AA; Serial: TP:1166
Measurement SW: DASY52, Version 52.8 (7); SEMCAD X Version 14.6.10 (7164)

Test Date: 2014-10-02; Ambient Temp: 20.1; Tissue Temp: 20.5

1cm space from Body, Front, W-LAN(802.11a 5.3G) Ch. 52, Ant Internal

Area Scan (141x321x1): Interpolated grid: dx=10mm, dy=10mm

Zoom Scan (7x7x11)/Cube 0: Measurement grid: dx=4mm, dy=4mm, dz=2mm
Power Drift = 0.00 dB

Peak SAR (extrapolated) = 0.217 W/kg

SAR(1 g) = 0.018 W/kg; SAR(10 g) = 0.00357 W/kg

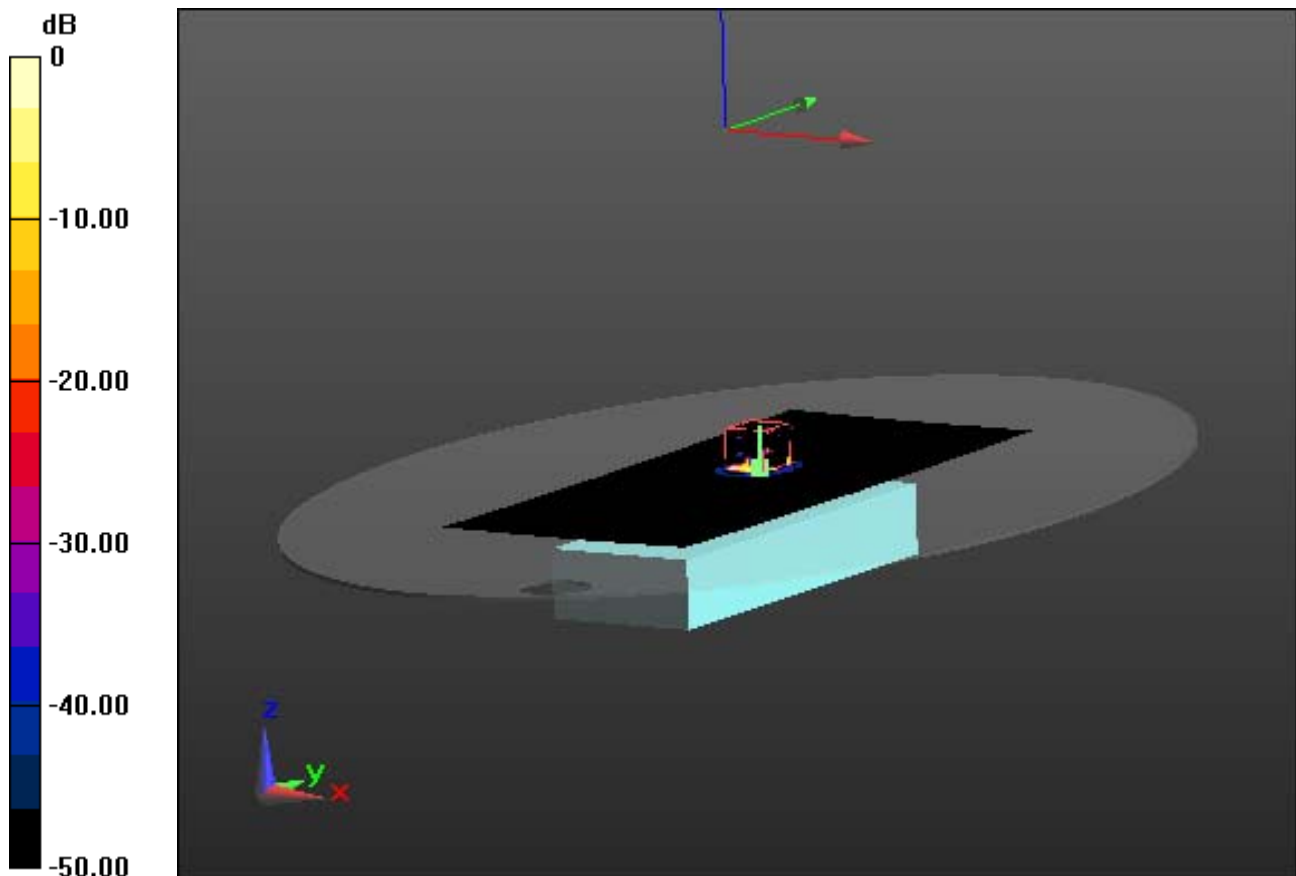

0 dB = 0.0256 W/kg

DT&C Co., Ltd.

DUT: PM450; Type: PDA

Communication System: W-LAN_5200 (0); Frequency: 5260 MHz; Duty Cycle: 1:1
Medium parameters used: $f = 5260$ MHz; $\sigma = 5.322$ S/m; $\epsilon_r = 47.787$; $\rho = 1000$ kg/m³
Phantom section: Flat Section

DASY5 Configuration:

Probe: EX3DV4 - SN3930; ConvF(4.49, 4.49, 4.49); Calibrated: 2014-07-22; Electronics: DAE4 Sn1394
Phantom: ELI v5.0; Type: QDOVA002AA; Serial: TP:1166
Measurement SW: DASY52, Version 52.8 (7); SEMCAD X Version 14.6.10 (7164)

Test Date: 2014-10-02; Ambient Temp: 20.1; Tissue Temp: 20.5

1cm space from Body, Front, W-LAN(802.11a 5.3G) Ch. 52, Ant Internal

With Enlarge Plot image

Area Scan (141x321x1): Interpolated grid: dx=10mm, dy=10mm
Zoom Scan (7x7x11)/Cube 0: Measurement grid: dx=4mm, dy=4mm, dz=2mm
Power Drift = 0.00 dB
Peak SAR (extrapolated) = 0.217 W/kg
SAR(1 g) = 0.018 W/kg; SAR(10 g) = 0.00357 W/kg

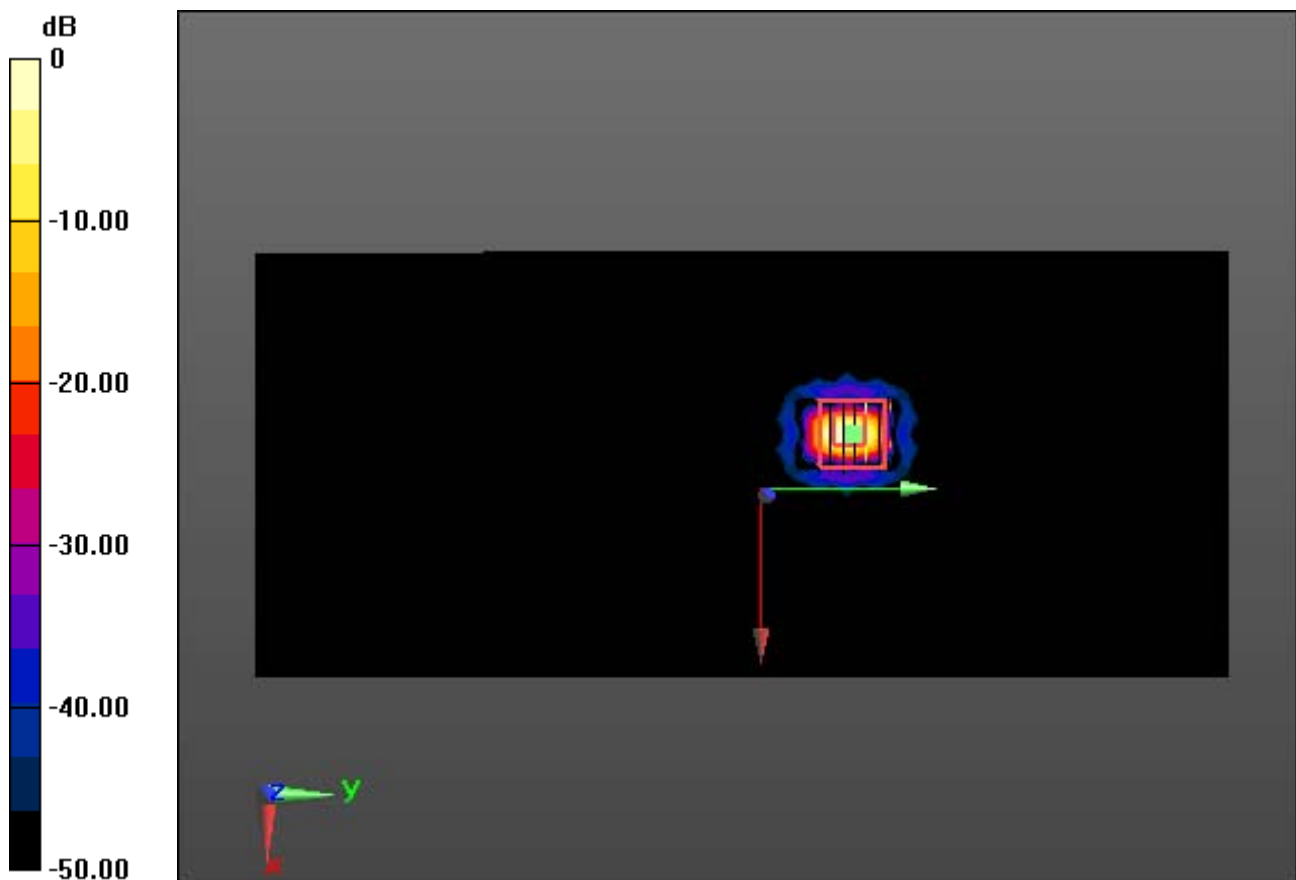

0 dB = 0.0256 W/kg

DT&C Co., Ltd.

DUT: PM450; Type: PDA

Communication System: W-LAN_5200 (0); Frequency: 5260 MHz; Duty Cycle: 1:1
Medium parameters used: $f = 5260$ MHz; $\sigma = 5.322$ S/m; $\epsilon_r = 47.787$; $\rho = 1000$ kg/m³
Phantom section: Flat Section

DASY5 Configuration:

Probe: EX3DV4 - SN3930; ConvF(4.49, 4.49, 4.49); Calibrated: 2014-07-22; Electronics: DAE4 Sn1394
Phantom: ELI v5.0; Type: QDOVA002AA; Serial: TP:1166
Measurement SW: DASY52, Version 52.8 (7); SEMCAD X Version 14.6.10 (7164)

Test Date: 2014-10-02; Ambient Temp: 20.1; Tissue Temp: 20.5

1cm space from Body, Front, W-LAN(802.11a 5.3G) Ch. 52, Ant Internal

Area Scan (141x321x1): Interpolated grid: dx=10mm, dy=10mm
Zoom Scan (7x7x11)/Cube 0: Measurement grid: dx=4mm, dy=4mm, dz=2mm
Power Drift = 0.00 dB
Peak SAR (extrapolated) = 0.217 W/kg
SAR(1 g) = 0.018 W/kg; SAR(10 g) = 0.00357 W/kg

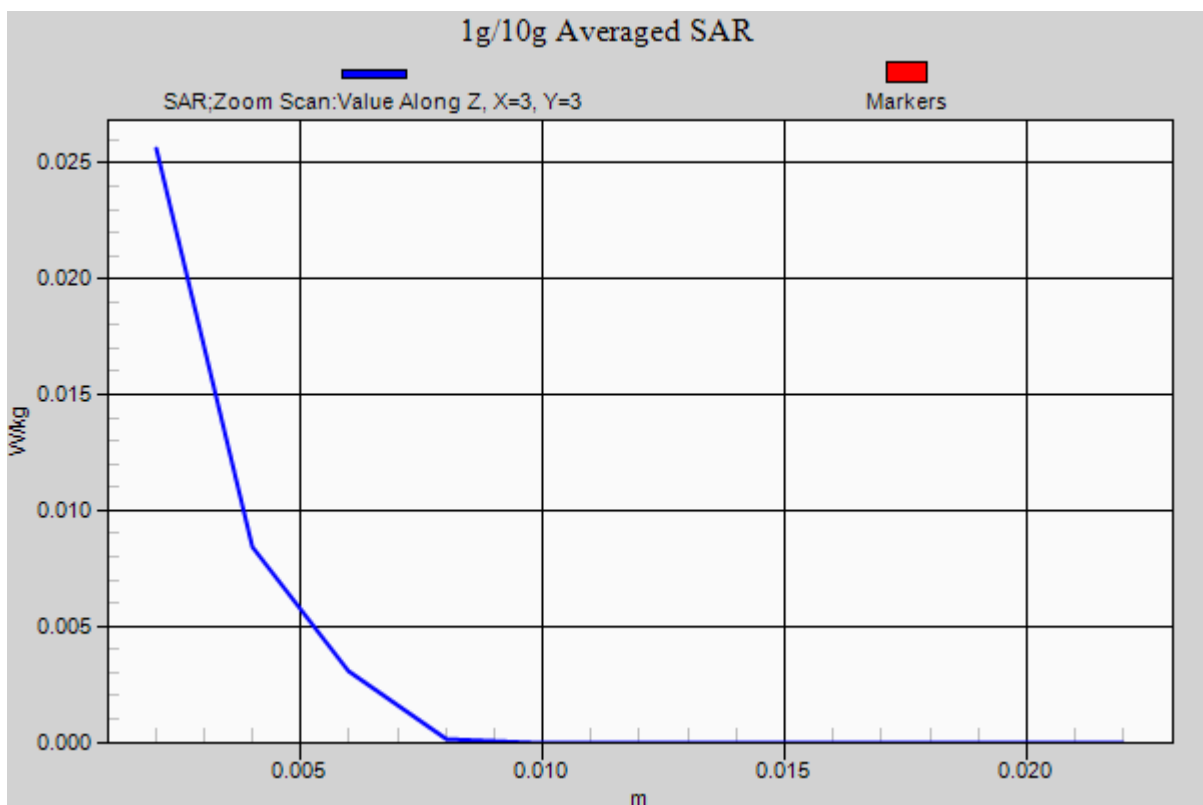

DT&C Co., Ltd.

DUT: PM450; Type: PDA

Communication System: W-LAN_5500 (0); Frequency: 5580 MHz; Duty Cycle: 1:1
Medium parameters used: $f = 5580$ MHz; $\sigma = 5.734$ S/m; $\epsilon_r = 47.241$; $\rho = 1000$ kg/m³
Phantom section: Flat Section

DASY5 Configuration:

Probe: EX3DV4 - SN3930; ConvF(4.06, 4.06, 4.06); Calibrated: 2014-07-22; Electronics: DAE4 Sn1394
Phantom: ELI v5.0; Type: QDOVA002AA; Serial: TP:1166
Measurement SW: DASY52, Version 52.8 (7); SEMCAD X Version 14.6.10 (7164)

Test Date: 2014-10-02; Ambient Temp: 20.1; Tissue Temp: 20.5

1cm space from Body, Front, W-LAN(802.11a 5.6G) Ch. 116, Ant Internal

Area Scan (141x321x1): Interpolated grid: dx=10mm, dy=10mm

Zoom Scan (7x7x11)/Cube 0: Measurement grid: dx=4mm, dy=4mm, dz=2mm

Power Drift = 0.00 dB

Peak SAR (extrapolated) = 0.201 W/kg

SAR(1 g) = 0.012 W/kg; SAR(10 g) = 0.00203 W/kg

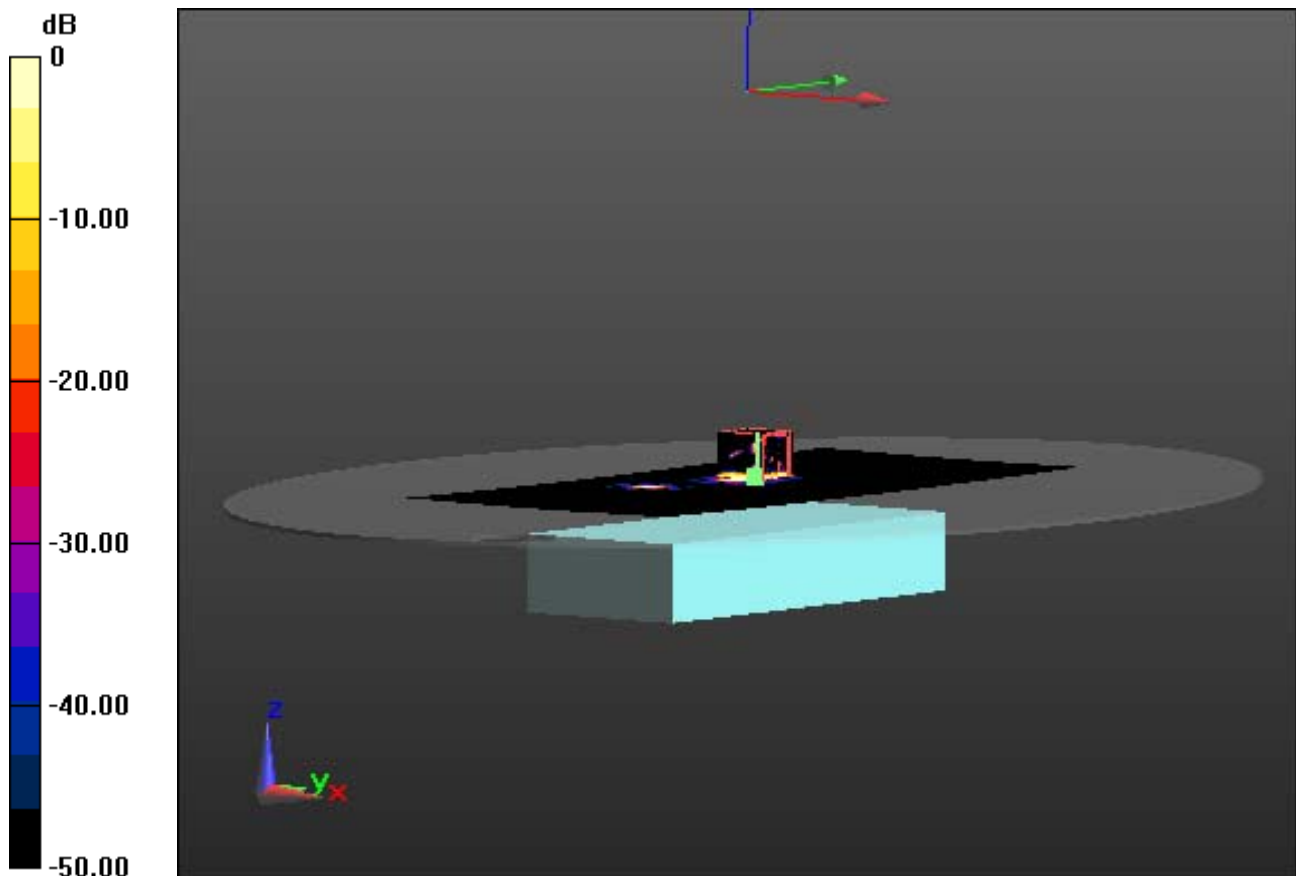

0 dB = 0.0261 W/kg

DT&C Co., Ltd.

DUT: PM450; Type: PDA

Communication System: W-LAN_5500 (0); Frequency: 5580 MHz; Duty Cycle: 1:1
Medium parameters used: $f = 5580$ MHz; $\sigma = 5.734$ S/m; $\epsilon_r = 47.241$; $\rho = 1000$ kg/m³
Phantom section: Flat Section

DASY5 Configuration:

Probe: EX3DV4 - SN3930; ConvF(4.06, 4.06, 4.06); Calibrated: 2014-07-22; Electronics: DAE4 Sn1394
Phantom: ELI v5.0; Type: QDOVA002AA; Serial: TP:1166
Measurement SW: DASY52, Version 52.8 (7); SEMCAD X Version 14.6.10 (7164)

Test Date: 2014-10-02; Ambient Temp: 20.1; Tissue Temp: 20.5

1cm space from Body, Front, W-LAN(802.11a 5.6G) Ch. 116, Ant Internal

With Enlarge Plot image

Area Scan (141x321x1): Interpolated grid: dx=10mm, dy=10mm

Zoom Scan (7x7x11)/Cube 0: Measurement grid: dx=4mm, dy=4mm, dz=2mm

Power Drift = 0.00 dB

Peak SAR (extrapolated) = 0.201 W/kg

SAR(1 g) = 0.012 W/kg; SAR(10 g) = 0.00203 W/kg

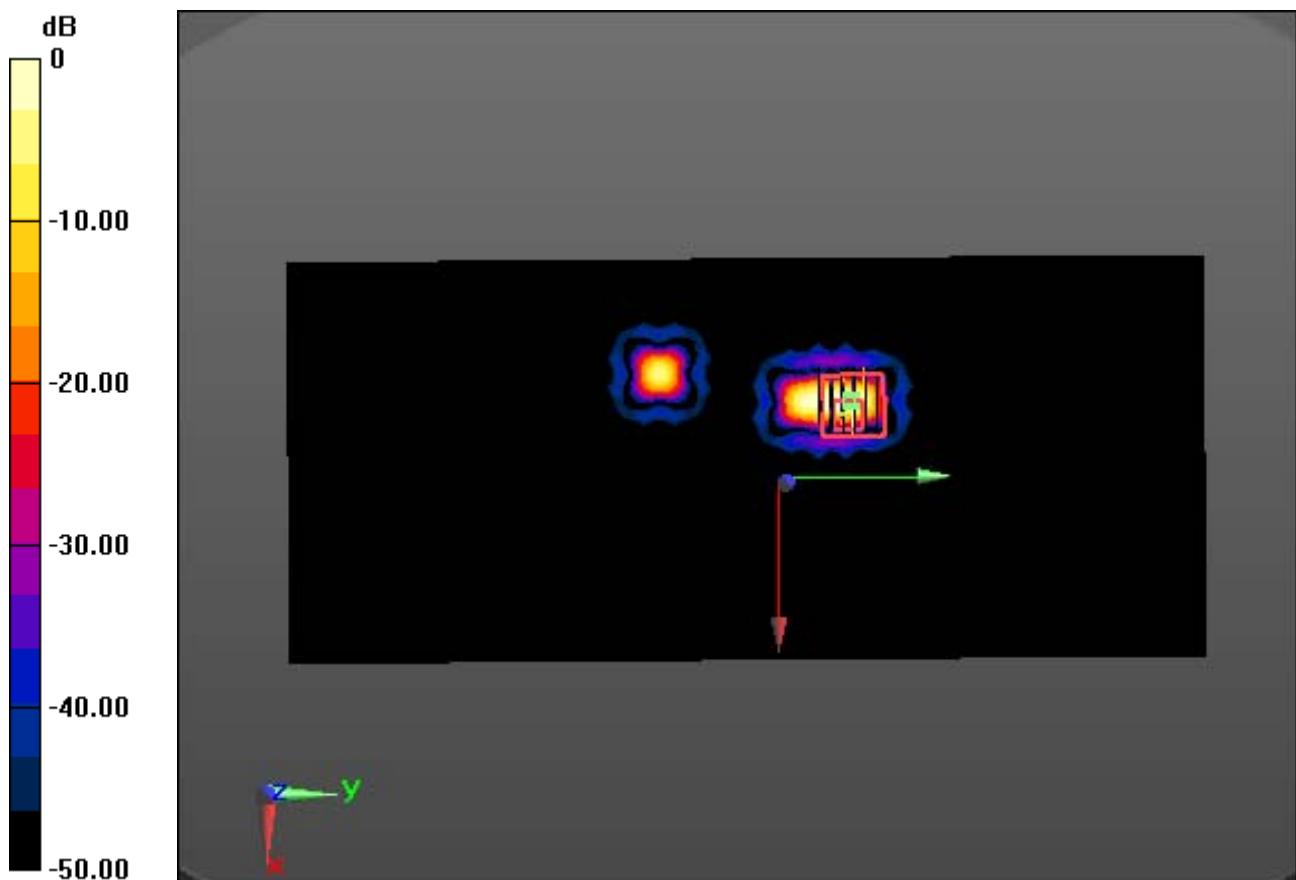

0 dB = 0.0261 W/kg

DT&C Co., Ltd.

DUT: PM450; Type: PDA

Communication System: W-LAN_5500 (0); Frequency: 5580 MHz; Duty Cycle: 1:1
Medium parameters used: $f = 5580$ MHz; $\sigma = 5.734$ S/m; $\epsilon_r = 47.241$; $\rho = 1000$ kg/m³
Phantom section: Flat Section

DASY5 Configuration:

Probe: EX3DV4 - SN3930; ConvF(4.06, 4.06, 4.06); Calibrated: 2014-07-22; Electronics: DAE4 Sn1394
Phantom: ELI v5.0; Type: QDOVA002AA; Serial: TP:1166
Measurement SW: DASY52, Version 52.8 (7); SEMCAD X Version 14.6.10 (7164)

Test Date: 2014-10-02; Ambient Temp: 20.1; Tissue Temp: 20.5

1cm space from Body, Front, W-LAN(802.11a 5.6G) Ch. 116, Ant Internal

Area Scan (141x321x1): Interpolated grid: dx=10mm, dy=10mm
Zoom Scan (7x7x11)/Cube 0: Measurement grid: dx=4mm, dy=4mm, dz=2mm
Power Drift = 0.00 dB
Peak SAR (extrapolated) = 0.201 W/kg
SAR(1 g) = 0.012 W/kg; SAR(10 g) = 0.00203 W/kg

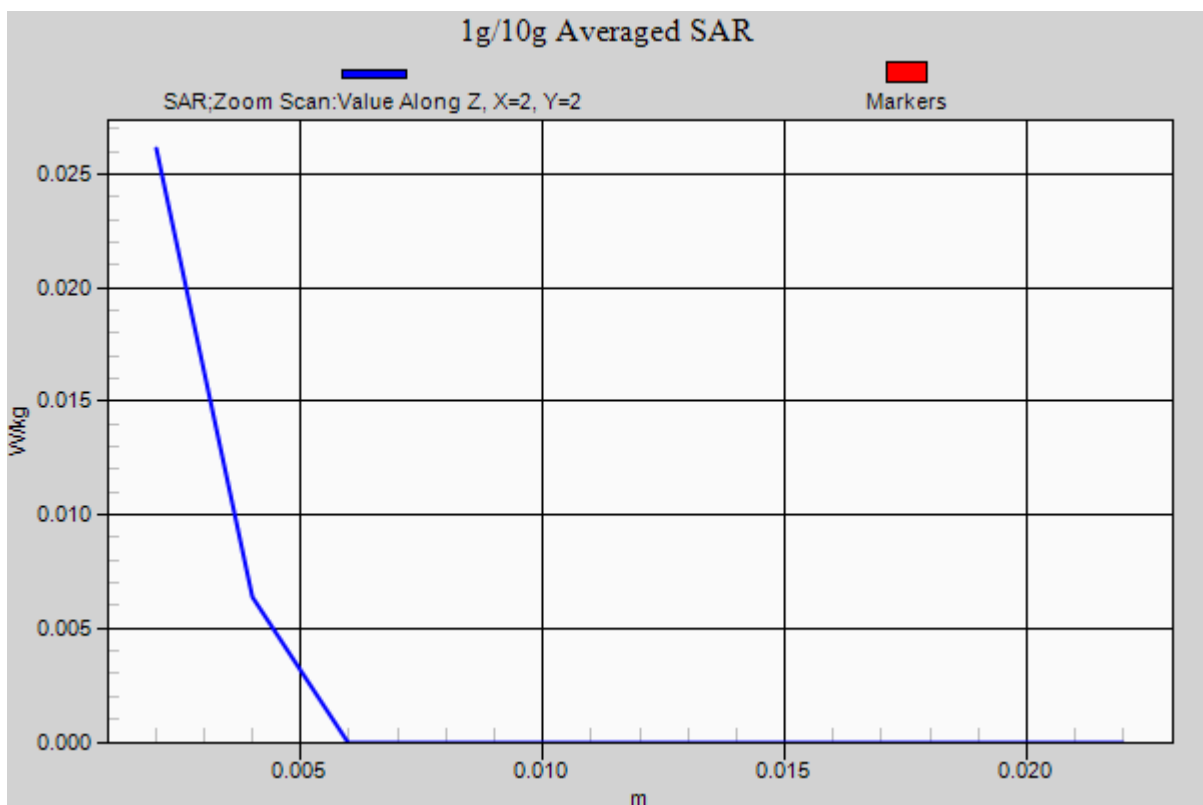

DT&C Co., Ltd.

DUT: PM450; Type: PDA

Communication System: W-LAN_5800 (0); Frequency: 5745 MHz; Duty Cycle: 1:1
Medium parameters used: $f = 5745$ MHz; $\sigma = 5.952$ S/m; $\epsilon_r = 46.978$; $\rho = 1000$ kg/m³
Phantom section: Flat Section

DASY5 Configuration:

Probe: EX3DV4 - SN3930; ConvF(4.21, 4.21, 4.21); Calibrated: 2014-07-22; Electronics: DAE4 Sn1394
Phantom: ELI v5.0; Type: QDOVA002AA; Serial: TP:1166
Measurement SW: DASY52, Version 52.8 (7); SEMCAD X Version 14.6.10 (7164)

Test Date: 2014-10-02; Ambient Temp: 20.1; Tissue Temp: 20.5

1cm space from Body, Front, W-LAN(802.11a 5.8G) Ch. 149, Ant Internal

Area Scan (141x321x1): Interpolated grid: dx=10mm, dy=10mm

Zoom Scan (7x7x11)/Cube 0: Measurement grid: dx=4mm, dy=4mm, dz=2mm

Power Drift = 0.00 dB

Peak SAR (extrapolated) = 0.245 W/kg

SAR(1 g) = 0.016 W/kg; SAR(10 g) = 0.00285 W/kg

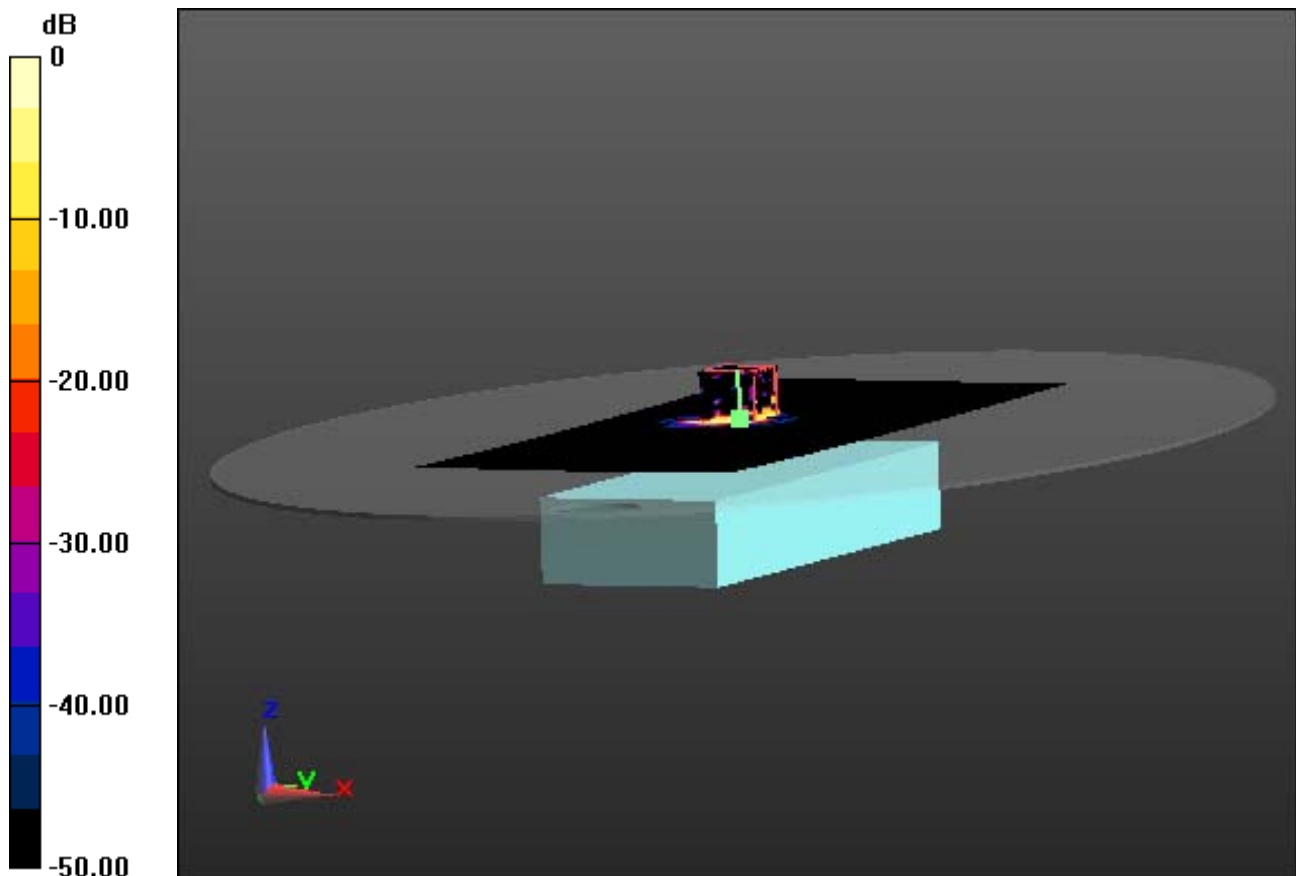

0 dB = 0.0288 W/kg

DT&C Co., Ltd.

DUT: PM450; Type: PDA

Communication System: W-LAN_5800 (0); Frequency: 5745 MHz; Duty Cycle: 1:1
Medium parameters used: $f = 5745$ MHz; $\sigma = 5.952$ S/m; $\epsilon_r = 46.978$; $\rho = 1000$ kg/m³
Phantom section: Flat Section

DASY5 Configuration:

Probe: EX3DV4 - SN3930; ConvF(4.21, 4.21, 4.21); Calibrated: 2014-07-22; Electronics: DAE4 Sn1394
Phantom: ELI v5.0; Type: QDOVA002AA; Serial: TP:1166
Measurement SW: DASY52, Version 52.8 (7); SEMCAD X Version 14.6.10 (7164)

Test Date: 2014-10-02; Ambient Temp: 20.1; Tissue Temp: 20.5

1cm space from Body, Front, W-LAN(802.11a 5.8G) Ch. 149, Ant Internal

With Enlarge plot image

Area Scan (141x321x1): Interpolated grid: dx=10mm, dy=10mm

Zoom Scan (7x7x11)/Cube 0: Measurement grid: dx=4mm, dy=4mm, dz=2mm

Power Drift = 0.00 dB

Peak SAR (extrapolated) = 0.245 W/kg

SAR(1 g) = 0.016 W/kg; SAR(10 g) = 0.00285 W/kg

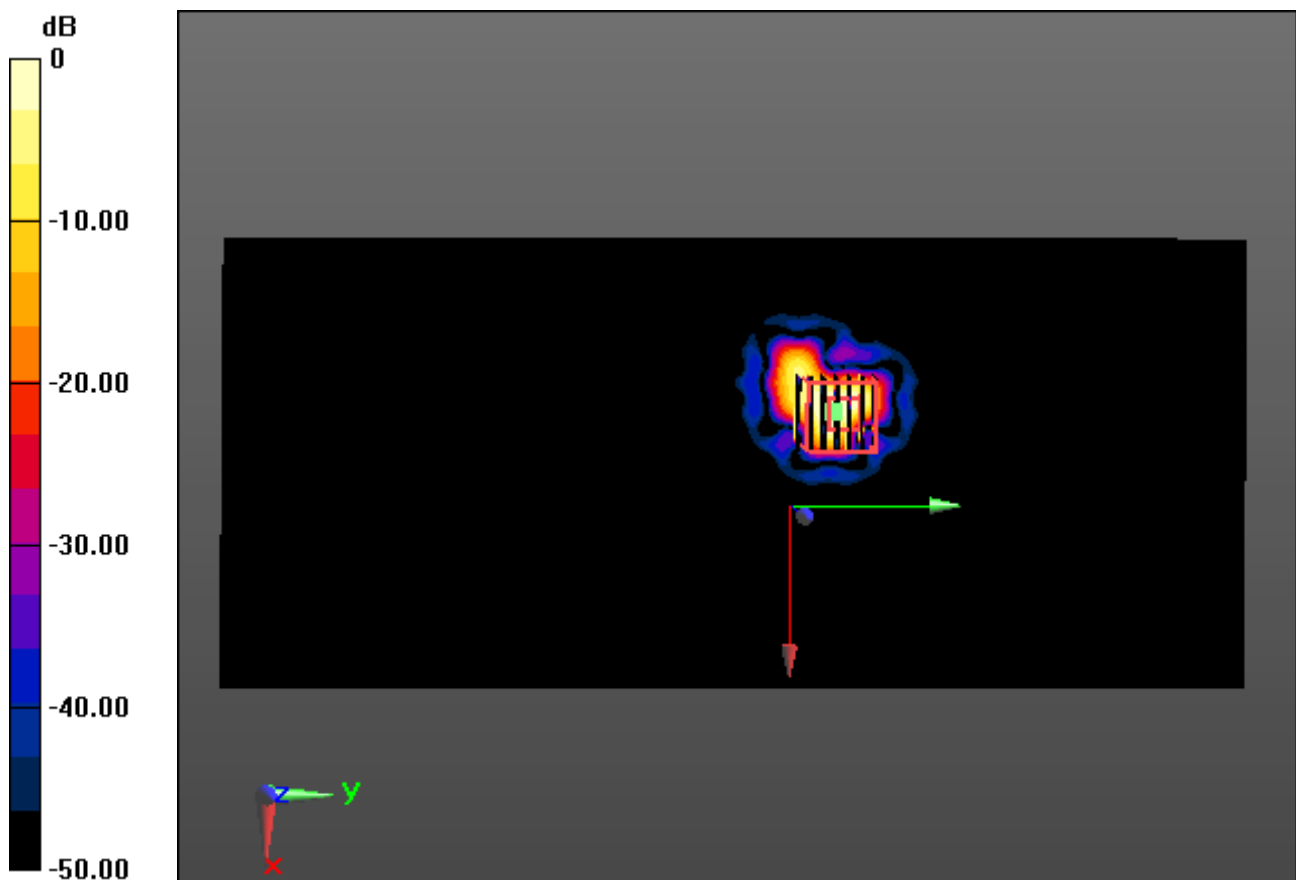

0 dB = 0.0288 W/kg

DT&C Co., Ltd.

DUT: PM450; Type: PDA

Communication System: W-LAN_5800 (0); Frequency: 5745 MHz; Duty Cycle: 1:1
Medium parameters used: $f = 5745$ MHz; $\sigma = 5.952$ S/m; $\epsilon_r = 46.978$; $\rho = 1000$ kg/m³
Phantom section: Flat Section

DASY5 Configuration:

Probe: EX3DV4 - SN3930; ConvF(4.21, 4.21, 4.21); Calibrated: 2014-07-22; Electronics: DAE4 Sn1394
Phantom: ELI v5.0; Type: QDOVA002AA; Serial: TP:1166
Measurement SW: DASY52, Version 52.8 (7); SEMCAD X Version 14.6.10 (7164)

Test Date: 2014-10-02; Ambient Temp: 20.1; Tissue Temp: 20.5

1cm space from Body, Front, W-LAN(802.11a 5.8G) Ch. 149, Ant Internal

Area Scan (141x321x1): Interpolated grid: dx=10mm, dy=10mm
Zoom Scan (7x7x11)/Cube 0: Measurement grid: dx=4mm, dy=4mm, dz=2mm
Power Drift = 0.00 dB
Peak SAR (extrapolated) = 0.245 W/kg
SAR(1 g) = 0.016 W/kg; SAR(10 g) = 0.00285 W/kg

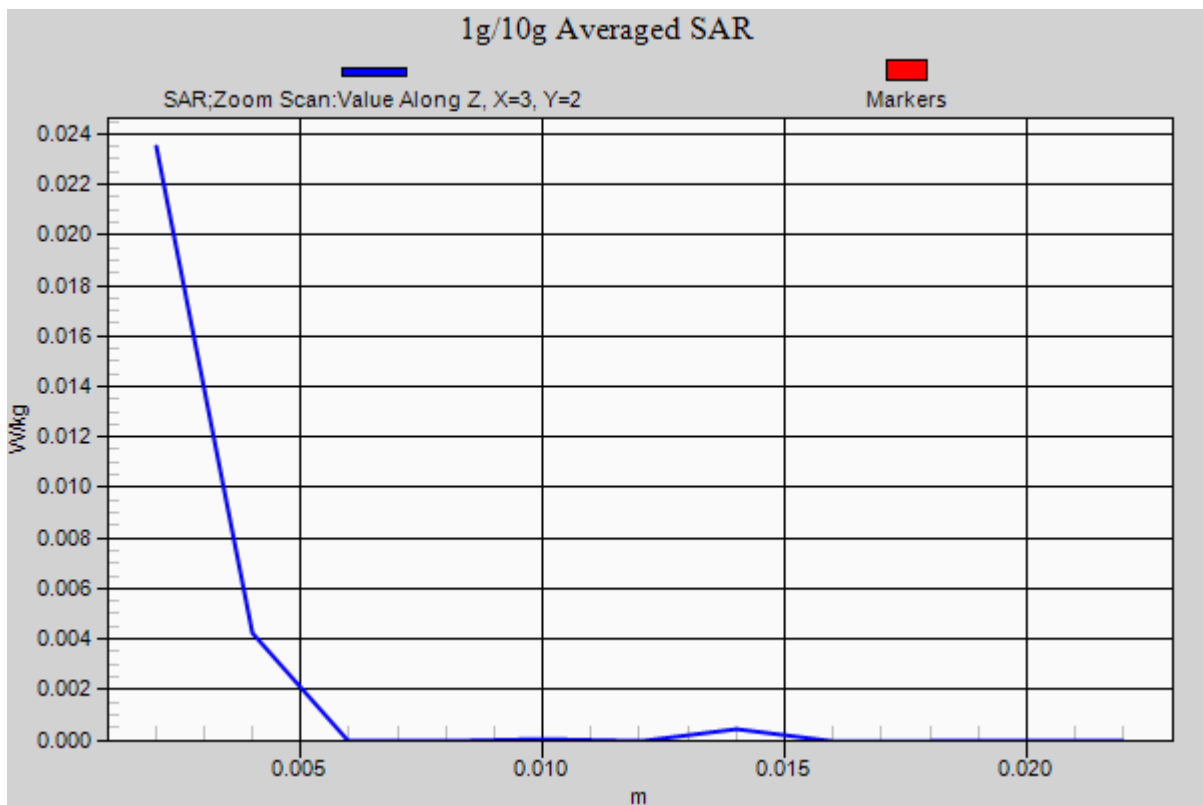

DT&C Co., Ltd.

DUT: PM450; Type: PDA

Communication System: W-LAN (0); Frequency: 2412 MHz; Duty Cycle: 1:1
Medium parameters used: $f = 2412$ MHz; $\sigma = 1.945$ S/m; $\epsilon_r = 51.449$; $\rho = 1000$ kg/m³
Phantom section: Flat Section

DASY5 Configuration:

Probe: EX3DV4 - SN3930; ConvF(7.12, 7.12, 7.12); Calibrated: 2014-07-22; Electronics: DAE4 Sn1394
Phantom: ELI v5.0; Type: QDOVA002AA; Serial: TP:1166
Measurement SW: DASY52, Version 52.8 (7); SEMCAD X Version 14.6.10 (7164)

Test Date: 2014-10-03; Ambient Temp: 20.4; Tissue Temp: 21.0

Touch from Body, Right, W-LAN(802.11b) Ch. 1, Ant Internal

Area Scan (81x231x1): Interpolated grid: dx=12mm, dy=12mm

Zoom Scan (7x7x7)/Cube 0: Measurement grid: dx=5mm, dy=5mm, dz=5mm

Power Drift = -0.03 dB

Peak SAR (extrapolated) = 3.31 W/kg

SAR(1 g) = 1.39 W/kg; SAR(10 g) = 0.549 W/kg

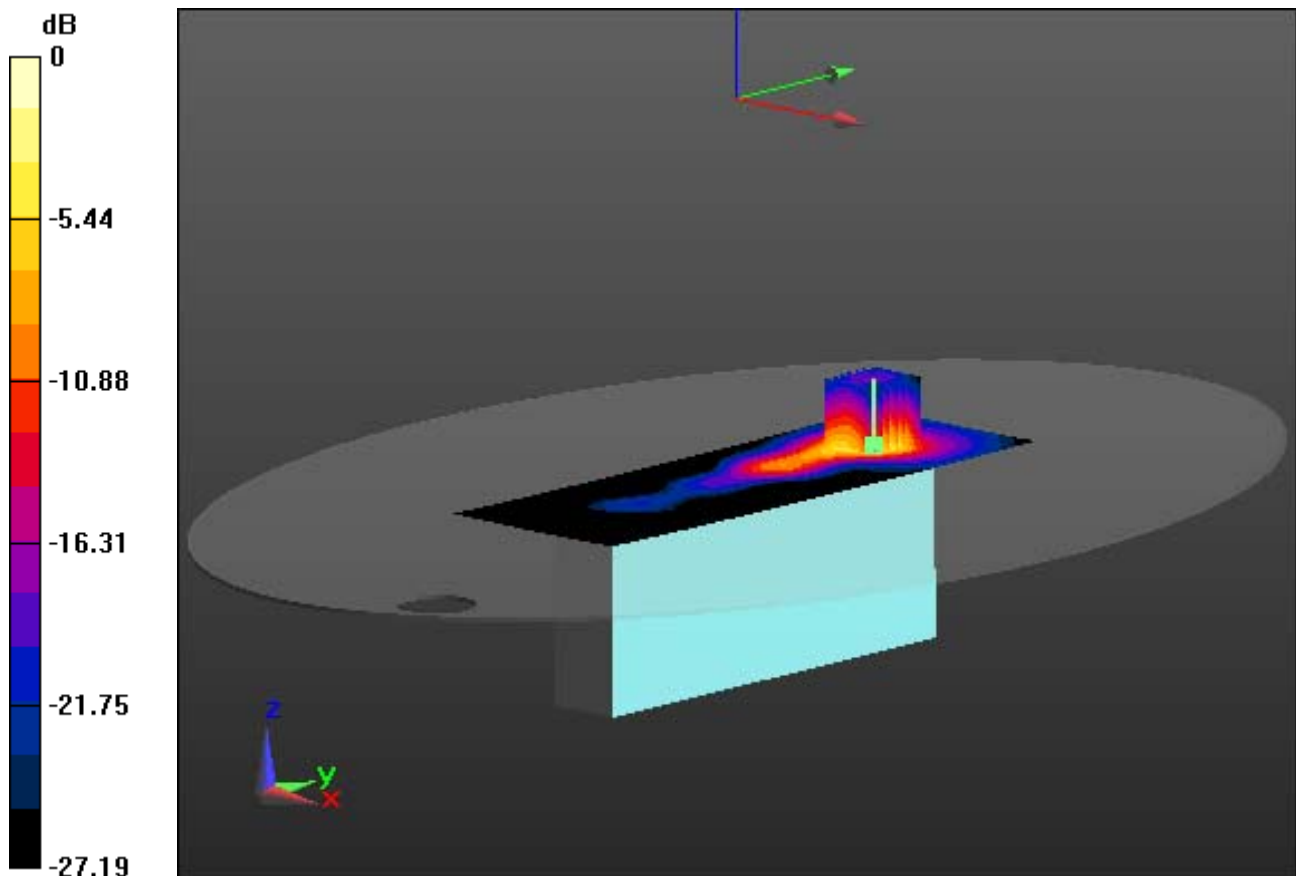

0 dB = 1.86 W/kg

DT&C Co., Ltd.

DUT: PM450; Type: PDA

Communication System: W-LAN (0); Frequency: 2412 MHz; Duty Cycle: 1:1
Medium parameters used: $f = 2412$ MHz; $\sigma = 1.945$ S/m; $\epsilon_r = 51.449$; $\rho = 1000$ kg/m³
Phantom section: Flat Section

DASY5 Configuration:

Probe: EX3DV4 - SN3930; ConvF(7.12, 7.12, 7.12); Calibrated: 2014-07-22; Electronics: DAE4 Sn1394
Phantom: ELI v5.0; Type: QDOVA002AA; Serial: TP:1166
Measurement SW: DASY52, Version 52.8 (7); SEMCAD X Version 14.6.10 (7164)

Test Date: 2014-10-03; Ambient Temp: 20.4; Tissue Temp: 21.0

Touch from Body, Right, W-LAN(802.11b) Ch. 1, Ant Internal

With Enlarge plot image

Area Scan (81x231x1): Interpolated grid: dx=12mm, dy=12mm
Zoom Scan (7x7x7)/Cube 0: Measurement grid: dx=5mm, dy=5mm, dz=5mm
Power Drift = -0.03 dB
Peak SAR (extrapolated) = 3.31 W/kg
SAR(1 g) = 1.39 W/kg; SAR(10 g) = 0.549 W/kg

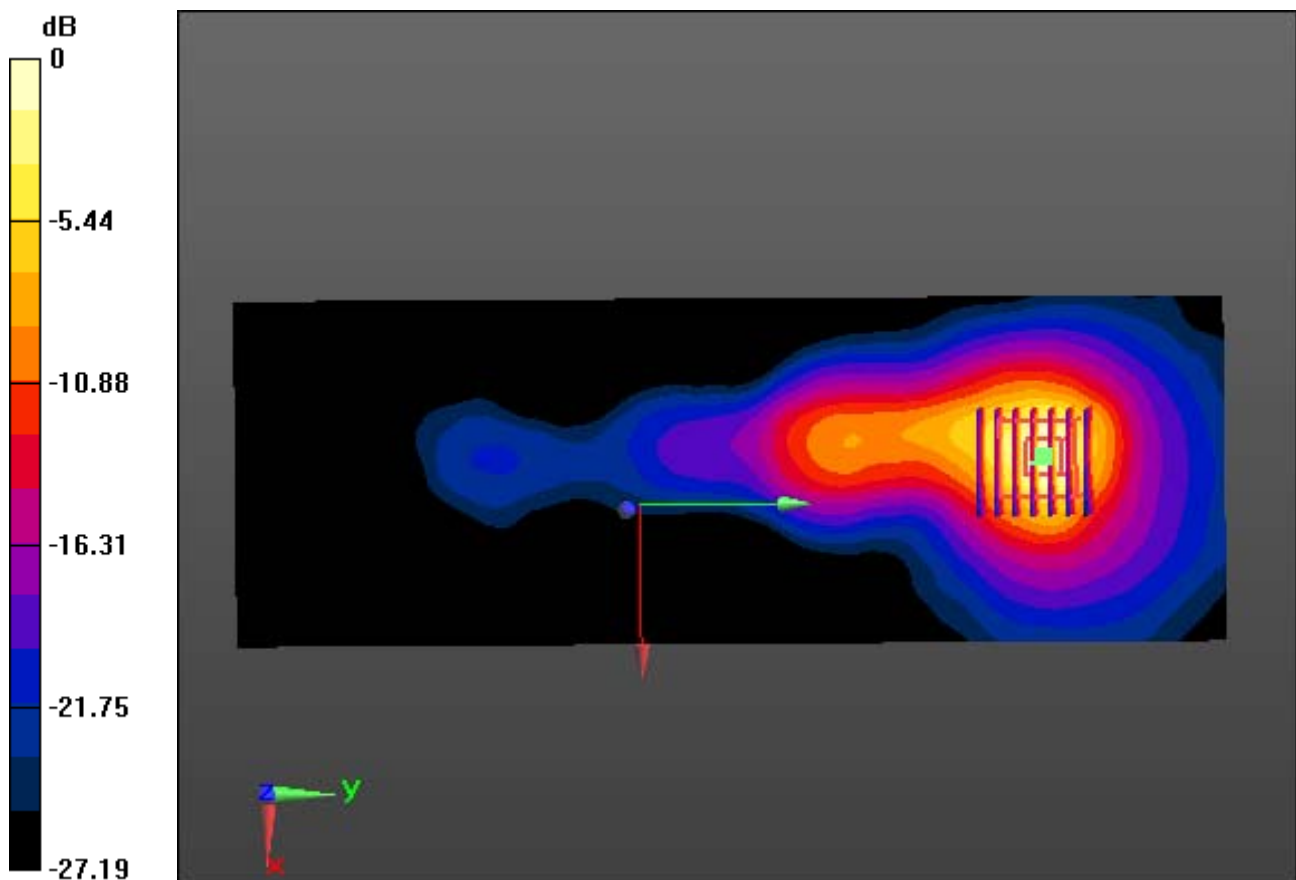

0 dB = 1.86 W/kg

DT&C Co., Ltd.

DUT: PM450; Type: PDA

Communication System: W-LAN (0); Frequency: 2412 MHz; Duty Cycle: 1:1
Medium parameters used: $f = 2412$ MHz; $\sigma = 1.945$ S/m; $\epsilon_r = 51.449$; $\rho = 1000$ kg/m³
Phantom section: Flat Section

DASY5 Configuration:

Probe: EX3DV4 - SN3930; ConvF(7.12, 7.12, 7.12); Calibrated: 2014-07-22; Electronics: DAE4 Sn1394
Phantom: ELI v5.0; Type: QDOVA002AA; Serial: TP:1166
Measurement SW: DASY52, Version 52.8 (7); SEMCAD X Version 14.6.10 (7164)

Test Date: 2014-10-03; Ambient Temp: 20.4; Tissue Temp: 21.0

Touch from Body, Right, W-LAN(802.11b) Ch. 1, Ant Internal

Area Scan (81x231x1): Interpolated grid: dx=12mm, dy=12mm
Zoom Scan (7x7x7)/Cube 0: Measurement grid: dx=5mm, dy=5mm, dz=5mm
Power Drift = -0.03 dB
Peak SAR (extrapolated) = 3.31 W/kg
SAR(1 g) = 1.39 W/kg; SAR(10 g) = 0.549 W/kg

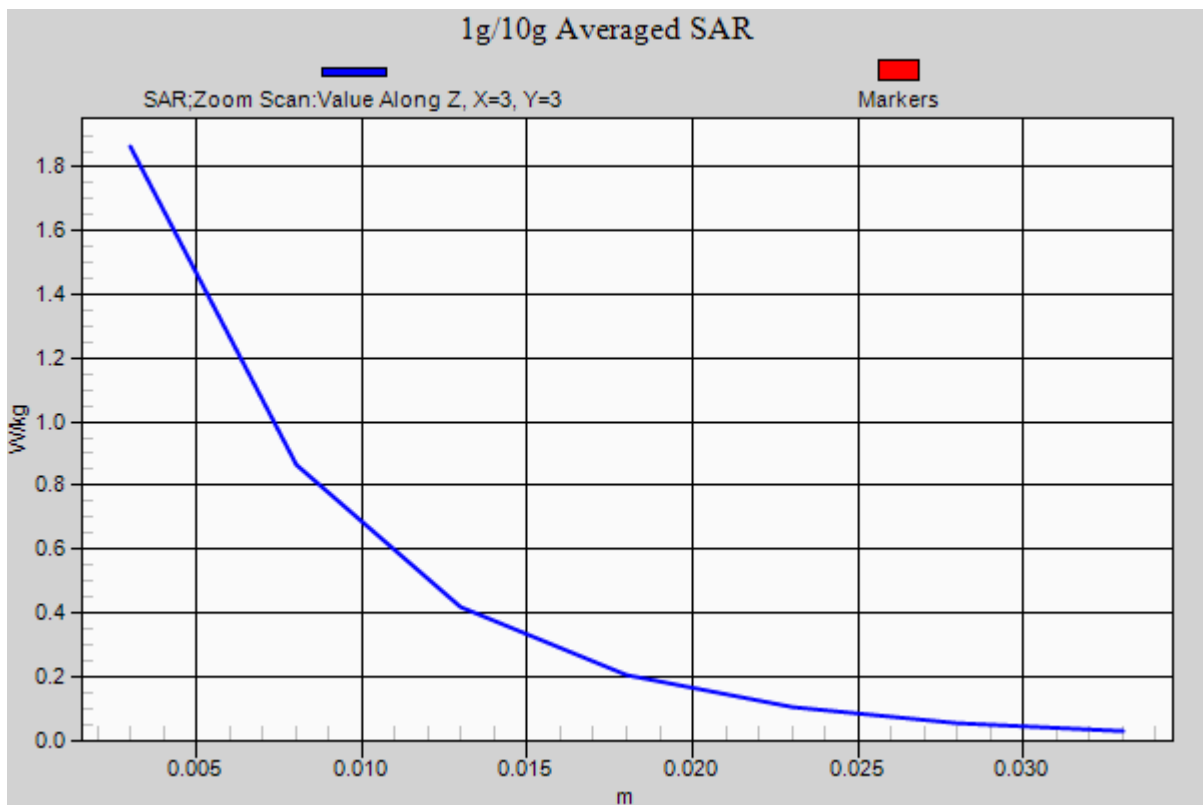

DT&C Co., Ltd.

DUT: PM450; Type: PDA

Communication System: W-LAN_5200 (0); Frequency: 5180 MHz; Duty Cycle: 1:1
Medium parameters used: $f = 5180$ MHz; $\sigma = 5.215$ S/m; $\epsilon_r = 47.938$; $\rho = 1000$ kg/m³
Phantom section: Flat Section

DASY5 Configuration:

Probe: EX3DV4 - SN3930; ConvF(4.67, 4.67, 4.67); Calibrated: 2014-07-22; Electronics: DAE4 Sn1394
Phantom: ELI v5.0; Type: QDOVA002AA; Serial: TP:1166
Measurement SW: DASY52, Version 52.8 (7); SEMCAD X Version 14.6.10 (7164)

Test Date: 2014-10-02; Ambient Temp: 20.1; Tissue Temp: 20.5

Touch from Body, Right, W-LAN(802.11a 5.2G) Ch. 36, Ant Internal

Area Scan (101x281x1): Interpolated grid: dx=10mm, dy=10mm

Zoom Scan (7x7x11)/Cube 0: Measurement grid: dx=4mm, dy=4mm, dz=2mm
Power Drift = 0.00 dB

Peak SAR (extrapolated) = 0.668 W/kg

SAR(1 g) = 0.158 W/kg; SAR(10 g) = 0.040 W/kg

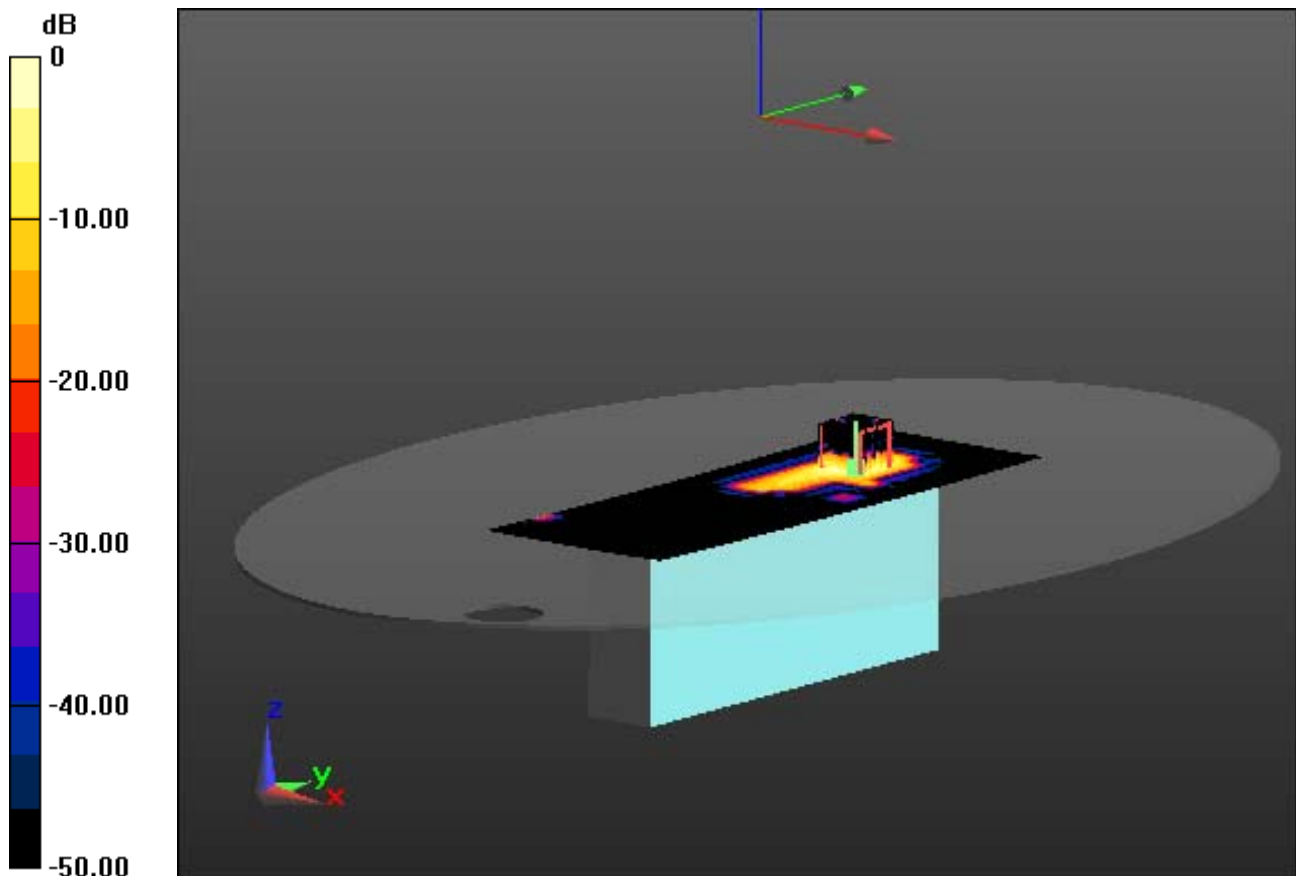

0 dB = 0.270 W/kg

DT&C Co., Ltd.

DUT: PM450; Type: PDA

Communication System: W-LAN_5200 (0); Frequency: 5180 MHz; Duty Cycle: 1:1
Medium parameters used: $f = 5180$ MHz; $\sigma = 5.215$ S/m; $\epsilon_r = 47.938$; $\rho = 1000$ kg/m³
Phantom section: Flat Section

DASY5 Configuration:

Probe: EX3DV4 - SN3930; ConvF(4.67, 4.67, 4.67); Calibrated: 2014-07-22; Electronics: DAE4 Sn1394
Phantom: ELI v5.0; Type: QDOVA002AA; Serial: TP:1166
Measurement SW: DASY52, Version 52.8 (7); SEMCAD X Version 14.6.10 (7164)

Test Date: 2014-10-02; Ambient Temp: 20.1; Tissue Temp: 20.5

Touch from Body, Right, W-LAN(802.11a 5.2G) Ch. 36, Ant Internal

With Enlarge plot image

Area Scan (101x281x1): Interpolated grid: dx=10mm, dy=10mm
Zoom Scan (7x7x11)/Cube 0: Measurement grid: dx=4mm, dy=4mm, dz=2mm
Power Drift = 0.00 dB
Peak SAR (extrapolated) = 0.668 W/kg
SAR(1 g) = 0.158 W/kg; SAR(10 g) = 0.040 W/kg

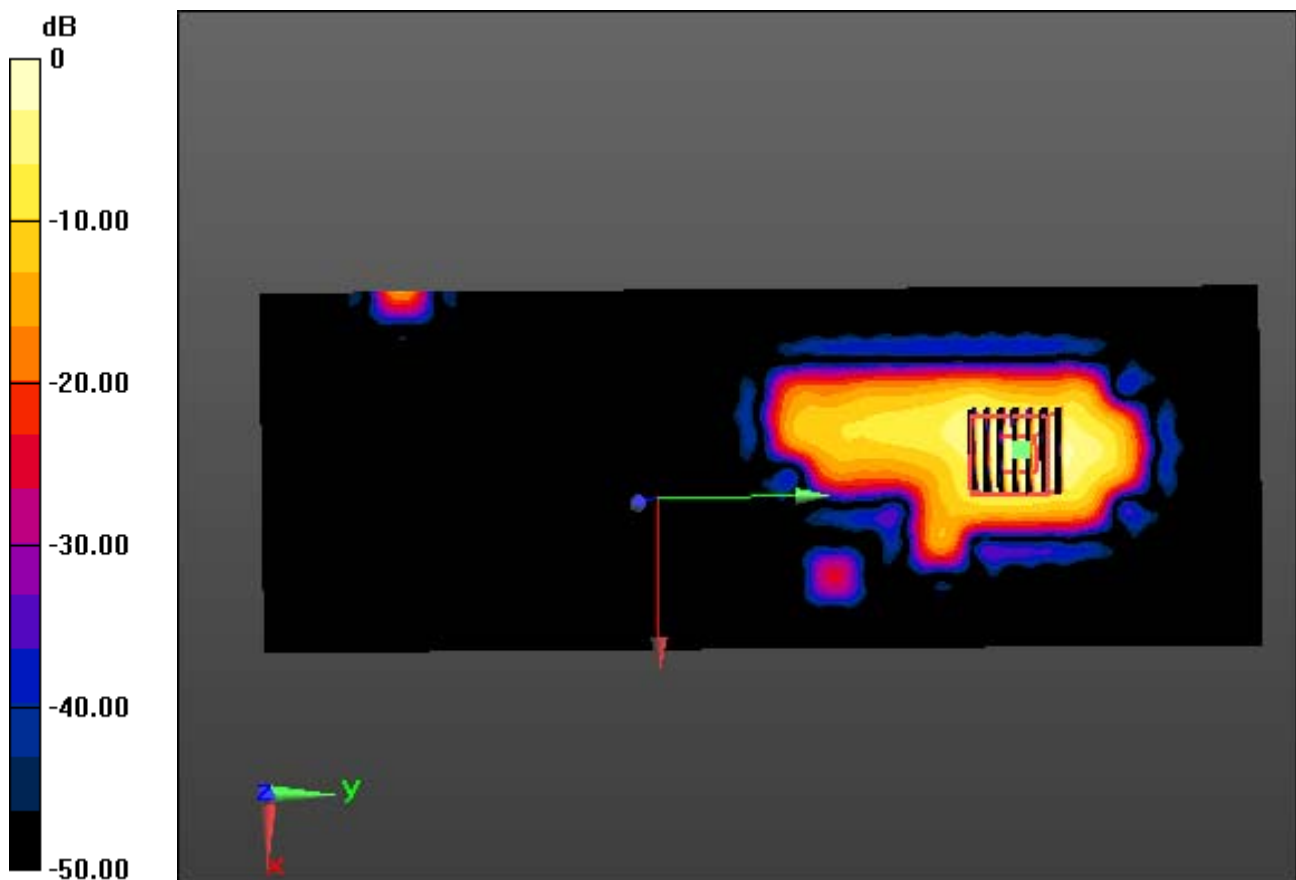

0 dB = 0.270 W/kg

DT&C Co., Ltd.

DUT: PM450; Type: PDA

Communication System: W-LAN_5200 (0); Frequency: 5180 MHz; Duty Cycle: 1:1
Medium parameters used: $f = 5180$ MHz; $\sigma = 5.215$ S/m; $\epsilon_r = 47.938$; $\rho = 1000$ kg/m³
Phantom section: Flat Section

DASY5 Configuration:

Probe: EX3DV4 - SN3930; ConvF(4.67, 4.67, 4.67); Calibrated: 2014-07-22; Electronics: DAE4 Sn1394
Phantom: ELI v5.0; Type: QDOVA002AA; Serial: TP:1166
Measurement SW: DASY52, Version 52.8 (7); SEMCAD X Version 14.6.10 (7164)

Test Date: 2014-10-02; Ambient Temp: 20.1; Tissue Temp: 20.5

Touch from Body, Right, W-LAN(802.11a 5.2G) Ch. 36, Ant Internal

Area Scan (101x281x1): Interpolated grid: dx=10mm, dy=10mm
Zoom Scan (7x7x11)/Cube 0: Measurement grid: dx=4mm, dy=4mm, dz=2mm
Power Drift = 0.00 dB
Peak SAR (extrapolated) = 0.668 W/kg
SAR(1 g) = 0.158 W/kg; SAR(10 g) = 0.040 W/kg

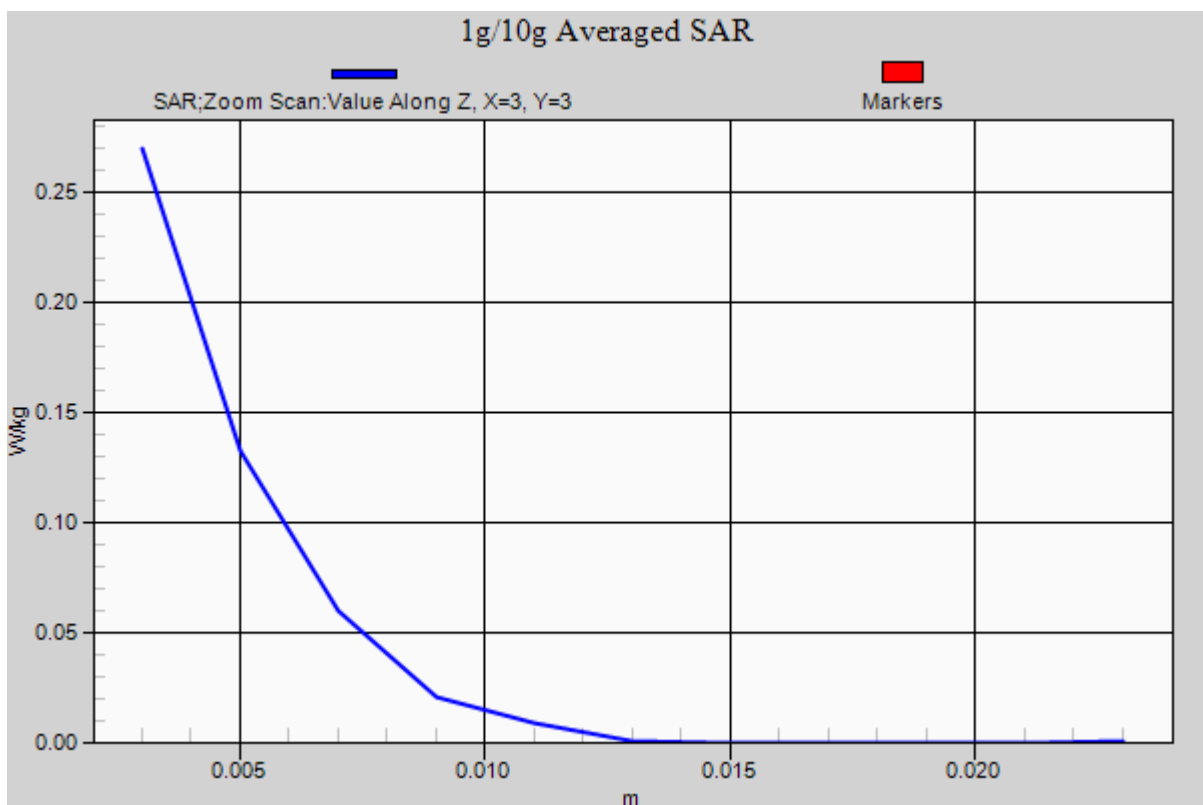

DT&C Co., Ltd.

DUT: PM450; Type: PDA

Communication System: W-LAN_5200 (0); Frequency: 5260 MHz; Duty Cycle: 1:1
Medium parameters used: $f = 5260$ MHz; $\sigma = 5.322$ S/m; $\epsilon_r = 47.787$; $\rho = 1000$ kg/m³
Phantom section: Flat Section

DASY5 Configuration:

Probe: EX3DV4 - SN3930; ConvF(4.49, 4.49, 4.49); Calibrated: 2014-07-22; Electronics: DAE4 Sn1394
Phantom: ELI v5.0; Type: QDOVA002AA; Serial: TP:1166
Measurement SW: DASY52, Version 52.8 (7); SEMCAD X Version 14.6.10 (7164)

Test Date: 2014-10-02; Ambient Temp: 20.1; Tissue Temp: 20.5

Touch from Body, Right, W-LAN(802.11a 5.3G) Ch. 52, Ant Internal

Area Scan (101x281x1): Interpolated grid: dx=10mm, dy=10mm
Zoom Scan (7x7x11)/Cube 0: Measurement grid: dx=4mm, dy=4mm, dz=2mm
Power Drift = 0.00 dB
Peak SAR (extrapolated) = 0.498 W/kg
SAR(1 g) = 0.047 W/kg; SAR(10 g) = 0.012 W/kg

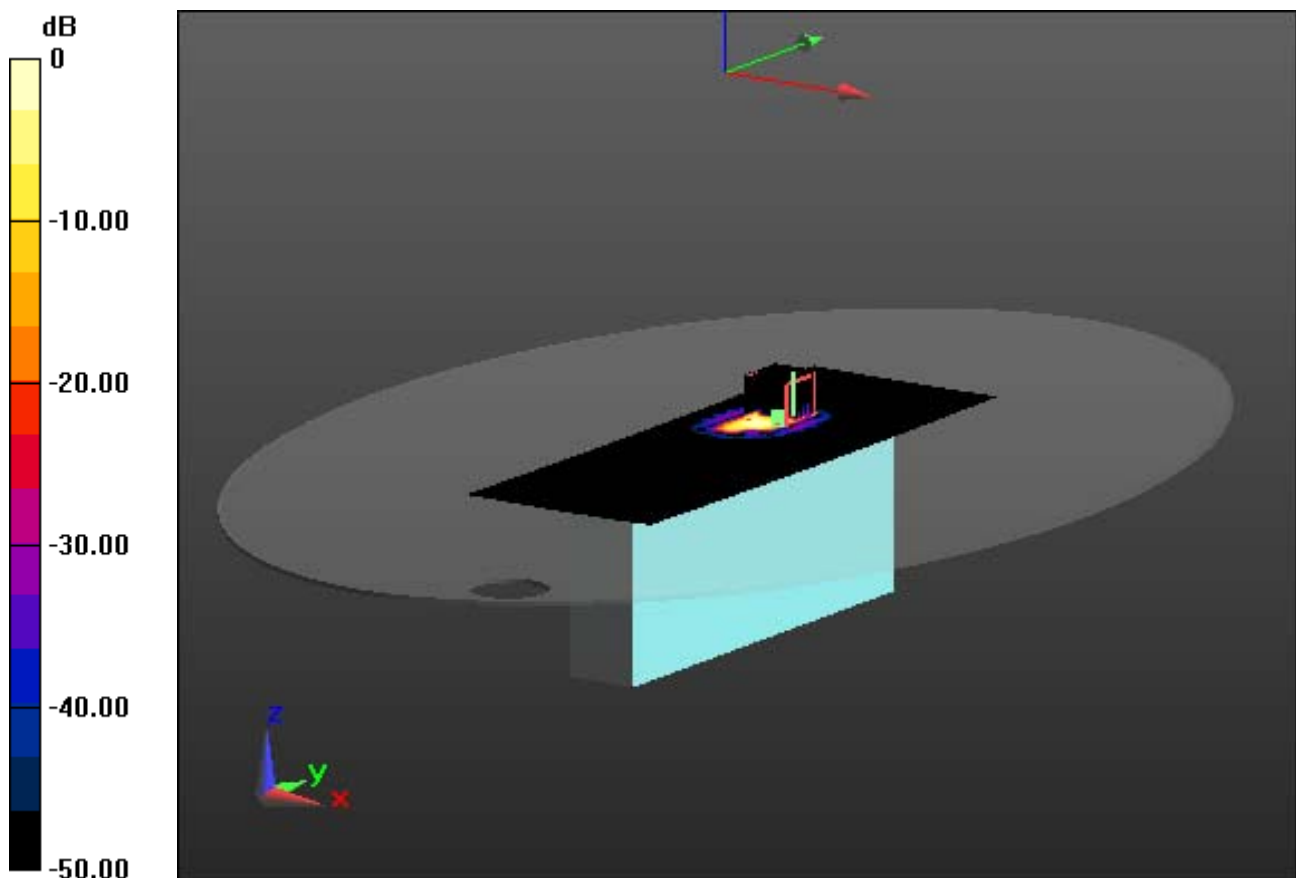

0 dB = 0.0516 W/kg

DT&C Co., Ltd.

DUT: PM450; Type: PDA

Communication System: W-LAN_5200 (0); Frequency: 5260 MHz; Duty Cycle: 1:1
Medium parameters used: $f = 5260$ MHz; $\sigma = 5.322$ S/m; $\epsilon_r = 47.787$; $\rho = 1000$ kg/m³
Phantom section: Flat Section

DASY5 Configuration:

Probe: EX3DV4 - SN3930; ConvF(4.49, 4.49, 4.49); Calibrated: 2014-07-22; Electronics: DAE4 Sn1394
Phantom: ELI v5.0; Type: QDOVA002AA; Serial: TP:1166
Measurement SW: DASY52, Version 52.8 (7); SEMCAD X Version 14.6.10 (7164)

Test Date: 2014-10-02; Ambient Temp: 20.1; Tissue Temp: 20.5

Touch from Body, Right, W-LAN(802.11a 5.3G) Ch. 52, Ant Internal

With Enlarge plot image

Area Scan (101x281x1): Interpolated grid: dx=10mm, dy=10mm
Zoom Scan (7x7x11)/Cube 0: Measurement grid: dx=4mm, dy=4mm, dz=2mm
Power Drift = 0.00 dB
Peak SAR (extrapolated) = 0.498 W/kg
SAR(1 g) = 0.047 W/kg; SAR(10 g) = 0.012 W/kg

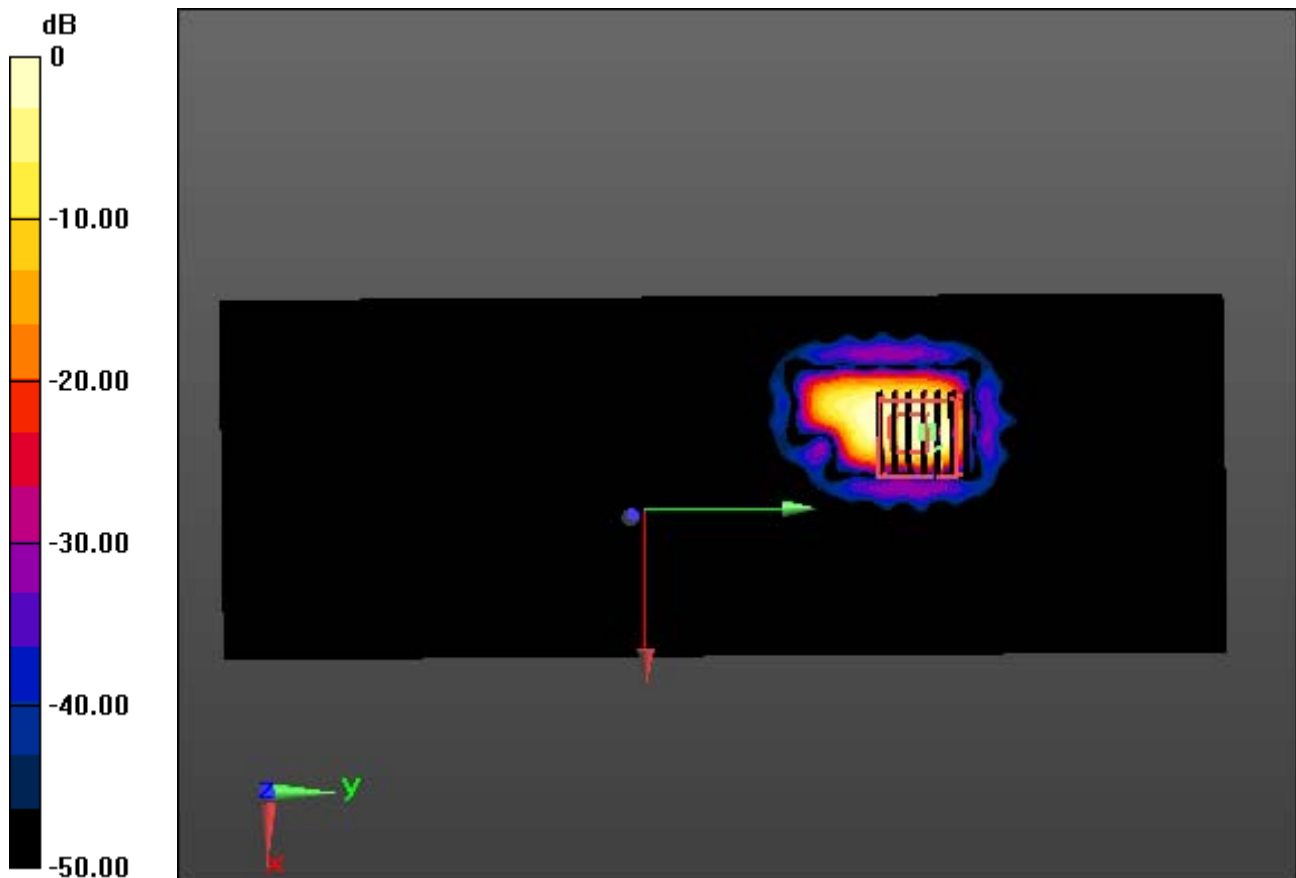

0 dB = 0.0516 W/kg

DT&C Co., Ltd.

DUT: PM450; Type: PDA

Communication System: W-LAN_5200 (0); Frequency: 5260 MHz; Duty Cycle: 1:1
Medium parameters used: $f = 5260$ MHz; $\sigma = 5.322$ S/m; $\epsilon_r = 47.787$; $\rho = 1000$ kg/m³
Phantom section: Flat Section

DASY5 Configuration:

Probe: EX3DV4 - SN3930; ConvF(4.49, 4.49, 4.49); Calibrated: 2014-07-22; Electronics: DAE4 Sn1394
Phantom: ELI v5.0; Type: QDOVA002AA; Serial: TP:1166
Measurement SW: DASY52, Version 52.8 (7); SEMCAD X Version 14.6.10 (7164)

Test Date: 2014-10-02; Ambient Temp: 20.1; Tissue Temp: 20.5

Touch from Body, Right, W-LAN(802.11a 5.3G) Ch. 52, Ant Internal

Area Scan (101x281x1): Interpolated grid: dx=10mm, dy=10mm
Zoom Scan (7x7x11)/Cube 0: Measurement grid: dx=4mm, dy=4mm, dz=2mm
Power Drift = 0.00 dB
Peak SAR (extrapolated) = 0.498 W/kg
SAR(1 g) = 0.047 W/kg; SAR(10 g) = 0.012 W/kg

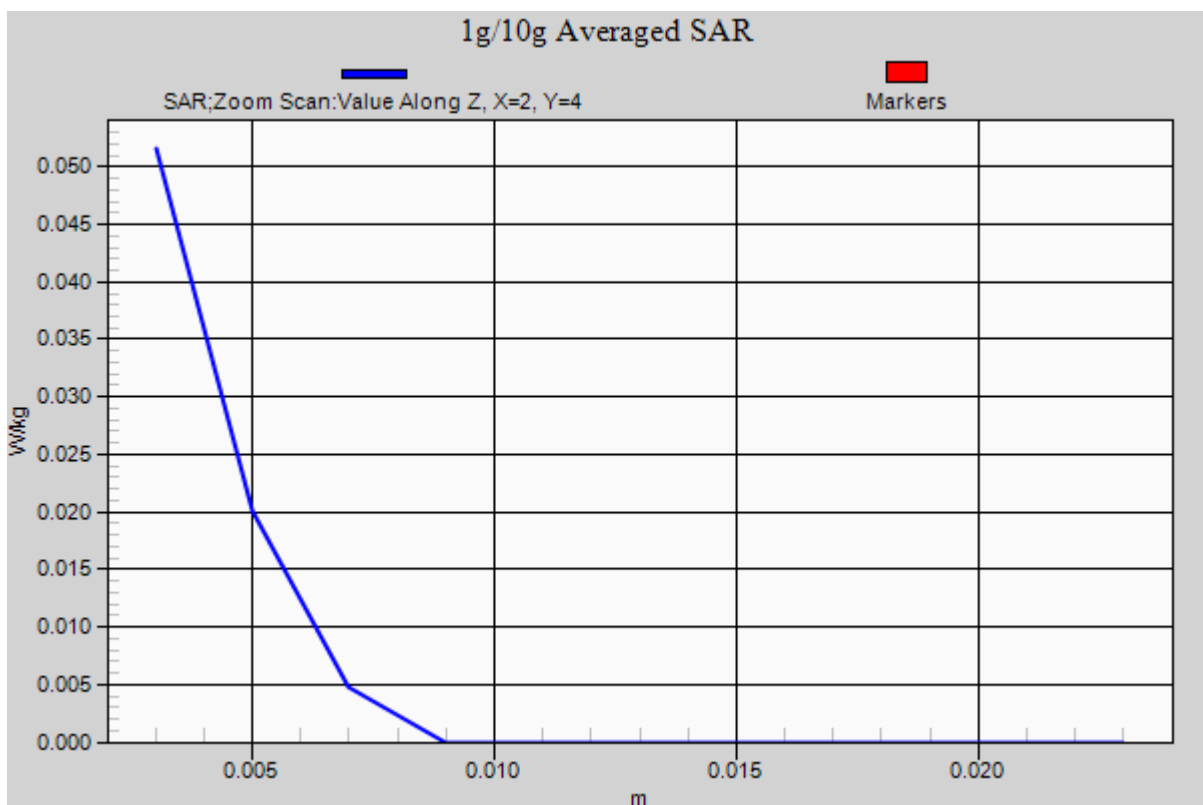

DT&C Co., Ltd.

DUT: PM450; Type: PDA

Communication System: W-LAN_5500 (0); Frequency: 5580 MHz; Duty Cycle: 1:1
Medium parameters used: $f = 5580$ MHz; $\sigma = 5.734$ S/m; $\epsilon_r = 47.241$; $\rho = 1000$ kg/m³
Phantom section: Flat Section

DASY5 Configuration:

Probe: EX3DV4 - SN3930; ConvF(4.06, 4.06, 4.06); Calibrated: 2014-07-22; Electronics: DAE4 Sn1394
Phantom: ELI v5.0; Type: QDOVA002AA; Serial: TP:1166
Measurement SW: DASY52, Version 52.8 (7); SEMCAD X Version 14.6.10 (7164)

Test Date: 2014-10-02; Ambient Temp: 20.1; Tissue Temp: 20.5

Touch from Body, Right, W-LAN(802.11a 5.6G) Ch. 116, Ant Internal

Area Scan (101x281x1): Interpolated grid: dx=10mm, dy=10mm

Zoom Scan (7x7x11)/Cube 0: Measurement grid: dx=4mm, dy=4mm, dz=2mm
Power Drift = 0.00 dB

Peak SAR (extrapolated) = 0.227 W/kg

SAR(1 g) = 0.039 W/kg; SAR(10 g) = 0.011 W/kg

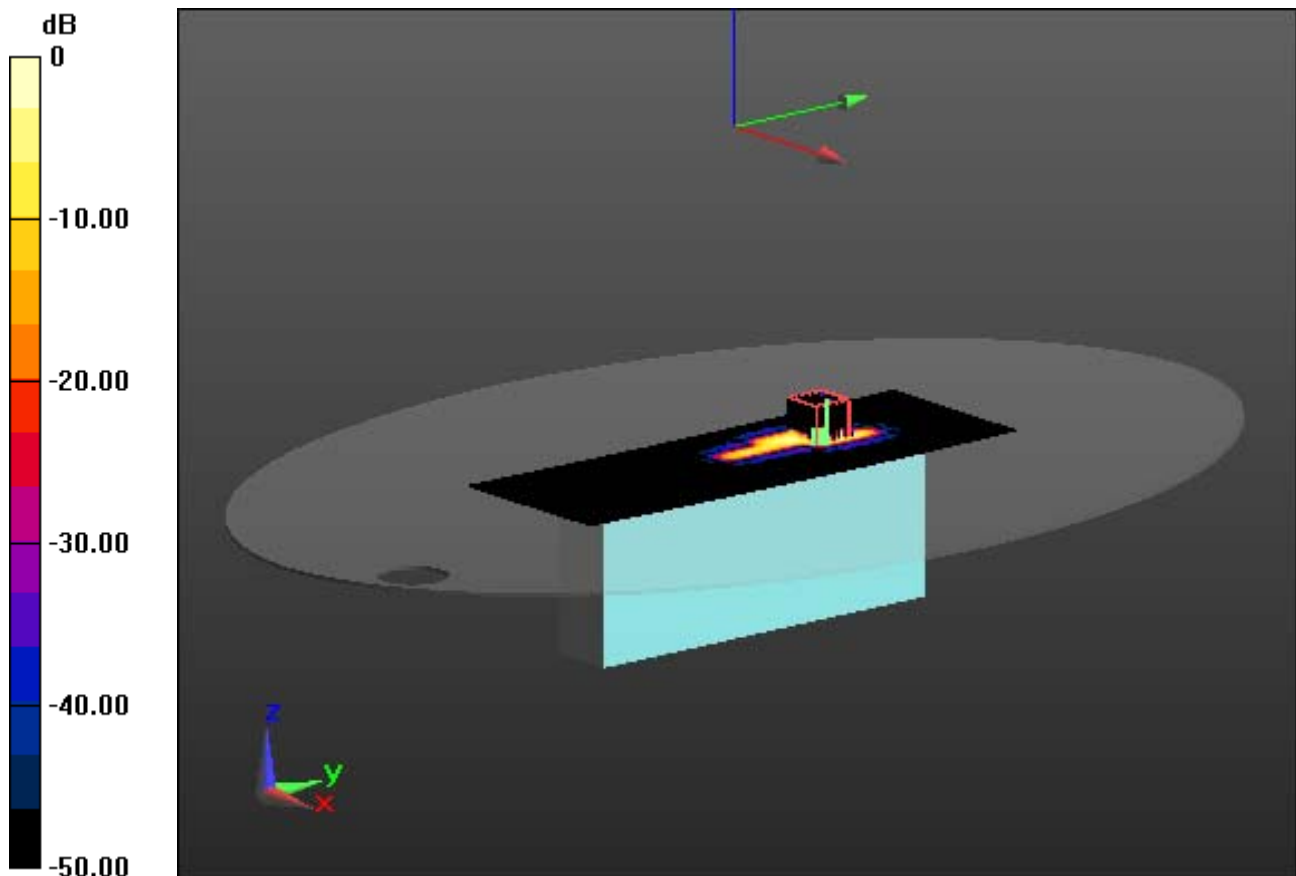

0 dB = 0.101 W/kg

DT&C Co., Ltd.

DUT: PM450; Type: PDA

Communication System: W-LAN_5500 (0); Frequency: 5580 MHz; Duty Cycle: 1:1
Medium parameters used: $f = 5580$ MHz; $\sigma = 5.734$ S/m; $\epsilon_r = 47.241$; $\rho = 1000$ kg/m³
Phantom section: Flat Section

DASY5 Configuration:

Probe: EX3DV4 - SN3930; ConvF(4.06, 4.06, 4.06); Calibrated: 2014-07-22; Electronics: DAE4 Sn1394
Phantom: ELI v5.0; Type: QDOVA002AA; Serial: TP:1166
Measurement SW: DASY52, Version 52.8 (7); SEMCAD X Version 14.6.10 (7164)

Test Date: 2014-10-02; Ambient Temp: 20.1; Tissue Temp: 20.5

Touch from Body, Right, W-LAN(802.11a 5.6G) Ch. 116, Ant Internal

Wiht Enlarge plot image

Area Scan (101x281x1): Interpolated grid: dx=10mm, dy=10mm

Zoom Scan (7x7x11)/Cube 0: Measurement grid: dx=4mm, dy=4mm, dz=2mm

Power Drift = 0.00 dB

Peak SAR (extrapolated) = 0.227 W/kg

SAR(1 g) = 0.039 W/kg; SAR(10 g) = 0.011 W/kg

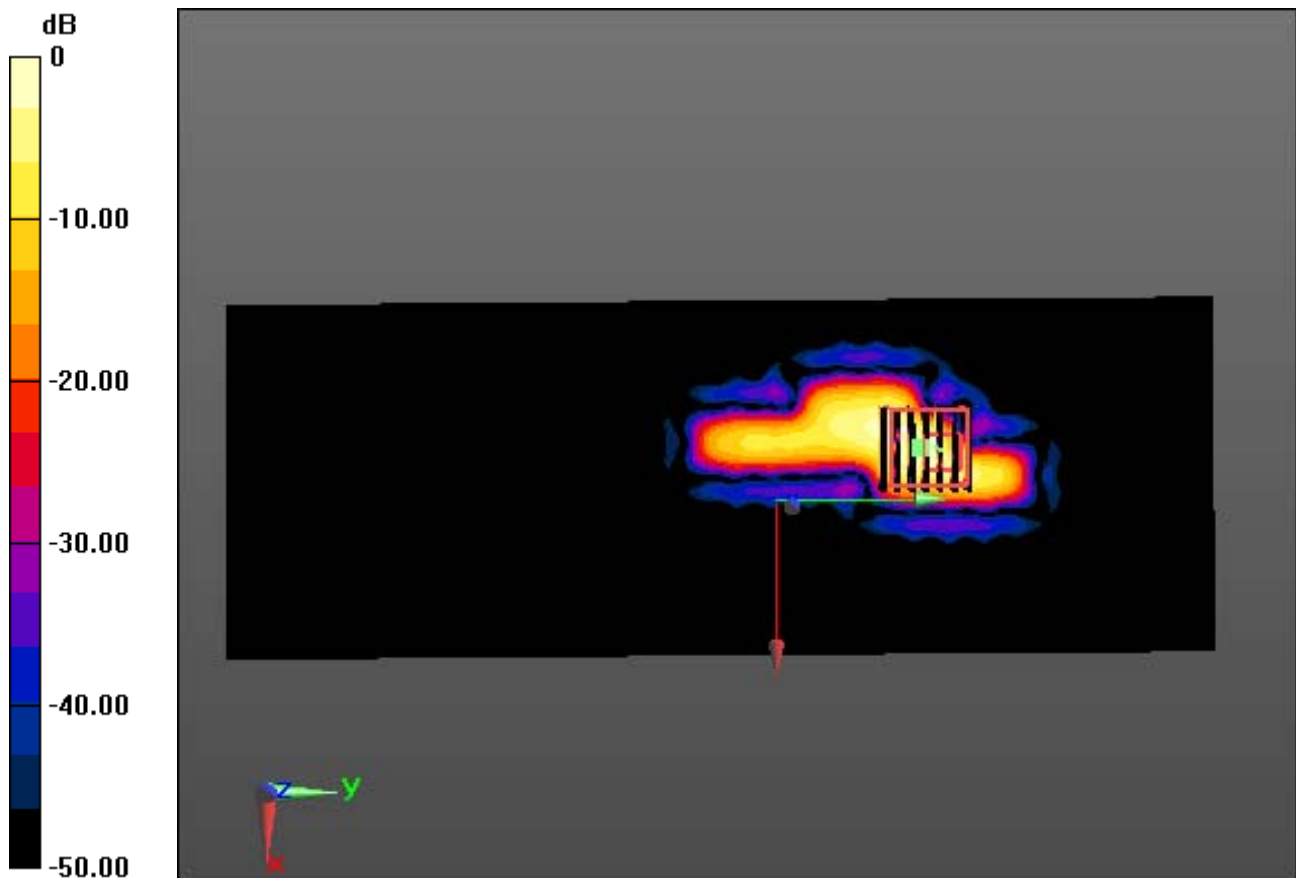

0 dB = 0.101 W/kg

DT&C Co., Ltd.

DUT: PM450; Type: PDA

Communication System: W-LAN_5500 (0); Frequency: 5580 MHz; Duty Cycle: 1:1
Medium parameters used: $f = 5580$ MHz; $\sigma = 5.734$ S/m; $\epsilon_r = 47.241$; $\rho = 1000$ kg/m³
Phantom section: Flat Section

DASY5 Configuration:

Probe: EX3DV4 - SN3930; ConvF(4.06, 4.06, 4.06); Calibrated: 2014-07-22; Electronics: DAE4 Sn1394
Phantom: ELI v5.0; Type: QDOVA002AA; Serial: TP:1166
Measurement SW: DASY52, Version 52.8 (7); SEMCAD X Version 14.6.10 (7164)

Test Date: 2014-10-02; Ambient Temp: 20.1; Tissue Temp: 20.5

Touch from Body, Right, W-LAN(802.11a 5.6G) Ch. 116, Ant Internal

Area Scan (101x281x1): Interpolated grid: dx=10mm, dy=10mm

Zoom Scan (7x7x11)/Cube 0: Measurement grid: dx=4mm, dy=4mm, dz=2mm
Power Drift = 0.00 dB

Peak SAR (extrapolated) = 0.227 W/kg

SAR(1 g) = 0.039 W/kg; SAR(10 g) = 0.011 W/kg

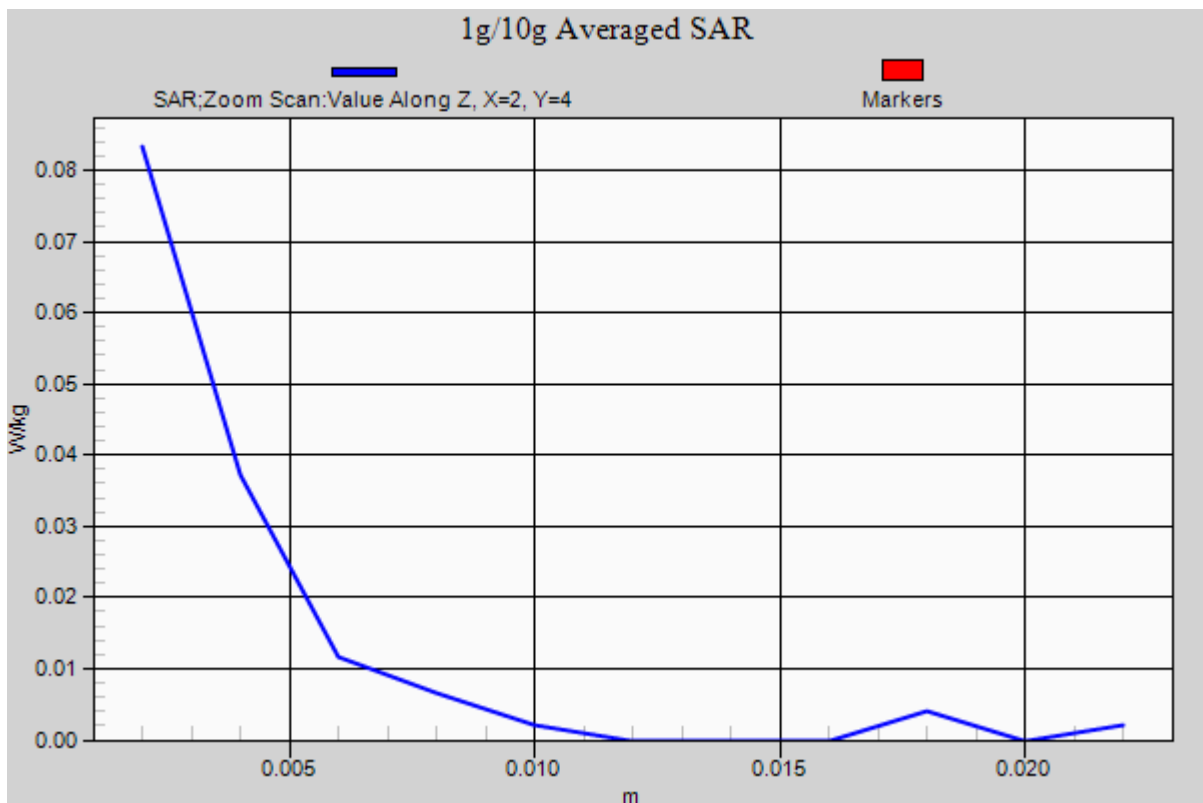

DT&C Co., Ltd.

DUT: PM450; Type: PDA

Communication System: W-LAN_5800 (0); Frequency: 5745 MHz; Duty Cycle: 1:1
Medium parameters used: $f = 5745$ MHz; $\sigma = 5.952$ S/m; $\epsilon_r = 46.978$; $\rho = 1000$ kg/m³
Phantom section: Flat Section

DASY5 Configuration:

Probe: EX3DV4 - SN3930; ConvF(4.21, 4.21, 4.21); Calibrated: 2014-07-22; Electronics: DAE4 Sn1394
Phantom: ELI v5.0; Type: QDOVA002AA; Serial: TP:1166
Measurement SW: DASY52, Version 52.8 (7); SEMCAD X Version 14.6.10 (7164)

Test Date: 2014-10-02; Ambient Temp: 20.1; Tissue Temp: 20.5

Touch from Body, Right, W-LAN(802.11a 5.8G) Ch. 149, Ant Internal

Area Scan (101x281x1): Interpolated grid: dx=10mm, dy=10mm

Zoom Scan (7x7x11)/Cube 0: Measurement grid: dx=4mm, dy=4mm, dz=2mm
Power Drift = 0.00 dB

Peak SAR (extrapolated) = 0.690 W/kg

SAR(1 g) = 0.061 W/kg; SAR(10 g) = 0.013 W/kg

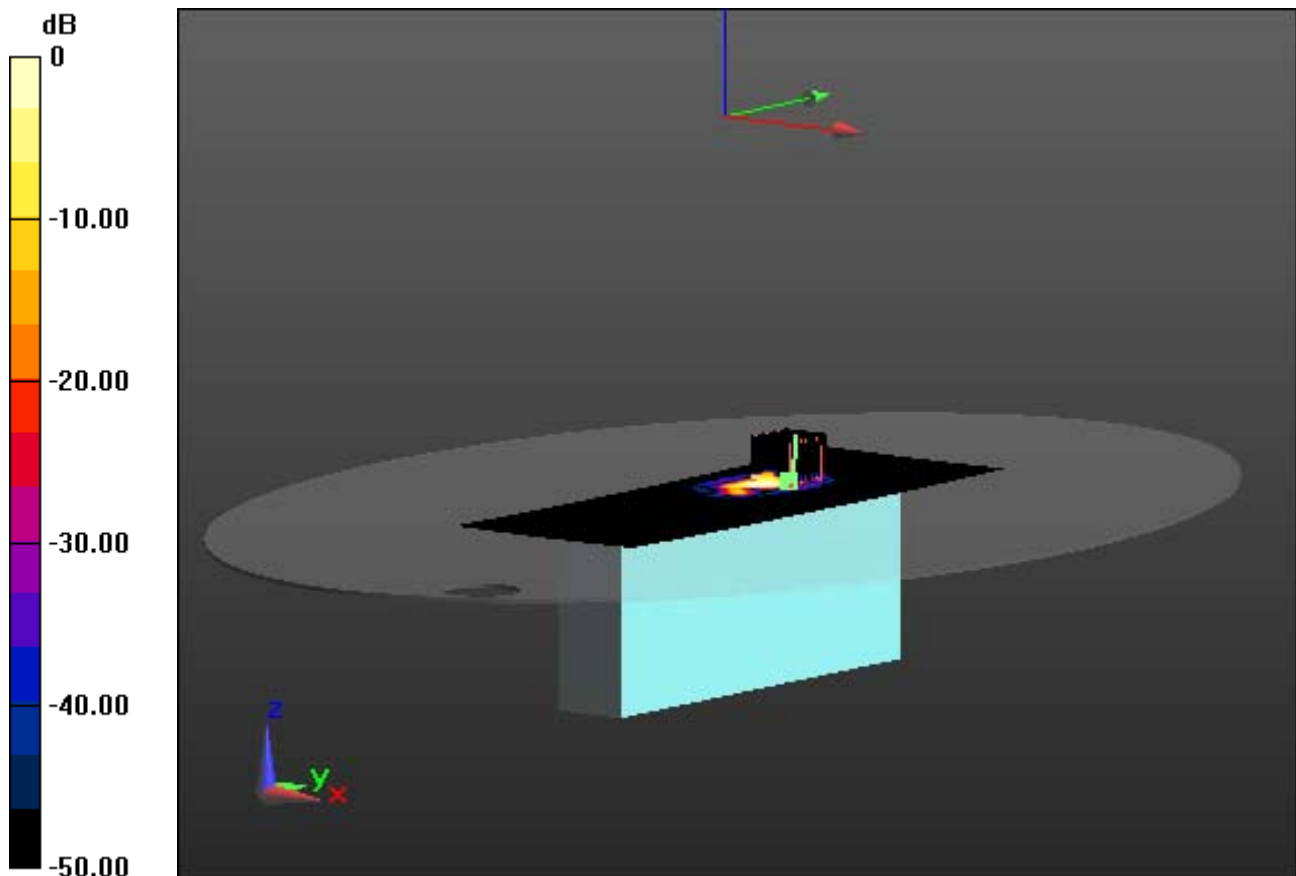

0 dB = 0.0668 W/kg

DT&C Co., Ltd.

DUT: PM450; Type: PDA

Communication System: W-LAN_5800 (0); Frequency: 5745 MHz; Duty Cycle: 1:1
Medium parameters used: $f = 5745$ MHz; $\sigma = 5.952$ S/m; $\epsilon_r = 46.978$; $\rho = 1000$ kg/m³
Phantom section: Flat Section

DASY5 Configuration:

Probe: EX3DV4 - SN3930; ConvF(4.21, 4.21, 4.21); Calibrated: 2014-07-22; Electronics: DAE4 Sn1394
Phantom: ELI v5.0; Type: QDOVA002AA; Serial: TP:1166
Measurement SW: DASY52, Version 52.8 (7); SEMCAD X Version 14.6.10 (7164)

Test Date: 2014-10-02; Ambient Temp: 20.1; Tissue Temp: 20.5

Touch from Body, Right, W-LAN(802.11a 5.8G) Ch. 149, Ant Internal

With Enlarge plot image

Area Scan (101x281x1): Interpolated grid: dx=10mm, dy=10mm

Zoom Scan (7x7x11)/Cube 0: Measurement grid: dx=4mm, dy=4mm, dz=2mm

Power Drift = 0.00 dB

Peak SAR (extrapolated) = 0.690 W/kg

SAR(1 g) = 0.061 W/kg; SAR(10 g) = 0.013 W/kg

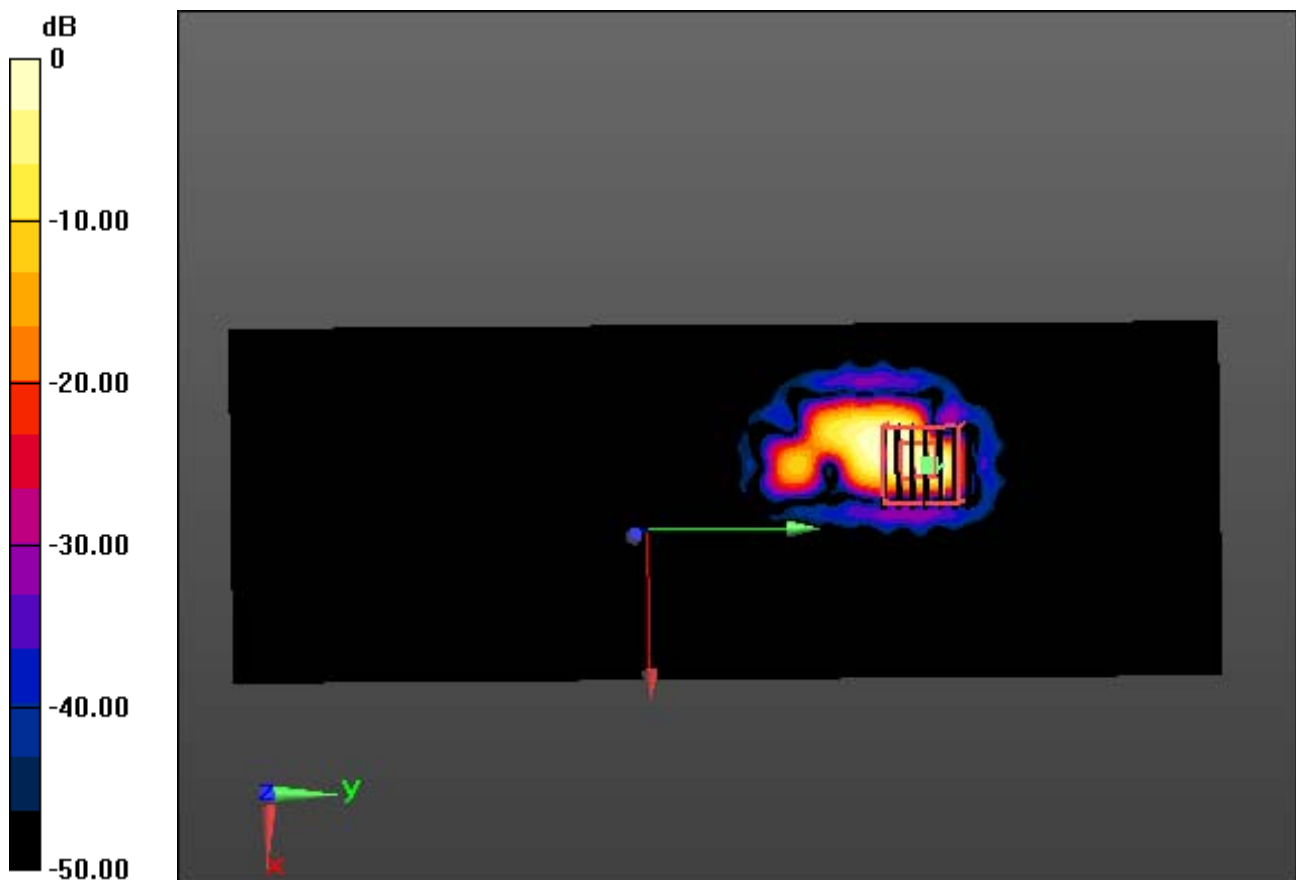

0 dB = 0.0668 W/kg

DT&C Co., Ltd.

DUT: PM450; Type: PDA

Communication System: W-LAN_5800 (0); Frequency: 5745 MHz; Duty Cycle: 1:1
Medium parameters used: $f = 5745$ MHz; $\sigma = 5.952$ S/m; $\epsilon_r = 46.978$; $\rho = 1000$ kg/m³
Phantom section: Flat Section

DASY5 Configuration:

Probe: EX3DV4 - SN3930; ConvF(4.21, 4.21, 4.21); Calibrated: 2014-07-22; Electronics: DAE4 Sn1394
Phantom: ELI v5.0; Type: QDOVA002AA; Serial: TP:1166
Measurement SW: DASY52, Version 52.8 (7); SEMCAD X Version 14.6.10 (7164)

Test Date: 2014-10-02; Ambient Temp: 20.1; Tissue Temp: 20.5

Touch from Body, Right, W-LAN(802.11a 5.8G) Ch. 149, Ant Internal

Area Scan (101x281x1): Interpolated grid: dx=10mm, dy=10mm

Zoom Scan (7x7x11)/Cube 0: Measurement grid: dx=4mm, dy=4mm, dz=2mm
Power Drift = 0.00 dB

Peak SAR (extrapolated) = 0.690 W/kg

SAR(1 g) = 0.061 W/kg; SAR(10 g) = 0.013 W/kg

