



# FCC TEST REPORT (CO-LOCATED)

**REPORT NO.:** RF110311C24A-7 R2

**MODEL NO.:** MC75A6HF

**FCC ID:** UZ7MC75A6HF

**RECEIVED:** Mar. 07, 2011

**TESTED:** Apr. 15, 2011

**ISSUED:** Jun. 03, 2011

**APPLICANT:** Motorola Solutions Inc.

**ADDRESS:** One Motorola Plaza, Holtsville, NY 11742-1300  
USA

**ISSUED BY:** Bureau Veritas Consumer Products Services  
(H.K.) Ltd., Taoyuan Branch

**LAB ADDRESS:** No. 47, 14th Ling, Chia Pau Tsuen, Lin Kou  
Hsiang, Taipei Hsien 244, Taiwan, R.O.C.

**TEST LOCATION:** No. 19, Hwa Ya 2nd Rd, Wen Hwa Tsuen, Kwei  
Shan Hsiang, Taoyuan Hsien 333, Taiwan,  
R.O.C.

This test report consists of 73 pages in total. It may be duplicated completely for legal use with the approval of the applicant. It should not be reproduced except in full, without the written approval of our laboratory. The client should not use it to claim product certification, approval or endorsement by TAF or any government agency. The test results in the report only apply to the tested sample.





## TABLE OF CONTENTS

RELEASE CONTROL RECORD .....	3
1. CERTIFICATION.....	4
2. SUMMARY OF TEST RESULTS .....	5
2.1 MEASUREMENT UNCERTAINTY .....	5
3. GENERAL INFORMATION.....	6
3.1 GENERAL DESCRIPTION OF EUT .....	6
3.2 DESCRIPTION OF TEST MODES .....	9
3.2.1 CONFIGURATION OF SYSTEM UNDER TEST .....	12
3.2.2 DESCRIPTION OF TEST MODES .....	13
3.3 GENERAL DESCRIPTION OF APPLIED STANDARDS .....	14
3.4 DESCRIPTION OF SUPPORT UNITS .....	15
4. TEST TYPES AND RESULTS .....	16
4.1 RADIATED EMISSION MEASUREMENT .....	16
4.1.1 LIMITS OF RADIATED EMISSION MEASUREMENT .....	16
4.1.2 LIMITS OF UNWANTED EMISSION OUT OF THE RESTRICTED BANDS .....	16
4.1.3 TEST INSTRUMENTS.....	17
4.1.4 TEST PROCEDURES .....	18
4.1.5 DEVIATION FROM TEST STANDARD.....	18
4.1.6 TEST SETUP.....	19
4.1.7 EUT OPERATING CONDITIONS .....	19
4.1.8 TEST RESULTS .....	20
4.2 CONDUCTED EMISSION MEASUREMENT .....	44
4.2.1 LIMITS OF CONDUCTED EMISSION MEASUREMENT .....	44
4.2.2 TEST INSTRUMENTS.....	44
4.2.3 TEST PROCEDURES .....	45
4.2.4 DEVIATION FROM TEST STANDARD.....	45
4.2.5 TEST SETUP .....	46
4.2.6 EUT OPERATING CONDITIONS .....	46
4.2.7 TEST RESULTS .....	47
5. PHOTOGRAPHS OF THE TEST CONFIGURATION.....	71
6. INFORMATION ON THE TESTING LABORATORIES .....	72
7. APPENDIX A - MODIFICATIONS RECORDERS FOR ENGINEERING CHANGES TO THE EUT BY THE LAB.....	73



## RELEASE CONTROL RECORD

ISSUE NO.	REASON FOR CHANGE	DATE ISSUED
Original release	NA	Apr. 20, 2011
RF110311C24A-7 R1	Added reference section of standard	Jun. 02, 2011
RF110311C24A-7 R2	Modified item 3.1 description	Jun. 03, 2011



## 1. CERTIFICATION

**PRODUCT:** Mobile Computer  
**MODEL NO.:** MC75A6HF  
**BRAND:** Motorola  
**APPLICANT:** Motorola Solutions Inc.  
**TEST SAMPLE:** ENGINEERING SAMPLE  
**TESTED:** Apr. 15, 2011  
**STANDARDS:** **FCC Part 15, Subpart C (Section 15.247)**  
**FCC Part 15, Subpart C (Section 15.225)**  
**FCC Part 15, Subpart C (Section 15.215)**  
**FCC Part 15, Subpart E (Section 15.407)**  
**FCC Part 22, Subpart H**  
**FCC Part 24, Subpart E**  
ANSI C63.4-2003  
ANSI C63.10-2009

The above equipment (Model: MC75A6HF) has been tested by **Bureau Veritas Consumer Products Services (H.K.) Ltd., Taoyuan Branch**, and found compliance with the requirement of the above standards. The test record, data evaluation & Equipment Under Test (EUT) configurations represented herein are true and accurate accounts of the measurements of the sample's EMC characteristics under the conditions specified in this report.

PREPARED BY : Andrea Hsia , DATE: Jun. 03, 2011  
Andrea Hsia / Specialist

APPROVED BY : Gary Chang , DATE: Jun. 03, 2011  
Gary Chang / Assistant Manager

## 2. SUMMARY OF TEST RESULTS

The EUT has been tested according to the following specifications:

<b>APPLIED STANDARD:</b>	<b>FCC Part 15, Subpart C (Section 15.247)</b> <b>FCC Part 15, Subpart C (Section 15.225)</b> <b>FCC Part 15, Subpart C (Section 15.215)</b> <b>FCC Part 15, Subpart E (Section 15.407)</b> <b>FCC Part 22, Subpart H</b> <b>FCC Part 24, Subpart E</b>		
STANDARD SECTION	TEST TYPE AND LIMIT	RESULT	REMARK
15.207 15.407(b)(5)	AC Power Conducted Emission	PASS	Meet the requirement of limit. Minimum passing margin is -16.86dB at 27.120MHz.
15.247(d) 15.407(b/1/2/3) (b)(5) 15.225 (d) 2.1053 22.917 24.238	Radiated Emissions	PASS	Meet the requirement of limit. Minimum passing margin is -6.5dB at 39.65 & 40.52MHz.

### 2.1 MEASUREMENT UNCERTAINTY

Where relevant, the following measurement uncertainty levels have been estimated for tests performed on the EUT as specified in CISPR 16-4-2:

MEASUREMENT	FREQUENCY	UNCERTAINTY
Conducted emissions	9kHz~30MHz	2.44 dB
Radiated emissions	30MHz ~ 200MHz	3.34 dB
	200MHz ~1000MHz	3.35 dB
	1GHz ~ 18GHz	2.26 dB
	18GHz ~ 40GHz	1.94 dB

This uncertainty represents an expanded uncertainty expressed at approximately the 95% confidence level using a coverage factor of  $k = 2$ .



### 3. GENERAL INFORMATION

#### 3.1 GENERAL DESCRIPTION OF EUT

<b>EUT</b>	Mobile Computer	
<b>MODEL NO.</b>	MC75A6HF	
<b>FCC ID</b>	UZ7MC75A6HF	
<b>POWER SUPPLY</b>	3.7Vdc (Li-ion battery) 5.4Vdc (Adapter)	
<b>MODULATION TYPE</b>	<b>WLAN</b>	CCK, DQPSK, DBPSK for DSSS 64QAM, 16QAM, QPSK, BPSK for OFDM
	<b>BT</b>	GFSK, /4-DQPSK, 8DPSK
	<b>RFID</b>	ASK
	<b>GSM, GPRS, E-GPRS</b>	GMSK, 8PSK
	<b>WCDMA</b>	BPSK
<b>OPERATING FREQUENCY</b>	<b>WLAN</b>	<b>2.4GHz:</b> 2412 ~ 2472MHz <b>5.0GHz:</b> 5180 ~ 5320MHz, 5500 ~ 5700MHz, 5745 ~ 5825MHz
	<b>BT</b>	2402 ~ 2480MHz
	<b>RFID</b>	13.56MHz
	<b>GSM, GPRS, E-GPRS</b>	824.2MHz ~ 848.8MHz 1850.2MHz ~ 1909.8MHz
	<b>WCDMA</b>	826.4MHz ~ 846.6MHz 1852.4MHz ~ 1907.6MHz
<b>ANTENNA TYPE</b>	<b>WLAN</b>	Refer to note as below
	<b>BT</b>	Chip antenna with -1.5dBi gain
	<b>RFID</b>	Loop antenna
	<b>GSM, GPRS, E-GPRS</b>	<b>For 850Band</b> Monopole antenna with 0.94dBi gain <b>For 1900Band</b> Monopole antenna with 2.02dBi gain
	<b>WCDMA</b>	<b>For 850Band</b> Monopole antenna with 0.94dBi gain <b>For 1900Band</b> Monopole antenna with 2.02dBi gain
<b>DATA CABLE</b>	NA	
<b>I/O PORTS</b>	Refer to user's manual	
<b>ACCESSORY DEVICES</b>	Battery	



**NOTE:**

1. The EUT is a Mobile Computer. The test data are separated into following test reports.

	TEST STANDARD	REFERENCE REPORT
WLAN 802.11b/g	FCC Part 15, Subpart C (Section 15.247)	RF110311C24A R1
WLAN 802.11a (5745~5825 MHz)		
WLAN 802.11a (5180~5320MHz, 5500~5700MHz )	FCC Part 15, Subpart E (Section 15.407)	RF110311C24A-1 R1
WLAN 802.11a (For DFS report) (5260~5320MHz, 5500~5700MHz )	FCC Part 15, Subpart E (Section 15.407)	RF110311C24A-3
BLUETOOTH	FCC Part 15, Subpart C (Section 15.247)	RF110311C24A-2 R1
RF ID	FCC Part 15, Subpart C (Section 15.225, 15.215)	RF110311C24A-4 R1
GSM 850 / WCDMA 850	FCC Part 22	RF110311C24A-5 R1
GSM 1900 / WCDMA 1900	FCC Part 24	RF110311C24A-6 R1
Co-Located Report	FCC Part 15, Subpart C (Section 15.247,15.225, 15.215 ) FCC Part 15, Subpart E (Section 15.407) FCC Part 22 FCC Part 24	RF110311C24A-7 R2

2. The EUT configuration is as below

BRAND	MODEL	DESCRIPTION
Motorola	MC75A6HF	HSDPA BB Numeric Camera

3. The EUT uses the following Li-ion battery:

BATTERY (1.5X)	
BRAND:	MOTOROLA
PART NUMBER:	82-71364-05
RATING:	3.7Vdc, 3600mAh, 13.3Wh

4. The EUT used two antennas listed as below:

ANTENNA ITEM	ANTENNA TYPE	TX/RX FUNCTION	ANTENNA CONNECTER	ANTENNA GAIN (dBi)	
				2.4GHz	5.0GHz
MAIN ANTENNA	inverted F	TX/RX	IPEX	1.09	5.30
AUX. ANTENNA	Planar inverted	RX only	IPEX	1.38	5.30

5. The following accessories are for optional units only.

PRODUCT	BRAND	MODEL	DESCRIPTION
RS232 charging cable	Motorola	25-102776-02R	1.2m non-shielded cable with one core
USB charging cable	Motorola	25-102775-02R	1.5m shielded cable with one core
Headset	Motorola	50-11300-050R	VR10 headset 0.8m non-shielded cable with one core
Power Supply Adaptor	Motorola	EADP-16BB A	I/P: 100-240Vac, 50-60Hz, 0.4A O/P: 5.4Vdc, 3A 1.8m non-shielded cable without core

6. The communicated functions of EUT listed as below:

		850MHz	1900MHz	With 802.11a/b/g + Bluetooth+GPS+RFID
2G	GSM	√	√	
	GPRS	√	√	
	E-GPRS	√	√	
3G	WCDMA	√	√	
	HSDPA	√	√	

7. Hardware version: EV3.

8. Software version: BSP 23.137.

9. IMEI Code: 355282030239490.

10. The above EUT information was declared by manufacturer and for more detailed features description, please refer to the manufacturer's specifications or user's manual.



### 3.2 DESCRIPTION OF TEST MODES

#### FOR 2.4GHz:

13 channels are provided for 802.11b, 802.11g:

CHANNEL	FREQUENCY	CHANNEL	FREQUENCY
1	2412MHz	8	2447MHz
2	2417MHz	9	2452MHz
3	2422MHz	10	2457MHz
4	2427MHz	11	2462MHz
5	2432MHz	12	2467MHz
6	2437MHz	13	2472MHz
7	2442MHz		

#### FOR 5.0GHz:

##### Operated in 5180 ~ 5320MHz

8 channels are provided for 802.11a

CHANNEL	FREQUENCY	CHANNEL	FREQUENCY
36	5180 MHz	52	5260 MHz
40	5200 MHz	56	5280 MHz
44	5220 MHz	60	5300 MHz
48	5240 MHz	64	5320 MHz

##### Operated in 5500 ~ 5700MHz

11 channels are provided for 802.11a

CHANNEL	FREQUENCY	CHANNEL	FREQUENCY
100	5500 MHz	124	5620 MHz
104	5520 MHz	128	5640 MHz
108	5540 MHz	132	5660 MHz
112	5560 MHz	136	5680 MHz
116	5580 MHz	140	5700 MHz
120	5600 MHz		

##### Operated in 5745 ~ 5825MHz

5 channels are provided for 802.11a:

CHANNEL	FREQUENCY	CHANNEL	FREQUENCY
149	5745MHz	161	5805MHz
153	5765MHz	165	5825MHz
157	5785MHz		



**FOR BT:**

79 channels are provided to this EUT:

CHANNEL	FREQ. (MHz)	CHANNEL	FREQ. (MHz)	CHANNEL	FREQ. (MHz)	CHANNEL	FREQ. (MHz)
0	2402	20	2422	40	2442	60	2462
1	2403	21	2423	41	2443	61	2463
2	2404	22	2424	42	2444	62	2464
3	2405	23	2425	43	2445	63	2465
4	2406	24	2426	44	2446	64	2466
5	2407	25	2427	45	2447	65	2467
6	2408	26	2428	46	2448	66	2468
7	2409	27	2429	47	2449	67	2469
8	2410	28	2430	48	2450	68	2470
9	2411	29	2431	49	2451	69	2471
10	2412	30	2432	50	2452	70	2472
11	2413	31	2433	51	2453	71	2473
12	2414	32	2434	52	2454	72	2474
13	2415	33	2435	53	2455	73	2475
14	2416	34	2436	54	2456	74	2476
15	2417	35	2437	55	2457	75	2477
16	2418	36	2438	56	2458	76	2478
17	2419	37	2439	57	2459	77	2479
18	2420	38	2440	58	2460	78	2480
19	2421	39	2441	59	2461		

**FOR RFID:**

The EUT only have one channel.

CHANNEL	FREQUENCY (MHz)
1	13.56

### FOR GSM, GPRS & E-GPRS:

#### 850Band:

124 channels are provided to this EUT. Therefore, the low, middle and high channels are chosen for testing.

	CHANNEL	FREQUENCY	TX MODE
<b>LOW</b>	128	824.2 MHz	GSM, GPRS, E-GPRS
<b>MIDDLE</b>	190	836.6 MHz	GSM, GPRS, E-GPRS
<b>HIGH</b>	251	848.8 MHz	GSM, GPRS, E-GPRS

#### 1900Band:

299 channels are provided to this EUT. Therefore, the low, middle and high channels are chosen for testing.

	CHANNEL	FREQUENCY	TX MODE
<b>LOW</b>	512	1850.2 MHz	GSM, GPRS, E-GPRS
<b>MIDDLE</b>	661	1880.0 MHz	GSM, GPRS, E-GPRS
<b>HIGH</b>	810	1909.8 MHz	GSM, GPRS, E-GPRS

### FOR WCDMA:

#### 850Band:

102 channels are provided to this EUT. Therefore, the low, middle and high channels are chosen for testing.

	CHANNEL	FREQUENCY	TX MODE
<b>LOW</b>	4132	826.4 MHz	WCDMA
<b>MIDDLE</b>	4182	836.4 MHz	WCDMA
<b>HIGH</b>	4233	846.6 MHz	WCDMA

#### 1900Band:

277 channels are provided to this EUT. Therefore, the low, middle and high channels are chosen for testing.

	CHANNEL	FREQUENCY	TX MODE
<b>LOW</b>	9262	1852.4 MHz	WCDMA
<b>MIDDLE</b>	9400	1880.0 MHz	WCDMA
<b>HIGH</b>	9538	1907.6 MHz	WCDMA

### 3.2.1 CONFIGURATION OF SYSTEM UNDER TEST

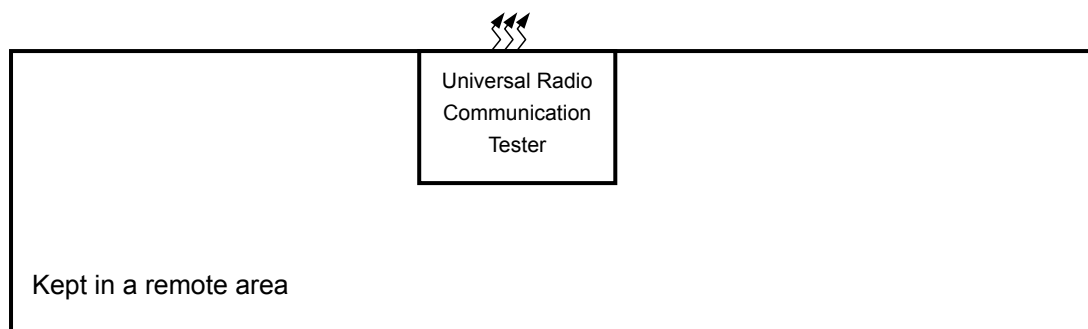
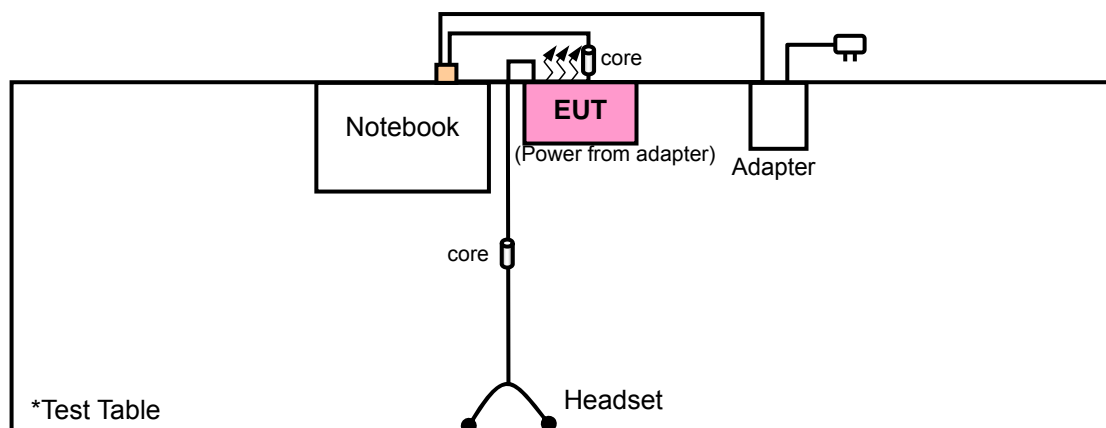

### 3.2.2 DESCRIPTION OF TEST MODES

Test Modes are presented in the report as below.

TEST MODE	TEST CONDITION	FREQ. RANGE (MHz)	AVAILABLE CHANNEL	TESTED CHANNEL	MODULATION TECHNOLOGY	AXIS
A1	802.11b + GSM 850 Band + BT+RFID	2412 ~ 2462	1 to 11	11 + 190 + 39 + 1	OFDM	Z
		824.2 ~ 848.8	128 to 251		GSM	
		2402 ~ 2480	0 to 78		FHSS	
		13.56	1		ASK	
A2	802.11a + GSM 850 Band + BT+RFID	5180~5320 & 5500 ~ 5700	36 to 64 & 100 to 140	132 + 190 + 39 + 1	OFDM	
		824.2 ~ 848.8	128 to 251		GSM	
		2402 ~ 2480	0 to 78		FHSS	
		13.56	1		ASK	
A3	802.11a + GSM 850 Band + BT+RFID	5745 ~ 5825	149 to 165	157 + 190 + 39 + 1	OFDM	
		824.2 ~ 848.8	128 to 251		GSM	
		2402 ~ 2480	0 to 78		FHSS	
		13.56	1		ASK	
B1	802.11b + GSM 1900 Band + BT+RFID	2412 ~ 2462	1 to 11	11 + 512 + 39 + 1	OFDM	
		1850.2 ~ 1909.8	512 to 810		GSM	
		2402 ~ 2480	0 to 78		FHSS	
		13.56	1		ASK	
B2	802.11a + GSM 1900 Band + BT+RFID	5180~5320 & 5500 ~ 5700	36 to 64 & 100 to 140	132 + 512 + 39 + 1	OFDM	
		824.2 ~ 848.8	128 to 251		GSM	
		2402 ~ 2480	0 to 78		FHSS	
		13.56	1		ASK	
B3	802.11a + GSM 1900 Band + BT+RFID	5745 ~ 5825	149 to 165	157 + 512 + 39 + 1	OFDM	
		824.2 ~ 848.8	128 to 251		GSM	
		2402 ~ 2480	0 to 78		FHSS	
		13.56	1		ASK	
C1	802.11b + WCDNA 850 Band + BT+RFID	2412 ~ 2462	1 to 11	11 + 4233 + 39 + 1	OFDM	
		826.4 ~ 846.6	4132 to 4233		GSM	
		2402 ~ 2480	0 to 78		FHSS	
		13.56	1		ASK	
C2	802.11a + WCDNA 850 Band + BT+RFID	5180~5320 & 5500 ~ 5700	36 to 64 & 100 to 140	32 + 4233 + 39 + 1	OFDM	
		826.4 ~ 846.6	4132 to 4233		GSM	
		2402 ~ 2480	0 to 78		FHSS	
		13.56	1		ASK	
C3	802.11a + WCDMA 850 Band + BT+RFID	5745 ~ 5825	149 to 165	57 + 4233 + 39 + 1	OFDM	
		826.4 ~ 846.6	4132 to 4233		GSM	
		2402 ~ 2480	0 to 78		FHSS	
		13.56	1		ASK	
D1	802.11b + WCDNA 1900 Band + BT+RFID	2412 ~ 2462	1 to 11	11 + 9538 + 39 + 1	OFDM	
		1852.4 ~ 1907.6	9262 to 9538		GSM	
		2402 ~ 2480	0 to 78		FHSS	
		13.56	1		ASK	
D2	802.11a + WCDNA 1900 Band + BT+RFID	5180~5320 & 5500 ~ 5700	36 to 64 & 100 to 140	32 + 9538 + 39 + 1	OFDM	
		1852.4 ~ 1907.6	9262 to 9538		GSM	
		2402 ~ 2480	0 to 78		FHSS	
		13.56	1		ASK	
D3	802.11a + WCDNA 1900 Band + BT+RFID	5745 ~ 5825	149 to 165	57 + 9538 + 39 + 1	OFDM	
		1852.4 ~ 1907.6	9262 to 9538		GSM	
		2402 ~ 2480	0 to 78		FHSS	
		13.56	1		ASK	

**NOTE:** Test modes as above are composed of the worst emission channel of each band.



**TEST CONDITION:**

APPLICABLE TO	ENVIRONMENTAL CONDITIONS	INPUT POWER	TESTED BY
RE $\geq$ 1G	25deg. C, 68%RH, 1010 hPa	120Vac, 60Hz	Sun Lin
RE $<$ 1G	22deg. C, 58%RH, 1015 hPa	120Vac, 60Hz	Sun Lin
PLC	25deg. C, 65%RH, 1014 hPa	120Vac, 60Hz	David Huang

**3.3 GENERAL DESCRIPTION OF APPLIED STANDARDS**

The EUT is a RF Product. According to the specifications of the manufacturer, it must comply with the requirements of the following standards:

**FCC Part 15, Subpart C (Section 15.247)**

**FCC Part 15, Subpart C (Section 15.225)**

**FCC Part 15, Subpart C (Section 15.215)**

**FCC Part 15, Subpart E (Section 15.407)**

**FCC Part 22, Subpart H**

**FCC Part 24, Subpart E**

**ANSI C63.4-2003**

**ANSI C63.10-2009**

All test items have been performed and recorded as per the above standards.

### 3.4 DESCRIPTION OF SUPPORT UNITS

The EUT has been tested as an independent unit together with other necessary accessories or support units. The following support units or accessories were used to form a representative test configuration during the tests.

NO.	PRODUCT	BRAND	MODEL NO.	SERIAL NO.	FCC ID
1	NOTEBOOK	DELL	D531	CN-0XM006-48643-81U-2610	QDS-BRCM1020
2	UNIVERSAL RADIO COMMUNICATION TESTER	R&S	CMU200	104484	NA
3	NJZ-2000 (GPRS+WCDMA SIMULATOR)	JRC	NJZ-2000	ET00054	NA

NO.	SIGNAL CABLE DESCRIPTION OF THE ABOVE SUPPORT UNITS
1	10m RJ45 cable.
2	NA
3	NA

**NOTE 1:** All power cords of the above support units are non shielded (1.8m).

**NOTE 2:** Item 2-3 acted as a communication partners to transfer data.

## 4. TEST TYPES AND RESULTS

### 4.1 RADIATED EMISSION MEASUREMENT

#### 4.1.1 LIMITS OF RADIATED EMISSION MEASUREMENT

Emissions radiated outside of the specified bands, shall be according to the general radiated limits in 15.209 as following:

FREQUENCIES (MHz)	FIELD STRENGTH (microvolts/meter)	MEASUREMENT DISTANCE (meters)
0.009 ~ 0.490	2400/F(kHz)	300
0.490 ~ 1.705	24000/F(kHz)	30
1.705 ~ 30.0	30	30
30 ~ 88	100	3
88 ~ 216	150	3
216 ~ 960	200	3
Above 960	500	3

**NOTE:**

1. The lower limit shall apply at the transition frequencies.
2. Emission level (dBuV/m) = 20 log Emission level (uV/m).
3. As shown in 15.35(b), for frequencies above 1000MHz, the field strength limits are based on average detector, however, the peak field strength of any emission shall not exceed the maximum permitted average limits, specified above by more than 20dB under any condition of modulation.

#### 4.1.2 LIMITS OF UNWANTED EMISSION OUT OF THE RESTRICTED BANDS

FREQUENCIES (MHz)	EIRP LIMIT (dBm)	EQUIVALENT FIELD STRENGTH AT 3m (dBµV/m) *NOTE 3
	PK	PK
5150 ~ 5250	-27	68.3
5250 ~ 5350	-27	68.3
5470 ~ 5725	-27	68.3

**NOTE:**

The following formula is used to convert the equipment isotropic radiated power (eirp) to field strength:

$$E = \frac{1000000\sqrt{30P}}{3} \mu\text{V/m, where P is the eirp (Watts).}$$



#### 4.1.3 TEST INSTRUMENTS

DESCRIPTION & MANUFACTURER	MODEL NO.	SERIAL NO.	DATE OF CALIBRATION	DUE DATE OF CALIBRATION
Test Receiver ROHDE & SCHWARZ	ESCI	100424	Aug. 04, 2010	Aug. 03, 2011
Spectrum Analyzer ROHDE & SCHWARZ	FSP40	100041	Jul. 09, 2010	Jul. 08, 2011
BILOG Antenna SCHWARZBECK	VULB9168	9168-156	Apr. 30, 2010	Apr. 29, 2011
HORN Antenna SCHWARZBECK	BBHA 9120 D	9120D-209	Aug. 02, 2010	Aug. 01, 2011
HORN Antenna SCHWARZBECK	BBHA 9170	BBHA9170243	Dec. 27, 2010	Dec. 26, 2011
Preamplifier Agilent	8449B	3008A01910	Sep. 09, 2010	Sep. 08, 2011
Preamplifier Agilent	8447D	2944A10638	Nov. 03, 2010	Nov. 02, 2011
RF signal cable HUBER+SUHNNER	SUCOFLEX 104	218190/4 231241/4	May 14, 2010	May 13, 2011
RF signal cable Worken	8D-FB	Cable-HYCH9-01	Aug. 20, 2010	Aug. 19, 2011
Software	ADT_Radiated_ V7.6.15.9.2	NA	NA	NA
Antenna Tower EMCO	2070/2080	512.835.4684	NA	NA
Turn Table EMCO	2087-2.03	NA	NA	NA
Antenna Tower & Turn Table Controller EMCO	2090	NA	NA	NA
26GHz ~ 40GHz Amplifier	EM26400	07026401	Aug. 25, 2010	Aug. 24, 2011

- NOTE:**
1. The calibration interval of the above test instruments is 12 months and the calibrations are traceable to NML/ROC and NIST/USA.
  2. The test was performed in HwaYa Chamber 9.
  3. The horn antenna and HP preamplifier (model: 8449B) are used only for the measurement of emission frequency above 1GHz if tested.
  4. The FCC Site Registration No. is 460141.
  5. The IC Site Registration No. is IC 7450F-4.

#### 4.1.4 TEST PROCEDURES

- a. The EUT was placed on the top of a rotating table 0.8 meters above the ground at a 3 meters semi-anechoic chamber. The table was rotated 360 degrees to determine the position of the highest radiation.
- b. The EUT was set 3 meters away from the interference-receiving antenna, which was mounted on the top of a variable-height antenna tower.
- c. The antenna is a broadband antenna, and its height is varied from one meter to four meters above the ground to determine the maximum value of the field strength. Both horizontal and vertical polarizations of the antenna are set to make the measurement.
- d. For each suspected emission, the EUT was arranged to its worst case and then the antenna was tuned to heights from 1 meter to 4 meters and the rotatable table was turned from 0 degrees to 360 degrees to find the maximum reading.
- e. The test-receiver system was set to Peak Detect Function and Specified Bandwidth with Maximum Hold Mode.
- f. If the emission level of the EUT in peak mode was lower than the limit specified, then testing could be stopped and the peak values of the EUT would be reported. Otherwise the emissions would be re-tested one by one using peak, quasi-peak or average method as specified and then reported in a data sheet.

**NOTE:**

1. The resolution bandwidth and video bandwidth of test receiver/spectrum analyzer is 120kHz for Quasi-peak detection at frequency below 1GHz.
2. The resolution bandwidth of test receiver/spectrum analyzer is 1MHz and video bandwidth is 3MHz for Peak detection at frequency above 1GHz.
3. All modes of operation were investigated and the worst-case emissions are reported.

#### 4.1.5 DEVIATION FROM TEST STANDARD

No deviation

#### 4.1.6 TEST SETUP

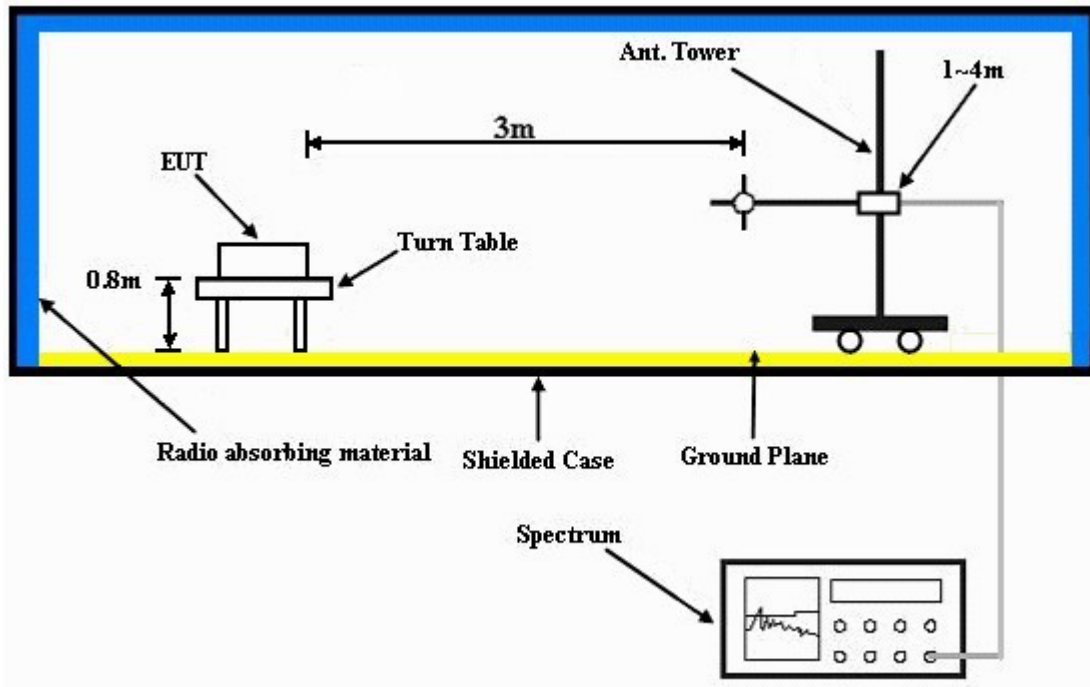

For the actual test configuration, please refer to the attached file (Test Setup Photo).

#### 4.1.7 EUT OPERATING CONDITIONS

- Connected the EUT to a notebook via USB cable and placed on a testing table.
- The EUT runs a test program (provided by manufacture) to transmit at specific channel.
- The necessary accessories enable the system in full functions.



#### 4.1.8 TEST RESULTS

#### ABOVE 1GHz WORST-CASE DATA: 802.11b + GSM 850 Band + BT + RFID

EUT TEST CONDITION		MEASUREMENT DETAIL	
CHANNEL	CH11+CH190+CH39+CH1	FREQUENCY RANGE	1 ~ 40GHz
INPUT POWER (SYSTEM)	120Vac, 60Hz	DETECTOR FUNCTION	Peak (PK) Average (AV)
ENVIRONMENTAL CONDITIONS	25deg. C, 68%RH 1010 hPa	TEST MODE	A1
TESTED BY	Sun Lin		

ANTENNA POLARITY & TEST DISTANCE: HORIZONTAL AT 3 M								
NO.	FREQ. (MHz)	EMISSION LEVEL (dBuV/m)	LIMIT (dBuV/m)	MARGIN (dB)	ANTENNA HEIGHT (m)	TABLE ANGLE (Degree)	RAW VALUE (dBuV)	CORRECTION FACTOR (dB/m)
1	3298.60	37.7 PK	74.0	-36.3	1.35 H	68	4.80	32.90
2	3298.60	27.3 AV	54.0	-26.7	1.35 H	68	-5.60	32.90
ANTENNA POLARITY & TEST DISTANCE: VERTICAL AT 3 M								
NO.	FREQ. (MHz)	EMISSION LEVEL (dBuV/m)	LIMIT (dBuV/m)	MARGIN (dB)	ANTENNA HEIGHT (m)	TABLE ANGLE (Degree)	RAW VALUE (dBuV)	CORRECTION FACTOR (dB/m)
1	3298.60	41.7 PK	74.0	-32.3	1.05 V	232	8.80	32.90
2	3298.60	29.8 AV	54.0	-24.2	1.05 V	232	-3.10	32.90

- REMARKS:**
1. Emission level (dBuV/m) = Raw Value (dBuV) + Correction Factor (dB/m).
  2. Correction Factor (dB/m) = Antenna Factor (dB/m) + Cable Factor (dB).
  3. The other emission levels were very low against the limit.
  4. Margin value = Emission level – Limit value.



**802.11a + GSM 850 Band + BT + RFID**

EUT TEST CONDITION		MEASUREMENT DETAIL	
CHANNEL	CH132+CH190+CH39+CH1	FREQUENCY RANGE	1 ~ 40GHz
INPUT POWER (SYSTEM)	120Vac, 60Hz	DETECTOR FUNCTION	Peak (PK) Average (AV)
ENVIRONMENTAL CONDITIONS	25deg. C, 68%RH 1010 hPa	TEST MODE	A2
TESTED BY	Sun Lin		

ANTENNA POLARITY & TEST DISTANCE: HORIZONTAL AT 3 M								
NO.	FREQ. (MHz)	EMISSION LEVEL (dBuV/m)	LIMIT (dBuV/m)	MARGIN (dB)	ANTENNA HEIGHT (m)	TABLE ANGLE (Degree)	RAW VALUE (dBuV)	CORRECTION FACTOR (dB/m)
1	6496.60	45.8 PK	74.0	-28.2	1.58 H	328	4.80	41.00
2	6496.60	34.0 AV	54.0	-20.0	1.58 H	328	-7.00	41.00
ANTENNA POLARITY & TEST DISTANCE: VERTICAL AT 3 M								
NO.	FREQ. (MHz)	EMISSION LEVEL (dBuV/m)	LIMIT (dBuV/m)	MARGIN (dB)	ANTENNA HEIGHT (m)	TABLE ANGLE (Degree)	RAW VALUE (dBuV)	CORRECTION FACTOR (dB/m)
1	6496.60	48.9 PK	74.0	-25.1	1.22 V	158	7.90	41.00
2	6496.60	37.7 AV	54.0	-16.3	1.22 V	158	-3.30	41.00

- REMARKS:**
1. Emission level (dBuV/m) = Raw Value (dBuV) + Correction Factor (dB/m).
  2. Correction Factor (dB/m) = Antenna Factor (dB/m) + Cable Factor (dB).
  3. The other emission levels were very low against the limit.
  4. Margin value = Emission level – Limit value.



802.11a + GSM 850 Band + BT + RFID

EUT TEST CONDITION		MEASUREMENT DETAIL	
CHANNEL	CH157+CH190+CH39+CH1	FREQUENCY RANGE	1 ~ 40GHz
INPUT POWER (SYSTEM)	120Vac, 60Hz	DETECTOR FUNCTION	Peak (PK) Average (AV)
ENVIRONMENTAL CONDITIONS	25deg. C, 68%RH 1010 hPa	TEST MODE	A3
TESTED BY	Sun Lin		

ANTENNA POLARITY & TEST DISTANCE: HORIZONTAL AT 3 M								
NO.	FREQ. (MHz)	EMISSION LEVEL (dBuV/m)	LIMIT (dBuV/m)	MARGIN (dB)	ANTENNA HEIGHT (m)	TABLE ANGLE (Degree)	RAW VALUE (dBuV)	CORRECTION FACTOR (dB/m)
1	6621.60	45.3 PK	74.0	-28.7	1.21 H	22	3.90	41.40
2	6621.60	34.7 AV	54.0	-19.3	1.21 H	22	-6.70	41.40
ANTENNA POLARITY & TEST DISTANCE: VERTICAL AT 3 M								
NO.	FREQ. (MHz)	EMISSION LEVEL (dBuV/m)	LIMIT (dBuV/m)	MARGIN (dB)	ANTENNA HEIGHT (m)	TABLE ANGLE (Degree)	RAW VALUE (dBuV)	CORRECTION FACTOR (dB/m)
1	6621.60	48.1 PK	74.0	-25.9	1.07 V	295	6.70	41.40
2	6621.60	37.0 AV	54.0	-17.0	1.07 V	295	-4.40	41.40

- REMARKS:**
1. Emission level (dBuV/m) = Raw Value (dBuV) + Correction Factor (dB/m).
  2. Correction Factor (dB/m) = Antenna Factor (dB/m) + Cable Factor (dB).
  3. The other emission levels were very low against the limit.
  4. Margin value = Emission level – Limit value.



**802.11b + GSM 1900 Band + BT + RFID**

EUT TEST CONDITION		MEASUREMENT DETAIL	
CHANNEL	CH11+CH512+CH39+CH1	FREQUENCY RANGE	1 ~ 40GHz
INPUT POWER (SYSTEM)	120Vac, 60Hz	DETECTOR FUNCTION	Peak (PK) Average (AV)
ENVIRONMENTAL CONDITIONS	25deg. C, 68%RH 1010 hPa	TEST MODE	B1
TESTED BY	Sun Lin		

ANTENNA POLARITY & TEST DISTANCE: HORIZONTAL AT 3 M								
NO.	FREQ. (MHz)	EMISSION LEVEL (dBuV/m)	LIMIT (dBuV/m)	MARGIN (dB)	ANTENNA HEIGHT (m)	TABLE ANGLE (Degree)	RAW VALUE (dBuV)	CORRECTION FACTOR (dB/m)
1	4312.20	39.8 PK	74.0	-34.2	1.38 H	218	4.50	35.30
2	4312.20	28.8 AV	54.0	-25.2	1.38 H	218	-6.50	35.30
ANTENNA POLARITY & TEST DISTANCE: VERTICAL AT 3 M								
NO.	FREQ. (MHz)	EMISSION LEVEL (dBuV/m)	LIMIT (dBuV/m)	MARGIN (dB)	ANTENNA HEIGHT (m)	TABLE ANGLE (Degree)	RAW VALUE (dBuV)	CORRECTION FACTOR (dB/m)
1	4312.20	42.8 PK	74.0	-31.2	1.22 V	38	7.50	35.30
2	4312.20	30.8 AV	54.0	-23.2	1.22 V	38	-4.50	35.30

- REMARKS:**
1. Emission level (dBuV/m) = Raw Value (dBuV) + Correction Factor (dB/m).
  2. Correction Factor (dB/m) = Antenna Factor (dB/m) + Cable Factor (dB).
  3. The other emission levels were very low against the limit.
  4. Margin value = Emission level – Limit value.



**802.11a + GSM 1900 Band + BT + RFID**

EUT TEST CONDITION		MEASUREMENT DETAIL	
CHANNEL	CH132+CH512+CH39+CH1	FREQUENCY RANGE	1 ~ 40GHz
INPUT POWER (SYSTEM)	120Vac, 60Hz	DETECTOR FUNCTION	Peak (PK) Average (AV)
ENVIRONMENTAL CONDITIONS	25deg. C, 68%RH 1010 hPa	TEST MODE	B2
TESTED BY	Sun Lin		

ANTENNA POLARITY & TEST DISTANCE: HORIZONTAL AT 3 M								
NO.	FREQ. (MHz)	EMISSION LEVEL (dBuV/m)	LIMIT (dBuV/m)	MARGIN (dB)	ANTENNA HEIGHT (m)	TABLE ANGLE (Degree)	RAW VALUE (dBuV)	CORRECTION FACTOR (dB/m)
1	7510.20	46.0 PK	74.0	-28.0	1.22 H	47	2.30	43.70
2	7510.20	34.6 AV	54.0	-19.4	1.22 H	47	-9.10	43.70
ANTENNA POLARITY & TEST DISTANCE: VERTICAL AT 3 M								
NO.	FREQ. (MHz)	EMISSION LEVEL (dBuV/m)	LIMIT (dBuV/m)	MARGIN (dB)	ANTENNA HEIGHT (m)	TABLE ANGLE (Degree)	RAW VALUE (dBuV)	CORRECTION FACTOR (dB/m)
1	7510.20	47.7 PK	74.0	-26.3	1.37 V	198	4.00	43.70
2	7510.20	38.0 AV	54.0	-16.0	1.37 V	198	-5.70	43.70

- REMARKS:**
1. Emission level (dBuV/m) = Raw Value (dBuV) + Correction Factor (dB/m).
  2. Correction Factor (dB/m) = Antenna Factor (dB/m) + Cable Factor (dB).
  3. The other emission levels were very low against the limit.
  4. Margin value = Emission level – Limit value.





802.11a + GSM 1900 Band + BT + RFID

EUT TEST CONDITION		MEASUREMENT DETAIL	
CHANNEL	CH157+CH512+CH39+CH1	FREQUENCY RANGE	1 ~ 40GHz
INPUT POWER (SYSTEM)	120Vac, 60Hz	DETECTOR FUNCTION	Peak (PK) Average (AV)
ENVIRONMENTAL CONDITIONS	25deg. C, 68%RH 1010 hPa	TEST MODE	B3
TESTED BY	Sun Lin		

ANTENNA POLARITY & TEST DISTANCE: HORIZONTAL AT 3 M								
NO.	FREQ. (MHz)	EMISSION LEVEL (dBuV/m)	LIMIT (dBuV/m)	MARGIN (dB)	ANTENNA HEIGHT (m)	TABLE ANGLE (Degree)	RAW VALUE (dBuV)	CORRECTION FACTOR (dB/m)
1	7635.20	45.7 PK	74.0	-28.3	1.15 H	228	1.70	44.00
2	7635.20	34.5 AV	54.0	-19.5	1.15 H	228	-9.50	44.00
ANTENNA POLARITY & TEST DISTANCE: VERTICAL AT 3 M								
NO.	FREQ. (MHz)	EMISSION LEVEL (dBuV/m)	LIMIT (dBuV/m)	MARGIN (dB)	ANTENNA HEIGHT (m)	TABLE ANGLE (Degree)	RAW VALUE (dBuV)	CORRECTION FACTOR (dB/m)
1	7635.20	47.8 PK	74.0	-26.2	1.27 V	359	3.80	44.00
2	7635.20	37.6 AV	54.0	-16.4	1.27 V	359	-6.40	44.00

- REMARKS:**
1. Emission level (dBuV/m) = Raw Value (dBuV) + Correction Factor (dB/m).
  2. Correction Factor (dB/m) = Antenna Factor (dB/m) + Cable Factor (dB).
  3. The other emission levels were very low against the limit.
  4. Margin value = Emission level – Limit value.



**802.11b + WCDMA 850 Band + BT + RFID**

EUT TEST CONDITION		MEASUREMENT DETAIL	
CHANNEL	CH11+CH4233+CH39+CH1	FREQUENCY RANGE	1 ~ 40GHz
INPUT POWER (SYSTEM)	120Vac, 60Hz	DETECTOR FUNCTION	Peak (PK) Average (AV)
ENVIRONMENTAL CONDITIONS	25deg. C, 68%RH 1010 hPa	TEST MODE	C1
TESTED BY	Sun Lin		

ANTENNA POLARITY & TEST DISTANCE: HORIZONTAL AT 3 M								
NO.	FREQ. (MHz)	EMISSION LEVEL (dBuV/m)	LIMIT (dBuV/m)	MARGIN (dB)	ANTENNA HEIGHT (m)	TABLE ANGLE (Degree)	RAW VALUE (dBuV)	CORRECTION FACTOR (dB/m)
1	3308.60	40.6 PK	74.0	-33.4	1.25 H	212	7.70	32.90
2	3308.60	29.7 AV	54.0	-24.3	1.25 H	212	-3.20	32.90
ANTENNA POLARITY & TEST DISTANCE: VERTICAL AT 3 M								
NO.	FREQ. (MHz)	EMISSION LEVEL (dBuV/m)	LIMIT (dBuV/m)	MARGIN (dB)	ANTENNA HEIGHT (m)	TABLE ANGLE (Degree)	RAW VALUE (dBuV)	CORRECTION FACTOR (dB/m)
1	3308.60	43.7 PK	74.0	-30.3	1.47 V	168	10.80	32.90
2	3308.60	32.6 AV	54.0	-21.4	1.47 V	168	-0.30	32.90

- REMARKS:**
1. Emission level (dBuV/m) = Raw Value (dBuV) + Correction Factor (dB/m).
  2. Correction Factor (dB/m) = Antenna Factor (dB/m) + Cable Factor (dB).
  3. The other emission levels were very low against the limit.
  4. Margin value = Emission level – Limit value.



802.11a + WCDMA 850 Band + BT + RFID

EUT TEST CONDITION		MEASUREMENT DETAIL	
CHANNEL	CH132+CH4233+CH39+CH1	FREQUENCY RANGE	1 ~ 40GHz
INPUT POWER (SYSTEM)	120Vac, 60Hz	DETECTOR FUNCTION	Peak (PK) Average (AV)
ENVIRONMENTAL CONDITIONS	25deg. C, 68%RH 1010 hPa	TEST MODE	C2
TESTED BY	Sun Lin		

ANTENNA POLARITY & TEST DISTANCE: HORIZONTAL AT 3 M								
NO.	FREQ. (MHz)	EMISSION LEVEL (dBuV/m)	LIMIT (dBuV/m)	MARGIN (dB)	ANTENNA HEIGHT (m)	TABLE ANGLE (Degree)	RAW VALUE (dBuV)	CORRECTION FACTOR (dB/m)
1	6506.60	45.3 PK	74.0	-28.7	1.01 H	198	4.30	41.00
2	6506.60	34.8 AV	54.0	-19.2	1.01 H	198	-6.20	41.00
ANTENNA POLARITY & TEST DISTANCE: VERTICAL AT 3 M								
NO.	FREQ. (MHz)	EMISSION LEVEL (dBuV/m)	LIMIT (dBuV/m)	MARGIN (dB)	ANTENNA HEIGHT (m)	TABLE ANGLE (Degree)	RAW VALUE (dBuV)	CORRECTION FACTOR (dB/m)
1	6506.60	48.6 PK	74.0	-25.4	1.52 V	247	7.60	41.00
2	6506.60	38.0 AV	54.0	-16.0	1.52 V	247	-3.00	41.00

- REMARKS:**
1. Emission level (dBuV/m) = Raw Value (dBuV) + Correction Factor (dB/m).
  2. Correction Factor (dB/m) = Antenna Factor (dB/m) + Cable Factor (dB).
  3. The other emission levels were very low against the limit.
  4. Margin value = Emission level – Limit value.



802.11a + WCDMA 850 Band + BT + RFID

EUT TEST CONDITION		MEASUREMENT DETAIL	
CHANNEL	CH157+CH4233+CH39+CH1	FREQUENCY RANGE	1 ~ 40GHz
INPUT POWER (SYSTEM)	120Vac, 60Hz	DETECTOR FUNCTION	Peak (PK) Average (AV)
ENVIRONMENTAL CONDITIONS	25deg. C, 68%RH 1010 hPa	TEST MODE	C3
TESTED BY	Sun Lin		

ANTENNA POLARITY & TEST DISTANCE: HORIZONTAL AT 3 M								
NO.	FREQ. (MHz)	EMISSION LEVEL (dBuV/m)	LIMIT (dBuV/m)	MARGIN (dB)	ANTENNA HEIGHT (m)	TABLE ANGLE (Degree)	RAW VALUE (dBuV)	CORRECTION FACTOR (dB/m)
1	6631.60	45.2 PK	74.0	-28.8	1.27 H	105	3.80	41.40
2	6631.60	34.7 AV	54.0	-19.3	1.27 H	105	-6.70	41.40
ANTENNA POLARITY & TEST DISTANCE: VERTICAL AT 3 M								
NO.	FREQ. (MHz)	EMISSION LEVEL (dBuV/m)	LIMIT (dBuV/m)	MARGIN (dB)	ANTENNA HEIGHT (m)	TABLE ANGLE (Degree)	RAW VALUE (dBuV)	CORRECTION FACTOR (dB/m)
1	6631.60	49.0 PK	74.0	-25.0	1.28 V	278	7.60	41.40
2	6631.60	38.9 AV	54.0	-15.1	1.28 V	278	-2.50	41.40

- REMARKS:**
1. Emission level (dBuV/m) = Raw Value (dBuV) + Correction Factor (dB/m).
  2. Correction Factor (dB/m) = Antenna Factor (dB/m) + Cable Factor (dB).
  3. The other emission levels were very low against the limit.
  4. Margin value = Emission level – Limit value.



**802.11b + WCDMA 1900 Band + BT + RFID**

EUT TEST CONDITION		MEASUREMENT DETAIL	
CHANNEL	CH11+CH9538+CH39+CH1	FREQUENCY RANGE	1 ~ 40GHz
INPUT POWER (SYSTEM)	120Vac, 60Hz	DETECTOR FUNCTION	Peak (PK) Average (AV)
ENVIRONMENTAL CONDITIONS	25deg. C, 68%RH 1010 hPa	TEST MODE	D1
TESTED BY	Sun Lin		

ANTENNA POLARITY & TEST DISTANCE: HORIZONTAL AT 3 M								
NO.	FREQ. (MHz)	EMISSION LEVEL (dBuV/m)	LIMIT (dBuV/m)	MARGIN (dB)	ANTENNA HEIGHT (m)	TABLE ANGLE (Degree)	RAW VALUE (dBuV)	CORRECTION FACTOR (dB/m)
1	4369.60	40.8 PK	74.0	-33.2	1.02 H	228	5.40	35.40
2	4369.60	29.3 AV	54.0	-24.7	1.02 H	228	-6.10	35.40
ANTENNA POLARITY & TEST DISTANCE: VERTICAL AT 3 M								
NO.	FREQ. (MHz)	EMISSION LEVEL (dBuV/m)	LIMIT (dBuV/m)	MARGIN (dB)	ANTENNA HEIGHT (m)	TABLE ANGLE (Degree)	RAW VALUE (dBuV)	CORRECTION FACTOR (dB/m)
1	4369.60	43.6 PK	74.0	-30.4	1.22 V	62	8.20	35.40
2	4369.60	32.5 AV	54.0	-21.5	1.22 V	62	-2.90	35.40

- REMARKS:**
1. Emission level (dBuV/m) = Raw Value (dBuV) + Correction Factor (dB/m).
  2. Correction Factor (dB/m) = Antenna Factor (dB/m) + Cable Factor (dB).
  3. The other emission levels were very low against the limit.
  4. Margin value = Emission level – Limit value.



**802.11a + WCDMA 1900 Band + BT + RFID**

EUT TEST CONDITION		MEASUREMENT DETAIL	
CHANNEL	CH132+CH9538+CH39+CH1	FREQUENCY RANGE	1 ~ 40GHz
INPUT POWER (SYSTEM)	120Vac, 60Hz	DETECTOR FUNCTION	Peak (PK) Average (AV)
ENVIRONMENTAL CONDITIONS	25deg. C, 68%RH 1010 hPa	TEST MODE	D2
TESTED BY	Sun Lin		

ANTENNA POLARITY & TEST DISTANCE: HORIZONTAL AT 3 M								
NO.	FREQ. (MHz)	EMISSION LEVEL (dBuV/m)	LIMIT (dBuV/m)	MARGIN (dB)	ANTENNA HEIGHT (m)	TABLE ANGLE (Degree)	RAW VALUE (dBuV)	CORRECTION FACTOR (dB/m)
1	7567.60	45.9 PK	74.0	-28.1	1.08 H	132	2.00	43.90
2	7567.60	34.8 AV	54.0	-19.2	1.08 H	132	-9.10	43.90
ANTENNA POLARITY & TEST DISTANCE: VERTICAL AT 3 M								
NO.	FREQ. (MHz)	EMISSION LEVEL (dBuV/m)	LIMIT (dBuV/m)	MARGIN (dB)	ANTENNA HEIGHT (m)	TABLE ANGLE (Degree)	RAW VALUE (dBuV)	CORRECTION FACTOR (dB/m)
1	7567.60	48.7 PK	74.0	-25.3	1.27 V	192	4.80	43.90
2	7567.60	37.9 AV	54.0	-16.1	1.27 V	192	-6.00	43.90

- REMARKS:**
1. Emission level (dBuV/m) = Raw Value (dBuV) + Correction Factor (dB/m).
  2. Correction Factor (dB/m) = Antenna Factor (dB/m) + Cable Factor (dB).
  3. The other emission levels were very low against the limit.
  4. Margin value = Emission level – Limit value.



802.11a + WCDMA 1900 Band + BT + RFID

EUT TEST CONDITION		MEASUREMENT DETAIL	
CHANNEL	CH157+CH9538+CH39+CH1	FREQUENCY RANGE	1 ~ 40GHz
INPUT POWER (SYSTEM)	120Vac, 60Hz	DETECTOR FUNCTION	Peak (PK) Average (AV)
ENVIRONMENTAL CONDITIONS	25deg. C, 68%RH 1010 hPa	TEST MODE	D3
TESTED BY	Sun Lin		

ANTENNA POLARITY & TEST DISTANCE: HORIZONTAL AT 3 M								
NO.	FREQ. (MHz)	EMISSION LEVEL (dBuV/m)	LIMIT (dBuV/m)	MARGIN (dB)	ANTENNA HEIGHT (m)	TABLE ANGLE (Degree)	RAW VALUE (dBuV)	CORRECTION FACTOR (dB/m)
1	7692.60	45.7 PK	74.0	-28.3	1.20 H	115	1.60	44.10
2	7692.60	34.3 AV	54.0	-19.7	1.20 H	115	-9.80	44.10
ANTENNA POLARITY & TEST DISTANCE: VERTICAL AT 3 M								
NO.	FREQ. (MHz)	EMISSION LEVEL (dBuV/m)	LIMIT (dBuV/m)	MARGIN (dB)	ANTENNA HEIGHT (m)	TABLE ANGLE (Degree)	RAW VALUE (dBuV)	CORRECTION FACTOR (dB/m)
1	7692.60	48.6 PK	74.0	-25.4	1.51 V	107	4.50	44.10
2	7692.60	37.7 AV	54.0	-16.3	1.51 V	107	-6.40	44.10

- REMARKS:**
1. Emission level (dBuV/m) = Raw Value (dBuV) + Correction Factor (dB/m).
  2. Correction Factor (dB/m) = Antenna Factor (dB/m) + Cable Factor (dB).
  3. The other emission levels were very low against the limit.
  4. Margin value = Emission level – Limit value.



**BELOW 1GHz WORST-CASE DATA :**

**802.11b + GSM 850 Band + BT + RFID**

EUT TEST CONDITION		MEASUREMENT DETAIL	
CHANNEL	CH11+CH190+CH39+CH1	FREQUENCY RANGE	Below 1000MHz
INPUT POWER (SYSTEM)	120Vac, 60Hz	DETECTOR FUNCTION	Quasi-Peak
ENVIRONMENTAL CONDITIONS	25deg. C, 68%RH 1010 hPa	TEST MODE	A1
TESTED BY	Sun Lin		

ANTENNA POLARITY & TEST DISTANCE: HORIZONTAL AT 3 M								
NO.	FREQ. (MHz)	EMISSION LEVEL (dBuV/m)	LIMIT (dBuV/m)	MARGIN (dB)	ANTENNA HEIGHT (m)	TABLE ANGLE (Degree)	RAW VALUE (dBuV)	CORRECTION FACTOR (dB/m)
1	101.84	25.0 QP	43.5	-18.5	2.00 H	79	15.50	9.50
2	132.95	30.4 QP	43.5	-13.1	2.00 H	34	17.60	12.80
3	191.28	28.8 QP	43.5	-14.7	1.25 H	40	17.20	11.60
4	265.16	31.0 QP	46.0	-15.0	1.00 H	10	17.80	13.20
5	529.58	26.5 QP	46.0	-19.5	1.50 H	43	6.40	20.10
6	566.52	26.9 QP	46.0	-19.1	1.25 H	43	5.90	21.00

ANTENNA POLARITY & TEST DISTANCE: VERTICAL AT 3 M								
NO.	FREQ. (MHz)	EMISSION LEVEL (dBuV/m)	LIMIT (dBuV/m)	MARGIN (dB)	ANTENNA HEIGHT (m)	TABLE ANGLE (Degree)	RAW VALUE (dBuV)	CORRECTION FACTOR (dB/m)
1	39.78	33.2 QP	40.0	-6.8	1.02 V	25	19.60	13.60
2	132.95	31.5 QP	43.5	-12.0	1.00 V	277	18.70	12.80
3	166.00	29.5 QP	43.5	-14.0	1.00 V	109	16.00	13.50
4	265.16	31.3 QP	46.0	-14.7	1.50 V	43	18.10	13.20
5	529.58	28.1 QP	46.0	-17.9	1.25 V	70	8.00	20.10
6	731.79	29.1 QP	46.0	-16.9	1.25 V	79	6.40	22.70

- REMARKS:**
1. Emission level (dBuV/m) = Raw Value (dBuV) + Correction Factor (dB/m).
  2. Correction Factor (dB/m) = Antenna Factor (dB/m) + Cable Factor (dB).
  3. The other emission levels were very low against the limit.
  4. Margin value = Emission level – Limit value.





**802.11a + GSM 850 Band + BT + RFID**

EUT TEST CONDITION		MEASUREMENT DETAIL	
CHANNEL	CH132+CH190+CH39+CH1	FREQUENCY RANGE	Below 1000MHz
INPUT POWER (SYSTEM)	120Vac, 60Hz	DETECTOR FUNCTION	Quasi-Peak
ENVIRONMENTAL CONDITIONS	25deg. C, 68%RH 1010 hPa	TEST MODE	A2
TESTED BY	Sun Lin		

ANTENNA POLARITY & TEST DISTANCE: HORIZONTAL AT 3 M								
NO.	FREQ. (MHz)	EMISSION LEVEL (dBuV/m)	LIMIT (dBuV/m)	MARGIN (dB)	ANTENNA HEIGHT (m)	TABLE ANGLE (Degree)	RAW VALUE (dBuV)	CORRECTION FACTOR (dB/m)
1	132.95	32.1 QP	43.5	-11.4	2.00 H	46	19.30	12.80
2	166.00	28.5 QP	43.5	-15.0	1.00 H	76	15.00	13.50
3	191.28	29.4 QP	43.5	-14.1	1.25 H	46	17.80	11.60
4	267.10	30.3 QP	46.0	-15.7	1.00 H	10	17.00	13.30
5	568.47	26.4 QP	46.0	-19.6	1.25 H	52	5.40	21.00
6	700.68	29.3 QP	46.0	-16.7	1.00 H	10	7.30	22.00
ANTENNA POLARITY & TEST DISTANCE: VERTICAL AT 3 M								
NO.	FREQ. (MHz)	EMISSION LEVEL (dBuV/m)	LIMIT (dBuV/m)	MARGIN (dB)	ANTENNA HEIGHT (m)	TABLE ANGLE (Degree)	RAW VALUE (dBuV)	CORRECTION FACTOR (dB/m)
1	39.78	33.0 QP	40.0	-7.0	1.02 V	285	19.40	13.60
2	132.95	31.8 QP	43.5	-11.7	1.00 V	262	19.00	12.80
3	166.00	30.2 QP	43.5	-13.3	1.00 V	109	16.70	13.50
4	265.16	25.5 QP	46.0	-20.5	2.00 V	64	12.30	13.20
5	529.58	26.6 QP	46.0	-19.4	1.00 V	58	6.50	20.10
6	624.85	27.5 QP	46.0	-18.5	1.00 V	10	5.80	21.70

- REMARKS:**
1. Emission level (dBuV/m) = Raw Value (dBuV) + Correction Factor (dB/m).
  2. Correction Factor (dB/m) = Antenna Factor (dB/m) + Cable Factor (dB).
  3. The other emission levels were very low against the limit.
  4. Margin value = Emission level – Limit value.



802.11a + GSM 850 Band + BT + RFID

EUT TEST CONDITION		MEASUREMENT DETAIL	
CHANNEL	CH157+CH190+CH39+CH1	FREQUENCY RANGE	Below 1000MHz
INPUT POWER (SYSTEM)	120Vac, 60Hz	DETECTOR FUNCTION	Quasi-Peak
ENVIRONMENTAL CONDITIONS	25deg. C, 68%RH 1010 hPa	TEST MODE	A3
TESTED BY	Sun Lin		

ANTENNA POLARITY & TEST DISTANCE: HORIZONTAL AT 3 M								
NO.	FREQ. (MHz)	EMISSION LEVEL (dBuV/m)	LIMIT (dBuV/m)	MARGIN (dB)	ANTENNA HEIGHT (m)	TABLE ANGLE (Degree)	RAW VALUE (dBuV)	CORRECTION FACTOR (dB/m)
1	74.62	26.1 QP	40.0	-13.9	1.25 H	328	14.90	11.20
2	132.95	32.9 QP	43.5	-10.6	1.25 H	37	20.10	12.80
3	191.28	30.7 QP	43.5	-12.8	1.50 H	49	19.10	11.60
4	267.10	34.0 QP	46.0	-12.0	2.00 H	105	20.70	13.30
5	331.26	27.7 QP	46.0	-18.3	1.75 H	223	12.50	15.20
6	545.14	33.8 QP	46.0	-12.2	1.50 H	217	13.30	20.50
ANTENNA POLARITY & TEST DISTANCE: VERTICAL AT 3 M								
NO.	FREQ. (MHz)	EMISSION LEVEL (dBuV/m)	LIMIT (dBuV/m)	MARGIN (dB)	ANTENNA HEIGHT (m)	TABLE ANGLE (Degree)	RAW VALUE (dBuV)	CORRECTION FACTOR (dB/m)
1	39.62	33.2 QP	40.0	-6.8	1.25 V	91	19.60	13.60
2	59.06	28.6 QP	40.0	-11.4	1.50 V	139	15.20	13.40
3	132.95	31.3 QP	43.5	-12.2	1.25 V	304	18.50	12.80
4	166.00	30.4 QP	43.5	-13.1	1.50 V	61	16.90	13.50
5	529.58	28.2 QP	46.0	-17.8	1.75 V	61	8.10	20.10
6	624.85	30.6 QP	46.0	-15.4	2.00 V	10	8.90	21.70

- REMARKS:**
1. Emission level (dBuV/m) = Raw Value (dBuV) + Correction Factor (dB/m).
  2. Correction Factor (dB/m) = Antenna Factor (dB/m) + Cable Factor (dB).
  3. The other emission levels were very low against the limit.
  4. Margin value = Emission level – Limit value.



**802.11b + GSM 1900 Band + BT + RFID**

EUT TEST CONDITION		MEASUREMENT DETAIL	
CHANNEL	CH11+CH512+CH39+CH1	FREQUENCY RANGE	Below 1000MHz
INPUT POWER (SYSTEM)	120Vac, 60Hz	DETECTOR FUNCTION	Quasi-Peak
ENVIRONMENTAL CONDITIONS	25deg. C, 68%RH 1010 hPa	TEST MODE	B1
TESTED BY	Sun Lin		

ANTENNA POLARITY & TEST DISTANCE: HORIZONTAL AT 3 M								
NO.	FREQ. (MHz)	EMISSION LEVEL (dBuV/m)	LIMIT (dBuV/m)	MARGIN (dB)	ANTENNA HEIGHT (m)	TABLE ANGLE (Degree)	RAW VALUE (dBuV)	CORRECTION FACTOR (dB/m)
1	140.23	35.8 QP	43.5	-7.7	1.08 H	58	22.40	13.40
2	166.00	29.4 QP	43.5	-14.1	1.00 H	85	15.90	13.50
3	191.28	27.8 QP	43.5	-15.7	1.00 H	64	16.20	11.60
4	267.10	31.7 QP	46.0	-14.3	1.00 H	13	18.40	13.30
5	331.26	27.6 QP	46.0	-18.4	1.00 H	43	12.40	15.20
6	523.75	32.4 QP	46.0	-13.6	1.00 H	37	12.50	19.90
ANTENNA POLARITY & TEST DISTANCE: VERTICAL AT 3 M								
NO.	FREQ. (MHz)	EMISSION LEVEL (dBuV/m)	LIMIT (dBuV/m)	MARGIN (dB)	ANTENNA HEIGHT (m)	TABLE ANGLE (Degree)	RAW VALUE (dBuV)	CORRECTION FACTOR (dB/m)
1	39.67	33.0 QP	40.0	-7.0	1.08 V	105	19.40	13.60
2	132.95	34.1 QP	43.5	-9.4	1.00 V	313	21.30	12.80
3	166.00	28.8 QP	43.5	-14.7	1.00 V	112	15.30	13.50
4	265.16	28.2 QP	46.0	-17.8	1.50 V	79	15.00	13.20
5	523.75	32.7 QP	46.0	-13.3	1.00 V	40	12.80	19.90
6	624.85	28.8 QP	46.0	-17.2	2.00 V	13	7.10	21.70

- REMARKS:**
1. Emission level (dBuV/m) = Raw Value (dBuV) + Correction Factor (dB/m).
  2. Correction Factor (dB/m) = Antenna Factor (dB/m) + Cable Factor (dB).
  3. The other emission levels were very low against the limit.
  4. Margin value = Emission level – Limit value.



**802.11a + GSM 1900 Band + BT + RFID**

EUT TEST CONDITION		MEASUREMENT DETAIL	
CHANNEL	CH132+CH512+CH39+CH1	FREQUENCY RANGE	Below 1000MHz
INPUT POWER (SYSTEM)	120Vac, 60Hz	DETECTOR FUNCTION	Quasi-Peak
ENVIRONMENTAL CONDITIONS	25deg. C, 68%RH 1010 hPa	TEST MODE	B2
TESTED BY	Sun Lin		

ANTENNA POLARITY & TEST DISTANCE: HORIZONTAL AT 3 M								
NO.	FREQ. (MHz)	EMISSION LEVEL (dBuV/m)	LIMIT (dBuV/m)	MARGIN (dB)	ANTENNA HEIGHT (m)	TABLE ANGLE (Degree)	RAW VALUE (dBuV)	CORRECTION FACTOR (dB/m)
1	140.23	35.6 QP	43.5	-7.9	1.07 H	58	22.20	13.40
2	166.00	28.0 QP	43.5	-15.5	1.00 H	82	14.50	13.50
3	191.28	28.4 QP	43.5	-15.1	1.00 H	67	16.80	11.60
4	267.10	31.7 QP	46.0	-14.3	1.00 H	7	18.40	13.30
5	523.95	38.2 QP	46.0	-7.8	1.78 H	57	18.30	19.90
6	580.13	35.6 QP	46.0	-10.4	2.00 H	358	14.30	21.30
ANTENNA POLARITY & TEST DISTANCE: VERTICAL AT 3 M								
NO.	FREQ. (MHz)	EMISSION LEVEL (dBuV/m)	LIMIT (dBuV/m)	MARGIN (dB)	ANTENNA HEIGHT (m)	TABLE ANGLE (Degree)	RAW VALUE (dBuV)	CORRECTION FACTOR (dB/m)
1	39.58	33.2 QP	40.0	-6.8	1.07 V	107	19.60	13.60
2	140.25	35.7 QP	43.5	-7.8	1.58 V	100	22.30	13.40
3	166.00	30.2 QP	43.5	-13.3	1.00 V	58	16.70	13.50
4	265.16	25.3 QP	46.0	-20.7	1.50 V	82	12.10	13.20
5	523.75	30.2 QP	46.0	-15.8	1.50 V	310	10.30	19.90
6	624.85	27.1 QP	46.0	-18.9	1.50 V	10	5.40	21.70

- REMARKS:**
1. Emission level (dBuV/m) = Raw Value (dBuV) + Correction Factor (dB/m).
  2. Correction Factor (dB/m) = Antenna Factor (dB/m) + Cable Factor (dB).
  3. The other emission levels were very low against the limit.
  4. Margin value = Emission level – Limit value.



**802.11a + GSM 1900 Band + BT + RFID**

EUT TEST CONDITION		MEASUREMENT DETAIL	
CHANNEL	CH157+CH512+CH39+CH1	FREQUENCY RANGE	Below 1000MHz
INPUT POWER (SYSTEM)	120Vac, 60Hz	DETECTOR FUNCTION	Quasi-Peak
ENVIRONMENTAL CONDITIONS	25deg. C, 68%RH 1010 hPa	TEST MODE	B3
TESTED BY	Sun Lin		

ANTENNA POLARITY & TEST DISTANCE: HORIZONTAL AT 3 M								
NO.	FREQ. (MHz)	EMISSION LEVEL (dBuV/m)	LIMIT (dBuV/m)	MARGIN (dB)	ANTENNA HEIGHT (m)	TABLE ANGLE (Degree)	RAW VALUE (dBuV)	CORRECTION FACTOR (dB/m)
1	141.20	36.4 QP	43.5	-7.1	1.06 H	13	23.00	13.40
2	166.00	27.4 QP	43.5	-16.1	1.50 H	67	13.90	13.50
3	191.28	28.5 QP	43.5	-15.0	1.50 H	58	16.90	11.60
4	267.10	31.6 QP	46.0	-14.4	1.00 H	10	18.30	13.30
5	523.75	38.2 QP	46.0	-7.8	1.00 H	358	18.30	19.90
6	576.25	29.0 QP	46.0	-17.0	2.00 H	121	7.80	21.20
ANTENNA POLARITY & TEST DISTANCE: VERTICAL AT 3 M								
NO.	FREQ. (MHz)	EMISSION LEVEL (dBuV/m)	LIMIT (dBuV/m)	MARGIN (dB)	ANTENNA HEIGHT (m)	TABLE ANGLE (Degree)	RAW VALUE (dBuV)	CORRECTION FACTOR (dB/m)
1	40.70	33.2 QP	40.0	-6.8	1.00 V	88	19.50	13.70
2	144.00	28.9 QP	43.5	-14.6	1.59 V	311	15.40	13.50
3	166.00	30.0 QP	43.5	-13.5	1.00 V	97	16.50	13.50
4	265.16	27.2 QP	46.0	-18.8	1.50 V	76	14.00	13.20
5	521.81	30.2 QP	46.0	-15.8	1.00 V	43	10.40	19.80
6	624.85	32.1 QP	46.0	-13.9	2.00 V	25	10.40	21.70

- REMARKS:**
1. Emission level (dBuV/m) = Raw Value (dBuV) + Correction Factor (dB/m).
  2. Correction Factor (dB/m) = Antenna Factor (dB/m) + Cable Factor (dB).
  3. The other emission levels were very low against the limit.
  4. Margin value = Emission level – Limit value.



**802.11b + WCDMA 850 Band + BT + RFID**

EUT TEST CONDITION		MEASUREMENT DETAIL	
CHANNEL	CH11+CH4233+CH39+CH1	FREQUENCY RANGE	Below 1000MHz
INPUT POWER (SYSTEM)	120Vac, 60Hz	DETECTOR FUNCTION	Quasi-Peak
ENVIRONMENTAL CONDITIONS	25deg. C, 68%RH 1010 hPa	TEST MODE	C1
TESTED BY	Sun Lin		

ANTENNA POLARITY & TEST DISTANCE: HORIZONTAL AT 3 M								
NO.	FREQ. (MHz)	EMISSION LEVEL (dBuV/m)	LIMIT (dBuV/m)	MARGIN (dB)	ANTENNA HEIGHT (m)	TABLE ANGLE (Degree)	RAW VALUE (dBuV)	CORRECTION FACTOR (dB/m)
1	109.62	29.4 QP	43.5	-14.1	1.25 H	43	19.00	10.40
2	132.95	31.3 QP	43.5	-12.2	1.25 H	31	18.50	12.80
3	191.28	32.3 QP	43.5	-11.2	1.25 H	49	20.70	11.60
4	267.10	34.1 QP	46.0	-11.9	1.00 H	10	20.80	13.30
5	366.26	30.8 QP	46.0	-15.2	1.00 H	184	14.80	16.00
6	632.63	30.2 QP	46.0	-15.8	1.25 H	64	8.40	21.80
ANTENNA POLARITY & TEST DISTANCE: VERTICAL AT 3 M								
NO.	FREQ. (MHz)	EMISSION LEVEL (dBuV/m)	LIMIT (dBuV/m)	MARGIN (dB)	ANTENNA HEIGHT (m)	TABLE ANGLE (Degree)	RAW VALUE (dBuV)	CORRECTION FACTOR (dB/m)
1	39.62	33.2 QP	40.0	-6.8	1.00 V	61	19.60	13.60
2	57.12	27.1 QP	40.0	-12.9	1.00 V	241	13.60	13.50
3	132.95	32.3 QP	43.5	-11.2	1.00 V	298	19.50	12.80
4	166.00	29.0 QP	43.5	-14.5	1.00 V	130	15.50	13.50
5	265.16	34.9 QP	46.0	-11.1	2.00 V	64	21.70	13.20
6	529.58	35.3 QP	46.0	-10.7	1.00 V	67	15.20	20.10

- REMARKS:**
1. Emission level (dBuV/m) = Raw Value (dBuV) + Correction Factor (dB/m).
  2. Correction Factor (dB/m) = Antenna Factor (dB/m) + Cable Factor (dB).
  3. The other emission levels were very low against the limit.
  4. Margin value = Emission level – Limit value.



802.11a + WCDMA 850 Band + BT + RFID

EUT TEST CONDITION		MEASUREMENT DETAIL	
CHANNEL	CH132+CH4233+CH39+CH1	FREQUENCY RANGE	Below 1000MHz
INPUT POWER (SYSTEM)	120Vac, 60Hz	DETECTOR FUNCTION	Quasi-Peak
ENVIRONMENTAL CONDITIONS	25deg. C, 68%RH 1010 hPa	TEST MODE	C2
TESTED BY	Sun Lin		

ANTENNA POLARITY & TEST DISTANCE: HORIZONTAL AT 3 M								
NO.	FREQ. (MHz)	EMISSION LEVEL (dBuV/m)	LIMIT (dBuV/m)	MARGIN (dB)	ANTENNA HEIGHT (m)	TABLE ANGLE (Degree)	RAW VALUE (dBuV)	CORRECTION FACTOR (dB/m)
1	132.95	30.5 QP	43.5	-13.0	2.00 H	31	17.70	12.80
2	166.00	27.0 QP	43.5	-16.5	1.00 H	70	13.50	13.50
3	191.28	27.8 QP	43.5	-15.7	1.50 H	49	16.20	11.60
4	267.10	31.1 QP	46.0	-14.9	1.00 H	10	17.80	13.30
5	515.97	24.6 QP	46.0	-21.4	1.25 H	184	4.90	19.70
6	566.52	27.4 QP	46.0	-18.6	1.25 H	46	6.40	21.00
ANTENNA POLARITY & TEST DISTANCE: VERTICAL AT 3 M								
NO.	FREQ. (MHz)	EMISSION LEVEL (dBuV/m)	LIMIT (dBuV/m)	MARGIN (dB)	ANTENNA HEIGHT (m)	TABLE ANGLE (Degree)	RAW VALUE (dBuV)	CORRECTION FACTOR (dB/m)
1	39.85	33.0 QP	40.0	-7.0	1.08 V	107	19.30	13.70
2	57.12	27.2 QP	40.0	-12.8	1.25 V	229	13.70	13.50
3	132.95	31.7 QP	43.5	-11.8	1.00 V	271	18.90	12.80
4	166.00	31.2 QP	43.5	-12.3	1.00 V	106	17.70	13.50
5	426.53	34.3 QP	46.0	-11.7	1.50 V	73	16.80	17.50
6	624.85	27.2 QP	46.0	-18.8	1.00 V	10	5.50	21.70

- REMARKS:**
1. Emission level (dBuV/m) = Raw Value (dBuV) + Correction Factor (dB/m).
  2. Correction Factor (dB/m) = Antenna Factor (dB/m) + Cable Factor (dB).
  3. The other emission levels were very low against the limit.
  4. Margin value = Emission level – Limit value.



802.11a + WCDMA 850 Band + BT + RFID

EUT TEST CONDITION		MEASUREMENT DETAIL	
CHANNEL	CH157+CH4233+CH39+CH1	FREQUENCY RANGE	Below 1000MHz
INPUT POWER (SYSTEM)	120Vac, 60Hz	DETECTOR FUNCTION	Quasi-Peak
ENVIRONMENTAL CONDITIONS	25deg. C, 68%RH 1010 hPa	TEST MODE	C3
TESTED BY	Sun Lin		

ANTENNA POLARITY & TEST DISTANCE: HORIZONTAL AT 3 M								
NO.	FREQ. (MHz)	EMISSION LEVEL (dBuV/m)	LIMIT (dBuV/m)	MARGIN (dB)	ANTENNA HEIGHT (m)	TABLE ANGLE (Degree)	RAW VALUE (dBuV)	CORRECTION FACTOR (dB/m)
1	132.95	30.9 QP	43.5	-12.6	2.00 H	241	18.10	12.80
2	166.00	27.6 QP	43.5	-15.9	1.00 H	10	14.10	13.50
3	191.28	30.1 QP	43.5	-13.4	1.25 H	55	18.50	11.60
4	267.10	31.1 QP	46.0	-14.9	1.25 H	154	17.80	13.30
5	300.16	26.6 QP	46.0	-19.4	1.25 H	169	12.10	14.50
6	566.52	27.7 QP	46.0	-18.3	1.25 H	64	6.70	21.00
ANTENNA POLARITY & TEST DISTANCE: VERTICAL AT 3 M								
NO.	FREQ. (MHz)	EMISSION LEVEL (dBuV/m)	LIMIT (dBuV/m)	MARGIN (dB)	ANTENNA HEIGHT (m)	TABLE ANGLE (Degree)	RAW VALUE (dBuV)	CORRECTION FACTOR (dB/m)
1	39.28	33.2 QP	40.0	-6.8	1.02 V	85	19.70	13.50
2	57.12	27.3 QP	40.0	-12.7	1.00 V	226	13.80	13.50
3	132.95	31.8 QP	43.5	-11.7	1.00 V	295	19.00	12.80
4	166.00	29.1 QP	43.5	-14.4	1.25 V	115	15.60	13.50
5	265.16	26.1 QP	46.0	-19.9	2.00 V	61	12.90	13.20
6	624.85	26.6 QP	46.0	-19.4	1.00 V	10	4.90	21.70

- REMARKS:**
1. Emission level (dBuV/m) = Raw Value (dBuV) + Correction Factor (dB/m).
  2. Correction Factor (dB/m) = Antenna Factor (dB/m) + Cable Factor (dB).
  3. The other emission levels were very low against the limit.
  4. Margin value = Emission level – Limit value.





**802.11b + WCDMA 1900 Band + BT + RFID**

EUT TEST CONDITION		MEASUREMENT DETAIL	
CHANNEL	CH11+CH9538+CH39+CH1	FREQUENCY RANGE	Below 1000MHz
INPUT POWER (SYSTEM)	120Vac, 60Hz	DETECTOR FUNCTION	Quasi-Peak
ENVIRONMENTAL CONDITIONS	25deg. C, 68%RH 1010 hPa	TEST MODE	D1
TESTED BY	Sun Lin		

ANTENNA POLARITY & TEST DISTANCE: HORIZONTAL AT 3 M								
NO.	FREQ. (MHz)	EMISSION LEVEL (dBuV/m)	LIMIT (dBuV/m)	MARGIN (dB)	ANTENNA HEIGHT (m)	TABLE ANGLE (Degree)	RAW VALUE (dBuV)	CORRECTION FACTOR (dB/m)
1	109.62	25.2 QP	43.5	-18.3	1.50 H	52	14.80	10.40
2	141.87	34.3 QP	43.5	-9.2	1.06 H	8	20.80	13.50
3	199.05	28.2 QP	43.5	-15.3	1.00 H	52	17.20	11.00
4	265.16	31.2 QP	46.0	-14.8	1.25 H	10	18.00	13.20
5	523.75	34.5 QP	46.0	-11.5	1.25 H	10	14.60	19.90
6	582.56	38.4 QP	46.0	-7.6	1.01 H	51	17.10	21.30
ANTENNA POLARITY & TEST DISTANCE: VERTICAL AT 3 M								
NO.	FREQ. (MHz)	EMISSION LEVEL (dBuV/m)	LIMIT (dBuV/m)	MARGIN (dB)	ANTENNA HEIGHT (m)	TABLE ANGLE (Degree)	RAW VALUE (dBuV)	CORRECTION FACTOR (dB/m)
1	40.52	33.5 QP	40.0	-6.5	1.32 V	12	19.80	13.70
2	57.12	27.4 QP	40.0	-12.6	1.00 V	244	13.90	13.50
3	141.73	35.0 QP	43.5	-8.5	1.56 V	54	21.50	13.50
4	166.00	31.2 QP	43.5	-12.3	1.25 V	118	17.70	13.50
5	267.10	26.3 QP	46.0	-19.7	1.50 V	28	13.00	13.30
6	523.75	32.0 QP	46.0	-14.0	2.00 V	190	12.10	19.90

- REMARKS:**
1. Emission level (dBuV/m) = Raw Value (dBuV) + Correction Factor (dB/m).
  2. Correction Factor (dB/m) = Antenna Factor (dB/m) + Cable Factor (dB).
  3. The other emission levels were very low against the limit.
  4. Margin value = Emission level – Limit value.



802.11a + WCDMA 1900 Band + BT + RFID

EUT TEST CONDITION		MEASUREMENT DETAIL	
CHANNEL	CH132+CH9538+CH39+CH1	FREQUENCY RANGE	Below 1000MHz
INPUT POWER (SYSTEM)	120Vac, 60Hz	DETECTOR FUNCTION	Quasi-Peak
ENVIRONMENTAL CONDITIONS	25deg. C, 68%RH 1010 hPa	TEST MODE	D2
TESTED BY	Sun Lin		

ANTENNA POLARITY & TEST DISTANCE: HORIZONTAL AT 3 M								
NO.	FREQ. (MHz)	EMISSION LEVEL (dBuV/m)	LIMIT (dBuV/m)	MARGIN (dB)	ANTENNA HEIGHT (m)	TABLE ANGLE (Degree)	RAW VALUE (dBuV)	CORRECTION FACTOR (dB/m)
1	109.62	24.6 QP	43.5	-18.9	1.50 H	55	14.20	10.40
2	141.32	35.9 QP	43.5	-7.6	1.57 H	15	22.40	13.50
3	191.28	28.8 QP	43.5	-14.7	1.50 H	58	17.20	11.60
4	265.16	30.9 QP	46.0	-15.1	1.00 H	13	17.70	13.20
5	523.75	35.4 QP	46.0	-10.6	1.50 H	13	15.50	19.90
6	582.67	38.7 QP	46.0	-7.3	1.22 H	57	17.40	21.30
ANTENNA POLARITY & TEST DISTANCE: VERTICAL AT 3 M								
NO.	FREQ. (MHz)	EMISSION LEVEL (dBuV/m)	LIMIT (dBuV/m)	MARGIN (dB)	ANTENNA HEIGHT (m)	TABLE ANGLE (Degree)	RAW VALUE (dBuV)	CORRECTION FACTOR (dB/m)
1	40.47	33.2 QP	40.0	-6.8	1.20 V	158	19.50	13.70
2	132.95	33.1 QP	43.5	-10.4	1.25 V	277	20.30	12.80
3	166.00	30.8 QP	43.5	-12.7	1.00 V	76	17.30	13.50
4	267.10	26.0 QP	46.0	-20.0	1.50 V	64	12.70	13.30
5	529.58	25.8 QP	46.0	-20.2	1.00 V	73	5.70	20.10
6	624.85	26.9 QP	46.0	-19.1	1.00 V	196	5.20	21.70

- REMARKS:**
1. Emission level (dBuV/m) = Raw Value (dBuV) + Correction Factor (dB/m).
  2. Correction Factor (dB/m) = Antenna Factor (dB/m) + Cable Factor (dB).
  3. The other emission levels were very low against the limit.
  4. Margin value = Emission level – Limit value.



**802.11a + WCDMA 1900 Band + BT + RFID**

EUT TEST CONDITION		MEASUREMENT DETAIL	
CHANNEL	CH157+CH9538+CH39+CH1	FREQUENCY RANGE	Below 1000MHz
INPUT POWER (SYSTEM)	120Vac, 60Hz	DETECTOR FUNCTION	Quasi-Peak
ENVIRONMENTAL CONDITIONS	25deg. C, 68%RH 1010 hPa	TEST MODE	D3
TESTED BY	Sun Lin		

ANTENNA POLARITY & TEST DISTANCE: HORIZONTAL AT 3 M								
NO.	FREQ. (MHz)	EMISSION LEVEL (dBuV/m)	LIMIT (dBuV/m)	MARGIN (dB)	ANTENNA HEIGHT (m)	TABLE ANGLE (Degree)	RAW VALUE (dBuV)	CORRECTION FACTOR (dB/m)
1	132.95	34.0 QP	43.5	-9.5	1.25 H	46	21.20	12.80
2	191.28	31.3 QP	43.5	-12.2	1.25 H	67	19.70	11.60
3	267.10	34.2 QP	46.0	-11.8	1.50 H	125	20.90	13.30
4	304.04	34.0 QP	46.0	-12.0	1.50 H	181	19.40	14.60
5	529.58	35.5 QP	46.0	-10.5	1.75 H	88	15.40	20.10
6	632.63	37.0 QP	46.0	-9.0	2.00 H	64	15.20	21.80
ANTENNA POLARITY & TEST DISTANCE: VERTICAL AT 3 M								
NO.	FREQ. (MHz)	EMISSION LEVEL (dBuV/m)	LIMIT (dBuV/m)	MARGIN (dB)	ANTENNA HEIGHT (m)	TABLE ANGLE (Degree)	RAW VALUE (dBuV)	CORRECTION FACTOR (dB/m)
1	39.65	33.5 QP	40.0	-6.5	1.02 V	15	19.90	13.60
2	132.95	33.5 QP	43.5	-10.0	1.00 V	331	20.70	12.80
3	216.00	15.8 QP	43.5	-27.7	1.50 V	136	4.30	11.50
4	267.10	26.5 QP	46.0	-19.5	1.50 V	67	13.20	13.30
5	529.58	26.3 QP	46.0	-19.7	1.00 V	79	6.20	20.10
6	624.85	27.3 QP	46.0	-18.7	2.00 V	196	5.60	21.70

- REMARKS:**
1. Emission level (dBuV/m) = Raw Value (dBuV) + Correction Factor (dB/m).
  2. Correction Factor (dB/m) = Antenna Factor (dB/m) + Cable Factor (dB).
  3. The other emission levels were very low against the limit.
  4. Margin value = Emission level – Limit value.

## 4.2 CONDUCTED EMISSION MEASUREMENT

### 4.2.1 LIMITS OF CONDUCTED EMISSION MEASUREMENT

FREQUENCY OF EMISSION (MHz)	CONDUCTED LIMIT (dB $\mu$ V)	
	Quasi-peak	Average
0.15-0.5	66 to 56	56 to 46
0.5-5	56	46
5-30	60	50

- NOTE:**
1. The lower limit shall apply at the transition frequencies.
  2. The limit decreases in line with the logarithm of the frequency in the range of 0.15 to 0.50 MHz.
  3. All emanations from a class A/B digital device or system, including any network of conductors and apparatus connected thereto, shall not exceed the level of field strengths specified above.

### 4.2.2 TEST INSTRUMENTS

DESCRIPTION & MANUFACTURER	MODEL NO.	SERIAL NO.	DATE OF CALIBRATION	DUE DATE OF CALIBRATION
Test Receiver ROHDE & SCHWARZ	ESCS30	100289	Nov. 23, 2010	Nov. 22, 2011
RF signal cable Woken	5D-FB	Cable-HYCO2-01	Dec. 30, 2010	Dec. 29, 2011
LISN ROHDE & SCHWARZ	ESH2-Z5	100100	Jan. 06, 2011	Jan. 05, 2012
LISN ROHDE & SCHWARZ	ESH3-Z5	100311	Jul. 08, 2010	Jul. 07, 2011
V-LISN SCHWARZBECK	NNBL 8226-2	8226-142	Jul. 12, 2010	Jul. 11, 2011
LISN ROHDE & SCHWARZ	ENV216	100072	Jun. 11, 2010	Jun. 10, 2011
Software ADT	ADT_Cond_ V7.3.7	NA	NA	NA

- NOTE:**
1. The calibration interval of the above test instruments is 12 months and the calibrations are traceable to NML/ROC and NIST/USA.
  2. The test was performed in HwaYa Shielded Room 2.
  3. The VCCI Site Registration No. is C-2047.

#### 4.2.3 TEST PROCEDURES

- a. The EUT was placed 0.4 meters from the conducting wall of the shielded room with EUT being connected to the power mains through a line impedance stabilization network (LISN). Other support units were connected to the power mains through another LISN. The two LISNs provide 50 ohm/ 50uH of coupling impedance for the measuring instrument.
- b. Both lines of the power mains connected to the EUT were checked for maximum conducted interference.
- c. The frequency range from 150kHz to 30MHz was searched. Emission levels under (Limit - 20dB) was not recorded.

**NOTE:** All modes of operation were investigated and the worst-case emissions are reported.

#### 4.2.4 DEVIATION FROM TEST STANDARD

No deviation.

## 4.2.5 TEST SETUP

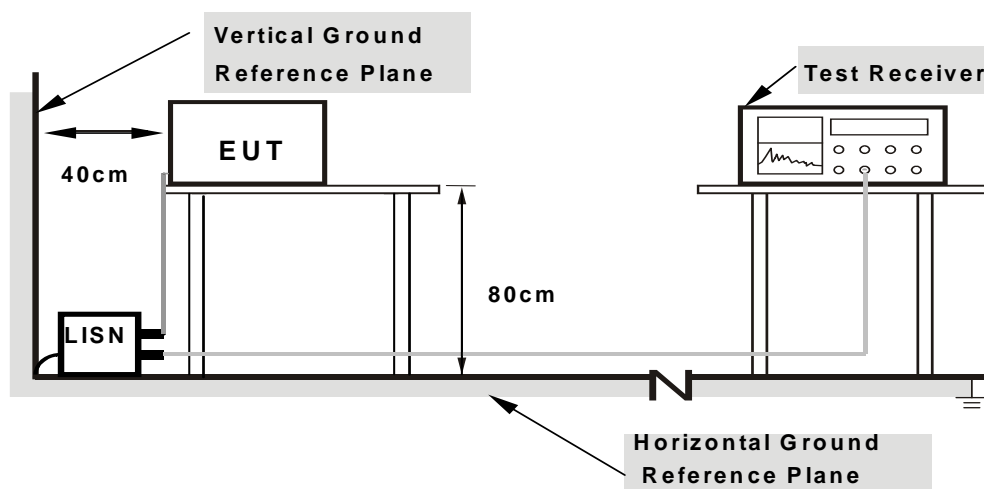

- Note:**
1. Support units were connected to second LISN.
  2. Both of LISNs (AMN) are 80 cm from EUT and at least 80 cm from other units and other metal planes

For the actual test configuration, please refer to the attached file (Test Setup Photo).

## 4.2.6 EUT OPERATING CONDITIONS

Same as 4.1.6.

#### 4.2.7 TEST RESULTS

##### CONDUCTED WORST-CASE DATA: 802.11b + GSM 850 BAND + BT + RFID

PHASE	Line 1	6dB BANDWIDTH	9kHz
TEST MODE	A1		

No	Freq. [MHz]	Corr. Factor (dB)	Reading Value [dB (uV)]		Emission Level [dB (uV)]		Limit [dB (uV)]		Margin (dB)	
			Q.P.	AV.	Q.P.	AV.	Q.P.	AV.	Q.P.	AV.
1	0.154	0.14	47.23	-	47.37	-	65.79	55.79	-18.41	-
2	0.228	0.14	37.02	-	37.16	-	62.52	52.52	-25.36	-
3	0.459	0.15	33.15	-	33.30	-	56.72	46.72	-23.41	-
4	1.805	0.21	15.44	-	15.65	-	56.00	46.00	-40.35	-
5	15.590	1.18	39.88	-	41.06	-	60.00	50.00	-18.94	-
6	27.117	2.03	40.62	-	42.65	-	60.00	50.00	-17.35	-

- REMARKS:**
1. Q.P. and AV. are abbreviations of quasi-peak and average individually.
  2. "-": The Quasi-peak reading value also meets average limit and measurement with the average detector is unnecessary.
  3. The emission levels of other frequencies were very low against the limit.
  4. Margin value = Emission level - Limit value
  5. Correction factor = Insertion loss + Cable loss
  6. Emission Level = Correction Factor + Reading Value.

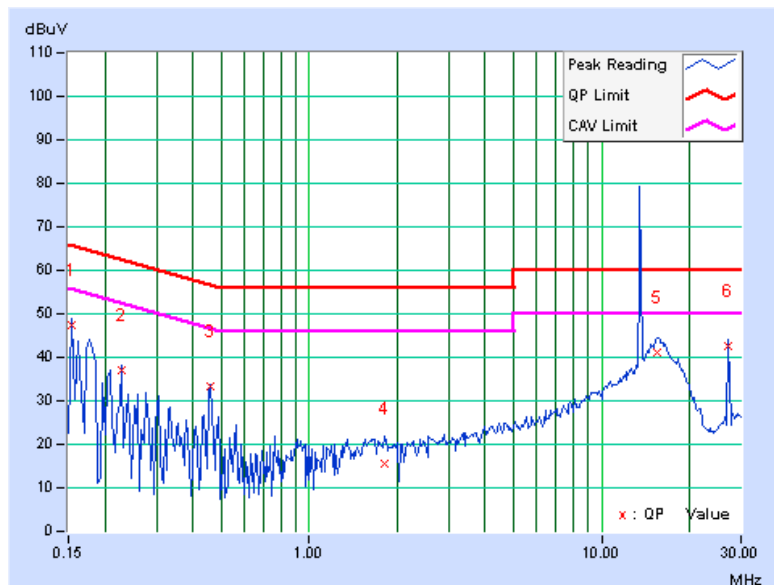

\*\* The emission level over the limit is the fundamental frequency of RFID.

<b>PHASE</b>	Line 2	<b>6dB BANDWIDTH</b>	9kHz
<b>TEST MODE</b>	A1		

No	Freq. [MHz]	Corr. Factor (dB)	Reading Value		Emission Level		Limit		Margin	
			[dB (uV)]		[dB (uV)]		[dB (uV)]		(dB)	
			Q.P.	AV.	Q.P.	AV.	Q.P.	AV.	Q.P.	AV.
1	0.181	0.13	38.54	-	38.67	-	64.43	54.43	-25.76	-
2	0.228	0.13	37.23	-	37.36	-	62.52	52.52	-25.16	-
3	0.455	0.14	32.40	-	32.54	-	56.79	46.79	-24.25	-
4	1.586	0.20	19.67	-	19.87	-	56.00	46.00	-36.13	-
5	15.871	1.05	39.58	-	40.63	-	60.00	50.00	-19.37	-
6	27.117	1.78	40.66	-	42.44	-	60.00	50.00	-17.56	-

- REMARKS:**
1. Q.P. and AV. are abbreviations of quasi-peak and average individually.
  2. "-": The Quasi-peak reading value also meets average limit and measurement with the average detector is unnecessary.
  3. The emission levels of other frequencies were very low against the limit.
  4. Margin value = Emission level - Limit value
  5. Correction factor = Insertion loss + Cable loss
  6. Emission Level = Correction Factor + Reading Value.

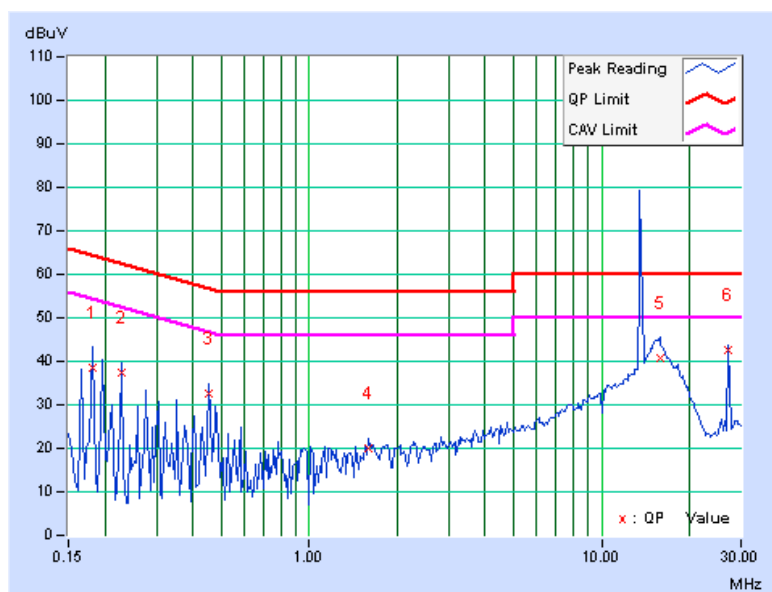

\*\* The emission level over the limit is the fundamental frequency of RFID.



802.11a + GSM 850 BAND + BT + RFID

PHASE	Line 1	6dB BANDWIDTH	9kHz
TEST MODE	A2		

No	Freq. [MHz]	Corr. Factor (dB)	Reading Value		Emission Level		Limit		Margin	
			[dB (uV)]		[dB (uV)]		[dB (uV)]		(dB)	
			Q.P.	AV.	Q.P.	AV.	Q.P.	AV.	Q.P.	AV.
1	0.150	0.15	47.78	-	47.93	-	66.00	56.00	-18.07	-
2	0.173	0.14	43.63	-	43.77	-	64.79	54.79	-21.02	-
3	0.220	0.14	36.45	-	36.59	-	62.81	52.81	-26.22	-
4	0.447	0.15	29.98	-	30.13	-	56.93	46.93	-26.80	-
5	15.449	1.17	38.53	-	39.70	-	60.00	50.00	-20.30	-
6	27.117	2.03	41.03	-	43.06	-	60.00	50.00	-16.94	-

- REMARKS:**
1. Q.P. and AV. are abbreviations of quasi-peak and average individually.
  2. "-": The Quasi-peak reading value also meets average limit and measurement with the average detector is unnecessary.
  3. The emission levels of other frequencies were very low against the limit.
  4. Margin value = Emission level - Limit value
  5. Correction factor = Insertion loss + Cable loss
  6. Emission Level = Correction Factor + Reading Value.

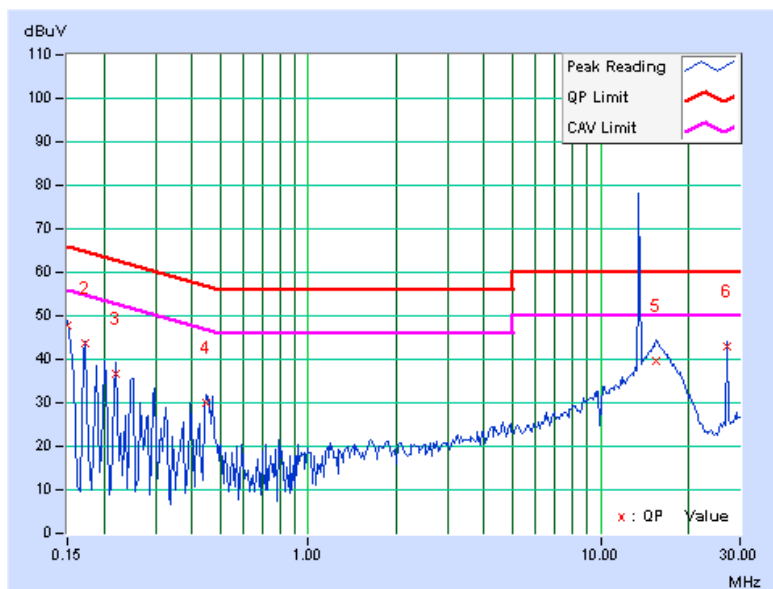

\*\* The emission level over the limit is the fundamental frequency of RFID.

<b>PHASE</b>	Line 2	<b>6dB BANDWIDTH</b>	9kHz
<b>TEST MODE</b>	A2		

No	Freq. [MHz]	Corr. Factor (dB)	Reading Value [dB (uV)]		Emission Level [dB (uV)]		Limit [dB (uV)]		Margin (dB)	
			Q.P.	AV.	Q.P.	AV.	Q.P.	AV.	Q.P.	AV.
1	0.150	0.12	47.90	-	48.02	-	66.00	56.00	-17.98	-
2	0.173	0.13	43.10	-	43.23	-	64.79	54.79	-21.57	-
3	0.205	0.13	34.34	-	34.47	-	63.42	53.42	-28.95	-
4	0.459	0.14	25.07	-	25.21	-	56.72	46.72	-31.50	-
5	15.504	1.03	39.62	-	40.65	-	60.00	50.00	-19.35	-
6	27.117	1.78	40.72	-	42.50	-	60.00	50.00	-17.50	-

- REMARKS:**
1. Q.P. and AV. are abbreviations of quasi-peak and average individually.
  2. "-": The Quasi-peak reading value also meets average limit and measurement with the average detector is unnecessary.
  3. The emission levels of other frequencies were very low against the limit.
  4. Margin value = Emission level - Limit value
  5. Correction factor = Insertion loss + Cable loss
  6. Emission Level = Correction Factor + Reading Value.

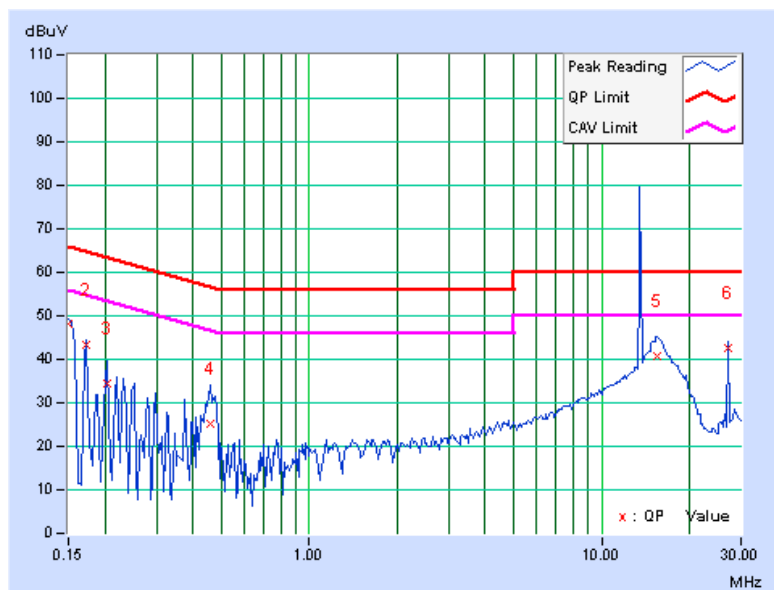

\*\* The emission level over the limit is the fundamental frequency of RFID.

### 802.11a + GSM 850 BAND + BT + RFID

PHASE	Line 1	6dB BANDWIDTH	9kHz
TEST MODE	A3		

No	Freq. [MHz]	Corr. Factor (dB)	Reading Value		Emission Level		Limit		Margin	
			[dB (uV)]		[dB (uV)]		[dB (uV)]		(dB)	
			Q.P.	AV.	Q.P.	AV.	Q.P.	AV.	Q.P.	AV.
1	0.150	0.15	47.04	-	47.19	-	66.00	56.00	-18.81	-
2	0.173	0.14	43.35	-	43.49	-	64.79	54.79	-21.30	-
3	0.466	0.15	33.16	-	33.31	-	56.58	46.58	-23.26	-
4	1.277	0.20	20.20	-	20.40	-	56.00	46.00	-35.60	-
5	15.727	1.19	39.11	-	40.30	-	60.00	50.00	-19.70	-
6	27.120	2.03	41.11	-	43.14	-	60.00	50.00	-16.86	-

- REMARKS:**
1. Q.P. and AV. are abbreviations of quasi-peak and average individually.
  2. "-": The Quasi-peak reading value also meets average limit and measurement with the average detector is unnecessary.
  3. The emission levels of other frequencies were very low against the limit.
  4. Margin value = Emission level - Limit value
  5. Correction factor = Insertion loss + Cable loss
  6. Emission Level = Correction Factor + Reading Value.

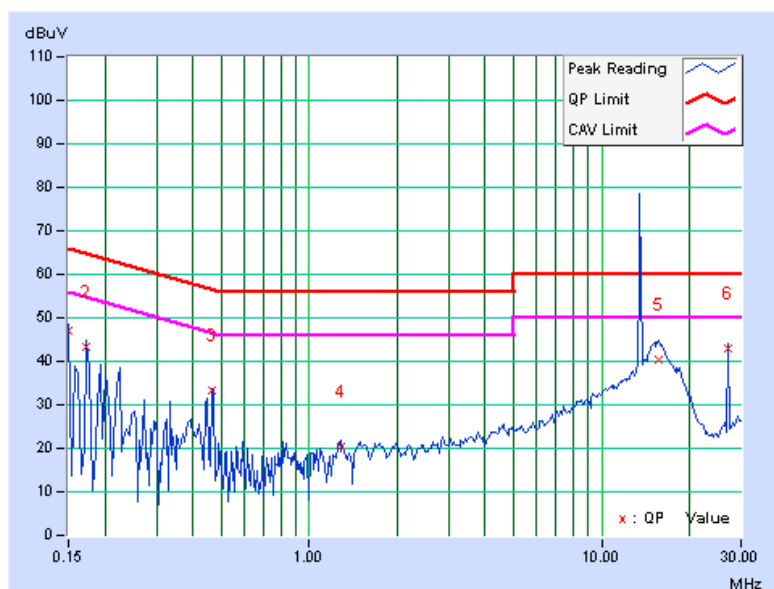

\*\* The emission level over the limit is the fundamental frequency of RFID.

PHASE	Line 2	6dB BANDWIDTH	9kHz
TEST MODE	A3		

No	Freq. [MHz]	Corr. Factor (dB)	Reading Value [dB (uV)]		Emission Level [dB (uV)]		Limit [dB (uV)]		Margin (dB)	
			Q.P.	AV.	Q.P.	AV.	Q.P.	AV.	Q.P.	AV.
1	0.150	0.12	46.47	-	46.59	-	66.00	56.00	-19.41	-
2	0.173	0.13	43.12	-	43.25	-	64.79	54.79	-21.55	-
3	0.466	0.14	32.51	-	32.65	-	56.58	46.58	-23.92	-
4	1.297	0.19	20.57	-	20.76	-	56.00	46.00	-35.24	-
5	15.637	1.04	39.84	-	40.88	-	60.00	50.00	-19.12	-
6	27.117	1.78	40.78	-	42.56	-	60.00	50.00	-17.44	-

- REMARKS:**
1. Q.P. and AV. are abbreviations of quasi-peak and average individually.
  2. "-": The Quasi-peak reading value also meets average limit and measurement with the average detector is unnecessary.
  3. The emission levels of other frequencies were very low against the limit.
  4. Margin value = Emission level - Limit value
  5. Correction factor = Insertion loss + Cable loss
  6. Emission Level = Correction Factor + Reading Value.

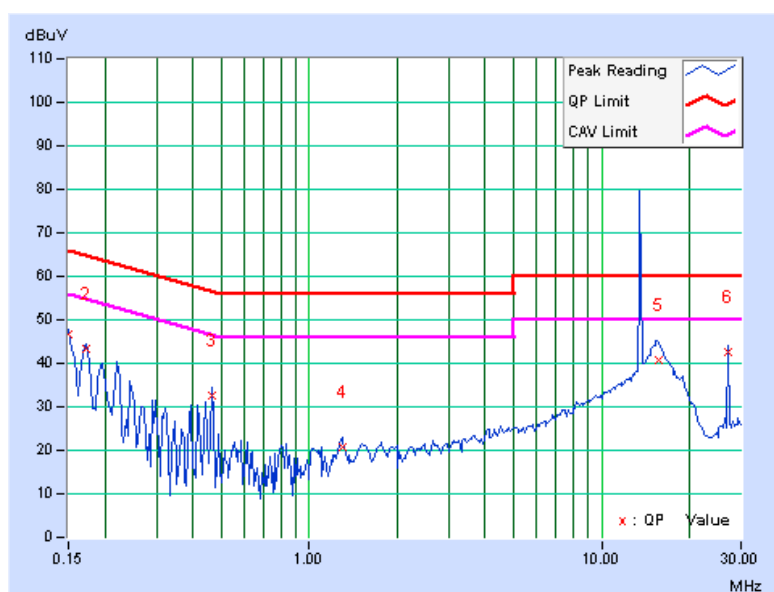

\*\* The emission level over the limit is the fundamental frequency of RFID.

**802.11b + GSM 1900 BAND + BT + RFID**

<b>PHASE</b>	Line 1	<b>6dB BANDWIDTH</b>	9kHz
<b>TEST MODE</b>	B1		

No	Freq. [MHz]	Corr. Factor (dB)	Reading Value		Emission Level		Limit		Margin	
			[dB (uV)]		[dB (uV)]		[dB (uV)]		(dB)	
			Q.P.	AV.	Q.P.	AV.	Q.P.	AV.	Q.P.	AV.
1	0.166	0.14	44.17	-	44.31	-	65.18	55.18	-20.86	-
2	0.197	0.14	34.24	-	34.38	-	63.74	53.74	-29.36	-
3	0.455	0.15	31.63	-	31.78	-	56.79	46.79	-25.01	-
4	1.695	0.21	19.69	-	19.90	-	56.00	46.00	-36.10	-
5	15.582	1.18	39.11	-	40.29	-	60.00	50.00	-19.71	-
6	27.117	2.03	40.94	-	42.97	-	60.00	50.00	-17.03	-

- REMARKS:**
1. Q.P. and AV. are abbreviations of quasi-peak and average individually.
  2. "-": The Quasi-peak reading value also meets average limit and measurement with the average detector is unnecessary.
  3. The emission levels of other frequencies were very low against the limit.
  4. Margin value = Emission level - Limit value
  5. Correction factor = Insertion loss + Cable loss
  6. Emission Level = Correction Factor + Reading Value.

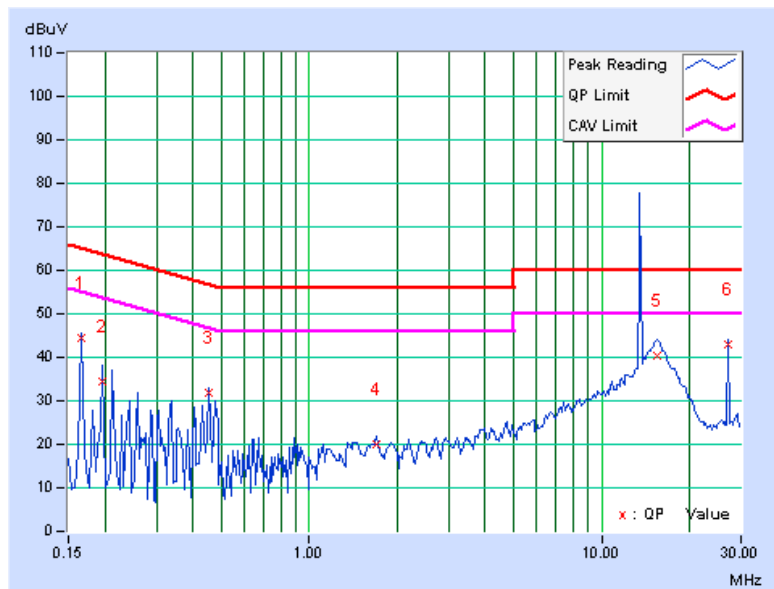

\*\* The emission level over the limit is the fundamental frequency of RFID.

<b>PHASE</b>	Line 2	<b>6dB BANDWIDTH</b>	9kHz
<b>TEST MODE</b>	B1		

No	Freq. [MHz]	Corr. Factor (dB)	Reading Value [dB (uV)]		Emission Level [dB (uV)]		Limit [dB (uV)]		Margin (dB)	
			Q.P.	AV.	Q.P.	AV.	Q.P.	AV.	Q.P.	AV.
1	0.166	0.13	43.65	-	43.78	-	65.18	55.18	-21.40	-
2	0.216	0.13	36.51	-	36.64	-	62.96	52.96	-26.31	-
3	0.455	0.14	31.25	-	31.39	-	56.79	46.79	-25.40	-
4	1.668	0.20	19.56	-	19.76	-	56.00	46.00	-36.24	-
5	15.301	1.02	38.57	-	39.59	-	60.00	50.00	-20.41	-
6	27.117	1.78	40.94	-	42.72	-	60.00	50.00	-17.28	-

- REMARKS:**
1. Q.P. and AV. are abbreviations of quasi-peak and average individually.
  2. "-": The Quasi-peak reading value also meets average limit and measurement with the average detector is unnecessary.
  3. The emission levels of other frequencies were very low against the limit.
  4. Margin value = Emission level - Limit value
  5. Correction factor = Insertion loss + Cable loss
  6. Emission Level = Correction Factor + Reading Value.

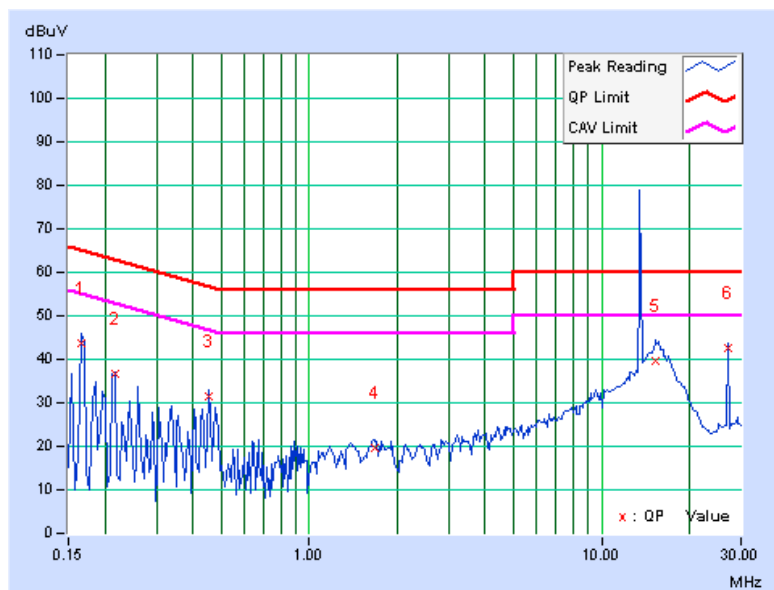

\*\* The emission level over the limit is the fundamental frequency of RFID.

### 802.11a + GSM 1900 BAND + BT + RFID

PHASE	Line 1	6dB BANDWIDTH	9kHz
TEST MODE	B2		

No	Freq. [MHz]	Corr. Factor (dB)	Reading Value		Emission Level		Limit		Margin	
			[dB (uV)]		[dB (uV)]		[dB (uV)]		(dB)	
			Q.P.	AV.	Q.P.	AV.	Q.P.	AV.	Q.P.	AV.
1	0.150	0.15	40.68	-	40.83	-	66.00	56.00	-25.17	-
2	0.189	0.14	40.76	-	40.90	-	64.08	54.08	-23.18	-
3	0.455	0.15	31.32	-	31.47	-	56.79	46.79	-25.32	-
4	1.621	0.21	18.84	-	19.05	-	56.00	46.00	-36.95	-
5	15.504	1.17	39.24	-	40.41	-	60.00	50.00	-19.59	-
6	27.117	2.03	40.92	-	42.95	-	60.00	50.00	-17.05	-

- REMARKS:**
1. Q.P. and AV. are abbreviations of quasi-peak and average individually.
  2. "-": The Quasi-peak reading value also meets average limit and measurement with the average detector is unnecessary.
  3. The emission levels of other frequencies were very low against the limit.
  4. Margin value = Emission level - Limit value
  5. Correction factor = Insertion loss + Cable loss
  6. Emission Level = Correction Factor + Reading Value.

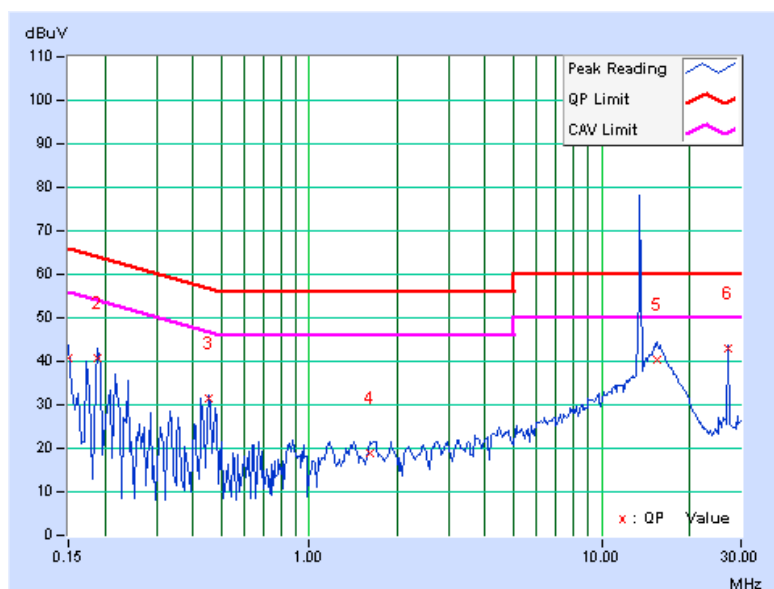

\*\* The emission level over the limit is the fundamental frequency of RFID.

PHASE	Line 2	6dB BANDWIDTH	9kHz
TEST MODE	B2		

No	Freq. [MHz]	Corr. Factor (dB)	Reading Value [dB (uV)]		Emission Level [dB (uV)]		Limit [dB (uV)]		Margin (dB)	
			Q.P.	AV.	Q.P.	AV.	Q.P.	AV.	Q.P.	AV.
1	0.170	0.13	43.49	-	43.62	-	64.98	54.98	-21.37	-
2	0.193	0.13	40.61	-	40.74	-	63.91	53.91	-23.17	-
3	0.455	0.14	31.57	-	31.71	-	56.79	46.79	-25.08	-
4	1.672	0.20	19.72	-	19.92	-	56.00	46.00	-36.08	-
5	15.883	1.05	38.33	-	39.38	-	60.00	50.00	-20.62	-
6	27.117	1.78	40.94	-	42.72	-	60.00	50.00	-17.28	-

- REMARKS:**
1. Q.P. and AV. are abbreviations of quasi-peak and average individually.
  2. "-": The Quasi-peak reading value also meets average limit and measurement with the average detector is unnecessary.
  3. The emission levels of other frequencies were very low against the limit.
  4. Margin value = Emission level - Limit value
  5. Correction factor = Insertion loss + Cable loss
  6. Emission Level = Correction Factor + Reading Value.

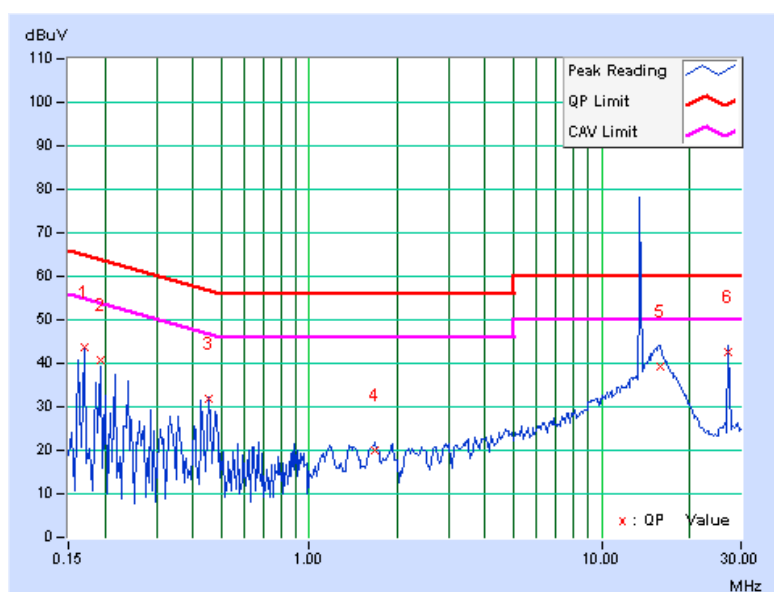

\*\* The emission level over the limit is the fundamental frequency of RFID.



802.11a + GSM 1900 BAND + BT + RFID

PHASE	Line 1	6dB BANDWIDTH	9kHz
TEST MODE	B3		

No	Freq. [MHz]	Corr. Factor (dB)	Reading Value		Emission Level		Limit		Margin	
			[dB (uV)]		[dB (uV)]		[dB (uV)]		(dB)	
			Q.P.	AV.	Q.P.	AV.	Q.P.	AV.	Q.P.	AV.
1	0.150	0.15	40.94	-	41.09	-	66.00	56.00	-24.91	-
2	0.170	0.14	43.63	-	43.77	-	64.98	54.98	-21.21	-
3	0.189	0.14	40.81	-	40.95	-	64.08	54.08	-23.13	-
4	0.455	0.15	31.69	-	31.84	-	56.79	46.79	-24.95	-
5	15.805	1.19	38.72	-	39.91	-	60.00	50.00	-20.09	-
6	27.121	2.03	40.85	-	42.88	-	60.00	50.00	-17.12	-

- REMARKS:**
1. Q.P. and AV. are abbreviations of quasi-peak and average individually.
  2. "-": The Quasi-peak reading value also meets average limit and measurement with the average detector is unnecessary.
  3. The emission levels of other frequencies were very low against the limit.
  4. Margin value = Emission level - Limit value
  5. Correction factor = Insertion loss + Cable loss
  6. Emission Level = Correction Factor + Reading Value.

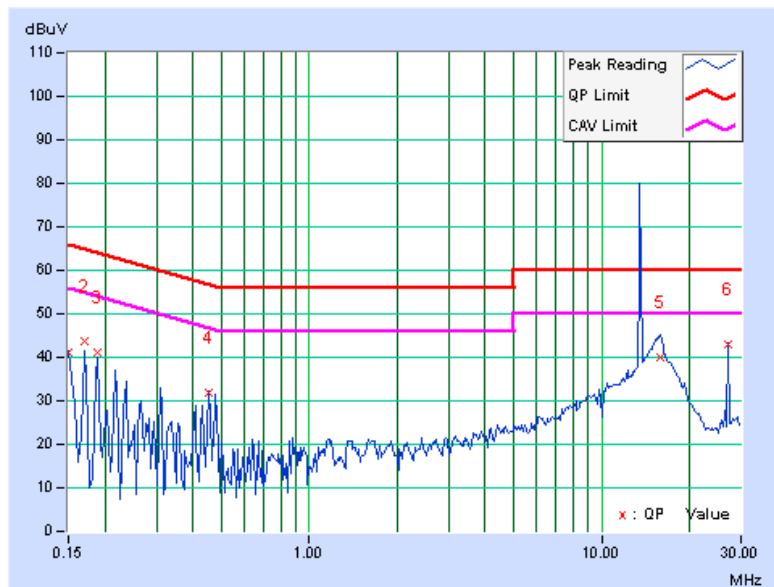

\*\* The emission level over the limit is the fundamental frequency of RFID.

PHASE	Line 2	6dB BANDWIDTH	9kHz
TEST MODE	B3		

No	Freq. [MHz]	Corr. Factor (dB)	Reading Value [dB (uV)]		Emission Level [dB (uV)]		Limit [dB (uV)]		Margin (dB)	
			Q.P.	AV.	Q.P.	AV.	Q.P.	AV.	Q.P.	AV.
1	0.166	0.13	44.13	-	44.26	-	65.18	55.18	-20.92	-
2	0.189	0.13	40.77	-	40.90	-	64.08	54.08	-23.18	-
3	0.466	0.14	23.86	-	24.00	-	56.58	46.58	-32.57	-
4	1.695	0.20	19.67	-	19.87	-	56.00	46.00	-36.13	-
5	15.691	1.04	39.03	-	40.07	-	60.00	50.00	-19.93	-
6	27.117	1.78	40.92	-	42.70	-	60.00	50.00	-17.30	-

- REMARKS:**
1. Q.P. and AV. are abbreviations of quasi-peak and average individually.
  2. "-": The Quasi-peak reading value also meets average limit and measurement with the average detector is unnecessary.
  3. The emission levels of other frequencies were very low against the limit.
  4. Margin value = Emission level - Limit value
  5. Correction factor = Insertion loss + Cable loss
  6. Emission Level = Correction Factor + Reading Value.

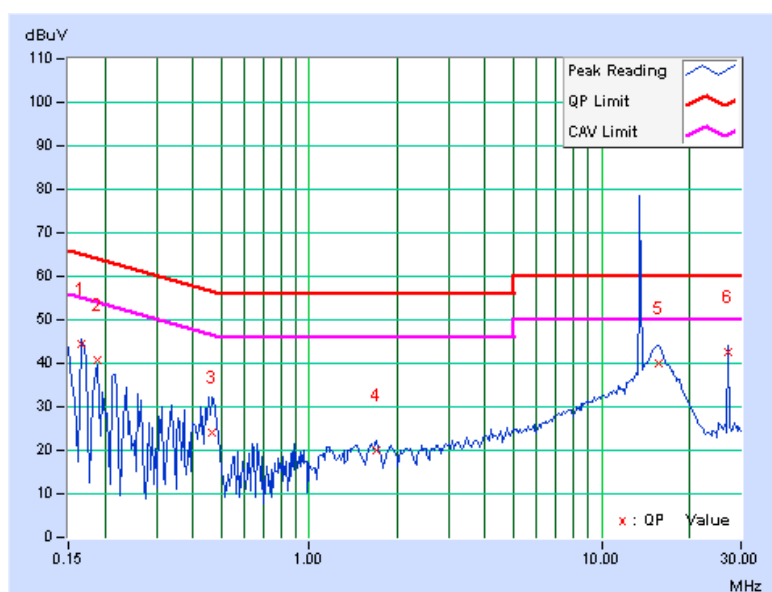

\*\* The emission level over the limit is the fundamental frequency of RFID.

802.11b + WCDMA 850 BAND + BT + RFID

PHASE	Line 1	6dB BANDWIDTH	9kHz
TEST MODE	C1		

No	Freq. [MHz]	Corr. Factor (dB)	Reading Value		Emission Level		Limit		Margin	
			[dB (uV)]		[dB (uV)]		[dB (uV)]		(dB)	
			Q.P.	AV.	Q.P.	AV.	Q.P.	AV.	Q.P.	AV.
1	0.162	0.14	37.90	-	38.04	-	65.38	55.38	-27.33	-
2	0.193	0.14	40.57	-	40.71	-	63.91	53.91	-23.20	-
3	0.451	0.15	31.10	-	31.25	-	56.86	46.86	-25.61	-
4	1.691	0.21	19.63	-	19.84	-	56.00	46.00	-36.16	-
5	15.789	1.19	39.07	-	40.26	-	60.00	50.00	-19.74	-
6	27.117	2.03	40.88	-	42.91	-	60.00	50.00	-17.09	-

- REMARKS:**
1. Q.P. and AV. are abbreviations of quasi-peak and average individually.
  2. "-": The Quasi-peak reading value also meets average limit and measurement with the average detector is unnecessary.
  3. The emission levels of other frequencies were very low against the limit.
  4. Margin value = Emission level - Limit value
  5. Correction factor = Insertion loss + Cable loss
  6. Emission Level = Correction Factor + Reading Value.

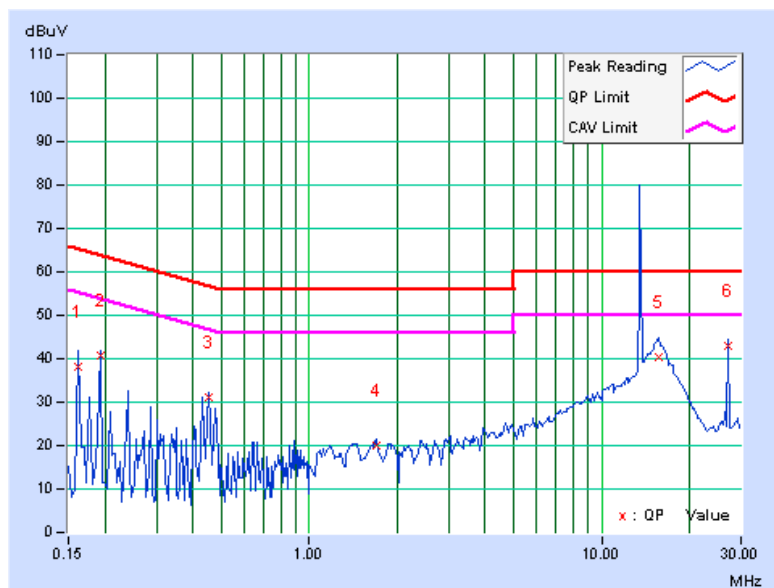

\*\* The emission level over the limit is the fundamental frequency of RFID.

PHASE	Line 2	6dB BANDWIDTH	9kHz
TEST MODE	C1		

No	Freq. [MHz]	Corr. Factor (dB)	Reading Value [dB (uV)]		Emission Level [dB (uV)]		Limit [dB (uV)]		Margin (dB)	
			Q.P.	AV.	Q.P.	AV.	Q.P.	AV.	Q.P.	AV.
1	0.166	0.13	44.11	-	44.24	-	65.18	55.18	-20.94	-
2	0.193	0.13	40.45	-	40.58	-	63.91	53.91	-23.33	-
3	0.455	0.14	31.67	-	31.81	-	56.79	46.79	-24.98	-
4	1.691	0.20	19.67	-	19.87	-	56.00	46.00	-36.13	-
5	15.488	1.03	39.22	-	40.25	-	60.00	50.00	-19.75	-
6	27.117	1.78	40.84	-	42.62	-	60.00	50.00	-17.38	-

- REMARKS:**
1. Q.P. and AV. are abbreviations of quasi-peak and average individually.
  2. "-": The Quasi-peak reading value also meets average limit and measurement with the average detector is unnecessary.
  3. The emission levels of other frequencies were very low against the limit.
  4. Margin value = Emission level - Limit value
  5. Correction factor = Insertion loss + Cable loss
  6. Emission Level = Correction Factor + Reading Value.

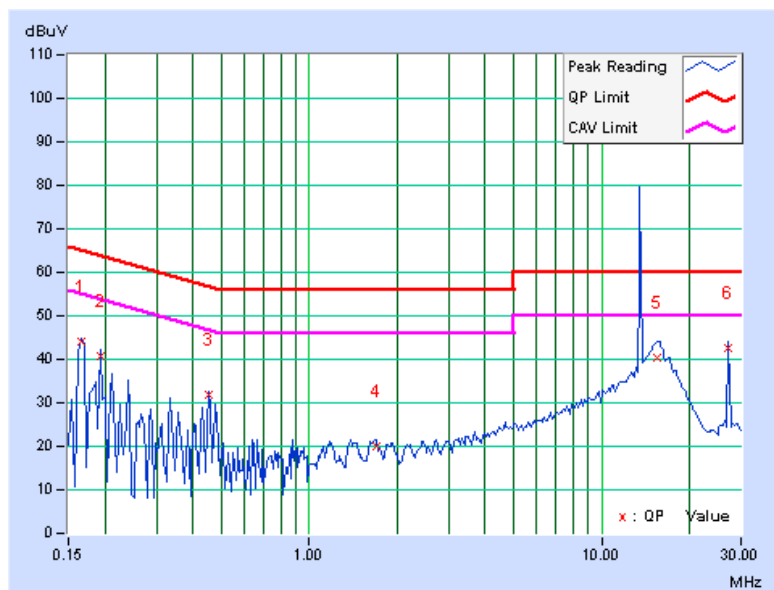

\*\* The emission level over the limit is the fundamental frequency of RFID.

802.11a + WCDMA 850 BAND + BT + RFID

PHASE	Line 1	6dB BANDWIDTH	9kHz
TEST MODE	C2		

No	Freq. [MHz]	Corr. Factor (dB)	Reading Value		Emission Level		Limit		Margin	
			[dB (uV)]		[dB (uV)]		[dB (uV)]		(dB)	
			Q.P.	AV.	Q.P.	AV.	Q.P.	AV.	Q.P.	AV.
1	0.173	0.14	37.32	-	37.46	-	64.79	54.79	-27.33	-
2	0.220	0.14	30.08	-	30.22	-	62.81	52.81	-32.59	-
3	0.463	0.15	23.22	-	23.37	-	56.65	46.65	-33.27	-
4	1.316	0.20	13.57	-	13.77	-	56.00	46.00	-42.23	-
5	15.383	1.16	38.72	-	39.88	-	60.00	50.00	-20.12	-
6	27.121	2.03	40.48	-	42.51	-	60.00	50.00	-17.49	-

- REMARKS:**
1. Q.P. and AV. are abbreviations of quasi-peak and average individually.
  2. "-": The Quasi-peak reading value also meets average limit and measurement with the average detector is unnecessary.
  3. The emission levels of other frequencies were very low against the limit.
  4. Margin value = Emission level - Limit value
  5. Correction factor = Insertion loss + Cable loss
  6. Emission Level = Correction Factor + Reading Value.

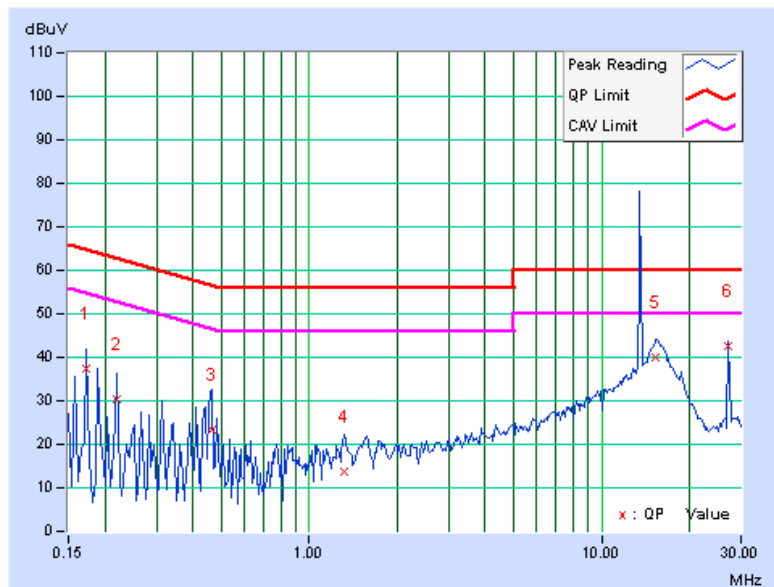

\*\* The emission level over the limit is the fundamental frequency of RFID.

PHASE	Line 2	6dB BANDWIDTH	9kHz
TEST MODE	C2		

No	Freq. [MHz]	Corr. Factor (dB)	Reading Value [dB (uV)]		Emission Level [dB (uV)]		Limit [dB (uV)]		Margin (dB)	
			Q.P.	AV.	Q.P.	AV.	Q.P.	AV.	Q.P.	AV.
1	0.166	0.13	43.93	-	44.06	-	65.18	55.18	-21.12	-
2	0.216	0.13	35.66	-	35.79	-	62.96	52.96	-27.16	-
3	0.263	0.13	32.11	-	32.24	-	61.33	51.33	-29.08	-
4	0.451	0.14	31.06	-	31.20	-	56.86	46.86	-25.66	-
5	15.590	1.04	38.56	-	39.60	-	60.00	50.00	-20.40	-
6	27.121	1.78	40.75	-	42.53	-	60.00	50.00	-17.47	-

- REMARKS:**
1. Q.P. and AV. are abbreviations of quasi-peak and average individually.
  2. "-": The Quasi-peak reading value also meets average limit and measurement with the average detector is unnecessary.
  3. The emission levels of other frequencies were very low against the limit.
  4. Margin value = Emission level - Limit value
  5. Correction factor = Insertion loss + Cable loss
  6. Emission Level = Correction Factor + Reading Value.

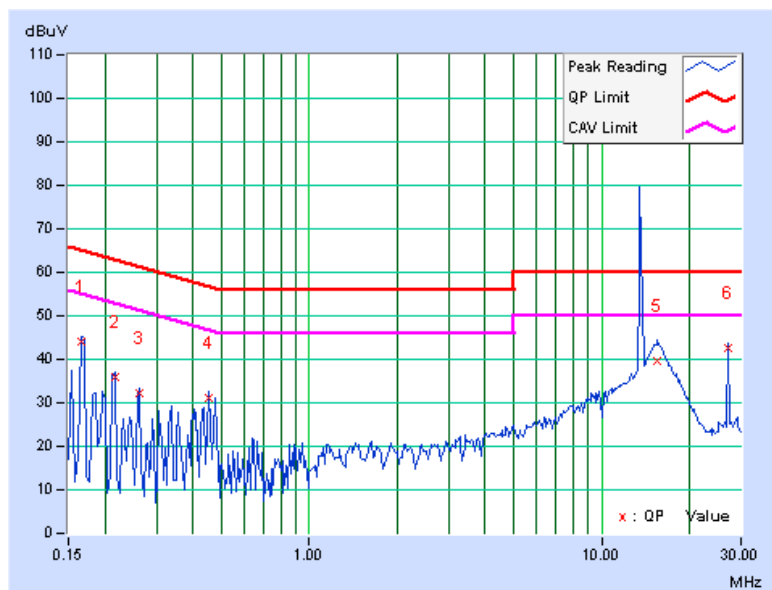

\*\* The emission level over the limit is the fundamental frequency of RFID.

802.11a + WCDMA 850 BAND + BT + RFID

PHASE	Line 1	6dB BANDWIDTH	9kHz
TEST MODE	C3		

No	Freq. [MHz]	Corr. Factor (dB)	Reading Value [dB (uV)]		Emission Level [dB (uV)]		Limit [dB (uV)]		Margin (dB)	
			Q.P.	AV.	Q.P.	AV.	Q.P.	AV.	Q.P.	AV.
			1	0.162	0.14	31.42	-	31.56	-	65.38
2	0.193	0.14	40.27	-	40.41	-	63.91	53.91	-23.50	-
3	0.463	0.15	31.53	-	31.68	-	56.65	46.65	-24.96	-
4	1.238	0.20	17.62	-	17.82	-	56.00	46.00	-38.18	-
5	15.813	1.19	38.33	-	39.52	-	60.00	50.00	-20.48	-
6	27.117	2.03	40.82	-	42.85	-	60.00	50.00	-17.15	-

- REMARKS:**
1. Q.P. and AV. are abbreviations of quasi-peak and average individually.
  2. "-": The Quasi-peak reading value also meets average limit and measurement with the average detector is unnecessary.
  3. The emission levels of other frequencies were very low against the limit.
  4. Margin value = Emission level - Limit value
  5. Correction factor = Insertion loss + Cable loss
  6. Emission Level = Correction Factor + Reading Value.

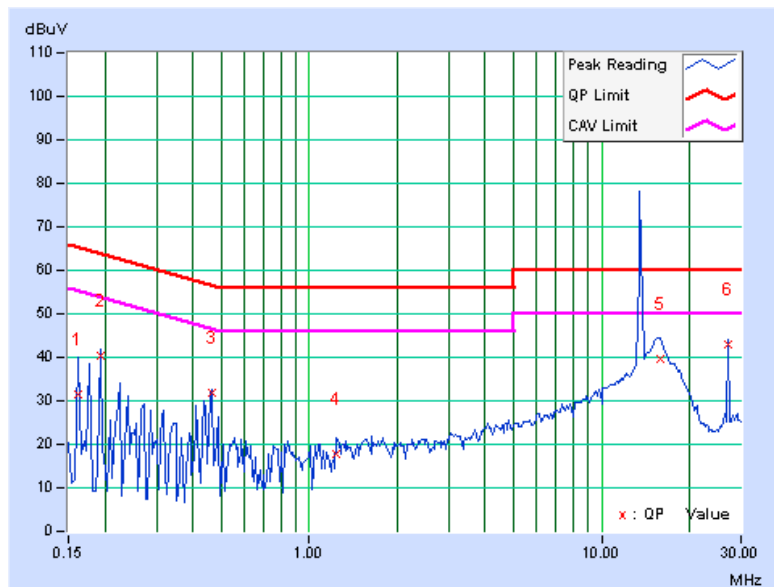

\*\* The emission level over the limit is the fundamental frequency of RFID.

PHASE	Line 2	6dB BANDWIDTH	9kHz
TEST MODE	C3		

No	Freq. [MHz]	Corr. Factor (dB)	Reading Value [dB (uV)]		Emission Level [dB (uV)]		Limit [dB (uV)]		Margin (dB)	
			Q.P.	AV.	Q.P.	AV.	Q.P.	AV.	Q.P.	AV.
1	0.150	0.12	46.15	-	46.27	-	66.00	56.00	-19.73	-
2	0.173	0.13	42.86	-	42.99	-	64.79	54.79	-21.81	-
3	0.220	0.13	35.96	-	36.09	-	62.81	52.81	-26.72	-
4	0.463	0.14	32.85	-	32.99	-	56.65	46.65	-23.65	-
5	15.988	1.06	38.67	-	39.73	-	60.00	50.00	-20.27	-
6	27.117	1.78	41.11	-	42.89	-	60.00	50.00	-17.11	-

- REMARKS:**
1. Q.P. and AV. are abbreviations of quasi-peak and average individually.
  2. "-": The Quasi-peak reading value also meets average limit and measurement with the average detector is unnecessary.
  3. The emission levels of other frequencies were very low against the limit.
  4. Margin value = Emission level - Limit value
  5. Correction factor = Insertion loss + Cable loss
  6. Emission Level = Correction Factor + Reading Value.

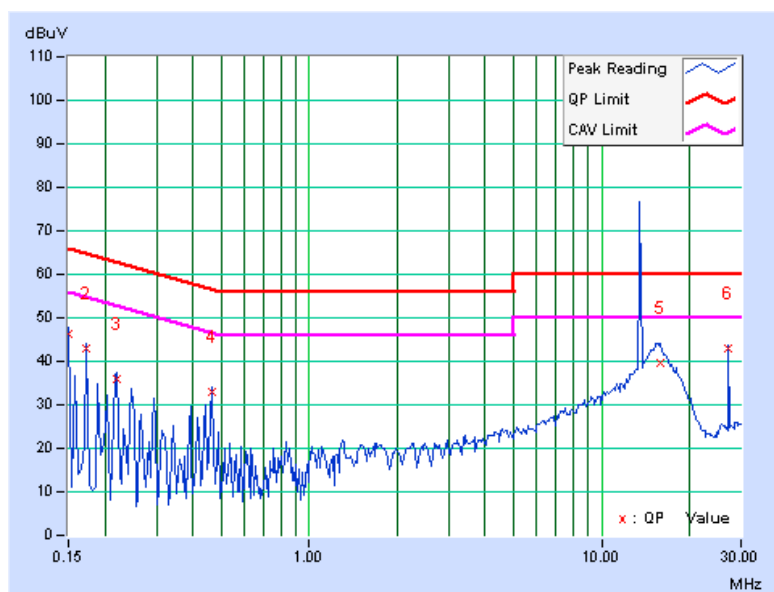

\*\* The emission level over the limit is the fundamental frequency of RFID.



### 802.11b + WCDMA 1900 BAND + BT + RFID

<b>PHASE</b>	Line 1	<b>6dB BANDWIDTH</b>	9kHz
<b>TEST MODE</b>	D1		

No	Freq. [MHz]	Corr. Factor (dB)	Reading Value		Emission Level		Limit		Margin	
			[dB (uV)]		[dB (uV)]		[dB (uV)]		(dB)	
			Q.P.	AV.	Q.P.	AV.	Q.P.	AV.	Q.P.	AV.
1	0.166	0.14	43.61	-	43.75	-	65.18	55.18	-21.42	-
2	0.193	0.14	40.68	-	40.82	-	63.91	53.91	-23.09	-
3	0.451	0.15	30.59	-	30.74	-	56.86	46.86	-26.12	-
4	1.645	0.21	19.08	-	19.29	-	56.00	46.00	-36.71	-
5	15.434	1.17	39.02	-	40.19	-	60.00	50.00	-19.81	-
6	27.117	2.03	40.88	-	42.91	-	60.00	50.00	-17.09	-

- REMARKS:**
1. Q.P. and AV. are abbreviations of quasi-peak and average individually.
  2. "-": The Quasi-peak reading value also meets average limit and measurement with the average detector is unnecessary.
  3. The emission levels of other frequencies were very low against the limit.
  4. Margin value = Emission level - Limit value
  5. Correction factor = Insertion loss + Cable loss
  6. Emission Level = Correction Factor + Reading Value.

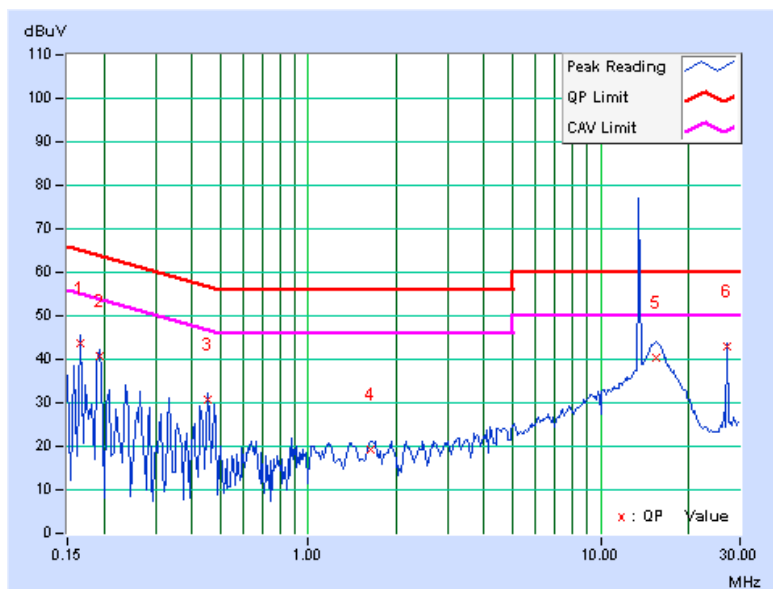

\*\* The emission level over the limit is the fundamental frequency of RFID.

PHASE	Line 2	6dB BANDWIDTH	9kHz
TEST MODE	D1		

No	Freq. [MHz]	Corr. Factor (dB)	Reading Value [dB (uV)]		Emission Level [dB (uV)]		Limit [dB (uV)]		Margin (dB)	
			Q.P.	AV.	Q.P.	AV.	Q.P.	AV.	Q.P.	AV.
1	0.170	0.13	42.95	-	43.08	-	64.98	54.98	-21.91	-
2	0.189	0.13	40.90	-	41.03	-	64.08	54.08	-23.05	-
3	0.455	0.14	31.07	-	31.21	-	56.79	46.79	-25.58	-
4	1.906	0.21	18.61	-	18.82	-	56.00	46.00	-37.18	-
5	15.695	1.04	39.05	-	40.09	-	60.00	50.00	-19.91	-
6	27.117	1.78	40.88	-	42.66	-	60.00	50.00	-17.34	-

- REMARKS:**
1. Q.P. and AV. are abbreviations of quasi-peak and average individually.
  2. "-": The Quasi-peak reading value also meets average limit and measurement with the average detector is unnecessary.
  3. The emission levels of other frequencies were very low against the limit.
  4. Margin value = Emission level - Limit value
  5. Correction factor = Insertion loss + Cable loss
  6. Emission Level = Correction Factor + Reading Value.

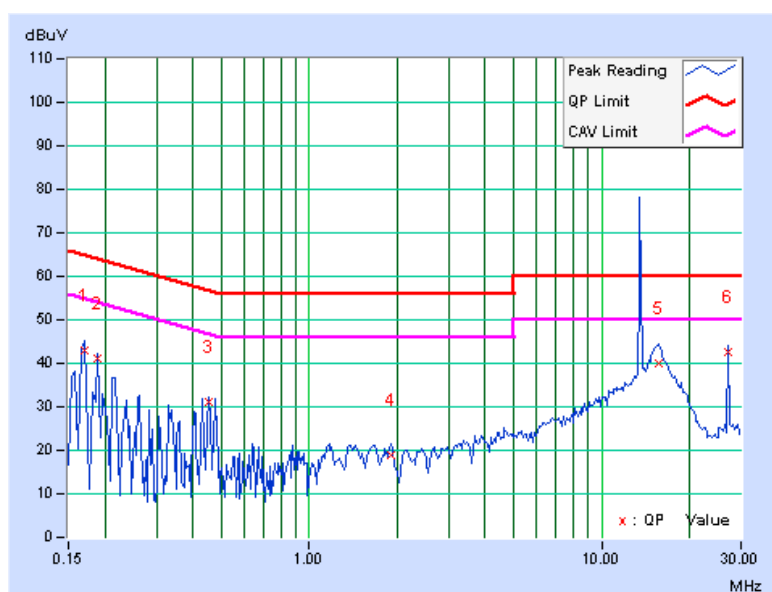

\*\* The emission level over the limit is the fundamental frequency of RFID.

**802.11a + WCDMA 1900 BAND + BT + RFID**

<b>PHASE</b>	Line 1	<b>6dB BANDWIDTH</b>	9kHz
<b>TEST MODE</b>	D2		

No	Freq. [MHz]	Corr. Factor (dB)	Reading Value		Emission Level		Limit		Margin	
			[dB (uV)]		[dB (uV)]		[dB (uV)]		(dB)	
			Q.P.	AV.	Q.P.	AV.	Q.P.	AV.	Q.P.	AV.
1	0.162	0.14	37.43	-	37.57	-	65.38	55.38	-27.80	-
2	0.193	0.14	40.82	-	40.96	-	63.91	53.91	-22.95	-
3	0.451	0.15	30.57	-	30.72	-	56.86	46.86	-26.14	-
4	1.668	0.21	19.74	-	19.95	-	56.00	46.00	-36.05	-
5	15.730	1.19	38.83	-	40.02	-	60.00	50.00	-19.98	-
6	27.117	2.03	40.88	-	42.91	-	60.00	50.00	-17.09	-

- REMARKS:**
1. Q.P. and AV. are abbreviations of quasi-peak and average individually.
  2. "-": The Quasi-peak reading value also meets average limit and measurement with the average detector is unnecessary.
  3. The emission levels of other frequencies were very low against the limit.
  4. Margin value = Emission level - Limit value
  5. Correction factor = Insertion loss + Cable loss
  6. Emission Level = Correction Factor + Reading Value.

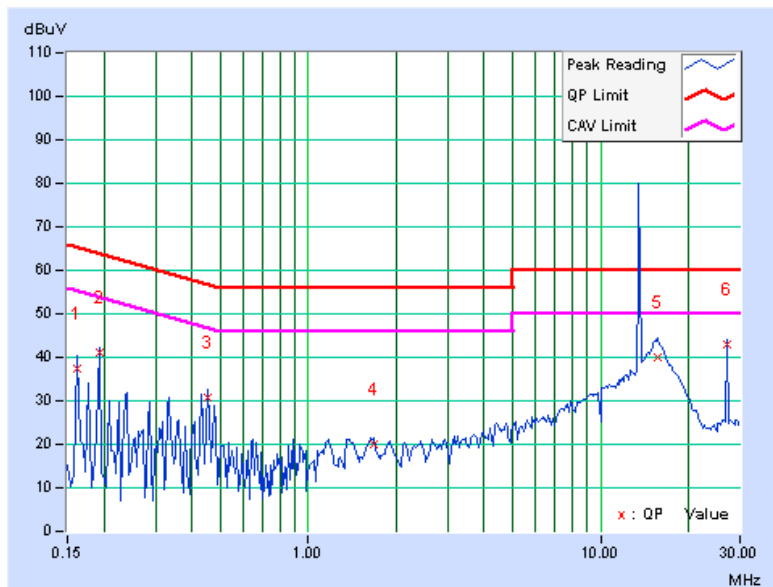

\*\* The emission level over the limit is the fundamental frequency of RFID.

<b>PHASE</b>	Line 2	<b>6dB BANDWIDTH</b>	9kHz
<b>TEST MODE</b>	D2		

No	Freq. [MHz]	Corr. Factor (dB)	Reading Value		Emission Level		Limit		Margin	
			[dB (uV)]		[dB (uV)]		[dB (uV)]		(dB)	
			Q.P.	AV.	Q.P.	AV.	Q.P.	AV.	Q.P.	AV.
1	0.162	0.13	38.02	-	38.15	-	65.38	55.38	-27.23	-
2	0.193	0.13	40.69	-	40.82	-	63.91	53.91	-23.09	-
3	0.466	0.14	21.99	-	22.13	-	56.58	46.58	-34.44	-
4	1.191	0.19	18.94	-	19.13	-	56.00	46.00	-36.87	-
5	16.008	1.06	38.23	-	39.29	-	60.00	50.00	-20.71	-
6	27.117	1.78	40.88	-	42.66	-	60.00	50.00	-17.34	-

- REMARKS:**
1. Q.P. and AV. are abbreviations of quasi-peak and average individually.
  2. "-": The Quasi-peak reading value also meets average limit and measurement with the average detector is unnecessary.
  3. The emission levels of other frequencies were very low against the limit.
  4. Margin value = Emission level - Limit value
  5. Correction factor = Insertion loss + Cable loss
  6. Emission Level = Correction Factor + Reading Value.

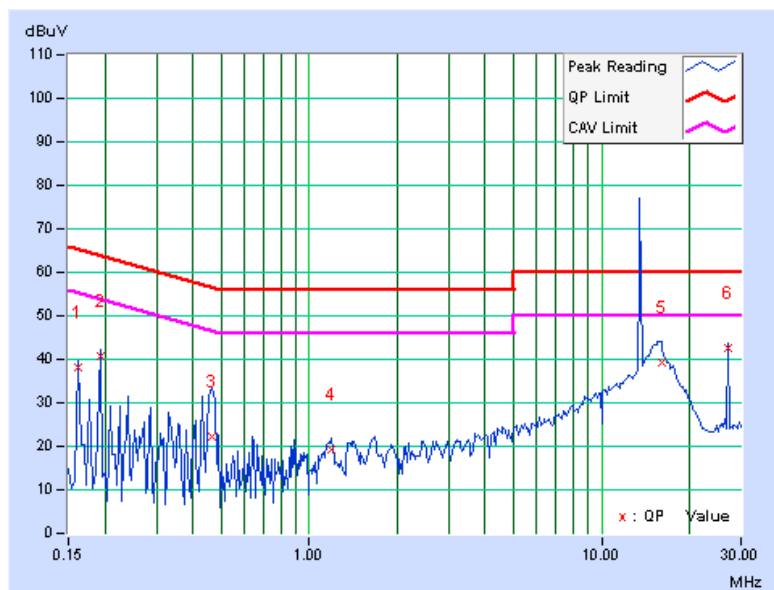

\*\* The emission level over the limit is the fundamental frequency of RFID.

**802.11a + WCDMA 1900 BAND + BT + RFID**

<b>PHASE</b>	Line 1	<b>6dB BANDWIDTH</b>	9kHz
<b>TEST MODE</b>	D3		

No	Freq. [MHz]	Corr. Factor (dB)	Reading Value [dB (uV)]		Emission Level [dB (uV)]		Limit [dB (uV)]		Margin (dB)	
			Q.P.	AV.	Q.P.	AV.	Q.P.	AV.	Q.P.	AV.
1	0.166	0.14	44.23	-	44.37	-	65.18	55.18	-20.80	-
2	0.193	0.14	40.69	-	40.83	-	63.91	53.91	-23.08	-
3	0.451	0.15	31.02	-	31.17	-	56.86	46.86	-25.69	-
4	1.359	0.20	18.70	-	18.90	-	56.00	46.00	-37.10	-
5	15.711	1.19	39.01	-	40.20	-	60.00	50.00	-19.80	-
6	27.117	2.03	40.90	-	42.93	-	60.00	50.00	-17.07	-

- REMARKS:**
1. Q.P. and AV. are abbreviations of quasi-peak and average individually.
  2. "-": The Quasi-peak reading value also meets average limit and measurement with the average detector is unnecessary.
  3. The emission levels of other frequencies were very low against the limit.
  4. Margin value = Emission level - Limit value
  5. Correction factor = Insertion loss + Cable loss
  6. Emission Level = Correction Factor + Reading Value.

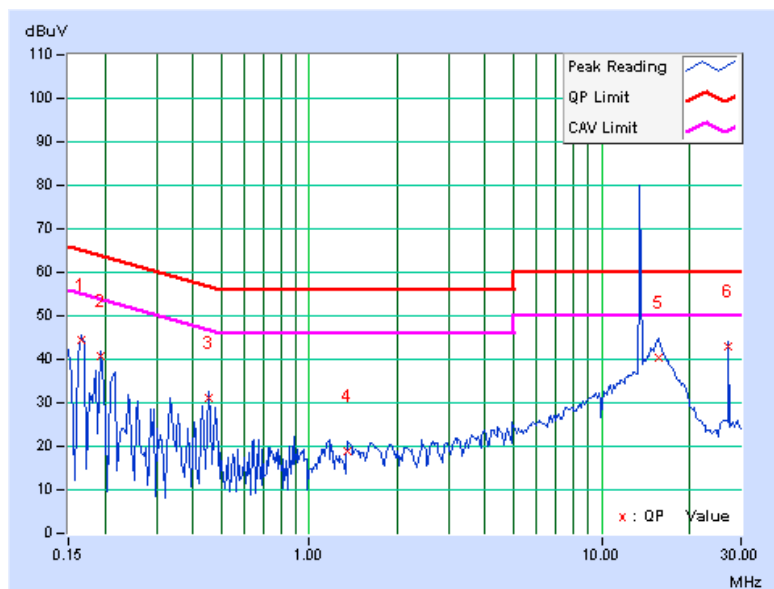

\*\* The emission level over the limit is the fundamental frequency of RFID.

PHASE	Line 2	6dB BANDWIDTH	9kHz
TEST MODE	D3		

No	Freq. [MHz]	Corr. Factor (dB)	Reading Value [dB (uV)]		Emission Level [dB (uV)]		Limit [dB (uV)]		Margin (dB)	
			Q.P.	AV.	Q.P.	AV.	Q.P.	AV.	Q.P.	AV.
1	0.150	0.12	40.45	-	40.57	-	66.00	56.00	-25.43	-
2	0.170	0.13	43.05	-	43.18	-	64.98	54.98	-21.81	-
3	0.189	0.13	40.99	-	41.12	-	64.08	54.08	-22.96	-
4	0.455	0.14	31.15	-	31.29	-	56.79	46.79	-25.50	-
5	15.434	1.03	39.24	-	40.27	-	60.00	50.00	-19.73	-
6	27.117	1.78	40.90	-	42.68	-	60.00	50.00	-17.32	-

- REMARKS:**
1. Q.P. and AV. are abbreviations of quasi-peak and average individually.
  2. "-": The Quasi-peak reading value also meets average limit and measurement with the average detector is unnecessary.
  3. The emission levels of other frequencies were very low against the limit.
  4. Margin value = Emission level - Limit value
  5. Correction factor = Insertion loss + Cable loss
  6. Emission Level = Correction Factor + Reading Value.

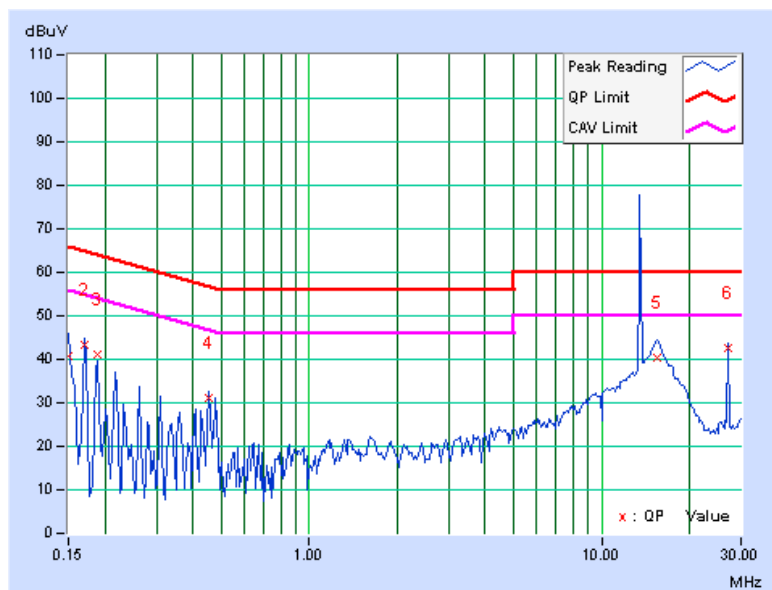

\*\* The emission level over the limit is the fundamental frequency of RFID.



## 5. PHOTOGRAPHS OF THE TEST CONFIGURATION

Please refer to the attached file (Test Setup Photo).



## 6. INFORMATION ON THE TESTING LABORATORIES

We, Bureau Veritas Consumer Products Services (H.K.) Ltd., Taoyuan Branch, were founded in 1988 to provide our best service in EMC, Radio, Telecom and Safety consultation. Our laboratories are accredited and approved according to ISO/IEC 17025.

Copies of accreditation certificates of our laboratories obtained from approval agencies can be downloaded from our web site: [www.adt.com.tw/index.5/phtml](http://www.adt.com.tw/index.5/phtml). If you have any comments, please feel free to contact us at the following:

**Linko EMC/RF Lab:**

Tel: 886-2-26052180

Fax: 886-2-26051924

**Hsin Chu EMC/RF Lab:**

Tel: 886-3-5935343

Fax: 886-3-5935342

**Hwa Ya EMC/RF/Safety Telecom Lab:**

Tel: 886-3-3183232

Fax: 886-3-3185050

**Web Site:** [www.adt.com.tw](http://www.adt.com.tw)

The address and road map of all our labs can be found in our web site also.





## **7. APPENDIX A - MODIFICATIONS RECORDERS FOR ENGINEERING CHANGES TO THE EUT BY THE LAB**

No any modifications are made to the EUT by the lab during the test.

**---END---**