



FCC RADIO TEST REPORT

FCC ID : UZ7MC3300U
Equipment : Mobile Computer
Brand Name : Zebra
Model name : MC3300U
Applicant : Zebra Technologies Corporation
1 Zebra Plaza, Holtsville, NY 11742
Manufacturer : Zebra Technologies Corporation
1 Zebra Plaza, Holtsville, NY 11742
Standard : FCC Part 15 Subpart E §15.407

The product was received on Aug. 12, 2019 and testing was started from Sep. 23, 2019 and completed on Nov. 04, 2019. We, SPORTON INTERNATIONAL INC., EMC & Wireless Communications Laboratory, would like to declare that the tested sample has been evaluated in accordance with the test procedures and has been in compliance with the applicable technical standards.

The report must not be used by the client to claim product certification, approval, or endorsement by TAF or any agency of government.

The test results in this report apply exclusively to the tested model / sample. Without written approval of SPORTON INTERNATIONAL INC. EMC & Wireless Communications Laboratory, the test report shall not be reproduced except in full.

Louis Wu

Approved by: Louis Wu

SPORTON INTERNATIONAL INC. EMC & Wireless Communications Laboratory

No. 52, Huaya 1st Rd., Guishan Dist., Taoyuan City, Taiwan (R.O.C.)



Table of Contents

History of this test report.....	3
Summary of Test Result.....	4
1 General Description	5
1.1 Product Feature of Equipment Under Test.....	5
1.2 Product Specification of Equipment Under Test.....	7
1.3 Modification of EUT	8
1.4 Testing Location	9
1.5 Applicable Standards.....	9
2 Test Configuration of Equipment Under Test	10
2.1 Carrier Frequency and Channel	10
2.2 Test Mode.....	11
2.3 Connection Diagram of Test System.....	19
2.4 Support Unit used in test configuration and system	20
2.5 EUT Operation Test Setup	21
2.6 Measurement Results Explanation Example.....	21
3 Test Result	22
3.1 6dB and 26dB and 99% Occupied Bandwidth Measurement	22
3.2 Maximum Conducted Output Power Measurement	28
3.3 Power Spectral Density Measurement	31
3.4 Unwanted Emissions Measurement.....	37
3.5 AC Conducted Emission Measurement.....	43
3.6 Automatically Discontinue Transmission	45
3.7 Antenna Requirements.....	46
4 List of Measuring Equipment.....	48
5 Uncertainty of Evaluation.....	50
Appendix A. AC Conducted Emission Test Result	
Appendix B. Radiated Spurious Emission	
Appendix C. Radiated Spurious Emission Plots	
Appendix D. Duty Cycle Plots	
Appendix E. Setup Photographs	



History of this test report

Report No.	Version	Description	Issued Date
FR981238G	01	Initial issue of report	Dec. 09, 2019



Summary of Test Result

Report Clause	Ref Std. Clause	Test Items	Result (PASS/FAIL)	Remark
3.1	15.403 (i)	6dB & 26dB Bandwidth	Pass	-
3.1	2.1049	99% Occupied Bandwidth	Reporting only	-
3.2	15.407 (a)	Maximum Conducted Output Power	Pass	-
3.3	15.407 (a)	Power Spectral Density	Pass	-
3.4	15.407(b)	Unwanted Emissions	Pass	Under limit 3.63 dB at 34.850 MHz for Quasi-Peak
3.5	15.207	AC Conducted Emission	Pass	Under limit 15.96 dB at 0.308 MHz
3.6	15.407 (c)	Automatically Discontinue Transmission	Pass	-
3.7	15.203 & 15.407 (a)	Antenna Requirement	Pass	-

Declaration of Conformity:

The test results with all measurement uncertainty excluded are presented in accordance with the regulation limits or requirements declared by manufacturers.

Comments and Explanations:

The declared of product specification for EUT presented in the report are provided by the manufacturer, and the manufacturer takes all the responsibilities for the accuracy of product specification.

Reviewed by: Wii Chang

Report Producer: Tina Chuang



1 General Description

1.1 Product Feature of Equipment Under Test

Product Feature	
Equipment	Mobile Computer
Brand Name	Zebra
Model Name	MC3300U
FCC ID	UZ7MC3300U
EUT supports Radios application	NFC WLAN 11a/b/g/n HT20/HT40 WLAN 11ac VHT20/VHT40/VHT80 Bluetooth BR/EDR/LE
HW Version	DV
SW Version	RFID Manager Application Version: 2.0.10.1 123 RFID Mobile Application Version: 1.0.0.11 Terminal Version: 02-11-14.00-PG-U07-PRD
FW Version	Module Version: PAAEES00-001-N20 Radio Version: 2.0.32.0 Terminal Version: FUSION_QA_2_1.2.0.006_P
MFD	27JUL19
EUT Stage	Identical Prototype

Remark: The above EUT's information was declared by manufacturer.

Specification of Accessories				
AC Adapter	Brand Name	Zebra	Part Number	PWR-WUA5V12W0US
USB Cable	Brand Name	Zebra	Part Number	CBL-MC33-USBCHG-01
MC32 2X battery (Inventus)	Brand Name	Symbol	Part Number	82-000012-02
MC33 2X battery (Inventus)	Brand Name	Zebra	Part Number	BT-000337-01
MC33 7000mA 2X (Inventus)	Brand Name	Zebra	Part Number	BT-000375-10
GUN Holster	Brand Name	Zebra	Part Number	SG-MC3021212-01R



<Sample Information>

	SKU1	SKU2	SKU3
Part Number	MC333U-GJ2EG4US	MC339U-GE2EG4US	MC339U-GF2EG4US
RFID Antenna	Middle range	Long range	Long range
Scanner	SE4770	SE4850	SE4750MR
Keypad	29	29	29
Region	US	US	US

	SKU7	SKU8	SKU9
Part Number	MC333U-GJ3EG4US	MC339U-GE3EG4US	MC339U-GF3EG4US
RFID Antenna	Middle range	Long range	Long range
Scanner	SE4770	SE4850	SE4750MR
Keypad	38	38	38
Region	US	US	US

	SKU13	SKU14	SKU15
Part Number	MC333U-GJ4EG4US	MC339U-GE4EG4US	MC339U-GF4EG4US
RFID Antenna	Middle range	Long range	Long range
Scanner	SE4770	SE4850	SE4750MR
Keypad	47	47	47
Region	US	US	US



1.2 Product Specification of Equipment Under Test

Standards-related Product Specification	
Tx/Rx Frequency Range	5745 MHz ~ 5825 MHz
Maximum Output Power to Antenna <CDD Modes>	<p><5745 MHz ~ 5825 MHz></p> <p><Ant. 1> 802.11a : 17.90 dBm / 0.0617 W 802.11n HT20 : 17.70 dBm / 0.0589 W 802.11n HT40 : 17.80 dBm / 0.0603 W 802.11ac VHT20: 17.80 dBm / 0.0603 W 802.11ac VHT40: 17.90 dBm / 0.0617 W 802.11ac VHT80: 17.90 dBm / 0.0617 W</p> <p><Ant. 2> 802.11a : 17.80 dBm / 0.0603 W 802.11n HT20 : 17.80 dBm / 0.0603 W 802.11n HT40 : 17.80 dBm / 0.0603 W 802.11ac VHT20: 17.90 dBm / 0.0617 W 802.11ac VHT40: 17.80 dBm / 0.0603 W 802.11ac VHT80: 17.90 dBm / 0.0617 W</p> <p>MIMO <Ant. 1 + 2> 802.11a : 20.71 dBm / 0.1178 W 802.11n HT20 : 20.66 dBm / 0.1164 W 802.11n HT40 : 20.66 dBm / 0.1164 W 802.11ac VHT20: 20.76 dBm / 0.1191 W 802.11ac VHT40: 20.76 dBm / 0.1191 W 802.11ac VHT80: 20.76 dBm / 0.1191 W</p>
Maximum Output Power to Antenna <TXBF Modes>	<p><MIMO <Ant. 1 + 2></p> 802.11ac VHT20: 19.92 dBm / 0.0982 W 802.11ac VHT40: 20.25 dBm / 0.1059 W 802.11ac VHT80: 20.48 dBm / 0.1117 W
99% Occupied Bandwidth <CDD Modes>	<p><Ant. 1> 802.11a : 16.73 MHz 802.11ac VHT20 : 17.88 MHz 802.11ac VHT40 : 36.56 MHz 802.11ac VHT80 : 76.24 MHz</p> <p><Ant. 2> 802.11a : 16.73 MHz 802.11ac VHT20 : 17.93 MHz 802.11ac VHT40 : 36.56 MHz 802.11ac VHT80 : 76.24 MHz</p> <p>MIMO <Ant. 1> 802.11a : 16.73 MHz 802.11ac VHT20 : 17.93 MHz 802.11ac VHT40 : 36.56 MHz 802.11ac VHT80 : 76.24 MHz</p> <p>MIMO <Ant. 2> 802.11a : 16.63 MHz 802.11ac VHT20 : 17.93 MHz 802.11ac VHT40 : 36.46 MHz 802.11ac VHT80 : 76.24 MHz</p>



Standards-related Product Specification			
99% Occupied Bandwidth <TXBF Modes>	<MIMO Ant. 1> 802.11ac VHT20 : 17.73 MHz 802.11ac VHT40 : 36.86 MHz 802.11ac VHT80 : 76.48 MHz		
	<MIMO Ant. 2> 802.11ac VHT20 : 19.18 MHz 802.11ac VHT40 : 36.56 MHz 802.11ac VHT80 : 76.60 MHz		
Type of Modulation	802.11a/n : OFDM (BPSK / QPSK / 16QAM / 64QAM) 802.11ac : OFDM (BPSK / QPSK / 16QAM / 64QAM / 256QAM)		
Antenna Gain / Gain	<Ant. 1> : Patch Antenna with gain 4.01 dBi <Ant. 2> : Patch Antenna with gain 4.32 dBi		
Antenna Function Description		Ant. 1	Ant. 2
	802.11 a/n/ac	V	V
	802.11 a/n/ac MIMO	V	V
	802.11 ac TXBF	V	V

Note: MIMO Ant. 1+2 is a calculated result from sum of the power MIMO Ant. 1 and MIMO Ant. 2.

1.3 Modification of EUT

No modifications are made to the EUT during all test items.



1.4 Testing Location

Test Site	SPORTON INTERNATIONAL INC. EMC & Wireless Communications Laboratory	
Test Site Location	No.52, Huaya 1st Rd., Guishan Dist., Taoyuan City, Taiwan (R.O.C.) TEL: +886-3-327-3456 FAX: +886-3-328-4978	
Test Site No.	Sporton Site No.	
	TH05-HY	CO05-HY

Note: The test site complies with ANSI C63.4 2014 requirement.

Test Site	SPORTON INTERNATIONAL INC. EMC & Wireless Communications Laboratory	
Test Site Location	No.58, Aly. 75, Ln. 564, Wenhua 3rd, Rd., Guishan Dist., Taoyuan City, Taiwan (R.O.C.) TEL: +886-3-327-0868 FAX: +886-3-327-0855	
Test Site No.	Sporton Site No.	
	03CH11-HY	

Note: The test site complies with ANSI C63.4 2014 requirement.

FCC designation No.: TW1190 and TW0007

1.5 Applicable Standards

According to the specifications of the manufacturer, the EUT must comply with the requirements of the following standards:

- ♦ FCC Part 15 Subpart E
- ♦ FCC KDB 789033 D02 General UNII Test Procedures New Rules v02r01.
- ♦ FCC KDB 414788 D01 Radiated Test Site v01r01.
- ♦ FCC KDB 662911 D01 Multiple Transmitter Output v02r01.
- ♦ ANSI C63.10-2013

Remark:

1. All test items were verified and recorded according to the standards and without any deviation during the test.
2. This EUT has also been tested and complied with the requirements of FCC Part 15, Subpart B, recorded in a separate test report.



2 Test Configuration of Equipment Under Test

- a. The EUT has been associated with peripherals and configuration operated in a manner tended to maximize its emission characteristics in a typical application. Frequency range investigated: conduction emission (150 kHz to 30 MHz), radiation emission (9 kHz to the 10th harmonic of the highest fundamental frequency or to 40 GHz, whichever is lower). For radiated measurement, pre-scanned in three orthogonal panels, X, Y, Z. The worst cases (SKU 1: Y plane for Ant. 1, and Ant. 2, Z plane for CDD and TXBF Mode; SKU 2: Y plane for Ant. 1; SKU 3: Y plane for Ant. 1) were recorded in this report

- b. AC power line Conducted Emission was tested under maximum output power.

2.1 Carrier Frequency and Channel

Frequency Band	Channel	Freq. (MHz)	Channel	Freq. (MHz)
5725-5850 MHz Band 4 (U-NII-3)	149	5745	157	5785
	151*	5755	159*	5795
	153	5765	161	5805
	155#	5775	165	5825

Note:

- 1. The above Frequency and Channel in "*" were 802.11n HT40 and 802.11ac VHT40.
- 2. The above Frequency and Channel in "#n" were 802.11ac VHT80.



2.2 Test Mode

Final test modes are considering the modulation and worse data rates as below table.

Single Mode

Modulation	Data Rate
802.11a	6 Mbps
802.11n HT20 (Covered by VHT20)	MCS0
802.11n HT40 (Covered by VHT40)	MCS0
802.11ac VHT20	MCS0
802.11ac VHT40	MCS0
802.11ac VHT80	MCS0

MIMO Mode

Modulation	Data Rate
802.11a	6 Mbps
802.11n HT20 (Covered by VHT20)	MCS0
802.11n HT40 (Covered by VHT40)	MCS0
802.11ac VHT20	MCS0
802.11ac VHT40	MCS0
802.11ac VHT80	MCS0

TXBF Mode

Modulation	Data Rate
802.11ac VHT20	MCS0
802.11ac VHT40	MCS0
802.11ac VHT80	MCS0

Test Cases	
AC Conducted Emission	Mode 1 :WLAN (5GHz) Link + Bluetooth Link + Keypad (29) + MPEG4 + Battery (Sentry 2X) + USB Cable + Adapter (PWR-WUA5V12W0US) for SKU 1
Remark: For Radiated Test Cases, the tests were performed with MC32 2X battery.	



Ch. #		Band IV : 5725-5850 MHz			
		802.11a	802.11ac VHT20	802.11ac VHT40	802.11ac VHT80
L	Low	149	149	151	-
M	Middle	157	157	-	155
H	High	165	165	159	-

<CDD Mode>

<Ant. 1>

802.11a RF Output Power (dBm)										
Power vs. Channel			Power vs Data Rate							
Channel	Frequency (MHz)	Data Rate (bps)	Channel	Data Rate (bps)						
		6M		9M	12M	18M	24M	36M	48M	54M
Duty Cycle (%)		95.73		94.30	92.60	89.60	87.00	82.00	77.70	75.90
CH 149	5745	17.90	CH 149							
CH 157	5785	17.80		17.80	17.80	17.70	17.60	17.80	17.80	17.80
CH 165	5825	17.80								

802.11n HT20 RF Output Power (dBm)										
Power vs. Channel			Power vs Data Rate							
Channel	Frequency (MHz)	MCS Index	Channel	MCS Index						
		MCS0		MCS1	MCS2	MCS3	MCS4	MCS5	MCS6	MCS7
Duty Cycle (%)		95.07		92.10	89.00	86.20	81.30	77.20	75.70	74.00
CH 149	5745	17.60	CH 165							
CH 157	5785	17.60		17.60	17.40	17.40	17.60	17.60	17.60	17.60
CH 165	5825	17.70								

802.11n HT40 RF Output Power (dBm)										
Power vs. Channel			Power vs Data Rate							
Channel	Frequency (MHz)	MCS Index	Channel	MCS Index						
		MCS0		MCS1	MCS2	MCS3	MCS4	MCS5	MCS6	MCS7
Duty Cycle (%)		91.15		85.80	80.80	76.80	70.30	65.80	63.90	61.80
CH 151	5755	17.70	CH 159							
CH 159	5795	17.80		17.70	17.70	17.70	17.70	17.70	17.70	17.70



802.11ac VHT20 RF Output Power (dBm)											
Power vs. Channel			Power vs Data Rate								
Channel	Frequency (MHz)	MCS Index	Channel	MCS Index							
		MCS0		MCS1	MCS2	MCS3	MCS4	MCS5	MCS6	MCS7	MCS8
Duty Cycle (%)		95.54		92.10	89.00	86.40	81.50	77.60	75.80	74.40	71.50
CH 149	5745	17.70	CH 165								
CH 157	5785	17.70		17.70	17.50	17.50	17.70	17.70	17.70	17.70	17.70
CH 165	5825	17.80									

802.11ac VHT40 RF Output Power (dBm)												
Power vs. Channel			Power vs Data Rate									
Channel	Frequency (MHz)	MCS Index	Channel	MCS Index								
		MCS0		MCS1	MCS2	MCS3	MCS4	MCS5	MCS6	MCS7	MCS8	MCS9
Duty Cycle (%)		91.51		85.90	81.00	77.00	70.60	66.20	64.40	62.50	59.50	58.60
CH 151	5755	17.80	CH 159									
CH 159	5795	17.90		17.80	17.80	17.80	17.80	17.80	17.80	17.80	17.80	17.80

802.11ac VHT80 RF Output Power (dBm)												
Power vs. Channel			Power vs Data Rate									
Channel	Frequency (MHz)	MCS Index	Channel	MCS Index								
		MCS0		MCS1	MCS2	MCS3	MCS4	MCS5	MCS6	MCS7	MCS8	MCS9
Duty Cycle (%)		85.29		76.00	17.80	17.80	17.80	17.80	17.80	17.80	17.80	17.80
CH155	5775	17.90	CH 155	17.40	17.40	17.40	17.40	17.40	17.40	17.40	17.40	15.20



<Ant. 2>

802.11a RF Output Power (dBm)										
Power vs. Channel			Power vs Data Rate							
Channel	Frequency (MHz)	Data Rate (bps)	Channel	Data Rate (bps)						
		6M		9M	12M	18M	24M	36M	48M	54M
Duty Cycle (%)		95.82		94.30	92.60	89.70	87.00	82.20	77.70	76.00
CH 149	5745	17.60	CH 157							
CH 157	5785	17.80		17.70	17.70	17.60	17.60	17.70	17.70	17.70
CH 165	5825	17.70								

802.11n HT20 RF Output Power (dBm)										
Power vs. Channel			Power vs Data Rate							
Channel	Frequency (MHz)	MCS Index	Channel	MCS Index						
		MCS0		MCS1	MCS2	MCS3	MCS4	MCS5	MCS6	MCS7
Duty Cycle (%)		95.15		92.10	89.00	86.30	81.50	77.30	75.70	74.20
CH 149	5745	17.70	CH 165							
CH 157	5785	17.70		17.70	17.50	17.50	17.70	17.70	17.70	17.70
CH 165	5825	17.80								

802.11n HT40 RF Output Power (dBm)										
Power vs. Channel			Power vs Data Rate							
Channel	Frequency (MHz)	MCS Index	Channel	MCS Index						
		MCS0		MCS1	MCS2	MCS3	MCS4	MCS5	MCS6	MCS7
Duty Cycle (%)		91.47		85.80	80.80	76.80	70.30	65.80	63.90	61.80
CH 151	5755	17.50	CH 159							
CH 159	5795	17.70		85.80	80.80	76.80	70.30	65.80	63.90	61.80



802.11ac VHT20 RF Output Power (dBm)											
Power vs. Channel			Power vs Data Rate								
Channel	Frequency (MHz)	MCS Index	Channel	MCS Index							
		MCS0		MCS1	MCS2	MCS3	MCS4	MCS5	MCS6	MCS7	MCS8
Duty Cycle (%)		95.85		92.20	89.10	86.40	81.50	77.70	75.90	74.40	71.60
CH 149	5745	17.80	CH 165	17.80	17.60	17.60	17.80	17.80	17.80	17.80	17.80
CH 157	5785	17.80									
CH 165	5825	17.90									

802.11ac VHT40 RF Output Power (dBm)												
Power vs. Channel			Power vs Data Rate									
Channel	Frequency (MHz)	MCS Index	Channel	MCS Index								
		MCS0		MCS1	MCS2	MCS3	MCS4	MCS5	MCS6	MCS7	MCS8	MCS9
Duty Cycle (%)		91.19		85.90	81.00	77.00	70.60	66.20	64.40	62.50	59.50	58.60
CH 151	5755	17.60	CH 159	17.70	17.70	17.70	17.70	17.70	17.70	17.70	17.70	17.70
CH 159	5795	17.80										

802.11ac VHT80 RF Output Power (dBm)												
Power vs. Channel			Power vs Data Rate									
Channel	Frequency (MHz)	MCS Index	Channel	MCS Index								
		MCS0		MCS1	MCS2	MCS3	MCS4	MCS5	MCS6	MCS7	MCS8	MCS9
Duty Cycle (%)		85.61		76.00	69.80	65.30	58.70	55.00	52.90	51.80	49.30	48.00
CH155	5775	17.90	CH155	17.60	17.60	17.60	17.50	17.60	17.60	17.60	17.60	17.60



MIMO <Ant. 1+2>

802.11a RF Output Power (dBm)										
Power vs. Channel			Power vs Data Rate							
Channel	Frequency (MHz)	Data Rate (bps)	Channel	Data Rate (bps)						
		6M		9M	12M	18M	24M	36M	48M	54M
Duty Cycle (%)										
CH 149	5745	20.66	CH 157	20.61	20.61	20.51	20.51	20.56	20.56	20.56
CH 157	5785	20.71								
CH 165	5825	20.71								

802.11n HT20 RF Output Power (dBm)										
Power vs. Channel			Power vs Data Rate							
Channel	Frequency (MHz)	MCS Index	Channel	MCS Index						
		MCS0		MCS1	MCS2	MCS3	MCS4	MCS5	MCS6	MCS7
Duty Cycle (%)										
CH 149	5745	20.66	CH 149	20.56	20.41	20.41	20.51	20.51	20.56	20.56
CH 157	5785	20.56								
CH 165	5825	20.56								

802.11n HT40 RF Output Power (dBm)										
Power vs. Channel			Power vs Data Rate							
Channel	Frequency (MHz)	MCS Index	Channel	MCS Index						
		MCS0		MCS1	MCS2	MCS3	MCS4	MCS5	MCS6	MCS7
Duty Cycle (%)										
CH 151	5755	20.56	CH 159	20.56	20.51	20.46	20.56	20.56	20.56	20.56
CH 159	5795	20.66								



802.11ac VHT20 RF Output Power (dBm)												
Power vs. Channel			Power vs Data Rate									
Channel	Frequency (MHz)	MCS Index	Channel	MCS Index								
		MCS0		MCS1	MCS2	MCS3	MCS4	MCS5	MCS6	MCS7	MCS8	
Duty Cycle (%)												
CH 149	5745	20.76	CH 149									
CH 157	5785	20.66		20.66	20.51	20.51	20.61	20.61	20.66	20.66	20.66	
CH 165	5825	20.66										

802.11ac VHT40 RF Output Power (dBm)												
Power vs. Channel			Power vs Data Rate									
Channel	Frequency (MHz)	MCS Index	Channel	MCS Index								
		MCS0		MCS1	MCS2	MCS3	MCS4	MCS5	MCS6	MCS7	MCS8	MCS9
Duty Cycle (%)												
CH 151	5755	20.66	CH 159									
CH 159	5795	20.76		20.66	20.61	20.56	20.66	20.66	20.66	20.66	20.66	20.66

802.11ac VHT80 RF Output Power (dBm)												
Power vs. Channel			Power vs Data Rate									
Channel	Frequency (MHz)	MCS Index	Channel	MCS Index								
		MCS0		MCS1	MCS2	MCS3	MCS4	MCS5	MCS6	MCS7	MCS8	MCS9
Duty Cycle (%)												
CH155	5775	20.76	CH155	20.66	20.66	20.66	20.66	20.66	20.66	20.66	20.66	20.66



<TXBF Mode>

MIMO <Ant. 1+2>

802.11ac VHT20 RF Output Power (dBm)												
Power vs. Channel			Power vs Data Rate									
Channel	Frequency (MHz)	MCS Index	Channel	MCS Index								
		MCS0		MCS1	MCS2	MCS3	MCS4	MCS5	MCS6	MCS7	MCS8	
Duty Cycle (%)												
CH 149	5745	19.72	CH 165									
CH 157	5785	19.80		19.82	19.87	19.80	19.90	19.82	19.82	19.80	19.80	
CH 165	5825	19.92										

802.11ac VHT40 RF Output Power (dBm)												
Power vs. Channel			Power vs Data Rate									
Channel	Frequency (MHz)	MCS Index	Channel	MCS Index								
		MCS0		MCS1	MCS2	MCS3	MCS4	MCS5	MCS6	MCS7	MCS8	MCS9
Duty Cycle (%)												
CH 151	5755	20.25	CH 151	19.87	19.90	20.09	20.00	20.02	20.11	20.22	20.20	20.16
CH 159	5795	20.18										

802.11ac VHT80 RF Output Power (dBm)												
Power vs. Channel			Power vs Data Rate									
Channel	Frequency (MHz)	MCS Index	Channel	MCS Index								
		MCS0		MCS1	MCS2	MCS3	MCS4	MCS5	MCS6	MCS7	MCS8	MCS9
Duty Cycle (%)												
CH155	5775	20.48	CH155	20.18	20.30	20.35	20.37	20.25	20.24	20.21	20.31	20.30

2.3 Connection Diagram of Test System

<CDD Mode>

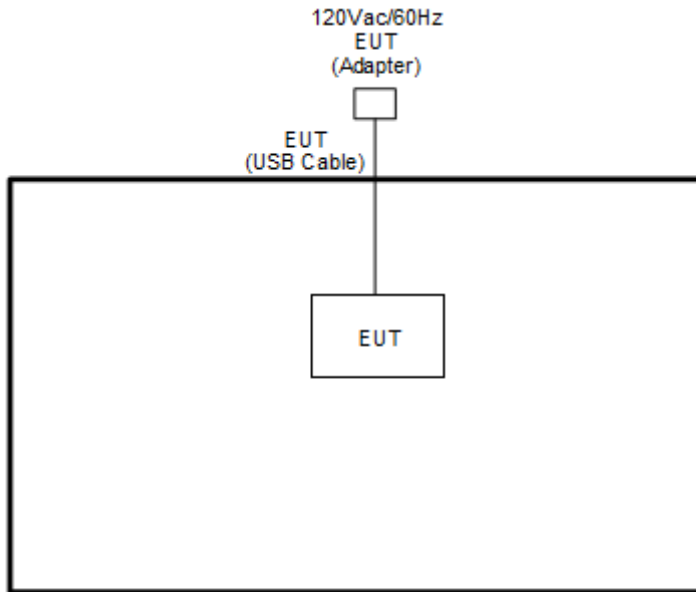

<TXBF Mode>

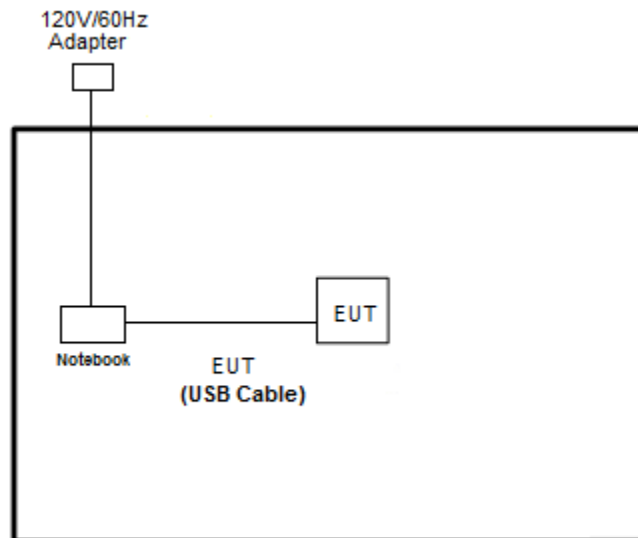

< AC Conducted Emission Mode >

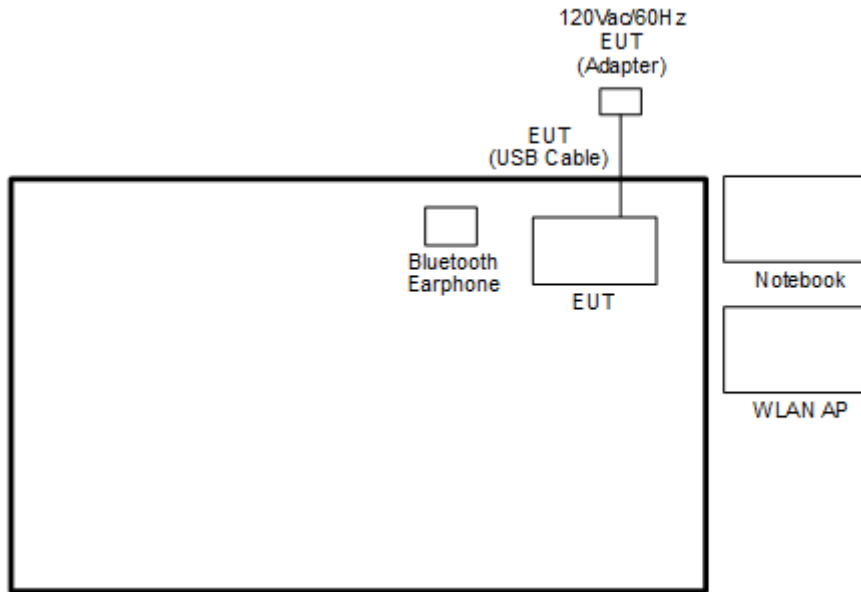

2.4 Support Unit used in test configuration and system

Item	Equipment	Trade Name	Model Name	FCC ID	Data Cable	Power Cord
1.	Bluetooth Earphone	Sony Ericsson	MW600	PY7DDA-2029	N/A	N/A
2.	WLAN AP	ASUS	RT-AC66U	MSQ-RTAC66U	N/A	Unshielded, 1.8 m
3.	Notebook	Dell	Latitude E5480	FCC DoC	N/A	AC I/P : Unshielded, 1.2m DC O/P : Shielded, 1.8m
4.	Notebook	Lenovo	G480	FCC DoC	N/A	AC I/P: Unshielded, 1.2 m DC O/P: Shielded, 1.8 m
5.	Notebook	DELL	Latitude E3340	FCC DoC/ Contains FCC ID: PD97260NGU	N/A	AC I/P: Unshielded, 1.2 m DC O/P: Shielded, 1.8 m
6.	SD Card	SanDisk	MicroSD HC	FCC DoC	N/A	N/A



2.5 EUT Operation Test Setup

The RF test items, utility “QRCT (V.3.0-00271)” was installed in Notebook which was programmed in order to make the EUT get into the engineering modes to provide channel selection, power level, data rate and the application type and for continuous transmitting signals.

For TXBF mode, the modulation modes and data rates manipulated by the command lines in the engineering program made the EUT link to another EUT by power under the normal operation. The “adb” software tool was used to enable the EUT to transmit signals continuously.

2.6 Measurement Results Explanation Example

For all conducted test items:

The offset level is set in the spectrum analyzer to compensate the RF cable loss and attenuator factor between EUT conducted output port and spectrum analyzer. With the offset compensation, the spectrum analyzer reading level is exactly the EUT RF output level.

Example :

The spectrum analyzer offset is derived from RF cable loss and attenuator factor.

Offset = RF cable loss + attenuator factor.

Following shows an offset computation example with cable loss 4.2 dB and 10dB attenuator.

$$\begin{aligned} \text{Offset(dB)} &= \text{RF cable loss(dB)} + \text{attenuator factor(dB)}. \\ &= 4.2 + 10 = 14.2 \text{ (dB)} \end{aligned}$$

3 Test Result

3.1 6dB and 26dB and 99% Occupied Bandwidth Measurement

3.1.1 Description of 6dB and 26dB and 99% Occupied Bandwidth

The minimum 6 dB bandwidth shall be at least 500 kHz.

26dB and 99% Occupied bandwidth are reporting only.

3.1.2 Measuring Instruments

See list of measuring equipment of this test report.

3.1.3 Test Procedures

1. The testing follows FCC KDB 789033 D02 General UNII Test Procedures New Rules v02r01. Section C) Emission bandwidth for the band 5.725-5.85GHz
2. Set RBW = 100kHz.
3. Set the VBW $\geq 3 \times$ RBW.
4. Detector = Peak.
5. Trace mode = max hold
6. Measure the maximum width of the emission that is 6 dB down from the peak of the emission.
7. Measure and record the results in the test report.

3.1.4 Test Setup

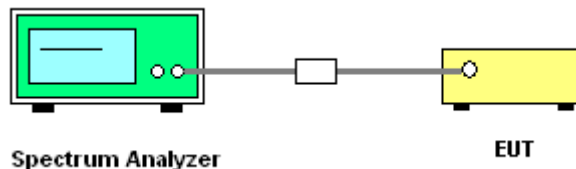



3.1.5 Test Result of 6dB and 26dB and 99% Occupied Bandwidth

Test Engineer :	Shiming Liu , Eason Huang	Temperature :	21~25°C
		Relative Humidity :	51~54%

<CDD Mode>

Band IV													
Mod.	Data Rate	NTX	CH.	Freq. (MHz)	99% Bandwidth (MHz)		26dB Bandwidth (MHz)		6 dB Bandwidth (MHz)		6 dB Bandwidth Min. Limit (MHz)	Pass/Fail	
					Ant 1	Ant 2	Ant 1	Ant 2	Ant 1	Ant 2			
11a	6Mbps	1	149	5745	16.73	16.68	24.68	24.68	15.13	15.53	0.50	Pass	
11a	6Mbps	1	157	5785	16.68	16.73	24.68	24.53	15.43	15.63	0.50	Pass	
11a	6Mbps	1	165	5825	16.73	16.73	24.63	24.83	15.28	15.49	0.50	Pass	
VHT20	MCS0	1	149	5745	17.88	17.88	25.87	25.82	16.73	16.53	0.50	Pass	
VHT20	MCS0	1	157	5785	17.88	17.93	26.32	25.77	16.78	15.29	0.50	Pass	
VHT20	MCS0	1	165	5825	17.88	17.93	24.98	25.97	16.78	15.93	0.50	Pass	
VHT40	MCS0	1	151	5755	36.46	36.46	41.72	41.72	35.07	35.25	0.50	Pass	
VHT40	MCS0	1	159	5795	36.56	36.56	41.63	41.81	35.69	35.34	0.50	Pass	
VHT80	MCS0	1	155	5775	76.24	76.24	83.76	83.76	75.12	75.12	0.50	Pass	
11a	6Mbps	2	149	5745	16.73	16.58	24.78	23.58	15.88	15.34	0.50	Pass	
11a	6Mbps	2	157	5785	16.73	16.63	24.13	24.18	15.93	15.78	0.50	Pass	
11a	6Mbps	2	165	5825	16.68	16.63	24.43	23.38	15.68	16.28	0.50	Pass	
VHT20	MCS0	2	149	5745	17.93	17.93	26.07	26.07	15.09	15.88	0.50	Pass	
VHT20	MCS0	2	157	5785	17.93	17.83	26.57	24.68	16.78	16.53	0.50	Pass	
VHT20	MCS0	2	165	5825	17.88	17.83	25.67	25.08	16.78	15.44	0.50	Pass	
VHT40	MCS0	2	151	5755	36.56	36.46	41.81	41.99	35.07	35.07	0.50	Pass	
VHT40	MCS0	2	159	5795	36.46	36.46	41.81	41.90	35.69	35.25	0.50	Pass	
VHT80	MCS0	2	155	5775	76.24	76.24	83.60	82.64	75.12	75.12	0.50	Pass	

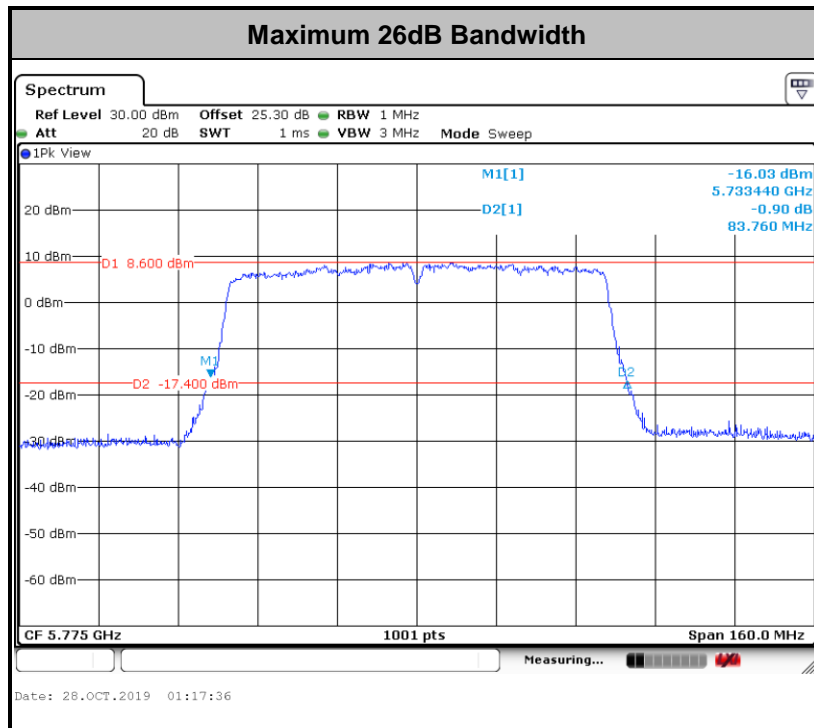
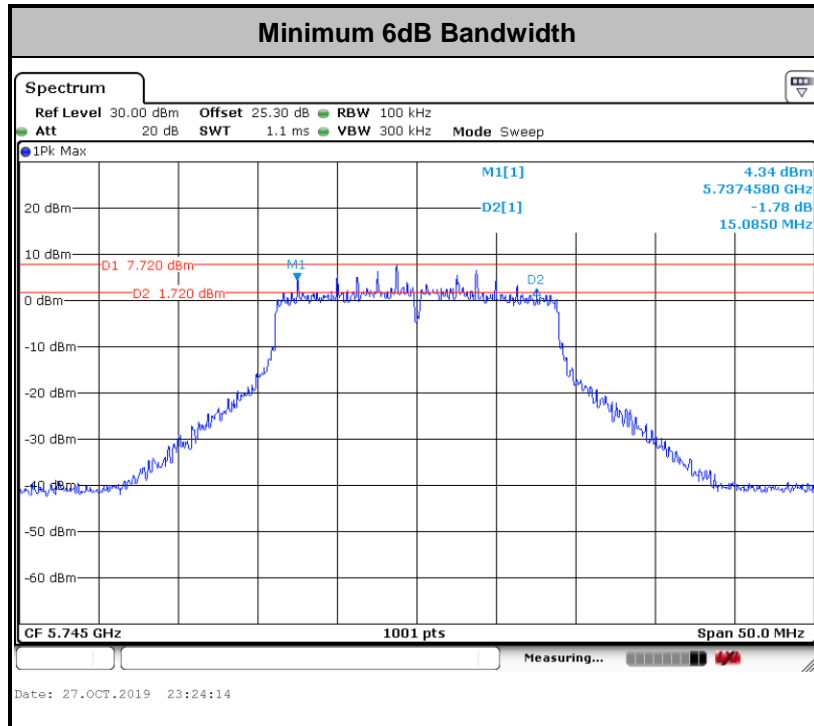

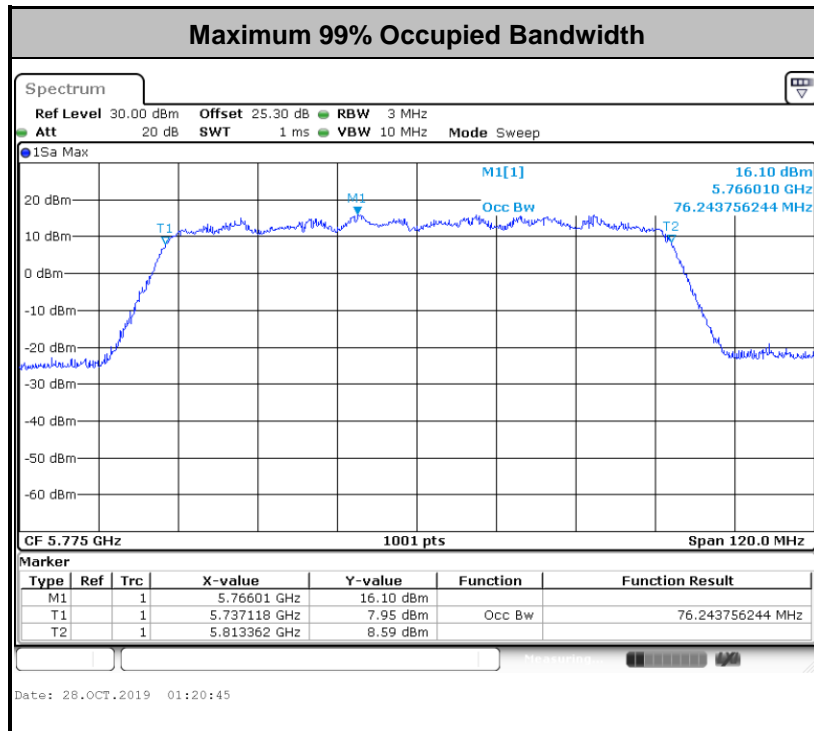

Note: The occupied channel bandwidth is maintained within the band of operation for all of the modulations.



<TXBF Mode>

Band IV												
Mod.	Data Rate	NTX	CH.	Freq. (MHz)	99% Bandwidth (MHz)		26dB Bandwidth (MHz)		6 dB Bandwidth (MHz)		6 dB Bandwidth Min. Limit (MHz)	Pass/Fail
					Ant 1	Ant 2	Ant 1	Ant 2	Ant 1	Ant 2		
VHT20	MCS0	2	149	5745	17.73	19.08	23.38	27.72	15.13	17.63	0.50	Pass
VHT20	MCS0	2	157	5785	17.68	19.18	23.43	28.07	14.99	17.53	0.50	Pass
VHT20	MCS0	2	165	5825	17.73	18.98	23.73	28.12	15.13	17.63	0.50	Pass
VHT40	MCS0	2	151	5755	36.66	36.56	41.09	42.62	35.06	36.23	0.50	Pass
VHT40	MCS0	2	159	5795	36.86	36.56	41.36	42.71	35.69	36.23	0.50	Pass
VHT80	MCS0	2	155	5775	76.48	76.60	82.16	84.08	75.13	75.13	0.50	Pass

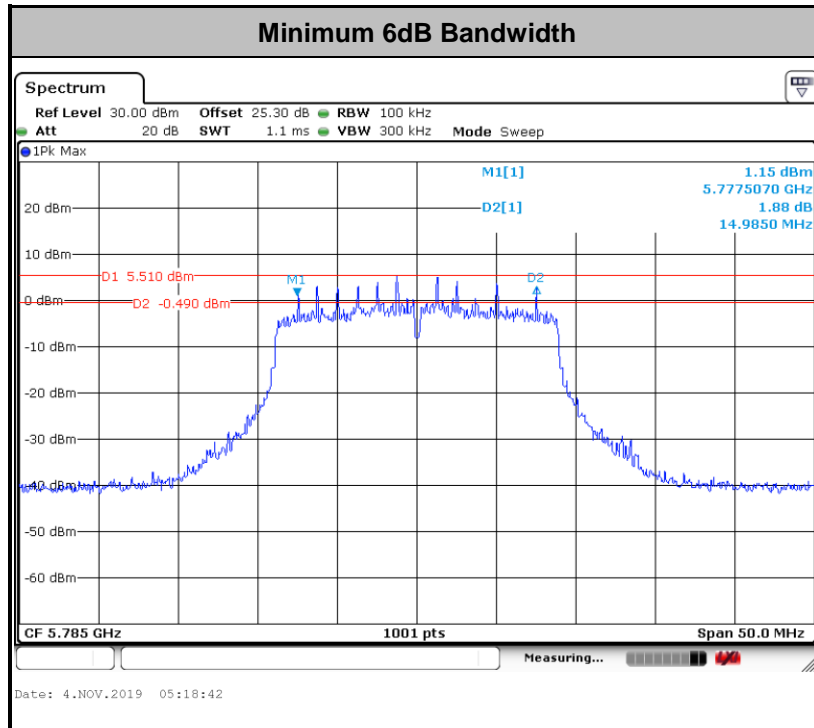

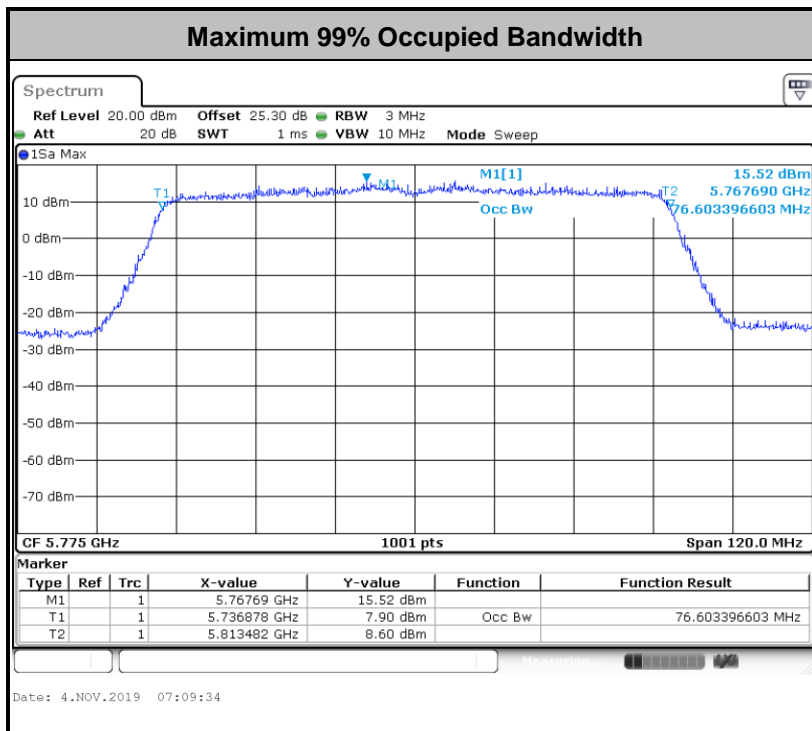
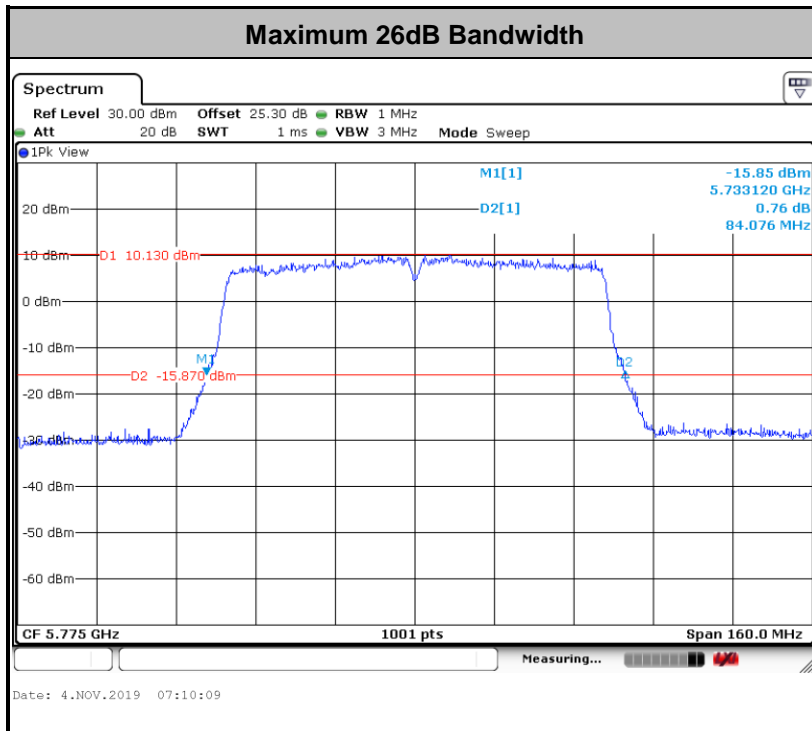

Note: The occupied channel bandwidth is maintained within the band of operation for all of the modulations.

3.2 Maximum Conducted Output Power Measurement

3.2.1 Limit of Maximum Conducted Output Power

For the band 5.725–5.85 GHz, the maximum conducted output power over the frequency band of operation shall not exceed 1 W.

If transmitting antennas of directional gain greater than 6 dBi are used, the peak output power shall be reduced by the amount in dB that the directional gain of the antenna exceeds 6 dBi.

3.2.2 Measuring Instruments

See list of measuring equipment of this test report.

3.2.3 Test Procedures

The testing follows Method PM-G of FCC KDB 789033 D02 General UNII Test Procedures New Rules v02r01.

Method PM-G (Measurement using a gated RF average power meter):

1. Measurement is performed using a wideband RF power meter.
2. The EUT is configured to transmit at its maximum power control level.
3. Measure the average power of the transmitter

Since the measurement is made only during the ON time of the transmitter, no duty cycle correction factor is required.

3.2.4 Test Setup

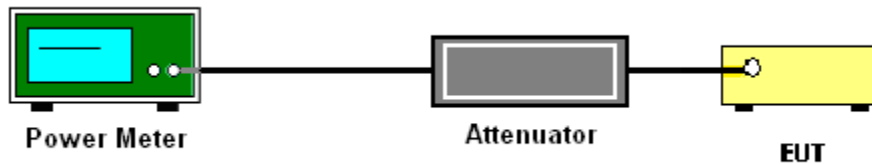



3.2.5 Test Result of Maximum Conducted Output Power

Test Engineer :	Shiming Liu , Eason Huang	Temperature :	21~25°C
		Relative Humidity :	51~54%

<CDD Mode>

Band IV												
Mod.	Data Rate	NTX	CH.	Freq. (MHz)	Average Conducted Power (dBm)			FCC Conducted Power Limit (dBm)		DG (dBi)		Pass/Fail
					Ant 1	Ant 2	SUM	Ant 1	Ant 2	Ant 1	Ant 2	
11a	6Mbps	1	149	5745	17.90	17.60		30.00	30.00	4.01	4.32	Pass
11a	6Mbps	1	157	5785	17.80	17.80		30.00	30.00	4.01	4.32	Pass
11a	6Mbps	1	165	5825	17.80	17.70		30.00	30.00	4.01	4.32	Pass
HT20	MCS0	1	149	5745	17.60	17.70		30.00	30.00	4.01	4.32	Pass
HT20	MCS0	1	157	5785	17.60	17.70		30.00	30.00	4.01	4.32	Pass
HT20	MCS0	1	165	5825	17.70	17.80		30.00	30.00	4.01	4.32	Pass
HT40	MCS0	1	151	5755	17.70	17.50		30.00	30.00	4.01	4.32	Pass
HT40	MCS0	1	159	5795	17.80	17.70		30.00	30.00	4.01	4.32	Pass
VHT20	MCS0	1	149	5745	17.70	17.80		30.00	30.00	4.01	4.32	Pass
VHT20	MCS0	1	157	5785	17.70	17.80		30.00	30.00	4.01	4.32	Pass
VHT20	MCS0	1	165	5825	17.80	17.90		30.00	30.00	4.01	4.32	Pass
VHT40	MCS0	1	151	5755	17.80	17.60		30.00	30.00	4.01	4.32	Pass
VHT40	MCS0	1	159	5795	17.90	17.80		30.00	30.00	4.01	4.32	Pass
VHT80	MCS0	1	155	5775	17.90	17.90		30.00	30.00	4.01	4.32	Pass
11a	6Mbps	2	149	5745	17.60	17.70	20.66	30.00		4.32		Pass
11a	6Mbps	2	157	5785	17.60	17.80	20.71	30.00		4.32		Pass
11a	6Mbps	2	165	5825	17.60	17.80	20.71	30.00		4.32		Pass
HT20	MCS0	2	149	5745	17.50	17.80	20.66	30.00		4.32		Pass
HT20	MCS0	2	157	5785	17.50	17.60	20.56	30.00		4.32		Pass
HT20	MCS0	2	165	5825	17.50	17.60	20.56	30.00		4.32		Pass
HT40	MCS0	2	151	5755	17.50	17.60	20.56	30.00		4.32		Pass
HT40	MCS0	2	159	5795	17.50	17.80	20.66	30.00		4.32		Pass
VHT20	MCS0	2	149	5745	17.60	17.90	20.76	30.00		4.32		Pass
VHT20	MCS0	2	157	5785	17.60	17.70	20.66	30.00		4.32		Pass
VHT20	MCS0	2	165	5825	17.60	17.70	20.66	30.00		4.32		Pass
VHT40	MCS0	2	151	5755	17.60	17.70	20.66	30.00		4.32		Pass
VHT40	MCS0	2	159	5795	17.60	17.90	20.76	30.00		4.32		Pass
VHT80	MCS0	2	155	5775	17.60	17.90	20.76	30.00		4.32		Pass



<TXBF Mode>

Band IV												
Mod.	Data Rate	NTX	CH.	Freq. (MHz)	Average Conducted Power (dBm)			FCC Conducted Power Limit (dBm)		DG (dBi)		Pass/Fail
					Ant 1	Ant 2	SUM	Ant 1	Ant 2	Ant 1	Ant 2	
VHT20	MCS0	2	149	5745	15.60	17.60	19.72	28.82	28.82	7.18	7.18	Pass
VHT20	MCS0	2	157	5785	15.80	17.60	19.80	28.82	28.82	7.18	7.18	Pass
VHT20	MCS0	2	165	5825	15.80	17.80	19.92	28.82	28.82	7.18	7.18	Pass
VHT40	MCS0	2	151	5755	16.60	17.80	20.25	28.82	28.82	7.18	7.18	Pass
VHT40	MCS0	2	159	5795	16.30	17.90	20.18	28.82	28.82	7.18	7.18	Pass
VHT80	MCS0	2	155	5775	17.00	17.90	20.48	28.82	28.82	7.18	7.18	Pass



3.3 Power Spectral Density Measurement

3.3.1 Limit of Power Spectral Density

For the band 5.725–5.85 GHz, the maximum power spectral density shall not exceed 30 dBm in any 500-kHz band.

If transmitting antennas of directional gain greater than 6 dBi are used, the peak output power shall be reduced by the amount in dB that the directional gain of the antenna exceeds 6 dBi.

3.3.2 Measuring Instruments

See list of measuring equipment of this test report.

3.3.3 Test Procedures

The testing follows FCC KDB 789033 D02 General UNII Test Procedures New Rules v02r01. Section F) Maximum power spectral density.

<CDD Modes>

Method SA-2

(trace averaging across on and off times of the EUT transmissions, followed by duty cycle correction).

- Measure the duty cycle.
- Set span to encompass the entire emission bandwidth (EBW) of the signal.
- Set RBW = 300 kHz.
- Set VBW \geq 1 MHz.
- Number of points in sweep \geq 2 Span / RBW.
- Sweep time = auto.
- Detector = RMS
- Trace average at least 100 traces in power averaging mode.
- Add $10 \log(500\text{kHz}/\text{RBW})$ to the test result.
- Add $10 \log(1/x)$, where x is the duty cycle, to the measured power in order to compute the average power during the actual transmission times. For example, add $10 \log(1/0.25) = 6$ dB if the duty cycle is 25 percent.

<TXBF Modes>**# Method SA-3 #**

(power averaging (rms) detection with max hold):

- Set span to encompass the entire emission bandwidth (EBW) of the signal.
 - Set RBW = 300 kHz.
 - Set VBW \geq 1 MHz.
 - Number of points in sweep \geq 2 Span / RBW.
 - Sweep time \leq (number of points in sweep) \times T, when duty cycle is less than 98 percent where T is the minimum transmission duration over which the transmitter is on and is transmitting at its maximum power control level for the tested mode of operation.
 - Detector = power averaging (rms).
 - Trace mode = max hold.
 - Allow max hold to run for at least 60 seconds, or longer as needed to allow the trace to stabilize.
1. The RF output of EUT was connected to the spectrum analyzer by a low loss cable.
 2. Each plot has already offset with cable loss, and attenuator loss. Measure the PPSD and record it.
 3. For MIMO mode, calculation method follows FCC KDB 662911 D01 Multiple Transmitter Output v02r01.

Method (c): Measure and add $10 \log(N_{ANT})$ dB.

With this technique, spectrum measurements are performed at each output of the device, but rather than summing the spectra or the spectral peaks across the outputs, the quantity $10 \log(N_{ANT})$ dB is added to each spectrum value before comparing to the emission limit. The addition of $10 \log(N_{ANT})$ dB serves to apportion the emission limit among the N_{ANT} outputs so that each output is permitted to contribute no more than $1/N_{ANT}^{th}$ of the PSD limit.

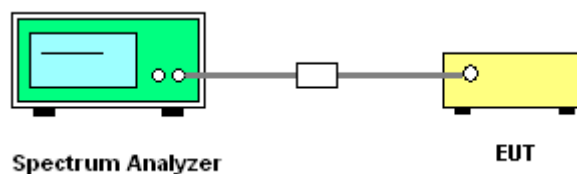
3.3.4 Test Setup



3.3.5 Test Result of Power Spectral Density

Test Engineer :	Shiming Liu , Eason Huang	Temperature :	21~25°C
		Relative Humidity :	51~54%

<CDD Mode>

Band IV																
Mod.	Data Rate	NTX	CH.	Freq. (MHz)	Duty Factor (dB)		10log (500kHz /RBW) Factor (dB)		Average Power Density (dBm/500kHz)			Average PSD Limit (dBm/500kHz)		DG (dBi)		Pass /Fail
					Ant 1	Ant 2	Ant 1	Ant 2	Ant 1	Ant 2	SUM	Ant 1	Ant 2	Ant 1	Ant 2	
11a	6Mbps	1	149	5745	0.19	0.19	2.22	2.22	3.75	3.59		30.00	30.00	4.01	4.32	Pass
11a	6Mbps	1	157	5785	0.19	0.19	2.22	2.22	3.78	3.54		30.00	30.00	4.01	4.32	Pass
11a	6Mbps	1	165	5825	0.19	0.19	2.22	2.22	3.84	3.63		30.00	30.00	4.01	4.32	Pass
VHT20	MCS0	1	149	5745	0.20	0.18	2.22	2.22	3.60	3.68		30.00	30.00	4.01	4.32	Pass
VHT20	MCS0	1	157	5785	0.20	0.18	2.22	2.22	3.48	3.64	-	30.00	30.00	4.01	4.32	Pass
VHT20	MCS0	1	165	5825	0.20	0.18	2.22	2.22	3.39	3.71		30.00	30.00	4.01	4.32	Pass
VHT40	MCS0	1	151	5755	0.39	0.40	2.22	2.22	0.36	0.22		30.00	30.00	4.01	4.32	Pass
VHT40	MCS0	1	159	5795	0.39	0.40	2.22	2.22	0.63	0.42		30.00	30.00	4.01	4.32	Pass
VHT80	MCS0	1	155	5775	0.69	0.67	2.22	2.22	-2.49	-2.38		30.00	30.00	4.01	4.32	Pass
11a	6Mbps	2	149	5745	0.20	0.18	2.22	2.22	3.42	3.51	6.52	28.82	28.82	7.18	7.18	Pass
11a	6Mbps	2	157	5785	0.20	0.18	2.22	2.22	3.60	3.68	6.69	28.82	28.82	7.18	7.18	Pass
11a	6Mbps	2	165	5825	0.20	0.18	2.22	2.22	3.58	3.87	6.88	28.82	28.82	7.18	7.18	Pass
VHT20	MCS0	2	149	5745	0.21	0.20	2.22	2.22	3.19	3.70	6.71	28.82	28.82	7.18	7.18	Pass
VHT20	MCS0	2	157	5785	0.21	0.20	2.22	2.22	3.23	3.29	6.30	28.82	28.82	7.18	7.18	Pass
VHT20	MCS0	2	165	5825	0.21	0.20	2.22	2.22	3.46	3.41	6.47	28.82	28.82	7.18	7.18	Pass
VHT40	MCS0	2	151	5755	0.38	0.40	2.22	2.22	-0.06	0.41	3.42	28.82	28.82	7.18	7.18	Pass
VHT40	MCS0	2	159	5795	0.38	0.40	2.22	2.22	0.34	0.47	3.48	28.82	28.82	7.18	7.18	Pass
VHT80	MCS0	2	155	5775	0.69	0.69	2.22	2.22	-2.25	-2.06	0.95	28.82	28.82	7.18	7.18	Pass

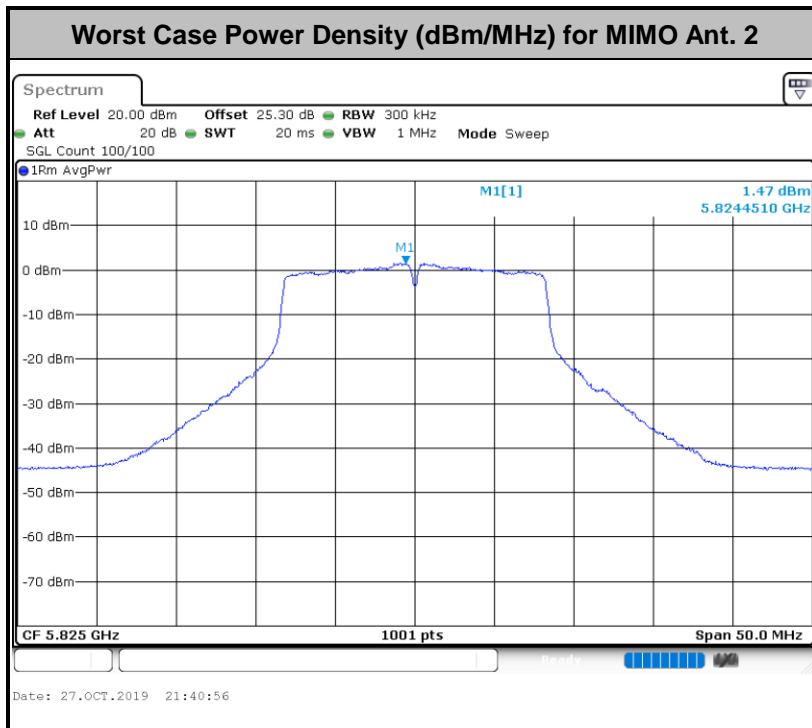
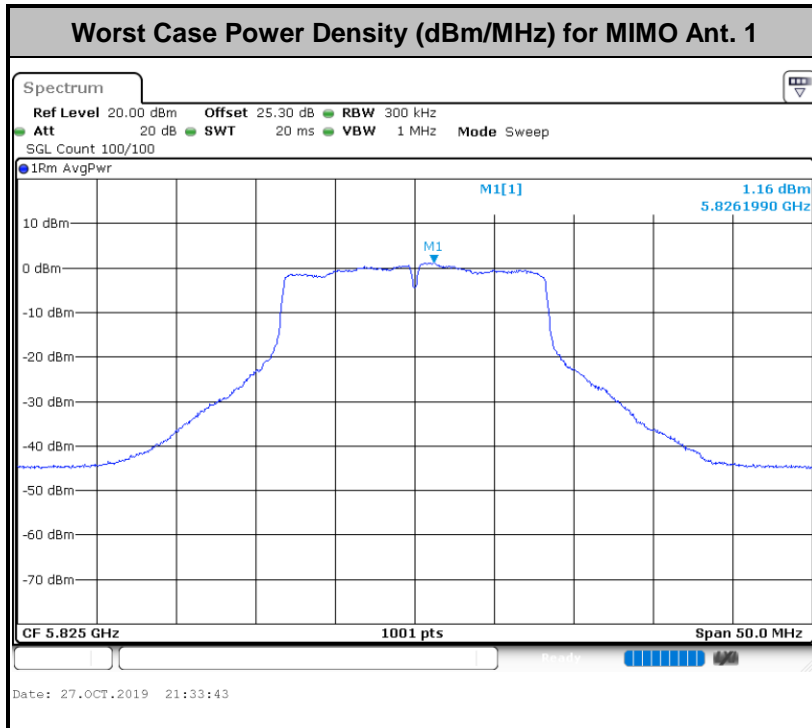



<TXBF Mode>

Band IV																
Mod.	Data Rate	NTX	CH.	Freq. (MHz)	Duty Factor (dB)		10log (500kHz /RBW) Factor (dB)		Average Power Density (dBm/500kHz)			Average PSD Limit (dBm/500kHz)		DG (dBi)		Pass /Fail
					Ant 1	Ant 2	Ant 1	Ant 2	Ant 1	Ant 2	SUM	Ant 1	Ant 2	Ant 1	Ant 2	
VHT20	MCS0	2	149	5745	0.00	0.00	2.22	5.28	7.13	10.14	28.82	7.18	Pass			
VHT20	MCS0	2	157	5785	0.00	0.00	2.22	5.16	6.80	9.81	28.82	7.18	Pass			
VHT20	MCS0	2	165	5825	0.00	0.00	2.22	5.21	6.98	9.99	28.82	7.18	Pass			
VHT40	MCS0	2	151	5755	0.00	0.00	2.22	2.86	4.17	7.18	28.82	7.18	Pass			
VHT40	MCS0	2	159	5795	0.00	0.00	2.22	2.60	3.69	6.70	28.82	7.18	Pass			
VHT80	MCS6	2	155	5775	0.00	0.00	2.22	2.18	2.80	5.81	28.82	7.18	Pass			

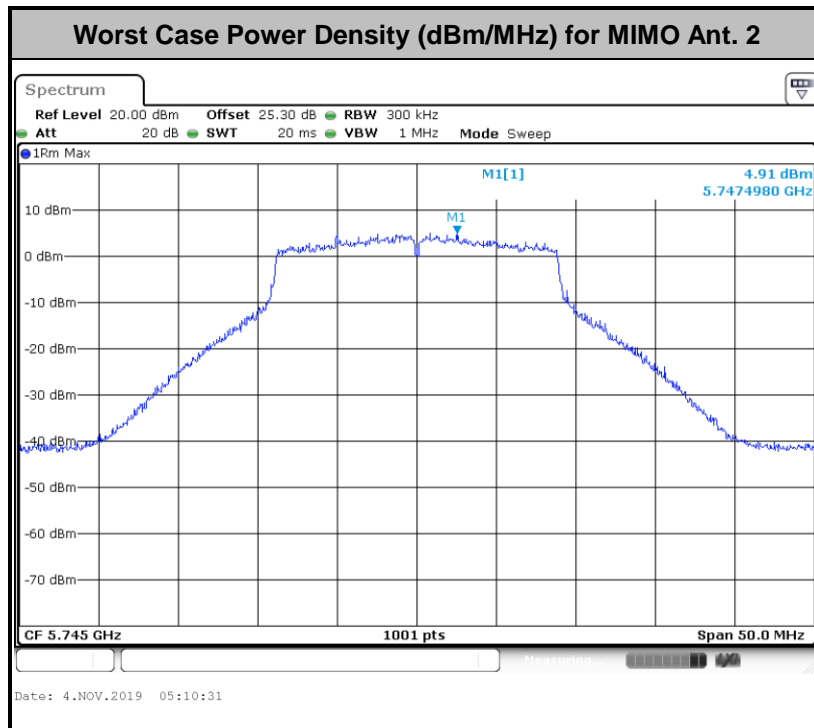
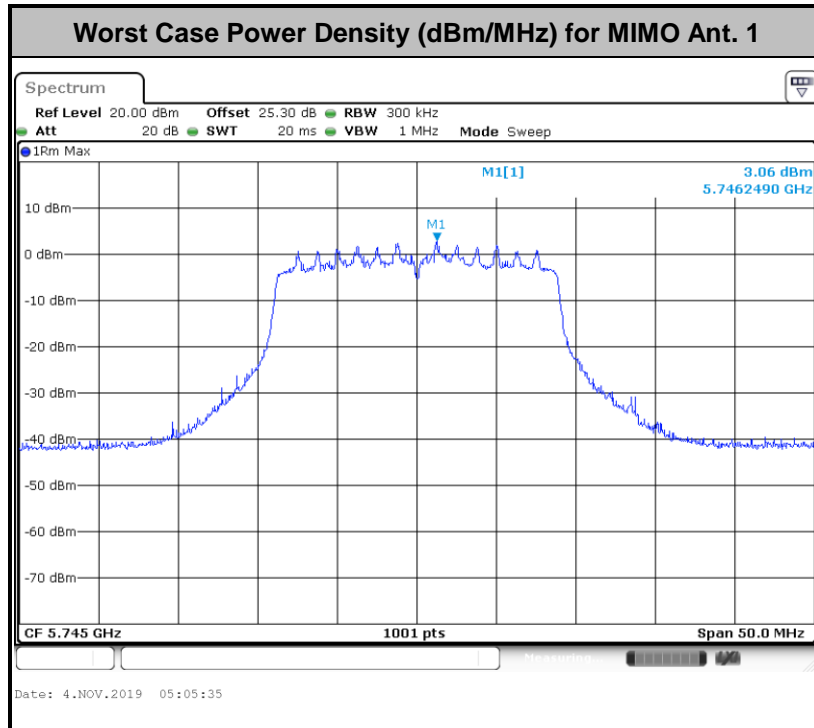



3.4 Unwanted Emissions Measurement

This section is to measure unwanted emissions through radiated measurement for band edge spurious emissions and out of band emissions measurement.

3.4.1 Limit of Unwanted Emissions

(1) For transmitters operating in the 5.725-5.85 GHz band:

15.407(b)(4)(i) All emissions shall be limited to a level of -27 dBm/MHz at 75 MHz or more above or below the band edge increasing linearly to 10 dBm/MHz at 25 MHz above or below the band edge, and from 25 MHz above or below the band edge increasing linearly to a level of 15.6 dBm/MHz at 5 MHz above or below the band edge, and from 5 MHz above or below the band edge increasing linearly to a level of 27 dBm/MHz at the band edge.

(2) Unwanted spurious emissions fallen in restricted bands shall comply with the general field strength limits as below table,

Frequency (MHz)	Field Strength (microvolts/meter)	Measurement Distance (meters)
0.009 – 0.490	2400/F(kHz)	300
0.490 – 1.705	24000/F(kHz)	30
1.705 – 30.0	30	30
30 – 88	100	3
88 – 216	150	3
216 - 960	200	3
Above 960	500	3

Note: The following formula is used to convert the EIRP to field strength.

$$E = \frac{1000000\sqrt{30P}}{3} \mu V/m, \text{ where } P \text{ is the eirp (Watts)}$$



EIRP (dBm)	Field Strength at 3m (dBμV/m)
- 27	68.3

(3) KDB789033 D02 v02r01 G)2)c)

- (i) Sections 15.407(b)(1-3) specifies the unwanted emissions limit for the U-NII-1 and U-NII-2 bands. As specified, emissions above 1000 MHz that are outside of the restricted bands are subject to a peak emission limit of -27 dBm/MHz.
- (ii) Section 15.407(b)(4) specifies the unwanted emissions limit for the U-NII-3 band. A band emissions mask is specified in Section 15.407(b)(4)(i). The emission limits are based on the use of a peak detector.

3.4.2 Measuring Instruments

See list of measuring equipment of this test report.

3.4.3 Test Procedures

1. The testing follows FCC KDB 789033 D02 General UNII Test Procedures New Rules v02r01. Section G) Unwanted emissions measurement.

(1) Procedure for Unwanted Emissions Measurements Below 1000MHz

- RBW = 120 kHz
- VBW = 300 kHz
- Detector = Peak
- Trace mode = max hold

(2) Procedure for Peak Unwanted Emissions Measurements Above 1000 MHz

- RBW = 1 MHz
- VBW ≥ 3 MHz
- Detector = Peak
- Sweep time = auto
- Trace mode = max hold

(3) Procedures for Average Unwanted Emissions Measurements Above 1000MHz

- RBW = 1 MHz
- VBW = 10 Hz, when duty cycle is no less than 98 percent.
- VBW ≥ 1/T, when duty cycle is less than 98 percent where T is the minimum transmission duration over which the transmitter is on and is transmitting at its maximum power control level for the tested mode of operation.



2. The EUT was placed on a turntable with 0.8 meter for frequency below 1GHz and 1.5 meter for frequency above 1GHz respectively above ground.
3. The EUT was set 3 meters from the interference receiving antenna which was mounted on the top of a variable height antenna tower.
4. The antenna is a broadband antenna and its height is adjusted between one meter and four meters above ground to find the maximum value of the field strength for both horizontal polarization and vertical polarization of the antenna.
5. For each suspected emission, the EUT was arranged to its worst case and then adjust the antenna tower (from 1 m to 4 m) and turntable (from 0 degree to 360 degrees) to find the maximum reading.
6. For testing below 1GHz, if the emission level of the EUT in peak mode was 3 dB lower than the limit specified, then peak values of EUT will be reported, otherwise, the emissions will be repeated one by one using the CISPR quasi-peak method and reported.
7. For testing above 1GHz, the emission level of the EUT in peak mode was 20dB lower than average limit (that means the emission level in average mode also complies with the limit in average mode), then peak values of EUT will be reported, otherwise, the emissions will be measured in average mode again and reported.

3.4.4 Test Setup

For radiated emissions below 30MHz

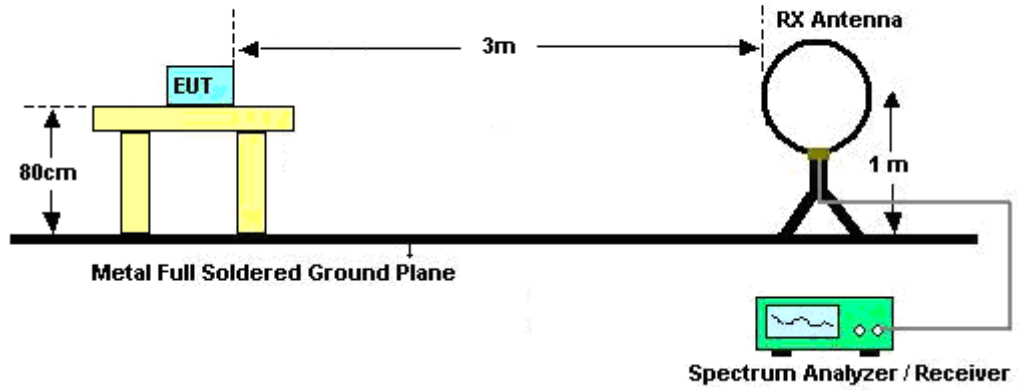

For radiated emissions from 30MHz to 1GHz

<CDD Mode>

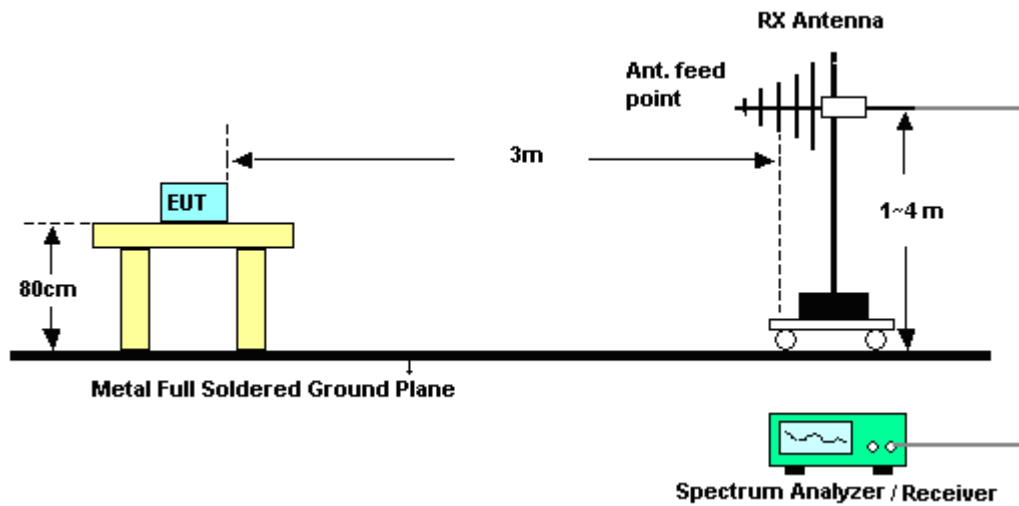

<TXBF Modes>

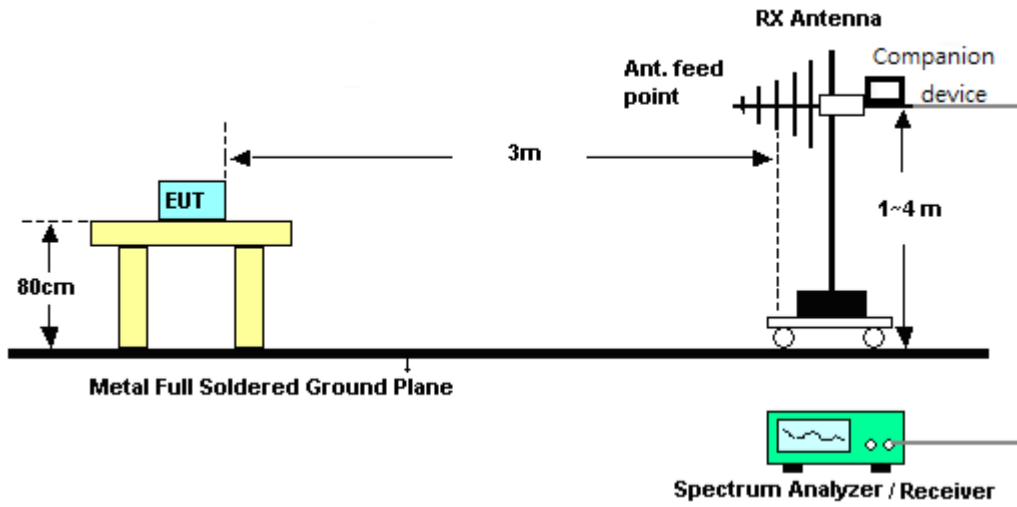

For radiated emissions above 1GHz

<CDD Mode>

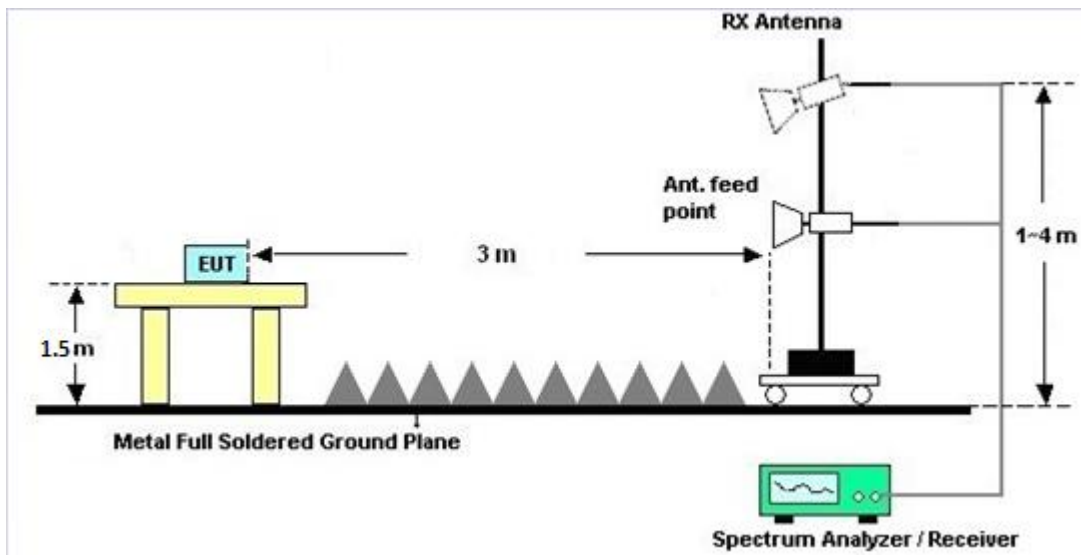

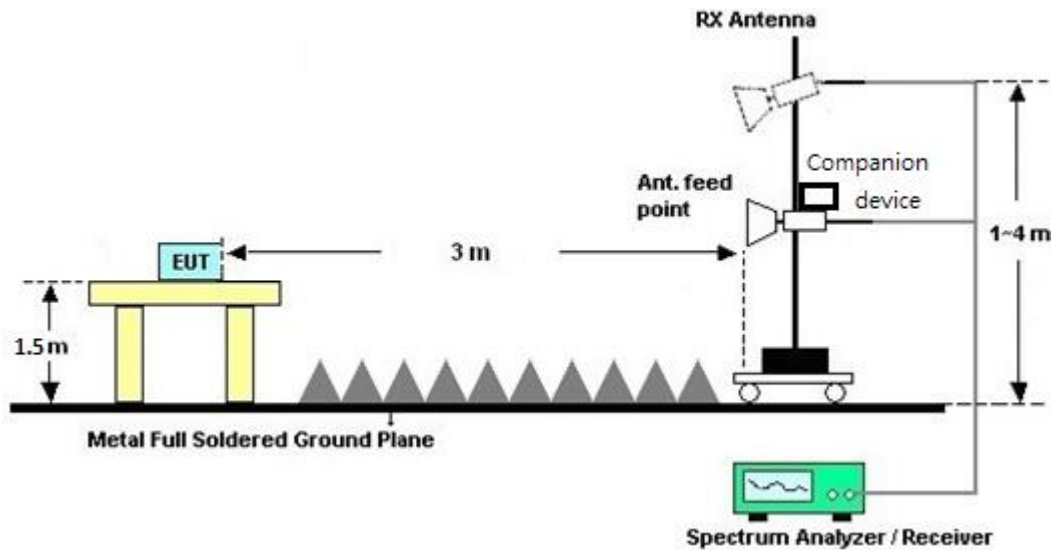
<TXBF Modes>**3.4.5 Test Results of Radiated Emissions (9 kHz ~ 30 MHz)**

The low frequency, which started from 9 kHz to 30MHz, was pre-scanned and the result which was 20dB lower than the limit line was not reported.

There is a comparison data of both open-field test site and alternative test site - semi-Anechoic chamber according to 414788 D01 Radiated Test Site v01r01, and the result came out very similar.

3.4.6 Test Result of Radiated Band Edges

Please refer to Appendix B and C.

3.4.7 Duty Cycle

Please refer to Appendix D.

3.4.8 Test Result of Unwanted Radiated Emission (30MHz ~ 10th Harmonic)

Please refer to Appendix B and C..



3.5 AC Conducted Emission Measurement

3.5.1 Limit of AC Conducted Emission

For equipment that is designed to be connected to the public utility (AC) power line, the radio frequency voltage that is conducted back onto the AC power line on any frequency or frequencies within the band 150 kHz to 30 MHz shall not exceed the limits in the following table.

Frequency of emission (MHz)	Conducted limit (dB μ V)	
	Quasi-peak	Average
0.15-0.5	66 to 56*	56 to 46*
0.5-5	56	46
5-30	60	50

*Decreases with the logarithm of the frequency.

3.5.2 Measuring Instruments

See list of measuring equipment of this test report.

3.5.3 Test Procedures

1. The EUT was placed 0.4 meter from the conducting wall of the shielding room was kept at least 80 centimeters from any other grounded conducting surface.
2. Connect EUT to the power mains through a line impedance stabilization network (LISN).
3. All the support units are connecting to the other LISN.
4. The LISN provides 50 ohm coupling impedance for the measuring instrument.
5. The FCC states that a 50 ohm, 50 microhenry LISN should be used.
6. Both sides of AC line were checked for maximum conducted interference.
7. The frequency range from 150 kHz to 30 MHz was searched.
8. Set the test-receiver system to Peak Detect Function and specified bandwidth with Maximum Hold Mode.

3.5.4 Test Setup

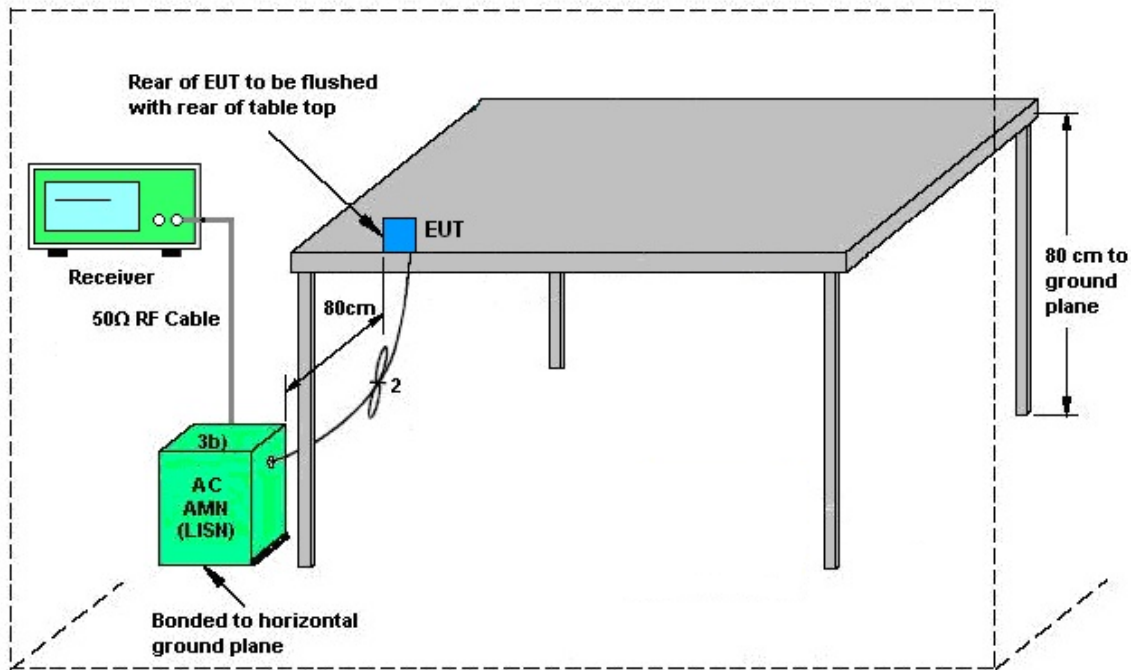

AMN = Artificial mains network (LISN)
 AE = Associated equipment
 EUT = Equipment under test
 ISN = Impedance stabilization network

3.5.5 Test Result of AC Conducted Emission

Please refer to Appendix A.



3.6 Automatically Discontinue Transmission

3.6.1 Limit of Automatically Discontinue Transmission

The device shall automatically discontinue transmission in case of either absence of information to transmit or operational failure. These provisions are not intended to preclude the transmission of control or signaling information or the use of repetitive codes used by certain digital technologies to complete frame or burst intervals. Applicants shall include in their application for equipment authorization to describe how this requirement is met.

3.6.2 Measuring Instruments

See list of measuring equipment of this test report.

3.6.3 Test Result of Automatically Discontinue Transmission

While the EUT is not transmitting any information, the EUT can automatically discontinue transmission and become standby mode for power saving. The EUT can detect the controlling signal of ACK message transmitting from remote device and verify whether it shall resend or discontinue transmission.



3.7 Antenna Requirements

3.7.1 Standard Applicable

If transmitting antenna directional gain is greater than 6 dBi, both the peak transmit power and the peak power spectral density shall be reduced by the amount in dB that the directional gain of the antenna exceeds 6 dBi.

3.7.2 Antenna Anti-Replacement Construction

An embedded-in antenna design is used.

3.7.3 Antenna Gain

<CDD Modes >

FCC KDB 662911 D01 Multiple Transmitter Output v02r01

For CDD transmissions, directional gain is calculated as

Directional gain = GANT + Array Gain, where Array Gain is as follows.

For power spectral density (PSD) measurements on all devices,

Array Gain = 10 log(NANT/NSS=1) dB.

For power measurements on IEEE 802.11 devices,

Array Gain = 0 dB (i.e., no array gain) for NANT ≤ 4.

Directional gain may be calculated by using the formulas applicable to equal gain antennas with GANT set equal to the gain of the antenna having the highest gain;

The EUT supports CDD mode.

For power, the directional gain GANT is set equal to the antenna having the highest gain, i.e., F)2)f)i).

For PSD, the directional gain calculation is following F)2)f)ii) of KDB 662911 D01 v02r01.

The power and PSD limit should be modified if the directional gain of EUT is over 6 dBi,

The directional gain "DG" is calculated as following table.

<CDD Modes>						
			DG	DG	Power	PSD
	Ant. 1	Ant. 2	for	for	Limit	Limit
	(dBi)	(dBi)	Power	PSD	Reduction	Reduction
			(dBi)	(dBi)	(dB)	(dB)
Band IV	4.01	4.32	4.32	7.18	0.00	1.18

Power Limit Reduction = DG(Power) – 6dBi, (min = 0)

PSD Limit Reduction = DG(PSD) – 6dBi, (min = 0)

TXBF modes

FCC KDB 662911 D01 Multiple Transmitter Output v02r01

For CDD transmissions, directional gain is calculated as

$$DirectionalGain = 10 \cdot \log \left[\frac{\sum_{j=1}^{N_{SS}} \left\{ \sum_{k=1}^{N_{ANT}} g_{j,k} \right\}^2}{N_{ANT}} \right]$$

where

Each antenna is driven by no more than one spatial stream;

N_{SS} = the number of independent spatial streams of data;

N_{ANT} = the total number of antennas

$g_{j,k} = 10^{G_k / 20}$ if the k th antenna is being fed by spatial stream j , or zero if it is not;
 G_k is the gain in dBi of the k th antenna.

The EUT supports beamforming for 802.11ac modes.

The directional gain calculation is following F)2)e)ii) of KDB 662911 D01 v02r01.

The power and PSD limit should be modified if the directional gain of EUT is over 6 dBi,

The directional gain “DG” is calculated as following table.

			DG	DG	Power	PSD
			for	for	Limit	Limit
	Ant 1	Ant 2	Power	PSD	Reduction	Reduction
	(dBi)	(dBi)	(dBi)	(dBi)	(dB)	(dB)
Band IV	4.01	4.32	7.18	7.18	1.18	1.18

$Power\ Limit\ Reduction = DG(Power) - 6dBi, (min = 0)$

$PSD\ Limit\ Reduction = DG(PSD) - 6dBi, (min = 0)$



4 List of Measuring Equipment

Instrument	Manufacturer	Model No.	Serial No.	Characteristics	Calibration Date	Test Date	Due Date	Remark
AC Power Source	ChainTek	APC-1000W	N/A	N/A	N/A	Sep. 23, 2019	N/A	Conduction (CO05-HY)
EMI Test Receiver	Rohde & Schwarz	ESR3	102388	9kHz~3.6GHz	Nov. 12, 2018	Sep. 23, 2019	Nov. 11, 2019	Conduction (CO05-HY)
LISN	Rohde & Schwarz	ENV216	100080	9kHz~30MHz	Nov. 14, 2018	Sep. 23, 2019	Nov. 13, 2019	Conduction (CO05-HY)
LISN	Rohde & Schwarz	ENV216	100081	9kHz~30MHz	Nov. 09, 2018	Sep. 23, 2019	Nov. 08, 2019	Conduction (CO05-HY)
Software	Rohde & Schwarz	EMC32 V10.30	N/A	N/A	N/A	Sep. 23, 2019	N/A	Conduction (CO05-HY)
LF Cable	HUBER + SUHNER	RG-214/U	LF01	N/A	Dec. 31, 2018	Sep. 23, 2019	Dec. 30, 2019	Conduction (CO05-HY)
Pulse Limiter	Rohde & Schwarz	ESH3-Z2	100851	N/A	Dec. 31, 2018	Sep. 23, 2019	Dec. 30, 2019	Conduction (CO05-HY)
Preamplifier	EMEC	EM18G40G	060715	18GHz ~ 40GHz	Dec. 06, 2018	Sep. 24, 2019~ Nov. 02, 2019	Dec. 05, 2019	Radiation (03CH11-HY)
Amplifier	SONOMA	310N	187312	9kHz~1GHz	Dec. 04, 2018	Sep. 24, 2019~ Nov. 02, 2019	Dec. 03, 2019	Radiation (03CH11-HY)
Bilog Antenna	TESEQ	CBL 6111D & 00800N1D01 N-06	41912 & 05	30MHz~1GHz	Feb. 12, 2019	Sep. 24, 2019~ Nov. 02, 2019	Feb. 11, 2020	Radiation (03CH11-HY)
Horn Antenna	SCHWARZBECK	BBHA 9120 D	9120D-152 2	1GHz ~ 18GHz	Sep. 19, 2019	Sep. 24, 2019~ Nov. 02, 2019	Sep. 18, 2020	Radiation (03CH11-HY)
Loop Antenna	Rohde & Schwarz	HFH2-Z2	100488	9 kHz~30 MHz	Nov. 22, 2018	Sep. 24, 2019~ Nov. 02, 2019	Nov. 21, 2019	Radiation (03CH11-HY)
Preamplifier	Keysight	83017A	MY532700 80	1GHz~26.5GHz	Nov. 14, 2018	Sep. 24, 2019~ Nov. 02, 2019	Nov. 13, 2020	Radiation (03CH11-HY)
Spectrum Analyzer	Keysight	N9010A	MY534701 18	10Hz ~ 44GHz	Apr. 18, 2019	Sep. 24, 2019~ Nov. 02, 2019	Apr. 17, 2020	Radiation (03CH11-HY)
Antenna Mast	EMEC	AM-BS-4500-B	N/A	1~4m	N/A	Sep. 24, 2019~ Nov. 02, 2019	N/A	Radiation (03CH11-HY)
Turn Table	EMEC	TT 2000	N/A	0~360 Degree	N/A	Sep. 24, 2019~ Nov. 02, 2019	N/A	Radiation (03CH11-HY)
Preamplifier	Jet-Power	JPA00101800 -30-10P	160118000 2	1GHz~18GHz	Aug. 01, 2019	Sep. 24, 2019~ Nov. 02, 2019	Jul. 31, 2020	Radiation (03CH11-HY)
Preamplifier	Jet-Power	JAP00101800 -30-10P	160118550 004	1GHz~18GHz	Sep. 27, 2019	Sep. 24, 2019~ Nov. 02, 2019	Sep. 26, 2020	Radiation (03CH11-HY)
SHF-EHF Horn Antenna	SCHWARZBECK	BBHA 9170	BBHA9170 584	18GHz- 40GHz	Dec. 05, 2018	Sep. 24, 2019~ Nov. 02, 2019	Dec. 04, 2019	Radiation (03CH11-HY)
EMI Test Receiver	Keysight	N9038A(MXE)	MY554201 70	20MHz~8.4GHz	Mar. 08, 2019	Sep. 24, 2019~ Nov. 02, 2019	Mar. 07, 2020	Radiation (03CH11-HY)
Software	Audix	E3 6.2009-8-24	RK-00104 2	N/A	N/A	Sep. 24, 2019~ Nov. 02, 2019	N/A	Radiation (03CH11-HY)
RF Cable	HUBER + SUHNER	SUCOFLEX 104	MY9837/4 PE	9kHz-30MHz	Mar. 13, 2019	Sep. 24, 2019~ Nov. 02, 2019	Mar. 12, 2020	Radiation (03CH11-HY)
RF Cable	HUBER + SUHNER	SUCOFLEX 102	MY2859/2	30MHz-40GHz	Mar. 13, 2019	Sep. 24, 2019~ Nov. 02, 2019	Mar. 12, 2020	Radiation (03CH11-HY)
RF Cable	HUBER + SUHNER	SUCOFLEX 104	MY9837/4 PE	30M-18G	Mar. 13, 2019	Sep. 24, 2019~ Nov. 02, 2019	Mar. 12, 2020	Radiation (03CH11-HY)
RF Cable	HUBER + SUHNER	SUCOFLEX 102	MY4274/2	30MHz-40GHz	Mar. 13, 2019	Sep. 24, 2019~ Nov. 02, 2019	Mar. 12, 2020	Radiation (03CH11-HY)
Filter	Wainwright	WLK4-1000-1 530-8000-40S S	SN11	1.53G Low Pass	Sep. 15, 2019	Sep. 24, 2019~ Nov. 02, 2019	Sep. 14, 2020	Radiation (03CH11-HY)
Filter	Wainwright	WHKX8-5872. 5-6750-18000 -40ST	SN3	6.75GHz High Pass	Sep. 16, 2019	Sep. 24, 2019~ Nov. 02, 2019	Sep. 15, 2020	Radiation (03CH11-HY)



Instrument	Manufacturer	Model No.	Serial No.	Characteristics	Calibration Date	Test Date	Due Date	Remark
<For CDD Mode>								
Power Sensor	DARE	RPR3006W	16I00054S NO10	10MHz~6GHz	Dec. 19, 2018	Oct. 11, 2019~ Nov. 01, 2019	Dec. 18, 2019	Conducted (TH05-HY)
Spectrum Analyzer	Rohde & Schwarz	FSV40	101397	10Hz~40GHz	Nov. 13, 2018	Oct. 11, 2019~ Nov. 01, 2019	Nov. 12, 2019	Conducted (TH05-HY)
Switch Box & RF Cable	EM	EMSW18	SW107090 3	N/A	Dec. 19, 2018	Oct. 11, 2019~ Nov. 01, 2019	Dec. 18, 2019	Conducted (TH05-HY)
<For TXBF Mode>								
Power Sensor	DARE	RPR3006W	16I00054S NO10	10MHz~6GHz	Dec. 19, 2018	Oct. 11, 2019~ Nov. 04, 2019	Dec. 18, 2019	Conducted (TH05-HY)
Spectrum Analyzer	Rohde & Schwarz	FSV40	101397	10Hz~40GHz	Nov. 13, 2018	Oct. 11, 2019~ Nov. 04, 2019	Nov. 12, 2019	Conducted (TH05-HY)
Switch Box & RF Cable	EM	EMSW18	SW107090 3	N/A	Dec. 19, 2018	Oct. 11, 2019~ Nov. 04, 2019	Dec. 18, 2019	Conducted (TH05-HY)



5 Uncertainty of Evaluation

Uncertainty of Conducted Emission Measurement (150kHz ~ 30MHz)

Measuring Uncertainty for a Level of Confidence of 95% ($U = 2Uc(y)$)	2.2
---	-----

Uncertainty of Radiated Emission Measurement (30 MHz ~ 1000 MHz)

Measuring Uncertainty for a Level of Confidence of 95% ($U = 2Uc(y)$)	5.2
---	-----

Uncertainty of Radiated Emission Measurement (1000 MHz ~ 18000 MHz)

Measuring Uncertainty for a Level of Confidence of 95% ($U = 2Uc(y)$)	5.5
---	-----

Uncertainty of Radiated Emission Measurement (18000 MHz ~ 40000 MHz)

Measuring Uncertainty for a Level of Confidence of 95% ($U = 2Uc(y)$)	5.2
---	-----



Appendix A. AC Conducted Emission Test Results

Test Engineer :	Howard Huang	Temperature :	25.9~26.2°C
		Relative Humidity :	41.8~42.7%
Test Voltage :	120Vac / 60Hz	Phase :	Line

Full Spectrum

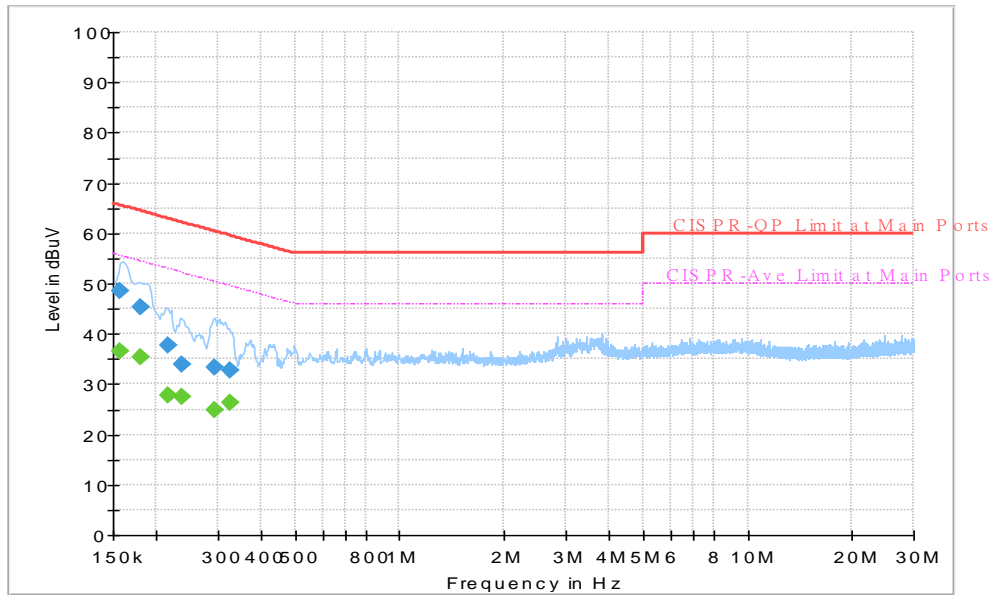

Final Result

Frequency (MHz)	QuasiPeak (dBuV)	CAverage (dBuV)	Limit (dBuV)	Margin (dB)	Line	Filter	Corr. (dB)
0.156750	---	36.46	55.63	19.17	L1	OFF	19.4
0.156750	48.40	---	65.63	17.23	L1	OFF	19.4
0.179250	---	35.44	54.52	19.08	L1	OFF	19.4
0.179250	45.38	---	64.52	19.14	L1	OFF	19.4
0.215250	---	27.86	53.00	25.14	L1	OFF	19.4
0.215250	37.65	---	63.00	25.35	L1	OFF	19.4
0.235500	---	27.57	52.25	24.68	L1	OFF	19.4
0.235500	33.94	---	62.25	28.31	L1	OFF	19.4
0.294000	---	24.94	50.41	25.47	L1	OFF	19.4
0.294000	33.43	---	60.41	26.98	L1	OFF	19.4
0.325500	---	26.41	49.57	23.16	L1	OFF	19.4
0.325500	32.86	---	59.57	26.71	L1	OFF	19.4



Test Engineer :	Howard Huang	Temperature :	25.9~26.2°C
		Relative Humidity :	41.8~42.7%
Test Voltage :	120Vac / 60Hz	Phase :	Neutral

Full Spectrum

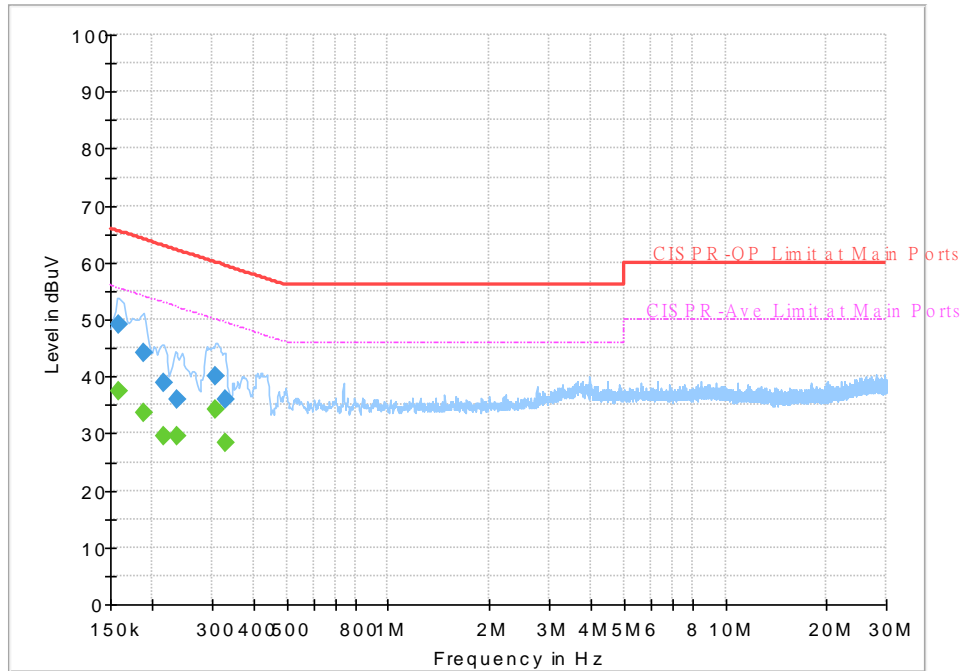

Final_Result

Frequency (MHz)	QuasiPeak (dBuV)	CAverage (dBuV)	Limit (dBuV)	Margin (dB)	Line	Filter	Corr. (dB)
0.159000	---	37.46	55.52	18.06	N	OFF	19.5
0.159000	49.01	---	65.52	16.51	N	OFF	19.5
0.188250	---	33.58	54.11	20.53	N	OFF	19.5
0.188250	44.29	---	64.11	19.82	N	OFF	19.5
0.215250	---	29.54	53.00	23.46	N	OFF	19.5
0.215250	38.99	---	63.00	24.01	N	OFF	19.5
0.237750	---	29.49	52.17	22.68	N	OFF	19.5
0.237750	35.84	---	62.17	26.33	N	OFF	19.5
0.307500	---	34.08	50.04	15.96	N	OFF	19.5
0.307500	40.19	---	60.04	19.85	N	OFF	19.5
0.327750	---	28.50	49.51	21.01	N	OFF	19.5
0.327750	35.86	---	59.51	23.65	N	OFF	19.5



Appendix B. Radiated Spurious Emission

Test Engineer :	Watt Tseng, Cookie Ku, Fu Chen, Troye Hsieh\	Temperature :	20.7 ~ 27.9°C
		Relative Humidity :	48.4 ~ 69.4%

<CDD Mode>

<For SKU1>

Band 4 - 5725~5850MHz

WIFI 802.11a (Band Edge @ 3m)

WIFI Ant.	Note	Frequency (MHz)	Level (dBμV/m)	Over Limit (dB)	Limit Line (dBμV/m)	Read Level (dBμV)	Antenna Factor (dB/m)	Path Loss (dB)	Preamp Factor (dB)	Ant Pos (cm)	Table Pos (deg)	Peak Avg. (P/A)	Pol. (H/V)	
802.11a CH 149 5745MHz		5638.8	49.38	-18.82	68.2	40.33	31.72	10.48	33.15	167	279	P	H	
		5697.8	53.17	-50.41	103.58	43.84	31.99	10.51	33.17	167	279	P	H	
		5712	52.09	-56.47	108.56	42.73	32.02	10.52	33.18	167	279	P	H	
		5725	57.44	-64.76	122.2	48.04	32.05	10.53	33.18	167	279	P	H	
	*	5745	107.14	-	-	97.7	32.09	10.54	33.19	167	279	P	H	
	*	5745	99.65	-	-	90.21	32.09	10.54	33.19	167	279	A	H	
														H
														H
			5629.8	50.38	-17.82	68.2	41.31	31.74	10.48	33.15	397	308	P	V
			5688	52.12	-44.23	96.35	42.85	31.93	10.51	33.17	397	308	P	V
			5709.8	54.69	-53.26	107.95	45.33	32.02	10.52	33.18	397	308	P	V
			5724.4	56.6	-64.23	120.83	47.2	32.05	10.53	33.18	397	308	P	V
	*		5745	111.71	-	-	102.27	32.09	10.54	33.19	397	308	P	V
	*		5745	104.2	-	-	94.76	32.09	10.54	33.19	397	308	A	V
													V	
													V	



WIFI Ant. 1	Note	Frequency (MHz)	Level (dBμV/m)	Over Limit (dB)	Limit Line (dBμV/m)	Read Level (dBμV)	Antenna Factor (dB/m)	Path Loss (dB)	Preamp Factor (dB)	Ant Pos (cm)	Table Pos (deg)	Peak Avg. (P/A)	Pol. (H/V)
		5648.5	49.25	-18.95	68.2	40.22	31.7	10.49	33.16	163	280	P	H
		5690.25	49.38	-48.63	98.01	40.1	31.94	10.51	33.17	163	280	P	H
		5708.75	50.18	-57.47	107.65	40.82	32.02	10.52	33.18	163	280	P	H
		5720	49.43	-61.37	110.8	40.04	32.04	10.53	33.18	163	280	P	H
	*	5785	106.56	-	-	97.03	32.17	10.56	33.2	163	280	P	H
	*	5785	99.03	-	-	89.5	32.17	10.56	33.2	163	280	A	H
		5854.75	50.13	-61.24	111.37	40.44	32.32	10.59	33.22	163	280	P	H
		5855.75	51.14	-59.45	110.59	41.45	32.32	10.59	33.22	163	280	P	H
		5883	51.01	-48.25	99.26	41.21	32.43	10.6	33.23	163	280	P	H
		5942.25	50.13	-18.07	68.2	40.17	32.58	10.63	33.25	163	280	P	H
													H
													H
802.11a													
CH 157													
5785MHz		5601.5	48.37	-19.83	68.2	39.25	31.8	10.46	33.14	374	303	P	V
		5695.75	49.78	-52.29	102.07	40.47	31.97	10.51	33.17	374	303	P	V
		5708	49.73	-57.71	107.44	40.37	32.02	10.52	33.18	374	303	P	V
		5724.5	49.27	-71.79	121.06	39.87	32.05	10.53	33.18	374	303	P	V
	*	5785	109.88	-	-	100.35	32.17	10.56	33.2	374	303	P	V
	*	5785	102.31	-	-	92.78	32.17	10.56	33.2	374	303	A	V
		5853.75	50	-63.65	113.65	40.32	32.31	10.59	33.22	374	303	P	V
		5867.25	52.15	-55.22	107.37	42.41	32.37	10.6	33.23	374	303	P	V
		5905.25	51.31	-31.47	82.78	41.43	32.51	10.61	33.24	374	303	P	V
		5930	50.25	-17.95	68.2	40.32	32.56	10.62	33.25	374	303	P	V
													V
													V



WIFI Ant. 1	Note	Frequency (MHz)	Level (dBμV/m)	Over Limit (dB)	Limit Line (dBμV/m)	Read Level (dBμV)	Antenna Factor (dB/m)	Path Loss (dB)	Preamp Factor (dB)	Ant Pos (cm)	Table Pos (deg)	Peak Avg. (P/A)	Pol. (H/V)	
802.11a CH 165 5825MHz	*	5825	105.86	-	-	96.24	32.25	10.58	33.21	164	283	P	H	
	*	5825	98.46	-	-	88.84	32.25	10.58	33.21	164	283	A	H	
		5850.6	52.05	-68.78	120.83	42.38	32.3	10.59	33.22	164	283	P	H	
		5859.2	52.74	-56.88	109.62	43.03	32.34	10.59	33.22	164	283	P	H	
		5879.4	52.18	-49.75	101.93	42.39	32.42	10.6	33.23	164	283	P	H	
		5925.8	50.97	-17.23	68.2	41.05	32.55	10.62	33.25	164	283	P	H	
														H
														H
	*	5825	109.38	-	-	99.76	32.25	10.58	33.21	386	304	P	V	
	*	5825	101.89	-	-	92.27	32.25	10.58	33.21	386	304	A	V	
		5854.75	54.49	-56.88	111.37	44.8	32.32	10.59	33.22	386	304	P	V	
		5874.75	52.83	-52.44	105.27	43.06	32.4	10.6	33.23	386	304	P	V	
		5880.75	53.12	-47.81	100.93	43.33	32.42	10.6	33.23	386	304	P	V	
		5928.75	49.91	-18.29	68.2	39.98	32.56	10.62	33.25	386	304	P	V	
														V
														V
													V	
Remark	1. No other spurious found. 2. All results are PASS against Peak and Average limit line.													



Band 4 5725~5850MHz

WIFI 802.11a (Harmonic @ 3m)

WIFI Ant. 1	Note	Frequency (MHz)	Level (dBμV/m)	Over Limit (dB)	Limit Line (dBμV/m)	Read Level (dBμV)	Antenna Factor (dB/m)	Path Loss (dB)	Preamp Factor (dB)	Ant Pos (cm)	Table Pos (deg)	Peak Avg. (P/A)	Pol. (H/V)
802.11a CH 149 5745MHz		10360	50.75	-17.45	68.2	56.15	39.54	16.35	61.29	100	0	P	H
		15540	46.84	-27.16	74	48.25	38.3	20.62	60.33	100	0	P	H
													H
													H
		10360	49.74	-18.46	68.2	55.14	39.54	16.35	61.29	100	0	P	V
		15540	46.97	-27.03	74	48.38	38.3	20.62	60.33	100	0	P	V
													V
													V
802.11a CH 157 5785MHz		11570	49.42	-24.58	74	53.32	39.49	17.6	60.99	100	0	P	H
		17355	50.04	-18.16	68.2	47.29	40.98	22.18	60.41	100	0	P	H
													H
													H
		11570	50.04	-23.96	74	53.94	39.49	17.6	60.99	100	0	P	V
		17355	49.51	-18.69	68.2	46.76	40.98	22.18	60.41	100	0	P	V
													V
													V
802.11a CH 165 5825MHz		11650	49.25	-24.75	74	53.39	39.2	17.72	61.06	100	0	P	H
		17475	50.26	-17.94	68.2	46.93	41.58	22.28	60.53	100	0	P	H
													H
													H
		11650	49.09	-24.91	74	53.23	39.2	17.72	61.06	100	0	P	V
		17475	50.21	-17.99	68.2	46.88	41.58	22.28	60.53	100	0	P	V
													V
													V
Remark	1. No other spurious found. 2. All results are PASS against Peak and Average limit line.												



Band 4 5725~5850MHz

WIFI 802.11ac VHT20 (Band Edge @ 3m)

WIFI Ant. 1	Note	Frequency (MHz)	Level (dBμV/m)	Over Limit (dB)	Limit Line (dBμV/m)	Read Level (dBμV)	Antenna Factor (dB/m)	Path Loss (dB)	Preamp Factor (dB)	Ant Pos (cm)	Table Pos (deg)	Peak Avg. (P/A)	Pol. (H/V)	
802.11ac VHT20 CH 149 5745MHz		5632	49.29	-18.91	68.2	40.22	31.74	10.48	33.15	169	280	P	H	
		5681.2	49.67	-41.66	91.33	40.45	31.89	10.5	33.17	169	280	P	H	
		5719.4	51.12	-59.51	110.63	41.73	32.04	10.53	33.18	169	280	P	H	
		5725	53.55	-68.65	122.2	44.15	32.05	10.53	33.18	169	280	P	H	
	*	5745	106.84	-	-	97.4	32.09	10.54	33.19	169	280	P	H	
	*	5745	99.17	-	-	89.73	32.09	10.54	33.19	169	280	A	H	
														H
														H
			5633	49.94	-18.26	68.2	40.88	31.73	10.48	33.15	380	303	P	V
			5697.2	51.27	-51.87	103.14	41.95	31.98	10.51	33.17	380	303	P	V
			5719.8	56.02	-54.72	110.74	46.63	32.04	10.53	33.18	380	303	P	V
			5724.6	58.35	-62.94	121.29	48.95	32.05	10.53	33.18	380	303	P	V
	*		5745	111.05	-	-	101.61	32.09	10.54	33.19	380	303	P	V
	*		5745	103.21	-	-	93.77	32.09	10.54	33.19	380	303	A	V
													V	
													V	



WIFI Ant. 1	Note	Frequency (MHz)	Level (dBµV/m)	Over Limit (dB)	Limit Line (dBµV/m)	Read Level (dBµV)	Antenna Factor (dB/m)	Path Loss (dB)	Preamp Factor (dB)	Ant Pos (cm)	Table Pos (deg)	Peak Avg. (P/A)	Pol. (H/V)
		5613.5	49.35	-18.85	68.2	40.26	31.77	10.47	33.15	163	280	P	H
		5665.75	49.59	-30.3	79.89	40.46	31.79	10.5	33.16	163	280	P	H
		5700	49.25	-55.95	105.2	39.91	32	10.51	33.17	163	280	P	H
		5720.25	49.06	-62.31	111.37	39.67	32.04	10.53	33.18	163	280	P	H
	*	5785	106.27	-	-	96.74	32.17	10.56	33.2	163	280	P	H
	*	5785	98.72	-	-	89.19	32.17	10.56	33.2	163	280	A	H
		5852	50.41	-67.23	117.64	40.73	32.31	10.59	33.22	163	280	P	H
		5855.5	50.86	-59.8	110.66	41.17	32.32	10.59	33.22	163	280	P	H
		5887.25	51.98	-44.13	96.11	42.16	32.45	10.6	33.23	163	280	P	H
		5933	49.87	-18.33	68.2	39.93	32.57	10.62	33.25	163	280	P	H
802.11ac													H
VHT20													H
CH 157		5612.25	52.3	-15.9	68.2	43.2	31.78	10.47	33.15	392	309	P	V
5785MHz		5671.5	49.74	-34.41	84.15	40.57	31.83	10.5	33.16	392	309	P	V
		5719.75	50.32	-60.41	110.73	40.93	32.04	10.53	33.18	392	309	P	V
		5720	50.25	-60.55	110.8	40.86	32.04	10.53	33.18	392	309	P	V
	*	5785	110.01	-	-	100.48	32.17	10.56	33.2	392	309	P	V
	*	5785	102.33	-	-	92.8	32.17	10.56	33.2	392	309	A	V
		5850.25	51.5	-70.13	121.63	41.83	32.3	10.59	33.22	392	309	P	V
		5873.25	50.8	-54.89	105.69	41.04	32.39	10.6	33.23	392	309	P	V
		5875	50.79	-54.41	105.2	41.02	32.4	10.6	33.23	392	309	P	V
		5943.25	49.82	-18.38	68.2	39.85	32.59	10.63	33.25	392	309	P	V
													V
													V



WIFI Ant. 1	Note	Frequency (MHz)	Level (dBμV/m)	Over Limit (dB)	Limit Line (dBμV/m)	Read Level (dBμV)	Antenna Factor (dB/m)	Path Loss (dB)	Preamp Factor (dB)	Ant Pos (cm)	Table Pos (deg)	Peak Avg. (P/A)	Pol. (H/V)	
802.11ac VHT20 CH 165 5825MHz	*	5825	105.58	-	-	95.96	32.25	10.58	33.21	164	285	P	H	
	*	5825	97.99	-	-	88.37	32.25	10.58	33.21	164	285	A	H	
		5850.4	52.53	-68.76	121.29	42.86	32.3	10.59	33.22	164	285	P	H	
		5866.8	51.64	-55.85	107.49	41.9	32.37	10.6	33.23	164	285	P	H	
		5888.8	52.77	-42.19	94.96	42.93	32.46	10.61	33.23	164	285	P	H	
		5927	49.09	-19.11	68.2	39.17	32.55	10.62	33.25	164	285	P	H	
														H
														H
	*	5825	109.28	-	-	99.66	32.25	10.58	33.21	385	311	P	V	
	*	5825	101.76	-	-	92.14	32.25	10.58	33.21	385	311	A	V	
		5850.6	56.2	-64.63	120.83	46.53	32.3	10.59	33.22	385	311	P	V	
		5862.6	53.06	-55.61	108.67	43.34	32.35	10.6	33.23	385	311	P	V	
		5881.2	52.32	-48.27	100.59	42.53	32.42	10.6	33.23	385	311	P	V	
		5925	50.97	-17.23	68.2	41.05	32.55	10.62	33.25	385	311	P	V	
														V
													V	
Remark	1. No other spurious found. 2. All results are PASS against Peak and Average limit line.													



Band 4 5725~5850MHz

WIFI 802.11ac VHT20 (Harmonic @ 3m)

WIFI Ant. 1	Note	Frequency (MHz)	Level (dBµV/m)	Over Limit (dB)	Limit Line (dBµV/m)	Read Level (dBµV)	Antenna Factor (dB/m)	Path Loss (dB)	Preamp Factor (dB)	Ant Pos (cm)	Table Pos (deg)	Peak Avg. (P/A)	Pol. (H/V)	
802.11ac VHT20 CH 149 5745MHz		11490	49.39	-24.61	74	53.15	39.7	17.48	60.94	100	0	P	H	
		17235	50.58	-17.62	68.2	48.31	40.51	22.06	60.3	100	0	P	H	
													H	
													H	
			11490	49.54	-24.46	74	53.3	39.7	17.48	60.94	100	0	P	V
			17235	49.44	-18.76	68.2	47.17	40.51	22.06	60.3	100	0	P	V
														V
802.11ac VHT20 CH 157 5785MHz		11570	49.4	-24.6	74	53.3	39.49	17.6	60.99	100	0	P	H	
		17355	49.45	-18.75	68.2	46.7	40.98	22.18	60.41	100	0	P	H	
													H	
													H	
			11570	50.9	-23.1	74	54.8	39.49	17.6	60.99	100	0	P	V
			17355	49.63	-18.57	68.2	46.88	40.98	22.18	60.41	100	0	P	V
														V
802.11ac VHT20 CH 165 5825MHz		11650	48.88	-25.12	74	53.02	39.2	17.72	61.06	100	0	P	H	
		17475	49.83	-18.37	68.2	46.5	41.58	22.28	60.53	100	0	P	H	
													H	
													H	
			11650	49.03	-24.97	74	53.17	39.2	17.72	61.06	100	0	P	V
			17475	49.87	-18.33	68.2	46.54	41.58	22.28	60.53	100	0	P	V
														V
Remark	1. No other spurious found.													
	2. All results are PASS against Peak and Average limit line.													



Band 4 5725~5850MHz

WIFI 802.11ac VHT40 (Band Edge @ 3m)

WIFI Ant. 1	Note	Frequency (MHz)	Level (dBμV/m)	Over Limit (dB)	Limit Line (dBμV/m)	Read Level (dBμV)	Antenna Factor (dB/m)	Path Loss (dB)	Preamp Factor (dB)	Ant Pos (cm)	Table Pos (deg)	Peak Avg. (P/A)	Pol. (H/V)
		5648.75	48.85	-19.35	68.2	39.82	31.7	10.49	33.16	164	278	P	H
		5699.75	52.01	-53.01	105.02	42.67	32	10.51	33.17	164	278	P	H
		5718	57.57	-52.67	110.24	48.19	32.04	10.52	33.18	164	278	P	H
		5723.75	59.78	-59.57	119.35	50.38	32.05	10.53	33.18	164	278	P	H
	*	5755	104.25	-	-	94.78	32.11	10.55	33.19	164	278	P	H
	*	5755	96.17	-	-	86.7	32.11	10.55	33.19	164	278	A	H
		5850.5	52.19	-68.87	121.06	42.52	32.3	10.59	33.22	164	278	P	H
		5855.75	51.86	-58.73	110.59	42.17	32.32	10.59	33.22	164	278	P	H
		5915	49.49	-26.08	75.57	39.58	32.53	10.62	33.24	164	278	P	H
		5931.5	49.28	-18.92	68.2	39.35	32.56	10.62	33.25	164	278	P	H
802.11ac													H
VHT40													H
CH 151		5623.75	49.82	-18.38	68.2	40.75	31.75	10.47	33.15	397	309	P	V
5755MHz		5699.25	54.63	-50.02	104.65	45.29	32	10.51	33.17	397	309	P	V
		5717.25	62.86	-47.17	110.03	53.49	32.03	10.52	33.18	397	309	P	V
		5725	64.27	-57.93	122.2	54.87	32.05	10.53	33.18	397	309	P	V
	*	5755	108.63	-	-	99.16	32.11	10.55	33.19	397	309	P	V
	*	5755	100.57	-	-	91.1	32.11	10.55	33.19	397	309	A	V
		5854.5	51.21	-60.73	111.94	41.52	32.32	10.59	33.22	397	309	P	V
		5867.5	51.44	-55.86	107.3	41.7	32.37	10.6	33.23	397	309	P	V
		5906	52.68	-29.54	82.22	42.8	32.51	10.61	33.24	397	309	P	V
		5934.75	51.13	-17.07	68.2	41.19	32.57	10.62	33.25	397	309	P	V
													V
													V



WIFI Ant. 1	Note	Frequency (MHz)	Level (dBμV/m)	Over Limit (dB)	Limit Line (dBμV/m)	Read Level (dBμV)	Antenna Factor (dB/m)	Path Loss (dB)	Preamp Factor (dB)	Ant Pos (cm)	Table Pos (deg)	Peak Avg. (P/A)	Pol. (H/V)
		5648.5	49.43	-18.77	68.2	40.4	31.7	10.49	33.16	159	279	P	H
		5652.5	50.99	-19.07	70.06	41.94	31.72	10.49	33.16	159	279	P	H
		5716.5	50.32	-59.5	109.82	40.95	32.03	10.52	33.18	159	279	P	H
		5724.5	49.15	-71.91	121.06	39.75	32.05	10.53	33.18	159	279	P	H
	*	5795	103.66	-	-	94.1	32.19	10.57	33.2	159	279	P	H
	*	5795	95.81	-	-	86.25	32.19	10.57	33.2	159	279	A	H
		5853	53.09	-62.27	115.36	43.41	32.31	10.59	33.22	159	279	P	H
		5866.75	53.31	-54.2	107.51	43.57	32.37	10.6	33.23	159	279	P	H
		5876	52.07	-52.39	104.46	42.3	32.4	10.6	33.23	159	279	P	H
		5942.75	49.68	-18.52	68.2	39.71	32.59	10.63	33.25	159	279	P	H
802.11ac													H
VHT40													H
CH 159		5621	48.65	-19.55	68.2	39.57	31.76	10.47	33.15	389	310	P	V
5795MHz		5668	49.93	-31.63	81.56	40.78	31.81	10.5	33.16	389	310	P	V
		5719.75	51.13	-59.6	110.73	41.74	32.04	10.53	33.18	389	310	P	V
		5721.75	50.96	-63.83	114.79	41.57	32.04	10.53	33.18	389	310	P	V
	*	5795	107.86	-	-	98.3	32.19	10.57	33.2	389	310	P	V
	*	5795	99.78	-	-	90.22	32.19	10.57	33.2	389	310	A	V
		5851.25	54.75	-64.6	119.35	45.07	32.31	10.59	33.22	389	310	P	V
		5860.25	54.76	-54.57	109.33	45.06	32.34	10.59	33.23	389	310	P	V
		5913.25	52.75	-24.12	76.87	42.84	32.53	10.62	33.24	389	310	P	V
		5928.5	49.75	-18.45	68.2	39.82	32.56	10.62	33.25	389	310	P	V
													V
													V
Remark	1. No other spurious found. 2. All results are PASS against Peak and Average limit line.												



Band 4 5725~5850MHz

WIFI 802.11ac VHT40 (Harmonic @ 3m)

WIFI Ant. 1	Note	Frequency (MHz)	Level (dBµV/m)	Over Limit (dB)	Limit Line (dBµV/m)	Read Level (dBµV)	Antenna Factor (dB/m)	Path Loss (dB)	Preamp Factor (dB)	Ant Pos (cm)	Table Pos (deg)	Peak Avg. (P/A)	Pol. (H/V)
802.11ac VHT40 CH 151 5755MHz		11510	48.64	-25.36	74	52.4	39.67	17.51	60.94	100	0	P	H
		17265	50.48	-17.72	68.2	48.11	40.6	22.09	60.32	100	0	P	H
													H
													H
		11510	48.82	-25.18	74	52.58	39.67	17.51	60.94	100	0	P	V
		17265	49.25	-18.95	68.2	46.88	40.6	22.09	60.32	100	0	P	V
													V
													V
802.11ac VHT40 CH 159 5795MHz		11590	48.66	-25.34	74	52.61	39.43	17.63	61.01	100	0	P	H
		17385	49.58	-18.62	68.2	46.7	41.12	22.2	60.44	100	0	P	H
													H
													H
		11590	49.46	-24.54	74	53.41	39.43	17.63	61.01	100	0	P	V
		17385	49.6	-18.6	68.2	46.72	41.12	22.2	60.44	100	0	P	V
													V
													V
Remark	1. No other spurious found. 2. All results are PASS against Peak and Average limit line.												



Band 4 5725~5850MHz

WIFI 802.11ac VHT80 (Band Edge @ 3m)

WIFI Ant. 1	Note	Frequency (MHz)	Level (dBμV/m)	Over Limit (dB)	Limit Line (dBμV/m)	Read Level (dBμV)	Antenna Factor (dB/m)	Path Loss (dB)	Preamp Factor (dB)	Ant Pos (cm)	Table Pos (deg)	Peak Avg. (P/A)	Pol. (H/V)
		5638.5	52.61	-15.59	68.2	43.56	31.72	10.48	33.15	105	298	P	H
		5692.25	60.16	-39.33	99.49	50.87	31.95	10.51	33.17	105	298	P	H
		5718	71.53	-38.71	110.24	62.15	32.04	10.52	33.18	105	298	P	H
		5722.75	63.3	-53.77	117.07	53.9	32.05	10.53	33.18	105	298	P	H
	*	5775	105.06	-	-	95.55	32.15	10.56	33.2	105	298	P	H
	*	5775	97.21	-	-	87.7	32.15	10.56	33.2	105	298	A	H
		5853.5	66.76	-47.46	114.22	57.08	32.31	10.59	33.22	105	298	P	H
		5860.75	66.55	-42.64	109.19	56.85	32.34	10.59	33.23	105	298	P	H
		5875.5	57.07	-47.76	104.83	47.3	32.4	10.6	33.23	105	298	P	H
		5931.25	51.91	-16.29	68.2	41.98	32.56	10.62	33.25	105	298	P	H
802.11ac													H
VHT80													H
CH 155		5634.5	49.08	-19.12	68.2	40.02	31.73	10.48	33.15	384	257	P	V
5775MHz		5661.75	49.69	-27.23	76.92	40.59	31.77	10.49	33.16	384	257	P	V
		5718.75	49.23	-61.22	110.45	39.84	32.04	10.53	33.18	384	257	P	V
		5720.5	49.82	-62.12	111.94	40.43	32.04	10.53	33.18	384	257	P	V
	*	5775	98.1	-	-	88.59	32.15	10.56	33.2	384	257	P	V
	*	5775	89.63	-	-	80.12	32.15	10.56	33.2	384	257	A	V
		5851.75	52.87	-65.34	118.21	43.19	32.31	10.59	33.22	384	257	P	V
		5872.5	52.39	-53.51	105.9	42.63	32.39	10.6	33.23	384	257	P	V
		5875	51.25	-53.95	105.2	41.48	32.4	10.6	33.23	384	257	P	V
		5929.25	51.07	-17.13	68.2	41.14	32.56	10.62	33.25	384	257	P	V
													V
													V
Remark	1. No other spurious found. 2. All results are PASS against Peak and Average limit line.												



Band 4 5725~5850MHz

WIFI 802.11ac VHT80 (Harmonic @ 3m)

WIFI Ant. 1	Note	Frequency (MHz)	Level (dBμV/m)	Over Limit (dB)	Limit Line (dBμV/m)	Read Level (dBμV)	Antenna Factor (dB/m)	Path Loss (dB)	Preamp Factor (dB)	Ant Pos (cm)	Table Pos (deg)	Peak Avg. (P/A)	Pol. (H/V)	
802.11ac VHT80 CH 155 5775MHz		11550	47.81	-26.19	74	51.67	39.55	17.57	60.98	100	0	P	H	
		17325	47.89	-20.31	68.2	45.28	40.83	22.15	60.37	100	0	P	H	
													H	
													H	
			11550	47.26	-26.74	74	51.12	39.55	17.57	60.98	100	0	P	V
			17325	47.92	-20.28	68.2	45.31	40.83	22.15	60.37	100	0	P	V
														V
														V
Remark	1. No other spurious found. 2. All results are PASS against Peak and Average limit line.													



Emission below 1GHz

5GHz WIFI 802.11ac VHT80 (LF @ 3m)

WIFI	Note	Frequency	Level	Over	Limit	Read	Antenna	Path	Preamp	Ant	Table	Peak	Pol.	
Ant.				Limit	Line	Level	Factor	Loss	Factor	Pos	Pos	Avg.		
1		(MHz)	(dBμV/m)	(dB)	(dBμV/m)	(dBμV)	(dB/m)	(dB)	(dB)	(cm)	(deg)	(P/A)	(H/V)	
5GHz 802.11ac VHT40 LF		40.67	30.38	-9.62	40	42.41	19.4	0.94	32.37	100	0	P	H	
		63.95	20.74	-19.26	40	40.01	11.99	1.1	32.36	-	-	P	H	
		111.48	23.68	-19.82	43.5	37.52	17.05	1.42	32.31	-	-	P	H	
		930.16	32.73	-13.27	46	29.8	29.71	4.29	31.07	-	-	P	H	
		941.8	33.75	-12.25	46	29.99	30.41	4.32	30.97	-	-	P	H	
		951.5	34.64	-11.36	46	30.25	30.93	4.34	30.88	-	-	P	H	
														H
														H
														H
														H
														H
														H
														H
														H
														H
			40.67	28.49	-11.51	40	40.52	19.4	0.94	32.37	103	26	QP	V
			48.43	26.11	-13.89	40	42.4	15.14	0.94	32.37	-	-	P	V
			54.25	24.15	-15.85	40	42.79	12.73	1	32.37	-	-	P	V
		944.71	33.3	-12.7	46	29.33	30.58	4.33	30.94	-	-	P	V	
		949.56	33.63	-12.37	46	29.31	30.87	4.34	30.89	-	-	P	V	
		954.41	34.19	-11.81	46	29.7	30.99	4.35	30.85	-	-	P	V	
													V	
													V	
													V	
													V	
													V	
													V	
Remark	1. No other spurious found. 2. All results are PASS against limit line.													



Band 4 - 5725~5850MHz

WIFI 802.11a (Band Edge @ 3m)

WIFI Ant. 2	Note	Frequency (MHz)	Level (dBμV/m)	Over Limit (dB)	Limit Line (dBμV/m)	Read Level (dBμV)	Antenna Factor (dB/m)	Path Loss (dB)	Preamp Factor (dB)	Ant Pos (cm)	Table Pos (deg)	Peak Avg. (P/A)	Pol. (H/V)	
802.11a CH 149 5745MHz		5638.8	51.24	-16.96	68.2	42.19	31.72	10.48	33.15	189	354	P	H	
		5698.2	50.32	-53.55	103.87	40.99	31.99	10.51	33.17	189	354	P	H	
		5717.4	52.01	-58.06	110.07	42.64	32.03	10.52	33.18	189	354	P	H	
		5723.6	50.21	-68.8	119.01	40.81	32.05	10.53	33.18	189	354	P	H	
	*	5745	106.41	-	-	96.97	32.09	10.54	33.19	189	354	P	H	
	*	5745	99.04	-	-	89.6	32.09	10.54	33.19	189	354	A	H	
														H
														H
			5614	49.9	-18.3	68.2	40.81	31.77	10.47	33.15	398	65	P	V
			5698.2	52.91	-50.96	103.87	43.58	31.99	10.51	33.17	398	65	P	V
			5712	54.75	-53.81	108.56	45.39	32.02	10.52	33.18	398	65	P	V
			5725	55.88	-66.32	122.2	46.48	32.05	10.53	33.18	398	65	P	V
	*		5745	111.59	-	-	102.15	32.09	10.54	33.19	398	65	P	V
	*		5745	104.01	-	-	94.57	32.09	10.54	33.19	398	65	A	V
														V
														V



WIFI Ant. 2	Note	Frequency (MHz)	Level (dBμV/m)	Over Limit (dB)	Limit Line (dBμV/m)	Read Level (dBμV)	Antenna Factor (dB/m)	Path Loss (dB)	Preamp Factor (dB)	Ant Pos (cm)	Table Pos (deg)	Peak Avg. (P/A)	Pol. (H/V)
		5618.75	49.21	-18.99	68.2	40.13	31.76	10.47	33.15	214	349	P	H
		5692.5	49.9	-49.77	99.67	40.61	31.95	10.51	33.17	214	349	P	H
		5708.5	49.35	-58.23	107.58	39.99	32.02	10.52	33.18	214	349	P	H
		5724.75	48.4	-73.23	121.63	39	32.05	10.53	33.18	214	349	P	H
	*	5785	106.16	-	-	96.63	32.17	10.56	33.2	214	349	P	H
	*	5785	99.09	-	-	89.56	32.17	10.56	33.2	214	349	A	H
		5852.5	50.05	-66.45	116.5	40.37	32.31	10.59	33.22	214	349	P	H
		5868.5	50.88	-56.14	107.02	41.14	32.37	10.6	33.23	214	349	P	H
		5915.25	50.76	-24.63	75.39	40.85	32.53	10.62	33.24	214	349	P	H
		5946.75	49.59	-18.61	68.2	39.62	32.59	10.63	33.25	214	349	P	H
													H
													H
802.11a													
CH 157													
5785MHz		5616	49.2	-19	68.2	40.11	31.77	10.47	33.15	372	50	P	V
		5674.5	51.08	-35.29	86.37	41.9	31.85	10.5	33.17	372	50	P	V
		5712	51.12	-57.44	108.56	41.76	32.02	10.52	33.18	372	50	P	V
		5722	51.37	-63.99	115.36	41.98	32.04	10.53	33.18	372	50	P	V
	*	5785	111.22	-	-	101.69	32.17	10.56	33.2	372	50	P	V
	*	5785	103.72	-	-	94.19	32.17	10.56	33.2	372	50	A	V
		5850.5	53.92	-67.14	121.06	44.25	32.3	10.59	33.22	372	50	P	V
		5859.25	52.08	-57.53	109.61	42.37	32.34	10.59	33.22	372	50	P	V
		5893.75	51.42	-39.87	91.29	41.58	32.47	10.61	33.24	372	50	P	V
		5942	51.4	-16.8	68.2	41.44	32.58	10.63	33.25	372	50	P	V
													V
													V



WIFI Ant. 2	Note	Frequency (MHz)	Level (dBμV/m)	Over Limit (dB)	Limit Line (dBμV/m)	Read Level (dBμV)	Antenna Factor (dB/m)	Path Loss (dB)	Preamp Factor (dB)	Ant Pos (cm)	Table Pos (deg)	Peak Avg. (P/A)	Pol. (H/V)	
802.11a CH 165 5825MHz	*	5825	106.86	-	-	97.24	32.25	10.58	33.21	200	349	P	H	
	*	5825	99.57	-	-	89.95	32.25	10.58	33.21	200	349	A	H	
		5852.2	50.7	-66.48	117.18	41.02	32.31	10.59	33.22	200	349	P	H	
		5857.8	53.53	-56.48	110.01	43.83	32.33	10.59	33.22	200	349	P	H	
		5876.6	51.79	-52.22	104.01	42.01	32.41	10.6	33.23	200	349	P	H	
		5932	50.54	-17.66	68.2	40.61	32.56	10.62	33.25	200	349	P	H	
														H
														H
	*	5825	111.29	-	-	101.67	32.25	10.58	33.21	381	47	P	V	
	*	5825	103.94	-	-	94.32	32.25	10.58	33.21	381	47	A	V	
		5854.2	52.73	-59.89	112.62	43.04	32.32	10.59	33.22	381	47	P	V	
		5870.8	53.91	-52.46	106.37	44.16	32.38	10.6	33.23	381	47	P	V	
		5885.6	52.7	-44.63	97.33	42.89	32.44	10.6	33.23	381	47	P	V	
		5938	50.38	-17.82	68.2	40.42	32.58	10.63	33.25	381	47	P	V	
														V
														V
														V
Remark	1. No other spurious found. 2. All results are PASS against Peak and Average limit line.													



Band 4 5725~5850MHz

WIFI 802.11a (Harmonic @ 3m)

WIFI Ant. 2	Note	Frequency (MHz)	Level (dBµV/m)	Over Limit (dB)	Limit Line (dBµV/m)	Read Level (dBµV)	Antenna Factor (dB/m)	Path Loss (dB)	Preamp Factor (dB)	Ant Pos (cm)	Table Pos (deg)	Peak Avg. (P/A)	Pol. (H/V)
802.11a CH 149 5745MHz		11490	49.45	-24.55	74	53.21	39.7	17.48	60.94	100	0	P	H
		17235	49.32	-18.88	68.2	47.05	40.51	22.06	60.3	100	0	P	H
													H
													H
		11490	48.96	-25.04	74	52.72	39.7	17.48	60.94	100	0	P	V
		17235	49.84	-18.36	68.2	47.57	40.51	22.06	60.3	100	0	P	V
													V
													V
802.11a CH 157 5785MHz		11570	49.54	-24.46	74	53.44	39.49	17.6	60.99	100	0	P	H
		17355	49.06	-19.14	68.2	46.31	40.98	22.18	60.41	100	0	P	H
													H
													H
		11570	49.31	-24.69	74	53.21	39.49	17.6	60.99	100	0	P	V
		17355	50.42	-17.78	68.2	47.67	40.98	22.18	60.41	100	0	P	V
													V
													V
802.11a CH 165 5825MHz		11650	49.63	-24.37	74	53.77	39.2	17.72	61.06	100	0	P	H
		17475	49.87	-18.33	68.2	46.54	41.58	22.28	60.53	100	0	P	H
													H
													H
		11650	49.99	-24.01	74	54.13	39.2	17.72	61.06	100	0	P	V
		17475	50.86	-17.34	68.2	47.53	41.58	22.28	60.53	100	0	P	V
													V
													V
Remark	1. No other spurious found. 2. All results are PASS against Peak and Average limit line.												



Band 4 5725~5850MHz

WIFI 802.11ac VHT20 (Band Edge @ 3m)

WIFI Ant. 2	Note	Frequency (MHz)	Level (dBμV/m)	Over Limit (dB)	Limit Line (dBμV/m)	Read Level (dBμV)	Antenna Factor (dB/m)	Path Loss (dB)	Preamp Factor (dB)	Ant Pos (cm)	Table Pos (deg)	Peak Avg. (P/A)	Pol. (H/V)	
802.11ac VHT20 CH 149 5745MHz		5627.45	50.02	-18.18	68.2	40.94	31.75	10.48	33.15	190	356	P	H	
		5696.75	52.28	-50.52	102.8	42.96	31.98	10.51	33.17	190	356	P	H	
		5719.7	52.55	-58.17	110.72	43.16	32.04	10.53	33.18	190	356	P	H	
		5724.425	55.62	-65.27	120.89	46.22	32.05	10.53	33.18	190	356	P	H	
	*	5745	106.47	-	-	97.03	32.09	10.54	33.19	190	356	P	H	
	*	5745	99.18	-	-	89.74	32.09	10.54	33.19	190	356	A	H	
														H
														H
			5641.6	51.71	-16.49	68.2	42.67	31.72	10.48	33.16	376	48	P	V
			5698.8	52.19	-52.13	104.32	42.86	31.99	10.51	33.17	376	48	P	V
			5718.8	54.92	-55.54	110.46	45.53	32.04	10.53	33.18	376	48	P	V
			5723.6	56.58	-62.43	119.01	47.18	32.05	10.53	33.18	376	48	P	V
	*		5745	111.32	-	-	101.88	32.09	10.54	33.19	376	48	P	V
	*		5745	103.77	-	-	94.33	32.09	10.54	33.19	376	48	A	V
													V	
													V	



WIFI Ant. 2	Note	Frequency (MHz)	Level (dBµV/m)	Over Limit (dB)	Limit Line (dBµV/m)	Read Level (dBµV)	Antenna Factor (dB/m)	Path Loss (dB)	Preamp Factor (dB)	Ant Pos (cm)	Table Pos (deg)	Peak Avg. (P/A)	Pol. (H/V)
		5617.5	48.97	-19.23	68.2	39.89	31.76	10.47	33.15	168	16	P	H
		5676.25	48.87	-38.8	87.67	39.68	31.86	10.5	33.17	168	16	P	H
		5709.75	49.63	-58.3	107.93	40.27	32.02	10.52	33.18	168	16	P	H
		5721.25	50.09	-63.56	113.65	40.7	32.04	10.53	33.18	168	16	P	H
	*	5785	107.1	-	-	97.57	32.17	10.56	33.2	168	16	P	H
	*	5785	99.67	-	-	90.14	32.17	10.56	33.2	168	16	A	H
		5850.5	49.76	-71.3	121.06	40.09	32.3	10.59	33.22	168	16	P	H
		5855.75	50.38	-60.21	110.59	40.69	32.32	10.59	33.22	168	16	P	H
		5915.75	49.98	-25.04	75.02	40.07	32.53	10.62	33.24	168	16	P	H
		5946.25	50.49	-17.71	68.2	40.52	32.59	10.63	33.25	168	16	P	H
802.11ac													H
VHT20													H
CH 157		5626.25	49.62	-18.58	68.2	40.55	31.75	10.47	33.15	373	52	P	V
5785MHz		5686.5	50.03	-45.21	95.24	40.77	31.92	10.51	33.17	373	52	P	V
		5707.75	50.52	-56.85	107.37	41.16	32.02	10.52	33.18	373	52	P	V
		5722.75	49.68	-67.39	117.07	40.28	32.05	10.53	33.18	373	52	P	V
	*	5785	111.37	-	-	101.84	32.17	10.56	33.2	373	52	P	V
	*	5785	103.71	-	-	94.18	32.17	10.56	33.2	373	52	A	V
		5854.5	51.43	-60.51	111.94	41.74	32.32	10.59	33.22	373	52	P	V
		5874.75	51.75	-53.52	105.27	41.98	32.4	10.6	33.23	373	52	P	V
		5908.25	51.46	-29.1	80.56	41.57	32.52	10.61	33.24	373	52	P	V
		5934.25	50.34	-17.86	68.2	40.4	32.57	10.62	33.25	373	52	P	V
													V
													V



WIFI Ant. 2	Note	Frequency (MHz)	Level (dBμV/m)	Over Limit (dB)	Limit Line (dBμV/m)	Read Level (dBμV)	Antenna Factor (dB/m)	Path Loss (dB)	Preamp Factor (dB)	Ant Pos (cm)	Table Pos (deg)	Peak Avg. (P/A)	Pol. (H/V)	
802.11ac VHT20 CH 165 5825MHz	*	5825	107.63	-	-	98.01	32.25	10.58	33.21	174	16	P	H	
	*	5825	99.94	-	-	90.32	32.25	10.58	33.21	174	16	A	H	
		5853.4	53.51	-60.94	114.45	43.83	32.31	10.59	33.22	174	16	P	H	
		5873	52.71	-53.05	105.76	42.95	32.39	10.6	33.23	174	16	P	H	
		5892.2	51.94	-40.5	92.44	42.1	32.47	10.61	33.24	174	16	P	H	
		5933.4	50.43	-17.77	68.2	40.49	32.57	10.62	33.25	174	16	P	H	
														H
														H
	*	5825	111.39	-	-	101.77	32.25	10.58	33.21	382	52	P	V	
	*	5825	103.94	-	-	94.32	32.25	10.58	33.21	382	52	A	V	
		5850.4	54.53	-66.76	121.29	44.86	32.3	10.59	33.22	382	52	P	V	
		5864.6	52.74	-55.37	108.11	43.01	32.36	10.6	33.23	382	52	P	V	
		5880	52.58	-48.91	101.49	42.79	32.42	10.6	33.23	382	52	P	V	
		5935.6	51.43	-16.77	68.2	41.49	32.57	10.62	33.25	382	52	P	V	
														V
													V	
Remark	1. No other spurious found. 2. All results are PASS against Peak and Average limit line.													



Band 4 5725~5850MHz

WIFI 802.11ac VHT20 (Harmonic @ 3m)

WIFI Ant. 2	Note	Frequency (MHz)	Level (dBµV/m)	Over Limit (dB)	Limit Line (dBµV/m)	Read Level (dBµV)	Antenna Factor (dB/m)	Path Loss (dB)	Preamp Factor (dB)	Ant Pos (cm)	Table Pos (deg)	Peak Avg. (P/A)	Pol. (H/V)	
802.11ac VHT20 CH 149 5745MHz		11490	49.37	-24.63	74	53.13	39.7	17.48	60.94	100	0	P	H	
		17235	50.64	-17.56	68.2	48.37	40.51	22.06	60.3	100	0	P	H	
													H	
													H	
			11490	48.78	-25.22	74	52.54	39.7	17.48	60.94	100	0	P	V
			17235	49.83	-18.37	68.2	47.56	40.51	22.06	60.3	100	0	P	V
														V
802.11ac VHT20 CH 157 5785MHz		11570	49.1	-24.9	74	53	39.49	17.6	60.99	100	0	P	H	
		17355	50.12	-18.08	68.2	47.37	40.98	22.18	60.41	100	0	P	H	
													H	
													H	
			11570	49.59	-24.41	74	53.49	39.49	17.6	60.99	100	0	P	V
			17355	49.93	-18.27	68.2	47.18	40.98	22.18	60.41	100	0	P	V
														V
802.11ac VHT20 CH 165 5825MHz		11650	49.22	-24.78	74	53.36	39.2	17.72	61.06	100	0	P	H	
		17475	50.23	-17.97	68.2	46.9	41.58	22.28	60.53	100	0	P	H	
													H	
													H	
			11650	49.37	-24.63	74	53.51	39.2	17.72	61.06	100	0	P	V
			17475	50.21	-17.99	68.2	46.88	41.58	22.28	60.53	100	0	P	V
														V
Remark	1. No other spurious found.													
	2. All results are PASS against Peak and Average limit line.													



Band 4 5725~5850MHz

WIFI 802.11ac VHT40 (Band Edge @ 3m)

WIFI Ant. 2	Note	Frequency (MHz)	Level (dBμV/m)	Over Limit (dB)	Limit Line (dBμV/m)	Read Level (dBμV)	Antenna Factor (dB/m)	Path Loss (dB)	Preamp Factor (dB)	Ant Pos (cm)	Table Pos (deg)	Peak Avg. (P/A)	Pol. (H/V)
		5640	48.22	-19.98	68.2	39.17	31.72	10.48	33.15	167	8	P	H
		5698.75	51.48	-52.8	104.28	42.15	31.99	10.51	33.17	167	8	P	H
		5713.25	51.36	-57.55	108.91	41.99	32.03	10.52	33.18	167	8	P	H
		5723.75	51.4	-67.95	119.35	42	32.05	10.53	33.18	167	8	P	H
	*	5755	104.43	-	-	94.96	32.11	10.55	33.19	167	8	P	H
	*	5755	96.26	-	-	86.79	32.11	10.55	33.19	167	8	A	H
		5850.25	50.12	-71.51	121.63	40.45	32.3	10.59	33.22	167	8	P	H
		5861.5	49.19	-59.79	108.98	39.48	32.35	10.59	33.23	167	8	P	H
		5914.25	50.05	-26.08	76.13	40.14	32.53	10.62	33.24	167	8	P	H
		5942	51.12	-17.08	68.2	41.16	32.58	10.63	33.25	167	8	P	H
													H
													H
802.11ac VHT40 CH 151 5755MHz		5640.5	50.78	-17.42	68.2	41.73	31.72	10.48	33.15	394	49	P	V
		5699	52.62	-51.84	104.46	43.29	31.99	10.51	33.17	394	49	P	V
		5718.75	55.73	-54.72	110.45	46.34	32.04	10.53	33.18	394	49	P	V
		5721.25	55.75	-57.9	113.65	46.36	32.04	10.53	33.18	394	49	P	V
	*	5755	108.75	-	-	99.28	32.11	10.55	33.19	394	49	P	V
	*	5755	100.82	-	-	91.35	32.11	10.55	33.19	394	49	A	V
		5853.5	49.79	-64.43	114.22	40.11	32.31	10.59	33.22	394	49	P	V
		5859.25	50.97	-58.64	109.61	41.26	32.34	10.59	33.22	394	49	P	V
		5891.5	50.92	-42.04	92.96	41.08	32.47	10.61	33.24	394	49	P	V
		5927.25	49.79	-18.41	68.2	39.87	32.55	10.62	33.25	394	49	P	V
													V
													V



WIFI Ant. 2	Note	Frequency (MHz)	Level (dBμV/m)	Over Limit (dB)	Limit Line (dBμV/m)	Read Level (dBμV)	Antenna Factor (dB/m)	Path Loss (dB)	Preamp Factor (dB)	Ant Pos (cm)	Table Pos (deg)	Peak Avg. (P/A)	Pol. (H/V)
		5617.5	48.51	-19.69	68.2	39.43	31.76	10.47	33.15	210	351	P	H
		5694	50.72	-50.06	100.78	41.42	31.96	10.51	33.17	210	351	P	H
		5714	49.65	-59.47	109.12	40.28	32.03	10.52	33.18	210	351	P	H
		5720.25	50.11	-61.26	111.37	40.72	32.04	10.53	33.18	210	351	P	H
	*	5795	104.41	-	-	94.85	32.19	10.57	33.2	210	351	P	H
	*	5795	96.46	-	-	86.9	32.19	10.57	33.2	210	351	A	H
		5855	53.12	-57.68	110.8	43.43	32.32	10.59	33.22	210	351	P	H
		5855	53.12	-57.68	110.8	43.43	32.32	10.59	33.22	210	351	P	H
		5885.75	52.67	-44.55	97.22	42.86	32.44	10.6	33.23	210	351	P	H
		5948	50.34	-17.86	68.2	40.36	32.6	10.63	33.25	210	351	P	H
802.11ac													H
VHT40													H
CH 159		5628.25	49.36	-18.84	68.2	40.29	31.74	10.48	33.15	385	48	P	V
5795MHz		5692.25	52.02	-47.47	99.49	42.73	31.95	10.51	33.17	385	48	P	V
		5716.25	50.97	-58.78	109.75	41.6	32.03	10.52	33.18	385	48	P	V
		5722.5	52.23	-64.27	116.5	42.84	32.04	10.53	33.18	385	48	P	V
	*	5795	108.91	-	-	99.35	32.19	10.57	33.2	385	48	P	V
	*	5795	101.02	-	-	91.46	32.19	10.57	33.2	385	48	A	V
		5853.5	52.08	-62.14	114.22	42.4	32.31	10.59	33.22	385	48	P	V
		5856	53.44	-57.08	110.52	43.75	32.32	10.59	33.22	385	48	P	V
		5922	51.76	-18.65	70.41	41.85	32.54	10.62	33.25	385	48	P	V
		5929	50.79	-17.41	68.2	40.86	32.56	10.62	33.25	385	48	P	V
													V
													V
Remark	1. No other spurious found. 2. All results are PASS against Peak and Average limit line.												



Band 4 5725~5850MHz

WIFI 802.11ac VHT40 (Harmonic @ 3m)

WIFI Ant. 2	Note	Frequency (MHz)	Level (dBµV/m)	Over Limit (dB)	Limit Line (dBµV/m)	Read Level (dBµV)	Antenna Factor (dB/m)	Path Loss (dB)	Preamp Factor (dB)	Ant Pos (cm)	Table Pos (deg)	Peak Avg. (P/A)	Pol. (H/V)	
802.11ac VHT40 CH 151 5755MHz		11510	48.97	-25.03	74	52.73	39.67	17.51	60.94	100	0	P	H	
		17265	50.3	-17.9	68.2	47.93	40.6	22.09	60.32	100	0	P	H	
													H	
													H	
			11510	48.98	-25.02	74	52.74	39.67	17.51	60.94	100	0	P	V
			17265	49.51	-18.69	68.2	47.14	40.6	22.09	60.32	100	0	P	V
														V
														V
802.11ac VHT40 CH 159 5795MHz		11590	49.46	-24.54	74	53.41	39.43	17.63	61.01	100	0	P	H	
		17385	50.02	-18.18	68.2	47.14	41.12	22.2	60.44	100	0	P	H	
													H	
													H	
			11590	49.06	-24.94	74	53.01	39.43	17.63	61.01	100	0	P	V
			17385	50.8	-17.4	68.2	47.92	41.12	22.2	60.44	100	0	P	V
														V
														V
Remark	1. No other spurious found. 2. All results are PASS against Peak and Average limit line.													



Band 4 5725~5850MHz

WIFI 802.11ac VHT80 (Band Edge @ 3m)

WIFI Ant. 2	Note	Frequency (MHz)	Level (dBμV/m)	Over Limit (dB)	Limit Line (dBμV/m)	Read Level (dBμV)	Antenna Factor (dB/m)	Path Loss (dB)	Preamp Factor (dB)	Ant Pos (cm)	Table Pos (deg)	Peak Avg. (P/A)	Pol. (H/V)
		5646.75	49.89	-18.31	68.2	40.85	31.71	10.49	33.16	293	360	P	H
		5662.75	51.42	-26.25	77.67	42.31	31.78	10.49	33.16	293	360	P	H
		5719	55.11	-55.41	110.52	45.72	32.04	10.53	33.18	293	360	P	H
		5725	51.64	-70.56	122.2	42.24	32.05	10.53	33.18	293	360	P	H
	*	5775	100.51	-	-	91	32.15	10.56	33.2	293	360	P	H
	*	5775	92.18	-	-	82.67	32.15	10.56	33.2	293	360	A	H
		5853.25	51.42	-63.37	114.79	41.74	32.31	10.59	33.22	293	360	P	H
		5859.75	52.22	-57.25	109.47	42.52	32.34	10.59	33.23	293	360	P	H
		5881	50.2	-50.54	100.74	40.41	32.42	10.6	33.23	293	360	P	H
		5943	50.82	-17.38	68.2	40.85	32.59	10.63	33.25	293	360	P	H
802.11ac													H
VHT80													H
CH 155		5605.75	50.49	-17.71	68.2	41.38	31.79	10.46	33.14	391	68	P	V
5775MHz		5700	54.09	-51.11	105.2	44.75	32	10.51	33.17	391	68	P	V
		5713.25	57.8	-51.11	108.91	48.43	32.03	10.52	33.18	391	68	P	V
		5724	56.41	-63.51	119.92	47.01	32.05	10.53	33.18	391	68	P	V
	*	5775	105.29	-	-	95.78	32.15	10.56	33.2	391	68	P	V
	*	5775	97.63	-	-	88.12	32.15	10.56	33.2	391	68	A	V
		5850.5	53.68	-67.38	121.06	44.01	32.3	10.59	33.22	391	68	P	V
		5863.5	53.93	-54.49	108.42	44.21	32.35	10.6	33.23	391	68	P	V
		5879	52.87	-49.36	102.23	43.08	32.42	10.6	33.23	391	68	P	V
		5933.25	49.83	-18.37	68.2	39.89	32.57	10.62	33.25	391	68	P	V
													V
													V
Remark	1. No other spurious found. 2. All results are PASS against Peak and Average limit line.												



Band 4 5725~5850MHz

WIFI 802.11ac VHT80 (Harmonic @ 3m)

WIFI Ant. 2	Note	Frequency (MHz)	Level (dBμV/m)	Over Limit (dB)	Limit Line (dBμV/m)	Read Level (dBμV)	Antenna Factor (dB/m)	Path Loss (dB)	Preamp Factor (dB)	Ant Pos (cm)	Table Pos (deg)	Peak Avg. (P/A)	Pol. (H/V)	
802.11ac VHT80 CH 155 5775MHz		11550	48.4	-25.6	74	52.25	39.55	17.57	60.97	100	0	P	H	
		17325	49.08	-19.12	68.2	46.48	40.83	22.15	60.38	100	0	P	H	
													H	
													H	
			11550	47.94	-26.06	74	51.79	39.55	17.57	60.97	100	0	P	V
			17325	48.05	-20.15	68.2	45.45	40.83	22.15	60.38	100	0	P	V
														V
														V
Remark	1. No other spurious found. 2. All results are PASS against Peak and Average limit line.													



Emission below 1GHz

5GHz WIFI 802.11ac VHT20 (LF @ 3m)

WIFI	Note	Frequency	Level	Over	Limit	Read	Antenna	Path	Preamp	Ant	Table	Peak	Pol.	
Ant.				Limit	Line	Level	Factor	Loss	Factor	Pos	Pos	Avg.		
2		(MHz)	(dBμV/m)	(dB)	(dBμV/m)	(dBμV)	(dB/m)	(dB)	(dB)	(cm)	(deg)	(P/A)	(H/V)	
5GHz 802.11ac VHT 20 LF		40.67	29.2	-10.8	40	41.23	19.4	0.94	32.37	100	0	P	H	
		66.86	20.68	-19.32	40	39.85	12.06	1.12	32.35	-	-	P	H	
		116.33	24.3	-19.2	43.5	37.83	17.33	1.45	32.31	-	-	P	H	
		932.1	33.23	-12.77	46	30.16	29.83	4.29	31.05	-	-	P	H	
		946.65	33.6	-12.4	46	29.49	30.7	4.33	30.92	-	-	P	H	
		958.29	33.61	-12.39	46	28.93	31.13	4.36	30.81	-	-	P	H	
														H
														H
														H
														H
														H
														H
														H
														H
														H
			40.67	28.35	-11.65	40	40.38	19.4	0.94	32.37	101	13	QP	V
			54.25	24.13	-15.87	40	42.77	12.73	1	32.37	-	-	P	V
			63.95	22.95	-17.05	40	42.22	11.99	1.1	32.36	-	-	P	V
		939.86	33.29	-12.71	46	29.67	30.29	4.31	30.98	-	-	P	V	
		948.59	33.42	-12.58	46	29.16	30.82	4.34	30.9	-	-	P	V	
		957.32	34.54	-11.46	46	29.91	31.09	4.36	30.82	-	-	P	V	
													V	
													V	
													V	
													V	
													V	
													V	
													V	
Remark	1. No other spurious found. 2. All results are PASS against limit line.													



Band 4 - 5725~5850MHz

WIFI 802.11a (Band Edge @ 3m)

WIFI	Note	Frequency	Level	Over	Limit	Read	Antenna	Path	Preamp	Ant	Table	Peak	Pol.	
Ant.				Limit	Line	Level	Factor	Loss	Factor	Pos	Pos	Avg.		
1+2		(MHz)	(dBμV/m)	(dB)	(dBμV/m)	(dBμV)	(dB/m)	(dB)	(dB)	(cm)	(deg)	(P/A)	(H/V)	
802.11a CH 149 5745MHz		5627	51.73	-16.47	68.2	42.66	31.75	10.47	33.15	309	35	P	H	
		5691.4	54.76	-44.1	98.86	45.47	31.95	10.51	33.17	309	35	P	H	
		5717.2	58.1	-51.92	110.02	48.73	32.03	10.52	33.18	309	35	P	H	
		5724.4	64.05	-56.78	120.83	54.65	32.05	10.53	33.18	309	35	P	H	
	*	5745	116.4	-	-	106.96	32.09	10.54	33.19	309	35	P	H	
	*	5745	108.92	-	-	99.48	32.09	10.54	33.19	309	35	A	H	
														H
														H
			5602	50.06	-18.14	68.2	40.94	31.8	10.46	33.14	100	62	P	V
			5685.8	52.01	-42.71	94.72	42.76	31.91	10.51	33.17	100	62	P	V
			5719.4	55.17	-55.46	110.63	45.78	32.04	10.53	33.18	100	62	P	V
			5724.4	61.4	-59.43	120.83	52	32.05	10.53	33.18	100	62	P	V
	*		5745	111.51	-	-	102.07	32.09	10.54	33.19	100	62	P	V
	*		5745	104.23	-	-	94.79	32.09	10.54	33.19	100	62	A	V
														V
														V



WIFI Ant. 1+2	Note	Frequency (MHz)	Level (dBμV/m)	Over Limit (dB)	Limit Line (dBμV/m)	Read Level (dBμV)	Antenna Factor (dB/m)	Path Loss (dB)	Preamp Factor (dB)	Ant Pos (cm)	Table Pos (deg)	Peak Avg. (P/A)	Pol. (H/V)	
802.11a CH 157 5785MHz		5614.5	50	-18.2	68.2	40.91	31.77	10.47	33.15	305	37	P	H	
		5690.75	52.13	-46.25	98.38	42.85	31.94	10.51	33.17	305	37	P	H	
		5707	52.32	-54.84	107.16	42.97	32.01	10.52	33.18	305	37	P	H	
		5721.75	50.64	-64.15	114.79	41.25	32.04	10.53	33.18	305	37	P	H	
	*	5785	116.13	-	-	106.6	32.17	10.56	33.2	305	37	P	H	
	*	5785	108.79	-	-	99.26	32.17	10.56	33.2	305	37	A	H	
		5851.5	52.16	-66.62	118.78	42.48	32.31	10.59	33.22	305	37	P	H	
		5873.75	52.02	-53.53	105.55	42.25	32.4	10.6	33.23	305	37	P	H	
		5893.5	51.81	-39.66	91.47	41.97	32.47	10.61	33.24	305	37	P	H	
		5932.75	51.3	-16.9	68.2	41.36	32.57	10.62	33.25	305	37	P	H	
														H
														H
			5609.25	49.69	-18.51	68.2	40.58	31.78	10.47	33.14	100	62	P	V
			5664.25	49.69	-29.09	78.78	40.56	31.79	10.5	33.16	100	62	P	V
			5716.5	51.45	-58.37	109.82	42.08	32.03	10.52	33.18	100	62	P	V
			5721.75	50.25	-64.54	114.79	40.86	32.04	10.53	33.18	100	62	P	V
	*		5785	110.78	-	-	101.25	32.17	10.56	33.2	100	62	P	V
	*		5785	103.23	-	-	93.7	32.17	10.56	33.2	100	62	A	V
			5852	49.3	-68.34	117.64	39.62	32.31	10.59	33.22	100	62	P	V
			5870	51.3	-55.3	106.6	41.55	32.38	10.6	33.23	100	62	P	V
		5875	50.81	-54.39	105.2	41.04	32.4	10.6	33.23	100	62	P	V	
		5932.25	49.98	-18.22	68.2	40.05	32.56	10.62	33.25	100	62	P	V	
													V	
													V	



WiFi Ant. 1+2	Note	Frequency (MHz)	Level (dBµV/m)	Over Limit (dB)	Limit Line (dBµV/m)	Read Level (dBµV)	Antenna Factor (dB/m)	Path Loss (dB)	Preamp Factor (dB)	Ant Pos (cm)	Table Pos (deg)	Peak Avg. (P/A)	Pol. (H/V)	
802.11a CH 165 5825MHz	*	5825	115.74	-	-	106.12	32.25	10.58	33.21	302	38	P	H	
	*	5825	108.14	-	-	98.52	32.25	10.58	33.21	302	38	A	H	
		5851.2	56.87	-62.59	119.46	47.2	32.3	10.59	33.22	302	38	P	H	
		5855.4	56.5	-54.19	110.69	46.81	32.32	10.59	33.22	302	38	P	H	
		5876.2	55.5	-48.81	104.31	45.73	32.4	10.6	33.23	302	38	P	H	
		5945.4	52.06	-16.14	68.2	42.09	32.59	10.63	33.25	302	38	P	H	
														H
														H
	*	5825	109.7	-	-	100.08	32.25	10.58	33.21	100	62	P	V	
	*	5825	102.31	-	-	92.69	32.25	10.58	33.21	100	62	A	V	
		5851	54.74	-65.18	119.92	45.07	32.3	10.59	33.22	100	62	P	V	
		5865.6	52.12	-55.71	107.83	42.39	32.36	10.6	33.23	100	62	P	V	
		5876.6	53.98	-50.03	104.01	44.2	32.41	10.6	33.23	100	62	P	V	
		5936.8	50.64	-17.56	68.2	40.7	32.57	10.62	33.25	100	62	P	V	
														V
														V
														V
Remark	1. No other spurious found. 2. All results are PASS against Peak and Average limit line.													



Band 4 5725~5850MHz

WIFI 802.11a (Harmonic @ 3m)

WIFI Ant. 1+2	Note	Frequency (MHz)	Level (dBµV/m)	Over Limit (dB)	Limit Line (dBµV/m)	Read Level (dBµV)	Antenna Factor (dB/m)	Path Loss (dB)	Preamp Factor (dB)	Ant Pos (cm)	Table Pos (deg)	Peak Avg. (P/A)	Pol. (H/V)
802.11a CH 149 5745MHz		11490	48.94	-25.06	74	52.7	39.7	17.48	60.94	100	0	P	H
		17235	50.36	-17.84	68.2	48.09	40.51	22.06	60.3	100	0	P	H
													H
													H
		11490	49.7	-24.3	74	53.46	39.7	17.48	60.94	100	0	P	V
		17235	49.64	-18.56	68.2	47.37	40.51	22.06	60.3	100	0	P	V
													V
													V
802.11a CH 157 5785MHz		11570	49.33	-24.67	74	53.23	39.49	17.6	60.99	100	0	P	H
		17355	49.37	-18.83	68.2	46.62	40.98	22.18	60.41	100	0	P	H
													H
													H
		11570	49.66	-24.34	74	53.56	39.49	17.6	60.99	100	0	P	V
		17355	49.34	-18.86	68.2	46.59	40.98	22.18	60.41	100	0	P	V
													V
													V
802.11a CH 165 5825MHz		11650	47.38	-26.62	74	53.96	39.2	17.72	63.5	100	0	P	H
		17475	49.4	-18.8	68.2	46.87	41.58	22.28	61.33	100	0	P	H
													H
													H
		11650	46.77	-27.23	74	53.35	39.2	17.72	63.5	100	0	P	V
		17475	49.65	-18.55	68.2	47.12	41.58	22.28	61.33	100	0	P	V
													V
													V
Remark	1. No other spurious found. 2. All results are PASS against Peak and Average limit line.												



Band 4 5725~5850MHz

WIFI 802.11ac VHT20 (Band Edge @ 3m)

WIFI Ant. 1+2	Note	Frequency (MHz)	Level (dBμV/m)	Over Limit (dB)	Limit Line (dBμV/m)	Read Level (dBμV)	Antenna Factor (dB/m)	Path Loss (dB)	Preamp Factor (dB)	Ant Pos (cm)	Table Pos (deg)	Peak Avg. (P/A)	Pol. (H/V)	
802.11ac VHT20 CH 149 5745MHz		5617.4	52.4	-15.8	68.2	43.31	31.77	10.47	33.15	295	37	P	H	
		5699.6	57.52	-47.39	104.91	48.18	32	10.51	33.17	295	37	P	H	
		5720	63.43	-47.37	110.8	54.04	32.04	10.53	33.18	295	37	P	H	
		5725	67.61	-54.59	122.2	58.21	32.05	10.53	33.18	295	37	P	H	
	*	5745	116.7	-	-	107.26	32.09	10.54	33.19	295	37	P	H	
	*	5745	108.29	-	-	98.85	32.09	10.54	33.19	295	37	A	H	
														H
														H
			5645.4	49.67	-18.53	68.2	40.64	31.71	10.48	33.16	100	61	P	V
			5685.6	53.97	-40.61	94.58	44.72	31.91	10.51	33.17	100	61	P	V
			5718.4	56.77	-53.58	110.35	47.38	32.04	10.53	33.18	100	61	P	V
			5725	65.58	-56.62	122.2	56.18	32.05	10.53	33.18	100	61	P	V
	*		5745	111.99	-	-	102.55	32.09	10.54	33.19	100	61	P	V
	*		5745	104.47	-	-	95.03	32.09	10.54	33.19	100	61	A	V
													V	
													V	



WIFI Ant. 1+2	Note	Frequency (MHz)	Level (dBµV/m)	Over Limit (dB)	Limit Line (dBµV/m)	Read Level (dBµV)	Antenna Factor (dB/m)	Path Loss (dB)	Preamp Factor (dB)	Ant Pos (cm)	Table Pos (deg)	Peak Avg. (P/A)	Pol. (H/V)
		5631.25	50.22	-17.98	68.2	41.15	31.74	10.48	33.15	291	39	P	H
		5700	51.3	-53.9	105.2	41.96	32	10.51	33.17	291	39	P	H
		5708	55.08	-52.36	107.44	45.72	32.02	10.52	33.18	291	39	P	H
		5722.25	52.48	-63.45	115.93	43.09	32.04	10.53	33.18	291	39	P	H
	*	5785	115.28	-	-	105.75	32.17	10.56	33.2	291	39	P	H
	*	5785	107.47	-	-	97.94	32.17	10.56	33.2	291	39	A	H
		5852.25	53.18	-63.89	117.07	43.5	32.31	10.59	33.22	291	39	P	H
		5868.75	53.07	-53.88	106.95	43.32	32.38	10.6	33.23	291	39	P	H
		5914	52.15	-24.16	76.31	42.24	32.53	10.62	33.24	291	39	P	H
		5936.25	51.04	-17.16	68.2	41.1	32.57	10.62	33.25	291	39	P	H
802.11ac													H
VHT20													H
CH 157		5615.25	49.69	-18.51	68.2	40.6	31.77	10.47	33.15	106	62	P	V
5785MHz		5664	49.93	-28.66	78.59	40.81	31.78	10.5	33.16	106	62	P	V
		5705.75	50.51	-56.3	106.81	41.16	32.01	10.52	33.18	106	62	P	V
		5724.5	51.47	-69.59	121.06	42.07	32.05	10.53	33.18	106	62	P	V
	*	5785	110.63	-	-	101.1	32.17	10.56	33.2	106	62	P	V
	*	5785	103.35	-	-	93.82	32.17	10.56	33.2	106	62	A	V
		5853.75	50.32	-63.33	113.65	40.64	32.31	10.59	33.22	106	62	P	V
		5866.75	51.26	-56.25	107.51	41.52	32.37	10.6	33.23	106	62	P	V
		5881.75	50.89	-49.3	100.19	41.09	32.43	10.6	33.23	106	62	P	V
		5937.25	50.6	-17.6	68.2	40.66	32.57	10.62	33.25	106	62	P	V
													V
													V



WiFi Ant. 1+2	Note	Frequency (MHz)	Level (dBμV/m)	Over Limit (dB)	Limit Line (dBμV/m)	Read Level (dBμV)	Antenna Factor (dB/m)	Path Loss (dB)	Preamp Factor (dB)	Ant Pos (cm)	Table Pos (deg)	Peak Avg. (P/A)	Pol. (H/V)	
802.11ac VHT20 CH 165 5825MHz	*	5825	115.08	-	-	105.46	32.25	10.58	33.21	300	37	P	H	
	*	5825	107.17	-	-	97.55	32.25	10.58	33.21	300	37	A	H	
		5850.2	59.5	-62.24	121.74	49.83	32.3	10.59	33.22	300	37	P	H	
		5860.6	57.92	-51.31	109.23	48.22	32.34	10.59	33.23	300	37	P	H	
		5878	54.87	-48.1	102.97	45.09	32.41	10.6	33.23	300	37	P	H	
		5948.8	51.36	-16.84	68.2	41.38	32.6	10.63	33.25	300	37	P	H	
														H
														H
	*	5825	108.52	-	-	98.9	32.25	10.58	33.21	100	60	P	V	
	*	5825	101.04	-	-	91.42	32.25	10.58	33.21	100	60	A	V	
		5853.2	53.01	-61.89	114.9	43.33	32.31	10.59	33.22	100	60	P	V	
		5860.2	55.05	-54.29	109.34	45.35	32.34	10.59	33.23	100	60	P	V	
		5884.8	51.24	-46.68	97.92	41.43	32.44	10.6	33.23	100	60	P	V	
		5925	50.16	-18.04	68.2	40.24	32.55	10.62	33.25	100	60	P	V	
														V
													V	
Remark	1. No other spurious found. 2. All results are PASS against Peak and Average limit line.													



Band 4 5725~5850MHz

WIFI 802.11ac VHT20 (Harmonic @ 3m)

WIFI Ant. 1+2	Note	Frequency (MHz)	Level (dBµV/m)	Over Limit (dB)	Limit Line (dBµV/m)	Read Level (dBµV)	Antenna Factor (dB/m)	Path Loss (dB)	Preamp Factor (dB)	Ant Pos (cm)	Table Pos (deg)	Peak Avg. (P/A)	Pol. (H/V)	
802.11ac VHT20 CH 149 5745MHz		11490	48	-26	74	54.32	39.7	17.48	63.5	100	0	P	H	
		17235	48.02	-20.18	68.2	47.12	40.51	22.06	61.67	100	0	P	H	
													H	
													H	
			11490	46.98	-27.02	74	53.3	39.7	17.48	63.5	100	0	P	V
			17235	47.88	-20.32	68.2	46.98	40.51	22.06	61.67	100	0	P	V
														V
802.11ac VHT20 CH 157 5785MHz		11570	47.19	-26.81	74	53.6	39.49	17.6	63.5	100	0	P	H	
		17355	48.18	-20.02	68.2	46.52	40.98	22.18	61.5	100	0	P	H	
													H	
													H	
			11570	46.93	-27.07	74	53.34	39.49	17.6	63.5	100	0	P	V
			17355	48.27	-19.93	68.2	46.61	40.98	22.18	61.5	100	0	P	V
														V
802.11ac VHT20 CH 165 5825MHz		11650	46.86	-27.14	74	53.44	39.2	17.72	63.5	100	0	P	H	
		17475	50.14	-18.06	68.2	47.61	41.58	22.28	61.33	100	0	P	H	
													H	
													H	
			11650	47.35	-26.65	74	53.93	39.2	17.72	63.5	100	0	P	V
			17475	49.64	-18.56	68.2	47.11	41.58	22.28	61.33	100	0	P	V
														V
Remark	1.	No other spurious found.												
	2.	All results are PASS against Peak and Average limit line.												



Band 4 5725~5850MHz

WIFI 802.11ac VHT40 (Band Edge @ 3m)

WIFI Ant. 1+2	Note	Frequency (MHz)	Level (dBμV/m)	Over Limit (dB)	Limit Line (dBμV/m)	Read Level (dBμV)	Antenna Factor (dB/m)	Path Loss (dB)	Preamp Factor (dB)	Ant Pos (cm)	Table Pos (deg)	Peak Avg. (P/A)	Pol. (H/V)
		5646.25	52.11	-16.09	68.2	43.07	31.71	10.49	33.16	309	35	P	H
		5699.5	56.86	-47.97	104.83	47.52	32	10.51	33.17	309	35	P	H
		5715	67.89	-41.51	109.4	58.52	32.03	10.52	33.18	309	35	P	H
		5722.5	68.46	-48.04	116.5	59.07	32.04	10.53	33.18	309	35	P	H
	*	5755	113.04	-	-	103.57	32.11	10.55	33.19	309	35	P	H
	*	5755	105.68	-	-	96.21	32.11	10.55	33.19	309	35	A	H
		5851.75	51.42	-66.79	118.21	41.74	32.31	10.59	33.22	309	35	P	H
		5866.75	51.46	-56.05	107.51	41.72	32.37	10.6	33.23	309	35	P	H
		5892.75	51.64	-40.39	92.03	41.8	32.47	10.61	33.24	309	35	P	H
		5926.25	51.33	-16.87	68.2	41.41	32.55	10.62	33.25	309	35	P	H
													H
													H
802.11ac VHT40 CH 151 5755MHz		5644.5	50.09	-18.11	68.2	41.06	31.71	10.48	33.16	100	62	P	V
		5697.25	54.21	-48.96	103.17	44.89	31.98	10.51	33.17	100	62	P	V
		5717	63.8	-46.16	109.96	54.43	32.03	10.52	33.18	100	62	P	V
		5723	64.85	-52.79	117.64	55.45	32.05	10.53	33.18	100	62	P	V
	*	5755	108.77	-	-	99.3	32.11	10.55	33.19	100	62	P	V
	*	5755	101.18	-	-	91.71	32.11	10.55	33.19	100	62	A	V
		5851.5	52.37	-66.41	118.78	42.69	32.31	10.59	33.22	100	62	P	V
		5860.25	52.83	-56.5	109.33	43.13	32.34	10.59	33.23	100	62	P	V
		5901	51.02	-34.9	85.92	41.15	32.5	10.61	33.24	100	62	P	V
		5936.25	51.39	-16.81	68.2	41.45	32.57	10.62	33.25	100	62	P	V
													V
													V



WIFI Ant. 1+2	Note	Frequency (MHz)	Level (dBμV/m)	Over Limit (dB)	Limit Line (dBμV/m)	Read Level (dBμV)	Antenna Factor (dB/m)	Path Loss (dB)	Preamp Factor (dB)	Ant Pos (cm)	Table Pos (deg)	Peak Avg. (P/A)	Pol. (H/V)
		5644.75	50.22	-17.98	68.2	41.19	31.71	10.48	33.16	317	38	P	H
		5699.75	53.98	-51.04	105.02	44.64	32	10.51	33.17	317	38	P	H
		5715.25	53.89	-55.58	109.47	44.52	32.03	10.52	33.18	317	38	P	H
		5723.75	53.92	-65.43	119.35	44.52	32.05	10.53	33.18	317	38	P	H
	*	5795	113.32	-	-	103.76	32.19	10.57	33.2	317	38	P	H
	*	5795	105.33	-	-	95.77	32.19	10.57	33.2	317	38	A	H
		5851	58.07	-61.85	119.92	48.4	32.3	10.59	33.22	317	38	P	H
		5856.75	56.22	-54.09	110.31	46.52	32.33	10.59	33.22	317	38	P	H
		5875.5	54.13	-50.7	104.83	44.36	32.4	10.6	33.23	317	38	P	H
		5948.5	52.26	-15.94	68.2	42.28	32.6	10.63	33.25	317	38	P	H
802.11ac													H
VHT40													H
CH 159		5627.75	49.66	-18.54	68.2	40.59	31.74	10.48	33.15	100	88	P	V
5795MHz		5694.75	49.57	-51.76	101.33	40.26	31.97	10.51	33.17	100	88	P	V
		5706	51.48	-55.4	106.88	42.13	32.01	10.52	33.18	100	88	P	V
		5723.5	51.12	-67.66	118.78	41.72	32.05	10.53	33.18	100	88	P	V
	*	5795	105.55	-	-	95.99	32.19	10.57	33.2	100	88	P	V
	*	5795	98.18	-	-	88.62	32.19	10.57	33.2	100	88	A	V
		5853.75	51.87	-61.78	113.65	42.19	32.31	10.59	33.22	100	88	P	V
		5862.25	51.49	-57.28	108.77	41.78	32.35	10.59	33.23	100	88	P	V
		5875.5	50.87	-53.96	104.83	41.1	32.4	10.6	33.23	100	88	P	V
		5935.5	49.73	-18.47	68.2	39.79	32.57	10.62	33.25	100	88	P	V
													V
													V
Remark	1. No other spurious found. 2. All results are PASS against Peak and Average limit line.												



Band 4 5725~5850MHz

WIFI 802.11ac VHT40 (Harmonic @ 3m)

WIFI Ant. 1+2	Note	Frequency (MHz)	Level (dBμV/m)	Over Limit (dB)	Limit Line (dBμV/m)	Read Level (dBμV)	Antenna Factor (dB/m)	Path Loss (dB)	Preamp Factor (dB)	Ant Pos (cm)	Table Pos (deg)	Peak Avg. (P/A)	Pol. (H/V)	
802.11ac VHT40 CH 151 5755MHz		11510	46.48	-27.52	74	52.8	39.67	17.51	63.5	100	0	P	H	
		17265	49.21	-18.99	68.2	48.15	40.6	22.09	61.63	100	0	P	H	
													H	
													H	
			11510	47.93	-26.07	74	54.25	39.67	17.51	63.5	100	0	P	V
			17265	48.25	-19.95	68.2	47.19	40.6	22.09	61.63	100	0	P	V
														V
														V
802.11ac VHT40 CH 159 5795MHz		11590	46.91	-27.09	74	53.35	39.43	17.63	63.5	100	0	P	H	
		17385	48.24	-19.96	68.2	46.38	41.12	22.2	61.46	100	0	P	H	
													H	
													H	
			11590	47.18	-26.82	74	53.62	39.43	17.63	63.5	100	0	P	V
			17385	49.65	-18.55	68.2	47.79	41.12	22.2	61.46	100	0	P	V
														V
														V
Remark	1. No other spurious found. 2. All results are PASS against Peak and Average limit line.													



Band 4 5725~5850MHz

WIFI 802.11ac VHT80 (Band Edge @ 3m)

WIFI Ant. 1+2	Note	Frequency (MHz)	Level (dBμV/m)	Over Limit (dB)	Limit Line (dBμV/m)	Read Level (dBμV)	Antenna Factor (dB/m)	Path Loss (dB)	Preamp Factor (dB)	Ant Pos (cm)	Table Pos (deg)	Peak Avg. (P/A)	Pol. (H/V)
		5643	51.72	-16.48	68.2	42.69	31.71	10.48	33.16	154	328	P	H
		5699.75	64.72	-40.3	105.02	55.38	32	10.51	33.17	154	328	P	H
		5704.5	66.29	-40.17	106.46	56.94	32.01	10.52	33.18	154	328	P	H
		5722	67.11	-48.25	115.36	57.72	32.04	10.53	33.18	154	328	P	H
	*	5775	109.32	-	-	99.81	32.15	10.56	33.2	154	328	P	H
	*	5775	101.66	-	-	92.15	32.15	10.56	33.2	154	328	A	H
		5855	62.65	-48.15	110.8	52.96	32.32	10.59	33.22	154	328	P	H
		5859.5	66.43	-43.11	109.54	56.73	32.34	10.59	33.23	154	328	P	H
		5881.5	60.76	-39.61	100.37	50.96	32.43	10.6	33.23	154	328	P	H
		5936.5	52.34	-15.86	68.2	42.4	32.57	10.62	33.25	154	328	P	H
802.11ac													H
VHT80													H
CH 155		5645.25	50.87	-17.33	68.2	41.84	31.71	10.48	33.16	400	275	P	V
5775MHz		5697.5	57.73	-45.63	103.36	48.4	31.99	10.51	33.17	400	275	P	V
		5717.25	60.43	-49.6	110.03	51.06	32.03	10.52	33.18	400	275	P	V
		5724	60.55	-59.37	119.92	51.15	32.05	10.53	33.18	400	275	P	V
	*	5775	106.76	-	-	97.25	32.15	10.56	33.2	400	275	P	V
	*	5775	99.06	-	-	89.55	32.15	10.56	33.2	400	275	A	V
		5851.25	57.46	-61.89	119.35	47.78	32.31	10.59	33.22	400	275	P	V
		5859.75	59	-50.47	109.47	49.3	32.34	10.59	33.23	400	275	P	V
		5882.5	51.92	-47.71	99.63	42.12	32.43	10.6	33.23	400	275	P	V
		5929.75	50.57	-17.63	68.2	40.64	32.56	10.62	33.25	400	275	P	V
													V
													V
Remark	1. No other spurious found. 2. All results are PASS against Peak and Average limit line.												



Band 4 5725~5850MHz

WIFI 802.11ac VHT80 (Harmonic @ 3m)

WIFI Ant. 1+2	Note	Frequency (MHz)	Level (dBμV/m)	Over Limit (dB)	Limit Line (dBμV/m)	Read Level (dBμV)	Antenna Factor (dB/m)	Path Loss (dB)	Preamp Factor (dB)	Ant Pos (cm)	Table Pos (deg)	Peak Avg. (P/A)	Pol. (H/V)	
802.11ac VHT80 CH 155 5775MHz		11550	47.65	-26.35	74	51.5	39.55	17.57	60.97	100	0	P	H	
		17325	49.21	-18.99	68.2	46.61	40.83	22.15	60.38	100	0	P	H	
													H	
													H	
			11550	48.12	-25.88	74	51.97	39.55	17.57	60.97	100	0	P	V
			17325	48.88	-19.32	68.2	46.28	40.83	22.15	60.38	100	0	P	V
														V
														V
Remark	1. No other spurious found. 2. All results are PASS against Peak and Average limit line.													



Emission below 1GHz

5GHz WIFI 802.11ac VHT20 (LF @ 3m)

WIFI	Note	Frequency	Level	Over	Limit	Read	Antenna	Path	Preamp	Ant	Table	Peak	Pol.	
Ant.				Limit	Line	Level	Factor	Loss	Factor	Pos	Pos	Avg.		
1+2		(MHz)	(dBμV/m)	(dB)	(dBμV/m)	(dBμV)	(dB/m)	(dB)	(dB)	(cm)	(deg)	(P/A)	(H/V)	
5GHz 802.11ac VHT20 LF		40.67	30.4	-9.6	40	42.43	19.4	0.94	32.37	100	0	P	H	
		67.83	21.25	-18.75	40	40.11	12.35	1.14	32.35	-	-	P	H	
		76.56	21.93	-18.07	40	40.06	13	1.21	32.34	-	-	P	H	
		934.04	32.81	-13.19	46	29.61	29.94	4.3	31.04	-	-	P	H	
		942.77	33.85	-12.15	46	30.01	30.47	4.33	30.96	-	-	P	H	
		956.35	35.17	-10.83	46	30.6	31.05	4.35	30.83	-	-	P	H	
													H	
													H	
													H	
													H	
													H	
													H	
			40.67	28.82	-11.18	40	40.85	19.4	0.94	32.37	102	14	QP	V
			54.25	23.95	-16.05	40	42.59	12.73	1	32.37	-	-	P	V
			63.95	22.74	-17.26	40	42.01	11.99	1.1	32.36	-	-	P	V
			909.79	32.77	-13.23	46	30.5	29.29	4.24	31.26	-	-	P	V
			923.37	32.93	-13.07	46	30.22	29.57	4.27	31.13	-	-	P	V
			943.74	34.04	-11.96	46	30.14	30.52	4.33	30.95	-	-	P	V
													V	
													V	
													V	
													V	
													V	
													V	
Remark	1. No other spurious found. 2. All results are PASS against limit line.													



<For SKU2>

Band 4 - 5725~5850MHz

WIFI 802.11ac VHT80 (Band Edge @ 3m)

WIFI Ant. 1	Note	Frequency (MHz)	Level (dBμV/m)	Over Limit (dB)	Limit Line (dBμV/m)	Read Level (dBμV)	Antenna Factor (dB/m)	Path Loss (dB)	Preamp Factor (dB)	Ant Pos (cm)	Table Pos (deg)	Peak Avg. (P/A)	Pol. (H/V)
		5618	49.97	-18.23	68.2	40.89	31.76	10.47	33.15	250	102	P	H
		5699	50.84	-53.62	104.46	41.51	31.99	10.51	33.17	250	102	P	H
		5715.5	54.01	-55.53	109.54	44.64	32.03	10.52	33.18	250	102	P	H
		5722	52.86	-62.5	115.36	43.47	32.04	10.53	33.18	250	102	P	H
	*	5775	102.71	-	-	93.2	32.15	10.56	33.2	250	102	P	H
	*	5775	94.87	-	-	85.36	32.15	10.56	33.2	250	102	A	H
		5852.5	56.97	-59.53	116.5	47.29	32.31	10.59	33.22	250	102	P	H
		5856.25	55.31	-55.14	110.45	45.61	32.33	10.59	33.22	250	102	P	H
		5879.25	51.97	-50.07	102.04	42.18	32.42	10.6	33.23	250	102	P	H
		5930.75	49.19	-19.01	68.2	39.26	32.56	10.62	33.25	250	102	P	H
802.11ac													H
VHT80													H
CH 155		5647	50.39	-17.81	68.2	41.35	31.71	10.49	33.16	400	61	P	V
5775MHz		5688.5	56.84	-39.88	96.72	47.57	31.93	10.51	33.17	400	61	P	V
		5719.5	57.9	-52.76	110.66	48.51	32.04	10.53	33.18	400	61	P	V
		5720.5	57.59	-54.35	111.94	48.2	32.04	10.53	33.18	400	61	P	V
	*	5775	107.5	-	-	97.99	32.15	10.56	33.2	400	61	P	V
	*	5775	99.26	-	-	89.75	32.15	10.56	33.2	400	61	A	V
		5854	59	-54.08	113.08	49.31	32.32	10.59	33.22	400	61	P	V
		5858.25	58.61	-51.28	109.89	48.91	32.33	10.59	33.22	400	61	P	V
		5876.5	53.18	-50.91	104.09	43.4	32.41	10.6	33.23	400	61	P	V
		5926.5	53.15	-15.05	68.2	43.23	32.55	10.62	33.25	400	61	P	V
													V
													V
Remark	1. No other spurious found. 2. All results are PASS against Peak and Average limit line.												



Band 4 5725~5850MHz

WIFI 802.11ac VHT80 (Harmonic @ 3m)

WIFI Ant. 1	Note	Frequency (MHz)	Level (dBμV/m)	Over Limit (dB)	Limit Line (dBμV/m)	Read Level (dBμV)	Antenna Factor (dB/m)	Path Loss (dB)	Preamp Factor (dB)	Ant Pos (cm)	Table Pos (deg)	Peak Avg. (P/A)	Pol. (H/V)	
802.11ac VHT80 CH 155 5775MHz		11550	48.62	-25.38	74	52.47	39.55	17.57	60.97	100	0	P	H	
		17325	49.06	-19.14	68.2	46.46	40.83	22.15	60.38	100	0	P	H	
													H	
													H	
			11550	48.37	-25.63	74	52.22	39.55	17.57	60.97	100	0	P	V
			17325	48.22	-19.98	68.2	45.62	40.83	22.15	60.38	100	0	P	V
														V
														V
Remark	1. No other spurious found. 2. All results are PASS against Peak and Average limit line.													



Emission below 1GHz

5GHz WIFI 802.11ac VHT80 (LF @ 3m)

WIFI	Note	Frequency	Level	Over	Limit	Read	Antenna	Path	Preamp	Ant	Table	Peak	Pol.	
Ant.				Limit	Line	Level	Factor	Loss	Factor	Pos	Pos	Avg.		
1		(MHz)	(dBμV/m)	(dB)	(dBμV/m)	(dBμV)	(dB/m)	(dB)	(dB)	(cm)	(deg)	(P/A)	(H/V)	
5GHz 802.11ac VHT80 LF		40.67	28.97	-11.03	40	41	19.4	0.94	32.37	100	0	P	H	
		65.89	22.42	-17.58	40	41.83	11.82	1.12	32.35	-	-	P	H	
		114.39	24.82	-18.68	43.5	38.39	17.3	1.44	32.31	-	-	P	H	
		940.83	33.25	-12.75	46	29.56	30.35	4.31	30.97	-	-	P	H	
		948.59	33.65	-12.35	46	29.39	30.82	4.34	30.9	-	-	P	H	
		958.29	33.92	-12.08	46	29.24	31.13	4.36	30.81	-	-	P	H	
														H
														H
														H
														H
														H
														H
														H
														H
														H
			40.67	28.82	-11.18	40	40.85	19.4	0.94	32.37	100	23	QP	V
			54.25	24.35	-15.65	40	42.99	12.73	1	32.37	-	-	P	V
			82.38	21.59	-18.41	40	38.9	13.78	1.25	32.34	-	-	P	V
		880.69	32.78	-13.22	46	31.08	28.99	4.16	31.45	-	-	P	V	
		939.86	34.03	-11.97	46	30.41	30.29	4.31	30.98	-	-	P	V	
		960	34.38	-11.62	46	29.61	31.2	4.37	30.8	-	-	P	V	
													V	
													V	
													V	
													V	
													V	
													V	
Remark	1. No other spurious found. 2. All results are PASS against limit line.													



<For SKU3>

Band 4 - 5725~5850MHz

WIFI 802.11ac VHT80 (Band Edge @ 3m)

WIFI	Note	Frequency	Level	Over	Limit	Read	Antenna	Path	Preamp	Ant	Table	Peak	Pol.	
Ant.				Limit	Line	Level	Factor	Loss	Factor	Pos	Pos	Avg.		
1		(MHz)	(dBμV/m)	(dB)	(dBμV/m)	(dBμV)	(dB/m)	(dB)	(dB)	(cm)	(deg)	(P/A)	(H/V)	
802.11ac VHT80 CH 155 5775MHz		5617.5	49.56	-18.64	68.2	40.48	31.76	10.47	33.15	250	100	P	H	
		5699	53.09	-51.37	104.46	43.76	31.99	10.51	33.17	250	100	P	H	
		5715	54.15	-55.25	109.4	44.78	32.03	10.52	33.18	250	100	P	H	
		5724	54.23	-65.69	119.92	44.83	32.05	10.53	33.18	250	100	P	H	
	*	5775	102.9	-	-	93.39	32.15	10.56	33.2	250	100	P	H	
	*	5775	95.22	-	-	85.71	32.15	10.56	33.2	250	100	A	H	
		5853	58.41	-56.95	115.36	48.73	32.31	10.59	33.22	250	100	P	H	
		5855	57.08	-53.72	110.8	47.39	32.32	10.59	33.22	250	100	P	H	
		5876.75	53.57	-50.33	103.9	43.79	32.41	10.6	33.23	250	100	P	H	
		5946.25	51.36	-16.84	68.2	41.39	32.59	10.63	33.25	250	100	P	H	
														H
														H
		5630	50.54	-17.66	68.2	41.47	31.74	10.48	33.15	400	63	P	V	
		5696.25	56.34	-46.1	102.44	47.02	31.98	10.51	33.17	400	63	P	V	
		5715.75	60	-49.61	109.61	50.63	32.03	10.52	33.18	400	63	P	V	
		5725	58.55	-63.65	122.2	49.15	32.05	10.53	33.18	400	63	P	V	
	*	5775	108.03	-	-	98.52	32.15	10.56	33.2	400	63	P	V	
	*	5775	100.51	-	-	91	32.15	10.56	33.2	400	63	A	V	
		5852.25	58.95	-58.12	117.07	49.27	32.31	10.59	33.22	400	63	P	V	
		5856.5	59.87	-50.51	110.38	50.17	32.33	10.59	33.22	400	63	P	V	
	5880.75	53.31	-47.62	100.93	43.52	32.42	10.6	33.23	400	63	P	V		
	5939	52.19	-16.01	68.2	42.23	32.58	10.63	33.25	400	63	P	V		
													V	
													V	
Remark	1. No other spurious found. 2. All results are PASS against Peak and Average limit line.													



Band 4 5725~5850MHz

WIFI 802.11ac VHT80 (Harmonic @ 3m)

WIFI Ant. 1	Note	Frequency (MHz)	Level (dBμV/m)	Over Limit (dB)	Limit Line (dBμV/m)	Read Level (dBμV)	Antenna Factor (dB/m)	Path Loss (dB)	Preamp Factor (dB)	Ant Pos (cm)	Table Pos (deg)	Peak Avg. (P/A)	Pol. (H/V)	
802.11ac VHT80 CH 155 5775MHz		11550	47.47	-26.53	74	51.32	39.55	17.57	60.97	100	0	P	H	
		17325	48.18	-20.02	68.2	45.58	40.83	22.15	60.38	100	0	P	H	
													H	
													H	
			11550	47.36	-26.64	74	51.21	39.55	17.57	60.97	100	0	P	V
			17325	48.43	-19.77	68.2	45.83	40.83	22.15	60.38	100	0	P	V
														V
														V
Remark	1. No other spurious found. 2. All results are PASS against Peak and Average limit line.													



Emission below 1GHz

5GHz WIFI 802.11ac VHT80 (LF @ 3m)

WIFI	Note	Frequency	Level	Over	Limit	Read	Antenna	Path	Preamp	Ant	Table	Peak	Pol.
Ant.				Limit	Line	Level	Factor	Loss	Factor	Pos	Pos	Avg.	
1		(MHz)	(dBµV/m)	(dB)	(dBµV/m)	(dBµV)	(dB/m)	(dB)	(dB)	(cm)	(deg)	(P/A)	(H/V)
5GHz 802.11ac VHT80 LF		40.67	26.76	-13.24	40	38.79	19.4	0.94	32.37	-	-	P	H
		63.95	19.7	-20.3	40	38.97	11.99	1.1	32.36	-	-	P	H
		113.42	23.35	-20.15	43.5	36.98	17.24	1.44	32.31	-	-	P	H
		932.1	32.99	-13.01	46	29.92	29.83	4.29	31.05	-	-	P	H
		946.65	33.84	-12.16	46	29.73	30.7	4.33	30.92	-	-	P	H
		958.29	34.08	-11.92	46	29.4	31.13	4.36	30.81	100	0	P	H
													H
													H
													H
													H
													H
													H
													H
													H
													H
													H
													H
			40.67	28.22	-11.78	40	40.25	19.4	0.94	32.37	100	21	QP
		48.43	25.61	-14.39	40	41.9	15.14	0.94	32.37	-	-	P	V
		63.95	21.48	-18.52	40	40.75	11.99	1.1	32.36	-	-	P	V
		925.31	32.7	-13.3	46	29.93	29.61	4.28	31.12	-	-	P	V
		943.74	33.31	-12.69	46	29.41	30.52	4.33	30.95	-	-	P	V
		956.35	34.2	-11.8	46	29.63	31.05	4.35	30.83	-	-	P	V
													V
													V
													V
													V
													V
													V
													V
Remark	1. No other spurious found. 2. All results are PASS against limit line.												



<TXBF Mode>

Band 4 - 5725~5850MHz

WIFI 802.11ac VHT20 (Band Edge @ 3m)

WIFI	Note	Frequency	Level	Over	Limit	Read	Antenna	Path	Preamp	Ant	Table	Peak	Pol.	
Ant.				Limit	Line	Level	Factor	Loss	Factor	Pos	Pos	Avg.		
1+2		(MHz)	(dBµV/m)	(dB)	(dBµV/m)	(dBµV)	(dB/m)	(dB)	(dB)	(cm)	(deg)	(P/A)	(H/V)	
802.11ac VHT20 CH 149 5745MHz		5626.25	49.57	-18.63	68.2	40.55	31.7	10.47	33.15	320	35	P	H	
		5699.5	50.18	-54.65	104.83	41.04	31.8	10.51	33.17	320	35	P	H	
		5719.25	52.86	-57.73	110.59	43.63	31.88	10.53	33.18	320	35	P	H	
		5725	60.74	-61.46	122.2	51.49	31.9	10.53	33.18	320	35	P	H	
	*	5745	112.95	-	-	103.62	31.98	10.54	33.19	320	35	P	H	
	*	5745	104.04	-	-	94.71	31.98	10.54	33.19	320	35	A	H	
														H
														H
			5642	49.58	-18.62	68.2	40.56	31.7	10.48	33.16	378	271	P	V
			5651.25	49.08	-20.05	69.13	40.05	31.7	10.49	33.16	378	271	P	V
			5719.75	51.03	-59.7	110.73	41.8	31.88	10.53	33.18	378	271	P	V
			5725	53.88	-68.32	122.2	44.63	31.9	10.53	33.18	378	271	P	V
	*		5745	109.46	-	-	100.13	31.98	10.54	33.19	378	271	P	V
	*		5745	100.31	-	-	90.98	31.98	10.54	33.19	378	271	A	V
													V	
													V	



WIFI Ant. 1+2	Note	Frequency (MHz)	Level (dBµV/m)	Over Limit (dB)	Limit Line (dBµV/m)	Read Level (dBµV)	Antenna Factor (dB/m)	Path Loss (dB)	Preamp Factor (dB)	Ant Pos (cm)	Table Pos (deg)	Peak Avg. (P/A)	Pol. (H/V)
		5640.75	49.96	-18.24	68.2	40.94	31.7	10.48	33.16	300	33	P	H
		5699.5	50.34	-54.49	104.83	41.2	31.8	10.51	33.17	300	33	P	H
		5704.5	50.82	-55.64	106.46	41.66	31.82	10.52	33.18	300	33	P	H
		5723.75	50.64	-68.71	119.35	41.39	31.9	10.53	33.18	300	33	P	H
	*	5785	113.57	-	-	104.14	32.07	10.56	33.2	300	33	P	H
	*	5785	104.07	-	-	94.64	32.07	10.56	33.2	300	33	A	H
		5853	51.66	-63.7	115.36	42.18	32.11	10.59	33.22	300	33	P	H
		5865.5	52.44	-55.42	107.86	42.94	32.13	10.6	33.23	300	33	P	H
		5877	51.07	-52.64	103.71	41.55	32.15	10.6	33.23	300	33	P	H
		5949	50.96	-17.24	68.2	41.18	32.4	10.63	33.25	300	33	P	H
802.11ac													H
VHT20													H
CH 157		5610.25	48.52	-19.68	68.2	39.5	31.7	10.47	33.15	400	280	P	V
5785MHz		5697.5	48.67	-54.69	103.36	39.53	31.8	10.51	33.17	400	280	P	V
		5713.75	49.02	-60.03	109.05	39.83	31.85	10.52	33.18	400	280	P	V
		5723.75	49.85	-69.5	119.35	40.6	31.9	10.53	33.18	400	280	P	V
	*	5785	111.68	-	-	102.25	32.07	10.56	33.2	400	280	P	V
	*	5785	101.69	-	-	92.26	32.07	10.56	33.2	400	280	A	V
		5851.25	48.89	-70.46	119.35	39.42	32.1	10.59	33.22	400	280	P	V
		5863.75	49.9	-58.45	108.35	40.4	32.13	10.6	33.23	400	280	P	V
		5895.5	50.74	-39.25	89.99	41.18	32.19	10.61	33.24	400	280	P	V
		5942	49.36	-18.84	68.2	39.61	32.37	10.63	33.25	400	280	P	V
													V
													V



WiFi Ant. 1+2	Note	Frequency (MHz)	Level (dBμV/m)	Over Limit (dB)	Limit Line (dBμV/m)	Read Level (dBμV)	Antenna Factor (dB/m)	Path Loss (dB)	Preamp Factor (dB)	Ant Pos (cm)	Table Pos (deg)	Peak Avg. (P/A)	Pol. (H/V)	
802.11ac VHT20 CH 165 5825MHz	*	5825	112.72	-	-	103.25	32.1	10.58	33.21	316	35	P	H	
	*	5825	103.47	-	-	94	32.1	10.58	33.21	316	35	A	H	
		5850.4	54.04	-67.25	121.29	44.57	32.1	10.59	33.22	316	35	P	H	
		5870.6	51.47	-54.96	106.43	41.96	32.14	10.6	33.23	316	35	P	H	
		5881.4	51.15	-49.3	100.45	41.62	32.16	10.6	33.23	316	35	P	H	
		5941	50.53	-17.67	68.2	40.79	32.36	10.63	33.25	316	35	P	H	
														H
														H
	*	5825	108.97	-	-	99.5	32.1	10.58	33.21	394	285	P	V	
	*	5825	99.09	-	-	89.62	32.1	10.58	33.21	394	285	A	V	
		5852.6	49.95	-66.32	116.27	40.47	32.11	10.59	33.22	394	285	P	V	
		5861	50.12	-59	109.12	40.64	32.12	10.59	33.23	394	285	P	V	
		5886.2	50.76	-46.12	96.88	41.22	32.17	10.6	33.23	394	285	P	V	
		5948.8	49.99	-18.21	68.2	40.21	32.4	10.63	33.25	394	285	P	V	
														V
													V	
Remark	1. No other spurious found. 2. All results are PASS against Peak and Average limit line.													



Band 4 5725~5850MHz

WIFI 802.11ac VHT20 (Harmonic @ 3m)

WIFI Ant. 1+2	Note	Frequency (MHz)	Level (dBμV/m)	Over Limit (dB)	Limit Line (dBμV/m)	Read Level (dBμV)	Antenna Factor (dB/m)	Path Loss (dB)	Preamp Factor (dB)	Ant Pos (cm)	Table Pos (deg)	Peak Avg. (P/A)	Pol. (H/V)	
802.11ac VHT20 CH 149 5745MHz		11490	47.38	-26.62	74	50.75	40.1	17.48	60.95	100	0	P	H	
		17235	48.32	-19.88	68.2	45.71	40.84	22.06	60.29	100	0	P	H	
													H	
													H	
			11490	48.23	-25.77	74	51.6	40.1	17.48	60.95	100	0	P	V
			17235	48.42	-19.78	68.2	45.81	40.84	22.06	60.29	100	0	P	V
														V
802.11ac VHT20 CH 157 5785MHz		11570	47.26	-26.74	74	50.76	39.89	17.6	60.99	100	0	P	H	
		17355	48.83	-19.37	68.2	45.68	41.38	22.18	60.41	100	0	P	H	
													H	
													H	
			11570	47.45	-26.55	74	50.95	39.89	17.6	60.99	100	0	P	V
			17355	48.3	-19.9	68.2	45.15	41.38	22.18	60.41	100	0	P	V
														V
802.11ac VHT20 CH 165 5825MHz		11650	47.64	-26.36	74	51.37	39.6	17.72	61.05	100	0	P	H	
		17475	49.59	-18.61	68.2	45.86	41.97	22.28	60.52	100	0	P	H	
													H	
													H	
			11650	47.86	-26.14	74	51.59	39.6	17.72	61.05	100	0	P	V
			17475	49.27	-18.93	68.2	45.54	41.97	22.28	60.52	100	0	P	V
														V
Remark	1.	No other spurious found.												
	2.	All results are PASS against Peak and Average limit line.												



Band 4 5725~5850MHz

WIFI 802.11ac VHT40 (Band Edge @ 3m)

WIFI Ant. 1+2	Note	Frequency (MHz)	Level (dBμV/m)	Over Limit (dB)	Limit Line (dBμV/m)	Read Level (dBμV)	Antenna Factor (dB/m)	Path Loss (dB)	Preamp Factor (dB)	Ant Pos (cm)	Table Pos (deg)	Peak Avg. (P/A)	Pol. (H/V)	
		5609.75	49.47	-18.73	68.2	40.45	31.7	10.47	33.15	336	31	P	H	
		5675.75	53.13	-34.17	87.3	44.05	31.75	10.5	33.17	336	31	P	H	
		5719	58.06	-52.46	110.52	48.83	31.88	10.53	33.18	336	31	P	H	
		5722	59.1	-56.26	115.36	49.86	31.89	10.53	33.18	336	31	P	H	
	*	5755	109.76	-	-	100.39	32.01	10.55	33.19	336	31	P	H	
	*	5755	101.07	-	-	91.7	32.01	10.55	33.19	336	31	A	H	
		5852.25	50.36	-66.71	117.07	40.89	32.1	10.59	33.22	336	31	P	H	
		5863.75	50.7	-57.65	108.35	41.2	32.13	10.6	33.23	336	31	P	H	
		5895	51.43	-38.93	90.36	41.87	32.19	10.61	33.24	336	31	P	H	
		5948.5	51.23	-16.97	68.2	41.46	32.39	10.63	33.25	336	31	P	H	
802.11ac VHT40 CH 151 5755MHz													H	
													H	
			5624	50.69	-17.51	68.2	41.67	31.7	10.47	33.15	400	277	P	V
			5672	50	-34.52	84.52	40.93	31.74	10.5	33.17	400	277	P	V
			5719	53.81	-56.71	110.52	44.58	31.88	10.53	33.18	400	277	P	V
			5723.75	53.82	-65.53	119.35	44.57	31.9	10.53	33.18	400	277	P	V
		*	5755	106.68	-	-	97.31	32.01	10.55	33.19	400	277	P	V
		*	5755	97.8	-	-	88.43	32.01	10.55	33.19	400	277	A	V
			5854.75	49.67	-61.7	111.37	40.19	32.11	10.59	33.22	400	277	P	V
			5871.25	51.05	-55.2	106.25	41.54	32.14	10.6	33.23	400	277	P	V
			5880	50.74	-50.75	101.49	41.21	32.16	10.6	33.23	400	277	P	V
			5933	49.72	-18.48	68.2	40.02	32.33	10.62	33.25	400	277	P	V
														V
														V



WIFI Ant. 1+2	Note	Frequency (MHz)	Level (dBµV/m)	Over Limit (dB)	Limit Line (dBµV/m)	Read Level (dBµV)	Antenna Factor (dB/m)	Path Loss (dB)	Preamp Factor (dB)	Ant Pos (cm)	Table Pos (deg)	Peak Avg. (P/A)	Pol. (H/V)
		5634	49.81	-18.39	68.2	40.78	31.7	10.48	33.15	323	33	P	H
		5690.25	50.81	-47.2	98.01	41.69	31.78	10.51	33.17	323	33	P	H
		5710.5	51.84	-56.3	108.14	42.66	31.84	10.52	33.18	323	33	P	H
		5721.25	54.13	-59.52	113.65	44.89	31.89	10.53	33.18	323	33	P	H
	*	5795	109.5	-	-	100.04	32.09	10.57	33.2	323	33	P	H
	*	5795	100.7	-	-	91.24	32.09	10.57	33.2	323	33	A	H
		5852	52.75	-64.89	117.64	43.28	32.1	10.59	33.22	323	33	P	H
		5859	52.29	-57.39	109.68	42.8	32.12	10.59	33.22	323	33	P	H
		5879	51.87	-50.36	102.23	42.34	32.16	10.6	33.23	323	33	P	H
		5940.25	50.1	-18.1	68.2	40.36	32.36	10.63	33.25	323	33	P	H
802.11ac													H
VHT40													H
CH 159		5601.5	48.28	-19.92	68.2	39.26	31.7	10.46	33.14	396	284	P	V
5795MHz		5691	50.03	-48.53	98.56	40.91	31.78	10.51	33.17	396	284	P	V
		5713.75	50.96	-58.09	109.05	41.77	31.85	10.52	33.18	396	284	P	V
		5724.75	49.61	-72.02	121.63	40.36	31.9	10.53	33.18	396	284	P	V
	*	5795	105.44	-	-	95.98	32.09	10.57	33.2	396	284	P	V
	*	5795	96.54	-	-	87.08	32.09	10.57	33.2	396	284	A	V
		5852.5	49.74	-66.76	116.5	40.27	32.1	10.59	33.22	396	284	P	V
		5868	50.91	-56.25	107.16	41.4	32.14	10.6	33.23	396	284	P	V
		5881.25	51.23	-49.33	100.56	41.7	32.16	10.6	33.23	396	284	P	V
		5946.75	50.09	-18.11	68.2	40.32	32.39	10.63	33.25	396	284	P	V
													V
													V
Remark	<ol style="list-style-type: none"> No other spurious found. All results are PASS against Peak and Average limit line. 												



Band 4 5725~5850MHz

WIFI 802.11ac VHT40 (Harmonic @ 3m)

WIFI Ant. 1+2	Note	Frequency (MHz)	Level (dBµV/m)	Over Limit (dB)	Limit Line (dBµV/m)	Read Level (dBµV)	Antenna Factor (dB/m)	Path Loss (dB)	Preamp Factor (dB)	Ant Pos (cm)	Table Pos (deg)	Peak Avg. (P/A)	Pol. (H/V)	
802.11ac VHT40 CH 151 5755MHz		11510	47.37	-26.63	74	50.72	40.07	17.51	60.93	100	0	P	H	
		17265	48.26	-19.94	68.2	45.54	40.96	22.09	60.33	100	0	P	H	
													H	
													H	
			11510	48.34	-25.66	74	51.69	40.07	17.51	60.93	100	0	P	V
			17265	48.39	-19.81	68.2	45.67	40.96	22.09	60.33	100	0	P	V
														V
802.11ac VHT40 CH 159 5795MHz		11590	47.23	-26.77	74	50.78	39.83	17.63	61.01	100	0	P	H	
		17385	48.19	-20.01	68.2	44.91	41.52	22.2	60.44	100	0	P	H	
													H	
													H	
			11590	47.39	-26.61	74	50.94	39.83	17.63	61.01	100	0	P	V
			17385	48.43	-19.77	68.2	45.15	41.52	22.2	60.44	100	0	P	V
														V
Remark	1. No other spurious found.													
	2. All results are PASS against Peak and Average limit line.													



Band 4 5725~5850MHz

WIFI 802.11ac VHT80 (Band Edge @ 3m)

WIFI Ant. 1+2	Note	Frequency (MHz)	Level (dBμV/m)	Over Limit (dB)	Limit Line (dBμV/m)	Read Level (dBμV)	Antenna Factor (dB/m)	Path Loss (dB)	Preamp Factor (dB)	Ant Pos (cm)	Table Pos (deg)	Peak Avg. (P/A)	Pol. (H/V)
		5646.75	50.2	-18	68.2	41.17	31.7	10.49	33.16	325	32	P	H
		5690.75	54.22	-44.16	98.38	45.1	31.78	10.51	33.17	325	32	P	H
		5719.75	57.21	-53.52	110.73	47.98	31.88	10.53	33.18	325	32	P	H
		5725	58.4	-63.8	122.2	49.15	31.9	10.53	33.18	325	32	P	H
	*	5775	105.73	-	-	96.32	32.05	10.56	33.2	325	32	P	H
	*	5775	96.52	-	-	87.11	32.05	10.56	33.2	325	32	A	H
		5853.5	57.32	-56.9	114.22	47.84	32.11	10.59	33.22	325	32	P	H
		5857	57.25	-52.99	110.24	47.77	32.11	10.59	33.22	325	32	P	H
		5879.75	52.22	-49.45	101.67	42.69	32.16	10.6	33.23	325	32	P	H
		5934.25	49.8	-18.4	68.2	40.09	32.34	10.62	33.25	325	32	P	H
802.11ac													H
VHT80													H
CH 155		5646	49.2	-19	68.2	40.17	31.7	10.49	33.16	400	271	P	V
5775MHz		5697.25	51.67	-51.5	103.17	42.54	31.79	10.51	33.17	400	271	P	V
		5712.5	53.36	-55.34	108.7	44.17	31.85	10.52	33.18	400	271	P	V
		5720.75	55.39	-57.12	112.51	46.16	31.88	10.53	33.18	400	271	P	V
	*	5775	101.49	-	-	92.08	32.05	10.56	33.2	400	271	P	V
	*	5775	93.41	-	-	84	32.05	10.56	33.2	400	271	A	V
		5854.75	52.27	-59.1	111.37	42.79	32.11	10.59	33.22	400	271	P	V
		5861.5	52.77	-56.21	108.98	43.29	32.12	10.59	33.23	400	271	P	V
		5876.5	51.01	-53.08	104.09	41.49	32.15	10.6	33.23	400	271	P	V
		5934.5	48.82	-19.38	68.2	39.11	32.34	10.62	33.25	400	271	P	V
													V
													V
Remark	1. No other spurious found. 2. All results are PASS against Peak and Average limit line.												



Band 4 5725~5850MHz

WIFI 802.11ac VHT80 (Harmonic @ 3m)

WIFI Ant. 1+2	Note	Frequency (MHz)	Level (dBμV/m)	Over Limit (dB)	Limit Line (dBμV/m)	Read Level (dBμV)	Antenna Factor (dB/m)	Path Loss (dB)	Preamp Factor (dB)	Ant Pos (cm)	Table Pos (deg)	Peak Avg. (P/A)	Pol. (H/V)	
802.11ac VHT80 CH 155 5775MHz		11550	45.75	-28.25	74	49.21	39.95	17.57	60.98	100	0	P	H	
		17325	47.39	-20.81	68.2	44.39	41.22	22.15	60.37	100	0	P	H	
													H	
													H	
			11550	45.6	-28.4	74	49.06	39.95	17.57	60.98	100	0	P	V
			17325	46.24	-21.96	68.2	43.24	41.22	22.15	60.37	100	0	P	V
														V
														V
Remark	1. No other spurious found. 2. All results are PASS against Peak and Average limit line.													



Emission below 1GHz

5GHz WIFI 802.11ac VHT40 (LF @ 3m)

WIFI	Note	Frequency	Level	Over	Limit	Read	Antenna	Path	Preamp	Ant	Table	Peak	Pol.	
Ant.				Limit	Line	Level	Factor	Loss	Factor	Pos	Pos	Avg.		
1+2		(MHz)	(dBμV/m)	(dB)	(dBμV/m)	(dBμV)	(dB/m)	(dB)	(dB)	(cm)	(deg)	(P/A)	(H/V)	
5GHz 802.11ac VHT40 LF		34.85	33.86	-6.14	40	42.63	22.78	0.82	32.37	100	0	P	H	
		101.78	34.87	-8.63	43.5	49.56	16.26	1.37	32.32	-	-	P	H	
		143.49	34.08	-9.42	43.5	47.25	17.5	1.62	32.29	-	-	P	H	
		807.94	31.57	-14.43	46	31.31	28.14	3.96	31.84	-	-	P	H	
		859.35	32.6	-13.4	46	30.94	29.11	4.12	31.57	-	-	P	H	
		957.32	34.1	-11.9	46	29.47	31.09	4.36	30.82	-	-	P	H	
														H
														H
														H
														H
														H
														H
														H
			34.85	36.37	-3.63	40	45.14	22.78	0.82	32.37	100	0	QP	V
			59.1	27.02	-12.98	40	46.41	11.91	1.06	32.36	100	41	QP	V
			101.78	36.26	-7.24	43.5	50.95	16.26	1.37	32.32	-	-	P	V
			663.41	32.37	-13.63	46	34.39	26.57	3.57	32.16	-	-	P	V
			800.18	31.43	-14.57	46	31.07	28.3	3.94	31.88	-	-	P	V
		955.38	33.76	-12.24	46	29.23	31.02	4.35	30.84	-	-	P	V	
													V	
													V	
													V	
													V	
													V	
													V	
Remark	1. No other spurious found. 2. All results are PASS against limit line.													



Note symbol

*	Fundamental Frequency which can be ignored. However, the level of any unwanted emissions shall not exceed the level of the fundamental frequency.
!	Test result is over limit line.
P/A	Peak or Average
H/V	Horizontal or Vertical



A calculation example for radiated spurious emission is shown as below:

WIFI	Note	Frequency	Level	Over	Limit	Read	Antenna	Path	Preamp	Ant	Table	Peak	Pol.
Ant.				Limit	Line	Level	Factor	Loss	Factor	Pos	Pos	Avg.	
1		(MHz)	(dBμV/m)	(dB)	(dBμV/m)	(dBμV)	(dB/m)	(dB)	(dB)	(cm)	(deg)	(P/A)	(H/V)
802.11b		2390	55.45	-18.55	74	54.51	32.22	4.58	35.86	103	308	P	H
CH 01													
2412MHz		2390	43.54	-10.46	54	42.6	32.22	4.58	35.86	103	308	A	H

1. Path Loss(dB) = Cable loss(dB) + Filter loss(dB) + Attenuator loss(dB)
2. Level(dBμV/m) = Antenna Factor(dB/m) + Path Loss(dB) + Read Level(dBμV) - Preamp Factor(dB)
3. Over Limit(dB) = Level(dBμV/m) – Limit Line(dBμV/m)

For Peak Limit @ 2390MHz:

1. Level(dBμV/m)
= Antenna Factor(dB/m) + Path Loss(dB) + Read Level(dBμV) - Preamp Factor(dB)
= 32.22(dB/m) + 4.58(dB) + 54.51(dBμV) – 35.86 (dB)
= 55.45 (dBμV/m)
2. Over Limit(dB)
= Level(dBμV/m) – Limit Line(dBμV/m)
= 55.45(dBμV/m) – 74(dBμV/m)
= -18.55(dB)

For Average Limit @ 2390MHz:

1. Level(dBμV/m)
= Antenna Factor(dB/m) + Path Loss(dB) + Read Level(dBμV) - Preamp Factor(dB)
= 32.22(dB/m) + 4.58(dB) + 42.6(dBμV) – 35.86 (dB)
= 43.54 (dBμV/m)
2. Over Limit(dB) = Level(dBμV/m) – Limit Line(dBμV/m)
= 43.54(dBμV/m) – 54(dBμV/m)
= -10.46(dB)

Both peak and average measured complies with the limit line, so test result is "PASS".



Appendix C. Radiated Spurious Emission Plots

Test Engineer :	Watt Tseng, Cookie Ku, Fu Chen, Troye Hsieh	Temperature :	20.7 ~ 27.9°C
		Relative Humidity :	48.4 ~ 69.4%

Note symbol

-L	Low channel location
-R	High channel location

<CDD Mode>

<SKU1>

Band 4 - 5725~5850MHz

WIFI 802.11a (Band Edge @ 3m)

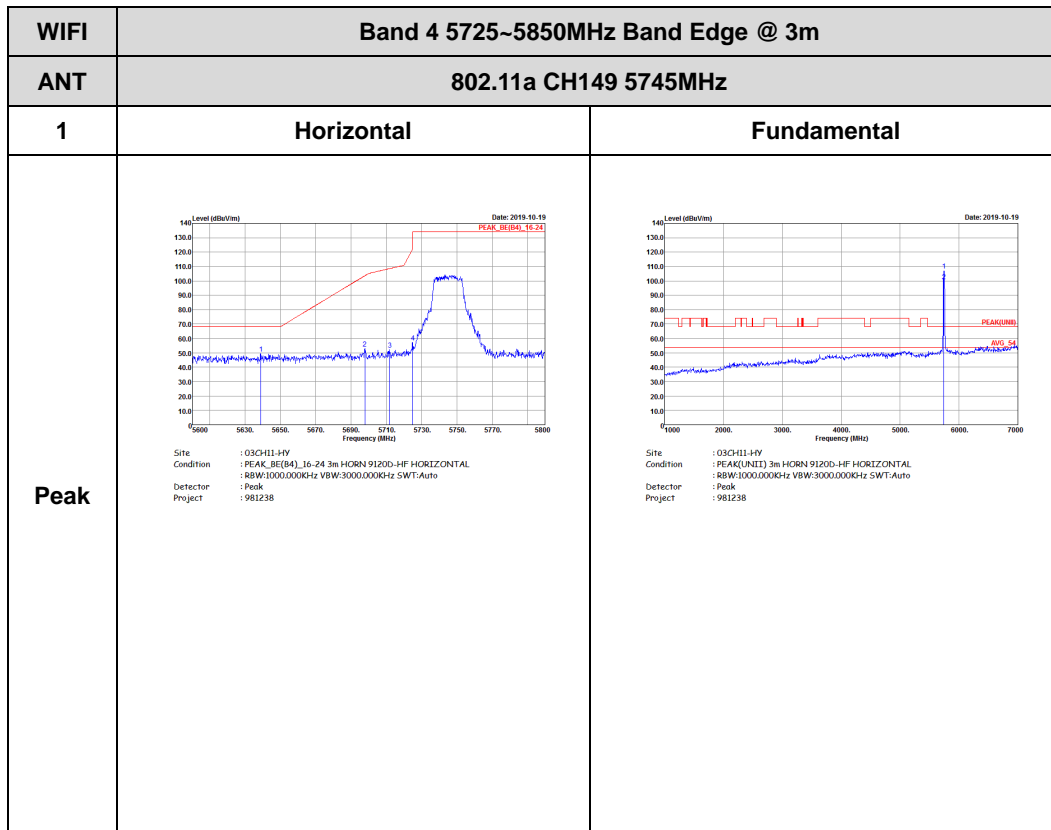

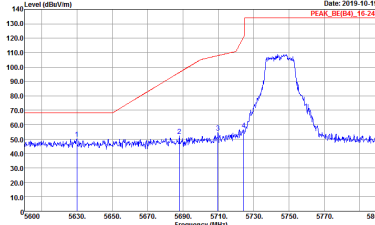
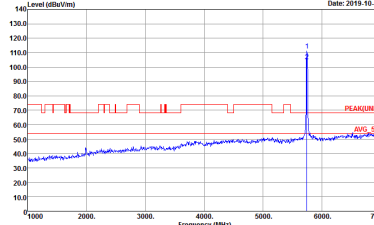

WIFI	Band 4 5725~5850MHz Band Edge @ 3m	
ANT	802.11a CH149 5745MHz	
1	Vertical	Fundamental
Peak	 <p>Date: 2019-10-19 PEAK_BE(49)_16-24</p> <p>Site : 03CH11-HY Condition : PEAK_BE(84)_16-24 3m HORN 91200-HF VERTICAL RBW:1000.000KHz VBW:3000.000KHz SWT:Auto Detector : Peak Project : 981238</p>	 <p>Date: 2019-10-19 PEAK_UN(8)_16-24</p> <p>Site : 03CH11-HY Condition : PEAK_UN(II) 3m HORN 91200-HF VERTICAL RBW:1000.000KHz VBW:3000.000KHz SWT:Auto Detector : Peak Project : 981238</p>



WIFI	Band 4 5725~5850MHz Band Edge @ 3m	
ANT	802.11a CH157 5785MHz	
1	Horizontal	Fundamental
<p>Peak</p>	<p>Site : 03CH11-HY Condition : PEAK_BE(B4)_16-24 3m HORN 91200-HF HORIZONTAL RBW:1000.000KHz VBW:3000.000KHz SWT:Auto Detector : Peak Project : 981238</p>	<p>Site : 03CH11-HY Condition : PEAK(UNII) 3m HORN 91200-HF HORIZONTAL RBW:1000.000KHz VBW:3000.000KHz SWT:Auto Detector : Peak Project : 981238</p>
<p>Peak</p>	<p>Site : 03CH11-HY Condition : PEAK_BE(B4)_16-24 3m HORN 91200-HF HORIZONTAL RBW:1000.000KHz VBW:3000.000KHz SWT:Auto Detector : Peak Project : 981238</p>	<p>Left blank</p>



WIFI	Band 4 5725~5850MHz Band Edge @ 3m	
ANT	802.11a CH157 5785MHz	
1	Vertical	Fundamental
Peak	<p>Site : 03CH11-HY Condition : PEAK_BE(B4)_16-24 3m HORN 91200-HF VERTICAL RBW:1000.000KHz VBW:3000.000KHz SWT:Auto Detector : Peak Project : 981238</p>	<p>Site : 03CH11-HY Condition : PEAK(UNII) 3m HORN 91200-HF VERTICAL RBW:1000.000KHz VBW:3000.000KHz SWT:Auto Detector : Peak Project : 981238</p>
Peak	<p>Site : 03CH11-HY Condition : PEAK_BE(B4)_16-24 3m HORN 91200-HF VERTICAL RBW:1000.000KHz VBW:3000.000KHz SWT:Auto Detector : Peak Project : 981238</p>	Left blank

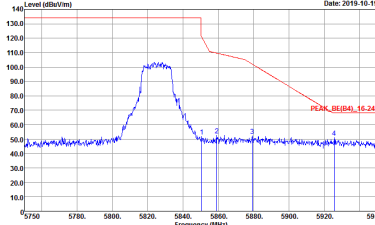
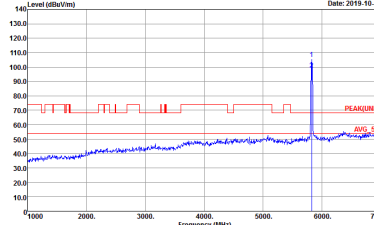

WIFI	Band 4 5725~5850MHz Band Edge @ 3m	
ANT	802.11a CH165 5825MHz	
1	Horizontal	Fundamental
Peak	 <p> Site : 03CH11-HY Condition : PEAK_BE(B4)_16-24 3m HORN 91200-HF HORIZONTAL RBW:1000.000KHz VBW:3000.000KHz SWT:Auto Detector : Peak Project : 981238 </p>	 <p> Site : 03CH11-HY Condition : PEAK(UNII) 3m HORN 91200-HF HORIZONTAL RBW:1000.000KHz VBW:3000.000KHz SWT:Auto Detector : Peak Project : 981238 </p>



WIFI	Band 4 5725~5850MHz Band Edge @ 3m	
ANT	802.11a CH165 5825MHz	
1	Vertical	Fundamental
Peak	<p>Site : 03CH11-HY Condition : PEAK_BE(B4)_16-24 3m HORN 91200-HF VERTICAL RBW:1000.000KHz VBW:3000.000KHz SWT:Auto Detector : Peak Project : 981238</p>	<p>Site : 03CH11-HY Condition : PEAK(UNII) 3m HORN 91200-HF VERTICAL RBW:1000.000KHz VBW:3000.000KHz SWT:Auto Detector : Peak Project : 981238</p>



Band 4 5725~5850MHz
WIFI 802.11ac VHT20 (Band Edge @ 3m)

WIFI	Band 4 5725~5850MHz Band Edge @ 3m	
ANT	802.11ac VHT20 CH149 5745MHz	
1	Horizontal	Fundamental
Peak	<p>Date: 2019-10-19 PEAK_BE(B4)_16-24</p> <p>Site : 03CH11-HY Condition : PEAK_BE(B4)_16-24 3m HORN 91200-HF HORIZONTAL Detector : RBW:3000.000KHz VSW:3000.000KHz SWT:Auto Project : 981238</p>	<p>Date: 2019-10-19 PEAK(UMB) AVG_S1</p> <p>Site : 03CH11-HY Condition : PEAK(UMB) 3m HORN 91200-HF HORIZONTAL Detector : RBW:3000.000KHz VSW:3000.000KHz SWT:Auto Project : 981238</p>

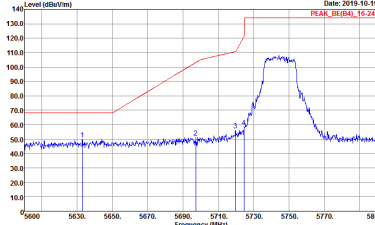
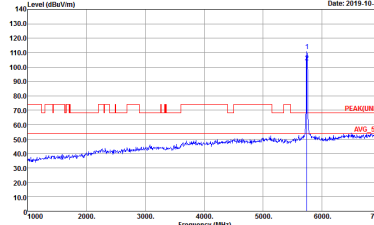

WIFI	Band 4 5725~5850MHz Band Edge @ 3m	
ANT	802.11ac VHT20 CH149 5745MHz	
1	Vertical	Fundamental
<p>Peak Avg.</p>	 <p>Site : 03CH11-HY Condition : PEAK_BE(84)_16-24 3m HORN 91200-HF VERTICAL Detector : Peak Project : 981238</p>	 <p>Site : 03CH11-HY Condition : PEAK(UNII) 3m HORN 91200-HF VERTICAL Detector : Peak Project : 981238</p>



WIFI	Band 4 5725~5850MHz Band Edge @ 3m	
ANT	802.11ac VHT20 CH157 5785MHz	
1	Horizontal	Fundamental
Peak	<p>Site : 03CH11-HY Condition : PEAK_BE(B4)_16-24 3m HORN 91200-HF HORIZONTAL RBW:1000.000KHz VBW:3000.000KHz SWT:Auto Detector : Peak Project : 981238</p>	<p>Site : 03CH11-HY Condition : PEAK(UNII) 3m HORN 91200-HF HORIZONTAL RBW:1000.000KHz VBW:3000.000KHz SWT:Auto Detector : Peak Project : 981238</p>
Peak	<p>Site : 03CH11-HY Condition : PEAK_BE(B4)_16-24 3m HORN 91200-HF HORIZONTAL RBW:1000.000KHz VBW:3000.000KHz SWT:Auto Detector : Peak Project : 981238</p>	Left blank



WIFI	Band 4 5725~5850MHz Band Edge @ 3m	
ANT	802.11ac VHT20 CH157 5785MHz	
1	Vertical	Fundamental
Peak	<p>Site : 03CH11-HY Condition : PEAK_BE(B4)_16-24 3m HORN 91200-HF VERTICAL : RBW:1000.000KHz VBW:3000.000KHz SWT:Auto Detector : Peak Project : 981238</p>	<p>Site : 03CH11-HY Condition : PEAK(UNII) 3m HORN 91200-HF VERTICAL : RBW:1000.000KHz VBW:3000.000KHz SWT:Auto Detector : Peak Project : 981238</p>
Peak	<p>Site : 03CH11-HY Condition : PEAK_BE(B4)_16-24 3m HORN 91200-HF VERTICAL : RBW:1000.000KHz VBW:3000.000KHz SWT:Auto Detector : Peak Project : 981238</p>	Left blank



WIFI	Band 4 5725~5850MHz Band Edge @ 3m	
ANT	802.11ac VHT20 CH165 5825MHz	
1	Horizontal	Fundamental
<p>Peak</p>	<p>Site : 03CH11-HY Condition : PEAK_BE(B4)_16-24 3m HORN 91200-HF HORIZONTAL RBW:1000.000KHz VBW:3000.000KHz SWT:Auto Detector : Peak Project : 981238</p>	<p>Site : 03CH11-HY Condition : PEAK(UNI) 3m HORN 91200-HF HORIZONTAL RBW:1000.000KHz VBW:3000.000KHz SWT:Auto Detector : Peak Project : 981238</p>



WIFI	Band 4 5725~5850MHz Band Edge @ 3m	
ANT	802.11ac VHT20 CH165 5825MHz	
1	Vertical	Fundamental
<p>Peak</p> <p>Avg.</p>	<p>Site : 03CH11-HY Condition : PEAK_BE(B4)_16-24 3m HORN 91200-HF VERTICAL RBW:1000.000KHz VBW:3000.000KHz SWT:Auto Detector : Peak Project : 981238</p>	<p>Site : 03CH11-HY Condition : PEAK(UNII) 3m HORN 91200-HF VERTICAL RBW:1000.000KHz VBW:3000.000KHz SWT:Auto Detector : Peak Project : 981238</p>

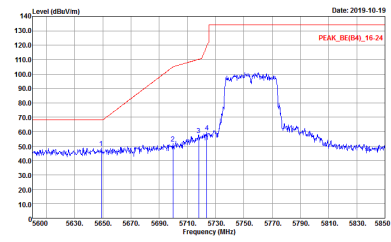
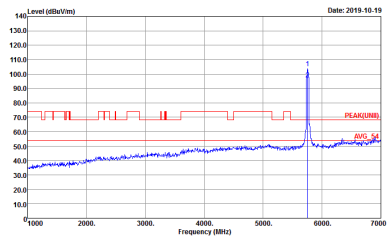
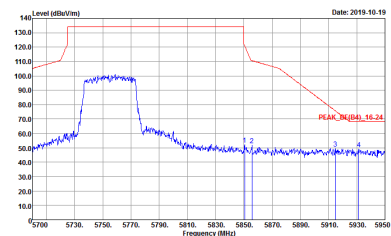

Band 4 5725~5850MHz
WIFI 802.11ac VHT40 (Band Edge @ 3m)

WIFI	Band 4 5725~5850MHz Band Edge @ 3m	
ANT	802.11ac VHT40 CH151 5755MHz	
1	<p align="center">Horizontal</p>  <p>Site : 03CH11-HY Condition : PEAK_BE(B4)_16-24 3m HORN 91200-HF HORIZONTAL RBW:1000.000KHz VBW:3000.000KHz SWT:Auto Detector : Peak Project : 981238</p>	<p align="center">Fundamental</p>  <p>Site : 03CH11-HY Condition : PEAK(UNIT) 3m HORN 91200-HF HORIZONTAL RBW:1000.000KHz VBW:3000.000KHz SWT:Auto Detector : Peak Project : 981238</p>
Peak	<p align="center">Peak</p>  <p>Site : 03CH11-HY Condition : PEAK_IN(B4)_16-24 3m HORN 91200-HF HORIZONTAL RBW:1000.000KHz VBW:3000.000KHz SWT:Auto Detector : Peak Project : 981238</p>	<p align="center">Left blank</p>

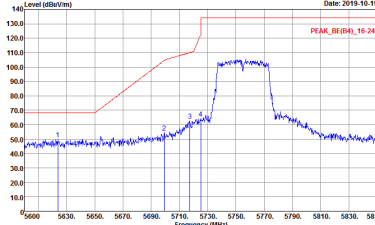
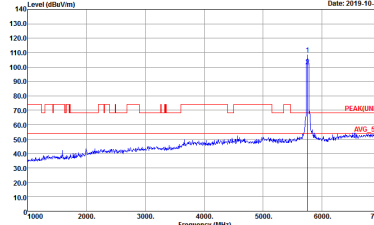
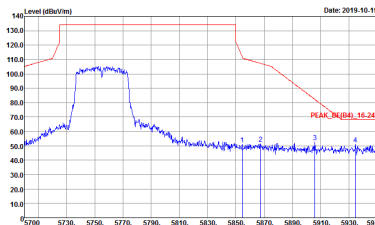

WIFI	Band 4 5725~5850MHz Band Edge @ 3m	
ANT	802.11ac VHT40 CH151 5755MHz	
1	Vertical	Fundamental
Peak	 <p>Site : 03CH11-HY Condition : PEAK_BE(B4)_16-24 3m HORN 91200-HF VERTICAL RBW:1000.000KHz VBW:3000.000KHz SWT:Auto Detector : Peak Project : 981238</p>	 <p>Site : 03CH11-HY Condition : PEAK(UNII) 3m HORN 91200-HF VERTICAL RBW:1000.000KHz VBW:3000.000KHz SWT:Auto Detector : Peak Project : 981238</p>
Peak	 <p>Site : 03CH11-HY Condition : PEAK_BE(B4)_16-24 3m HORN 91200-HF VERTICAL RBW:1000.000KHz VBW:3000.000KHz SWT:Auto Detector : Peak Project : 981238</p>	Left blank



WIFI	Band 4 5725~5850MHz Band Edge @ 3m	
ANT	802.11ac VHT40 CH159 5795MHz	
1	Horizontal	Fundamental
Peak	<p>Site : 03CH11-HY Condition : PEAK_BE(B4)_16-24 3m HORN 9120D-HF HORIZONTAL RBW:1000.000KHz VBW:3000.000KHz SWT:Auto Detector : Peak Project : 981238</p>	<p>Site : 03CH11-HY Condition : PEAK(LIN)I 3m HORN 9120D-HF HORIZONTAL RBW:1000.000KHz VBW:3000.000KHz SWT:Auto Detector : Peak Project : 981238</p>
Peak	<p>Site : 03CH11-HY Condition : PEAK_BE(B4)_16-24 3m HORN 9120D-HF HORIZONTAL RBW:1000.000KHz VBW:3000.000KHz SWT:Auto Detector : Peak Project : 981238</p>	Left blank



WIFI	Band 4 5725~5850MHz Band Edge @ 3m	
ANT	802.11ac VHT40 CH159 5795MHz	
1	Vertical	Fundamental
Peak	<p>Site : 03CH11-HY Condition : PEAK_BE(B4)_16-24 3m HORN 91200-HF VERTICAL RBW:1000.000KHz VBW:3000.000KHz SWT:Auto Detector : Peak Project : 981238</p>	<p>Site : 03CH11-HY Condition : PEAK(UNII) 3m HORN 91200-HF VERTICAL RBW:1000.000KHz VBW:3000.000KHz SWT:Auto Detector : Peak Project : 981238</p>
Peak	<p>Site : 03CH11-HY Condition : PEAK_BE(B4)_16-24 3m HORN 91200-HF VERTICAL RBW:1000.000KHz VBW:3000.000KHz SWT:Auto Detector : Peak Project : 981238</p>	Left blank



Band 4 5725~5850MHz

WIFI 802.11ac VHT80 (Band Edge @ 3m)

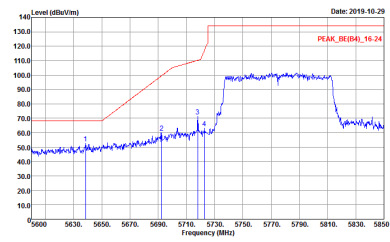
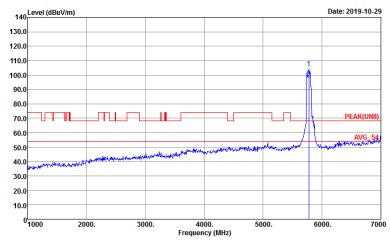
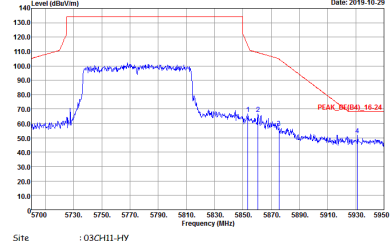
WIFI	Band 4 5725~5850MHz Band Edge @ 3m	
ANT	802.11ac VHT80 CH155 5775MHz	
1	Horizontal	Fundamental
Peak	 <p>Site : 03CH11-HY Condition : PEAK_BE(B4)_16-24 3m HORN 91200-HF HORIZONTAL RBW:1000.000kHz VBW:3000.000kHz SWT:Auto Detector : Peak Project : 981238</p>	 <p>Site : 03CH11-HY Condition : PEAK(UNIT) 3m HORN 91200-HF HORIZONTAL RBW:1000.000kHz VBW:3000.000kHz SWT:Auto Detector : Peak Project : 981238</p>
Peak	 <p>Site : 03CH11-HY Condition : PEAK_IN(B4)_16-24 3m HORN 91200-HF HORIZONTAL RBW:1000.000kHz VBW:3000.000kHz SWT:Auto Detector : Peak Project : 981238</p>	Left blank



WIFI	Band 4 5725~5850MHz Band Edge @ 3m	
ANT	802.11ac VHT80 CH155 5775MHz	
1	Vertical	Fundamental
Peak	<p>Site : 03CH11-HY Condition : PEAK_BE(B4)_16-24 3m HORN 91200-HF VERTICAL RBW:1000.000KHz VBW:3000.000KHz SWT:Auto Detector : Peak Project : 981238</p>	<p>Site : 03CH11-HY Condition : PEAK(UNII) 3m HORN 91200-HF VERTICAL RBW:1000.000KHz VBW:3000.000KHz SWT:Auto Detector : Peak Project : 981238</p>
Peak	<p>Site : 03CH11-HY Condition : PEAK_BE(B4)_16-24 3m HORN 91200-HF VERTICAL RBW:1000.000KHz VBW:3000.000KHz SWT:Auto Detector : Peak Project : 981238</p>	Left blank



Band 4 - 5725~5850MHz

WIFI 802.11a (Harmonic @ 3m)

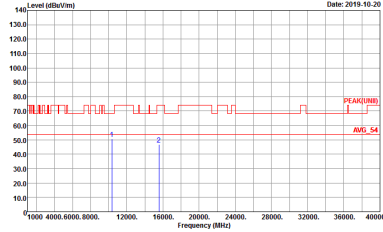
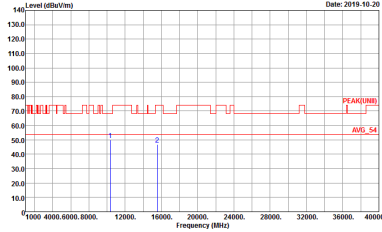
WIFI	Band 4 5725~5850MHz Harmonic @ 3m	
ANT	802.11a CH149 5745MHz	
1	Horizontal	Vertical
<p>Peak</p> <p>Avg.</p>	 <p>Date: 2019-10-20</p> <p>Site : 03CH11-4FY Condition : PEAK(UNII) 3m HORN 9120D-HF HORIZONTAL Detector : Peak Project : 981238</p>	 <p>Date: 2019-10-20</p> <p>Site : 03CH11-4FY Condition : PEAK(UNII) 3m HORN 9120D-HF VERTICAL Detector : Peak Project : 981238</p>



WIFI	Band 4 5725~5850MHz Harmonic @ 3m	
ANT	802.11a CH157 5785MHz	
1	Horizontal	Vertical
Peak Avg.	<p>Site : 03CH11-HY Condition : PEAK(UNED) 3m HORN 91200-HF HORIZONTAL Detector : Peak Project : 981238</p>	<p>Site : 03CH11-HY Condition : PEAK(UNED) 3m HORN 91200-HF VERTICAL Detector : Peak Project : 981238</p>



WIFI	Band 4 5725~5850MHz Harmonic @ 3m	
ANT	802.11a CH165 5825MHz	
1	Horizontal	Vertical
Peak Avg.	<p>Site : 03CH11-HY Condition : PEAK(UNED) 3m HORN 91200-HF HORIZONTAL Detector : Peak Project : 981238</p>	<p>Site : 03CH11-HY Condition : PEAK(UNED) 3m HORN 91200-HF VERTICAL Detector : Peak Project : 981238</p>



Band 4 5725~5850MHz
WIFI 802.11ac VHT20 (Harmonic @ 3m)

Table with 2 columns: WIFI (Band 4 5725~5850MHz Harmonic @ 3m), ANT (802.11ac VHT20 CH149 5745MHz). Row 1: 1, Horizontal, Vertical. Includes two graphs showing Level (dBuV/m) vs Frequency (MHz) for Peak and Avg. measurements.



WIFI	Band 4 5725~5850MHz Harmonic @ 3m	
ANT	802.11ac VHT20 CH157 5785MHz	
1	Horizontal	Vertical
Peak Avg.	<p>Site : 03CH11-HY Condition : PEAK(UNED) 3m HORN 9120D-HF HORIZONTAL Detector : Peak Project : 981238</p>	<p>Site : 03CH11-HY Condition : PEAK(UNED) 3m HORN 9120D-HF VERTICAL Detector : Peak Project : 981238</p>



WIFI	Band 4 5725~5850MHz Harmonic @ 3m	
ANT	802.11ac VHT20 CH165 5825MHz	
1	Horizontal	Vertical
Peak Avg.	<p>Site : 03CH11-HY Condition : PEAK(UNED) 3m HORN 9120D-HF HORIZONTAL Detector : Peak Project : 981238</p>	<p>Site : 03CH11-HY Condition : PEAK(UNED) 3m HORN 9120D-HF VERTICAL Detector : Peak Project : 981238</p>



Band 4 5725~5850MHz
WIFI 802.11ac VHT40 (Harmonic @ 3m)

WIFI	Band 4 5725~5850MHz Harmonic @ 3m	
ANT	802.11ac VHT40 CH151 5755MHz	
1	Horizontal	Vertical
Peak Avg.	<p>Site : 03CH11-HY Condition : PEAK(LINE) 3m HORN 91200-HF HORIZONTAL Detector : Peak Project : 981238</p>	<p>Site : 03CH11-HY Condition : PEAK(LINE) 3m HORN 91200-HF VERTICAL Detector : Peak Project : 981238</p>

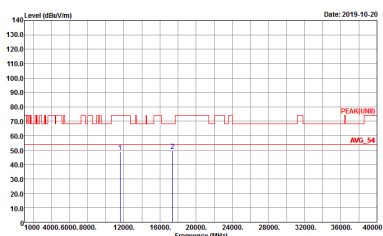
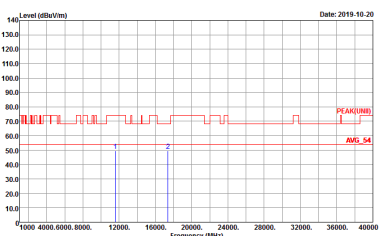

WIFI	Band 4 5725~5850MHz Harmonic @ 3m	
ANT	802.11ac VHT40 CH159 5795MHz	
1	Horizontal	Vertical
<p>Peak</p> <p>Avg.</p>	 <p>Site : 03CH11-HY Condition : PEAK(UNED) 3m HORN 91200-HF HORIZONTAL Detector : Peak Project : 981238</p>	 <p>Site : 03CH11-HY Condition : PEAK(UNED) 3m HORN 91200-HF VERTICAL Detector : Peak Project : 981238</p>



**Band 4 5725~5850MHz
WIFI 802.11ac VHT80 (Harmonic @ 3m)**

WIFI	Band 4 5725~5850MHz Harmonic @ 3m	
ANT	802.11ac VHT80 CH155 5775MHz	
1	Horizontal	Vertical
Peak Avg.	<p>Site : 03CH11-HY Condition : PEAK(LINII) 3m HORN 91200-HF HORIZONTAL Detector : Peak Project : 981238</p>	<p>Site : 03CH11-HY Condition : PEAK(LINII) 3m HORN 91200-HF VERTICAL Detector : Peak Project : 981238</p>

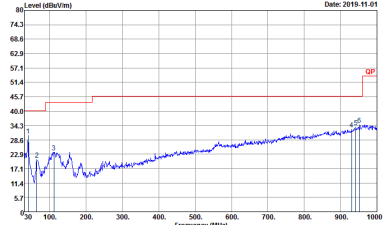
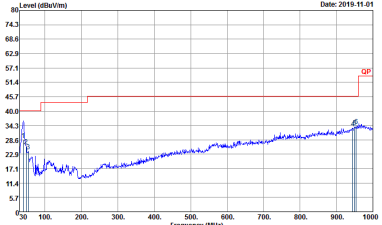

Emission below 1GHz
 5GHz WIFI 802.11ac VHT80 (LF)

WIFI	5GHz 5725~5850MHZ	
ANT	802.11ac VHT80 LF	
1	Horizontal	Vertical
<p>QP / Peak</p>	 <p>Site : 03CH11-FY Condition : QP 3m B1LOG_15_41912 HORIZONTAL Detector : Peak Project : 981238</p>	 <p>Site : 03CH11-FY Condition : QP 3m B1LOG_15_41912 VERTICAL Detector : Peak Project : 981238</p>



Band 4 - 5725~5850MHz

WIFI 802.11a (Band Edge @ 3m)

WIFI	Band 4 5725~5850MHz Band Edge @ 3m	
ANT	802.11a CH149 5745MHz	
2	Horizontal	Fundamental
Peak	<p>Site : 03CH11-4FY Condition : PEAK_BE(84)_16-24 3m HORN 91200-HF HORIZONTAL Detector : RBW:1000.000KHz VBW:3000.000KHz SWT:Auto Project : 981238</p>	<p>Site : 03CH11-4FY Condition : PEAK(LINII) 3m HORN 91200-HF HORIZONTAL Detector : RBW:1000.000KHz VBW:3000.000KHz SWT:Auto Project : 981238</p>

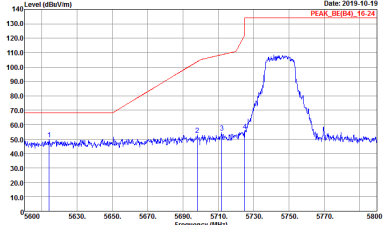
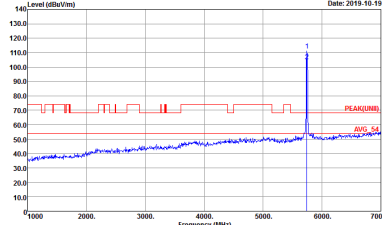

WIFI	Band 4 5725~5850MHz Band Edge @ 3m	
ANT	802.11a CH149 5745MHz	
2	Vertical	Fundamental
Peak	 <p>Date: 2019-10-19 PEAK_BE(49)_TC(2)</p> <p>Site : 03CH11-HY Condition : PEAK_BE(84)_16-24 3m HORN 91200-HF VERTICAL RBW:1000.000KHz VBW:3000.000KHz SWT:Auto Detector : Peak Project : 981238</p>	 <p>Date: 2019-10-19 PEAK(UR)</p> <p>Site : 03CH11-HY Condition : PEAK(UNII) 3m HORN 91200-HF VERTICAL RBW:1000.000KHz VBW:3000.000KHz SWT:Auto Detector : Peak Project : 981238</p>



WIFI	Band 4 5725~5850MHz Band Edge @ 3m	
ANT	802.11a CH157 5785MHz	
2	Horizontal	Fundamental
Peak	<p>Site : 03CH11-HY Condition : PEAK_BE(B4)_16-24 3m HORN 91200-HF HORIZONTAL RBW:1000.000KHz VBW:3000.000KHz SWT:Auto Detector : Peak Project : 981238</p>	<p>Site : 03CH11-HY Condition : PEAK(UNII) 3m HORN 91200-HF HORIZONTAL RBW:1000.000KHz VBW:3000.000KHz SWT:Auto Detector : Peak Project : 981238</p>
Peak	<p>Site : 03CH11-HY Condition : PEAK_BE(B4)_16-24 3m HORN 91200-HF HORIZONTAL RBW:1000.000KHz VBW:3000.000KHz SWT:Auto Detector : Peak Project : 981238</p>	Left blank



WIFI	Band 4 5725~5850MHz Band Edge @ 3m	
ANT	802.11a CH157 5785MHz	
2	Vertical	Fundamental
Peak	<p>Site : 03CH11-HY Condition : PEAK_BE(B4)_16-24 3m HORN 91200-HF VERTICAL : RBW:1000.000KHz VBW:3000.000KHz SWT:Auto Detector : Peak Project : 981238</p>	<p>Site : 03CH11-HY Condition : PEAK(UNII) 3m HORN 91200-HF VERTICAL : RBW:1000.000KHz VBW:3000.000KHz SWT:Auto Detector : Peak Project : 981238</p>
Peak	<p>Site : 03CH11-HY Condition : PEAK_BE(B4)_16-24 3m HORN 91200-HF VERTICAL : RBW:1000.000KHz VBW:3000.000KHz SWT:Auto Detector : Peak Project : 981238</p>	Left blank

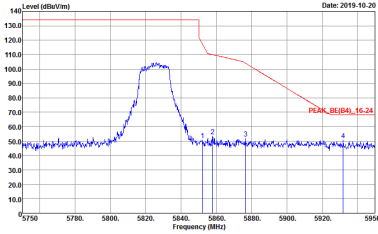
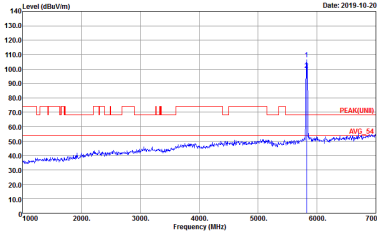

WIFI	Band 4 5725~5850MHz Band Edge @ 3m	
ANT	802.11a CH165 5825MHz	
2	Horizontal	Fundamental
Peak	 <p>Site : 03CH11-HY Condition : PEAK_BE(B4)_16-24 3m HORN 91200-HF HORIZONTAL RBW:1000.000KHz VBW:3000.000KHz SWT:Auto Detector : Peak Project : 981238</p>	 <p>Site : 03CH11-HY Condition : PEAK(UNI) 3m HORN 91200-HF HORIZONTAL RBW:1000.000KHz VBW:3000.000KHz SWT:Auto Detector : Peak Project : 981238</p>

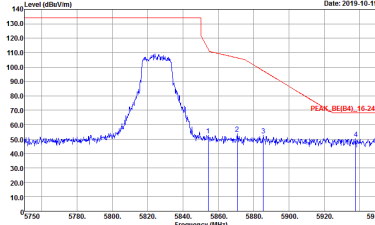
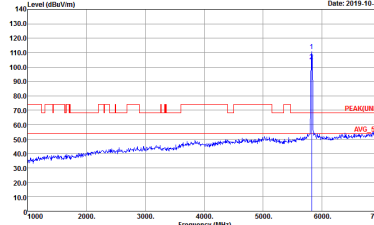

WIFI	Band 4 5725~5850MHz Band Edge @ 3m	
ANT	802.11a CH165 5825MHz	
2	Vertical	Fundamental
Peak	 <p>Site : 03CH11-HY Condition : PEAK_BE(84)_16-24 3m HORN 91200-HF VERTICAL RBW:1000.000KHz VBW:3000.000KHz SWT:Auto Detector : Peak Project : 981238</p>	 <p>Site : 03CH11-HY Condition : PEAK(UNII) 3m HORN 91200-HF VERTICAL RBW:1000.000KHz VBW:3000.000KHz SWT:Auto Detector : Peak Project : 981238</p>

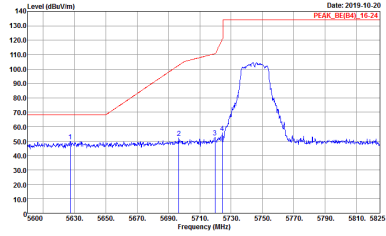
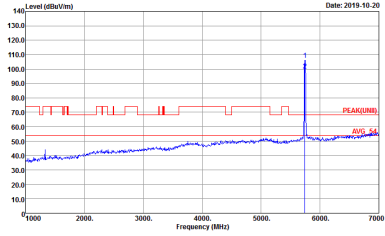

Band 4 5725~5850MHz
WIFI 802.11ac VHT20 (Band Edge @ 3m)

WIFI	Band 4 5725~5850MHz Band Edge @ 3m	
ANT	802.11ac VHT20 CH149 5745MHz	
2	Horizontal	Fundamental
Peak	 <p>Site : 03CH11-HY Condition : PEAK_BE(B4)_16-24 3m HORN 91200-HF HORIZONTAL Detector : RBW:3000.000KHz VSW:3000.000KHz SWT:Auto Project : 981238</p>	 <p>Site : 03CH11-HY Condition : PEAK(UNIT) 3m HORN 91200-HF HORIZONTAL Detector : RBW:3000.000KHz VSW:3000.000KHz SWT:Auto Project : 981238</p>

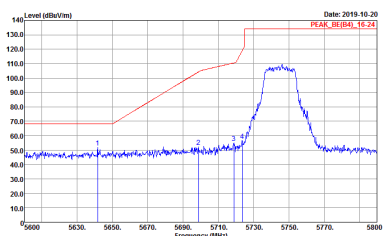
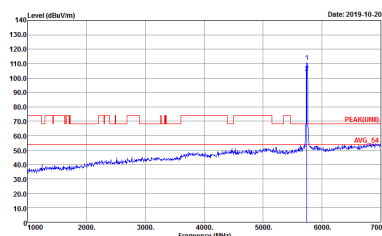

WIFI	Band 4 5725~5850MHz Band Edge @ 3m	
ANT	802.11ac VHT20 CH149 5745MHz	
2	Vertical	Fundamental
<p>Peak Avg.</p>	 <p>Site : 03CH11-HY Condition : PEAK_BE(84)_16-24 3m HORN 91200-HF VERTICAL RBW:1000.000KHz VBW:3000.000KHz SWT:Auto Detector : Peak Project : 981238</p>	 <p>Site : 03CH11-HY Condition : PEAK(UNII) 3m HORN 91200-HF VERTICAL RBW:1000.000KHz VBW:3000.000KHz SWT:Auto Detector : Peak Project : 981238</p>



WIFI	Band 4 5725~5850MHz Band Edge @ 3m	
ANT	802.11ac VHT20 CH157 5785MHz	
2	Horizontal	Fundamental
Peak	<p>Site : 03CH11-HY Condition : PEAK_BE(B4)_16-24 3m HORN 91200-HF HORIZONTAL RBW:1000.000KHz VBW:3000.000KHz SWT:Auto Detector : Peak Project : 981238</p>	<p>Site : 03CH11-HY Condition : PEAK(UNII) 3m HORN 91200-HF HORIZONTAL RBW:1000.000KHz VBW:3000.000KHz SWT:Auto Detector : Peak Project : 981238</p>
Peak	<p>Site : 03CH11-HY Condition : PEAK_BE(B4)_16-24 3m HORN 91200-HF HORIZONTAL RBW:1000.000KHz VBW:3000.000KHz SWT:Auto Detector : Peak Project : 981238</p>	Left blank



WIFI	Band 4 5725~5850MHz Band Edge @ 3m	
ANT	802.11ac VHT20 CH157 5785MHz	
2	Vertical	Fundamental
Peak	<p>Site : 03CH11-HY Condition : PEAK_BE(B4)_16-24 3m HORN 91200-HF VERTICAL RBW:1000.000KHz VBW:3000.000KHz SWT:Auto Detector : Peak Project : 981238</p>	<p>Site : 03CH11-HY Condition : PEAK(UNII) 3m HORN 91200-HF VERTICAL RBW:1000.000KHz VBW:3000.000KHz SWT:Auto Detector : Peak Project : 981238</p>
Peak	<p>Site : 03CH11-HY Condition : PEAK_BE(B4)_16-24 3m HORN 91200-HF VERTICAL RBW:1000.000KHz VBW:3000.000KHz SWT:Auto Detector : Peak Project : 981238</p>	Left blank

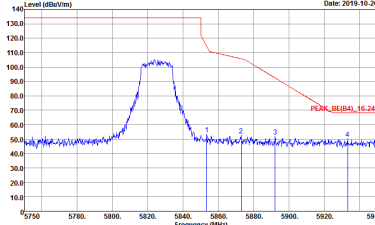
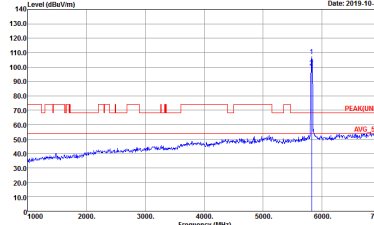

WIFI	Band 4 5725~5850MHz Band Edge @ 3m	
ANT	802.11ac VHT20 CH165 5825MHz	
2	Horizontal	Fundamental
Peak	 <p>Site : 03CH11-HY Condition : PEAK_BE(B4)_16-24 3m HORN 91200-HF HORIZONTAL RBW:1000.000KHz VBW:3000.000KHz SWT:Auto Detector : Peak Project : 981238</p>	 <p>Site : 03CH11-HY Condition : PEAK(UNII) 3m HORN 91200-HF HORIZONTAL RBW:1000.000KHz VBW:3000.000KHz SWT:Auto Detector : Peak Project : 981238</p>

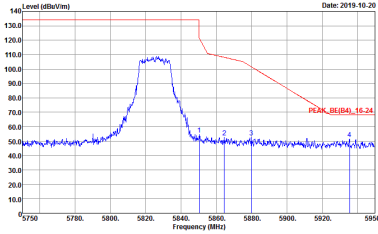
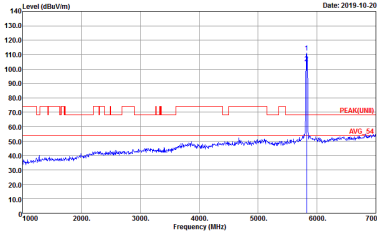

WIFI	Band 4 5725~5850MHz Band Edge @ 3m	
ANT	802.11ac VHT20 CH165 5825MHz	
2	Vertical	Fundamental
<p>Peak Avg.</p>	 <p>Site : 03CH11-HY Condition : PEAK_BE(84)_16-24 3m HORN 91200-HF VERTICAL RBW:1000.000KHz VBW:3000.000KHz SWT:Auto Detector : Peak Project : 981238</p>	 <p>Site : 03CH11-HY Condition : PEAK(UNII) 3m HORN 91200-HF VERTICAL RBW:1000.000KHz VBW:3000.000KHz SWT:Auto Detector : Peak Project : 981238</p>

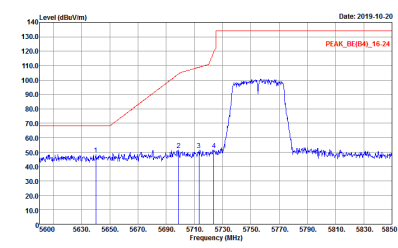
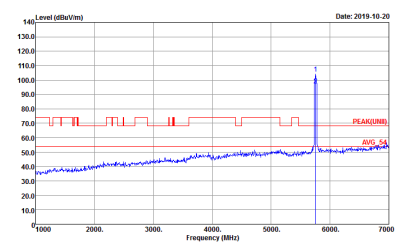
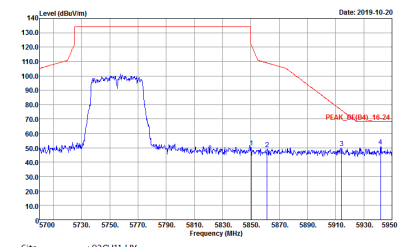

Band 4 5725~5850MHz
WIFI 802.11ac VHT40 (Band Edge @ 3m)

WIFI	Band 4 5725~5850MHz Band Edge @ 3m	
ANT	802.11ac VHT40 CH151 5755MHz	
2	Horizontal	Fundamental
Peak	 <p>Site : 03CH11-HY Condition : PEAK_BE(B4)_16-24 3m HORN 91200-HF HORIZONTAL RBW:1000.000KHz VBW:3000.000KHz SWT:Auto Detector : Peak Project : 981238</p>	 <p>Site : 03CH11-HY Condition : PEAK(UNIT) 3m HORN 91200-HF HORIZONTAL RBW:1000.000KHz VBW:3000.000KHz SWT:Auto Detector : Peak Project : 981238</p>
Peak	 <p>Site : 03CH11-HY Condition : PEAK_BE(B4)_16-24 3m HORN 91200-HF HORIZONTAL RBW:1000.000KHz VBW:3000.000KHz SWT:Auto Detector : Peak Project : 981238</p>	Left blank

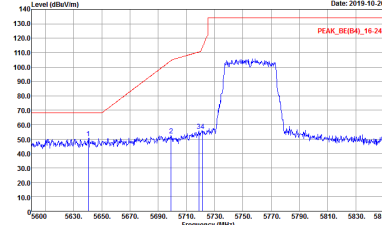
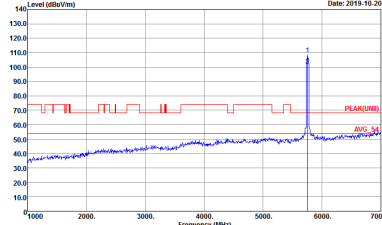
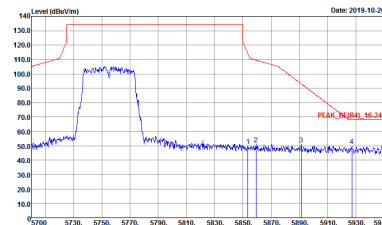

WIFI	Band 4 5725~5850MHz Band Edge @ 3m	
ANT	802.11ac VHT40 CH151 5755MHz	
2	Vertical	Fundamental
Peak	 <p>Site : 03CH11-HY Condition : PEAK_BE(B4)_16-24 3m HORN 91200-HF VERTICAL RBW:1000.000KHz VBW:3000.000KHz SWT:Auto Detector : Peak Project : 981238</p>	 <p>Site : 03CH11-HY Condition : PEAK(UNII) 3m HORN 91200-HF VERTICAL RBW:1000.000KHz VBW:3000.000KHz SWT:Auto Detector : Peak Project : 981238</p>
Peak	 <p>Site : 03CH11-HY Condition : PEAK_BE(B4)_16-24 3m HORN 91200-HF VERTICAL RBW:1000.000KHz VBW:3000.000KHz SWT:Auto Detector : Peak Project : 981238</p>	Left blank



WIFI	Band 4 5725~5850MHz Band Edge @ 3m	
ANT	802.11ac VHT40 CH159 5795MHz	
2	Horizontal	Fundamental
Peak	<p>Site : 03CH11-HY Condition : PEAK_BE(04)_16-24 3m HORN 91200-HF HORIZONTAL RBW:1000.000KHz VBW:3000.000KHz SWF:Auto Detector : Peak Project : 981238</p>	WLAN_11ac40_Ch159_BE_002
Peak	WLAN_11ac40_Ch159_BE_003	Left blank



WIFI	Band 4 5725~5850MHz Band Edge @ 3m	
ANT	802.11ac VHT40 CH159 5795MHz	
2	Vertical	Fundamental
Peak	<p>Site : 03CH11-HY Condition : PEAK_BE(B4)_16-24 3m HORN 91200-HF VERTICAL RBW:1000.000KHz VBW:3000.000KHz SWT:Auto Detector : Peak Project : 981238</p>	<p>Site : 03CH11-HY Condition : PEAK(UNII) 3m HORN 91200-HF VERTICAL RBW:1000.000KHz VBW:3000.000KHz SWT:Auto Detector : Peak Project : 981238</p>
Peak	<p>Site : 03CH11-HY Condition : PEAK_BE(B4)_16-24 3m HORN 91200-HF VERTICAL RBW:1000.000KHz VBW:3000.000KHz SWT:Auto Detector : Peak Project : 981238</p>	Left blank



Band 4 5725~5850MHz
WIFI 802.11ac VHT80 (Band Edge @ 3m)

WIFI	Band 4 5725~5850MHz Band Edge @ 3m	
ANT	802.11ac VHT80 CH155 5775MHz	
2	Horizontal	Fundamental
Peak	<p>Site : 03CH11-HY Condition : PEAK_BE(B4)_16-24 3m HORN 91200-HF HORIZONTAL Detector : Peak Project : 981238</p>	<p>Site : 03CH11-HY Condition : PEAK(UNIT) 3m HORN 91200-HF HORIZONTAL Detector : Peak Project : 981238</p>
Peak	<p>Site : 03CH11-HY Condition : PEAK_BE(B4)_16-24 3m HORN 91200-HF HORIZONTAL Detector : Peak Project : 981238</p>	Left blank

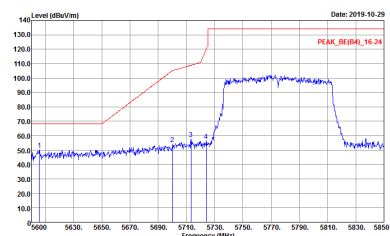
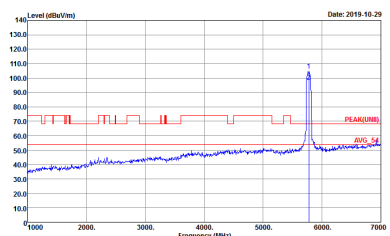
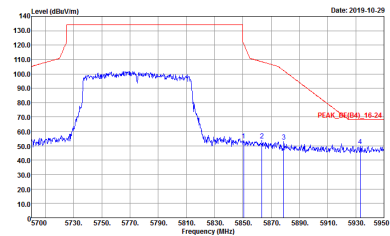

WIFI	Band 4 5725~5850MHz Band Edge @ 3m	
ANT	802.11ac VHT80 CH155 5775MHz	
2	Vertical	Fundamental
Peak	 <p>Site : 03CH11-HY Condition : PEAK_BE(B4)_16-24 3m HORN 91200-HF VERTICAL RBW:1000.000KHz VBW:3000.000KHz SWT:Auto Detector : Peak Project : 981238</p>	 <p>Site : 03CH11-HY Condition : PEAK(UNII) 3m HORN 91200-HF VERTICAL RBW:1000.000KHz VBW:3000.000KHz SWT:Auto Detector : Peak Project : 981238</p>
Peak	 <p>Site : 03CH11-HY Condition : PEAK_BE(B4)_16-24 3m HORN 91200-HF VERTICAL RBW:1000.000KHz VBW:3000.000KHz SWT:Auto Detector : Peak Project : 981238</p>	Left blank



Band 4 - 5725~5850MHz

WIFI 802.11a (Harmonic @ 3m)

WIFI	Band 4 5725~5850MHz Harmonic @ 3m	
ANT	802.11a CH149 5745MHz	
2	Horizontal	Vertical
<p>Peak</p> <p>Avg.</p>	<p>Site : 03CH11-4FY Condition : PEAK(LINE1) 3m HORN 9120D-HF HORIZONTAL Detector : Peak Project : 981238</p>	<p>Site : 03CH11-4FY Condition : PEAK(LINE1) 3m HORN 9120D-HF VERTICAL Detector : Peak Project : 981238</p>

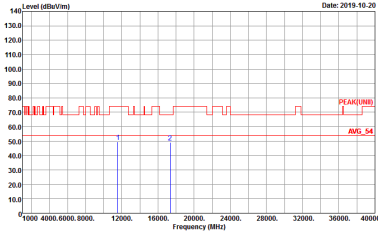
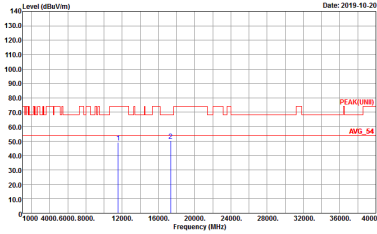

WIFI	Band 4 5725~5850MHz Harmonic @ 3m	
ANT	802.11a CH157 5785MHz	
2	Horizontal	Vertical
<p>Peak</p> <p>Avg.</p>	 <p>Site : 03CH11-HY Condition : PEAK(UNED) 3m HORN 9120D-HF HORIZONTAL Detector : Peak Project : 981238</p>	 <p>Site : 03CH11-HY Condition : PEAK(UNED) 3m HORN 9120D-HF VERTICAL Detector : Peak Project : 981238</p>

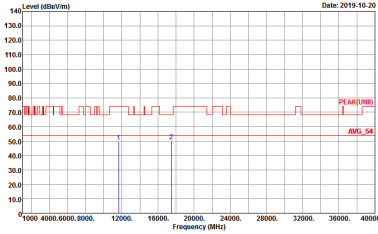
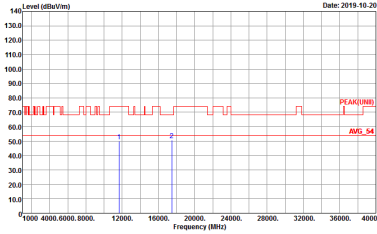

WIFI	Band 4 5725~5850MHz Harmonic @ 3m	
ANT	802.11a CH165 5825MHz	
2	Horizontal	Vertical
<p>Peak</p> <p>Avg.</p>	 <p>Site : 03CH11-HY Condition : PEAK(UNED) 3m HORN 91200-HF HORIZONTAL Detector : Peak Project : 981238</p>	 <p>Site : 03CH11-HY Condition : PEAK(UNED) 3m HORN 91200-HF VERTICAL Detector : Peak Project : 981238</p>



**Band 4 5725~5850MHz
WIFI 802.11ac VHT20 (Harmonic @ 3m)**

WIFI	Band 4 5725~5850MHz Harmonic @ 3m	
ANT	802.11ac VHT20 CH149 5745MHz	
2	Horizontal	Vertical
Peak Avg.	<p>Site : 03CH11-HY Condition : PEAK(LINE) 3m HORN 91200-HF HORIZONTAL Detector : Peak Project : 981238</p>	<p>Site : 03CH11-HY Condition : PEAK(LINE) 3m HORN 91200-HF VERTICAL Detector : Peak Project : 981238</p>

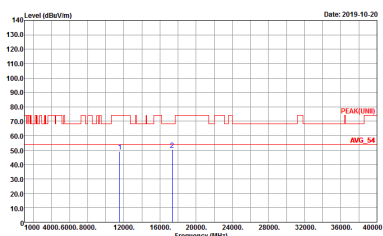
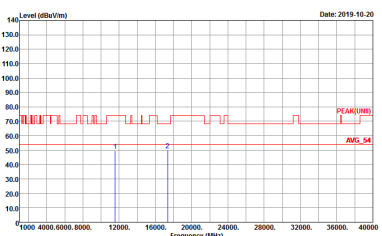

WIFI	Band 4 5725~5850MHz Harmonic @ 3m	
ANT	802.11ac VHT20 CH157 5785MHz	
2	Horizontal	Vertical
<p>Peak</p> <p>Avg.</p>	 <p>Site : 03CH11-HY Condition : PEAK(UNED) 3m HORN 9120D-HF HORIZONTAL Detector : Peak Project : 981238</p>	 <p>Site : 03CH11-HY Condition : PEAK(UNED) 3m HORN 9120D-HF VERTICAL Detector : Peak Project : 981238</p>



WIFI	Band 4 5725~5850MHz Harmonic @ 3m	
ANT	802.11ac VHT20 CH165 5825MHz	
2	Horizontal	Vertical
Peak Avg.	<p>Site : 03CH11-HY Condition : PEAK(UNED) 3m HORN 9120D-HF HORIZONTAL Detector : Peak Project : 981238</p>	<p>Site : 03CH11-HY Condition : PEAK(UNED) 3m HORN 9120D-HF VERTICAL Detector : Peak Project : 981238</p>



**Band 4 5725~5850MHz
WIFI 802.11ac VHT40 (Harmonic @ 3m)**

WIFI	Band 4 5725~5850MHz Harmonic @ 3m	
ANT	802.11ac VHT40 CH151 5755MHz	
2	Horizontal	Vertical
Peak Avg.	<p>Site : 03CH11-HY Condition : PEAK(UNII) 3m HORN 91200-HF HORIZONTAL Detector : Peak Project : 981238</p>	<p>Site : 03CH11-HY Condition : PEAK(UNII) 3m HORN 91200-HF VERTICAL Detector : Peak Project : 981238</p>



WIFI	Band 4 5725~5850MHz Harmonic @ 3m	
ANT	802.11ac VHT40 CH159 5795MHz	
2	Horizontal	Vertical
Peak Avg.	<p>Site : 03CH11-HY Condition : PEAK(UNED) 3m HORN 9120D-HF HORIZONTAL Detector : Peak Project : 981238</p>	<p>Site : 03CH11-HY Condition : PEAK(UNED) 3m HORN 9120D-HF VERTICAL Detector : Peak Project : 981238</p>



Band 4 5725~5850MHz
WIFI 802.11ac VHT80 (Harmonic @ 3m)

WIFI	Band 4 5725~5850MHz Harmonic @ 3m	
ANT	802.11ac VHT80 CH155 5775MHz	
2	Horizontal	Vertical
Peak Avg.	<p>Site : 03CH11-HY Condition : PEAK(UNII) 3m HORN 91200-HF HORIZONTAL Detector : Peak Project : 981238</p>	<p>Site : 03CH11-HY Condition : PEAK(UNII) 3m HORN 91200-HF VERTICAL Detector : Peak Project : 981238</p>



Emission below 1GHz
5GHz WIFI 802.11ac VHT20 (LF)

WIFI	5GHz 5725-5850MHz	
ANT	802.11ac VHT20 LF	
2	Horizontal	Vertical
QP / Peak	<p>Site : 03CH11-FY Condition : QP 3m B1LOG_15_41912 HORIZONTAL Detector : Peak Project : 981238</p>	<p>Site : 03CH11-FY Condition : QP 3m B1LOG_15_41912 VERTICAL Detector : Peak Project : 981238</p>



Band 4 - 5725~5850MHz

WIFI 802.11a (Band Edge @ 3m)

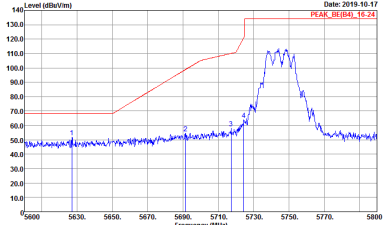
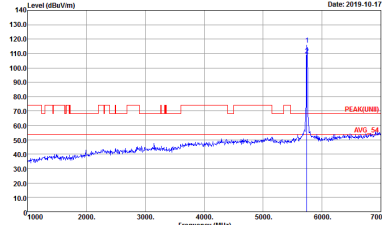
WIFI	Band 4 5725~5850MHz Band Edge @ 3m	
ANT	802.11a CH149 5745MHz	
1+2	Horizontal	Fundamental
Peak	 <p>Site : 03CH11-HY Condition : PEAK_BE(84)_16-24 3m HORN 91200-HF HORIZONTAL Detector : RBW:1000.000KHz VBW:3000.000KHz SWT:Auto Project : 981238</p>	 <p>Site : 03CH11-HY Condition : PEAK(LINII) 3m HORN 91200-HF HORIZONTAL Detector : RBW:1000.000KHz VBW:3000.000KHz SWT:Auto Project : 981238</p>

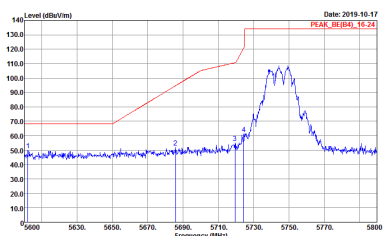
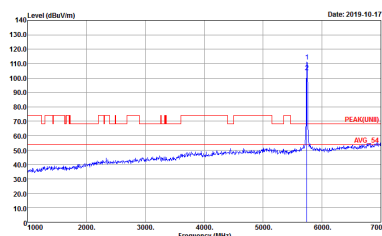

WIFI	Band 4 5725~5850MHz Band Edge @ 3m	
ANT	802.11a CH149 5745MHz	
1+2	Vertical	Fundamental
Peak	 <p>Date: 2019-10-17 PEAK_BE(49)_16-24</p> <p>Site : 03CH11-HY Condition : PEAK_BE(84)_16-24 3m HORN 91200-HF VERTICAL RBW:1000.000KHz VBW:3000.000KHz SWT:Auto Detector : Peak Project : 981238</p>	 <p>Date: 2019-10-17 PEAK_UN(8)</p> <p>Site : 03CH11-HY Condition : PEAK_UN(II) 3m HORN 91200-HF VERTICAL RBW:1000.000KHz VBW:3000.000KHz SWT:Auto Detector : Peak Project : 981238</p>



WIFI	Band 4 5725~5850MHz Band Edge @ 3m	
ANT	802.11a CH157 5785MHz	
1+2	Horizontal	Fundamental
Peak	<p>Site : 03CH11-HY Condition : PEAK_BE(B4)_16-24 3m HORN 91200-HF HORIZONTAL RBW:1000.000KHz VBW:3000.000KHz SWT:Auto Detector : Peak Project : 981238</p>	<p>Site : 03CH11-HY Condition : PEAK_UN(B4)_16-24 3m HORN 91200-HF HORIZONTAL RBW:1000.000KHz VBW:3000.000KHz SWT:Auto Detector : Peak Project : 981238</p>
Peak	<p>Site : 03CH11-HY Condition : PEAK_BE(B4)_16-24 3m HORN 91200-HF HORIZONTAL RBW:1000.000KHz VBW:3000.000KHz SWT:Auto Detector : Peak Project : 981238</p>	Left blank



WIFI	Band 4 5725~5850MHz Band Edge @ 3m	
ANT	802.11a CH157 5785MHz	
1+2	Vertical	Fundamental
Peak	<p>Site : 03CH11-HY Condition : PEAK_BE(B4)_16-24 3m HORN 91200-HF VERTICAL RBW:1000.000KHz VBW:3000.000KHz SWT:Auto Detector : Peak Project : 981238</p>	<p>Site : 03CH11-HY Condition : PEAK(UNII) 3m HORN 91200-HF VERTICAL RBW:1000.000KHz VBW:3000.000KHz SWT:Auto Detector : Peak Project : 981238</p>
Peak	<p>Site : 03CH11-HY Condition : PEAK_BE(B4)_16-24 3m HORN 91200-HF VERTICAL RBW:1000.000KHz VBW:3000.000KHz SWT:Auto Detector : Peak Project : 981238</p>	Left blank

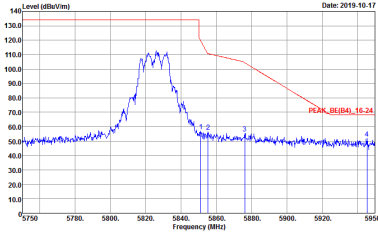
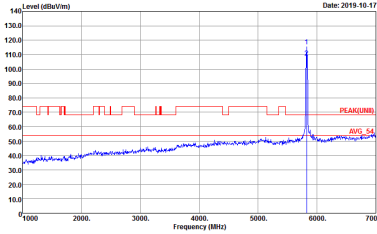

WIFI	Band 4 5725~5850MHz Band Edge @ 3m	
ANT	802.11a CH165 5825MHz	
1+2	Horizontal	Fundamental
Peak	 <p> Site : 03CH11-HY Condition : PEAK_BE(B4)_16-24 3m HORN 9120D-HF HORIZONTAL RBW:1000.000KHz VBW:3000.000KHz SWT:Auto Detector : Peak Project : 981238 </p>	 <p> Site : 03CH11-HY Condition : PEAK(UNI) 3m HORN 9120D-HF HORIZONTAL RBW:1000.000KHz VBW:3000.000KHz SWT:Auto Detector : Peak Project : 981238 </p>

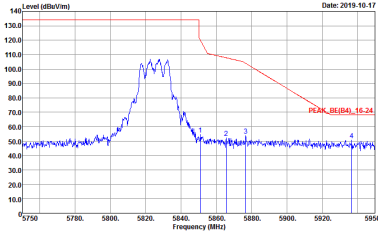
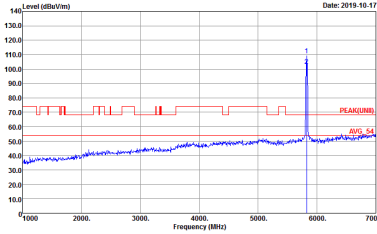

WIFI	Band 4 5725~5850MHz Band Edge @ 3m	
ANT	802.11a CH165 5825MHz	
1+2	Vertical	Fundamental
Peak	 <p>Site : 03CH11-HY Condition : PEAK_BE(84)_16-24 3m HORN 91200-HF VERTICAL RBW:1000.000KHz VBW:3000.000KHz SWT:Auto Detector : Peak Project : 981238</p>	 <p>Site : 03CH11-HY Condition : PEAK(UNII) 3m HORN 91200-HF VERTICAL RBW:1000.000KHz VBW:3000.000KHz SWT:Auto Detector : Peak Project : 981238</p>



Band 4 5725~5850MHz
WIFI 802.11ac VHT20 (Band Edge @ 3m)

WIFI	Band 4 5725~5850MHz Band Edge @ 3m	
ANT	802.11ac VHT20 CH149 5745MHz	
1+2	Horizontal	Fundamental
Peak	<p> Site : 03CH11-HY Condition : PEAK_BE(B4)_16-24 3m HORN 91200-HF HORIZONTAL Detector : RBW:3000.000KHz VSW:3000.000KHz SWT:Auto Project : 981238 </p>	<p> Site : 03CH11-HY Condition : PEAK(UNIT) 3m HORN 91200-HF HORIZONTAL Detector : RBW:3000.000KHz VSW:3000.000KHz SWT:Auto Project : 981238 </p>



WIFI	Band 4 5725~5850MHz Band Edge @ 3m	
ANT	802.11ac VHT20 CH149 5745MHz	
1+2	Vertical	Fundamental
Peak Avg.	<p>Site : 03CH11-HY Condition : PEAK_BE(84)_16-24 3m HORN 91200-HF VERTICAL RBW:1000.000KHz VBW:3000.000KHz SWT:Auto Detector : Peak Project : 981238</p>	<p>Site : 03CH11-HY Condition : PEAK(UNII) 3m HORN 91200-HF VERTICAL RBW:1000.000KHz VBW:3000.000KHz SWT:Auto Detector : Peak Project : 981238</p>



WIFI	Band 4 5725~5850MHz Band Edge @ 3m	
ANT	802.11ac VHT20 CH157 5785MHz	
1+2	Horizontal	Fundamental
<p>Peak</p>	<p>Site : 03CH11-HY Condition : PEAK_BE(B4)_16-24 3m HORN 9120D-HF HORIZONTAL RBW:1000.000KHz VBW:3000.000KHz SWF:Auto Detector : Peak Project : 981238</p>	<p>Site : 03CH11-HY Condition : PEAK(UNI) 3m HORN 9120D-HF HORIZONTAL RBW:1000.000KHz VBW:3000.000KHz SWF:Auto Detector : Peak Project : 981238</p>
<p>Peak</p>	<p>Site : 03CH11-HY Condition : PEAK_BE(B4)_16-24 3m HORN 9120D-HF HORIZONTAL RBW:1000.000KHz VBW:3000.000KHz SWF:Auto Detector : Peak Project : 981238</p>	<p>Left blank</p>

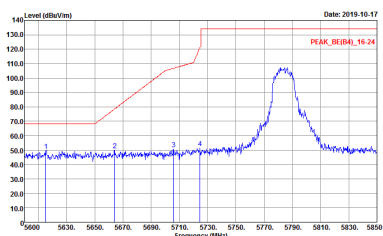
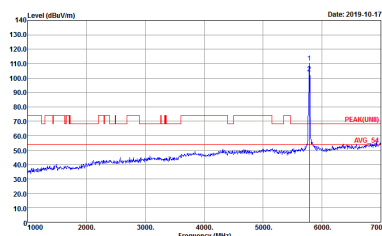
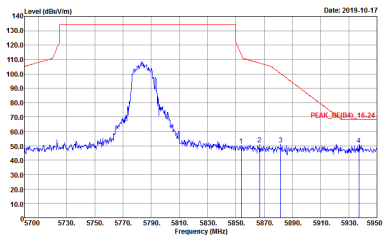

WIFI	Band 4 5725~5850MHz Band Edge @ 3m	
ANT	802.11ac VHT20 CH157 5785MHz	
1+2	Vertical	Fundamental
Peak	 <p>Date: 2019-10-17 PEAK_BE(B4)_16-24</p> <p>Site : 03CH11-HY Condition : PEAK_BE(B4)_16-24 3m HORN 91200-HF VERTICAL RBW:1000.000KHz VBW:3000.000KHz SWT:Auto Detector : Peak Project : 981238</p>	 <p>Date: 2019-10-17 PEAK(B4)</p> <p>Site : 03CH11-HY Condition : PEAK(UNII) 3m HORN 91200-HF VERTICAL RBW:1000.000KHz VBW:3000.000KHz SWT:Auto Detector : Peak Project : 981238</p>
Peak	 <p>Date: 2019-10-17 PEAK_BE(B4)_16-24</p> <p>Site : 03CH11-HY Condition : PEAK_BE(B4)_16-24 3m HORN 91200-HF VERTICAL RBW:1000.000KHz VBW:3000.000KHz SWT:Auto Detector : Peak Project : 981238</p>	Left blank

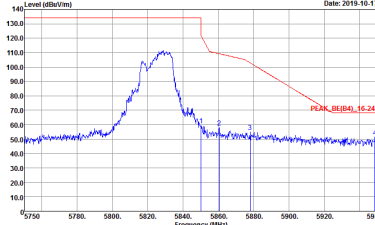
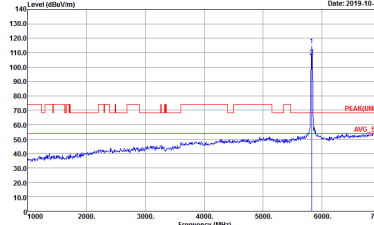

WIFI	Band 4 5725~5850MHz Band Edge @ 3m	
ANT	802.11ac VHT20 CH165 5825MHz	
1+2	Horizontal	Fundamental
Peak	 <p>Site : 03CH11-HY Condition : PEAK_BE(B4)_16-24 3m HORN 91200-HF HORIZONTAL RBW:1000.000KHz VBW:3000.000KHz SWT:Auto Detector : Peak Project : 981238</p>	 <p>Site : 03CH11-HY Condition : PEAK(UNI) 3m HORN 91200-HF HORIZONTAL RBW:1000.000KHz VBW:3000.000KHz SWT:Auto Detector : Peak Project : 981238</p>



WIFI	Band 4 5725~5850MHz Band Edge @ 3m	
ANT	802.11ac VHT20 CH165 5825MHz	
1+2	Vertical	Fundamental
<p>Peak</p> <p>Avg.</p>	<p>Site : 03CH11-HY Condition : PEAK_BE(84)_16-24 3m HORN 91200-HF VERTICAL RBW:1000.000KHz VBW:3000.000KHz SWT:Auto Detector : Peak Project : 981238</p>	<p>Site : 03CH11-HY Condition : PEAK(UNII) 3m HORN 91200-HF VERTICAL RBW:1000.000KHz VBW:3000.000KHz SWT:Auto Detector : Peak Project : 981238</p>



Band 4 5725~5850MHz
WIFI 802.11ac VHT40 (Band Edge @ 3m)

WIFI	Band 4 5725~5850MHz Band Edge @ 3m	
ANT	802.11ac VHT40 CH151 5755MHz	
1+2	Horizontal	Fundamental
Peak	<p>Site : 03CH11-HY Condition : PEAK_BE(B4)_16-24 3m HORN 91200-HF HORIZONTAL RBW:1000.000KHz VBW:3000.000KHz SWT:Auto Detector : Peak Project : 981238</p>	<p>Site : 03CH11-HY Condition : PEAK(UNIT) 3m HORN 91200-HF HORIZONTAL RBW:1000.000KHz VBW:3000.000KHz SWT:Auto Detector : Peak Project : 981238</p>
Peak	<p>Site : 03CH11-HY Condition : PEAK_BE(B4)_16-24 3m HORN 91200-HF HORIZONTAL RBW:1000.000KHz VBW:3000.000KHz SWT:Auto Detector : Peak Project : 981238</p>	Left blank



WIFI	Band 4 5725~5850MHz Band Edge @ 3m	
ANT	802.11ac VHT40 CH151 5755MHz	
1+2	Vertical	Fundamental
Peak	<p>Site : 03CH11-HY Condition : PEAK_BE(B4)_16-24 3m HORN 91200-HF VERTICAL RBW:1000.000KHz VBW:3000.000KHz SWT:Auto Detector : Peak Project : 981238 Setting :</p>	<p>Site : 03CH11-HY Condition : PEAK(UNII) 3m HORN 91200-HF VERTICAL RBW:1000.000KHz VBW:3000.000KHz SWT:Auto Detector : Peak Project : 981238</p>
Peak	<p>Site : 03CH11-HY Condition : PEAK_BE(B4)_16-24 3m HORN 91200-HF VERTICAL RBW:1000.000KHz VBW:3000.000KHz SWT:Auto Detector : Peak Project : 981238</p>	Left blank



WIFI	Band 4 5725~5850MHz Band Edge @ 3m	
ANT	802.11ac VHT40 CH159 5795MHz	
1+2	Horizontal	Fundamental
Peak	<p>Site : 03CH11-HY Condition : PEAK_BE(B4)_16-24 3m HORN 9120D-HF HORIZONTAL RBW:1000.000KHz VBW:3000.000KHz SWT:Auto Detector : Peak Project : 981238</p>	<p>Site : 03CH11-HY Condition : PEAK(UNIT) 3m HORN 9120D-HF HORIZONTAL RBW:1000.000KHz VBW:3000.000KHz SWT:Auto Detector : Peak Project : 981238</p>
Peak	<p>Site : 03CH11-HY Condition : PEAK_BE(B4)_16-24 3m HORN 9120D-HF HORIZONTAL RBW:1000.000KHz VBW:3000.000KHz SWT:Auto Detector : Peak Project : 981238</p>	Left blank



WIFI	Band 4 5725~5850MHz Band Edge @ 3m	
ANT	802.11ac VHT40 CH159 5795MHz	
1+2	Vertical	Fundamental
Peak	<p>Site : 03CH11-HY Condition : PEAK_BE(B4)_16-24 3m HORN 91200-HF VERTICAL RBW:1000.000KHz VBW:3000.000KHz SWT:Auto Detector : Peak Project : 981238</p>	<p>Site : 03CH11-HY Condition : PEAK(UNII) 3m HORN 91200-HF VERTICAL RBW:1000.000KHz VBW:3000.000KHz SWT:Auto Detector : Peak Project : 981238</p>
Peak	<p>Site : 03CH11-HY Condition : PEAK_BE(B4)_16-24 3m HORN 91200-HF VERTICAL RBW:1000.000KHz VBW:3000.000KHz SWT:Auto Detector : Peak Project : 981238</p>	Left blank



Band 4 5725~5850MHz
WIFI 802.11ac VHT80 (Band Edge @ 3m)

WIFI	Band 4 5725~5850MHz Band Edge @ 3m	
ANT	802.11ac VHT80 CH155 5775MHz	
1+2	Horizontal	Fundamental
Peak	<p>Site : 03CH11-HY Condition : PEAK_BE(B4)_16-24 3m HORN 91200-HF HORIZONTAL RBW:1000.000KHz VBW:3000.000KHz SWT:Auto Detector : Peak Project : 981238</p>	<p>Site : 03CH11-HY Condition : PEAK(UNIT) 3m HORN 91200-HF HORIZONTAL RBW:1000.000KHz VBW:3000.000KHz SWT:Auto Detector : Peak Project : 981238</p>
Peak	<p>Site : 03CH11-HY Condition : PEAK_IN(B4)_16-24 3m HORN 91200-HF HORIZONTAL RBW:1000.000KHz VBW:3000.000KHz SWT:Auto Detector : Peak Project : 981238</p>	Left blank



WIFI	Band 4 5725~5850MHz Band Edge @ 3m	
ANT	802.11ac VHT80 CH155 5775MHz	
1+2	Vertical	Fundamental
Peak	<p>Site : 03CH11-HY Condition : PEAK_BE(B4)_16-24 3m HORN 91200-HF VERTICAL RBW:1000.000KHz VBW:3000.000KHz SWT:Auto Detector : Peak Project : 981238</p>	<p>Site : 03CH11-HY Condition : PEAK(UNI) 3m HORN 91200-HF VERTICAL RBW:1000.000KHz VBW:3000.000KHz SWT:Auto Detector : Peak Project : 981238</p>
Peak	<p>Site : 03CH11-HY Condition : PEAK_BE(B4)_16-24 3m HORN 91200-HF VERTICAL RBW:1000.000KHz VBW:3000.000KHz SWT:Auto Detector : Peak Project : 981238</p>	Left blank



Band 4 - 5725~5850MHz

WIFI 802.11a (Harmonic @ 3m)

WIFI	Band 4 5725~5850MHz Harmonic @ 3m	
ANT	802.11a CH149 5745MHz	
1+2	Horizontal	Vertical
Peak Avg.	<p>Site : 03CH11-4FY Condition : PEAK(LINE1) 3m HORN 9120D-HF HORIZONTAL Detector : Peak Project : 981238</p>	<p>Site : 03CH11-4FY Condition : PEAK(LINE1) 3m HORN 9120D-HF VERTICAL Detector : Peak Project : 981238</p>

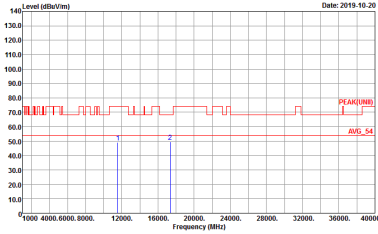
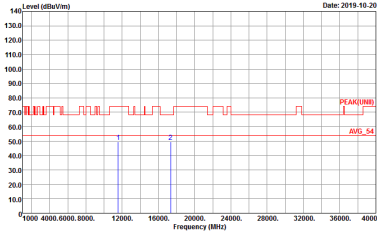

WIFI	Band 4 5725~5850MHz Harmonic @ 3m	
ANT	802.11a CH157 5785MHz	
1+2	Horizontal	Vertical
<p>Peak</p> <p>Avg.</p>	 <p>Site : 03CH11-HY Condition : PEAK(UNED) 3m HORN 91200-HF HORIZONTAL Detector : Peak Project : 981238</p>	 <p>Site : 03CH11-HY Condition : PEAK(UNED) 3m HORN 91200-HF VERTICAL Detector : Peak Project : 981238</p>



WIFI	Band 4 5725~5850MHz Harmonic @ 3m	
ANT	802.11a CH165 5825MHz	
1+2	Horizontal	Vertical
Peak Avg.	<p>Site : 03CH11-HY Condition : PEAK(UNED) 3m HORN 9120D-HF HORIZONTAL Detector : Peak Project : 981238</p>	<p>Site : 03CH11-HY Condition : PEAK(UNED) 3m HORN 9120D-HF VERTICAL Detector : Peak Project : 981238</p>



Band 4 5725~5850MHz
WIFI 802.11ac VHT20 (Harmonic @ 3m)

WIFI	Band 4 5725~5850MHz Harmonic @ 3m	
ANT	802.11ac VHT20 CH149 5745MHz	
1+2	Horizontal	Vertical
Peak Avg.	<p>Site : 03CH11-HY Condition : PEAK(UNII) 3m HORN 91200-HF HORIZONTAL Detector : Peak Project : 981238</p>	<p>Site : 03CH11-HY Condition : PEAK(UNII) 3m HORN 91200-HF VERTICAL Detector : Peak Project : 981238</p>



WIFI	Band 4 5725~5850MHz Harmonic @ 3m	
ANT	802.11ac VHT20 CH157 5785MHz	
1+2	Horizontal	Vertical
Peak Avg.	<p>Site : 03CH11-HY Condition : PEAK(UNED) 3m HORN 91200-HF HORIZONTAL Detector : Peak Project : 981238</p>	<p>Site : 03CH11-HY Condition : PEAK(UNED) 3m HORN 91200-HF VERTICAL Detector : Peak Project : 981238</p>

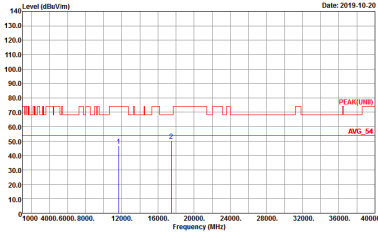
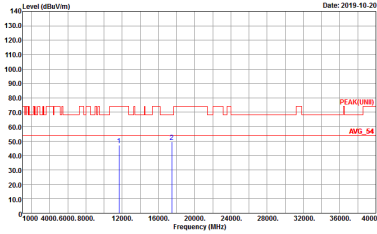

WIFI	Band 4 5725~5850MHz Harmonic @ 3m	
ANT	802.11ac VHT20 CH165 5825MHz	
1+2	Horizontal	Vertical
<p>Peak</p> <p>Avg.</p>	 <p>Site : 03CH11-HY Condition : PEAK(UNED) 3m HORN 9120D-HF HORIZONTAL Detector : Peak Project : 981238</p>	 <p>Site : 03CH11-HY Condition : PEAK(UNED) 3m HORN 9120D-HF VERTICAL Detector : Peak Project : 981238</p>



**Band 4 5725~5850MHz
WIFI 802.11ac VHT40 (Harmonic @ 3m)**

WIFI	Band 4 5725~5850MHz Harmonic @ 3m	
ANT	802.11ac VHT40 CH151 5755MHz	
1+2	Horizontal	Vertical
Peak Avg.	<p>Site : 03CH11-HY Condition : PEAK(UNII) 3m HORN 91200-HF HORIZONTAL Detector : Peak Project : 981238</p>	<p>Site : 03CH11-HY Condition : PEAK(UNII) 3m HORN 91200-HF VERTICAL Detector : Peak Project : 981238</p>

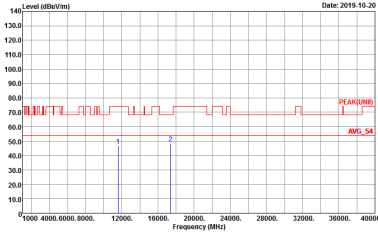
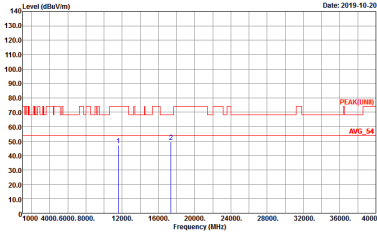

WIFI	Band 4 5725~5850MHz Harmonic @ 3m	
ANT	802.11ac VHT40 CH159 5795MHz	
1+2	Horizontal	Vertical
<p>Peak</p> <p>Avg.</p>	 <p>Site : 03CH11-HY Condition : PEAK(UNED) 3m HORN 91200-HF HORIZONTAL Detector : Peak Project : 981238</p>	 <p>Site : 03CH11-HY Condition : PEAK(UNED) 3m HORN 91200-HF VERTICAL Detector : Peak Project : 981238</p>



**Band 4 5725~5850MHz
WIFI 802.11ac VHT80 (Harmonic @ 3m)**

WIFI	Band 4 5725~5850MHz Harmonic @ 3m	
ANT	802.11ac VHT80 CH155 5775MHz	
1+2	Horizontal	Vertical
Peak Avg.	<p>Site : 03CH11-HY Condition : PEAK(UNII) 3m HORN 91200-HF HORIZONTAL Detector : Peak Project : 981238</p>	<p>Site : 03CH11-HY Condition : PEAK(UNII) 3m HORN 91200-HF VERTICAL Detector : Peak Project : 981238</p>

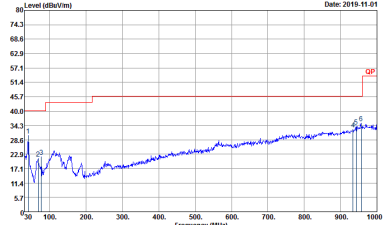
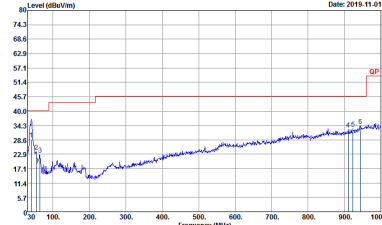

Emission below 1GHz
 5GHz WIFI 802.11ac VHT20 (LF)

WIFI	5GHz 5725-5850MHz	
ANT	802.11ac VHT20 LF	
1+2	Horizontal	Vertical
QP / Peak	 <p>Site : 03CH11-FY Condition : QP 3m B1LOG_15_41912 HORIZONTAL Detector : Peak Project : 981238</p>	 <p>Site : 03CH11-FY Condition : QP 3m B1LOG_15_41912 VERTICAL Detector : Peak Project : 981238</p>



<SKU2>

Band 4 - 5725~5850MHz

WIFI 802.11ac VHT80 (Band Edge @ 3m)

WIFI	Band 4 5725~5850MHz Band Edge @ 3m	
ANT	802.11ac VHT80 CH155 5775MHz	
1	Horizontal	Fundamental
Peak	<p>Site : 03CH11-HY Condition : PEAK_BE(B4)_16-24 3m HORN 9120D-HF HORIZONTAL Detector : Peak Project : 981238 Setting : 16.5</p>	<p>Site : 03CH11-HY Condition : PEAK(FUNB) 3m HORN 9120D-HF HORIZONTAL Detector : Peak Project : 981238 Setting : 16.5</p>
Peak	<p>Site : 03CH11-HY Condition : PEAK_BE(B4)_16-24 3m HORN 9120D-HF HORIZONTAL Detector : Peak Project : 981238 Setting : 16.5</p>	Left blank