

# FCC RF Test Report

FCC ID : UZ7ET45BB  
EQUIPMENT : Tablet  
BRAND NAME : Zebra  
MODEL NAME : ET45BB  
Applicant : Zebra Technologies Corporation  
1 Zebra Plaza, Holtsville, NY 11742  
Manufacturer : Zebra Technologies Corporation  
1 Zebra Plaza, Holtsville, NY 11742  
STANDARD : 47 CFR Part 2, 27 Subpart Q  
CLASSIFICATION : PCS Licensed Transmitter (PCB)  
Test Date(s) : May 30, 2022 ~ Jul. 21, 2022

We, Sporton International Inc. (Kunshan), would like to declare that the tested sample has been evaluated in accordance with the procedures given in ANSI C63.26-2015 and shown compliance with the applicable technical standards.

The test results in this report apply exclusively to the tested model / sample. Without written approval of Sporton International Inc. (Kunshan), the test report shall not be reproduced except in full.

Jason Jia

Approved by: Jason Jia



**Sporton International Inc. (Kunshan)**

**No. 1098, Pengxi North Road, Kunshan Economic Development Zone Jiangsu Province 215300  
People's Republic of China**



TABLE OF CONTENTS

REVISION HISTORY... 3
SUMMARY OF TEST RESULT ... 4
1. GENERAL DESCRIPTION ... 5
1.1 Product Feature of Equipment Under Test... 5
1.2 Product Specification of Equipment Under Test... 6
1.3 Modification of EUT ... 6
1.4 Maximum EIRP and Emission Designator ... 7
1.5 Testing Site ... 8
1.6 Test Software... 8
1.7 Applied Standards ... 8
2. TEST CONFIGURATION OF EQUIPMENT UNDER TEST ... 9
2.1 Test Mode ... 9
2.2 Connection Diagram of Test System ... 10
2.3 Support Unit used in test configuration and system ... 10
2.4 Measurement Results Explanation Example ... 10
2.5 Frequency List of Low/Middle/High Channels ... 11
3. CONDUCTED TEST ITEMS ... 13
3.1 Measuring Instruments ... 13
3.2 Test Setup ... 13
3.3 Test Result of Conducted Test ... 13
3.4 Conducted Output Power Measurement ... 14
3.5 Peak-to-Average Ratio ... 15
3.6 EIRP ... 16
3.7 Occupied Bandwidth ... 17
3.8 Conducted Band Edge Measurement ... 18
3.9 Conducted Spurious Emission Measurement ... 19
3.10 Frequency Stability Measurement ... 20
4. RADIATED TEST ITEMS ... 21
4.1 Measuring Instruments ... 21
4.2 Test Setup ... 21
4.3 Test Result of Radiated Test ... 22
4.4 Radiated Spurious Emission Measurement ... 23
5. LIST OF MEASURING EQUIPMENT ... 24
6. UNCERTAINTY OF EVALUATION ... 25
APPENDIX A. TEST RESULTS OF CONDUCTED TEST
APPENDIX B. TEST RESULTS OF RADIATED TEST
APPENDIX C. TEST SETUP PHOTOGRAPHS



## REVISION HISTORY

REPORT NO.	VERSION	DESCRIPTION	ISSUED DATE
FG230405L	Rev. 01	Initial issue of report	Aug. 03, 2022

## SUMMARY OF TEST RESULT

Report Section	FCC Rule	Description	Limit	Result	Remark
3.4	§2.1046	Conducted Output Power	—	Report Only	-
3.5	§27.50 (k)(4)	Peak-to-Average Ratio	<13dB	PASS	
3.6	§27.50 (k)(3)	EIRP	EIRP < 1W (30dBm)	PASS	-
3.7	§2.1049	Occupied Bandwidth	—	Report Only	-
3.8	§2.1051 §27.53 (n)(2)	Conducted Band Edge Measurement	-13dBm/MHz	PASS	-
3.9	§2.1051 §27.53 (n)(2)	Conducted Spurious Emission	-13dBm/MHz	PASS	-
3.10	§2.1055 §27.54	Frequency Stability Temperature & Voltage	Within the band	PASS	-
4.4	§2.1053 §27.53 (n)(2)	Radiated Spurious Emission	-13dBm/MHz	PASS	Under limit 21.32 dB at 6900.00 MHz

<b>Declaration of Conformity:</b>
The test results with all measurement uncertainty excluded are presented in accordance with the regulation limits or requirements declared by manufacturers.
<b>Comments and Explanations:</b>
The declared of product specification for EUT presented in the report are provided by the manufacturer, and the manufacturer takes all the responsibilities for the accuracy of product specification.



# 1. General Description

## 1.1 Product Feature of Equipment Under Test

Product Feature	
Equipment	Tablet
Brand Name	Zebra
Model Name	ET45BB
FCC ID	UZ7ET45BB
HW Version	EV2-2
SW Version	ET45USERDEBUG 11 11-10-12.00-RG-U00-PRD-GSE MXJ release-keys
MFD	07MAY22
EUT Stage	Identical Prototype

Specification of Accessory				
Battery	Brand Name	Zebra	Model Number	BT-000456

Supported Unit Used in Test Configuration and System				
AC Adapter	Brand Name	Zebra	Part Number	PWR-WUA5V12W0US
Earphone 1	Brand Name	Zebra	Part Number	HDST-35MM-PTVP-01
Earphone 2	Brand Name	Zebra	Part Number	HDST-USBC-PTT1-01
USB Cable (Type C to Type A)	Brand Name	Zebra	Part Number	CBL-TC5X-USBC2A-01
Type C-Audio Cable (Type C to 3.5mm)	Brand Name	Zebra	Part Number	ADP-USBC-35MM1-01

## 1.2 Product Specification of Equipment Under Test

Product Feature	
<b>Tx/Rx Frequency</b>	5G NR n77: 3450 MHz ~ 3550 MHz 5G NR n78: 3450 MHz ~ 3550 MHz
<b>SCS</b>	30kHz
<b>Bandwidth</b>	n77: 20 / 30 / 40 / 60 / 80 / 100MHz n78: 20 / 30 / 40 / 50 / 60 / 70 / 80 / 90 / 100MHz
<b>Antenna Type</b>	IFA Antenna
<b>Antenna Gain</b>	<b>Ant. 1:</b> 5G NR n77: -1.1 dBi 5G NR n78: -1.1 dBi <b>Ant. 3:</b> 5G NR n77: 0.4 dBi 5G NR n78: 0.4 dBi <b>Ant. 4:</b> 5G NR n77: -0.4 dBi 5G NR n78: -1.9 dBi <b>Ant. 5:</b> 5G NR n77: -1.0 dBi 5G NR n78: -1.0 dBi
<b>Type of Modulation</b>	CP-OFDM: QPSK / 16QAM / 64QAM / 256QAM DFT-s-OFDM: PI/2 BPSK / QPSK / 16QAM / 64QAM / 256QAM

**Remark:**

1. The device supports n77/n78(1T4R) SRS resources on Ant.1/3/4/5, only the test data of worst Ant.3 is showed in the report according to the maximum power.
2. 5G NR n77/n78 support SA and NSA mode. The whole testing has assessed SA mode for n78 by referring to the higher conducted power for conducted test items.
3. 5G NR n77/n78 support HPUE mode.
4. The EN-DC mode combination could be referred to the product spec.
5. For NSA mode of RSE testing, we only choose the combination of the maximum power among all NSA combinations to test.

## 1.3 Modification of EUT

No modifications are made to the EUT during all test items.

### 1.4 Maximum EIRP and Emission Designator

5G NR n77		PI/2 BPSK / QPSK		16QAM/64QAM/256QAM	
BW (MHz)	Frequency Range (MHz)	Maximum EIRP(W)	Emission Designator (99%OBW)	Maximum EIRP(W)	Emission Designator (99%OBW)
20	3460.02 ~ 3540.00	0.3846	18M4G7D	0.3097	18M5W7D
30	3465.00 ~ 3534.99	0.3811	26M8G7D	0.3319	26M9W7D
40	3470.01 ~ 3529.98	0.3828	36M1G7D	0.3105	36M0W7D
60	3480.00 ~ 3519.99	0.3673	58M6G7D	0.2897	58M4W7D
80	3490.02 ~ 3510.00	0.3428	76M9G7D	0.2891	78M0W7D
100	3500.01 ~ 3500.01	0.3855	95M9G7D	0.2805	97M1W7D

5G NR n78		PI/2 BPSK / QPSK		16QAM/64QAM/256QAM	
BW (MHz)	Frequency Range (MHz)	Maximum EIRP(W)	Emission Designator (99%OBW)	Maximum EIRP(W)	Emission Designator (99%OBW)
20	3460.02 ~ 3540.00	0.4130	18M4G7D	0.3266	18M5W7D
30	3465.00 ~ 3534.99	0.4121	26M8G7D	0.3350	26M9W7D
40	3470.01 ~ 3529.98	0.4121	36M1G7D	0.3273	36M0W7D
50	3475.02 ~ 3525.00	0.3972	45M9G7D	0.3228	46M2W7D
60	3480.00 ~ 3519.99	0.3963	58M6G7D	0.3184	58M4W7D
70	3485.01 ~ 3514.98	0.3873	64M3G7D	0.3170	65M0W7D
80	3490.02 ~ 3510.00	0.3908	76M9G7D	0.3041	78M0W7D
90	3495.00 ~ 3504.99	0.3837	87M2G7D	0.3184	87M4W7D
100	3500.01 ~ 3500.01	0.4178	95M9G7D	0.3155	97M1W7D

**Note:**

- 5G NR Band n78 overlaps the entire frequency range of Band n77, and n78 power > n77 power, therefore the conducted test results of n78 provided in this report cover n77.
- All modulations have been tested, and only the worst test results of PSK & QAM are shown in the report.

## 1.5 Testing Site

Sporton International Inc. (Kunshan) is accredited to ISO/IEC 17025:2017 by American Association for Laboratory Accreditation with Certificate Number 5145.02.

<b>Test Firm</b>	Sporton International Inc. (Kunshan)		
<b>Test Site Location</b>	No. 1098, Pengxi North Road, Kunshan Economic Development Zone Jiangsu Province 215300 People's Republic of China TEL : +86-512-57900158 FAX : +86-512-57900958		
<b>Test Site No.</b>	<b>Sporton Site No.</b>	<b>FCC Designation No.</b>	<b>FCC Test Firm Registration No.</b>
	03CH04-KS TH01-KS	CN1257	314309

## 1.6 Test Software

Item	Site	Manufacturer	Name	Version
1.	03CH04-KS	AUDIX	E3	6.2009-8-24a

## 1.7 Applied Standards

According to the specifications of the manufacturer, the EUT must comply with the requirements of the following standards:

- ♦ 47 CFR Part 2, 27Q
- ♦ ANSI C63.26-2015
- ♦ FCC KDB 971168 Power Meas License Digital Systems D01 v03r01
- ♦ FCC KDB 412172 D01 Determining ERP and EIRP v01r01
- ♦

**Remark:**

1. All test items were verified and recorded according to the standards and without any deviation during the test.
2. This EUT has also been tested and complied with the requirements of FCC Part 15, Subpart B, recorded in a separate test report.





## 2. Test Configuration of Equipment Under Test

### 2.1 Test Mode

Antenna port conducted and radiated test items listed below are performed according to KDB 971168 D01 Power Meas. License Digital Systems v03r01 with maximum output power.

For radiated measurement, pre-scanned in three orthogonal panels, X, Y, Z. The worst cases were recorded in this report.(Y-Plane)

Test Items	5G NR	Bandwidth (MHz)									Modulation					RB #			Test Channel			
		20	30	40	50	60	70	80	90	100	PI/2 BPSK	QPSK	16QAM	64QAM	256 QAM	1	Half	Full	L	M	H	
Max. Output Power	n77	v	v	v	-	v	-	v	-	v	v	v	v	v	v	v	v	v	v	v	v	v
	n78	v	v	v	v	v	v	v	v	v	v	v	v	v	v	v	v	v	v	v	v	v
Peak-to-Average Ratio	n78	v									v	v				v		v			v	
26dB and 99% Bandwidth	n78	v	v	v	v	v	v	v	v	v		v	v	v	v			v			v	
Conducted Band Edge	n78	v				v				v	v					v		v			v	
Conducted Spurious Emission	n78	v				v				v	v					v					v	v
Frequency Stability	n78	v										v						v				v
E.R.P / E.I.R.P	n77	v	v	v	-	v	-	v	-	v	v	v	v	v	v	v	v	v	v	v	v	v
	n78	v	v	v	v	v	v	v	v	v	v	v	v	v	v	v	v	v	v	v	v	v
Radiated Spurious Emission	n78	Worst Case																				v
Note	1. The mark "v" means that this configuration is chosen for testing 2. The mark "-" means that this bandwidth is not supported. 3. The device is investigated from 30MHz to 10 times of fundamental signal for radiated spurious emission test under different RB size/offset and modulations in exploratory test. Subsequently, only the worst case emissions are reported. 4. Normal Voltage: 3.87Vdc, Extreme Voltage: 3.55Vdc ~4.45Vdc																					

## 2.2 Connection Diagram of Test System

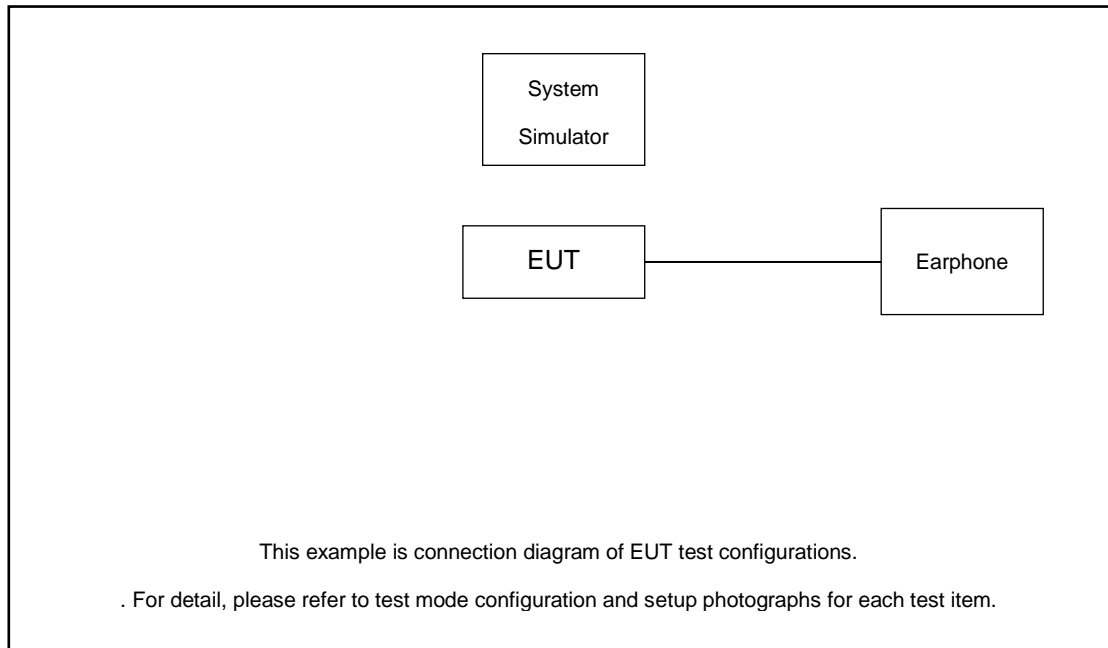

## 2.3 Support Unit used in test configuration and system

Item	Equipment	Trade Name	Model No.	FCC ID	Data Cable	Power Cord
1.	Power Supply	GWINSTEK	PSS-2002	N/A	N/A	Unshielded, 1.8 m
2.	LTE Base Station	Anritsu	MT8821C	N/A	N/A	Unshielded, 1.8 m
3.	NR Base Station	Anritsu	MT8000A	N/A	N/A	Unshielded, 1.8 m

## 2.4 Measurement Results Explanation Example

### For all conducted test items:

The offset level is set in the spectrum analyzer to compensate the RF cable loss between EUT conducted output port and spectrum analyzer. With the offset compensation, the spectrum analyzer reading level is exactly the EUT RF output level.

The spectrum analyzer offset is derived from RF cable loss.

*Offset = RF cable loss.*

Following shows an offset computation example with cable loss 6.0 dB.

Example :

$$\begin{aligned} \text{Offset(dB)} &= \text{RF cable loss(dB)}. \\ &= 6.0 \text{ (dB)} \end{aligned}$$

## 2.5 Frequency List of Low/Middle/High Channels

5G n77 Channel and Frequency List				
BW [MHz]	Channel/Frequency(MHz)	Lowest	Middle	Highest
100	Channel	-	633334	-
	Frequency	-	3500.01	-
80	Channel	632668	633334	634000
	Frequency	3490.02	3500.01	3510
60	Channel	632000	633334	634666
	Frequency	3480	3500.01	3519.99
40	Channel	631334	633334	635332
	Frequency	3470.01	3500.01	3529.98
30	Channel	631000	633334	635666
	Frequency	3465	3500.01	3534.99
20	Channel	630668	633334	636000
	Frequency	3460.02	3500.01	3540

5G n78 Channel and Frequency List				
BW [MHz]	Channel/Frequency(MHz)	Lowest	Middle	Highest
100	Channel	-	633334	-
	Frequency	-	3500.01	-
90	Channel	633000	633334	633666
	Frequency	3495	3500.01	3504.99
80	Channel	632668	633334	634000
	Frequency	3490.02	3500.01	3510
70	Channel	632334	633334	634332
	Frequency	3485.01	3500.01	3514.98
60	Channel	632000	633334	634666
	Frequency	3480	3500.01	3519.99
50	Channel	631668	633334	635000
	Frequency	3475.02	3500.01	3525
40	Channel	631334	633334	635332
	Frequency	3470.01	3500.01	3529.98
30	Channel	631000	633334	635666
	Frequency	3465	3500.01	3534.99
20	Channel	630668	633334	636000
	Frequency	3460.02	3500.01	3540

### 3. Conducted Test Items

#### 3.1 Measuring Instruments

See list of measuring instruments of this test report.

#### 3.2 Test Setup

1. Conducted Output Power

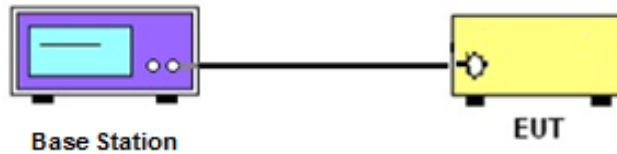

2. Peak-to-Average Ratio, Occupied / 26dB Bandwidth ,Band-Edge and Conducted Spurious Emission

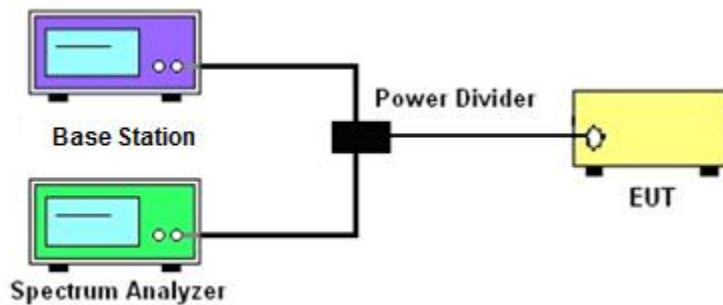

3. Frequency Stability

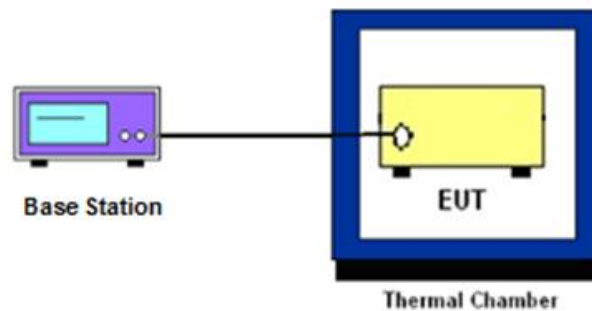

#### 3.3 Test Result of Conducted Test

Please refer to Appendix A.



### **3.4 Conducted Output Power Measurement**

#### 3.4.1 Description of the Conducted Output Power Measurement

A base station simulator was used to establish communication with the EUT. Its parameters were set to transmit the maximum power on the EUT. The measured power in the radio frequency on the transmitter output terminals shall be reported.

#### 3.4.2 Test Procedures

1. The testing follows ANSI C63.26 Section 5.2
2. The transmitter output port was connected to the system simulator.
3. Set EUT at maximum power through the system simulator.
4. Select lowest, middle, and highest channels for each band and different modulation.
5. Measure and record the power level from the system simulator.

## 3.5 Peak-to-Average Ratio

### 3.5.1 Description of the PAR Measurement

Power Complementary Cumulative Distribution Function (CCDF) curves provide a means for characterizing the power peaks of a digitally modulated signal on a statistical basis. A CCDF curve depicts the probability of the peak signal amplitude exceeding the average power level. Most contemporary measurement instrumentation include the capability to produce CCDF curves for an input signal provided that the instrument's resolution bandwidth can be set wide enough to accommodate the entire input signal bandwidth. In measuring transmissions in this band using an average power technique, the peak-to-average ratio (PAR) of the transmission may not exceed 13 dB.

### 3.5.2 Test Procedures

4. The testing follows ANSI C63.26 Section 5.2.6 (PAPR).
5. The EUT was connected to spectrum and system simulator via a power divider.
6. Set EUT in maximum power output.
7. Set the RBW = 1MHz, VBW = 3MHz, Detector = Peak, Trace mode = max hold, Set span  $\geq 2 \times$  OBW in spectrum analyzer.
8. Set the RBW = 1MHz, VBW = 3MHz, Detector = power averaging, Trace mode = max hold, Set span  $\geq 2 \times$  OBW in spectrum analyzer.
9. Add  $[10 \log (1/\text{duty cycle})]$  to the measured maximum power level to compute the average power during continuous transmission.
10.  $\text{PAPR (dB)} = P_{Pk} \text{ (dBm)} - P_{Avg} \text{ (dBm)}$   
where  
PAPR peak-to-average power ratio, in dB  
 $P_{Pk}$  measured peak power level, in dBm  
 $P_{Avg}$  measured average power level, in dBm
11. Record the deviation as Peak to Average Ratio.



## 3.6 EIRP

### 3.6.1 Description of EIRP Limit

#### § 27.50 (k)(3)

Mobile devices are limited to 1Watt (30 dBm) EIRP. Mobile devices operating in these bands must employ a means for limiting power to the minimum necessary for successful communications

### 3.6.2 Test Procedures

1. According to KDB 412172 D01 Power Approach,
2.  $EIRP = P_T + G_T - L_C$ ,  $ERP = EIRP - 2.15$ , where  
 $P_T$  = transmitter output power in dBm  
 $G_T$  = gain of the transmitting antenna in dBi  
 $L_C$  = signal attenuation in the connecting cable between the transmitter and antenna in dB



## 3.7 Occupied Bandwidth

### 3.7.1 Description of Occupied Bandwidth Measurement

The occupied bandwidth is the width of a frequency band such that, below the lower and above the upper frequency limits, the mean powers emitted are each equal to a specified percentage 0.5% of the total mean transmitted power.

The 26 dB emission bandwidth is defined as the frequency range between two points, one above and one below the carrier frequency, at which the spectral density of the emission is attenuated 26 dB below the maximum in-band spectral density of the modulated signal. Spectral density (power per unit bandwidth) is to be measured with a detector of resolution bandwidth equal to approximately 1.0% of the emission bandwidth.

### 3.7.2 Test Procedures

1. The testing follows ANSI C63.26 Section 5.4
2. The EUT was connected to spectrum analyzer and system simulator via a power divider.
3. The spectrum analyzer center frequency is set to the nominal EUT channel center frequency. The span range for the spectrum analyzer shall be between two and five times the anticipated OBW.
4. The nominal resolution bandwidth (RBW) shall be in the range of 1 to 5 % of the anticipated OBW, and the VBW shall be at least 3 times the RBW.
5. Set the detection mode to peak, and the trace mode to max hold.
6. Determine the reference value: Set the EUT to transmit a modulated signal. Allow the trace to stabilize. Set the spectrum analyzer marker to the highest level of the displayed trace.  
(this is the reference value)
7. Determine the “-26 dB down amplitude” as equal to (Reference Value – X).
8. Place two markers, one at the lowest and the other at the highest frequency of the envelope of the spectral display such that each marker is at or slightly below the “-X dB down amplitude” determined in step 6. If a marker is below this “-X dB down amplitude” value it shall be placed as close as possible to this value. The OBW is the positive frequency difference between the two markers.
9. Use the 99 % power bandwidth function of the spectrum analyzer and report the measured bandwidth.

## 3.8 Conducted Band Edge Measurement

### 3.8.1 Description of Conducted Band Edge Measurement

#### § 27.53 (n)(2)

For mobile operations in the 3450-3550 MHz band, the conducted power of any emission outside the licensee's authorized bandwidth shall not exceed  $-13$  dBm/MHz.

Compliance with this paragraph is based on the use of measurement instrumentation employing a resolution bandwidth of 1 megahertz or greater. However, in the 1 megahertz bands immediately outside and adjacent to the licensee's frequency block, a resolution bandwidth of at least one percent of the emission bandwidth of the fundamental emission of the transmitter may be employed, but limited to a maximum of 200 kHz. In the bands between 1 and 5 MHz removed from the licensee's frequency block, the minimum resolution bandwidth for the measurement shall be 500 kHz.

### 3.8.2 Test Procedures

1. The testing follows ANSI C63.26 section 5.7
2. The EUT was connected to spectrum analyzer and system simulator via a power divider.
3. The band edges of low and high channels for the highest RF powers were measured.
4. Set RBW  $\geq 1\%$  EBW but limited to a maximum of 200 kHz in the 1MHz band immediately outside and adjacent to the band edge.
5. Beyond the 1 MHz and 5 MHz removed from the band edge, set RBW  $\geq 500$ KHz.
6. Beyond the 5 MHz removed from the band edge, set RBW = 1MHz.
7. Offset has included the duty factor for Band n77/n78. Duty factor =  $10 \log (1/x)$ , where x is the measured duty cycle
8. Set spectrum analyzer with RMS detector.
9. The RF fundamental frequency should be excluded against the limit line in the operating frequency band.
10. Checked that all the results comply with the emission limit line.
11. When using the integration method, the starting frequency of the integration shall be centered at one-half of the RBW away from the band edge.

### 3.9 Conducted Spurious Emission Measurement

#### 3.9.1 Description of Conducted Spurious Emission Measurement

The power of any emission outside of the authorized operating frequency ranges shall not exceed -13 dBm/MHz.

It is measured by means of a calibrated spectrum analyzer and scanned from 9 kHz up to a frequency including its 10<sup>th</sup> harmonic.

#### 3.9.2 Test Procedures

1. The testing follows ANSI C63.26 section 5.7
2. The EUT was connected to spectrum analyzer and system simulator via a power divider.
3. The RF output of EUT was connected to the spectrum analyzer by RF cable and attenuator. The path loss was compensated to the results for each measurement.
4. The middle channel for the highest RF power within the transmitting frequency was measured.
5. The conducted spurious emission for the whole frequency range was taken.
6. Make the measurement with the spectrum analyzer's RBW = 1MHz, VBW = 3MHz.
7. Set spectrum analyzer with RMS detector.
8. Offset has included the duty factor for Band n77/n78. Duty factor =  $10 \log(1/x)$ , where x is the measured duty cycle
9. Taking the record of maximum spurious emission.
10. The RF fundamental frequency should be excluded against the limit line in the operating frequency band.
11. Checked that all the results comply with the emission limit line.

## 3.10 Frequency Stability Measurement

### 3.10.1 Description of Frequency Stability Measurement

The frequency stability shall be measured by variation of ambient temperature and variation of primary supply voltage to ensure that the fundamental emission stays within the authorized frequency block.

### 3.10.2 Test Procedures for Temperature Variation

1. The testing follows ANSI C63.26 section 5.6.4
2. The EUT was set up in the thermal chamber and connected with the system simulator.
3. With power OFF, the temperature was decreased to  $-30^{\circ}\text{C}$  and the EUT was stabilized before testing. Power was applied and the maximum change in frequency was recorded within one minute.
4. With power OFF, the temperature was raised in  $10^{\circ}\text{C}$  step up to  $50^{\circ}\text{C}$ . The EUT was stabilized at each step for at least half an hour. Power was applied and the maximum frequency change was recorded within one minute.

### 3.10.3 Test Procedures for Voltage Variation

1. The testing follows ANSI C63.26 section 5.6.5.
2. The EUT was placed in a temperature chamber at  $20\pm 5^{\circ}\text{C}$  and connected with the system simulator.
3. The power supply voltage to the EUT was varied from 85% to 115% of the nominal value for other than hand carried battery equipment.
4. For hand carried, battery powered equipment, reduce the primary ac or dc supply voltage to the battery operating end point, which shall be specified by the manufacturer.
5. The variation in frequency was measured for the worst case.

## 4. Radiated Test Items

### 4.1 Measuring Instruments

See list of measuring instruments of this test report.

### 4.2 Test Setup

#### 4.2.1 For radiated test below 30MHz

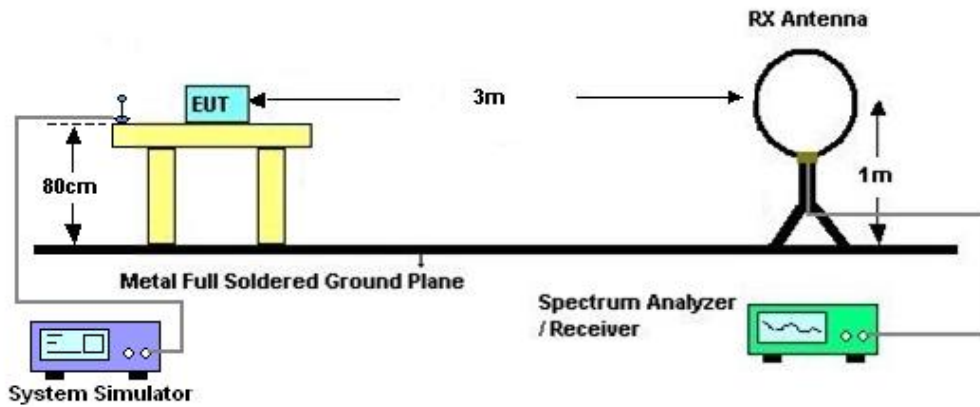

#### 4.2.2 For radiated test from 30MHz to 1GHz

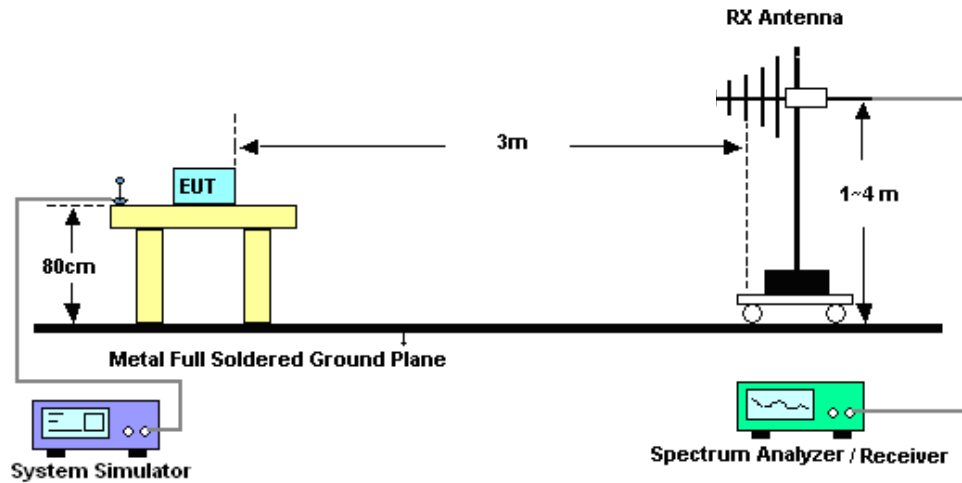

4.2.3 For radiated test above 1GHz

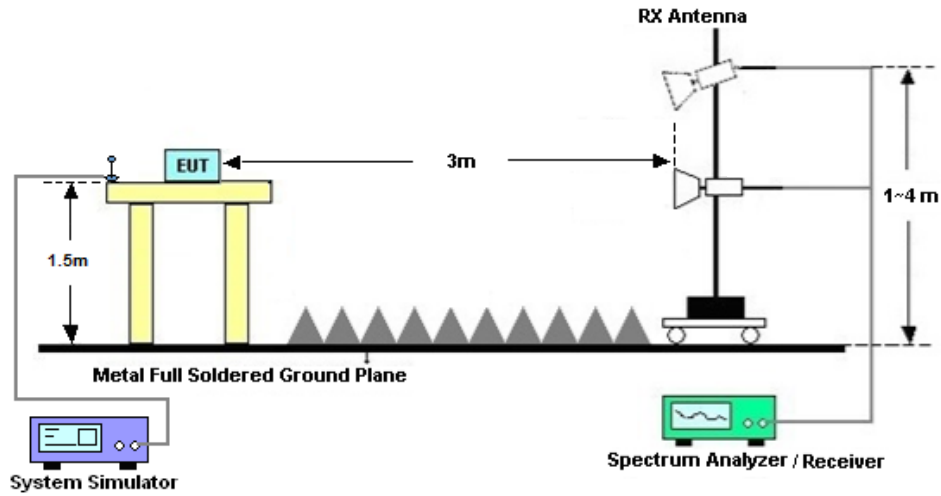

### 4.3 Test Result of Radiated Test

The low frequency, which started from 9 kHz to 30MHz, was pre-scanned and the result which was 20dB lower than the limit line was not reported.

Please refer to Appendix B.

## 4.4 Radiated Spurious Emission Measurement

### 4.4.1 Description of Radiated Spurious Emission

The radiated spurious emission was measured by substitution method according to ANSI/TIA-603-E. The power of any emission outside of the authorized operating frequency ranges shall not exceed -13 dBm/MHz.

The spectrum is scanned from 30 MHz up to a frequency including its 10th harmonic.

### 4.4.2 Test Procedures

1. The testing follows ANSI C63.26 Section 5.5
2. The EUT was placed on a turntable with 0.8 meter height for frequency below 1GHz and 1.5 meter height for frequency above 1GHz respectively above ground.
3. The EUT was set 3 meters from the receiving antenna mounted on the antenna tower.
4. The table was rotated 360 degrees to determine the position of the highest spurious emission.
5. The height of the receiving antenna is varied between 1m to 4m to search the maximum spurious emission for both horizontal and vertical polarizations.
6. During the measurement, the system simulator parameters were set to force the EUT transmitting at maximum output power.
7. Make the measurement with the spectrum analyzer's RBW = 1MHz, VBW = 3MHz, taking the record of maximum spurious emission.
8. A horn antenna was substituted in place of the EUT and was driven by a signal generator.
9. Tune the output power of signal generator to the same emission level with EUT maximum spurious emission.  
$$\text{EIRP (dBm)} = \text{S.G. Power} - \text{Tx Cable Loss} + \text{Tx Antenna Gain}$$
$$\text{ERP (dBm)} = \text{EIRP} - 2.15$$
10. The RF fundamental frequency should be excluded against the limit line in the operating frequency band.



## 5. List of Measuring Equipment

Instrument	Manufacturer	Model No.	Serial No.	Characteristics	Calibration Date	Test Date	Due Date	Remark
Spectrum Analyzer	R&S	FSV40	101040	10Hz~40GHz	Oct. 14, 2021	May 30, 2022~ Jul. 21, 2022	Oct. 13, 2022	Conducted (TH01-KS)
Power divider	STI	STI08-0055	-	0.5~40GHz	Aug. 26, 2021	May 30, 2022~ Jul. 21, 2022	Aug. 25, 2022	Conducted (TH01-KS)
Temperature & humidity chamber	Hongzhan	LP-150U	H2014011440	-40~+150°C 20%~95%RH	Jul. 12, 2021	May 30, 2022~ Jul. 21, 2022	Jul. 11, 2022	Conducted (TH01-KS)
Temperature & humidity chamber	Hongzhan	LP-150U	H2014011440	-40~+150°C 20%~95%RH	Jul. 11, 2022		Jul. 10, 2023	Conducted (TH01-KS)
EXA Spectrum Analyzer	Keysight	N9010B	MY57541079	10Hz-44G,MAX 30dB	Oct. 14, 2021	Jun. 24, 2022	Oct. 13, 2022	Radiation (03CH04-KS)
Loop Antenna	R&S	HFH2-Z2	100321	9kHz~30MHz	Oct. 30, 2021	Jun. 24, 2022	Oct. 29, 2022	Radiation (03CH04-KS)
Bilog Antenna	TeseQ	CBL6111D	49922	30MHz-1GHz	May 30, 2022	Jun. 24, 2022	May 29, 2023	Radiation (03CH04-KS)
Horn Antenna	Schwarzbeck	BBHA9120D	1284	1GHz~18GHz	Oct. 18, 2021	Jun. 24, 2022	Oct. 18, 2022	Radiation (03CH04-KS)
SHF-EHF Horn	Com-power	AH-840	101070	18GHz~40GHz	Jan. 05, 2022	Jun. 24, 2022	Jan. 04, 2023	Radiation (03CH04-KS)
Amplifier	SONOMA	310N	187289	9KHz-1GHz	Jan. 05, 2022	Jun. 24, 2022	Jan. 04, 2023	Radiation (03CH04-KS)
Amplifier	MITEQ	EM18G40G GA	060728	18~40GHz	Jan. 05, 2022	Jun. 24, 2022	Jan. 04, 2023	Radiation (03CH04-KS)
high gain Amplifier	MITEQ	AMF-7D-00 101800-30-1 0P	2025788	1Ghz-18Ghz	Jul. 30, 2021	Jun. 24, 2022	Jul. 29, 2022	Radiation (03CH04-KS)
Amplifier	Keysight	83017A	MY57280106	500MHz~26.5GHz	Oct. 13, 2021	Jun. 24, 2022	Oct. 12, 2022	Radiation (03CH04-KS)
AC Power Source	Chroma	61601	F104090004	N/A	NCR	Jun. 24, 2022	NCR	Radiation (03CH04-KS)
Turn Table	ChamPro	EM 1000-T	060762-T	0~360 degree	NCR	Jun. 24, 2022	NCR	Radiation (03CH04-KS)
Antenna Mast	ChamPro	EM 1000-A	060762-A	1 m~4 m	NCR	Jun. 24, 2022	NCR	Radiation (03CH04-KS)

NCR: No Calibration Required



## 6. Uncertainty of Evaluation

The measurement uncertainties shown below were calculated in accordance with the requirements of ANSI 63.26-2015. All the measurement uncertainty value were shown with a coverage  $K=2$  to indicate 95% level of confidence. The measurement data show herein meets or exceeds the CISPR measurement uncertainty values specified in CISPR 16-4-2 and can be compared directly to specified limit to determine compliance.

### Uncertainty of Radiated Emission Measurement (30 MHz ~ 1000 MHz)

Measuring Uncertainty for a Level of Confidence of 95% ( $U = 2Uc(y)$ )	3.3 dB
---	--------

### Uncertainty of Radiated Emission Measurement (1 GHz ~ 18 GHz)

Measuring Uncertainty for a Level of Confidence of 95% ( $U = 2Uc(y)$ )	2.8 dB
---	--------

### Uncertainty of Radiated Emission Measurement (18 GHz ~ 40 GHz)

Measuring Uncertainty for a Level of Confidence of 95% ( $U = 2Uc(y)$ )	2.8 dB
---	--------

## Appendix A. Test Results of Conducted Test

Test Engineer :	Simle Wang	Temperature :	22~23°C
		Relative Humidity :	45~51%

### Conducted Output Power(Average power) and EIRP

5G NR n77										
BW [MHz]	Modulation	RB Size	RB Offset	Power Low Ch. / Freq.	Power Middle Ch. / Freq.	Power High Ch. / Freq.	Gain	EIRP	EIRP	EIRP
Channel				633334	633334	633334		L	M	H
Frequency (MHz)				3500.01	3500.01	3500.01				
100	PI/2 BPSK	1	1		24.96		0.4		0.3436	
100	PI/2 BPSK	1	137		25.46		0.4		0.3855	
100	PI/2 BPSK	1	271		25.19		0.4		0.3622	
100	PI/2 BPSK	135	0		24.70		0.4		0.3236	
100	PI/2 BPSK	135	67		25.26		0.4		0.3681	
100	PI/2 BPSK	135	138		24.77		0.4		0.3289	
100	PI/2 BPSK	270	0		24.63		0.4		0.3184	
100	QPSK	1	1		24.82		0.4		0.3327	
100	QPSK	1	137		25.21		0.4		0.3639	
100	QPSK	1	271		25.01		0.4		0.3475	
100	QPSK	135	0		24.20		0.4		0.2884	
100	QPSK	135	67		25.29		0.4		0.3707	
100	QPSK	135	138		24.28		0.4		0.2938	
100	QPSK	270	0		24.10		0.4		0.2818	
100	16QAM	1	1		24.08		0.4		0.2805	
100	64QAM	1	1		22.04		0.4		0.1754	
100	256QAM	1	1		20.32		0.4		0.1180	
Channel				632668	633334	634000	Gain	EIRP	EIRP	EIRP
Frequency (MHz)				3490.02	3500.01	3510				
80	PI/2 BPSK	1	1	24.92	24.95	24.89	0.4	0.3404	0.3428	0.3381
80	QPSK	1	1	24.85	24.91	24.77	0.4	0.3350	0.3396	0.3289



80	16QAM	1	1	24.12	24.05	24.21	0.4	0.2831	0.2786	0.2891
Channel				632000	633334	634668	Gain	EIRP	EIRP	EIRP
Frequency (MHz)				3480	3500.01	3520.02				
60	PI/2 BPSK	1	1	24.90	24.88	25.25	0.4	0.3388	0.3373	0.3673
60	QPSK	1	1	24.75	24.85	24.63	0.4	0.3273	0.3350	0.3184
60	16QAM	1	1	24.22	24.13	24.06	0.4	0.2897	0.2838	0.2793
Channel				631334	633334	635334	Gain	EIRP	EIRP	EIRP
Frequency (MHz)				3470.01	3500.01	3530.01				
40	PI/2 BPSK	1	1	25.43	25.36	25.34	0.4	0.3828	0.3767	0.3750
40	QPSK	1	1	25.33	25.13	25.17	0.4	0.3741	0.3573	0.3606
40	16QAM	1	1	24.36	24.52	24.44	0.4	0.2992	0.3105	0.3048
Channel				631000	633334	635668	Gain	EIRP	EIRP	EIRP
Frequency (MHz)				3465	3500.01	3535.02				
30	PI/2 BPSK	1	1	25.26	25.41	25.29	0.4	0.3681	0.3811	0.3707
30	QPSK	1	1	25.13	25.36	25.17	0.4	0.3573	0.3767	0.3606
30	16QAM	1	1	24.56	24.63	24.81	0.4	0.3133	0.3184	0.3319
Channel				630668	633334	636000	Gain	EIRP	EIRP	EIRP
Frequency (MHz)				3460.02	3500.01	3540				
20	PI/2 BPSK	1	1	25.40	25.45	25.39	0.4	0.3802	0.3846	0.3793
20	QPSK	1	1	25.36	25.44	25.31	0.4	0.3767	0.3837	0.3724
20	16QAM	1	1	24.51	24.36	24.28	0.4	0.3097	0.2992	0.2938



5G NR n78										
BW [MHz]	Modulation	RB Size	RB Offset	Power Low Ch. / Freq.	Power Middle Ch. / Freq.	Power High Ch. / Freq.	Gain	EIRP	EIRP	EIRP
Channel				633334	633334	633334		L	M	H
Frequency (MHz)				3500.01	3500.01	3500.01				
100	PI/2 BPSK	1	1		25.36		0.4		0.3767	
100	PI/2 BPSK	1	137		25.81		0.4		0.4178	
100	PI/2 BPSK	1	271		25.35		0.4		0.3758	
100	PI/2 BPSK	135	0		24.59		0.4		0.3155	
100	PI/2 BPSK	135	67		25.66		0.4		0.4036	
100	PI/2 BPSK	135	138		24.46		0.4		0.3062	
100	PI/2 BPSK	270	0		24.53		0.4		0.3112	
100	QPSK	1	1		25.35		0.4		0.3758	
100	QPSK	1	137		25.66		0.4		0.4036	
100	QPSK	1	271		25.36		0.4		0.3767	
100	QPSK	135	0		24.56		0.4		0.3133	
100	QPSK	135	67		25.63		0.4		0.4009	
100	QPSK	135	138		24.44		0.4		0.3048	
100	QPSK	270	0		24.56		0.4		0.3133	
100	16QAM	1	1		24.59		0.4		0.3155	
100	64QAM	1	1		22.29		0.4		0.1858	
100	256QAM	1	1		20.86		0.4		0.1337	
Channel				633000	633334	633668	Gain	EIRP	EIRP	EIRP
Frequency (MHz)				3495	3500.01	3505.02				
90	PI/2 BPSK	1	1	25.44	25.41	25.38	0.4	0.3837	0.3811	0.3784
90	QPSK	1	1	25.42	25.36	25.28	0.4	0.3819	0.3767	0.3698
90	16QAM	1	1	24.63	24.52	24.39	0.4	0.3184	0.3105	0.3013
Channel				632668	633334	634000	Gain	EIRP	EIRP	EIRP
Frequency (MHz)				3490.02	3500.01	3510				
80	PI/2 BPSK	1	1	25.36	25.41	25.52	0.4	0.3767	0.3811	0.3908
80	QPSK	1	1	25.24	25.36	25.46	0.4	0.3664	0.3767	0.3855
80	16QAM	1	1	24.36	24.43	24.36	0.4	0.2992	0.3041	0.2992
Channel				632334	633334	634334	Gain	EIRP	EIRP	EIRP



Frequency (MHz)				3485.01	3500.01	3515.01				
70	PI/2 BPSK	1	1	25.42	25.48	25.36	0.4	0.3819	0.3873	0.3767
70	QPSK	1	1	25.31	25.14	25.22	0.4	0.3724	0.3581	0.3648
70	16QAM	1	1	24.36	24.45	24.61	0.4	0.2992	0.3055	0.3170
Channel				632000	633334	634668	Gain	EIRP	EIRP	EIRP
Frequency (MHz)				3480	3500.01	3520.02				
60	PI/2 BPSK	1	1	25.58	25.52	25.56	0.4	0.3963	0.3908	0.3945
60	QPSK	1	1	25.46	25.41	25.36	0.4	0.3855	0.3811	0.3767
60	16QAM	1	1	24.63	24.52	24.46	0.4	0.3184	0.3105	0.3062
Channel				631668	633334	635000	Gain	EIRP	EIRP	EIRP
Frequency (MHz)				3475.02	3500.01	3525				
50	PI/2 BPSK	1	1	25.41	25.43	25.59	0.4	0.3811	0.3828	0.3972
50	QPSK	1	1	25.36	25.21	25.54	0.4	0.3767	0.3639	0.3926
50	16QAM	1	1	24.69	24.58	24.61	0.4	0.3228	0.3148	0.3170
Channel				631334	633334	635334	Gain	EIRP	EIRP	EIRP
Frequency (MHz)				3470.01	3500.01	3530.01				
40	PI/2 BPSK	1	1	25.70	25.75	25.69	0.4	0.4074	0.4121	0.4064
40	QPSK	1	1	25.69	25.52	25.65	0.4	0.4064	0.3908	0.4027
40	16QAM	1	1	24.75	24.63	24.70	0.4	0.3273	0.3184	0.3236
Channel				631000	633334	635668	Gain	EIRP	EIRP	EIRP
Frequency (MHz)				3465	3500.01	3535.02				
30	PI/2 BPSK	1	1	25.72	25.75	25.62	0.4	0.4093	0.4121	0.3999
30	QPSK	1	1	25.63	25.55	25.41	0.4	0.4009	0.3936	0.3811
30	16QAM	1	1	24.85	24.74	24.63	0.4	0.3350	0.3266	0.3184
Channel				630668	633334	636000	Gain	EIRP	EIRP	EIRP
Frequency (MHz)				3460.02	3500.01	3540				
20	PI/2 BPSK	1	1	25.76	25.73	25.56	0.4	0.4130	0.4102	0.3945
20	QPSK	1	1	25.63	25.55	25.36	0.4	0.4009	0.3936	0.3767
20	16QAM	1	1	24.74	24.52	24.63	0.4	0.3266	0.3105	0.3184



# FR1 n78

## Peak-to-Average Ratio

Mode	FR1 n78 / 20MHz / DFT-S OFDM				
Mod.	20M				Limit: 13dB
RB Size	BPSK	QPSK			Result
Middle CH	5.46	5.42			PASS

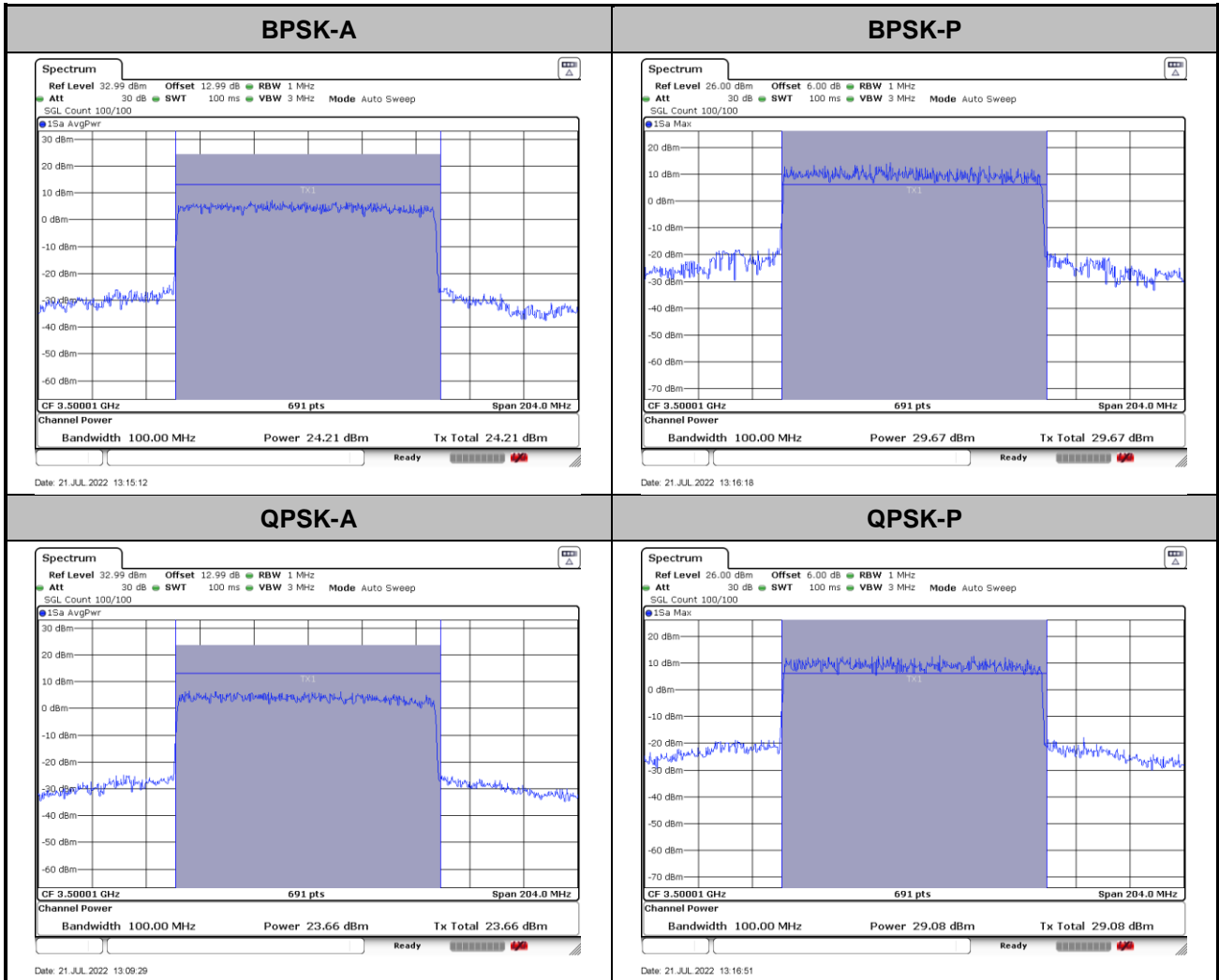



**26dB Bandwidth**

Mode	FR1 n78 : 26dB BW(20 MHz) / CP OFDM				
BW	CP				
Mod.		QPSK	16QAM	64QAM	256QAM
Middle CH		19.94	20.10	20.22	20.34
Mode	FR1 n78 : 26dB BW(30 MHz) / CP OFDM				
BW	CP				
Mod.		QPSK	16QAM	64QAM	256QAM
Middle CH		27.99	28.11	28.17	27.69
Mode	FR1 n78 : 26dB BW(40 MHz) / CP OFDM				
BW	CP				
Mod.		QPSK	16QAM	64QAM	256QAM
Middle CH		38.12	38.12	38.20	38.04
Mode	FR1 n78 : 26dB BW(50 MHz) / CP OFDM				
BW	CP				
Mod.		QPSK	16QAM	64QAM	256QAM
Middle CH		48.05	47.95	47.95	47.95
Mode	FR1 n78 : 26dB BW(60 MHz) / CP OFDM				
BW	CP				
Mod.		QPSK	16QAM	64QAM	256QAM
Middle CH		62.58	62.82	62.46	62.82
Mode	FR1 n78 : 26dB BW(70 MHz) / CP OFDM				
BW	CP				
Mod.		QPSK	16QAM	64QAM	256QAM
Middle CH		69.09	68.67	68.81	68.81
Mode	FR1 n78 : 26dB BW(80 MHz) / CP OFDM				
BW	CP				
Mod.		QPSK	16QAM	64QAM	256QAM
Middle CH		82.00	82.16	82.00	81.84
Mode	FR1 n78 : 26dB BW(90 MHz) / CP OFDM				
BW	CP				
Mod.		QPSK	16QAM	64QAM	256QAM
Middle CH		91.53	91.53	91.53	91.35
Mode	FR1 n78 : 26dB BW(100 MHz) / CP OFDM				
BW	CP				
Mod.		QPSK	16QAM	64QAM	256QAM
Middle CH		101.7	101.5	101.3	101.3





20MHz CP

QPSK

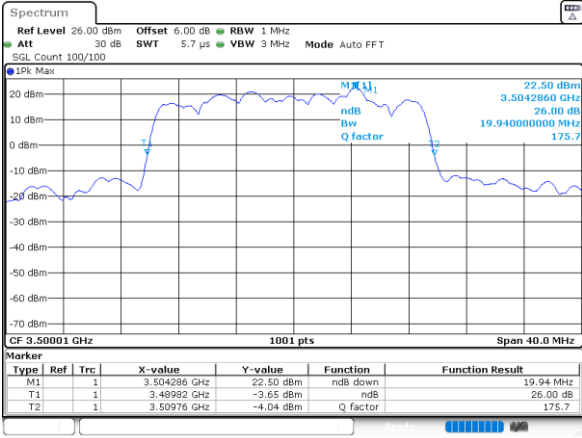

Date: 30.MAY.2022 21:28:45

16QAM

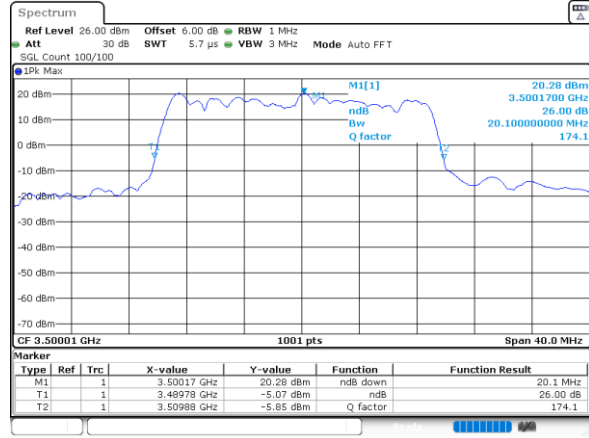

Date: 30.MAY.2022 21:29:10

64QAM

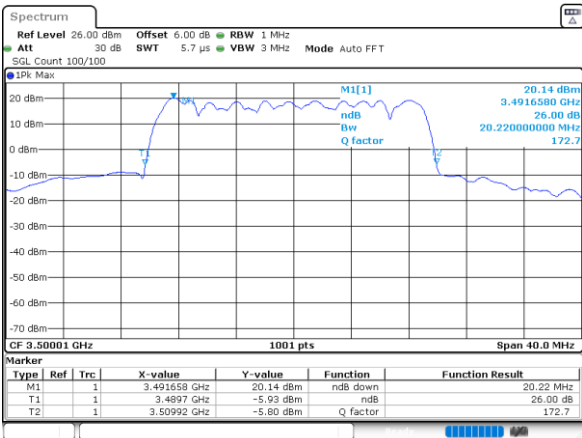

Date: 30.MAY.2022 21:29:43

256QAM

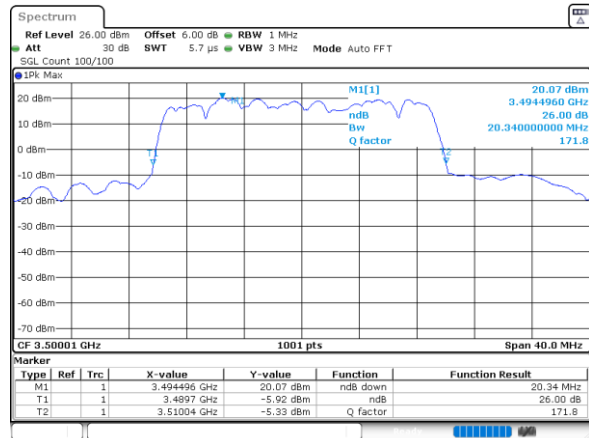

Date: 30.MAY.2022 21:30:05



30MHz CP

QPSK

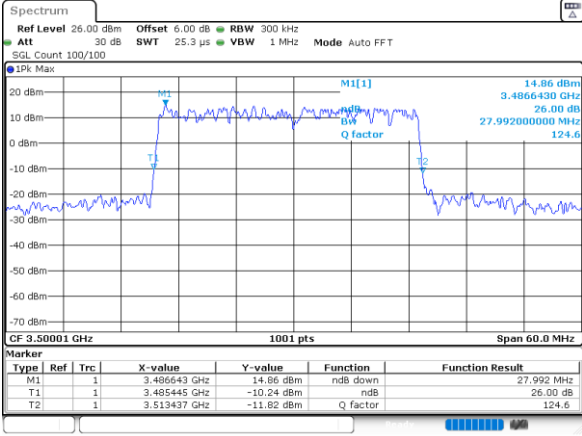

Date: 30.MAY.2022 21:24:17

16QAM

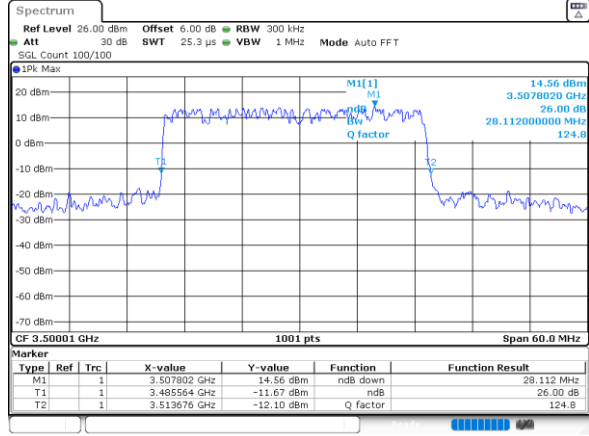

Date: 30.MAY.2022 21:25:06

64QAM

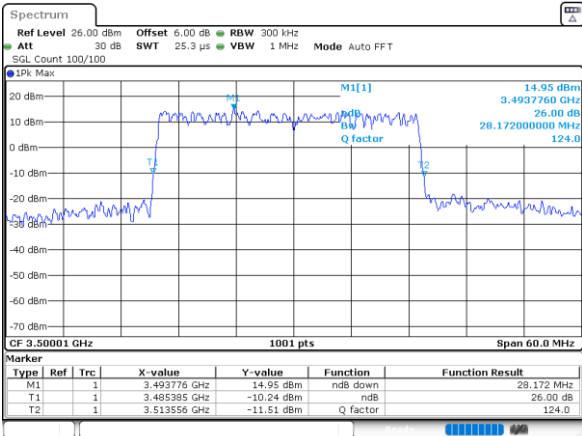

Date: 30.MAY.2022 21:26:17

256QAM

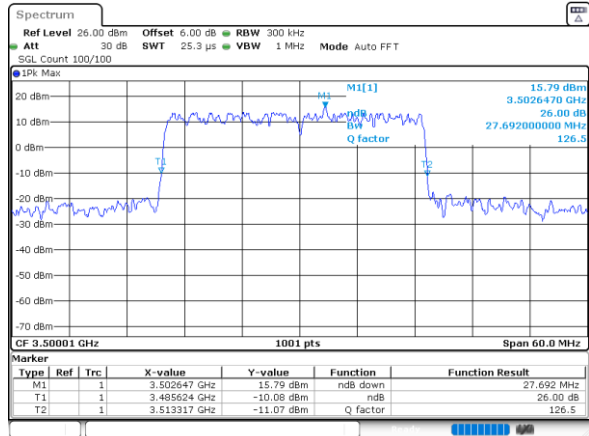

Date: 30.MAY.2022 21:26:54



40MHz CP

QPSK

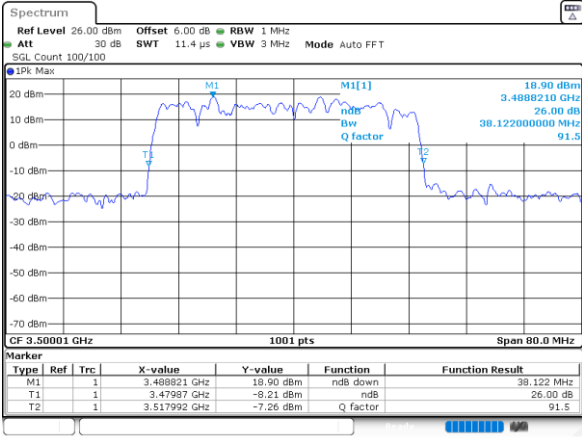

Date: 30.MAY.2022 21:19:04

16QAM

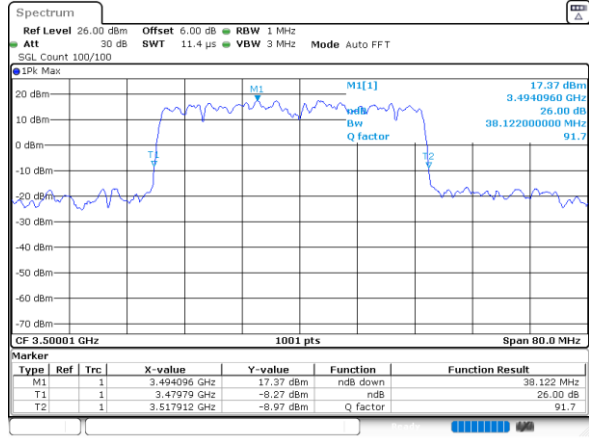

Date: 30.MAY.2022 21:19:47

64QAM

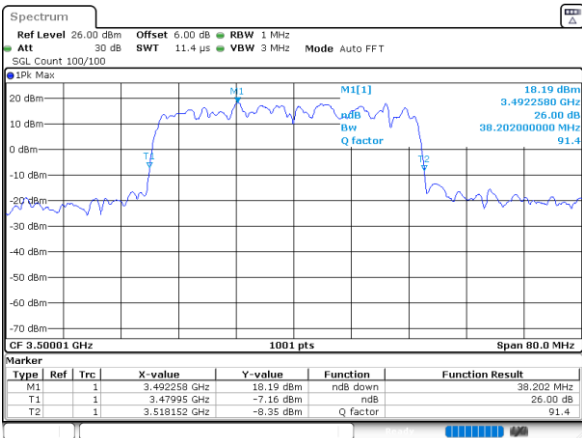

Date: 30.MAY.2022 21:20:22

256QAM

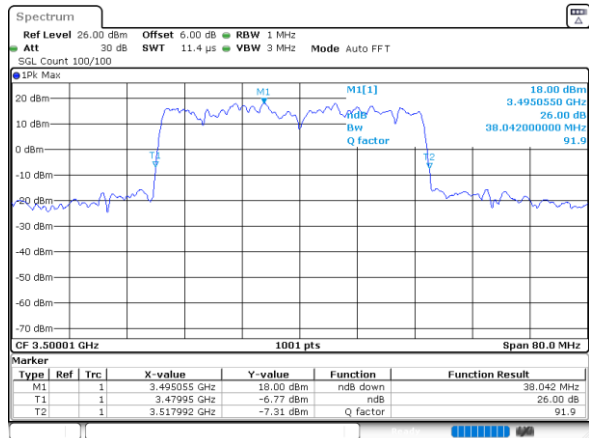

Date: 30.MAY.2022 21:20:58



50MHz CP

QPSK

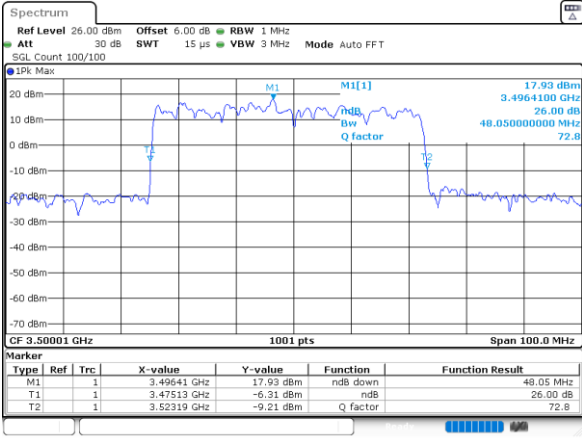

Date: 30.MAY.2022 21:16:07

16QAM

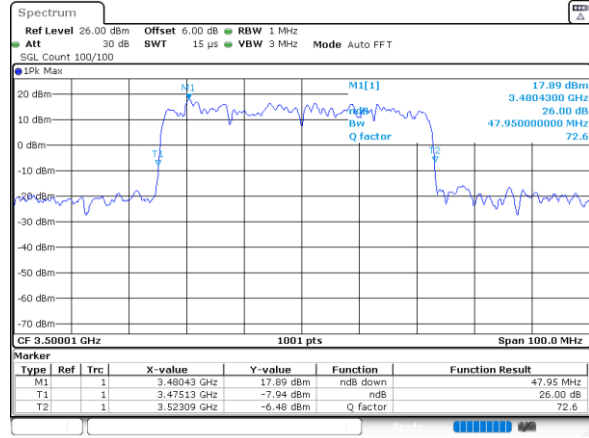

Date: 30.MAY.2022 21:16:30

64QAM

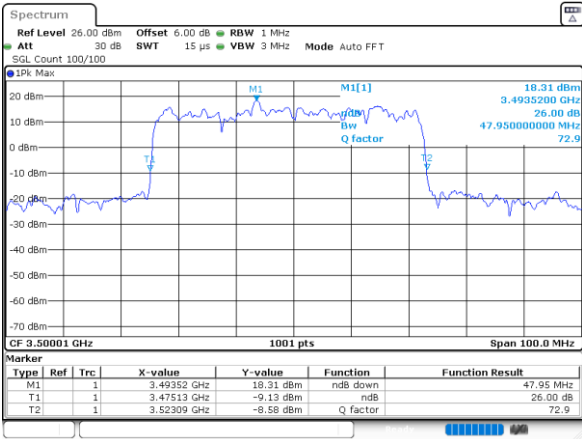

Date: 30.MAY.2022 21:17:11

256QAM

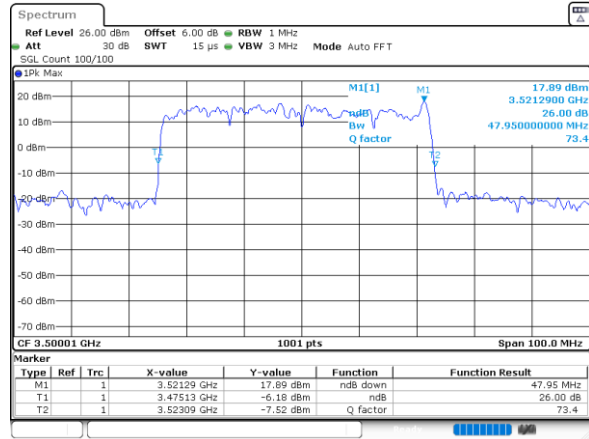

Date: 30.MAY.2022 21:17:40



60MHz CP

QPSK

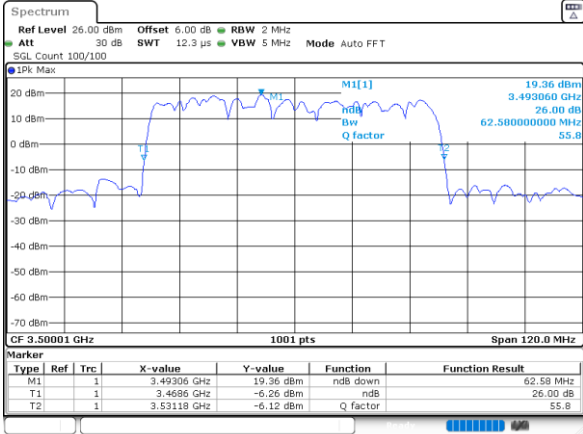

Date: 30.MAY.2022 21:12:25

16QAM

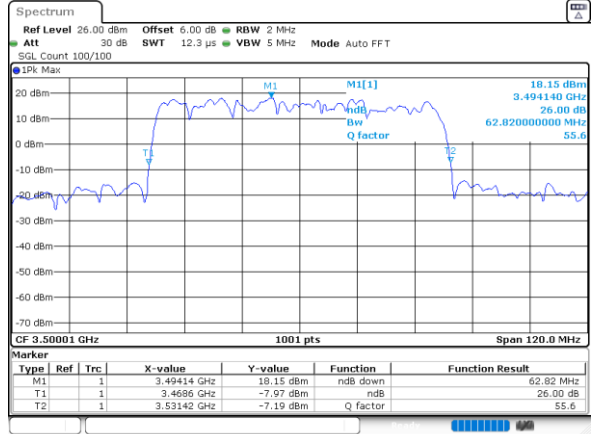

Date: 30.MAY.2022 21:13:00

64QAM

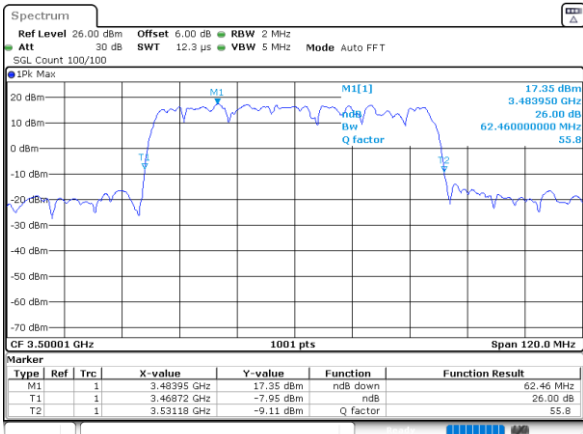

Date: 30.MAY.2022 21:13:24

256QAM

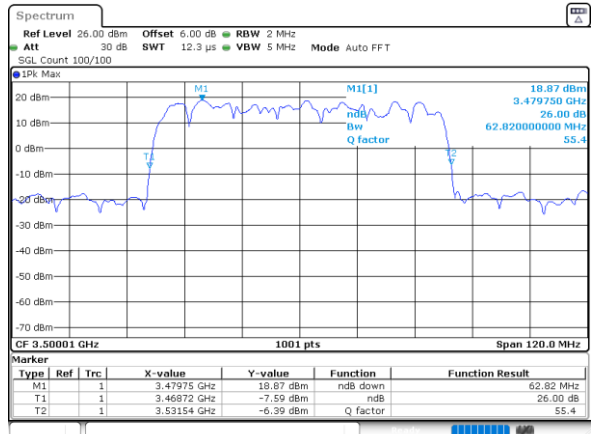

Date: 30.MAY.2022 21:13:55



70MHz CP

QPSK

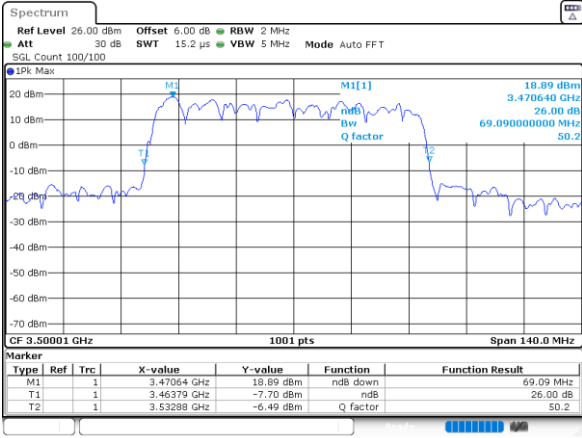

Date: 30.MAY.2022 21:08:41

16QAM

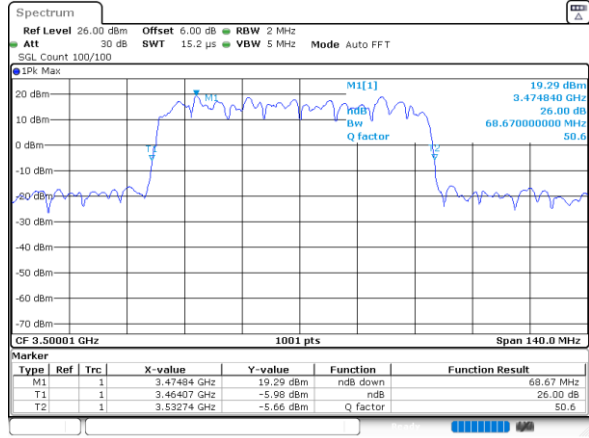

Date: 30.MAY.2022 21:09:40

64QAM

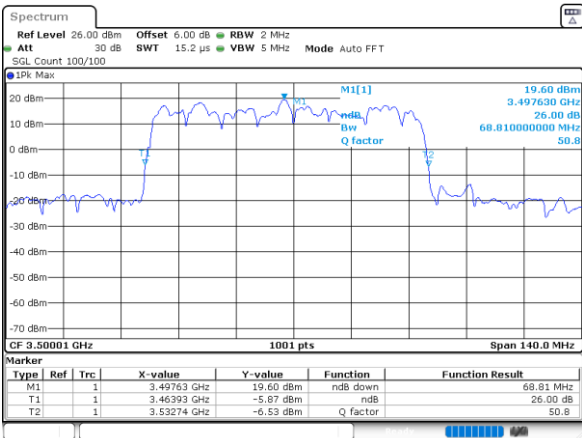

Date: 30.MAY.2022 21:10:23

256QAM

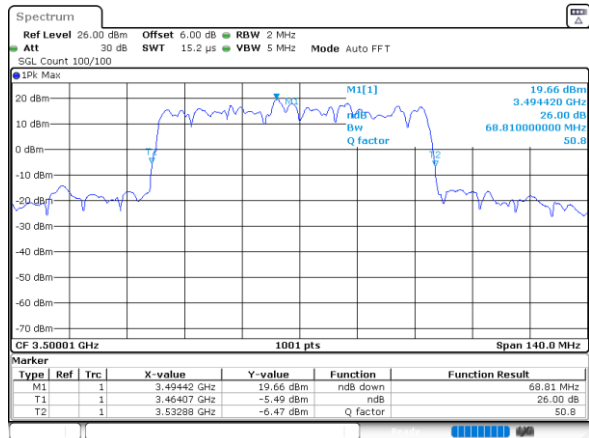

Date: 30.MAY.2022 21:11:10

80MHz CP

QPSK

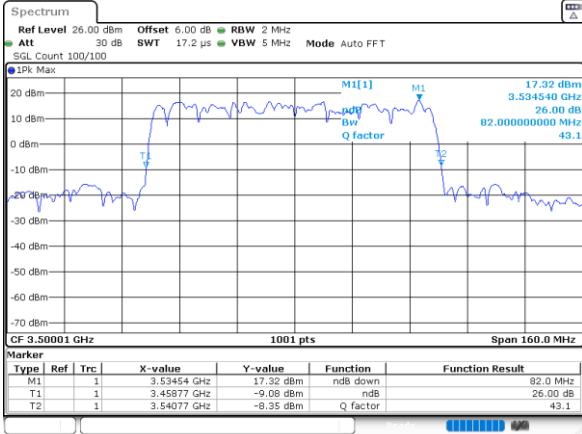

Date: 30.MAY.2022 21:04:05

16QAM

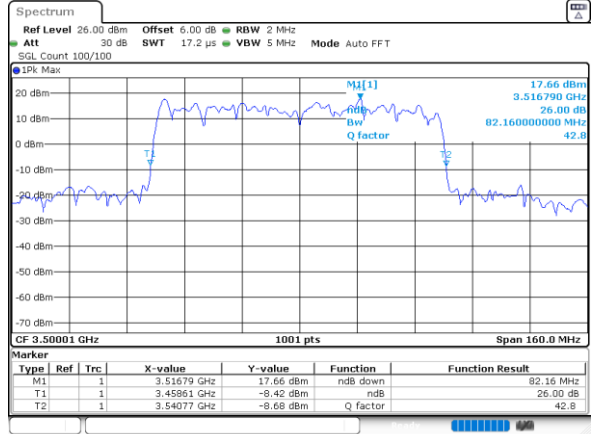

Date: 30.MAY.2022 21:04:38

64QAM

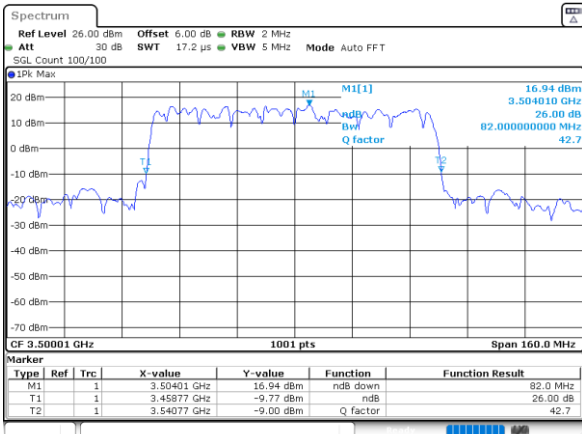

Date: 30.MAY.2022 21:05:12

256QAM

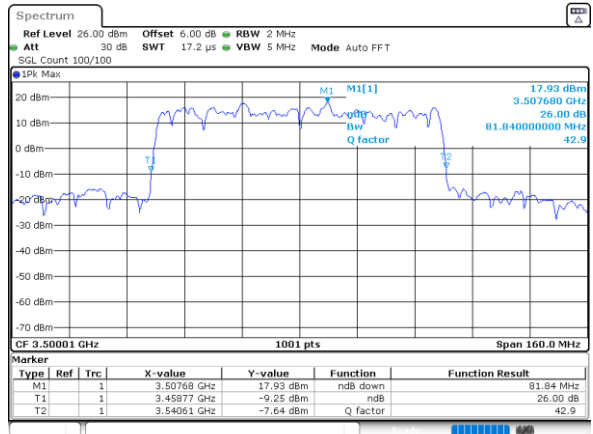

Date: 30.MAY.2022 21:05:50



90MHz CP

QPSK

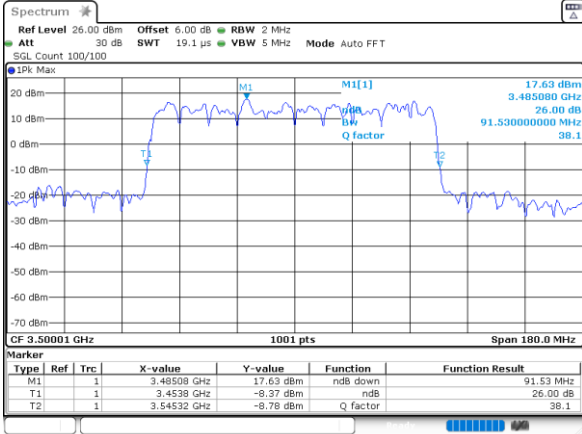

Date: 30.MAY.2022 20:55:34

16QAM

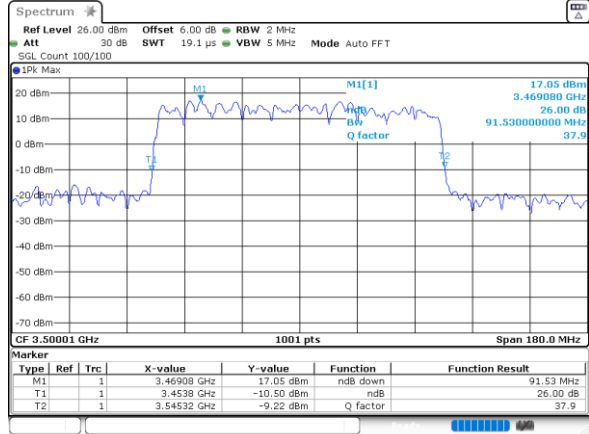

Date: 30.MAY.2022 20:57:08

64QAM

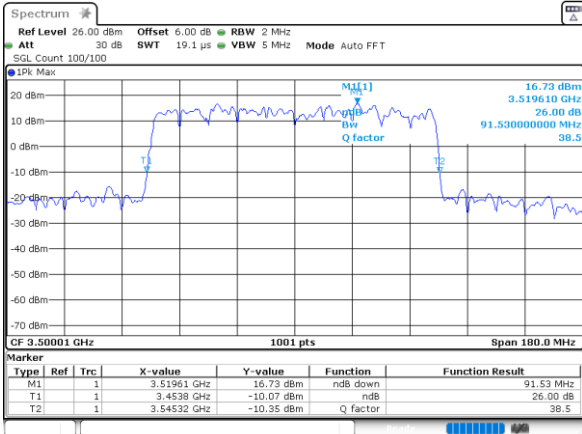

Date: 30.MAY.2022 21:00:02

256QAM

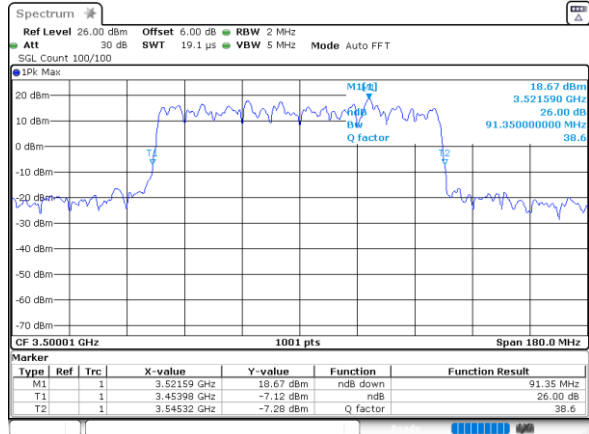

Date: 30.MAY.2022 21:01:08





100MHz CP

QPSK

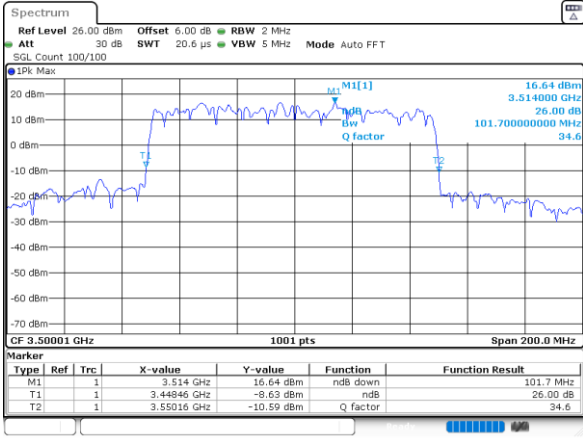

Date: 30.MAY.2022 20:49:46

16QAM

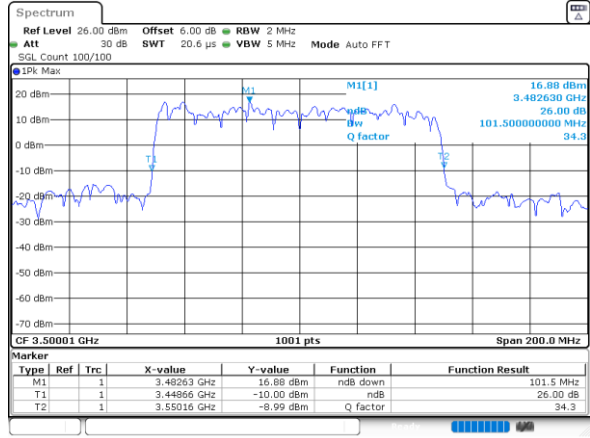

Date: 30.MAY.2022 20:50:19

64QAM

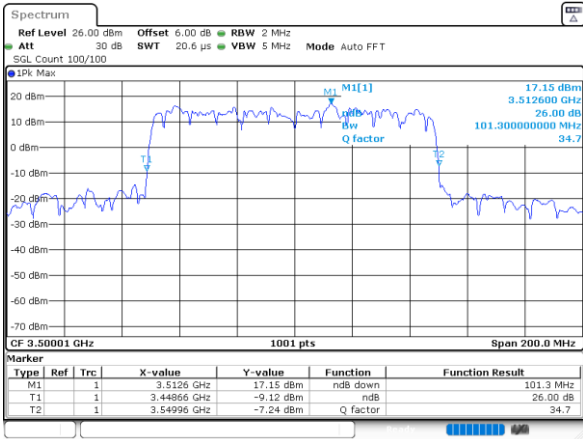

Date: 30.MAY.2022 20:50:54

256QAM

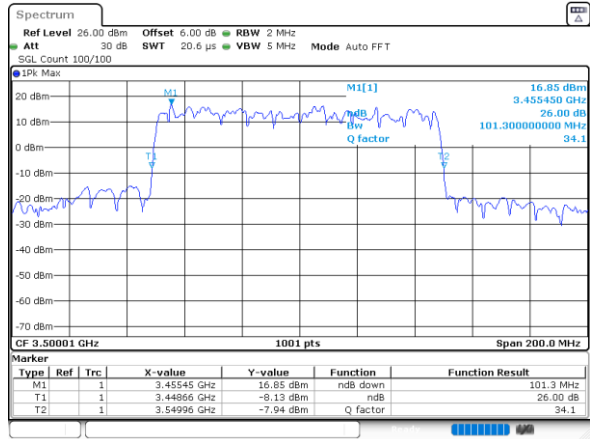

Date: 30.MAY.2022 20:51:33

## Occupied Bandwidth

Mode	FR1 n78 : OB BW(20 MHz) / CP OFDM				
BW	CP				
Mod.		QPSK	16QAM	64QAM	256QAM
Middle CH		18.42	18.30	18.54	18.42
Mode	FR1 n78 : OB BW(30 MHz) / CP OFDM				
BW	CP				
Mod.		QPSK	16QAM	64QAM	256QAM
Middle CH		26.79	26.85	26.67	26.79
Mode	FR1 n78 : OB BW(40 MHz) / CP OFDM				
BW	CP				
Mod.		QPSK	16QAM	64QAM	256QAM
Middle CH		36.12	35.88	36.04	35.96
Mode	FR1 n78 : OB BW(50 MHz) / CP OFDM				
BW	CP				
Mod.		QPSK	16QAM	64QAM	256QAM
Middle CH		45.85	46.15	45.45	45.85
Mode	FR1 n78 : OB BW(60 MHz) / CP OFDM				
BW	CP				
Mod.		QPSK	16QAM	64QAM	256QAM
Middle CH		58.62	58.38	58.26	58.26
Mode	FR1 n78 : OB BW(70 MHz) / CP OFDM				
BW	CP				
Mod.		QPSK	16QAM	64QAM	256QAM
Middle CH		64.34	64.76	64.90	65.03
Mode	FR1 n78 : OB BW(80 MHz) / CP OFDM				
BW	CP				
Mod.		QPSK	16QAM	64QAM	256QAM
Middle CH		76.88	77.36	78.00	77.84
Mode	FR1 n78 : OB BW(90 MHz) / CP OFDM				
BW	CP				
Mod.		QPSK	16QAM	64QAM	256QAM
Middle CH		87.21	87.39	87.21	87.03
Mode	FR1 n78 : OB BW(100 MHz) / CP OFDM				
BW	CP				
Mod.		QPSK	16QAM	64QAM	256QAM
Middle CH		95.90	96.90	97.10	96.30



20MHz CP

QPSK

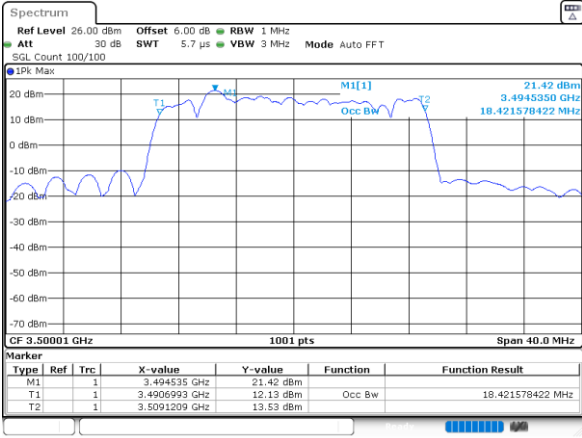

Date: 30.MAY.2022 21:28:36

16QAM

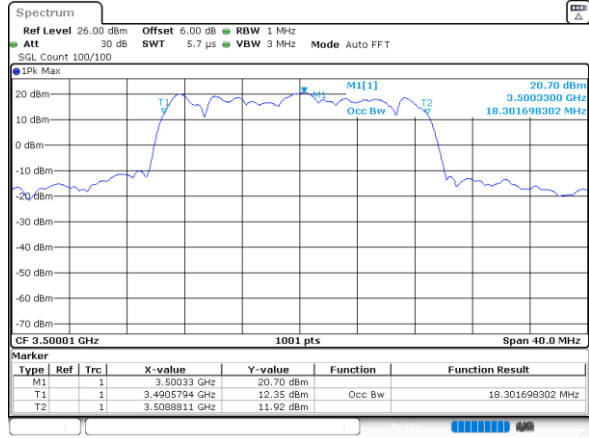

Date: 30.MAY.2022 21:29:02

64QAM

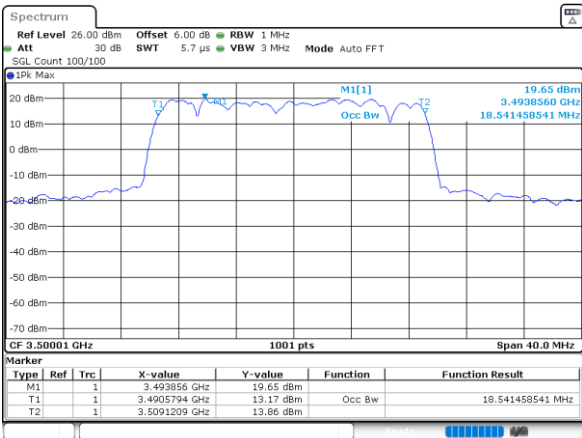

Date: 30.MAY.2022 21:29:29

256QAM

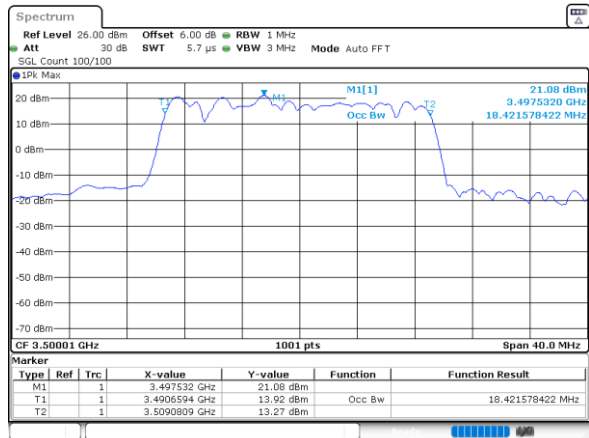

Date: 30.MAY.2022 21:29:57



30MHz CP

QPSK

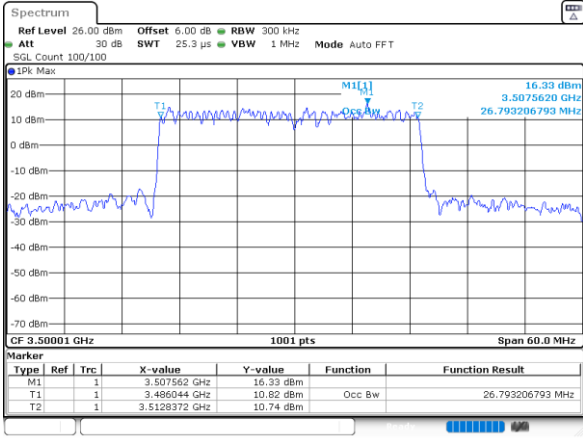

Date: 30.MAY.2022 21:24:03

16QAM

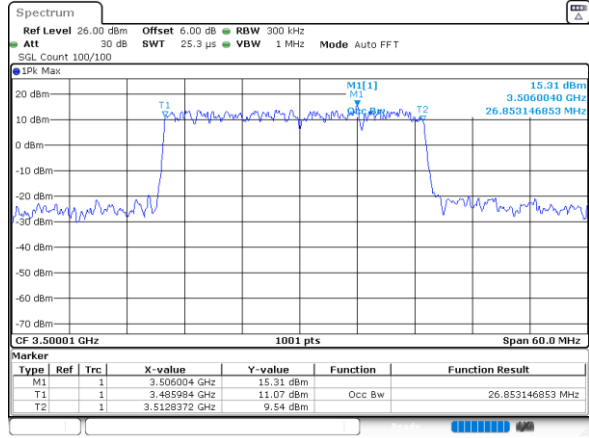

Date: 30.MAY.2022 21:24:50

64QAM

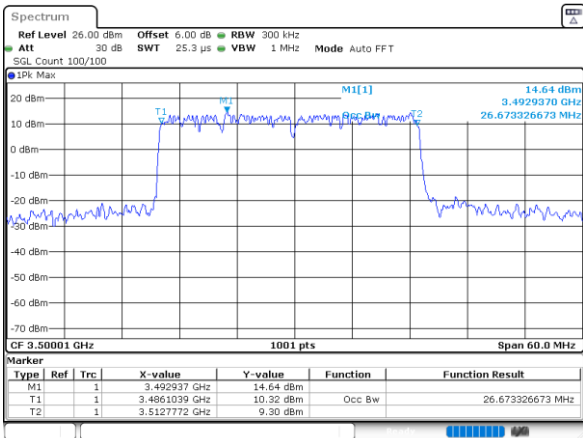

Date: 30.MAY.2022 21:26:01

256QAM

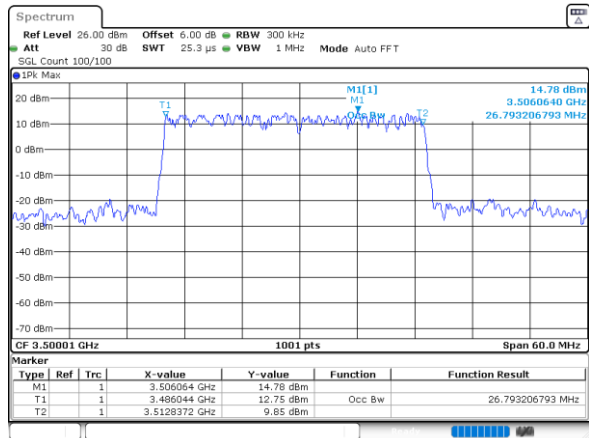

Date: 30.MAY.2022 21:26:41



40MHz CP

QPSK

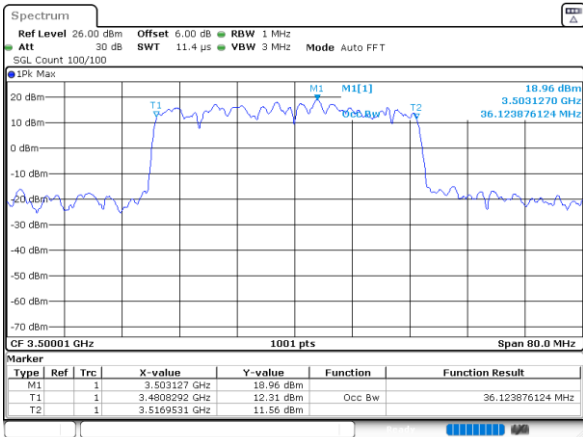

Date: 30.MAY.2022 21:18:57

16QAM

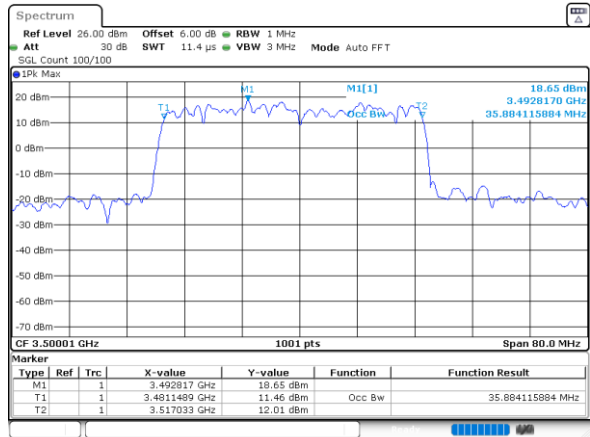

Date: 30.MAY.2022 21:19:39

64QAM

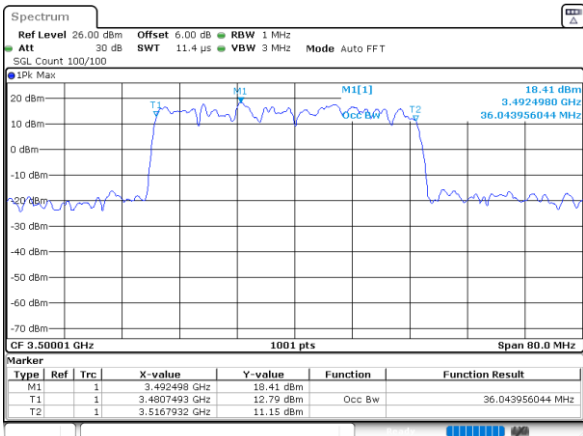

Date: 30.MAY.2022 21:20:15

256QAM

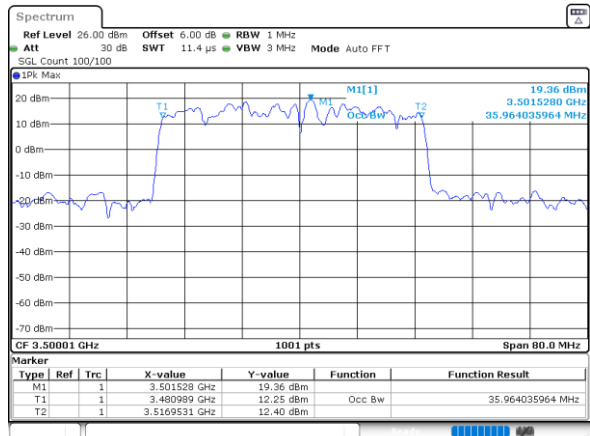

Date: 30.MAY.2022 21:20:51



50MHz CP

QPSK

16QAM

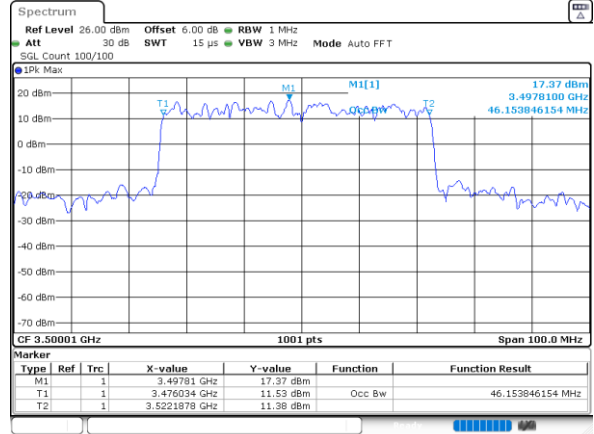
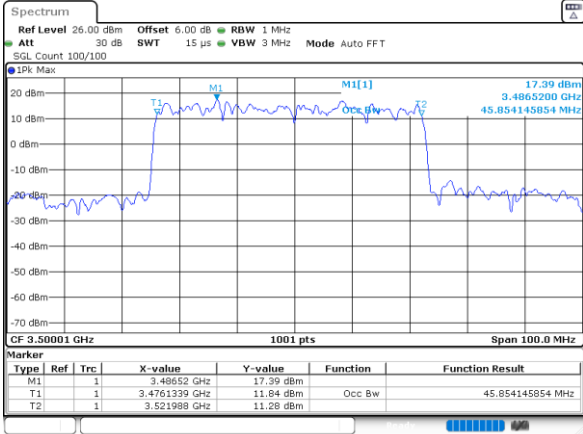

Date: 30.MAY.2022 21:15:59

Date: 30.MAY.2022 21:16:21

64QAM

256QAM

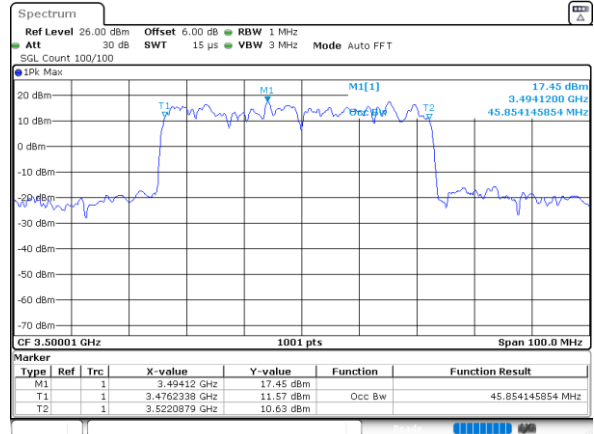
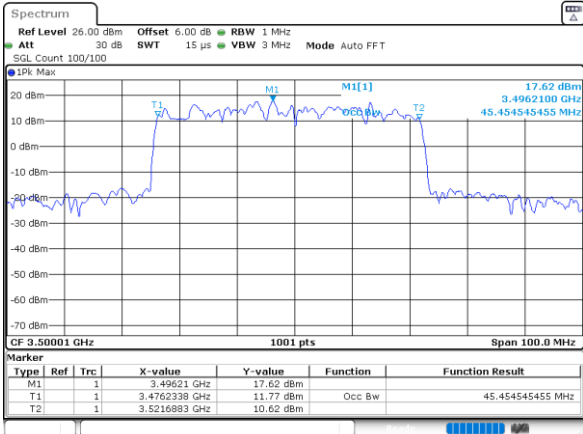

Date: 30.MAY.2022 21:17:00

Date: 30.MAY.2022 21:17:27



60MHz CP

QPSK

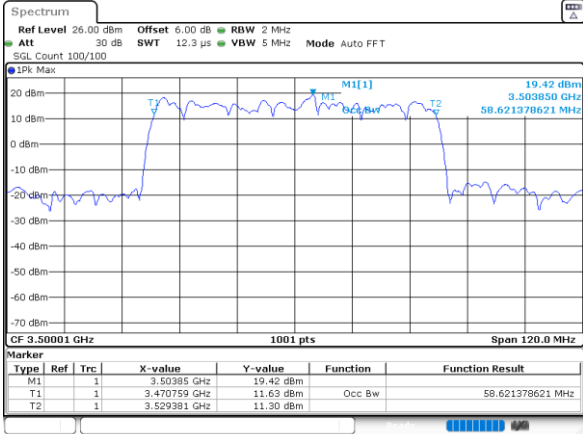

Date: 30.MAY.2022 21:12:16

16QAM

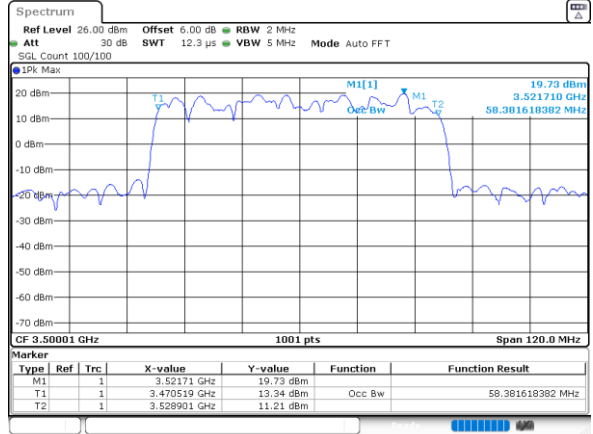

Date: 30.MAY.2022 21:12:48

64QAM

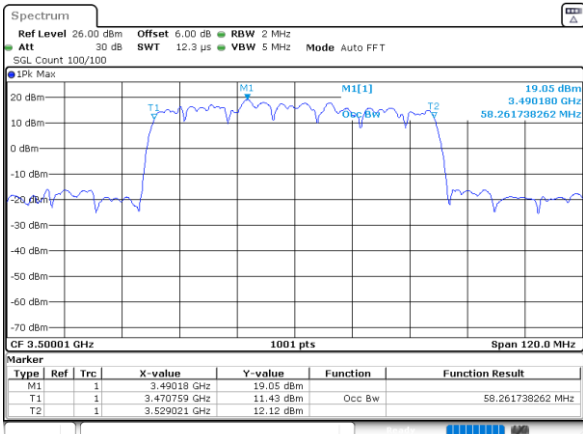

Date: 30.MAY.2022 21:13:15

256QAM

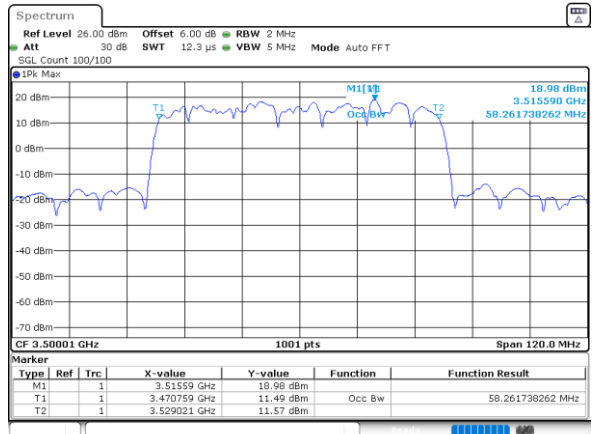

Date: 30.MAY.2022 21:13:47



70MHz CP

QPSK

16QAM

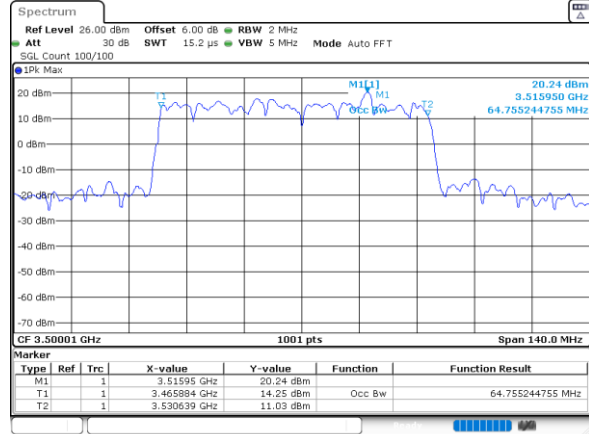
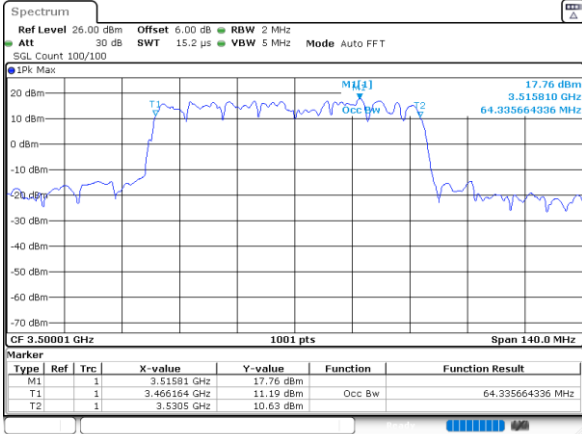

Date: 30.MAY.2022 21:08:23

Date: 30.MAY.2022 21:09:12

64QAM

256QAM

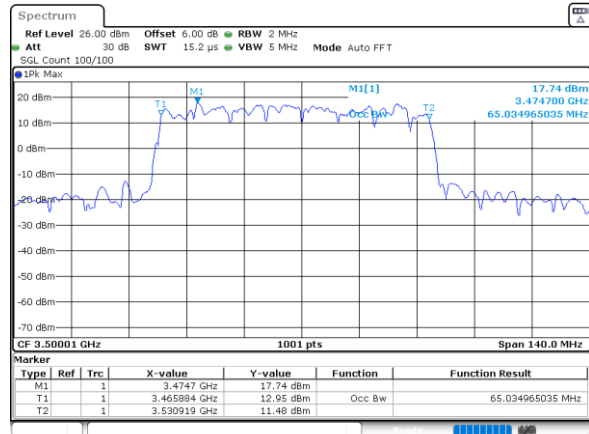
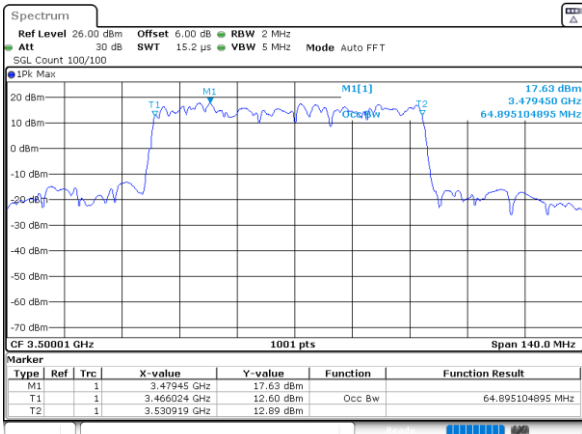

Date: 30.MAY.2022 21:10:07

Date: 30.MAY.2022 21:10:54





80MHz CP

QPSK

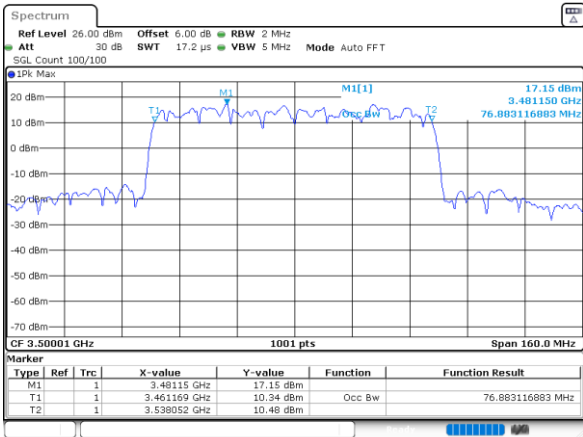

Date: 30.MAY.2022 21:03:51

16QAM

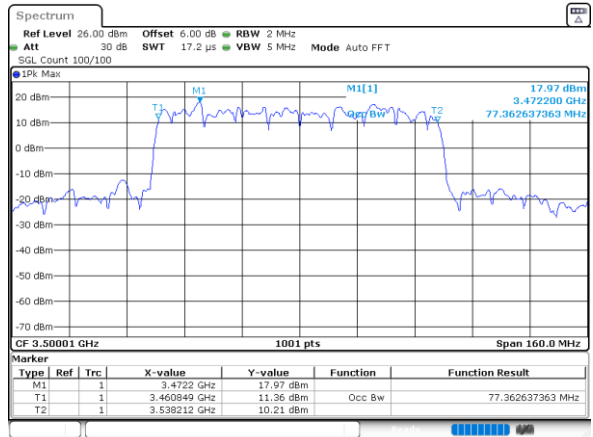

Date: 30.MAY.2022 21:04:27

64QAM

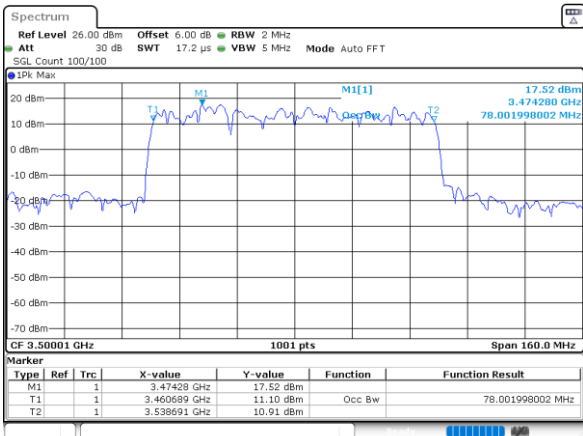

Date: 30.MAY.2022 21:05:01

256QAM

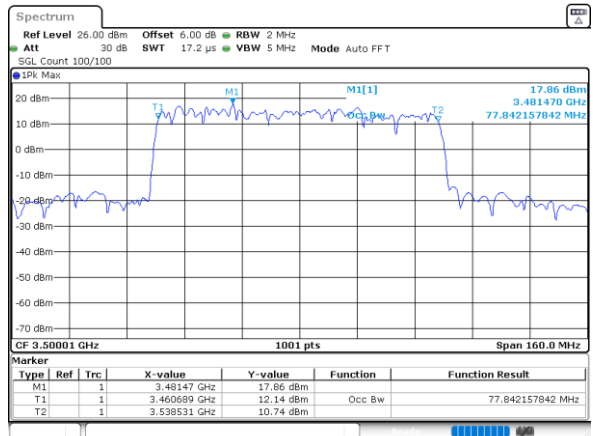

Date: 30.MAY.2022 21:05:32



90MHz CP

QPSK

16QAM

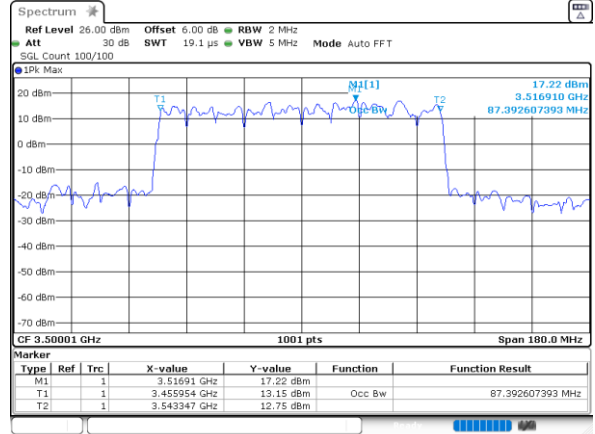
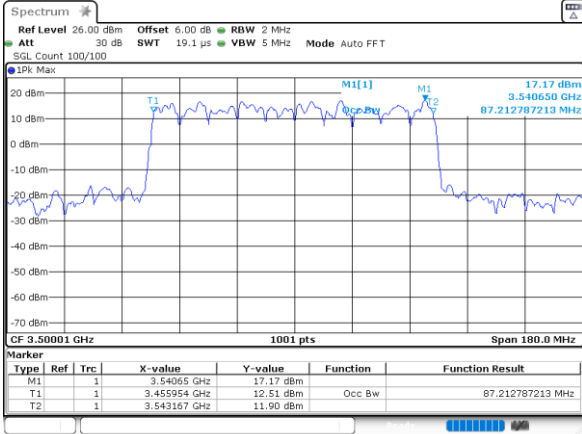

Date: 30.MAY.2022 20:55:06

Date: 30.MAY.2022 20:56:42

64QAM

256QAM

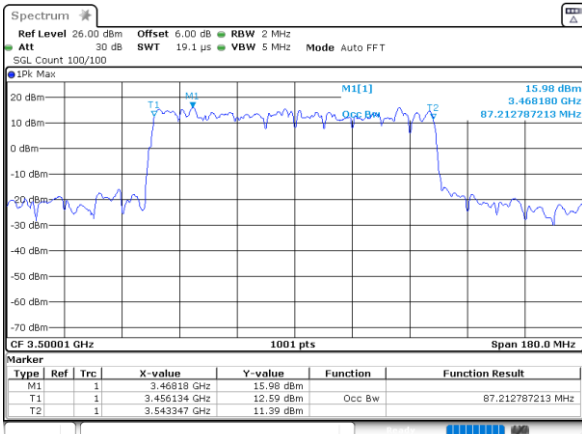

Date: 30.MAY.2022 20:58:10

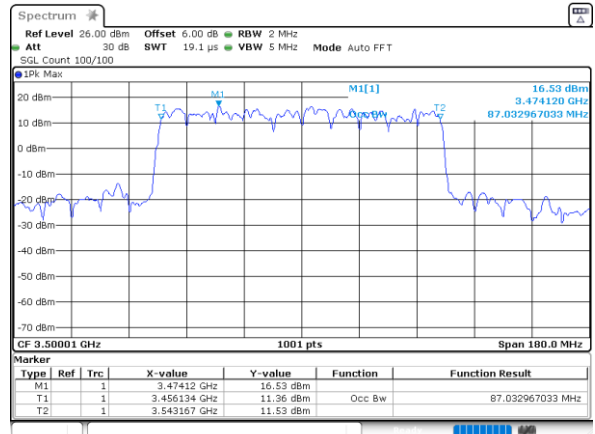

Date: 30.MAY.2022 21:00:36



100MHz CP

QPSK

16QAM

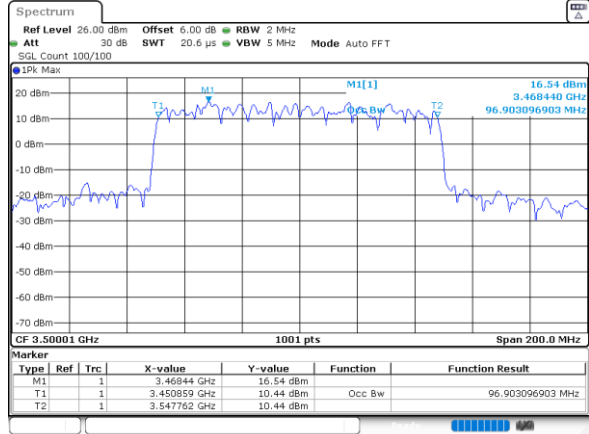
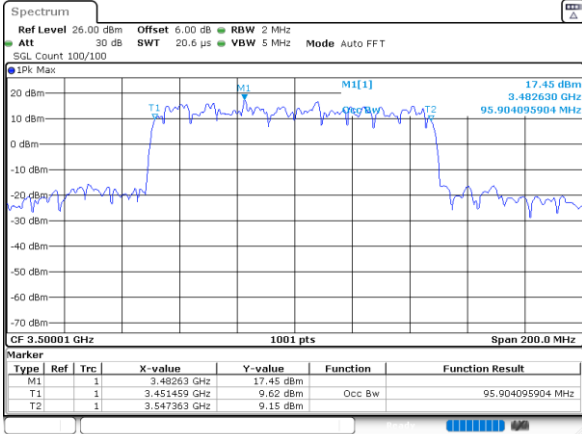

Date: 30.MAY.2022 20:49:34

Date: 30.MAY.2022 20:50:07

64QAM

256QAM

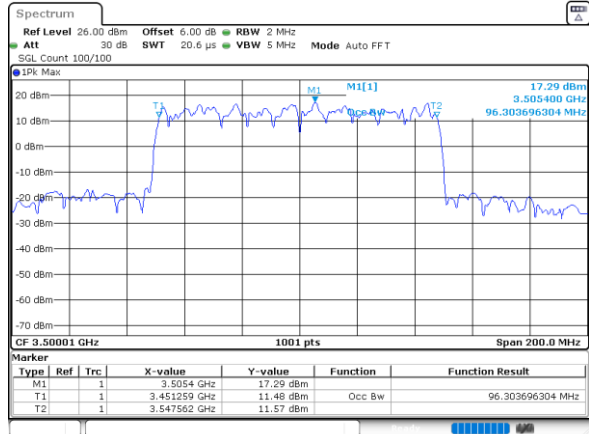
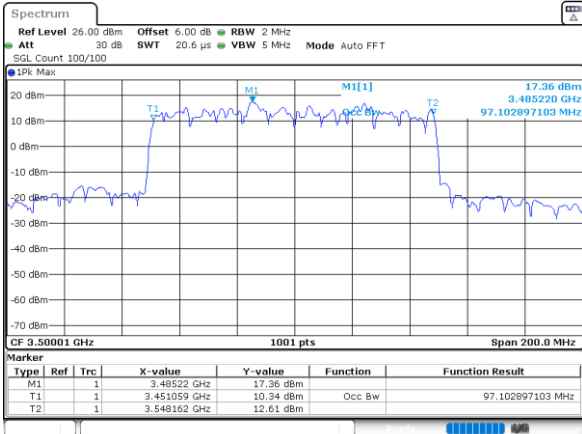

Date: 30.MAY.2022 20:50:40

Date: 30.MAY.2022 20:51:51



# Conducted Band Edge

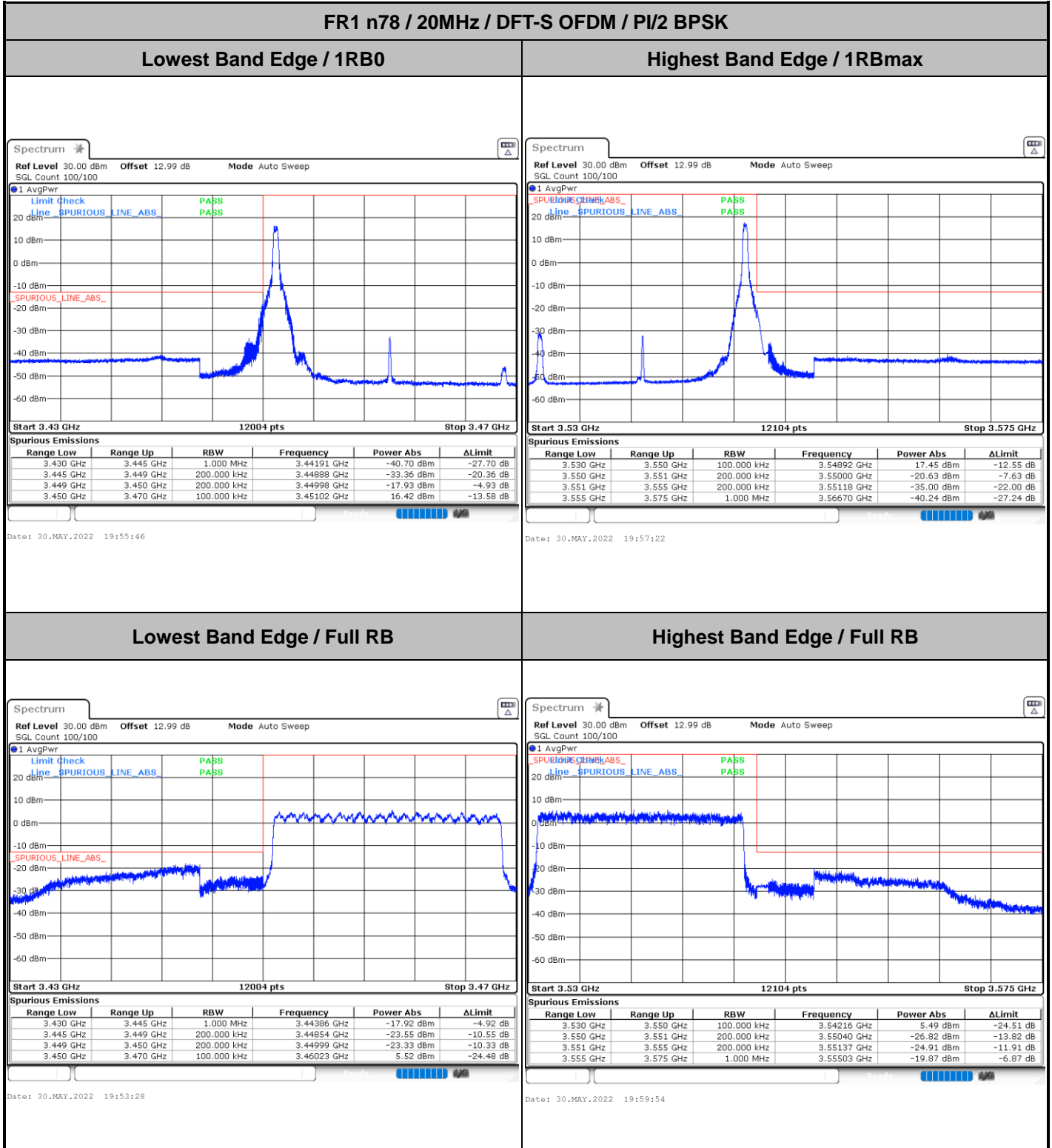



FR1 n78 / 20MHz / DFT-S OFDM / QPSK

Lowest Band Edge / 1RB0

Highest Band Edge / 1RBmax

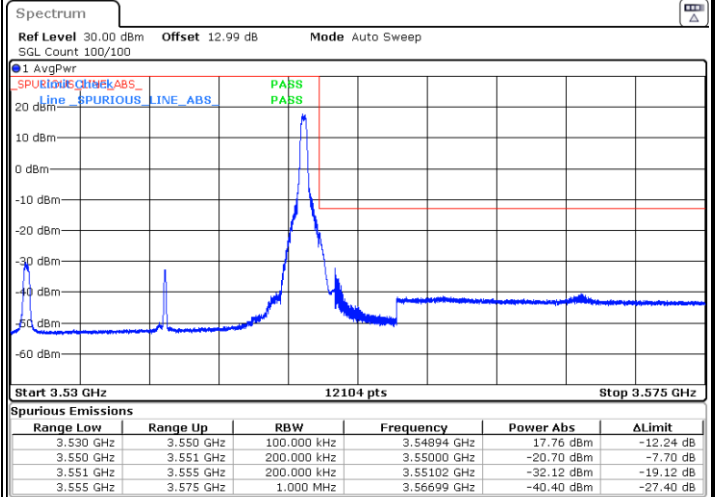
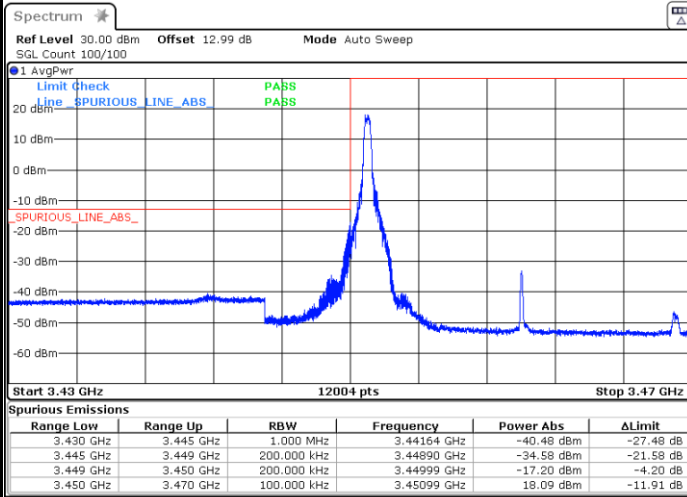

Date: 30.MAY.2022 19:55:11

Date: 30.MAY.2022 19:58:28

Lowest Band Edge / Full RB

Highest Band Edge / Full RB

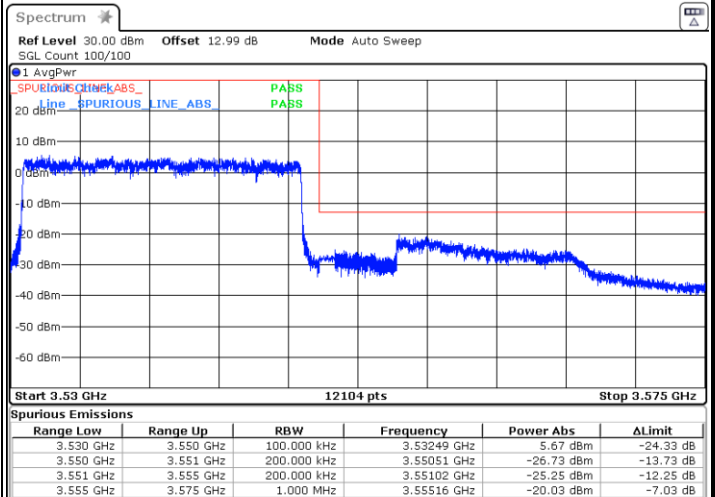
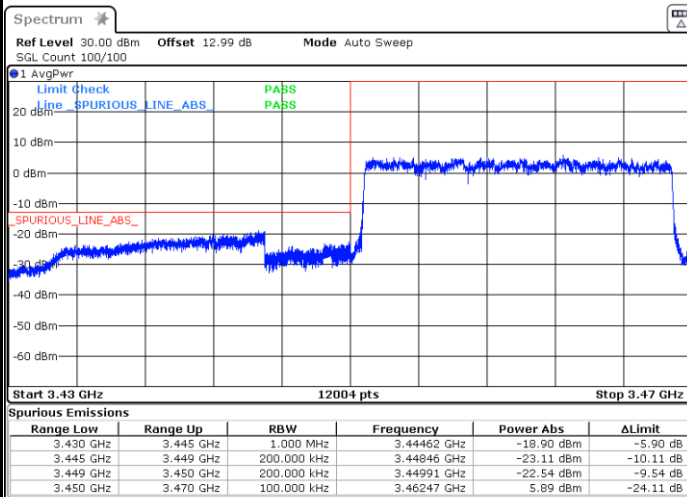

Date: 30.MAY.2022 19:54:27

Date: 30.MAY.2022 19:59:16



FR1 n78 / 60MHz / DFT-S OFDM / PI/2 BPSK

Lowest Band Edge / 1RB0

Highest Band Edge / 1RBmax

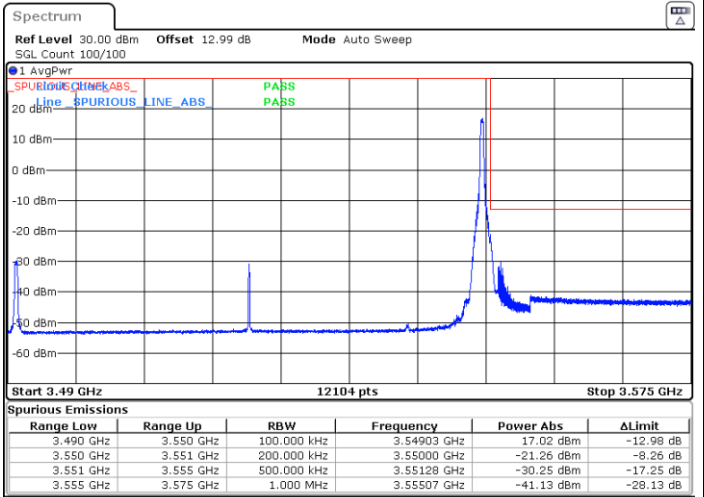
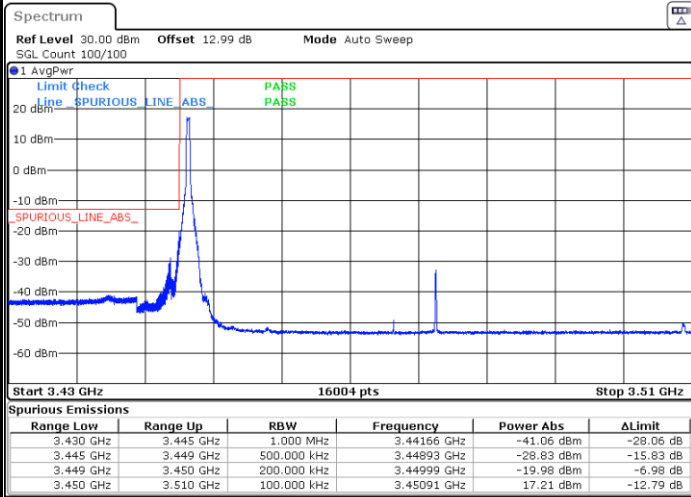

Date: 30.MAY.2022 20:27:31

Date: 30.MAY.2022 20:22:21

Lowest Band Edge / Full RB

Highest Band Edge / Full RB

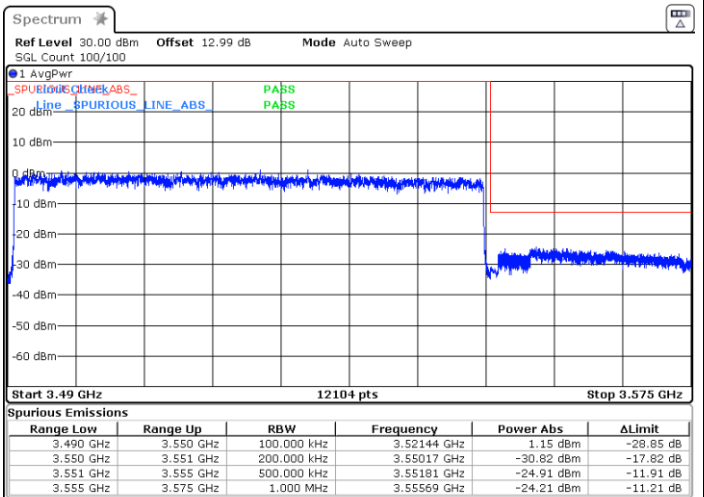
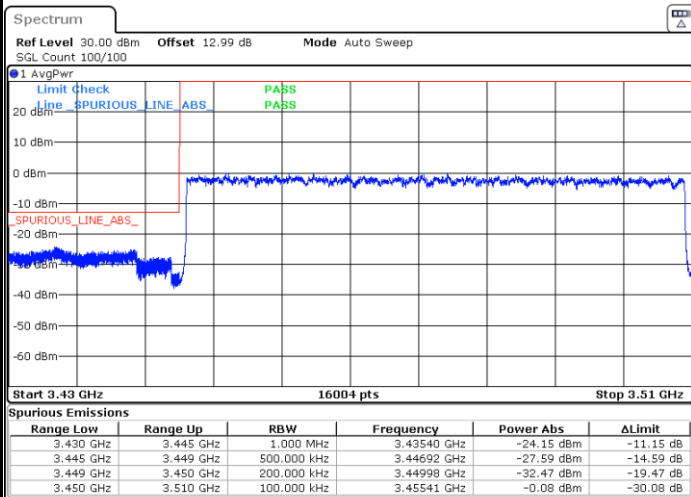

Date: 30.MAY.2022 20:26:03

Date: 30.MAY.2022 20:21:04