



**USB Cable Replacement
Reference Design Kit**

**Wireless Hub and USB Dongle
User Guide**

© Wisair 2006. All rights reserved. All right, title and interest, copyrights, patents, know-how, trade secrets and other intellectual property relating to this publication and to Wisair products are proprietary products of Wisair Ltd. ("Wisair"). The information presented in this publication does not form part of any quotation or contract, is believed to be accurate and reliable, and may change. No part of this publication may be reproduced in any form whatsoever without prior written approval by Wisair.

Any and all other trademarks, product names and other intellectual property rights are the sole property of their respective owners.

Wisair Proprietary Information

Customer Support:

Tel: +972-3-7676606

Fax: 972-3-7677608

Support@Wisair.com

Wisair doc. version UG10014 R 1.05

About Wisair

Wisair is a leading provider of WiMedia ultra-wideband (UWB) chipset solutions for consumer electronics, PC peripherals, and mobile devices. Leveraging the management teams' decades of wireless communications product development expertise, Wisair is the first company to deliver fully-functional WiMedia-based UWB chipsets and small form-factor reference designs.

Today, the fabless semiconductor company continues to focus on delivering low-cost, low-power, and high bit-rate wireless connectivity solutions.

For more information, visit www.wisair.com.

Table of Contents

1	Introduction	5
2	Quick Start	7
3	Functional Overview	9
3.1	Initialization.....	9
3.2	Association/Disassociation	10
3.3	Automatic Rate Adaptation	11
4	Installation	13
4.1	System Requirements	13
4.2	Physical Preparation.....	13
4.3	PC Software Installation	13
5	Operation	21
5.1	Status Indication.....	21
5.2	Configuration Properties.....	21
5.3	Pairing and Association/Connection	24
5.4	Closing the Connection Manager Application	25
6	Maintenance	27
6.1	Troubleshooting.....	27
6.2	Firmware Upgrade.....	31
7	Technical Specifications	41
8	Mechanical Description	43

Table of Figures

Figure 1: USB Dongle	5
Figure 2: USB Dongle block diagram	6
Figure 3: Wireless Hub	6
Figure 4: Wireless Hub block diagram	6
Figure 5: USB Dongle LED indications	10
Figure 6: Transmit Rate Select drop-down list.....	11
Figure 7: Found New Hardware Wizard	14
Figure 8: Insert Media Window	14
Figure 9: Hardware Installation screen.....	15
Figure 10: Completing the Found New Hardware Wizard	15
Figure 11: Confirm File Replace Window	16
Figure 12: Windows Device Manager Window	16
Figure 13: Found New Hardware Wizard	17
Figure 14: Hardware Installation Window.....	18
Figure 15: Device Manager displaying installed USB drivers	18
Figure 16: Connection Manager Properties.....	23
Figure 17: USB Dongle LED indications.....	27
Figure 18: Wireless Hub LED indications.....	27
Figure 19: Channel is busy message	28
Figure 20: HyperTerminal Properties	32
Figure 21: COM1 Properties	32
Figure 22: Wisair boot loader screen	33
Figure 23: Ready to Load New Firmware Flash Version Window.....	34
Figure 24: Send File Command	34
Figure 25: Send File Window.....	35
Figure 26: Send File progress window	35
Figure 27: HyperTerminal Window.....	35
Figure 28: Wisload application screen	36
Figure 29: Burn progress indication	37
Figure 30: Burn complete confirmation screen	37
Figure 31: Wisman initial screen	38
Figure 32: Wisman configuration screen.....	38
Figure 33: USB Dongle board top view.....	43
Figure 34: Main Wireless Hub board top view with dimensions.....	44
Figure 35: Main Wireless Hub board side view	44
Figure 36: Main Wireless Hub board component clearance dimensions	45
Figure 37: Mezzanine card oblique view	45
Figure 38: Mezzanine card top and side view	45

List of Tables

Table 1: Wireless channel selection.....	22
Table 2: Serial Port configuration parameters	33

1 Introduction

Wisair USB Cable Replacement reference design kit enables you to set up an ad hoc, Wireless network instantly, for USB cable replacement or extending USB range without the need for a network infrastructure, thus providing the right balance between functionality and aesthetics.. It allows remote content browsing, sharing, control, multi channel streaming, hotsync, printing, fast copy and very fast information exchange between PC and USB 2.0/1.1 PC peripherals. The types of content supported are data, applications, pictures, and compressed video and audio files (asynchronous transfer).

Some examples of USB PC peripherals (device side) types that can to be made using Wisair cable replacement solution are:

- § Wireless Hub—Multi-port wireless hub for legacy USB 2.0/USB1.1 devices
- § Combo of Wireless Hub and devices—Wireless Hub with: WLAN access-point/router/gateway, DSL modem/router, all-in-one memory card reader, desktop DVD player, desktop Hard Disk drive.
- § Wireless cradle—Wireless cradle for digital still camera, cellular phones, Smart Phones., PDA, MP3 players (such as iPod), Camcorder, Wireless (iPod) speakers. Laptop/notebook docking stations/port replicator.
- § Wireless embedded PC peripheral devices—Integrated into different products such as Wireless digital still camera, Wireless portable Hard Disk drives, Wireless Camcorder, Wireless printer, Wireless scanner, Wireless DVD player,.

The development kit is comprised of two major components: USB Dongle and Wireless Hub which form a point to point Wireless link. The components are:

- § USB Dongle—A USB PC dongle, shown below in **Figure 1: USB Dongle**. The dongle is plugged directly to a PC USB port or to a USB hub host port. The dongle is powered by the USB port and contains an on-board omni-directional antenna.
- § Wireless Hub—A Wireless Hub, shown below in **Figure 3: Wireless Hub**. The 4 port USB 2.0/1.1 wireless hub is a stand alone unit with external power and two internal omni-directional antennas. Up to four USB legacy devices can be directly attached to the hub.

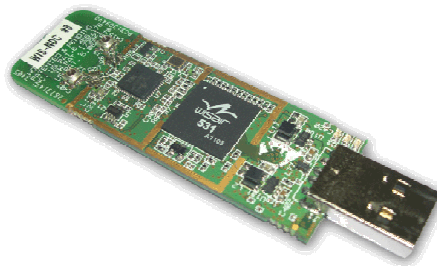

Figure 1: USB Dongle

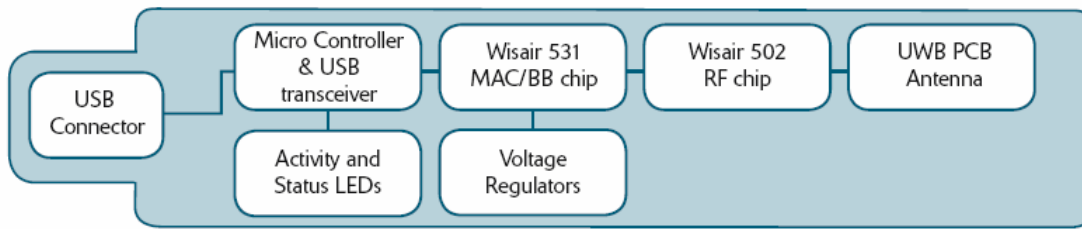

Figure 2: USB Dongle block diagram



Figure 3: Wireless Hub

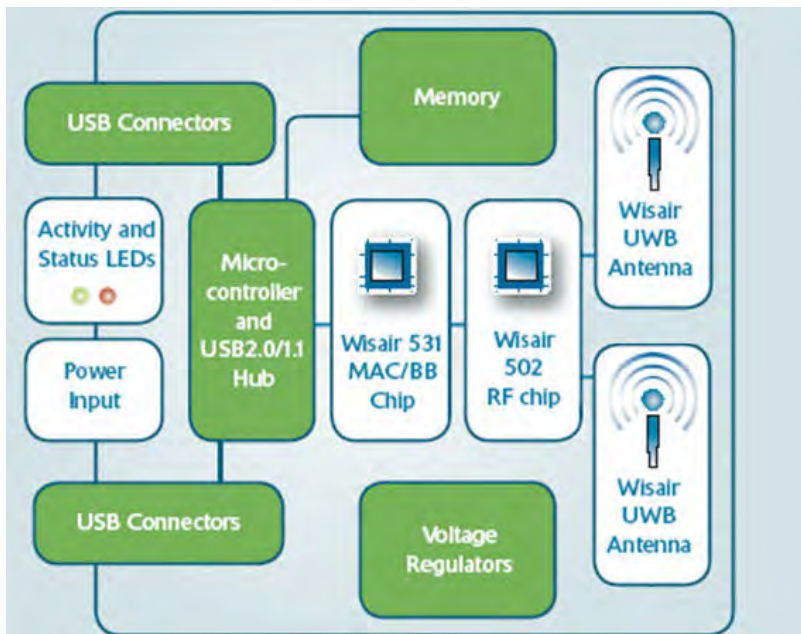
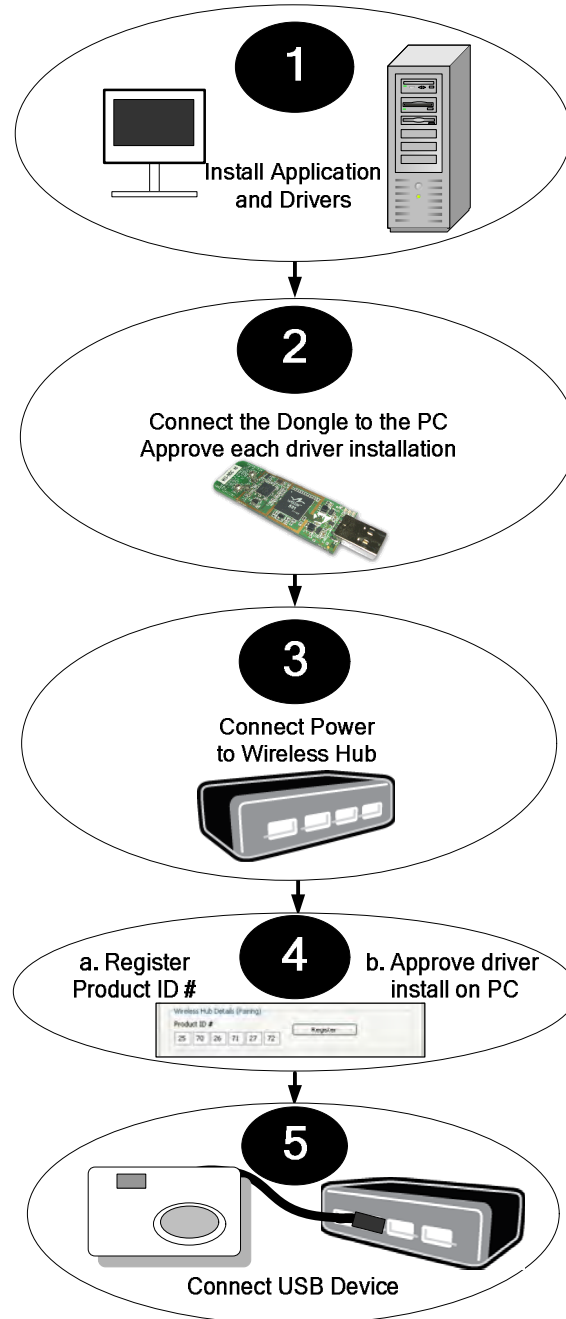

Figure 4: Wireless Hub block diagram

2 Quick Start

The following diagram illustrates the basic steps in connecting and getting started with the reference design USB Dongle and Wireless Hub:





3 Functional Overview

The following diagram illustrates the sequence of events performed by an USB Dongle connected to a PC, and by a Wireless Hub in order to create a wireless USB link and to associate the two entities.

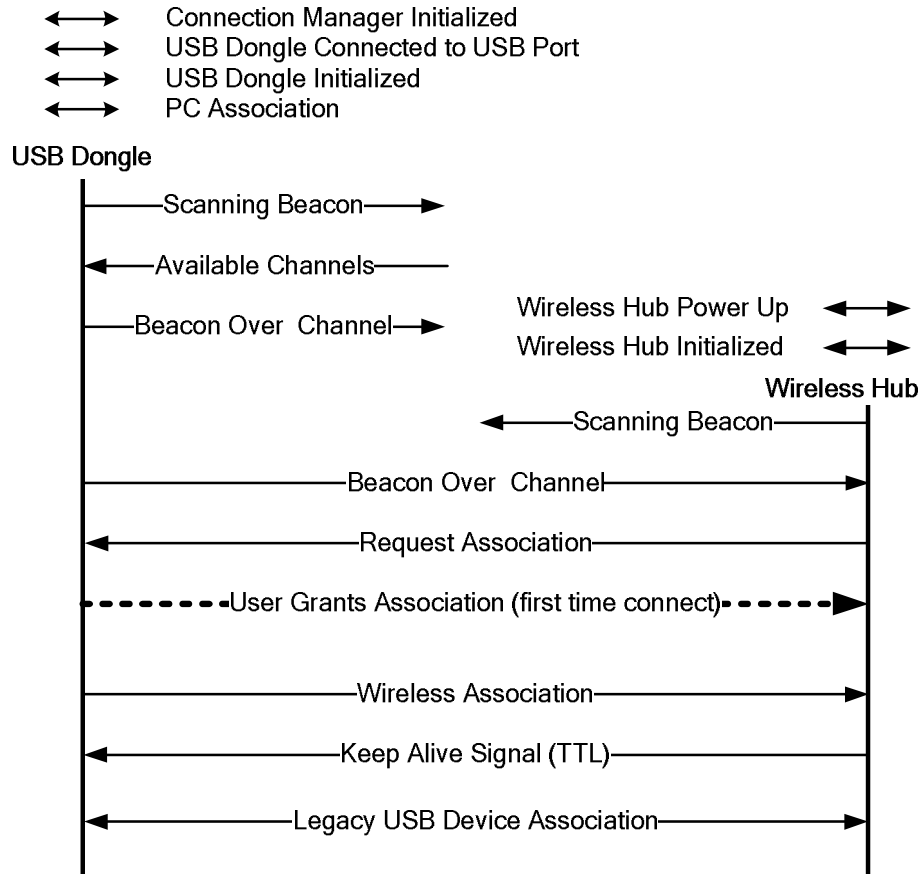

The following describes the startup and connection process that is performed by the USB dongle.

3.1 Initialization

Initialization (USB Dongle)—When the USB dongle is connected to the PC, the initialization procedure starts automatically. The embedded software is downloaded to the USB 2.0 microcontroller (Cypress FX2), the 531 and 502 chips are initialized, and the system is ready for use.

Each USB dongle has a unique Host ID pre-configured during production (the Product ID, which resembles the MAC address format).

LED Indications:

- § **Power** – Steady green when connected to USB port.
- § **Association** – Flashes at slow rate during association.
- § **Traffic** – Flashes rapidly when packets are received.

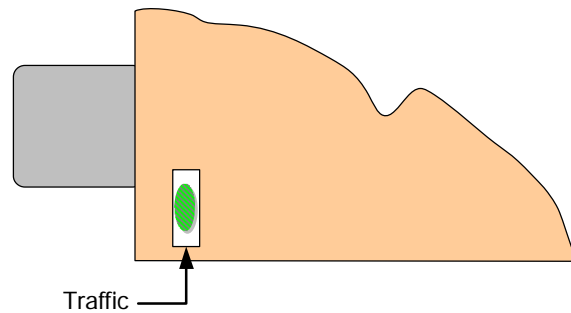

Figure 5: USB Dongle LED indications

Scanning (USB Dongle)—After initialization, the USB Dongle scans the airwaves - looking for the first available channel. An available channel is defined as a channel where no other UWB system is currently transmitting beacons. For a description of the available channels, see Table 1: Wireless channel selection in Sec. 5 Operation.

Once an available channel is found, the USB Dongle keeps sending out a beacon signal on this channel waiting for a response from a device (Wireless Hub).

Initialization (Wireless Hub)—When the Wireless Hub is powered up, initialization begins. This includes initialization of the 531 and 502 chips, and a download of software code to the ARM embedded in the Star 9104. Each Wireless Hub has a unique Dev ID pre-configured during production (based on product ID).

Scanning (Wireless Hub)—Once initialization ends, the Wireless Hub locates a wireless Host by scanning all channels. Once a Host is found, the Wireless Hub sends an association request that is either granted by the Host or denied. If granted (manually or automatically), the Wireless Hub switches to the Connected state. If denied, the Wireless Hub returns to the **Scan** state to search for an alternate wireless host.

3.2 Association/Disassociation

A connection request is always initiated by the Wireless Hub and received by the USB Dongle. Typically, the Wireless Hub scans channels until it finds a host to which it sends an association request. For first time association the USB Dongle asks the user to approve the association request through the GUI (a pop-up message screen). The Wireless Hub must retransmit the association request until it sees that it was added as an associated device to the host beacon or until it times out and returns to the scanning mode. Retransmissions should occur no more frequently than once per superframe.

Once the Host grants the association request, it will allocate bandwidth for the communication with this Wireless Hub (based on the bandwidth requirements of this device as sent in the association request message). After successful negotiation, bi-directional data transfer can begin between the Host and devices connected to the Wireless Hub. The Wireless Hub sends keep-alive messages periodically in order to signal the Host that it still wishes to be associated. Otherwise, it will be disassociated by the Host after the time out period.

After the first manual association, the same Wireless Hub is automatically associated to the same PC whenever the Wireless Hub operates within range. To associate with another Wireless Hub, you need to manually disassociate the previous Wireless Hub by pressing the Un-Register button in the Wireless Hub Connection Status GUI, which causes the Wireless Hub to dis-associate with the PC.

A typical association process takes no more than 1 second.

3.3 Automatic Rate Adaptation

A fast automatic rate adaptation algorithm is used to maximize utilization of the UWB link resources in scenarios where the USB Dongle (attached to a portable notebook) is moving towards or moving away from the Wireless Hub. The rate adaptation algorithm keeps the output Tx power constant while the transmitted PHY bit rate changes with the distance. For greater distances or high interference, the bit rate may be reduced to the minimum 53.3Mbps, while at short distances or low interference the bit rate increases automatically to the maximum rate of 480Mbps.

Rate adaptation is enabled in the Connection Manager GUI from the **Transmit Rate** dropdown-list by selecting **Auto** (this is also the default value in the wireless link). If a fixed **Transmit Rate** is selected instead of **Auto**, the same rate will be fixed in both USB Dongle and Wireless Hub.

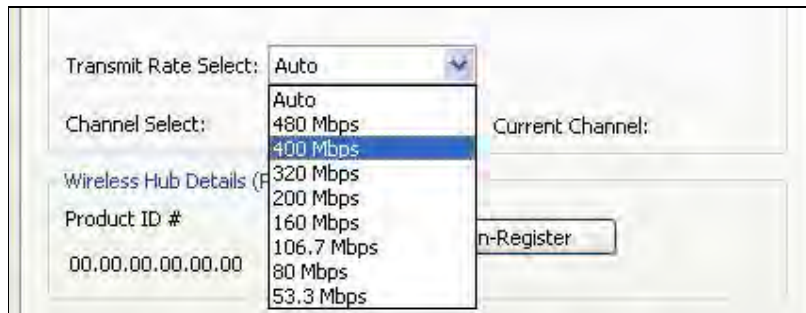

Figure 6: Transmit Rate Select drop-down list



4 Installation

4.1 System Requirements

The minimum requirements for running Wisair wireless connection software on a PC are as follows:

- § No previous Wisair software version. If you need to uninstall a previous version of the software, detach the USB Dongle and use the uninstall utility under **Start>Programs>Wireless Hub**
- § One or more available high speed (EHCI controller) USB 2.0 ports
- § Windows XP with SP2
- § 3 MB of free disk space

4.2 Physical Preparation

- § Check that all Wisair devices are set up properly
- § Ensure the Wireless Hub unit has a power supply unit and the external antenna is attached.
- § Ensure the Wireless Hub unit is switched off and not connected to any USB devices (e.g. Camera, Hard Disk etc.)
- § Ensure the distance between the Wireless Hub and USB Dongle is about 0.5 meter.
- § Ensure the USB Dongle and Wireless Hub unit are facing each other.

4.3 PC Software Installation

Note: Do not attach the USB Dongle before the host drivers are installed

The software and driver installation is performed in three steps:

1. The GUI application and USB drivers are installed on the PC
2. The dongle is connected to the high speed (EHCI controller) USB 2.0 port in the PC and the Windows Hardware Installation Wizard must recognize the dongle and register each of the drivers in turn (3 drivers in total).
3. The Wireless Hub is powered, associated with the USB Dongle, and its corresponding driver is registered by Windows Hardware Installation Wizard.

Note: If a previous installation of USB drivers already exists in your PC, uninstall the previous version using the uninstall utility under **Start>Programs>Wireless Hub**.

4.3.1 Install the USB Drivers and GUI

Ensure that your PC system hardware and software are both operational.

1. Ensure that the Wireless Hub is switched off and the USB Dongle is unplugged from the PC.
2. Run the **Setup_ver_XX_XX.exe** Wisair Setup Launcher program. Follow the onscreen instructions, and proceed by clicking **Next>** and **continue anyway** when prompted.

3. When the installation procedure is successfully finished. Proceed by clicking **Finish** twice and restart your PC.

4.3.2 Connecting the USB Dongle

1. Connect the Wisair USB Dongle to the high speed PC USB port. The system will automatically detect and begin installation of the drivers for the connected dongle using the Found New Hardware Wizard.



Figure 7: Found New Hardware Wizard

2. Select **No, not this time**, and click **Next >**.



Figure 8: Insert Media Window

3. Select **Install the software automatically (recommended)** and click **Next>** to install the UWB Dongle over USB driver.
4. The Hardware Installation screen is displayed.



Figure 9: Hardware Installation screen

5. Click **Continue Anyway**. The Completing the Found New Hardware Wizard screen is displayed.



Figure 10: Completing the Found New Hardware Wizard

6. Click **Finish** to complete the driver installation.
7. Windows will repeat this sequence two more times for the following drivers:
 - § UWB Dongle Control
 - § UWB Dongle MAC

Note: If the following screen displays during the installation, click Yes

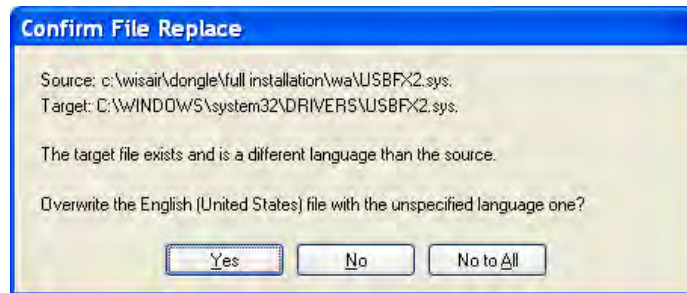

Figure 11: Confirm File Replace Window

8. Disconnect the Dongle from the USB port.

Note: It is recommended that you restart the PC in order to ensure that the USB driver installation has been successful.

9. Connect the USB Dongle to the PC after restart.

10. In order to verify a successful installation, run the Windows Device Manager utility (Start>Run>devmgmt.msc) and verify that it recognize the USB Dongle driver as shown in the following picture (choose View-> Device by Connection).

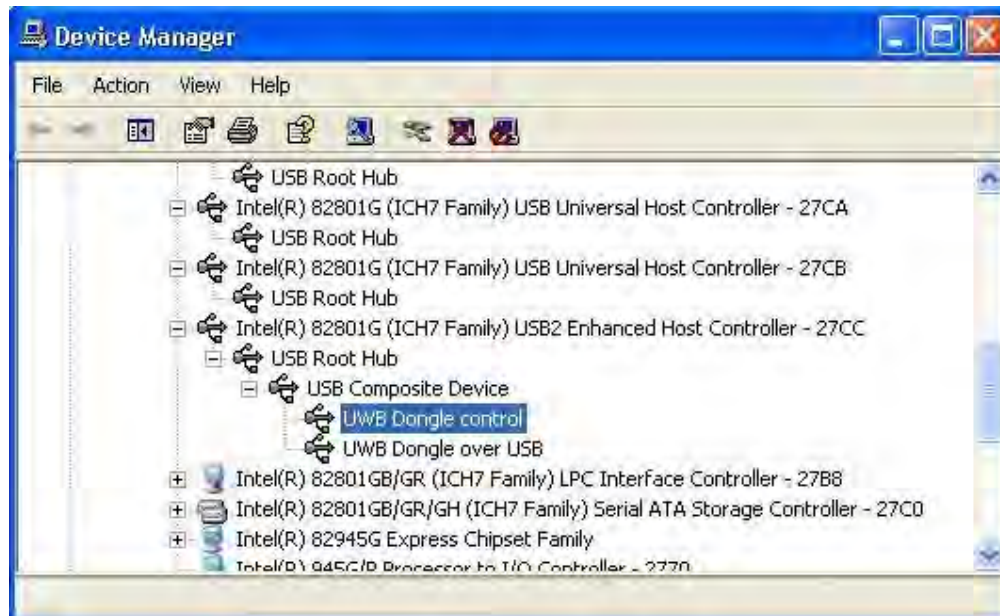

Figure 12: Windows Device Manager Window

4.3.3 Connecting the Wireless Hub

1. Ensure that the Wireless Hub is switched off.
2. Place the Wireless Hub within 0.5 meter distance from the USB dongle. Ensure the two units have clear line-of-sight.
3. Turn the Wireless Hub unit on. Ensure the LEDs are on.
4. Register the Wireless Hub Product ID# in the Wireless Hub Connection Status screen. See section 5.3.1 Registration (Pairing) for instructions.



Wireless Hub Details (Pairing)

Product ID #

25	70	26	71	27	72
----	----	----	----	----	----

Register

- The system will automatically detect and begin installation of the connected device using the Found New Hardware Wizard.



Figure 13: Found New Hardware Wizard

- Select **No, not this time**, and click **Next>**. The **Insert Media** window is displayed:
- Follow the instructions in the wizard, this is the same procedure as in setting the USB dongle.
- The **Hardware Installation** window is displayed.



Figure 14: Hardware Installation Window

9. Click **Continue Anyway**. The **Completing the Found New Hardware Wizard** screen is displayed.
10. Click **Finish** to complete the installation.

Note: It is recommended that you restart the PC in order to ensure that the USB driver installation has been successful. Disconnect the USB Dongle from the PC during the restart procedure and ensure the Wireless Hub unit is turned off.

11. To verify a successful installation, run the Windows Device Manager utility (**Start> Run>devmgmt.msc**) and verify that it recognizes the new drivers that were installed. You should see the following names: **UWB Dongle Control**, **USB Composite Device**, **UWB Dongle over USB**, and **Wireless Hub**. See the following screen shot:

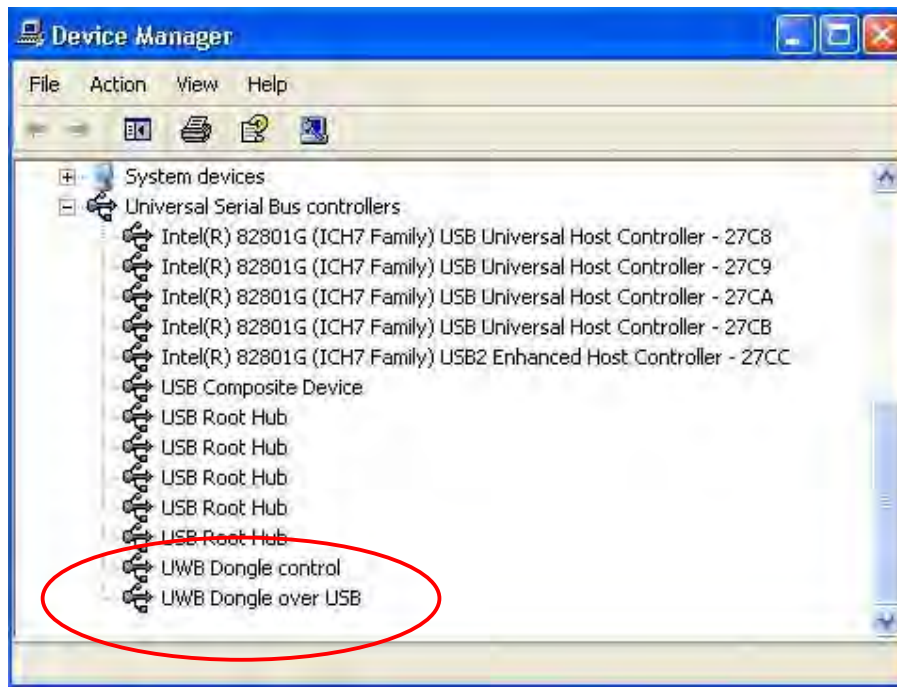

Figure 15: Device Manager displaying installed USB drivers

4.3.4 Uninstalling the Software

If you need to uninstall the software, you can do so by using the automatic uninstaller or by using the **Windows Control Panel>Add or Remove Programs** utility.

To uninstall the software:

1. Detach the USB Dongle from the USB port of the PC.
2. Select **Uninstall Wireless Hub** from **Start>Programs>Wireless Hub**.

OR

3. Use the **Windows Control Panel>Add or Remove Programs** utility, under **Wireless Hub**.





5 Operation

To begin operation, please review the simple steps outlined in **Sec. 2 Quick Start**.

5.1 Status Indication

When the Wisair Connection Manager is up, the Wisair icon displays in the Windows System Tray. The color of the icon indicates the current activity state, as follows:

Icon Color	Status
	Enabled (yellow icon) USB dongle is connected to the PC (dongle is enabled, no wireless connection is detected)
	Connected (green icon) A wireless connection is established with a Wireless Hub module
	Disabled (gray icon) USB Dongle is disabled (and no connection available)

5.2 Configuration Properties

The USB Dongle hardware **properties** screen provides direct access to the dongle hardware configuration.

To open the **properties** screen, right click on the Wisair icon and select **properties** from the context menu.

The following table explains the properties that can be configured or viewed:

Property	Description
Connection Status	
Operating State	Disabled/Disconnected/Connected
Signal Strength	0-100%
Transmit Rate Select	Auto/480/400/320/200/160/106.7/80/53.3 Mbps
Channel Select	Auto Detect/A/B/C/D/E (see Table 1: Wireless channel selection)
Current Channel	A/B/C/D/E (see Table 1: Wireless channel selection)
Wireless Hub Details	
Product ID #	Enables the registration of the Wireless Hub Product ID# in order to allow association/connection with that hub.
Register/ Un-Register	Registers (associates) or Un-Registers (disassociates) the Wireless Hub of the given Product ID #.

USB Dongle Status	
Reset	Resets the connection/disassociates Wireless Hub from Host and restarts scanning
Disable/Enable	Turns USB dongle off to save PHY power
Packets Sent/Packets Received	Packets Sent (by USB Dongle) Packets Received (from Wireless Hub)
USB Dongle Details	
Description	Wisair USB Dongle (HWA531)
Product ID	Unique hardware identification number (configurable, see Sec. 6.2.3 Changing Product ID)
Firmware Version	Host firmware version
Driver Version	Wisair PC driver version

Table 1: Wireless channel selection

Wisair Channel Name	TFC Channel	Band Search Pattern
A	TFC1	F ₁ F ₂ F ₃ F ₁ F ₂ F ₃
B	TFC2	F ₁ F ₃ F ₂ F ₁ F ₃ F ₂
C	TFC5	F ₁ F ₁ F ₁ F ₁ F ₁ F ₁
D	TFC6	F ₂ F ₂ F ₂ F ₂ F ₂ F ₂
E	TFC7	F ₃ F ₃ F ₃ F ₃ F ₃ F ₃



Figure 16: Connection Manager Properties

5.3 Pairing and Association/Connection

Once the Wireless Hub is powered up and completes its initialization, it is ready for association. First time association occurs after manually **Registering** the Product ID# of the Wireless Hub with the PC, this is also called **Pairing** the two entities.

After the first time connection/association, future association is handled automatically, so that no user intervention is necessary.

5.3.1 Registration (Pairing)

To Register the product ID number:

1. Open the **Wireless Hub Connection Status** screen (double-click the CM tray icon).
2. In the **Wireless Hub Details (Pairing)** section, enter the **Product ID #**. (There are six pairs of character/digit combinations in the product ID).

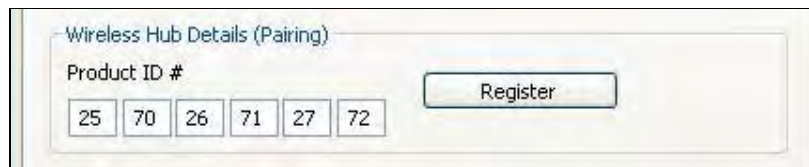

3. Press **Register** to finalize the registration/pairing. Once the Product ID number is accepted, the Product ID numbers are displayed as read-only, and the button is labeled **Un-Register**.

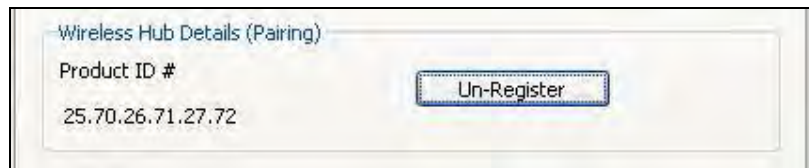

4. Following registration/pairing, association/connection is established, and a tool tip is displayed in the System Tray area showing the Product ID # and a message that the Wireless Hub is connected with the PC as shown in the screen shot below.



5. Check the **Operating State** field in the Wireless Hub Connection Status screen to see if the status changes from **Disconnected** to **Connected**.



5.3.2 Automatic Association

After the first manual association, the same Wireless Hub is automatically associated to the same PC whenever the Wireless Hub operates within range. To associate to another Wireless Hub, you must manually **Un-Register** the previous Wireless Hub by pressing **Un-Register** which causes the Wireless Hub to dis-associate from the PC.

5.3.3 Changing Association/Registration (Pairing)

To change the association/registration from one Wireless Hub to another:

1. In the Wireless Hub Connection Status screen, click **Un-Register**.

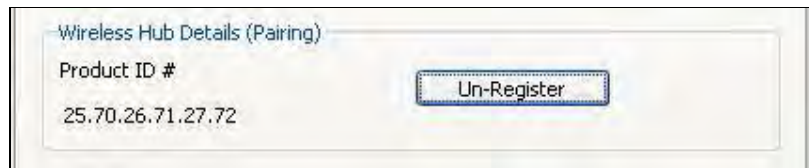

2. Enter the **Product ID #** of the Wireless Hub that you want to associate and press **Register**.

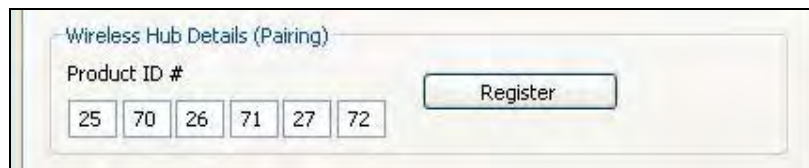

3. A tool tip is displayed in the System Tray area, containing the Product ID and a message that the Wireless Hub is now connected with the PC.
4. Check to see the **Operating State** field to see if the status changes from **Disconnected** to **Connected**.

5.4 Closing the Connection Manager Application

To shut down the Connection Manager:

1. Right click the tray icon and select **Exit**.



2. Click **Yes** to confirm that you want to shut down the application.



6 Maintenance

The following sections provide maintenance information; troubleshooting advice, and firmware upgrade instructions.

6.1 Troubleshooting

6.1.1 USB Dongle LED Indications

- § Power – Constant green when 5V DC is applied from the PC USB port.
- § USB Association – Slow flashing green when dongle associates with the PC.
- § Rx Traffic – Flashes green when packets are received.

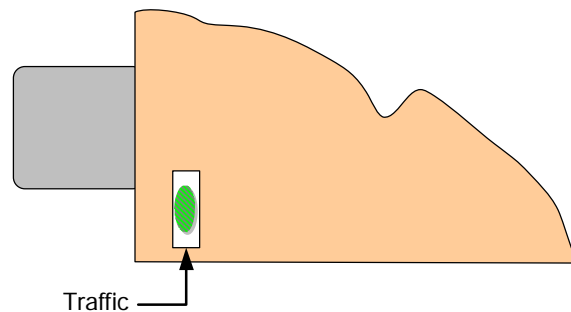

Figure 17: USB Dongle LED indications

6.1.2 Wireless Hub LED Indications

- § Power—Constant ON, green when 5V DC is applied
- § Association with USB Dongle/Traffic Indication—Slow flashing when the connection/association is established. Rapid flashing to indicate Rx/Tx traffic.

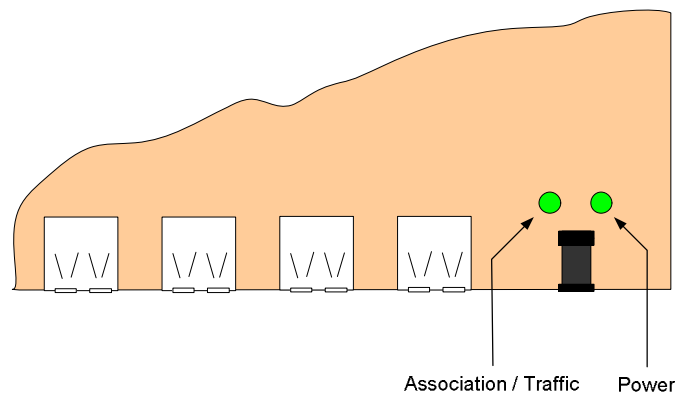

Figure 18: Wireless Hub LED indications

6.1.3 Channel Busy

When the user selected a specific channel (frequency range) and the USB Dongle (after scanning) found it cannot be the master on that channel, an information message window

displays automatically. This is the result of more than one USB Dongle present in the same range.



Figure 19: Channel is busy message

To resolve this conflict, select a different channel in the **Connection Manager Properties** screen one of the USB Dongles.

6.1.4 Support for USB Classes

Audio devices (USB Audio class) and *some* Web cams (USB Video class) which have isochronous endpoints, are not supported by the software.

6.1.5 Product ID Conflict

When 2 USB Dongles or Wireless Hubs with same product ID are within range, a conflict may occur.

Solution—Change the product ID on one or more of the entities.

6.1.6 Wireless Link Out of Range

If you are experiencing frequent Wireless link breaks, the Wireless Hub may be out of range—the solution is to shorten the range between the USB Dongle and Wireless Hub.

6.1.7 Extended or External Wired USB Hub Connections

If you are connecting the USB Dongle to a PC via an external wired USB hub – we recommend:

- § Apply external power to the wired USB hub.
- § Do not use the external hub during initial connect and driver installation.

6.1.8 Automatic Software Installation Fails

If you receive a message saying that the installer could not complete the installation, check the following before retrying the installation:

- § You are logged in to your PC with an administrator level profile.
- § The PC has Windows XP with SP 2 installed.
- § If you are working with a laptop that is working on battery power, connect to a power supply before attempting installation.

6.1.9 Manual Software Installation

If automatic installation of the Wisair software does not succeed on your PC, you can perform a manual installation.

For a clean (first time) installation:

1. Create a new directory on your PC (for example, C:\Program Files\Wireless Hub).
2. Copy the Wireless Hub Windows drivers into the directory:
 - § FX2Control.sys
 - § swmac.sys
 - § USBFX2.sys
 - § WirelessHub.sys
 - § FX2Control.inf
 - § SwMac.inf
 - § USBFX2.inf
 - § WirelessHub.inf
3. Copy the application (ConnectionManager.exe) plus the CM_API.DLL file into the same directory. Create a shortcut to the ConnectionManager.exe and place it in the **Start>Programs>Startup** menu of the PC so that the application starts up automatically when Windows starts.
4. Launch the GUI application (ConnectionManager.exe)
5. Connect the USB Dongle to the USB port of the PC.
6. When prompted for the required driver, select the option **Install from a list or a specific location (advanced)**, and point to the new directory where you placed the drivers (for example, C:\Program Files\ Wireless Hub).
7. Follow the procedure outlined in Sec. 4.3.2 Connecting the USB Dongle
8. Check the Windows Device Manager to ensure that all 3 drivers are installed. If any of the drivers display a yellow exclamation mark (!), right click that driver name and select **Uninstall**, and repeat the driver installation procedure.
9. When you complete the USB Dongle side driver installation, plug in the dongle and power up the Wireless Hub. Windows will prompt you for the required driver. Browse and point to the new directory containing the drivers (for example, C:\Program Files\Wireless Hub). Complete the procedure as described in Sec 4.3.3 Connecting the Wireless Hub.
10. Manual installation is now completed.

6.1.10 Manual Software Uninstall

To uninstall the software manually:

1. Ensure that the Connection Manager is stopped and the USB dongle is disconnected.
2. Go to C:\windows\system32\drivers and locate the four driver files:
 - § FX2Control.sys
 - § swmac.sys
 - § USBFX2.sys
 - § WirelessHub.sys
3. Delete the four files
4. If applicable, remove the shortcut for the ConnectionManager.exe from the Start>Programs>Startup menu.

6.1.11 Reading Software and Firmware Version

In order to ensure that you are working with the latest version of software and hardware, you can check the versions of each component as follows:

Wisair application	In Control Panel>Add or Remove Programs>Wireless Hub>Click here for support information for the automatically installed application.
PC host drivers version	Right click the tray icon, select Properties . Read the Driver Version field in the USB Dongle Details section.
USB Dongle firmware version	Right click the tray icon, select Properties . Read the Firmware version field in the USB Dongle Details section. .
Wireless Hub firmware version	Use a serial connector to connect via HyperTerminal application and view the firmware version in the command prompt of the Wireless Hub.

6.1.12 Compiling the Application Software

For ODM/OEM manufacturers:

In order to make a custom compilation of the Wisair application software (Connection Manager/ GUI), you will need the following:

- § The Connection Manager sources directory which contains:
 - § CM_API sub-directory (contains CM_API.dll)
 - § ConnectionManager sub-directory (contains code source files)
 - § ConnectionManager.sln file
- § The Wireless Hub Windows drivers (4 *.sys files and 4 *.inf files):.
 - § FX2Control.sys
 - § swmac.sys
 - § USBFX2.sys
 - § WirelessHub.sys
 - § FX2Control.inf

- § SwMac.inf
- § USBFX2.inf
- § WirelessHub.inf

To compile the ConnectionManager.exe application:

1. Copy the ConnectionManager source files to a directory on your PC.
2. Open Microsoft Visual Studio (or similar) application.
3. Browse to provide the same new directory created for the project.
4. Run the compilation.
5. The output is a ConnectionManager.exe file – the executable CM GUI application.

6.1.13 Creating an Automatic Installer

1. Copy the ConnectionManager.exe file into a new directory on your PC.
2. Copy the USB Windows drivers (four *.sys and four *.inf files) into this new directory.
3. Run an install shield utility, and point to the new directory as the source files.
4. A new automatic installer executable file is created for the application.

6.2 Firmware Upgrade**6.2.1 Wireless Hub – Serial Software Upload**

The Wireless Hub Firmware consists of two software packages:

- § Boot loader
- § Application code

The boot loader code is burned into the chip memory during the Wireless Hub factory stages using production level tools The application code programming is done using the boot loader software that manages the code download from the PC into the Wireless Hub FLASH memory device. The Boot loader code must be installed on the Wireless Hub unit prior this phase.

Note: A special FEMALE-D-type 9 pin to FEMALE-flat type 3 pin RS232 cable is required for connecting the Wireless Hub unit to the PC serial port.

1. Ensure that your PC system hardware and software are both operational.
2. Ensure that the Wireless Hub is switched off.
3. Connect the Wisair D-type 9 pin to 4 pin adapter cable to the Wireless Hub, connect the other end to the PC COM1 serial port.
4. Open Hyper Terminal on Windows and create a connection.
5. In **File** → **Properties** select Configure.

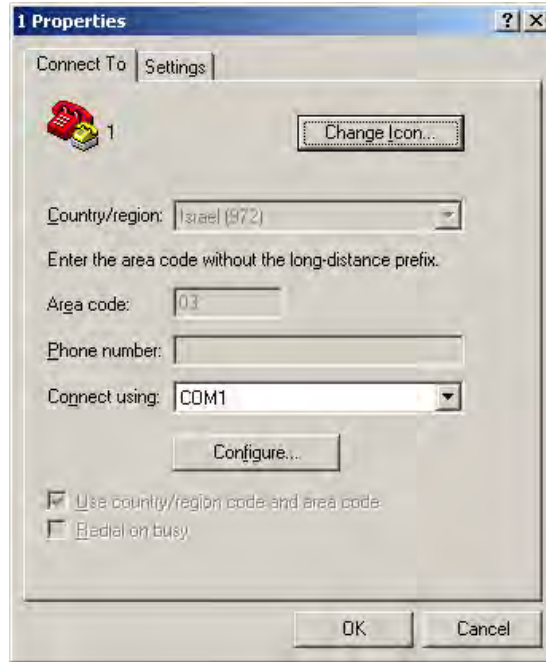

Figure 20: HyperTerminal Properties

6. Check that all parameters are sets as describes below and click Ok to save.

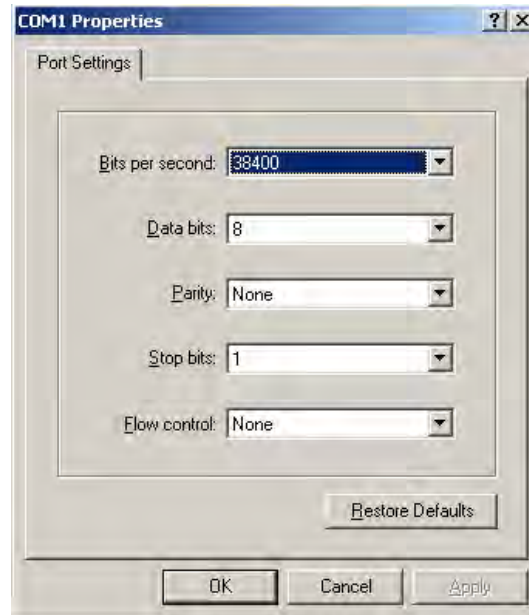
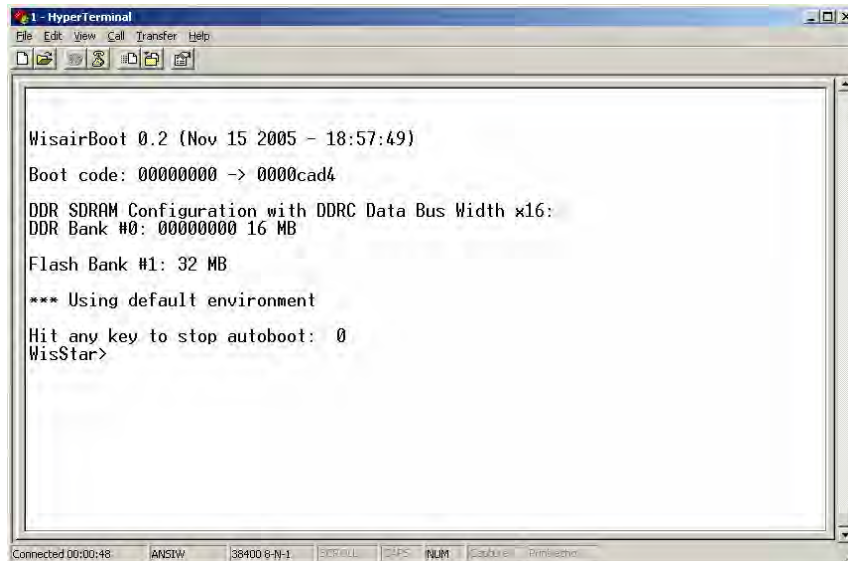

Figure 21: COM1 Properties

Table 2: Serial Port configuration parameters

Parameter	Value
Bits per second	38400
Data bit	8
Parity	None
Stop bit	1
Flow Control	None

- Turn on the Wireless Hub unit. During the boot up process, there is a 2 seconds delay. During this delay to must hit any key on the PC keyboard to stop the Wireless Hub boot process in order to enter the Boot loader menu.



```

1 - HyperTerminal
File Edit View Call Transfer Help
[Icons]

WisairBoot 0.2 (Nov 15 2005 - 18:57:49)
Boot code: 00000000 -> 0000cad4
DDR SDRAM Configuration with DDRC Data Bus Width x16:
DDR Bank #0: 00000000 16 MB
Flash Bank #1: 32 MB
*** Using default environment
Hit any key to stop autoboot: 0
WisStar>

Connected 00:00:48  ANSIW  38400 8-N-1  8000ULL  845  845M  845M  845M  845M  845M
  
```

Figure 22: Wisair boot loader screen

- At the WisStar> command prompt, type the command `loadall` and press Enter.

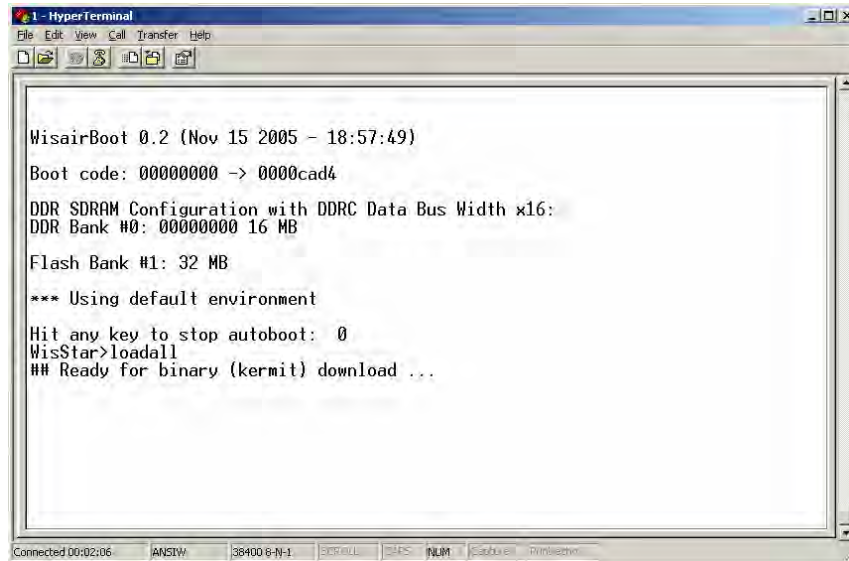

```
1 - HyperTerminal
File Edit View Call Transfer Help
[Icons]

WisairBoot 0.2 (Nov 15 2005 - 18:57:49)
Boot code: 00000000 -> 0000cad4
DDR SDRAM Configuration with DDRC Data Bus Width x16:
DDR Bank #0: 00000000 16 MB
Flash Bank #1: 32 MB
*** Using default environment
Hit any key to stop autoboot: 0
WisStar>loadall
## Ready for binary (kermit) download ...

Connected 00:02:06  ANSLW  38400 8-N-1  8000L  845  NUM  256000  00000000
```

Figure 23: Ready to Load New Firmware Flash Version Window

9. Go to Transfer à Send File.

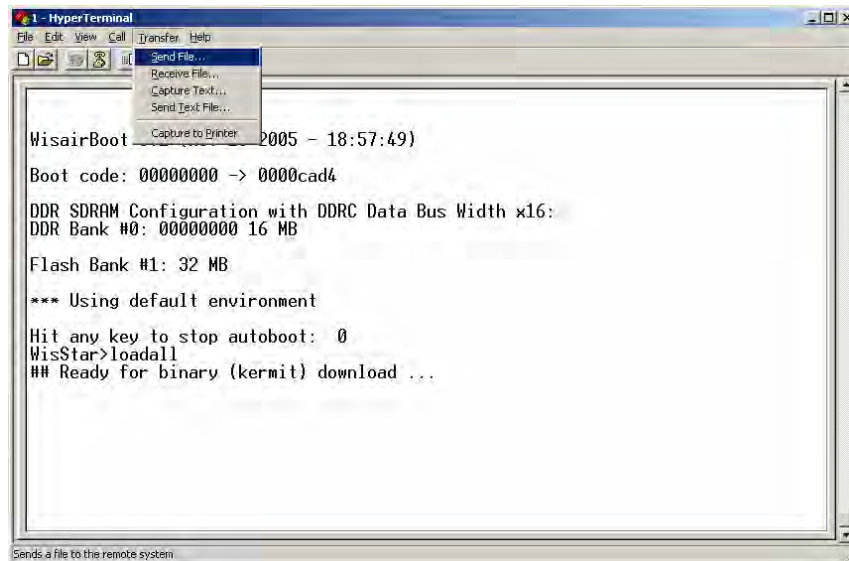

```
1 - HyperTerminal
File Edit View Call Transfer Help
[Icons]
[Transfer Menu Open]
  Send File...
  Receive File...
  Capture Text...
  Send Text File...
  Capture to Printer

WisairBoot 0.2 (Nov 15 2005 - 18:57:49)
Boot code: 00000000 -> 0000cad4
DDR SDRAM Configuration with DDRC Data Bus Width x16:
DDR Bank #0: 00000000 16 MB
Flash Bank #1: 32 MB
*** Using default environment
Hit any key to stop autoboot: 0
WisStar>loadall
## Ready for binary (kermit) download ...

Sends a file to the remote system
```

Figure 24: Send File Command

10. Select the application image file to burn. Ensure that the protocol type is set to Kermit. The image file will be located at C:\Program Files\Wireless Hub\Firmware after you have installed the Wisair software.



Figure 25: Send File Window

11. Press **Send**. The application code is now uploaded to the Wireless Hub unit. It may take a few minutes; follow the progress bar in the File text box for status.

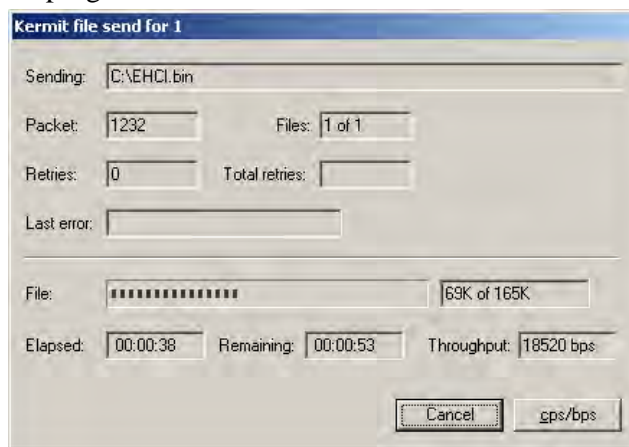

Figure 26: Send File progress window

12. Upon receiving the new application code, the Wireless Hub unit burns it into the FLASH memory.

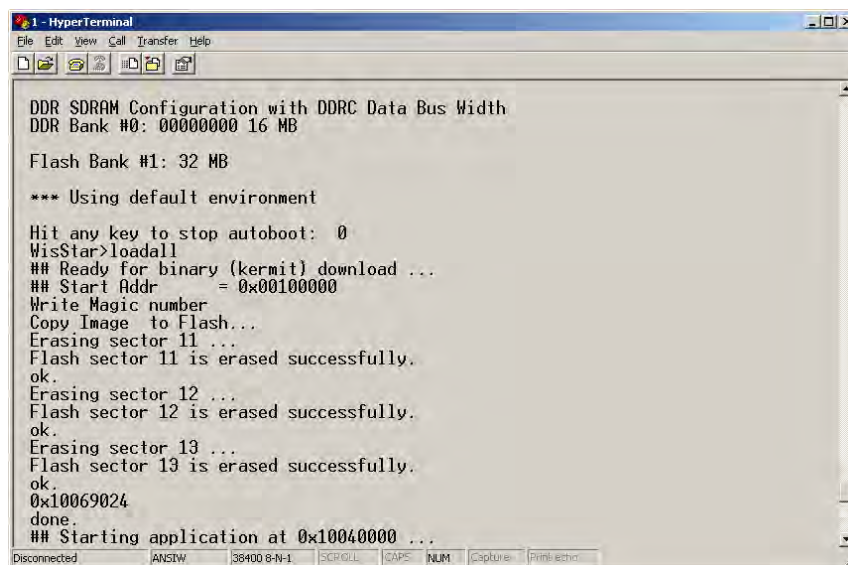

Figure 27: HyperTerminal Window

13. The command prompt displays the message: "The application code was installed successfully". Check to see that the version on the Wireless Hub screen is the same as the one you programmed.
14. Turn the Wireless Hub unit power off and on again before continuing.
15. The Wireless Hub unit is ready to use with updated application software.

6.2.2 USB Dongle – Memory Upload

To update the embedded software on the USB dongle, use the Wisload application as follows:

1. Connect the dongle to the PC USB port.
2. Open the Wisload application included in the package.



Figure 28: Wisload application screen

3. Press **Burn**
4. From the file browse dialog that displays, go to **C:\Program Files\Wireless Hub\Firmware** directory and select **DongleFW.iic**, this is the firmware file that is to be burned into the dongle memory.
5. Click **open**. The software is burned into the dongle memory and a countdown counter is displayed as seen in the following screen capture.

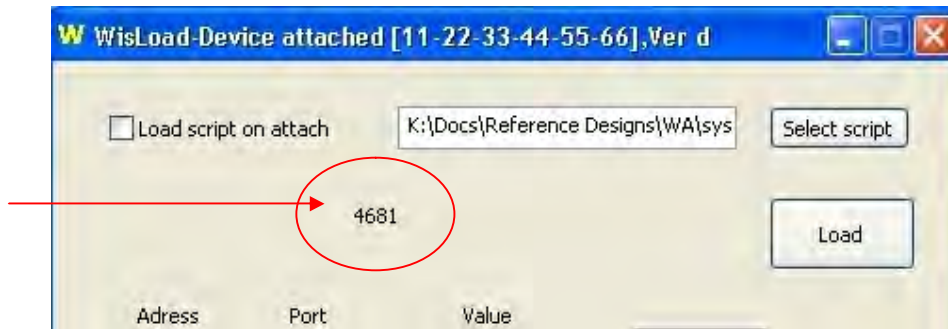

Figure 29: Burn progress indication

Warning! Do not detach the dongle from the PC until the burn has completed and the confirmation message "Done!" is displayed as shown below



Figure 30: Burn complete confirmation screen

6. Click OK
7. Detach and reattach the dongle and check the Product ID and Firmware version displayed in the Wisload title bar as seen below.

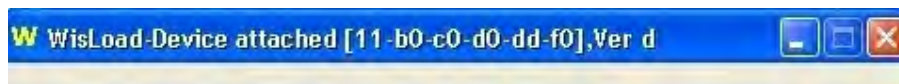

Note: Please note that the new firmware version inserts a default product ID on the USB Dongle. If you need to have a unique address, follow the instructions for the USB Dongle in Sec. 6.2.3 . This can be done in Wisload as well as Wisman.

8. .Exit the Wisload application.

6.2.3 Changing Product ID

To avoid conflicts among similar Wireless Hub devices or USB dongles during testing of multiple connections, it is advisable to set a different and unique product ID for each device. To change the product address ID on a device, use the Wisman application as follows:

Note: The Wisload application can also be used to modify the product ID in the USB Dongle. Wisload allows you to write to one address space at a time, starting with the most significant address digits in C180, and continuing through the least significant digits in C185 (using port 8).

9. Connect the Wireless Hub device to the PC using the special serial D-type to 3 pin cable that is provided. The Wireless Hub serial connector is located on the inside face of the

- Mezzanine card, between the USB connectors.
OR
Connect the **USB Dongle** to the USB port of the PC.
10. Open the Wisman application from **Start>Programs>Wisair>Wisman**.

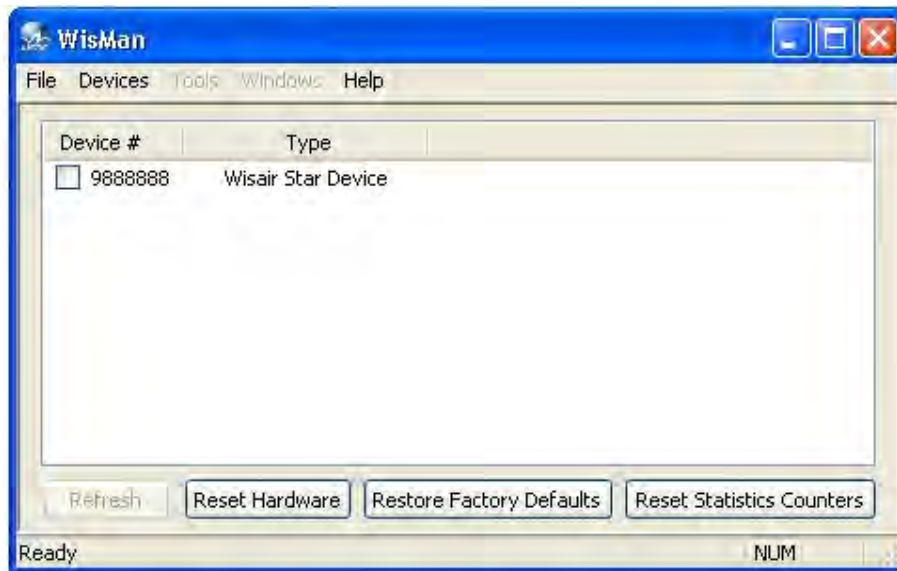

Figure 31: Wisman initial screen

11. Hold down the CTRL key and double click the device name in the Wisman screen.

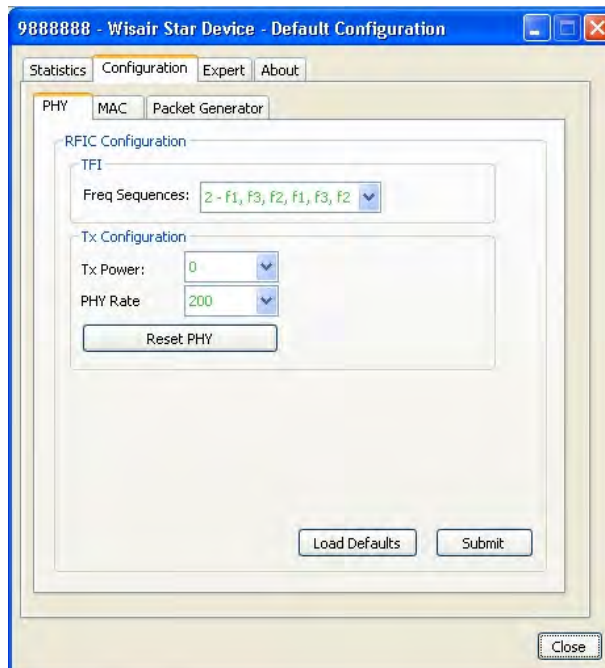

Figure 32: Wisman configuration screen

12. Select the **Expert** tab

13. In the **Read** section, enter the values: **Length – 6**, **Start Address – c180**, **Port – 8** and click **Read** to display the current product ID in the connected device. (c180 is the address of the most significant digits)



Read

Length: 6 Start Address: c180 Port: 8

Output Data (Bytes)

1	10	11	12	13	14	15			
13									
25									

Read

Cont

14. Enter the same values in the **Write** section, and enter the product ID (in Hexadecimal format) in the first 6 address positions.
15. Click **Write** to set the new product address in the device memory.

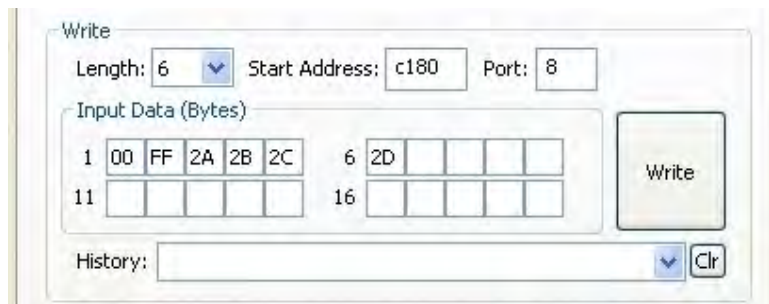

Write

Length: 6 Start Address: c180 Port: 8

Input Data (Bytes)

1	00	FF	2A	2B	2C	6	2D		
11						16			

Write

History: Clr

16. Click **Read** again to check that the new product ID was saved to the device



Read

Length: 6 Start Address: c180 Port: 8

Output Data (Bytes)

1	00	FF	2a	2b	2c	2d			
13									
25									

Read

Cont

17. Exit the Wisman application.



7 Technical Specifications

Model number	HWA531 — USB Dongle DWA531 — 4 port Wireless Hub
UWB Chipset	Wisair 531 MAC/BB chip, Wisair 502 RF chip
Operational Range	Up to 10 to 20 meters (30 to 60 feet)
PHY data rate	Up to 480Mbps (Automatic or manually selected)
Frequency range	3.1GHz to 4.8GHz; supporting 3 sub-bands, 528MHz each
RF modulation type	Multiband OFDM
Max. output power	80 μ W (-41.25dBm/MHz maximum)
Max Power Consumption	HWA531 — 1.75W (350 mA maximum @5VDC from USB port) DWA531 — 3 W (600mA @5VDC from external power supply)
USB end points types	Bulk in/out, Interrupt, Control
Number of endpoints	32 endpoints
USB power drive	Powers up to 4 USB external devices (500mA@5VDC each)
USB association type	Host GUI based association
LED indications	Power , Association, Traffic
PCB size	HWA531 — 25 by 69 mm DWA531 — 38 by 92 mm
Antenna	HWA531 — UWB on-board omni-directional antenna DWA531 — UWB two internal omni-directional antennas
Operating Temperature range	5°C to +50°C
Operational Humidity	10-95%
PHY compliance	Complies with WiMedia PHY spec. Rev. 1.0
FCC compliance	Complies with FCC CFR 47 Part 15 subpart F; UWB intentional radiation
USB hub compliance	Complies with USB 2.0/1.1
OS compliance	Microsoft® Windows XP SP2; Windows Plug and Play compliant
Coexistence	Co-exists with standard WiMedia devices Coexistence with co-located additional USB dongles or UWB systems (FFI, TFI schemes)



8 Mechanical Description

The package includes:

- § PC side: USB Dongle and software CD.
- § Device side: Wireless Hub and power supply
- § External, omni-directional antenna for Wireless Hub.
- § Serial connection cable, DWA_CBL2 – standard FEMALE-D-type 9 pin to FEMALE-3 pin (flat type) RS232 cable

Note: Previous versions of the Wireless Hub included a serial connection cable (DWA_CBL1 — standard FEMALE-D-type 9 pin to MALE-4 pin flat type connector RS232 cable).

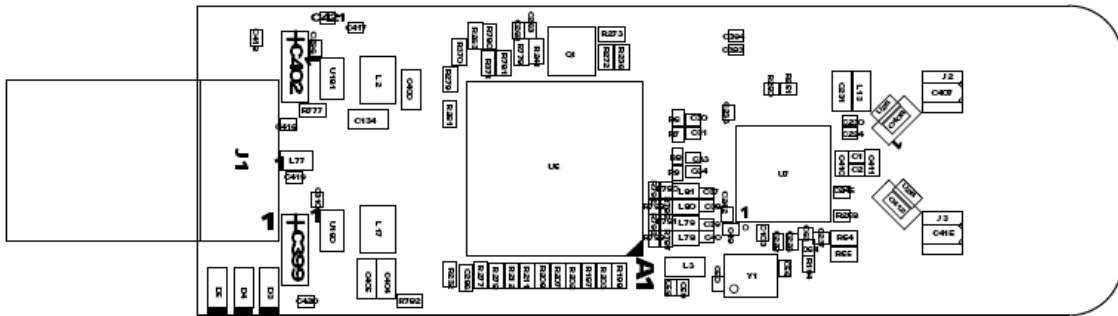

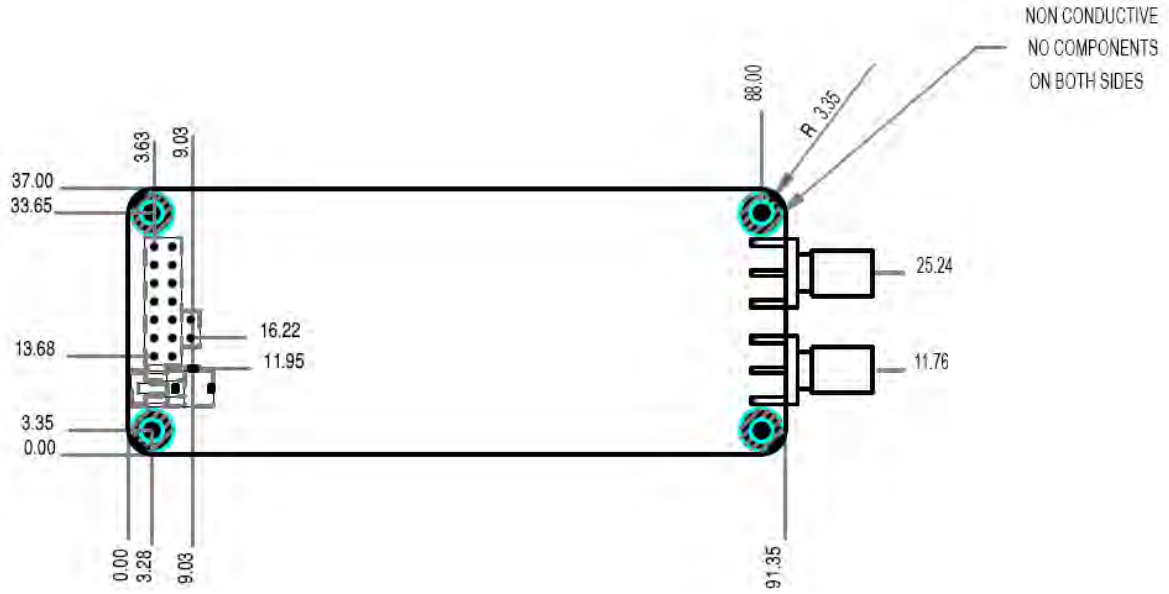

Figure 34: Main Wireless Hub board top view with dimensions

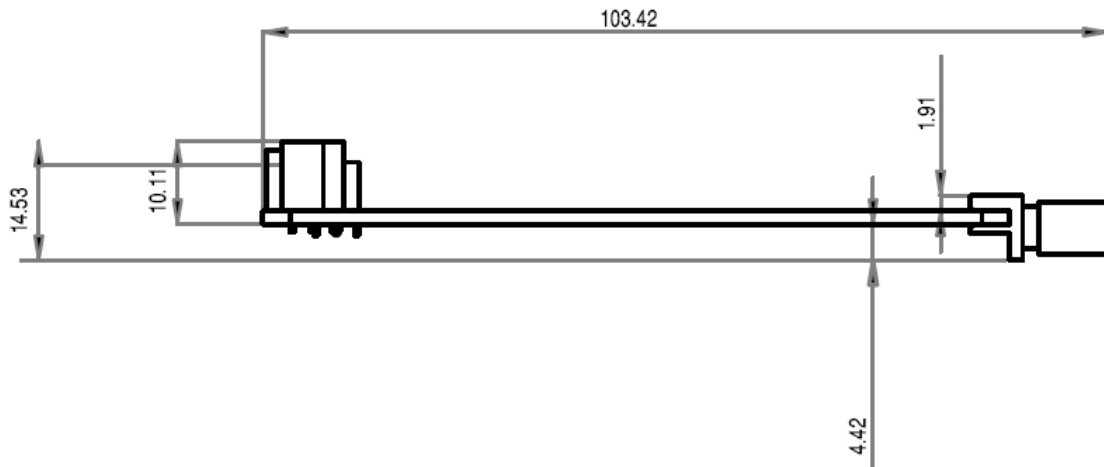

Figure 35: Main Wireless Hub board side view

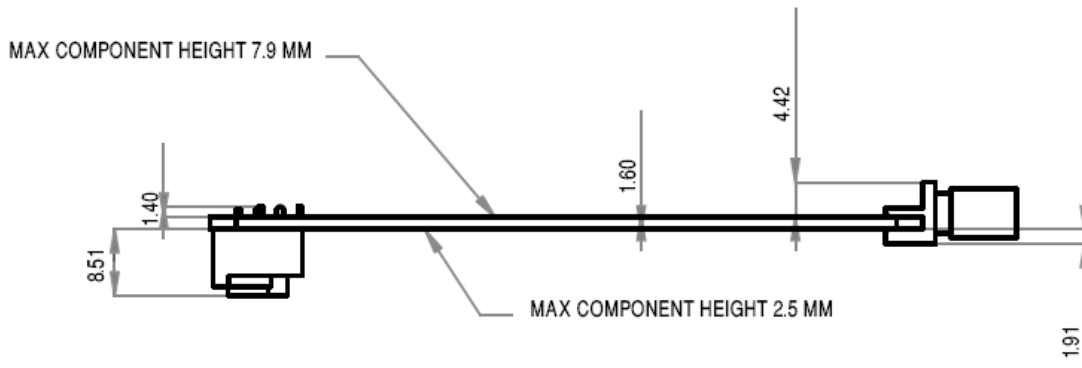

Figure 36: Main Wireless Hub board component clearance dimensions

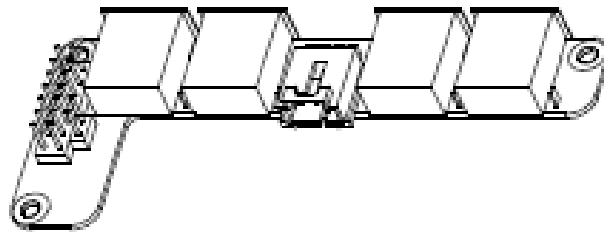

Figure 37: Mezzanine card oblique view



Figure 38: Mezzanine card top and side view