

A2415 Series Cellular Access Point Installation Guide

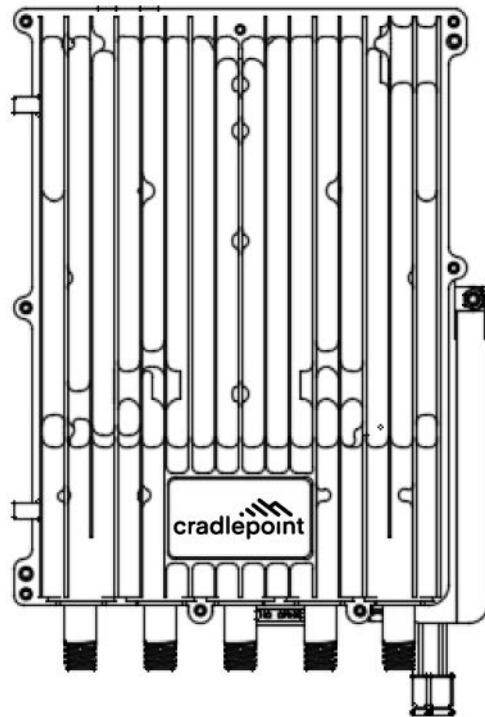

Table of Contents

Product Overview	3
Introduction	3
Highlights	3
Appearance	3
Installation Preparation	6
Support Materials	6
Installation Tools	7
Installation Environmental Requirements	7
Lightning & Grounding Protection	7
Weatherproofing	8
Installation	9
Unpacking	9
Installation Procedure Overview	9
Installing the GNSS Antenna	9
Install on Pole	10
Install on Wall	11
Connect Cable	12
Cable Laying Requirements	12
Connecting the GNSS Antenna	13
Connecting the RF Cable	13
Connecting the Optical Fiber	13
Connecting the Ethernet Cable	14
Connecting the Power Connector	14
Connecting the Ground Cable	16
Waterproofing the Maintenance Chamber	19
Powering on to Check LED Status	19
Troubleshooting	20
FAQ	20
Common Installation Errors	20
Terminology & Acronyms	23
Regulatory Compliance	24
FCC Compliance	24

Product Overview

Introduction

The Cradlepoint A2415 is an advanced two-carrier outdoor Cellular Access Point (CAP) compliant with 3GPP LTE TDD technology. This 4x1W CAP operates in Carrier Aggregation (CA) mode or Dual Carrier (DC) mode.

In CA mode, A2415 supports 2CC (2 component carriers) DL/UL CA. 2CC DL/UL CA doubles DL/UL peak throughput comparing to that of a single carrier. By aggregating 2 separated spectrum resources into a virtual contiguous spectrum resource. In DC mode, each carrier is treated as an independent cell, supporting 128+128 users, with each cell supporting 5, 10, 15, or 20 MHz bandwidth. Using a A2415 in DC mode simplifies and streamlines the deployment of split sectors.

Highlights

Following are some of the key A2415 highlights.

- GUI-based local and remote Web management
- Excellent Non-Line-of-Sight (NLOS) coverage
- Peak rate: Up to DL 290Mbps and UL 70Mbps with 2x20MHz bandwidth
- 2CC DL/UL CA improves the spectrum efficiency of fragmented spectrum resources.
- Suitable for private and public deployments; any IP based backhaul can be used, including public transmission protected by Internet Protocol Security (IPsec)
- 128 RRC connected users per carrier, 128+128 in DC mode; upgradeable to higher capacity in future releases
- Supports 4-port antenna or 2 antennas with 2 ports
- Integrated small cell form factor for quick and easy installation
- Supports Transparent Bridge Mode
- Supports Citizens Broadband Radio Service (CBRS) with proxy/direct Spectrum Access System (SAS)
- Supports Multi Operator Radio Access Network (MORAN)
- Support Inter Cell Interference Coordination (ICIC) with static
- Plug-and-play with Self-Organizing Network (SON) capabilities
- Inter operation with all standard LTE Evolved Packet Core network (EPC)
- Supports TR-069 network management interface
- Lower power consumption, which reduces OPEX, can be powered easily by Baicells compact outdoor smart UPS

Appearance

The A2415 CAP appearance is shown below.

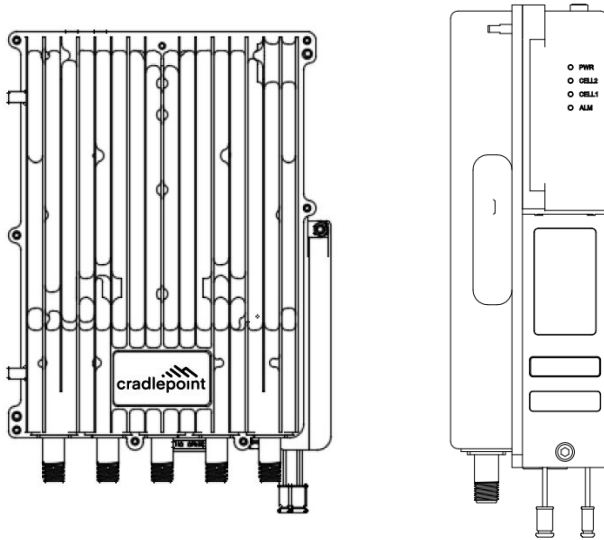

The A2415 ports and LEDs are shown below.

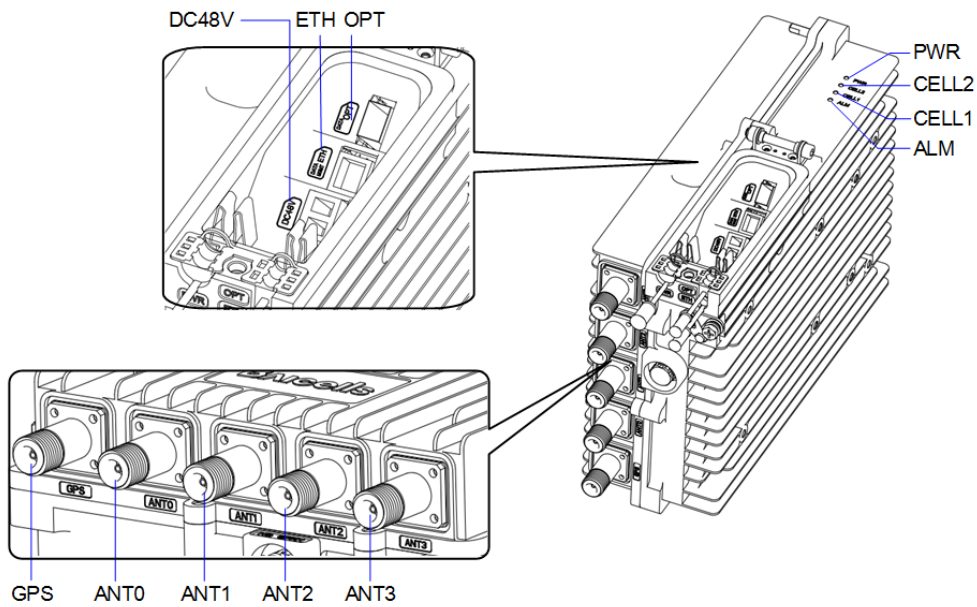

The A2415 ports are described below.

Port Name	Description
DC48V	Power interface: -40VDC ~ -57 VDC, nominal -48VDC
OPT	Optical interface (SFP), connect to external transmission network, used for data backhaul.
ETH	RJ-45 interface (GE), used for debug or data backhaul.
GPS	External GPS antenna, N-female connector.
ANT0	External antenna 0, N-female connector.
ANT1	External antenna 1, N-female connector.
ANT2	External antenna 2, N-female connector.
ANT3	External antenna 3, N-female connector.

A2415 LED Indicators:







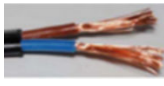

LED	Color	Status	Description
PWR	Green	Steady On	Power On
		OFF	No Power Supply
CELL2	Green	Fast flash: 0.125s on,0.125s off	CELL 2 inactivated
		Slow flash: 1s on,1s off	CELL 2 activated
CELL1	Green	Fast flash: 0.125s on,0.125s off	CELL 1 inactivated
		Slow flash: 1s on,1s off	CELL 1 activated
ALM	Red	Steady On	Hardware alarm, e.g., VSWR alarm
		OFF	No alarm

Installation Preparation

Support Materials

















In addition to industry standard tools, you will need the materials described in Table 2-1 during the installation. When selecting an RF antenna, be sure to match the frequency range of the antenna with the CAP.

Table 2-1 Support Materials

Item	Figure	Description
AC cord		The diameter of power cable must be AWG13 (2.5mm ²) or greater (such as AWG12) with three cores.
DC cord		It is suggested that AWG13 is used if the DC cord is less than 10 meters and AWG12 is used if the DC cord is between 30 meters to 60 meters and the adaptor output is 500 watts. The cord is two cores cable, the diameter of the cable is 9±1mm.
RF antenna cable		50 ohm feeder, 1/2 jumper
Optical fiber		Optical fiber (armor) It is suggested that the diameter of the cable is 7±1mm.
Ethernet cable		Outdoor CAT6, shorter than 100 meters (~109 yards) It is suggested that the diameter of the cable is 7±1mm.
RF antenna		Omni or directional dual polarized antenna
Ground cable		If the length of lead is more than 10 meters, 10mm ² diameter grounding cable should be used. If the length of lead is less than 10 meters, 10mm ² diameter grounding cable should be used.
Pole		φ 100mm≥pole≥ φ 40mm hot-galvanized steel pipe Channel steel and equal angle steel installation are also supported. The width of the channel steel is 50mm to 100mm; the length of side of the angle steel is 63mm to 80mm.
Distribution box		AC Air switch, socket, power grounding point, broadband access is all in the distribution box, which must be waterproofed.

Installation Tools

The following tools are needed during the installation.

Level bar 	Marker pen 	Knife 	Pliers 	Adjustable wrench 
Power drill and drill bits 	Hammer 	Phillips screwdriver 	Cable crimping tool 	Tape measure 
Allen wrench (5 mm) 	Screwdriver (T7) 	Ladder 	Compass 	Fixed pulley 
Multimeter 				

Installation Environmental Requirements

In addition to network planning, when determining where to place the CAP you need to consider factors such as climate, hydrology, geology, the possibility of earthquakes, reliable electric power, and transportation access. Avoid locating the CAP in areas where there may be extreme temperatures, harmful gases, unstable voltages, volatile vibrations, loud noises, flames, explosives, or electromagnetic interference (e.g., large radar stations, transformer substations). Avoid areas prone to impounded water, soaking, leakage, or condensation.

Table 2-2 provides typical environmental specifications for this CAP.

Table 2-2 Environmental Requirements

Item	Range	Typical value
Temperature	-40°C to 55°C	25°C
Relative humidity (no condensation)	0% to 100%	5% to 95%
Safety voltage	42V to 58V	48V

Lightning & Grounding Protection

You must protect the CAP, antennas and GPS against lightning. Following are guidelines concerning grounding.

- The yellow-green ground wire must be at least 10mm² in diameter.
- Always place the grounding as near as possible to the equipment.
- Connect to a reliable outdoor grounding point (earth) using one ground screw.
- The connection of the grounding points and ground bar need to be tight and reliable. Rustproofing the terminals, e.g., with anti-oxidant coating or grease, is required.

Weatherproofing

To protect the connection points from weather and climate, clean each connection point before installing cold shrink tubes, per the following.

1. Insert the cable into the cold shrink tube.
2. Tighten the connector.
3. Push the cold shrink tube to the top joint, and pull out the strip.
4. Ensure the cold shrink tube is tightly fitted with the connection.

Weatherproofing



Installation

Unpacking

Before opening the box, make sure the package is in good condition, undamaged and not wet. During the unpacking, avoid potential damaging impacts from hits or excessive force.

Once unpacked, check whether the quantity is consistent with the packing list.

Installation Procedure Overview

The A2415 CAP installation process is generally as follows:

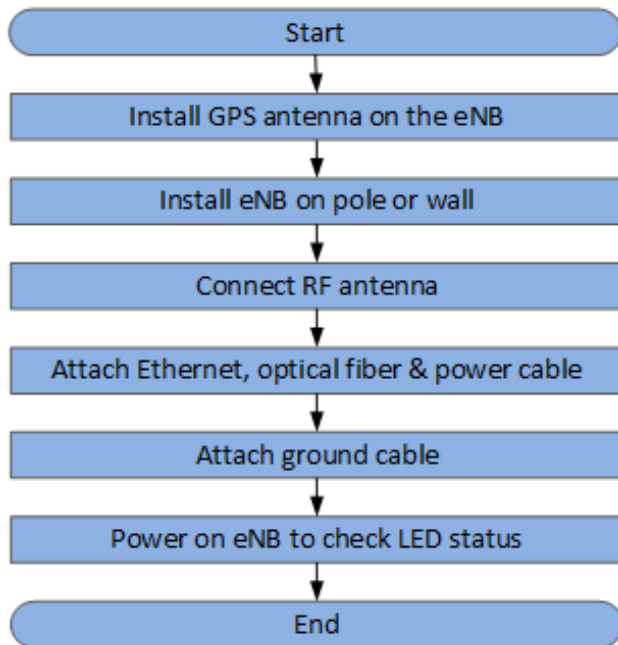

Installing the GNSS Antenna

Read the following GNSS/GPS antenna installation requirements before installing it on the CAP.

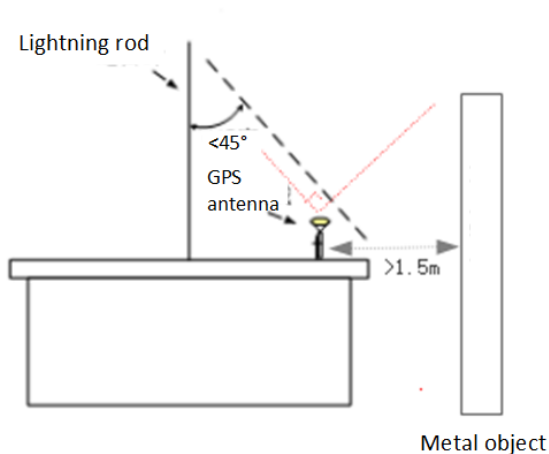

- No major blocking from buildings in the vicinity. Keep the rooftop buildings a distance away from the GPS. Make sure the space atop within 90 degrees (at least 45 degrees) is not blocked by any buildings.
- Avoid installing the GNSS in the vicinity of any other transmitting and receiving devices. Avoid interference from other transmitting antennas to the GNSS antennas.
- The GNSS antenna should be installed within 45 degrees to the lightning rod.
- When two or more GNSS antennas are installed, it is recommended to keep the spacing of more than 2 meters and install multiple GNSS antennas in different locations to prevent simultaneous interference.
- Do not install the GNSS antenna near other transmitting and receiving equipment. Do not install it under the microwave antenna or high voltage cable. Avoid the direction of radiation from other transmitting antennas to the GNSS antenna.
- GNSS antenna feeders cannot be grounded together with ground conductors of interfering equipment such as air conditioners, motors, and pump motors, etc. to prevent external interference from being introduced into the antenna system.

The GNSS antenna system is assembled before packing. The only installation step is to affix the GPS mounting bracket on the CAP with the M4*14 screws.

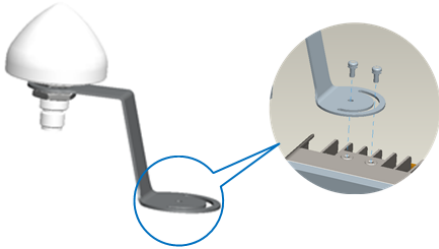

NOTE: Included GPS antenna may vary from the one shown, while the installation steps are the same.

Install on Pole

The CAP mounting bracket is assembled in manufacturing before packing. The only action required by the installer is to fix the assembly on the pole.

Check to ensure the diameter of the pole is in the range of 1.6 inches to 2.8 inches (40mm to 70 mm). The position of the gNB on the pole should be at least 47 inches (120 cm) in height.

Follow the steps below to install the CAP on a pole.

1. Unscrew the 4 screws of the assembled bracket. Slide the two omega clamps to the left, and then turn them up or down.

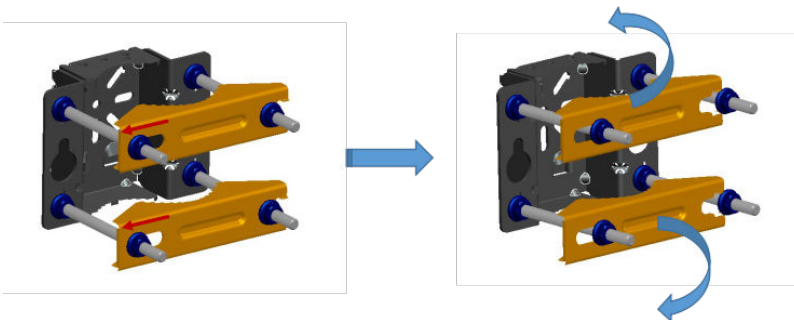

2. Attach the bracket to the pole, considering the height requirements described above. Fit the threaded rod of the bracket to the pole, and then turn the 2 clamps to the proper position. Fasten with the 4 screws.

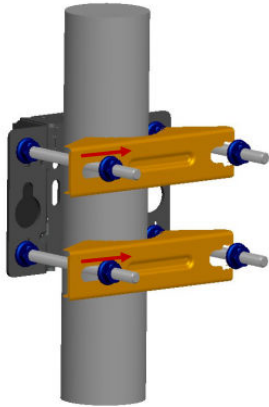

3. Align the pin on the CAP bracket to the pin holes on the pole bracket, lower the pin into the pin holes vertically until the hook on the CAP gets stuck firmly with the slot on the pole bracket.

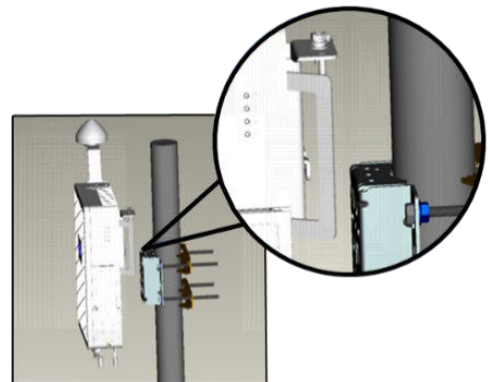
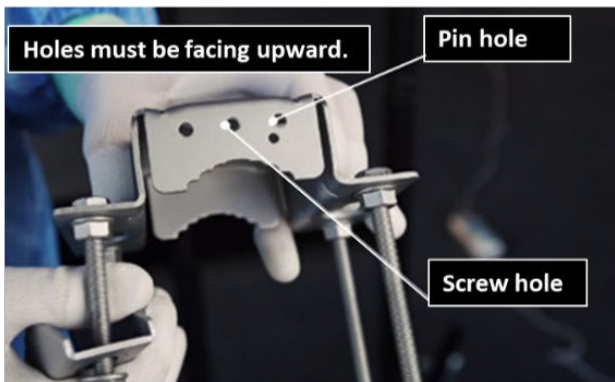

4. Tighten the screw on the top of the bracket using a Phillips screwdriver to complete the installation.



5. Proceed to "3.6 Connect Cable".

Install on Wall

Ensure that the wall can bear at least 4 times the weight of the CAP. Follow the steps below to install the A2415 CAP on the wall.

1. Take apart the assembled installation bracket kit to get the installation bracket.
2. Hold the installation bracket against the wall, with the arrow pointing up. Mark the drilling locations using a pencil or marker.

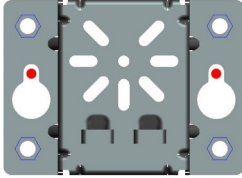

3. Drill two .4in/10mm diameter by 2.8in/70mm deep holes in the wall at the marked locations.
4. Insert M8 * 80 expansion screws and fasten.
5. Check the up/down direction of the installation bracket, and then fix it to the wall with M8 * 80 expansion screws.
6. Refer to pole installation steps, fix the CAP on the wall bracket.

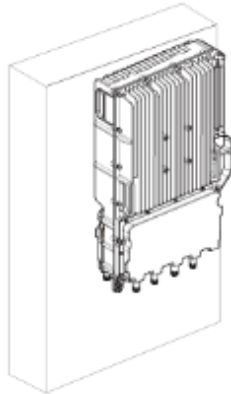

Connect Cable

Cable Laying Requirements

General requirements:

- Bending radius of feeder cable: 7/8" > 250mm, 4/5" > 380mm.
- Bending radius of jumper cable: 1/4" > 35mm, 1/2" (super soft) > 50mm, 1/2" (ordinary) > 127mm.
- Bending radius of power cable and grounding cable: > tripled of the diameter of the cable.
- The minimum bend radius of the optical fiber is the 20 times the diameter of the optical fiber.
- Bind the cables according the type of the cable, intertwining and crossing are forbidden.
- An identification label should be attached after the cable is laid.

Optical fiber laying requirements:

- Avoid circling and twisting during the laying.
- Avoid binding on a turn.

- Avoid pulling and weighing down the optical fiber.
- The redundant optical fiber must enwind the dedicated device.

Grounding laying requirements:

- The grounding cable must connect to the grounding point.
- The grounding cable must be separate with the signal cables, of enough distance to avoid signal interference.

Connecting the GNSS Antenna

1. Insert the GNSS jumper into a cold shrink tube.
2. Connect one end of the GNSS jumper to the GNSS antenna.
3. Push the cold shrink tube to the top joint, and pull out the strip.
4. Take another cold shrink tube, and the GPS jumper through it.
5. Connect the other end of the GNSS jumper to **GPS** interface on the CAP, which also needs weatherproof protection.

The top of the GNSS antenna should avoid the frontal position of the directional antenna as far as possible. In the case of obstruction, it is recommended to pull away and install the GNSS antenna, that is, the GNSS antenna be installed in an open and lightning protected position.

Connecting the RF Cable



CAUTION

It is strictly prohibited to activate the cell and transmit RF if the antenna feed system is not connected properly. The wireless signal transmission power of the outdoor CAPs is powerful, and if the CAP transmits without the antenna feed system it can cause injury to installation personnel and damage the RF power amplifier devices.

1. Open the dust caps of the **ANT0**, **ANT1**, **ANT2**, and **ANT3** interfaces.
2. Insert RF cables into cold shrink tubes.
3. Connect RF cables to the **ANT0**, **ANT1**, **ANT2**, and **ANT3** interfaces on the CAP, and tighten them with wrench to 12-15 in-lbs or 1.4-1.7 NM torque.
4. Push the cold shrink tube to the top joint and pull out the strip.
5. Pass the free end of the cable through a second cold shrink tube.
6. Connect the other end of the RF cables to the external antenna.
7. Push the cold shrink tube to the antenna connector, and pull out the strip.

Connecting the Optical Fiber

1. Unscrew the 3 screws on the cover of the CAP's wiring cavity using M4 cross screwdriver. Open the wiring cavity.
2. Connect the optical fiber to **OPT** interface in the wiring cavity.
3. Lay the optical fiber along the wire groove, and stretch out the wiring cavity from **OPT** hole.

Coil up the leftover fiber neatly to avoid damaging the cable as installation proceeds.

Connecting the Ethernet Cable

1. Connect the Ethernet cable to **ETH** interface in the wiring cavity.
2. Lay the Ethernet cable along the wire groove, and straighten out the cable from the wiring cavity and **ETH** port.

Connecting the Power Connector

Since the length of cable needed for power varies from site to site, the two ends of the power adapter are bare terminal ends. You will need to make the power cable according to the actual measurements of the installation site, and assemble the power plug and power terminal on the two ends of the power adapter, as shown.



- AC power
 - It is recommended to install an air switch in the distribution box for lightning protection and leakage protection, or a socket or plug with a fuse.
 - The power cord needs to be protected by a soft casing or wiring tube.
 - The distribution box should be grounding and have leakage protection.



Strip .47in/12mm insulating layer with a wire stripper, reserved conductor is used for connection. The power cord length should be kept below 330 ft/100m.



NOTE

If the adapter connects to a surge arrester, it must be grounded.

- DC power
 - If the outlet is indoors, place the power adapter indoors.
 - If the outlet is outdoors, place the power adapter in a waterproof box.
- The AC power cord length from the adaptor should be kept below 98.4 ft/30m.

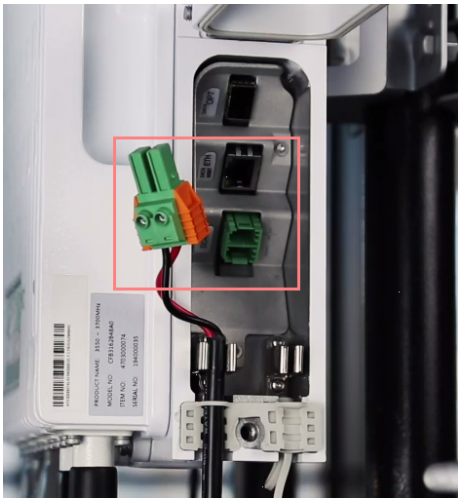

The connection steps for the power cable are as follows.

1. Assemble the power plug.
The power plug should be self-prepared according to local standards by the customer.
The power plug will be installed on the end of the input direction. Refer to the labels on the power plug for connecting the live wire, neutral wire, and ground wire to the corresponding terminals separately, and tighten the screws.
2. Assemble the power terminal.
The power terminal will be installed on the end of the output direction. Refer to the image to see the live wire and neutral wire connections.



3. Connect the power cable to the **PWR** interface in the wiring cavity.
4. The power cable lays along the lint slot, from the wiring cavity and the PWR hole.
5. The input of the power adapter connects to the outlet.
6. After the cable connection is complete in the wiring cavity, tighten the screws on the cover to close the wiring cavity using M4 phillips screwdriver.

Connecting the Ground Cable

Pole Grounding

The purpose of the pole grounding is to protect the equipment in the station from the damage of lightning overvoltage as far as possible. However, the interfaces between the CAP and the outside world mainly include power system, grounding system, antenna feeder and lightning receiving device, and signal line. Therefore, the damage caused by lightning mainly comes from the voltage difference between the equipment in the CAP and one or more of the four interfaces.

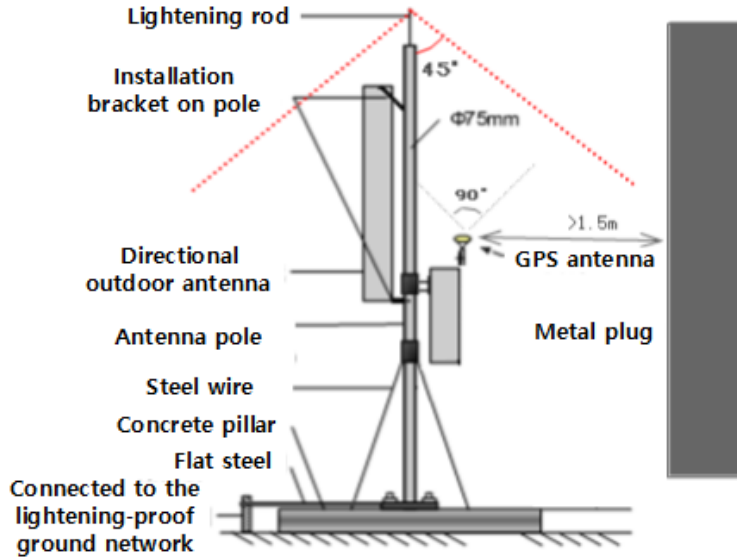

Pole Grounding Requirements

1. The installation position of the grounding bar shall meet the design requirements. The holding pole and tower body must be connected to the lightning protection network or grounded with a separate lead.
2. The diameter of the grounding wire meets the design requirements. The copper nose must be used for grounding, and the grounding resistance is required to be less than 10 ohms. If the resistance of the public network communication equipment placed in other systems is less than 10 ohms, the grounding network of the system should be overlapped.
3. The grounding wire must be the whole wire material. When laying, it should be bound separately with other cables. All grounding wires should be fixed with wire code or binding tape with a fixed spacing of 0.3m. The appearance should be straight and beautiful.
4. The copper bar must be used for the grounding bar, and the specification of the grounding bar shall meet the design requirements. If there are no specific requirements in the design, 300 × 40 × 4mm and fixed with expansion bolts.
5. The grounding wire must be made of the whole cable material, the intermediate joint is strictly prohibited, and the excess length should be cut. The skin shall be complete, and the insulation resistance of the core wire to the ground (or metal isolation layer) shall meet the technical requirements of the cable.
6. The grounding wire shall be connected to the integrated grounding bar of the building. If it is impossible to connect to the integrated grounding bar of the building, the appropriate grounding point can be selected according to the integrated grounding situation of the indoor building. The selection of grounding point must be higher than the grounding grid, and the feeder grounding shall be towards the downward direction of the feeder, never upward.
7. The grounding electrode of the self-built grounding grid for the outdoor antenna of the tunnel must meet the design requirements. The buried depth of the grounding electrode and the welding quality of the flat iron meet the specification requirements. In principle, the buried depth of the grounding electrode shall not be less than 0.7m. The non-self-built grounding network shall be connected to the grounding network of the owner.
8. The CAP grounding, power adapter grounding, distribution box grounding and feeder grounding must be connected to the grounding bar independently, and the grounding bar must have a path from the lead to the earth.

CAP Grounding

Prepare the grounding cable according to the actual measurements and requirements of the specific installation site. The CAP has two grounding screws located on the bottom of the unit. Follow the steps below the figure to connect the ground cable.

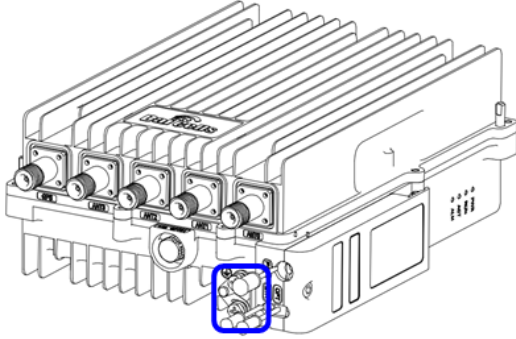

1. Unscrew one grounding screw, connect one end of the ground cable to the grounding screw, and fasten it again.
2. Once the CAP is installed at the outdoor location, the other end of the ground cable needs to connect to a good grounding point.

GPS Antenna Grounding

If the length of GPS antenna is more than 5 meters, it is recommended to extend the installation distance. It is suggested to carry out lightning protection of GPS antenna, add lightning protector, and connect the lightning protector to the grounding bar.

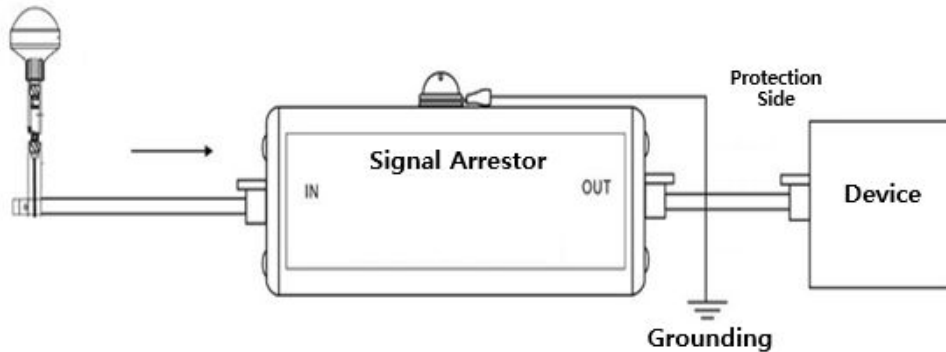

Power Adapter Grounding

The adapter ground terminal is connected to the ground bar conforming to the local standard through the ground wire, as shown.

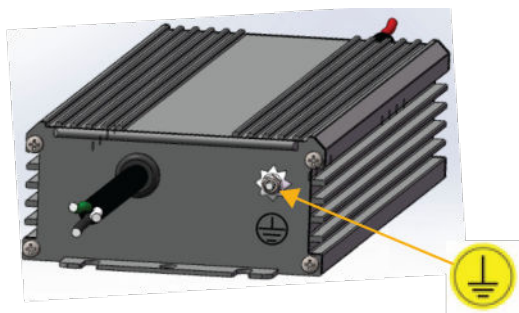

Waterproofing the Maintenance Chamber

When all the installation has been completed, close the maintenance chamber and waterproof the connections at the same time.

1. Clamp the power cord to the wire position and seal the wire diameter 9 ± 1 mm.
2. Put the pigtail / network cable on the wire, and seal the wire diameter 7 ± 1 mm.

Powering on to Check LED Status

Power on the CAP, and wait a few minutes while the CAP boots up. Verify that the LED indicators light up as expected.

Troubleshooting

FAQ

1. After the device is connected with the power line, the PWR of the device will not be displayed when it is powered on.
 - a. Maybe the power line is not connected well, and the contact is poor.
 - b. There is no power in the circuit.
 - c. Reverse connection of DC wire.
 - d. The adapter does not work.
 - e. Poor contact of equipment power interface.
2. How do you connect the antenna feeder?
 - a. ANT0 is the main channel and ANT1 is the secondary channel.
3. Why is the GNSS out of sync?
 - a. The antenna is not installed in an open place.
 - b. The antenna is blocked, which affects the search.
 - c. There are strong interference sources around the installation location, such as large transformer station and high-power motor fan.
 - d. Installed under the front cover of wireless antenna, strong signal interference and so on.
 - e. GPS satellite search is slow and takes a long time. The number of satellites and signal strength can be observed in the maintenance page.
4. What is the best practice for roof pole installation?
 - a. Not near the edge.
 - b. The position of non-bearing beam cannot be selected.
 - c. Do not choose the side close to the barrier, you need to choose the most open position.
5. Why is the coverage of CAP signal not ideal after installation and powering up?
 - a. Check if the power is full in the base station configuration.
 - b. Check whether the equipment has standing wave alarm. If there is any alarm, please handle it in time.
 - c. Check whether the RF frequency band of the equipment is consistent with that of the antenna.
 - d. Check whether the dip angle planning of the base station is reasonable.
 - e. Whether there is blocking in antenna coverage direct vision.

Common Installation Errors

Avoid these common installation errors:

GPS antenna blocked



Disordered wiring



The holding pole lightning rod is not led to the ground bar



The GPS antenna is mounted on the front of the RF antenna



No lightning rod installed



Disordered wiring of distribution box



Power line and signal cable are crossed

Multiple grounding wires connected to a single point

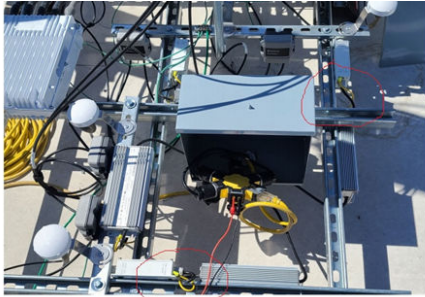

The RF feed system does not connect, the cell is activated and RF transmits signal



Terminology & Acronyms

Acronym	Full Name
ANR	Automatic Neighbor Relations
ARQ	Automatic Repeat Request
CA	Carrier Aggregation
CC	Component Carriers
CSFB	Circuit Switched Fallback
DC	Dual Carrier
EPC	Evolved Packet Core network
GPS	Global Positioning System
HARQ	Hybrid Automatic Repeat Request
IPsec	Internet Protocol Security
MIMO	Multi Input Multi Output
MME	Mobility Management Entity
MOCN	Multi-Operator Core Network
NLOS	Non-Line-of-Sight
OPEX	Operating Expense
PAP	Password Authentication Protocol
PCI	Physical Cell Identifier
PLMN	Public Land Mobile Network
QAM	Quadrature Amplitude Modulation
QCI	QoS Class Identifiers
QoS	Quality of Service
QPSK	Quadrature Phase Shift Keying
RSRP	Reference Signal Receiving Power
SSH	Secure Shell
SON	Self-Organized Network
TAC	Tracking Area Code

Regulatory Compliance

FCC Compliance

For Cradlepoint A2415, Model S1A415A, FCC ID: UXX-S1A415A

This device complies with part 15 of the FCC Rules. Operation is subject to the following two conditions: (1) This device may not cause harmful interference, and (2) this device must accept any interference received, including interference that may cause undesired operation.

Any Changes or modifications not expressly approved by the party responsible for compliance could void the user's authority to operate the equipment.

This equipment has been tested and found to comply with the limits for a Class B digital device, pursuant to part 15 of the FCC Rules. These limits are designed to provide reasonable protection against harmful interference in a residential installation. This equipment generates uses and can radiate radio frequency energy and, if not installed and used in accordance with the instructions, may cause harmful interference to radio communications. However, there is no guarantee that interference will not occur in a particular installation. If this equipment does cause harmful interference to radio or television reception, which can be determined by turning the equipment off and on, the user is encouraged to try to correct the interference by one or more of the following measures:

- Reorient or relocate the receiving antenna.
- Increase the separation between the equipment and receiver.
- Connect the equipment into an outlet on a circuit different from that to which the receiver is connected.
- Consult the dealer or an experienced radio/TV technician for help.

Warning:

This equipment complies with FCC radiation exposure limits set forth for an uncontrolled environment. This equipment should be installed and operated with minimum distance 70cm between the radiator & your body.