



## TEST REPORT

---

Report No.: SRMC2008-H024-E0011

Product Name: GSM Digital Fixed Wireless Phone

Product Model: GD852P

Manufacture: Inventec Appliances  
(Jiangning) Corporation

Specification: FCC Part22, Part 24, Part 2, Part 15

FCC ID: UPMFW390001

The State Radio Monitoring Center, Equipment Testing Division

The State Radio Spectrum Monitoring and Testing Center

No.80 Beilishi Road Xicheng District Beijing, China

Tel: 86-10-68009202 Fax: 86-10-68009205

## CONTENTS

1. General information .....	3
1.1 Notes of the test report .....	3
1.2 Information about the testing laboratory.....	3
1.3 Applicant's details .....	3
1.4 Manufacturer's details.....	3
1.5 Application details .....	4
1.6 Reference specification.....	4
1.7 Information of EUT .....	4
1.7.1 General information.....	4
1.7.2 EUT details .....	5
1.7.3 Auxiliary equipment details.....	5
2. Test information: .....	6
2.1 Summary of the test results: .....	6
2.2 Test result.....	7
2.2.1 GSM850.....	7
2.2.1.1 RF Power Output –FCC Part2.1046.....	7
2.2.1.2 Effective Radiated Power-FCC Part22.913.....	8
2.2.1.3 Occupied Bandwidth-FCC Part2.1049.....	10
2.2.1.4 Spurious Emissions at antenna terminals-FCC Part2.1051/22.917 .....	13
2.2.1.5 Band Edges Compliance-FCC Part2.1051/22.917 .....	16
2.2.1.6 Frequency Stability-FCC Part2.1055/Part22.355 .....	18
2.2.1.7 Radiated Spurious Emissions-FCC Part2.1053/22.917 .....	19
2.2.1.8 Conducted Emissions-FCC Part15.107.....	23
2.2.1.9 Radiated Emissions-FCC Part15.109 .....	25
2.2.2 PCS1900.....	27
2.2.2.1 RF Power Output –FCC Part2.1046.....	27
2.2.2.2 Effective Isotropic Radiated Power-FCC Part24.232.....	28
2.2.2.3 Occupied Bandwidth-FCC Part2.1049.....	30
2.2.2.4 Spurious Emissions at antenna terminals-FCC Part2.1051/24.238 .....	33
2.2.2.5 Band Edges Compliance- FCC Part2.1051/24.238 .....	36
2.2.2.6 Frequency Stability-FCC Part2.1055/Part24.235 .....	38
2.2.2.7 Radiated Spurious Emissions-FCC Part2.1053/24.238 .....	39
2.2.2.8 Conducted Emissions-FCC Part15.107.....	43
2.2.2.9 Radiated Emissions -FCC Part15.109.....	45
2.3. List of test equipments .....	47
Appendix.....	48

---

## 1. General information

### 1.1 Notes of the test report

The test report may only be reproduced or published in full. Reproduction or publication of extracts from the report requires the prior written permission of The State Radio Monitoring Center.

The test results relate only to individual items of the samples which have been tested.

### 1.2 Information about the testing laboratory

Company: The State Radio Monitoring Center, Equipment Testing Division  
The State Radio Spectrum Monitoring and Testing Center  
Address: No.80 Beilishi Road, Xicheng District, Beijing China  
City: Beijing  
Country or Region: China  
Contacted person: Wang Junfeng  
Tel: +86 10 68009181 +86 10 68009202  
Fax: +86 10 68009195 +86 10 68009205  
Email: Wangjf@srrc.org.cn

### 1.3 Applicant's details

Company: Inventec Appliances (Jiangning) Corporation  
Address: Jiangning Economic and Technological Development Zone  
City: Nanjing, 211153 Jiangsu  
Country or Region: P.R.China  
Grantee Code: UPM  
Contacted person: William Zhang  
Tel: +86 25 52262313  
Fax: +86 25 52218366  
Email: zhang.hui-liang@inventec-inc.com

### 1.4 Manufacturer's details

Company: Inventec Appliances (Jiangning) Corporation  
Address: Jiangning Economic and Technological Development Zone  
City: Nanjing, 211153 Jiangsu  
Country or Region: P.R.China  
Grantee Code: UPM  
Contacted person: William Zhang  
Tel: +86 25 52262313  
Fax: +86 25 52218366  
Email: zhang.hui-liang@inventec-inc.com

---

## 1.5 Application details

Date of receipt of application: 15<sup>th</sup> Mar. 2008

Date of receipt of test sample: 15<sup>th</sup> Mar. 2008

Date of test: 8<sup>th</sup> Apr. 2008

## 1.6 Reference specification

FCC Part22, Part 24, Part 2, Part 15

## 1.7 Information of EUT

### 1.7.1 General information

Name of EUT	GSM Digital Fixed Wireless Phone
FCC ID	UPMFW390001
Frequency range	GSM850: Tx:824~849MHz Rx:869~894MHz PCS1900: Tx:1850~1910MHz Rx:1930~1990MHz
Rated output power	GSM850:33.0dBm PCS1900:30.0dBm
Modulation type	GMSK
Duplex mode	FDD
Duplex spacing:	GSM850:45MHz PCS1900:80MHz
Antenna type	External
Power Supply	Battery or charger
Rated Power Supply Voltage	3.7V
Extreme Temperature	-30°C~+50°C

### 1.7.2 EUT details

Name	Model	Serial number
GSM Digital Fixed Wireless Phone	GD852P	007912351

### 1.7.3 Auxiliary equipment details

Equipment	Charger
Manufacturer	DEE VAN ENTERPRISE CO., LTD
Model Number	DSA-5W-05FUS 050040

Equipment	Battery
Manufacturer	BYD COMPANY LIMITED
Model Number	LP043450A(FW39)
Capacity	650mAh
Rated Voltage	3.7V

2. Test information:

2.1 Summary of the test results:

No.	Test case	FCC reference	Verdict
1	RF Power Output	2.1046	Pass
2	Effective Isotropic Radiated Power	22.913/24.232	Pass
3	Occupied Bandwidth,	2.1049	Pass
4	Spurious Emissions at antenna terminals	2.1051/22.917/24.238	Pass
5	Band Edges Compliance	2.1051/22.917/24.238	Pass
6	Frequency Stability	2.1055/24.235/22.355	Pass
7	Radiated Spurious Emissions	2.1053/22.917/24.238	Pass
8	Conducted emissions	15.107	Pass
9	Radiated emissions	15.109	Pass

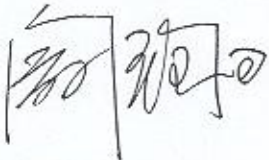
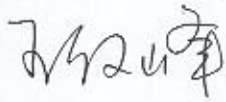
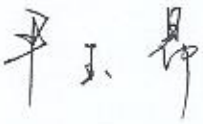
This Test Report Is Issued by: 	Checked by: 
Tested by: 	Issued date: 2008.5.7

## 2.2 Test result

### 2.2.1 GSM850

#### 2.2.1.1 RF Power Output –FCC Part2.1046

Ambient condition:

Temperature	Relative humidity	Pressure
22°C	45%	101.2kPa

Test Setup:

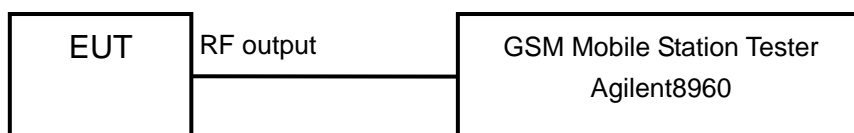

Test procedure:

After a radio link has been established between EUT and Tester, the output power of the cell signal of the testing equipment will be decreased until the output power of the EUT reach a maximum value. Then the test data can be read at the tester screen. The loss between RF output port of the EUT and the input port of the tester will be taken into consideration.

The measurement will be conducted at three channels No128, No189 and No251 (Bottom, middle and top channels of GSM850 band)

Limits	$\leq 33\text{dBm}$
--------	---------------------

Test result:

Carrier frequency (MHz)	Channel No.	RF Power Output (dBm)
824.2	128	31.9
836.4	189	31.7
848.8	251	31.7

### 2.2.1.2 Effective Radiated Power-FCC Part22.913

Ambient condition:

Temperature	Relative humidity	Pressure
22°C	45%	101.2kPa

Test setup

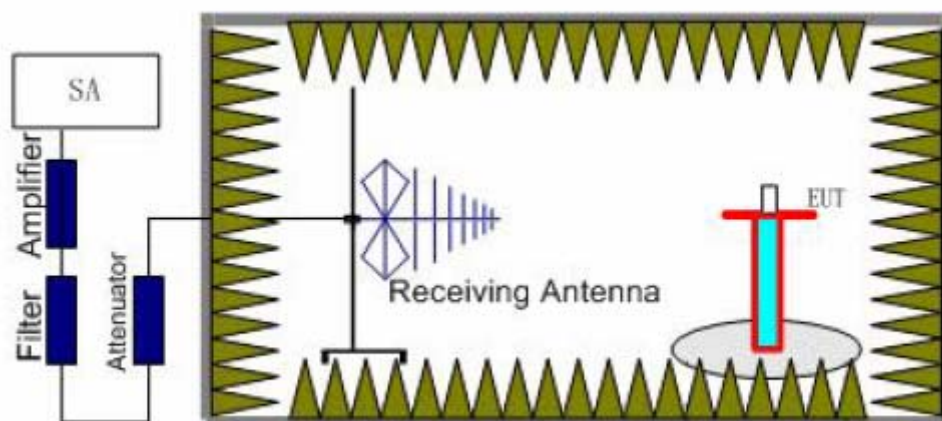

Step 1

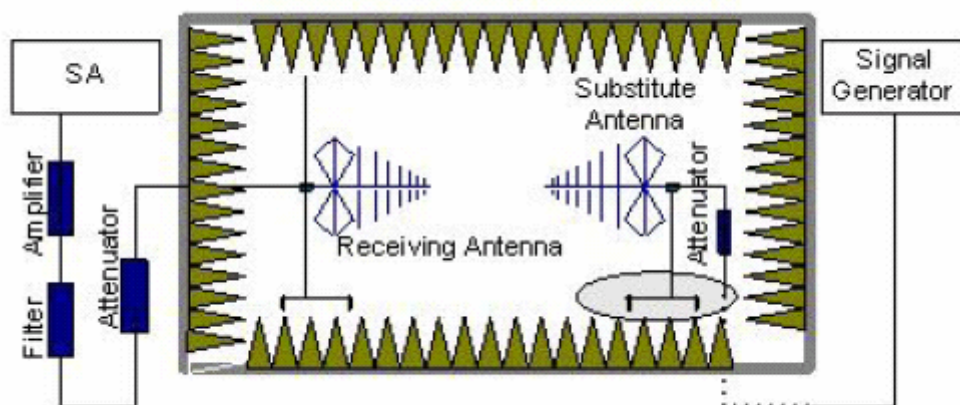

Step 2

Test procedure:

Step 1:

The measurement is carried out in the fully anechoic chamber. EUT was placed on a 2.4 meters high non-conductive table at a 3 meters test distance from the test receive antenna. A receiving antenna was placed on the antenna mast 3 meters from the EUT. The height of receiving antenna is 2.4m and varies in certain range to find the maximum power value. A radio link shall be established between EUT and Tester. The output power of the cell signal of



the tester will be decreased until the output power of the EUT reach a maximum value. A RMS detector is used and RBW is set to 3MHz. Then the antenna height and turn table rotation is adjusted till the maximum power value is founded on spectrum analyzer or receiver.

Step 2:

A log-periodic antenna or double-ridged waveguide horn antenna shall be substituted in place of the EUT. The log-periodic antenna will be driven by a signal generator. To repeat the same procedure as step1 and the level of signal generator will be adjusted till the same power value on the spectrum analyzer or receiver. The ERP/EIRP of the EUT can be calculated through the level of the signal generator, cable loss, the gain of the substitution antenna and the reading of the spectrum analyzer or receiver.

The measurement will be conducted at three channels No128, No189 and No251 (Bottom, middle and top channels of GSM850 band)

Limits	$\leq 38.5\text{dBm}$
--------	-----------------------

Test result:

Carrier frequency (MHz)	Channel No.	E.R.P. (dBm)
824.2	128	28.3
836.4	189	29.7
848.8	251	29.7

### 2.2.1.3 Occupied Bandwidth-FCC Part2.1049

Ambient condition:

Temperature	Relative humidity	Pressure
22°C	45%	101.2kPa

Test Setup:

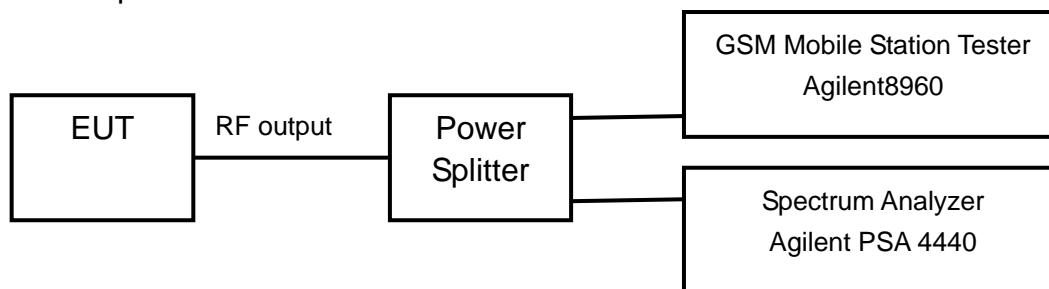

Test procedure:

After a radio link has been established between EUT and Tester, the output power of the cell signal of the testing equipment will be decreased until the output power of the EUT reach a maximum value. The occupied bandwidth is measured using spectrum analyzer. RBW is set to 3kHz on spectrum analyzer. The bandwidth of 99% power can be read on spectrum analyzer. The measurement will be conducted at three channels No128, No189 and No251 (Bottom, middle and top channels of GSM850 band)

Limits: No specific occupied bandwidth requirements in part 2.1049

Test result:

Carrier frequency (MHz)	Channel No.	Bandwidth of 99% Power (MHz)
824.2	128	247.2
836.4	189	247.0
848.8	251	247.8

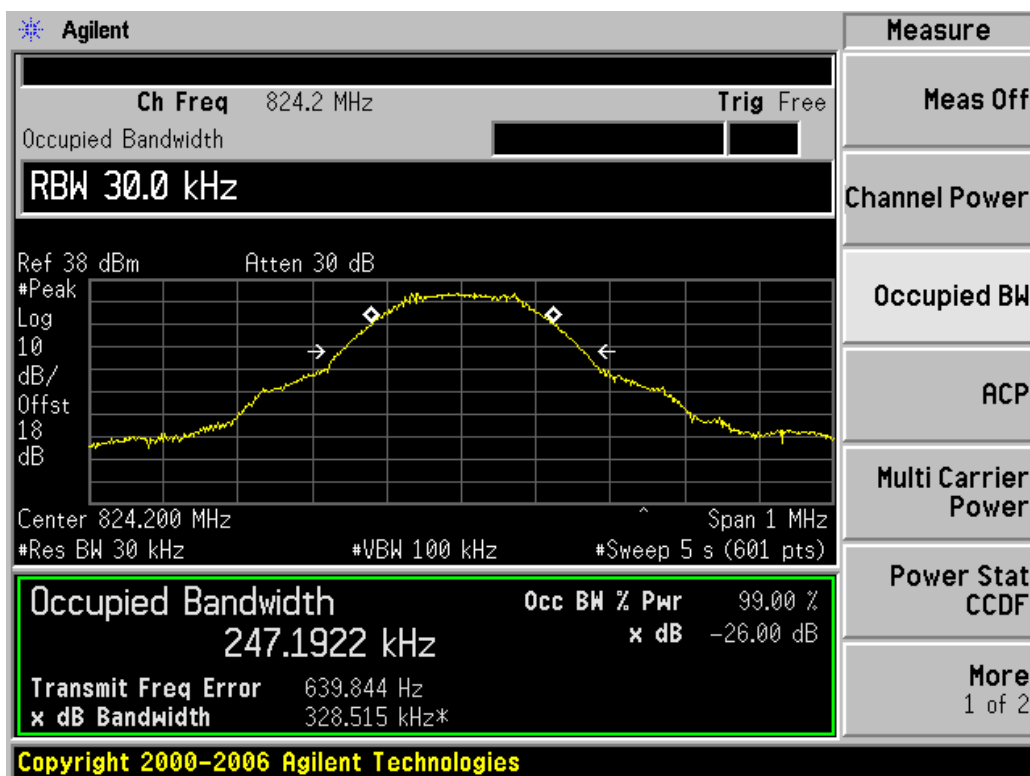

Channel 128

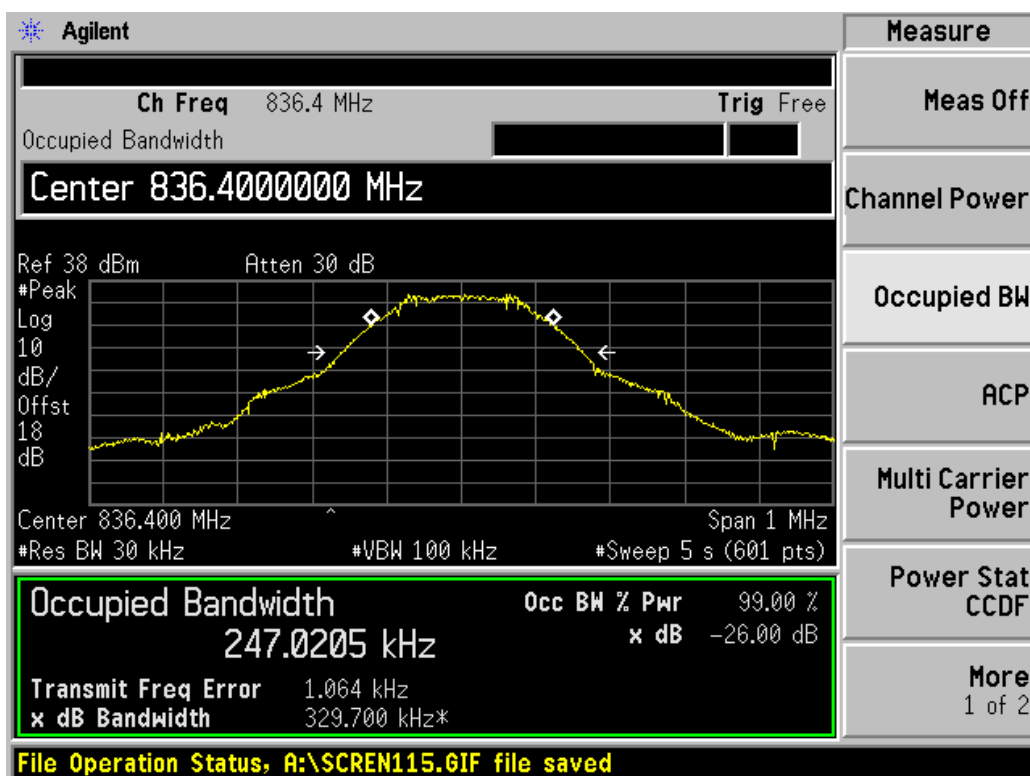

Channel 189

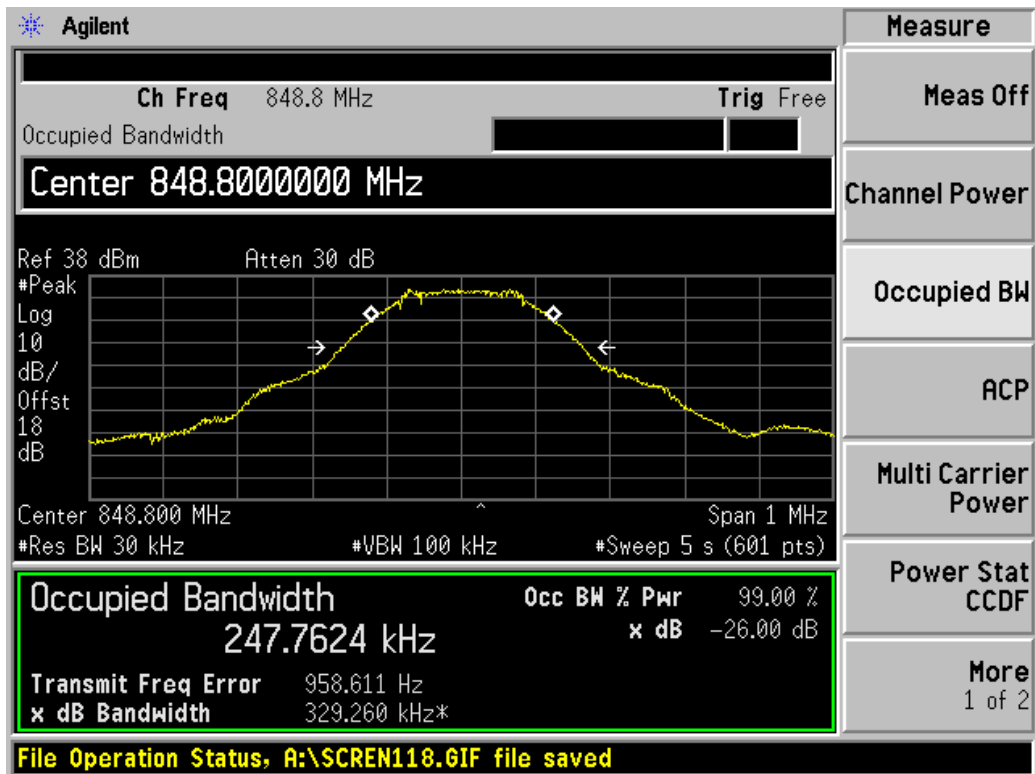

Channel 251

### 2.2.1.4 Spurious Emissions at antenna terminals-FCC Part2.1051/22.917

Ambient condition:

Temperature	Relative humidity	Pressure
22°C	45%	101.2kPa

Test Setup:

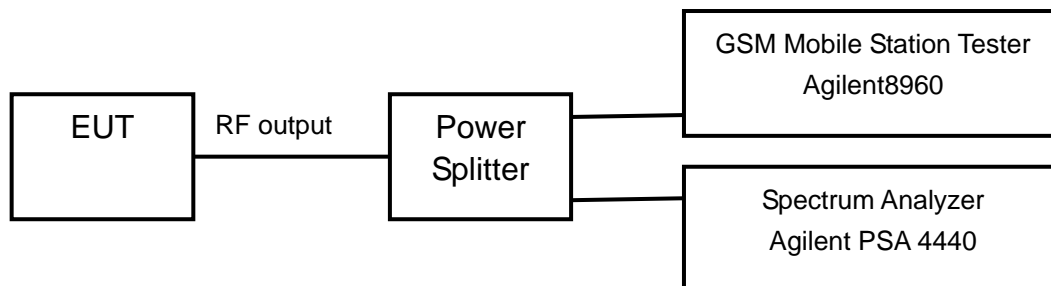

Test procedure:

After a radio link has been established between EUT and Tester, the output power of the cell signal of the testing equipment will be decreased until the output power of the EUT reach a maximum value. The measurement is carried out using a spectrum analyzer. The spectrum analyzer scans from 30MHz to 20GHz (higher than the 10<sup>th</sup> harmonic of the carrier). The peak detector is used and RBW is set to 1MHz on spectrum analyzer.

The measurement will be conducted at one channel No189

Limits	≤ -13dBm
--------	----------

Test result:

Refer to the following figures.

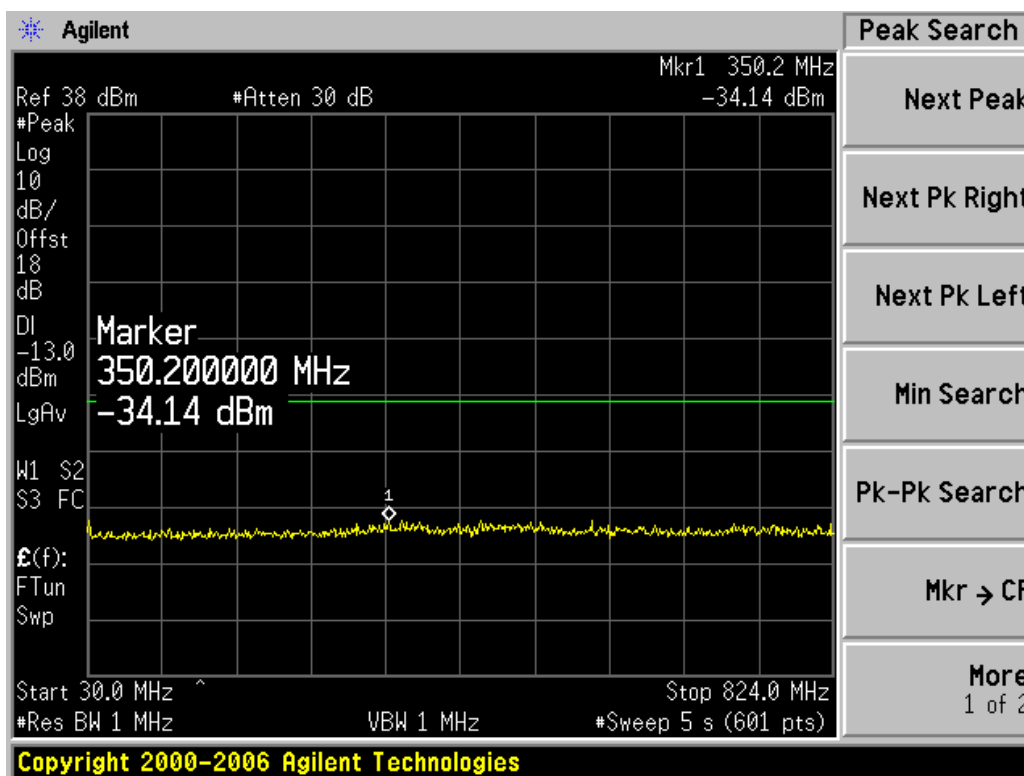

Channel 189, 30MHz~824MHz

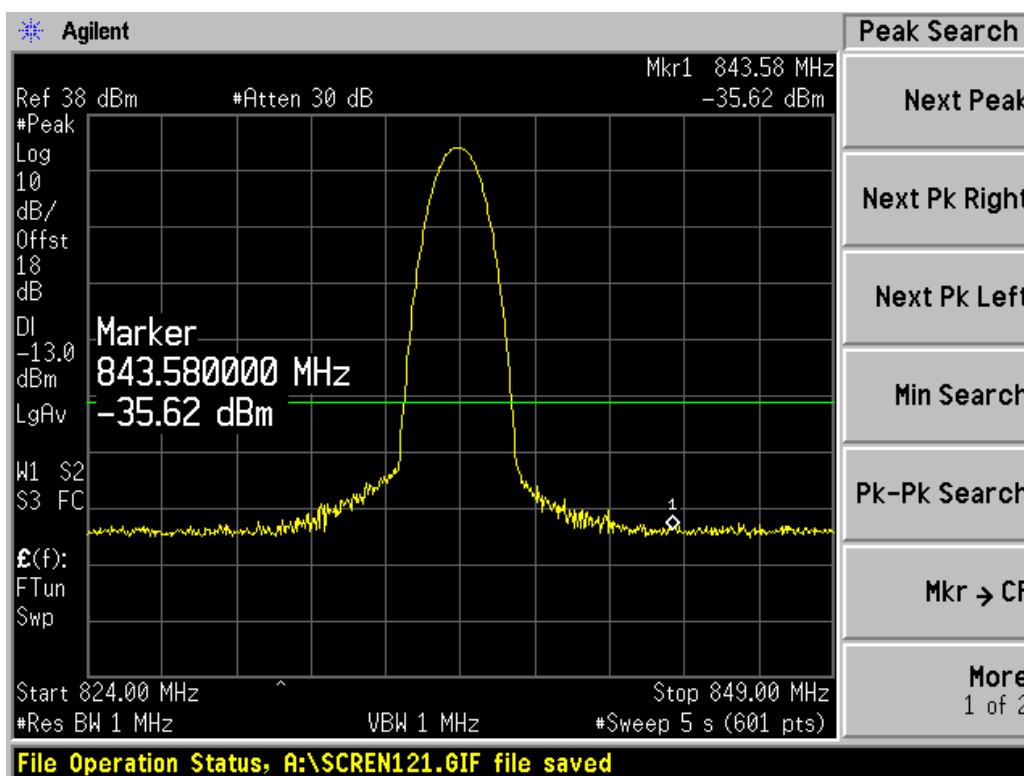

Channel 189, 824MHz~849MHz

Note: The signal beyond the limit is carrier.

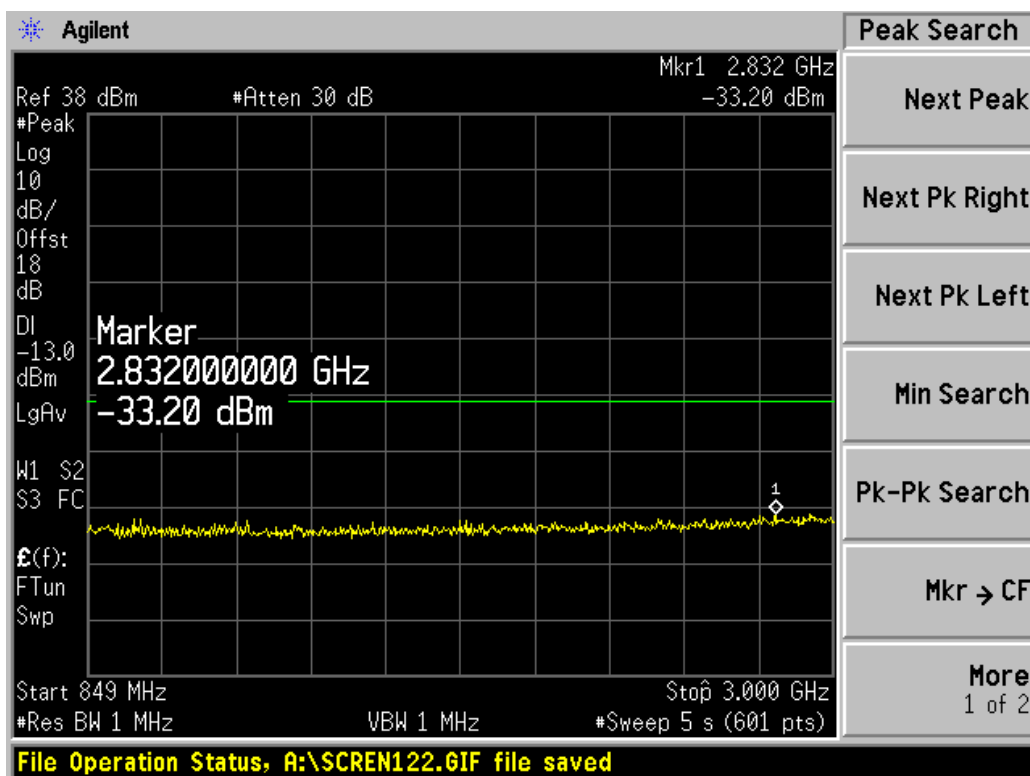

Channel 189, 849MHz~3GHz

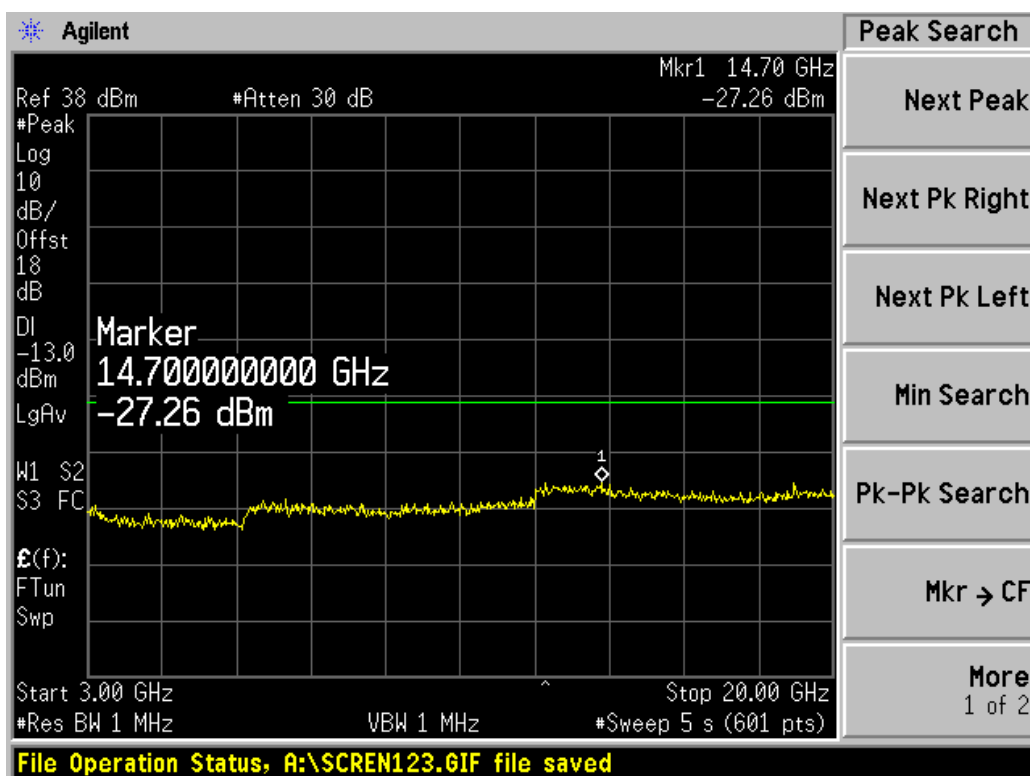

Channel 189, 3GHz~20GHz

### 2.2.1.5 Band Edges Compliance-FCC Part2.1051/22.917

Ambient condition:

Temperature	Relative humidity	Pressure
22°C	45%	101.2kPa

Test Setup:

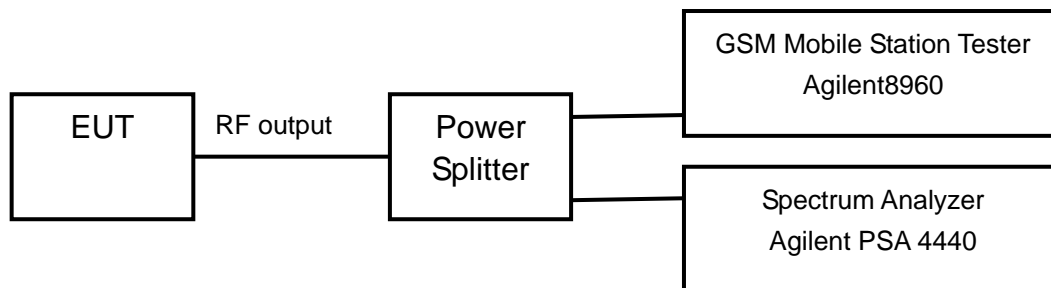

Test procedure:

After a radio link has been established between EUT and Tester, the output power of the cell signal of the testing equipment will be decreased until the output power of the EUT reach a maximum value. The measurement is carried out using a spectrum analyzer. The peak detector is used and RBW is set to 3kHz on spectrum analyzer.

The measurement will be conducted at two channels No128 and No251 (Bottom and top channels of GSM850 band)

Limits	$\leq -13\text{dBm}$
--------	----------------------

Test result:

Refer to the following figures.



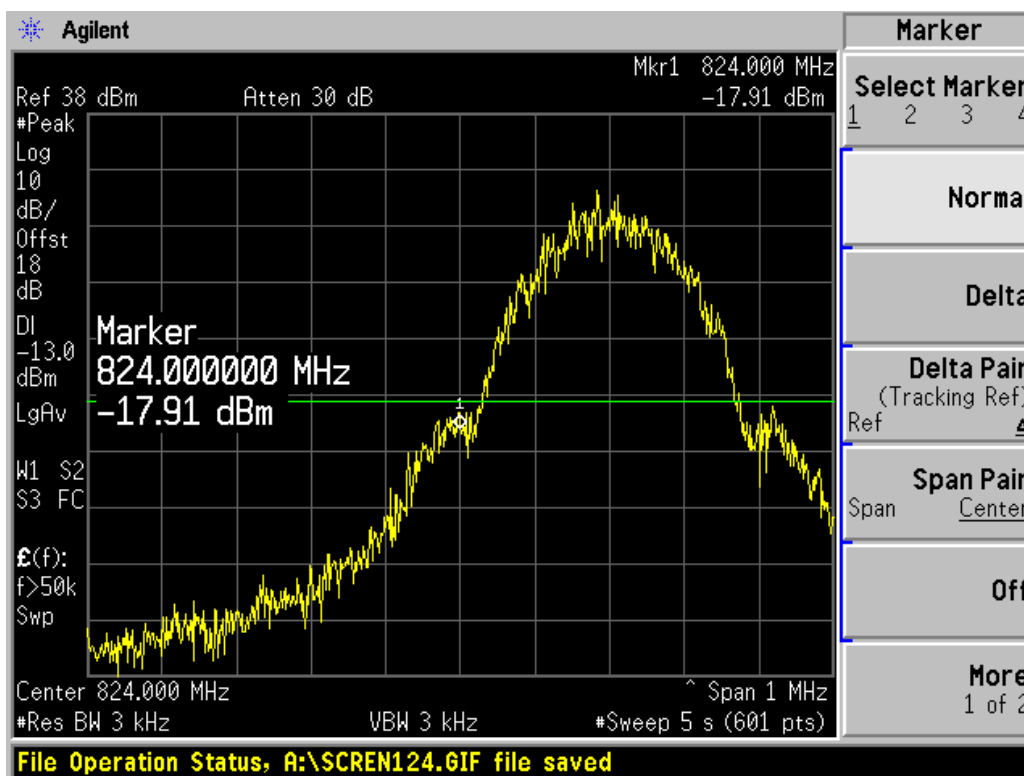

Channel 128

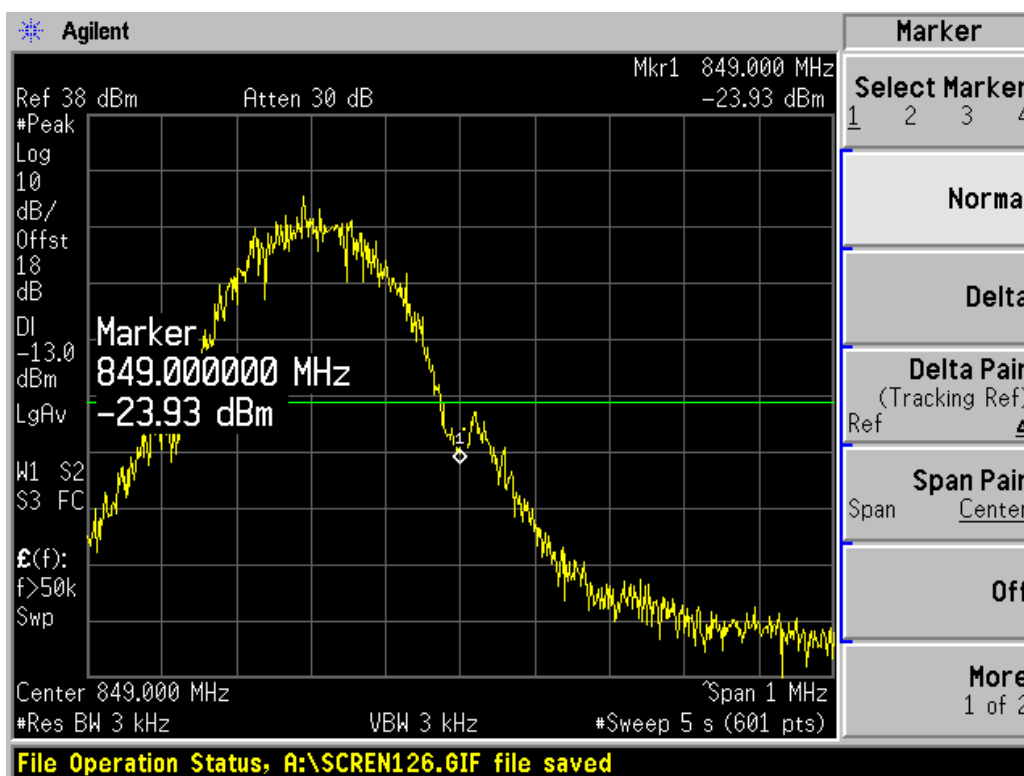

Channel 251

### 2.2.1.6 Frequency Stability-FCC Part2.1055/Part22.355

Ambient condition:

Temperature	Relative humidity	Pressure
22°C	45%	101.2kPa

Test setup:

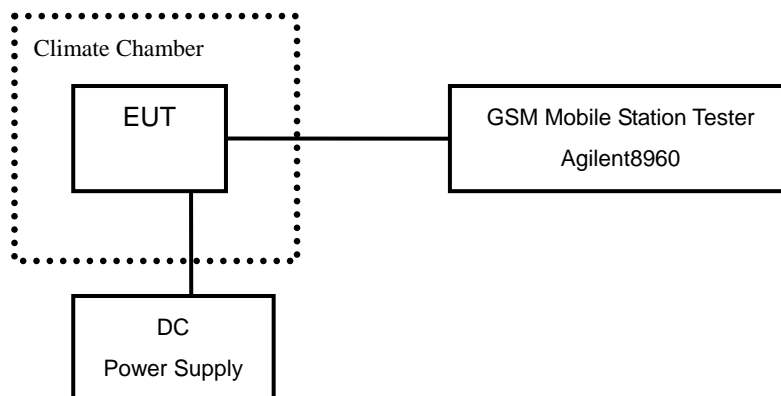

Test Procedure:

A radio link shall be established between EUT and Tester. The tester will sample the transmitter RF output signal and measure its frequency. The temperature inside the climate chamber is varied from -30 to +50° C in 10° C step size, and also the DC power supply voltage to the EUT is varied from 3.55 to 4.2 V.

Limits: No specific frequency stability requirements in part 2.1055 and part 22.355

Test Result:

Temperature(° C)	Test Result (ppm)		
	Channel 128	Channel 189	Channel 251
-30	---	0.015	---
-20	---	0.012	---
-10	---	0.003	---
0	---	0.008	---
+10	---	0.018	---
+20	---	0.013	---
+30	---	0.014	---
+40	---	0.009	---
+50	---	0.016	---

Voltage (V)	Test Result (ppm)		
	Channel 128	Channel 189	Channel 251
3.55	---	0.005	---
4.2	---	0.009	---

### 2.2.1.7 Radiated Spurious Emissions-FCC Part2.1053/22.917

Ambient condition

Temperature	Relative humidity	Pressure
22°C	45%	101.2kPa

Test Setup:

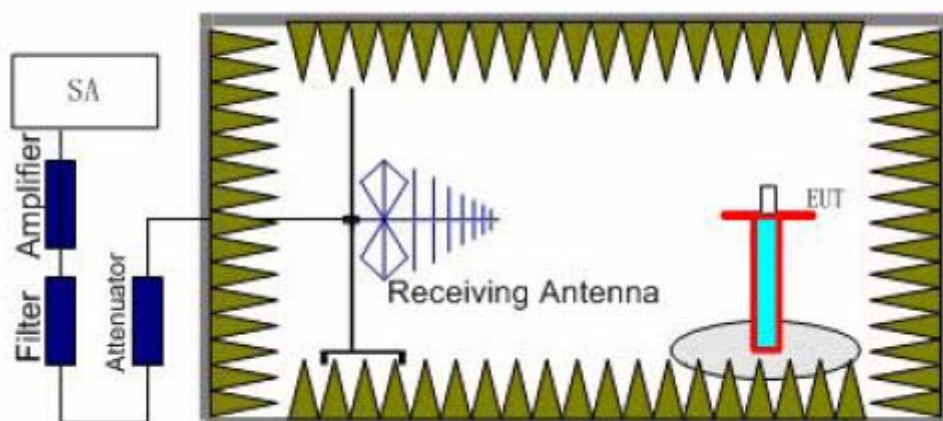

Step 1

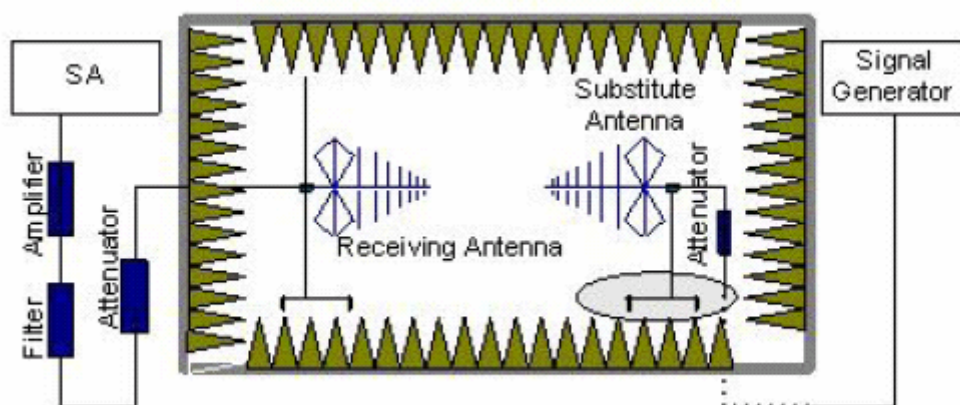

Step 2

Test procedure:

Step 1:

The measurement is carried out in the fully anechoic chamber. EUT was placed on a 2.4 meter high non-conductive table at a 3 meter test distance from the test receive antenna. A receiving antenna was placed on the antenna mast 3 meters from the EUT. The height of receiving antenna is 2.4m and varies in certain range to find the maximum power value. A radio link shall be

established between EUT and Tester. The output power of the cell signal of the tester will be decreased until the output power of the EUT reach a maximum value. The measurement is carried out using a spectrum analyzer or receiver. The spectrum analyzer scans from 30MHz to 20GHz (higher than the 10<sup>th</sup> harmonic of the carrier). The peak detector is used and RBW is set to 1MHz on spectrum analyzer. Then the antenna height and turn table rotation is adjusted till the maximum power value is founded on spectrum analyzer or receiver. A notch filter is necessary in the band near to the carrier frequency. A high pass filter is needed to avoid the distortion of the testing equipment in the band above the carrier frequency.

Step 2:

A log-periodic antenna or double-ridged waveguide horn antenna shall be substituted in place of the EUT. The log-periodic antenna will be driven by a signal generator and the level will be adjusted till the same power value on the spectrum analyzer or receiver. The level of the spurious emissions can be calculated through the level of the signal generator, cable loss, the gain of the substitution antenna and the reading of the spectrum analyzer or receiver.

Calculation procedure:

The data of cable loss, antenna gain and air loss has been calibrated in full testing frequency range before the testing.

The power of the Radiated Spurious Emissions is calculated by adding the cable loss, antenna gain and air loss. The basic equation with a sample calculation is as followed:

$$P=P_R+L_C+L_A-G$$

Where

P: Power of the Radiated Spurious Emissions (dBm)

P<sub>R</sub>: reading of the receiver (dBm)

L<sub>C</sub>: Cable Lose (dB)

L<sub>A</sub>: Air loss (dB)

G: Antenna Gain (dBi)

Assumed the reading of the receiver is -60dBm. A cable lose of 10dB, an air lose of 30dB and an antenna gain of 11dBi are added.

$$P=P_R+L_C+L_A-G=-60+10+30-11=-31\text{dBm}$$

The measurement will be conducted at one channel No189 (middle channels of GSM850 band)

Test result:

Refer to the following figures.

---

Limits	$\leq -13\text{dBm}$
--------	----------------------

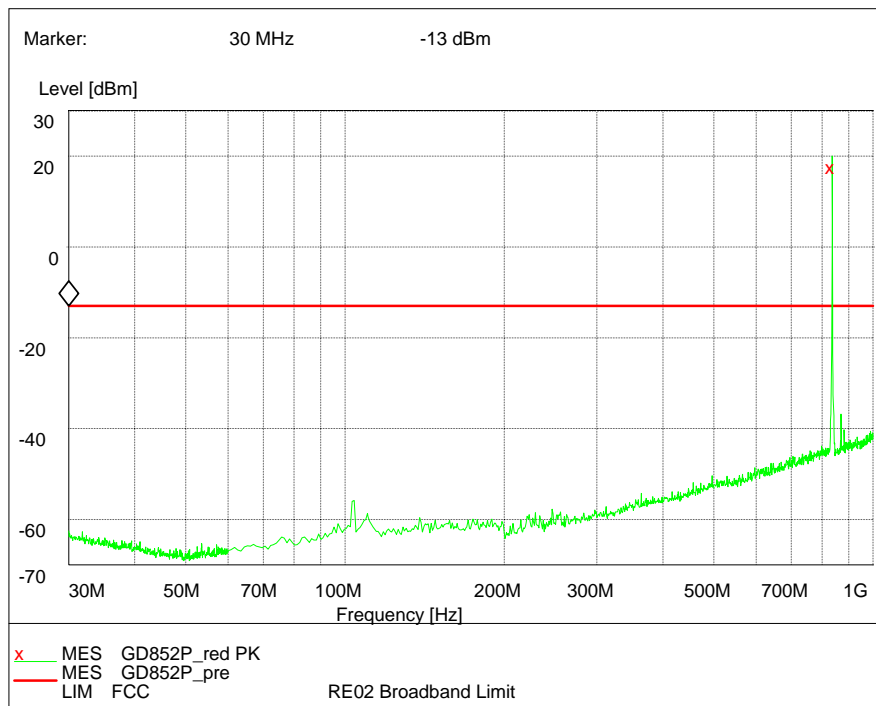

Channel 189, 30MHz~1GHz (Traffic Mode)

Note: The signal beyond the limit is carrier.

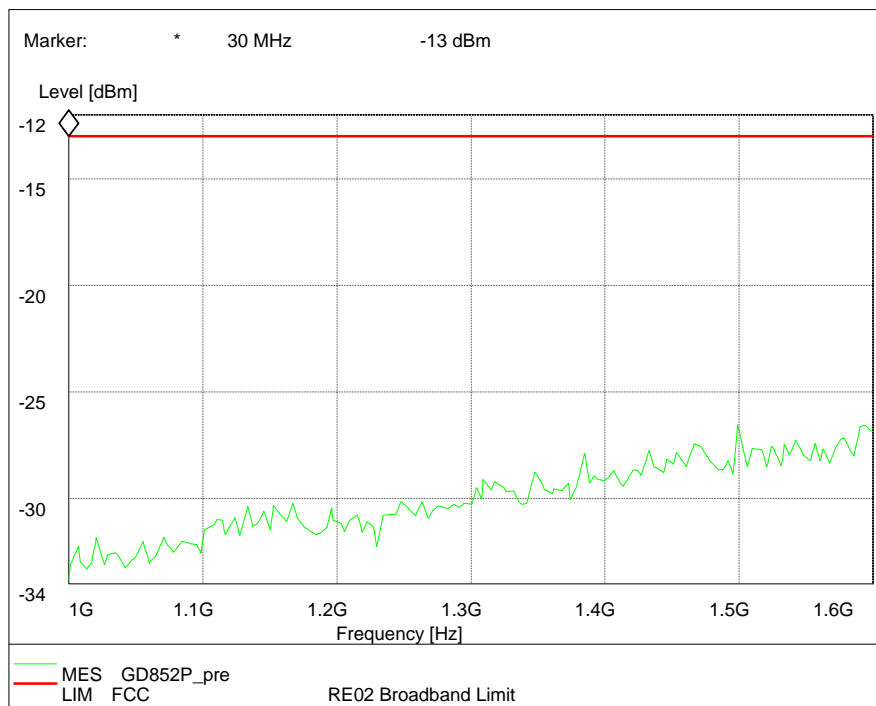

Channel 189, 1GHz~1.6GHz (Traffic Mode)



Channel 189, 1.6GHz~3GHz (Traffic Mode)

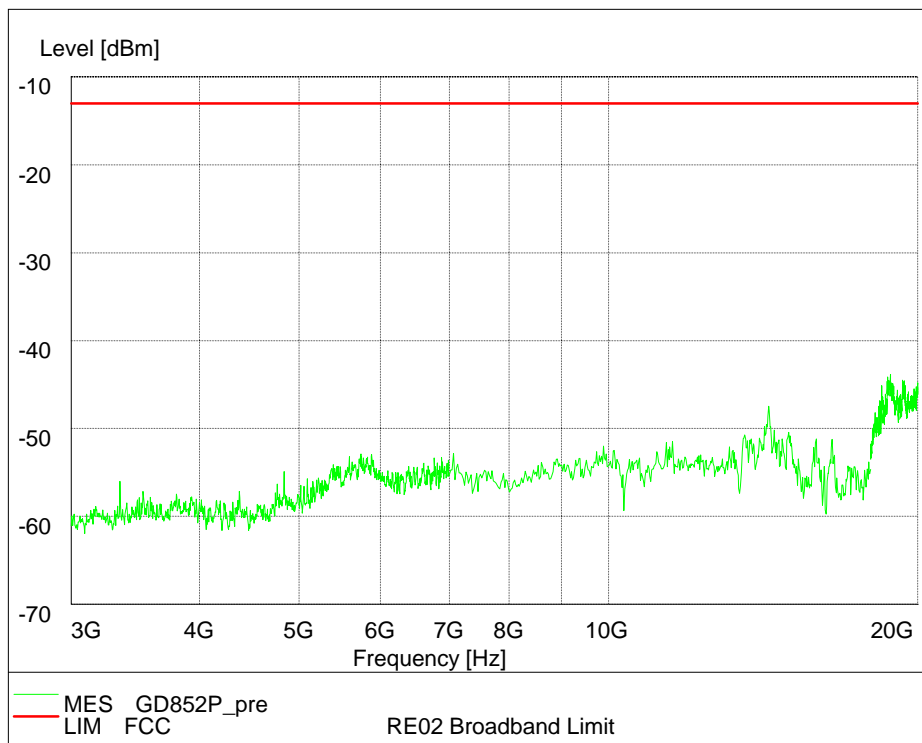

Channel 189, 3GHz~20GHz (Traffic Mode)

### 2.2.1.8 Conducted Emissions-FCC Part15.107

Ambient condition:

Temperature	Relative humidity	Pressure
22°C	45%	101.2kPa

Test Setup:

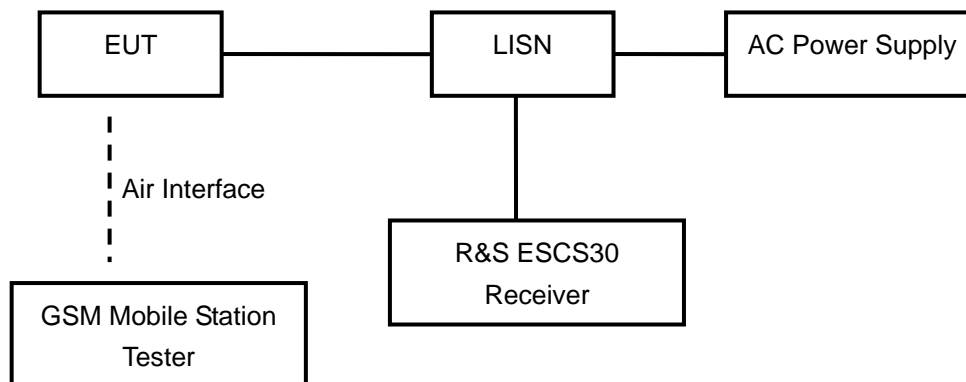

Test Procedure:

The EUT is placed on a non-metallic table 0.8m above the horizontal metal reference ground plane. The EUT is connected to LISN and LISN is connected to the reference ground. All other supplemental devices are connected with EUT through other LISN. The distance between EUT and LISN is 80cm. The measurement should be done both L line and N line. The receiver uses both average detector and quasi-peak detector. A radio link is established between EUT and the tester. The output power of the EUT is controlled by the tester and driven to maximum value.

Frequency of Emission(MHz)	Limits(dB $\mu$ V)	
	Quasi-peak	Average
0.15~0.5	66 to 56*	56 to 46*
0.5~5	56	46
5~30	60	50

Note: \* Decreases with the logarithm of the frequency

Test result:

Refer to the following figures.

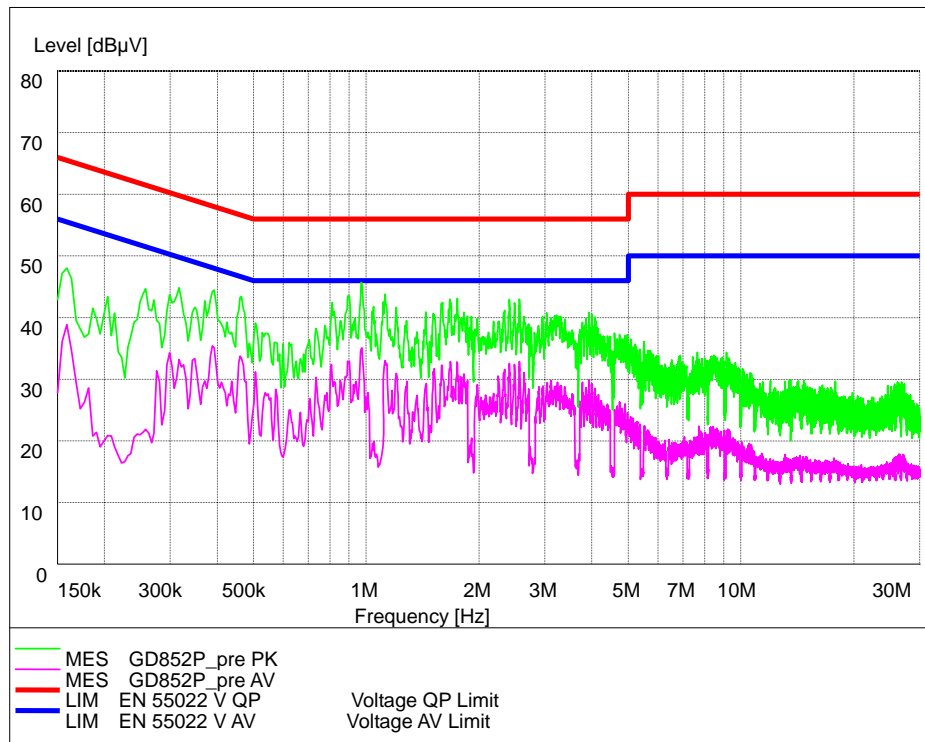

L Line

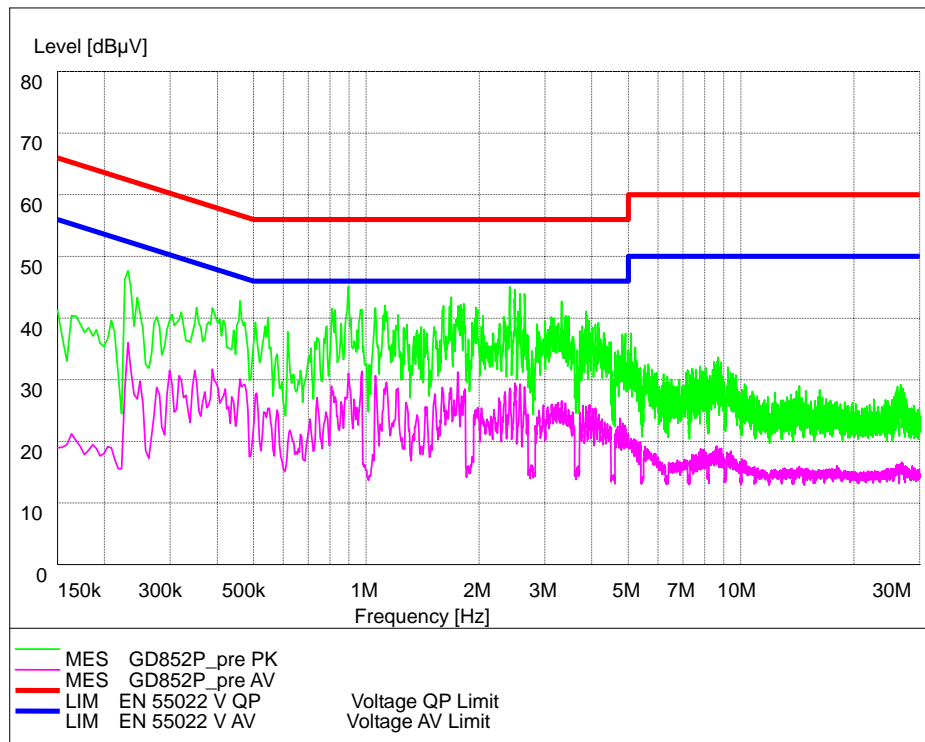

N Line



### 2.2.1.9 Radiated Emissions-FCC Part15.109

Ambient condition:

Temperature	Relative humidity	Pressure
22°C	45%	101.2kPa

Test Setup:

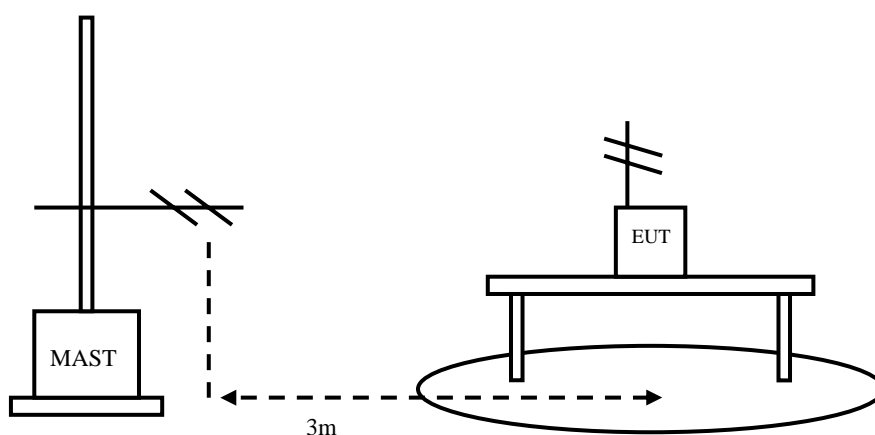

Test Procedure:

The EUT and receive antenna shall be placed to SAC (semi anechoic chamber) upon a non-metallic turn table. The receive antennas shall be moved from 1 to 4 meters. The distance between equipment and receive antenna shall be 3 meters.

Testing shall operate the EUT in typical modes of operation and cable positions in a test set-up which is representative of typical system configurations, as declared by the manufacturer. The output port shall be terminated with 50 ohms.

Then start the test software ES-K1. Sweep the whole frequency band through the range from 30MHz to 1GHz, using receive log period antenna HL562.

During the test, the height of receive antenna shall be moved from 1 to 4 meters, and the antenna shall be performed under horizontal and vertical polarization. The turn table shall be rotated from 0 to 360 degrees for detecting the maximum of radiated spurious signal level. The measurements shall be repeated with orthogonal polarization of the test antenna.

The data of cable loss and antenna factor has been calibrated in full testing frequency range before the testing.

Frequency of Emission(MHz)	Limits	
	Unit( $\mu$ V/m)	Average(dB $\mu$ V/m)
30~88	100	40
88~216	150	43.5
216~960	200	46
960~1000	500	54

Test result:  
 Refer to the following figures.

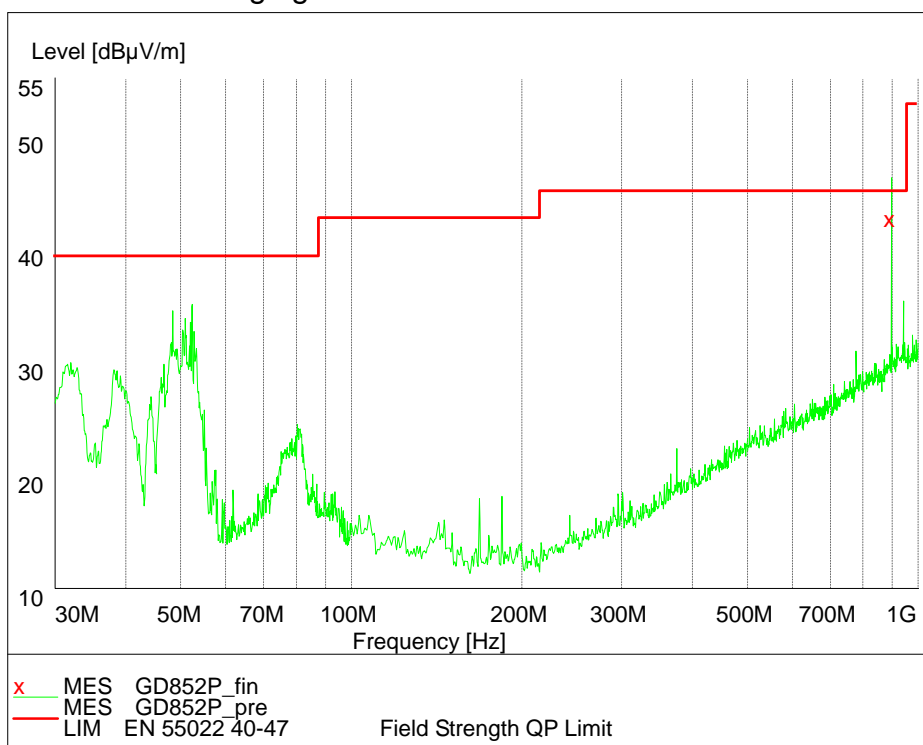

## 2.2.2 PCS1900

### 2.2.2.1 RF Power Output –FCC Part2.1046

Ambient condition:

Temperature	Relative humidity	Pressure
22°C	45%	101.2kPa

Test Setup:

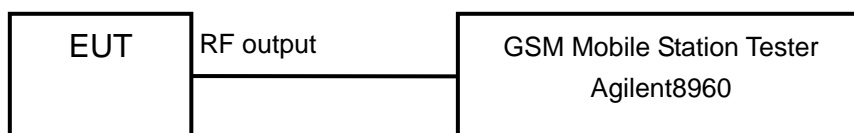

Test procedure:

After a radio link has been established between EUT and Tester, the output power of the cell signal of the testing equipment will be decreased until the output power of the EUT reach a maximum value. Then the test data can be read at the tester screen. The loss between RF output port of the EUT and the input port of the tester will be taken into consideration.

The measurement will be conducted at three channels No512, No661 and No810 (Bottom, middle and top channels of PCS1900 band)

Limits	$\leq 30\text{dBm}$
--------	---------------------

Test result:

Carrier frequency (MHz)	Channel No.	RF Power Output (dBm)
1850.2	512	29.6
1880.0	661	29.7
1909.8	810	29.7

### 2.2.2.2 Effective Isotropic Radiated Power-FCC Part24.232

Ambient condition:

Temperature	Relative humidity	Pressure
22°C	45%	101.2kPa

Test setup

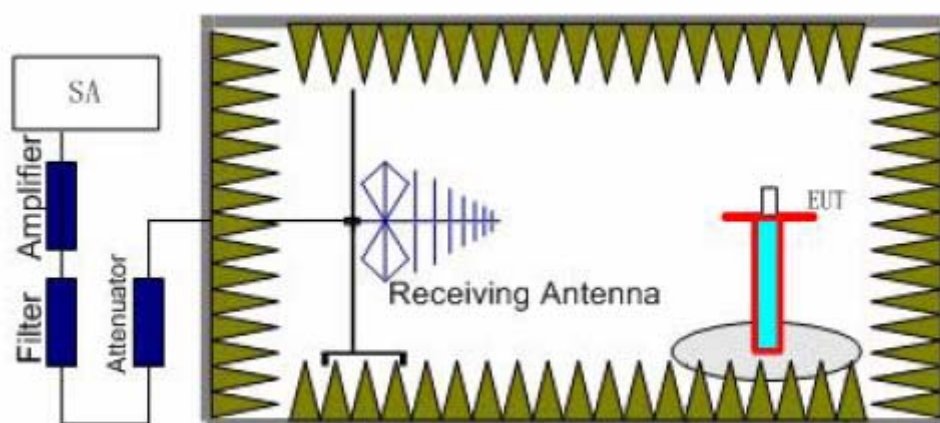

Step 1

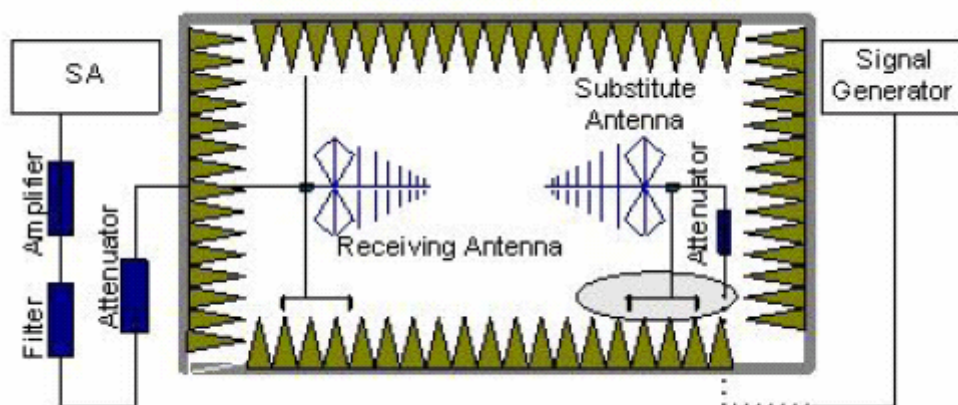

Step 2

Test procedure:

Step 1:

The measurement is carried out in the fully anechoic chamber. EUT was placed on a 2.4 meters high non-conductive table at a 3 meters test distance from the test receive antenna. A receiving antenna was placed on the antenna mast 3 meters from the EUT. The height of receiving antenna is 2.4m and varies in certain range to find the maximum power value. A radio link shall be established between EUT and Tester. The output power of the cell signal of

the tester will be decreased until the output power of the EUT reach a maximum value. A RMS detector is used and RBW is set to 3MHz. Then the antenna height and turn table rotation is adjusted till the maximum power value is founded on spectrum analyzer or receiver.

Step 2:

A log-periodic antenna or double-ridged waveguide horn antenna shall be substituted in place of the EUT. The log-periodic antenna will be driven by a signal generator. To repeat the same procedure as step1 and the level of signal generator will be adjusted till the same power value on the spectrum analyzer or receiver. The ERP/EIRP of the EUT can be calculated through the level of the signal generator, cable loss, the gain of the substitution antenna and the reading of the spectrum analyzer or receiver.

The measurement will be conducted at three channels No512, No661 and No810 (Bottom, middle and top channels of PCS1900 band)

Limits	$\leq 33\text{dBm}$
--------	---------------------

Test result:

Carrier frequency (MHz)	Channel No.	E.I.R.P. (dBm)
1850.2	512	26.1
1880.0	661	28.0
1909.8	810	29.2

### 2.2.2.3 Occupied Bandwidth-FCC Part2.1049

Ambient condition:

Temperature	Relative humidity	Pressure
22°C	45%	101.2kPa

Test Setup:

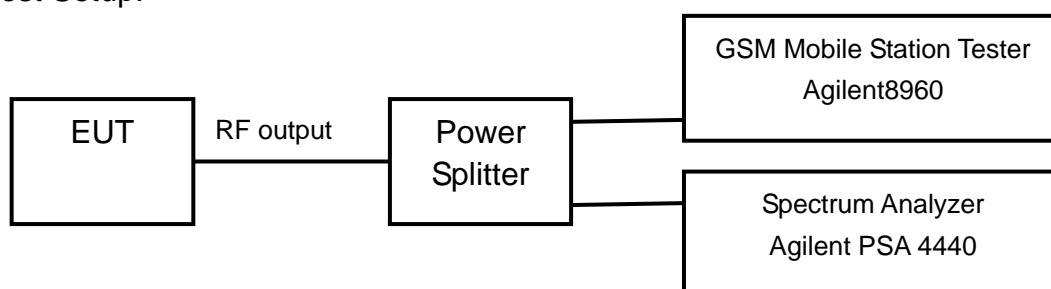

Test procedure:

After a radio link has been established between EUT and Tester, the output power of the cell signal of the testing equipment will be decreased until the output power of the EUT reach a maximum value. The occupied bandwidth is measured using spectrum analyzer. RBW is set to 3kHz on spectrum analyzer. The bandwidth of 99% power can be read on spectrum analyzer. The measurement will be conducted at three channels No512, No661 and No810 (Bottom, middle and top channels of PCS1900 band)

Limits: No specific occupied bandwidth requirements in part 2.1049

Test result:

Carrier frequency (MHz)	Channel No.	Bandwidth of 99% Power (MHz)
1850.2	512	245.0
1880.0	661	242.7
1909.8	810	243.1



Channel 512

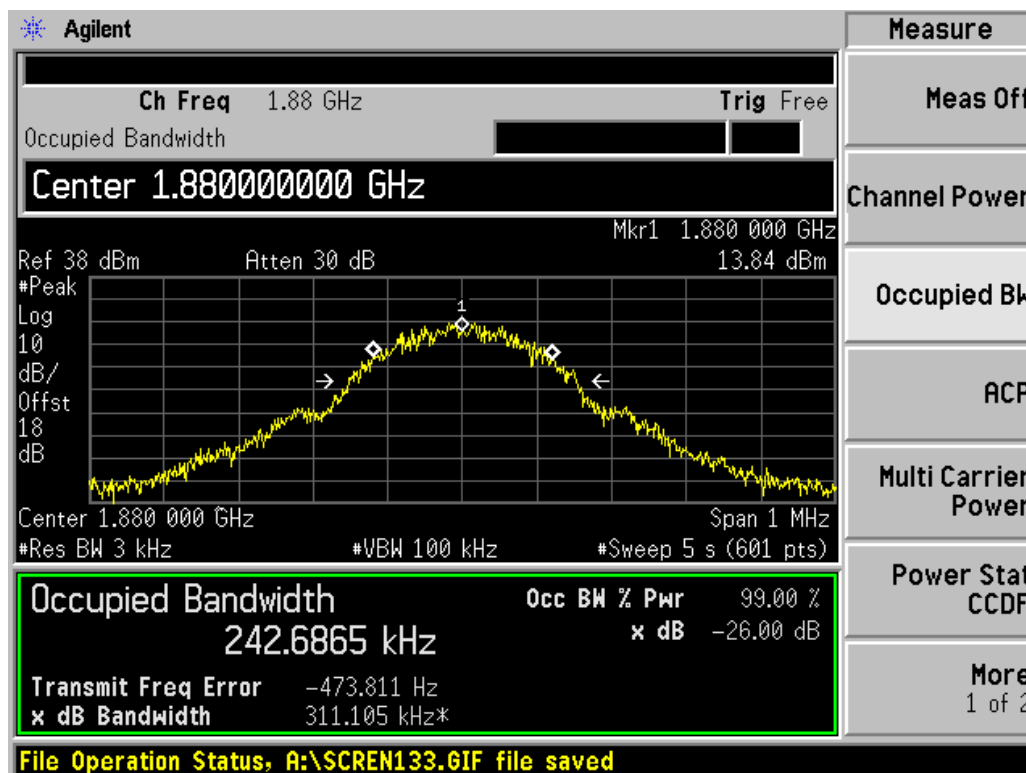

Channel 661

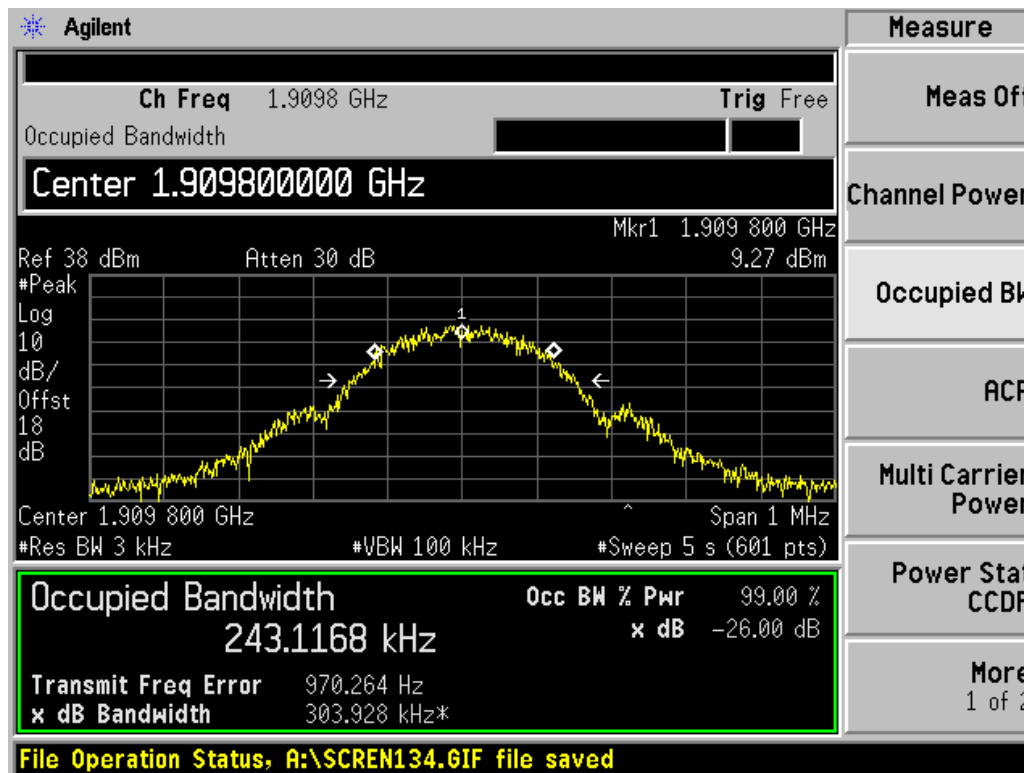

Channel 810



### 2.2.2.4 Spurious Emissions at antenna terminals-FCC Part2.1051/24.238

Ambient condition:

Temperature	Relative humidity	Pressure
22°C	45%	101.2kPa

Test Setup:

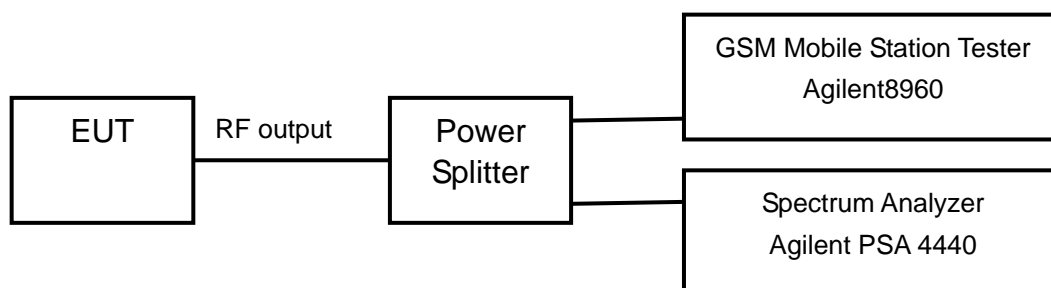

Test procedure:

After a radio link has been established between EUT and Tester, the output power of the cell signal of the testing equipment will be decreased until the output power of the EUT reach a maximum value. The measurement is carried out using a spectrum analyzer. The spectrum analyzer scans from 30MHz to 20GHz (higher than the 10<sup>th</sup> harmonic of the carrier). The peak detector is used and RBW is set to 1MHz on spectrum analyzer.

The measurement will be conducted at three channels No512, No661 and No810 (Bottom, middle and top channels of PCS1900 band)

Limits	≤ -13dBm
--------	----------

Test result:

Refer to the following figures.

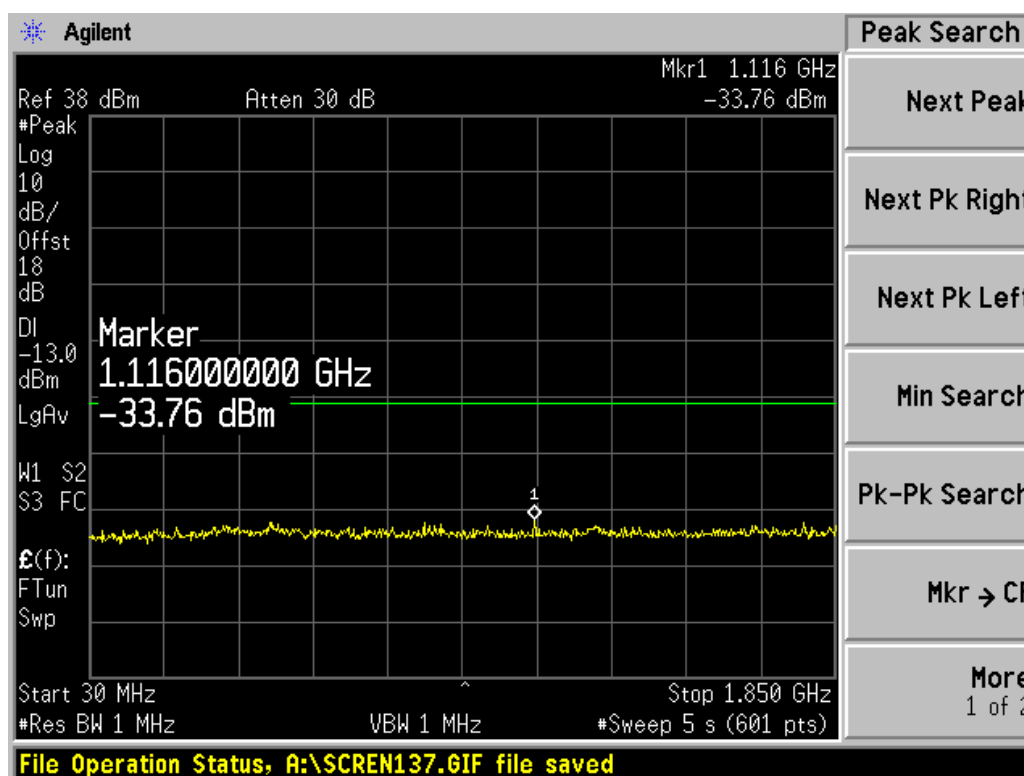

Channel 661, 30MHz~1850MHz

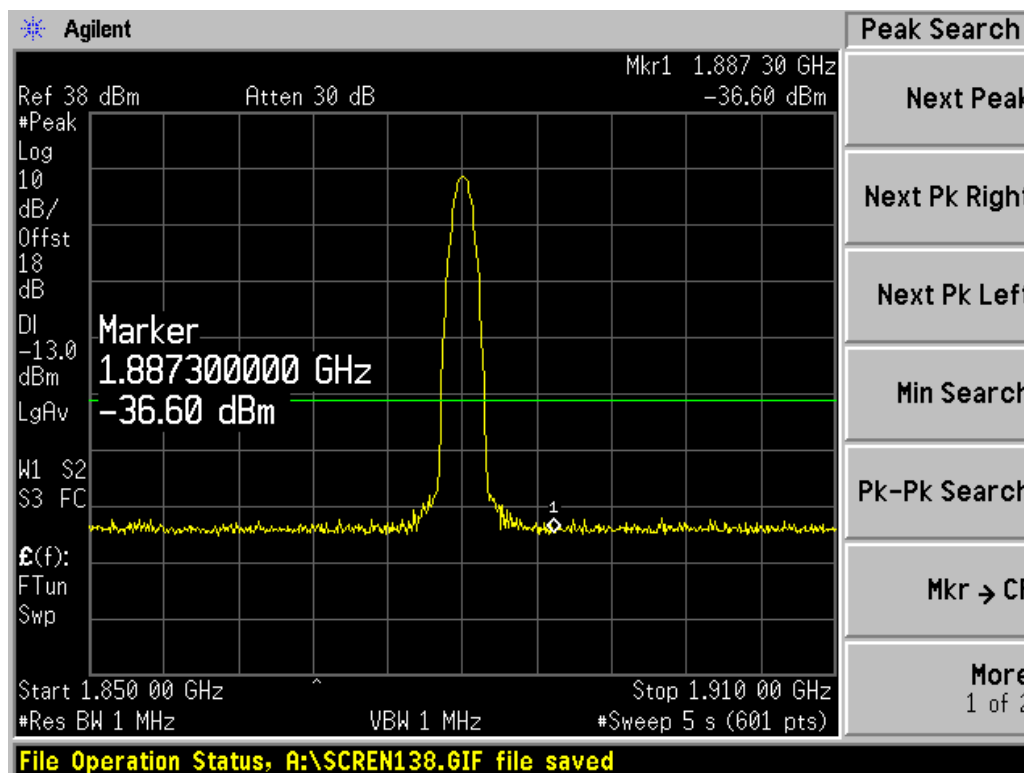

Channel 661, 1850MHz~1910MHz

Note: The signal beyond the limit is carrier.

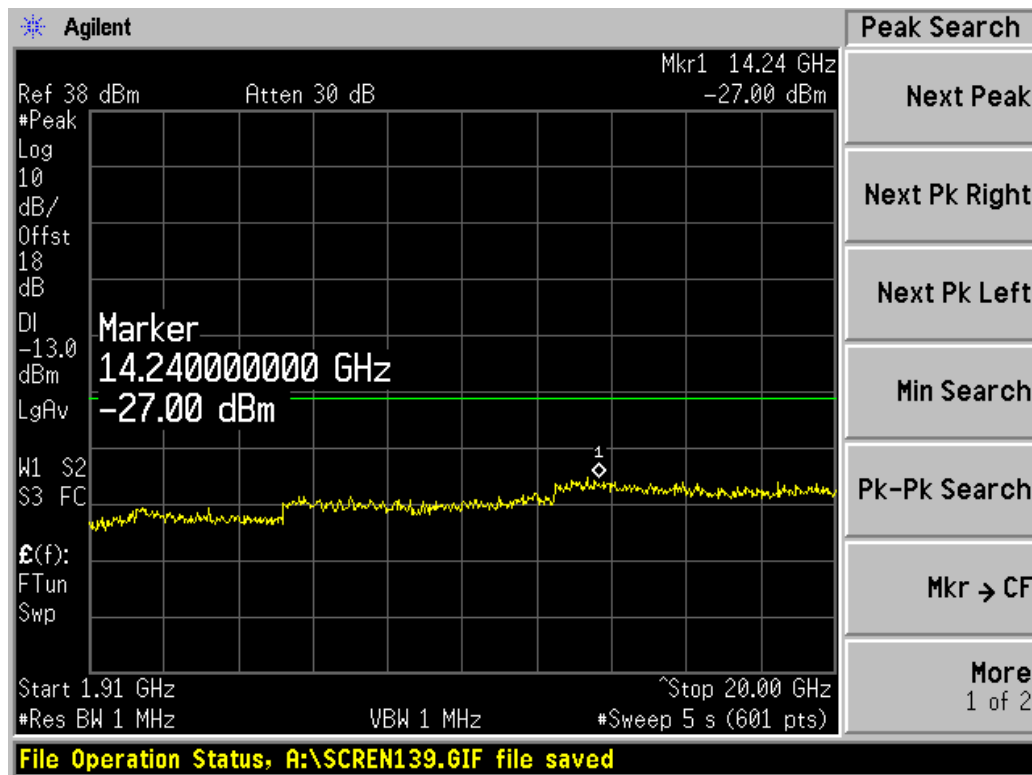

Channel 661, 1910MHz ~20GHz

### 2.2.2.5 Band Edges Compliance- FCC Part2.1051/24.238

Ambient condition:

Temperature	Relative humidity	Pressure
22°C	45%	101.2kPa

Test Setup:

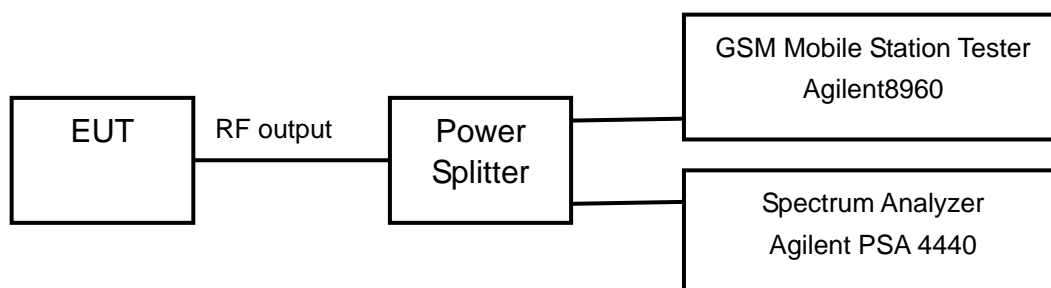

Test procedure:

After a radio link has been established between EUT and Tester, the output power of the cell signal of the testing equipment will be decreased until the output power of the EUT reach a maximum value. The measurement is carried out using a spectrum analyzer. The peak detector is used and RBW is set to 3KHz on spectrum analyzer.

The measurement will be conducted at two channels No512 and No810 (Bottom and top channels of PCS1900 band)

Limits	≤ -13dBm
--------	----------

Test result:

Refer to the following figures.

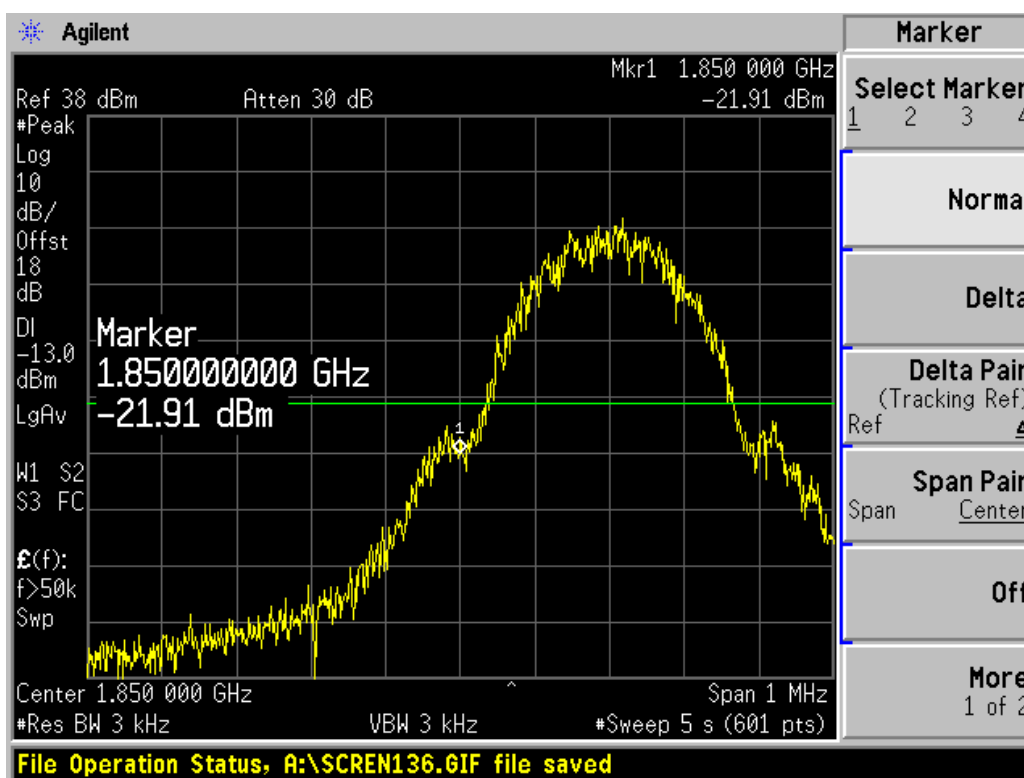

Channel 512

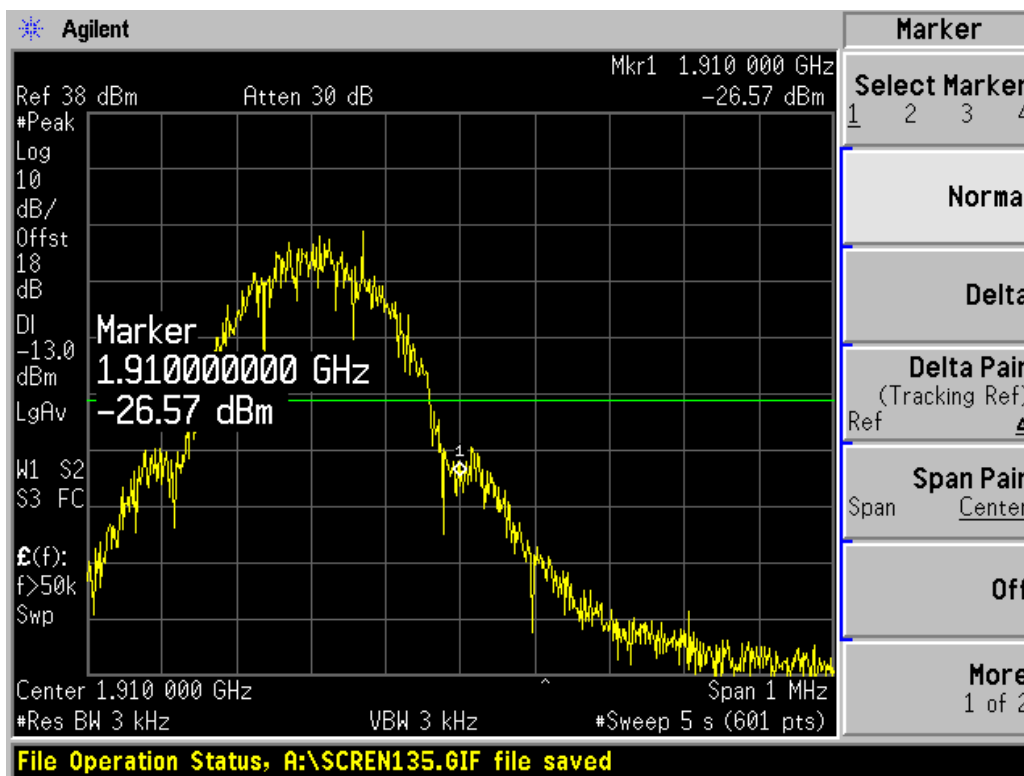

Channel 810

### 2.2.2.6 Frequency Stability-FCC Part2.1055/Part24.235

Ambient condition:

Temperature	Relative humidity	Pressure
22°C	45%	101.2kPa

Test setup:

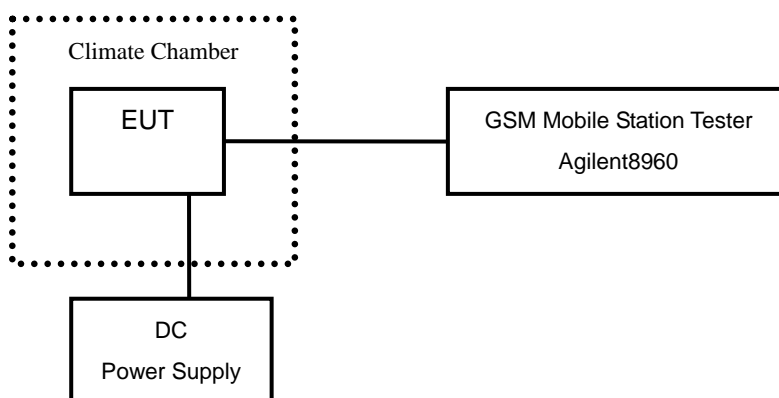

Test Procedure:

A radio link shall be established between EUT and Tester. The tester will sample the transmitter RF output signal and measure its frequency. The temperature inside the climate chamber is varied from -30 to +50° C in 10° C step size, and also the DC power supply voltage to the EUT is varied from 3.55 to 4.2 V.

Limits: No specific frequency stability requirements in part 2.1055 and part 24.235

Test Result:

Temperature(° C)	Test Result (Hz)		
	Channel 512	Channel 661	Channel 810
-30	---	0.026	---
-20	---	0.019	---
-10	---	0.013	---
0	---	0.007	---
+10	---	0.004	---
+20	---	0.007	---
+30	---	0.012	---
+40	---	0.014	---
+50	---	0.012	---

Voltage (V)	Test Result (Hz)		
	Channel 512	Channel 661	Channel 810
3.55	---	0.010	---
4.2	---	0.017	---

### 2.2.2.7 Radiated Spurious Emissions-FCC Part2.1053/24.238

Ambient condition

Temperature	Relative humidity	Pressure
22°C	45%	101.2kPa

Test Setup:

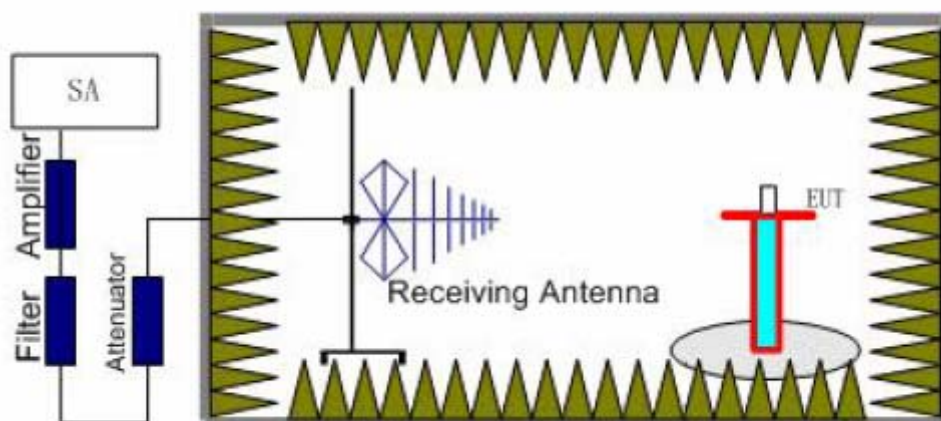

Step 1

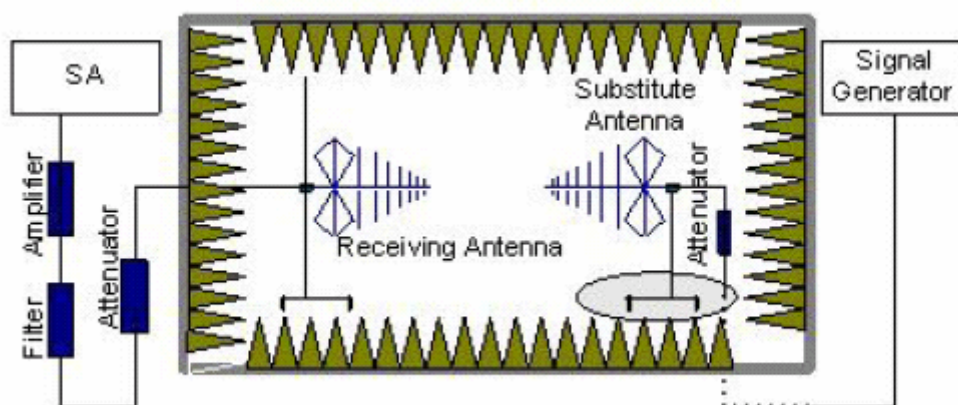

Step 2

Test procedure:

Step 1:

The measurement is carried out in the fully anechoic chamber. EUT was placed on a 2.4 meter high non-conductive table at a 3 meter test distance from the test receive antenna. A receiving antenna was placed on the antenna mast 3 meters from the EUT. The height of receiving antenna is 2.4m and varies in certain range to find the maximum power value. A radio link shall be

established between EUT and Tester. The output power of the cell signal of the tester will be decreased until the output power of the EUT reach a maximum value. The measurement is carried out using a spectrum analyzer or receiver. The spectrum analyzer scans from 30MHz to 20GHz (higher than the 10<sup>th</sup> harmonic of the carrier). The peak detector is used and RBW is set to 1MHz on spectrum analyzer. Then the antenna height and turn table rotation is adjusted till the maximum power value is founded on spectrum analyzer or receiver. A notch filter is necessary in the band near to the carrier frequency. A high pass filter is needed to avoid the distortion of the testing equipment in the band above the carrier frequency.

Step 2:

A log-periodic antenna or double-ridged waveguide horn antenna shall be substituted in place of the EUT. The log-periodic antenna will be driven by a signal generator and the level will be adjusted till the same power value on the spectrum analyzer or receiver. The level of the spurious emissions can be calculated through the level of the signal generator, cable loss, the gain of the substitution antenna and the reading of the spectrum analyzer or receiver.

Calculation procedure:

The data of cable loss, antenna gain and air loss has been calibrated in full testing frequency range before the testing.

The power of the Radiated Spurious Emissions is calculated by adding the cable loss, antenna gain and air loss. The basic equation with a sample calculation is as followed:

$$P = P_R + L_C + L_A - G$$

Where

P: Power of the Radiated Spurious Emissions (dBm)

P<sub>R</sub>: reading of the receiver (dBm)

L<sub>C</sub>: Cable Lose (dB)

L<sub>A</sub>: Air loss (dB)

G: Antenna Gain (dBi)

Assumed the reading of the receiver is -60dBm. A cable lose of 10dB, an air lose of 30dB and an antenna gain of 11dBi are added.

$$P = P_R + L_C + L_A - G = -60 + 10 + 30 - 11 = -31 \text{ dBm}$$

The measurement will be conducted at one channels No661 (middle channels of PCS1900 band)

Limits	≤ -13dBm
--------	----------

Test result:

---



Refer to the following figures.

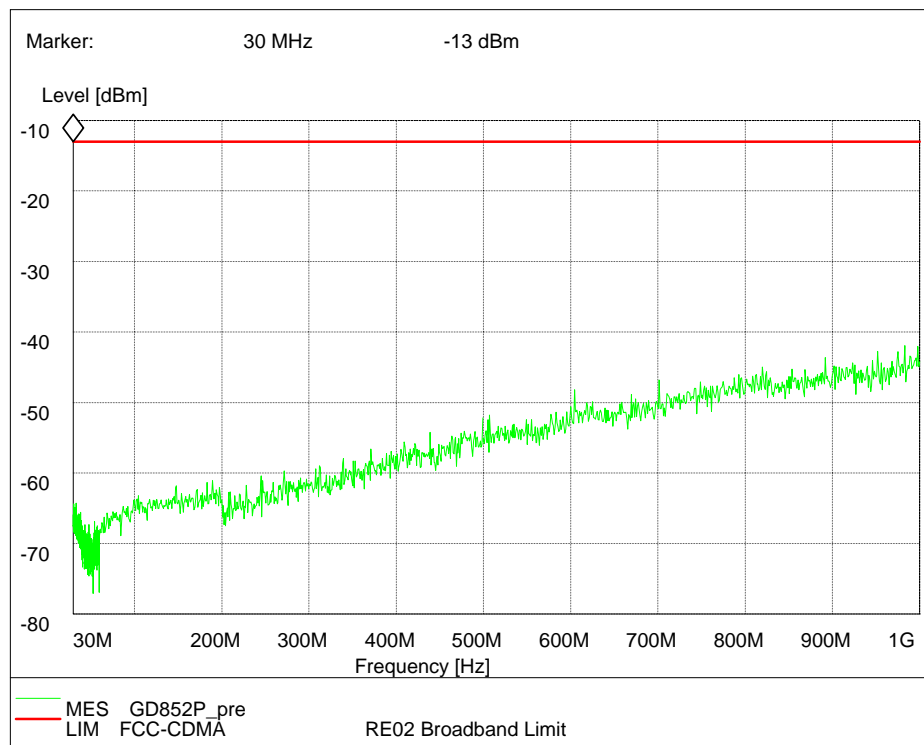

Channel 661, 30MHz~1GHz (Traffic Mode)

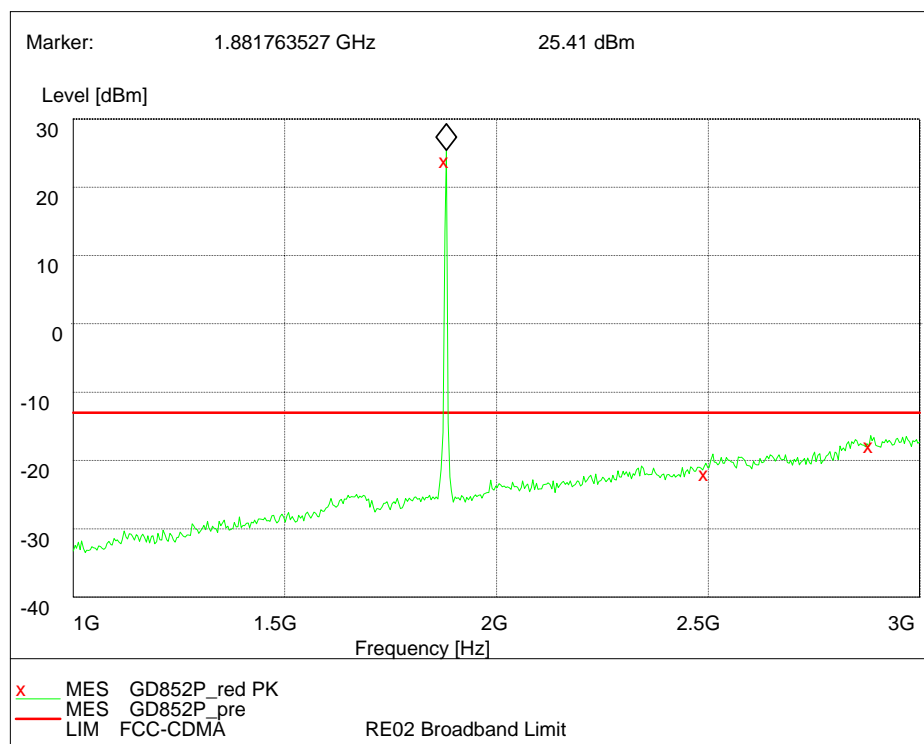

Channel 661, 1GHz~3GHz(Traffic Mode)

Note: The signal beyond the limit is carrier.

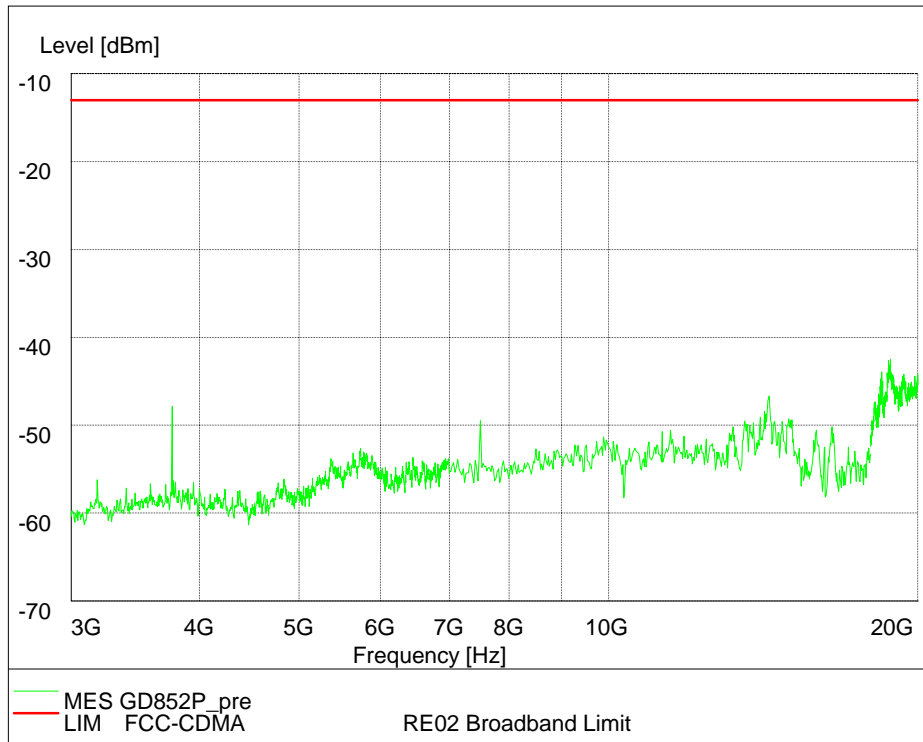

Channel 661, 3GHz~20GHz(Traffic Mode)

### 2.2.2.8 Conducted Emissions-FCC Part15.107

Ambient condition:

Temperature	Relative humidity	Pressure
22°C	45%	101.2kPa

Test Setup:

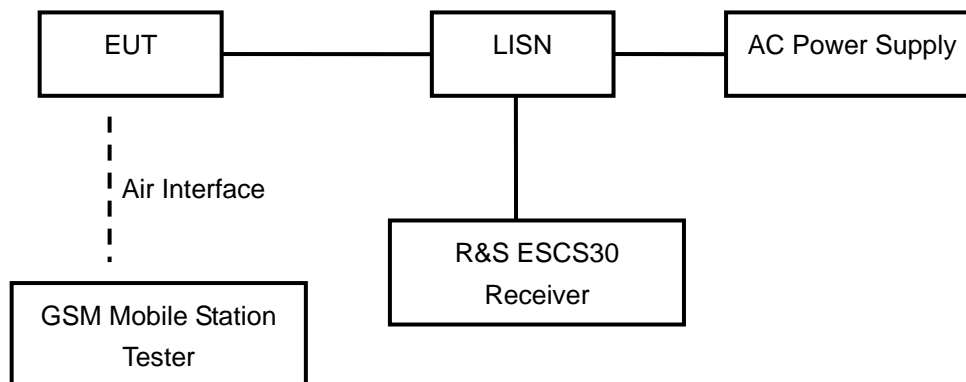

Test Procedure:

The EUT is placed on a non-metallic table 0.8m above the horizontal metal reference ground plane. The EUT is connected to LISN and LISN is connected to the reference ground. All other supplemental devices are connected with EUT through other LISN. The distance between EUT and LISN is 80cm. The measurement should be done both L line and N line. The receiver uses both average detector and quasi-peak detector. A radio link is established between EUT and the tester. The output power of the EUT is controlled by the tester and driven to maximum value.

Frequency of Emission(MHz)	Limits(dB $\mu$ V)	
	Quasi-peak	Average
0.15~0.5	66 to 56*	56 to 46*
0.5~5	56	46
5~30	60	50

Note: \* Decreases with the logarithm of the frequency

Test result:

Refer to the following figures.

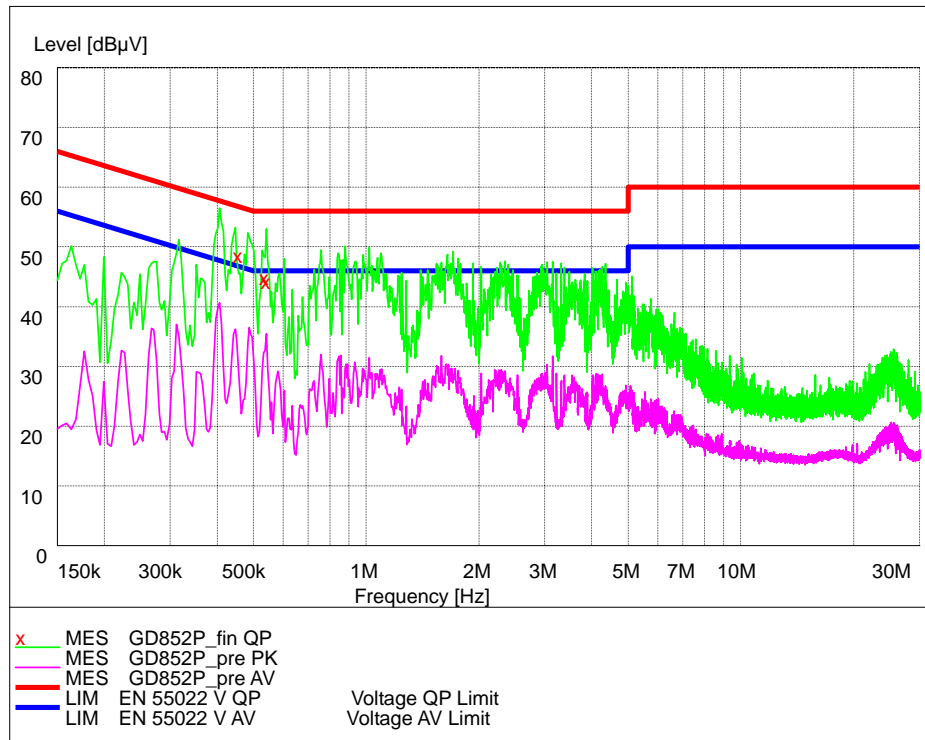

L Line

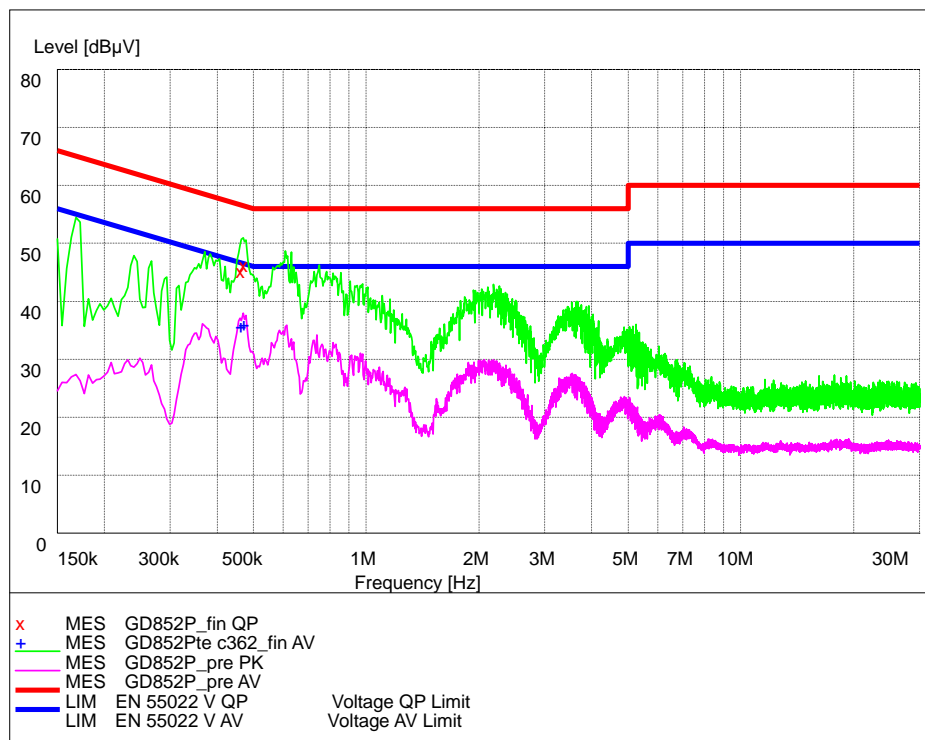

N Line

## 2.2.2.9 Radiated Emissions -FCC Part15.109

Ambient condition:

Temperature	Relative humidity	Pressure
22°C	45%	101.2kPa

Test Setup:

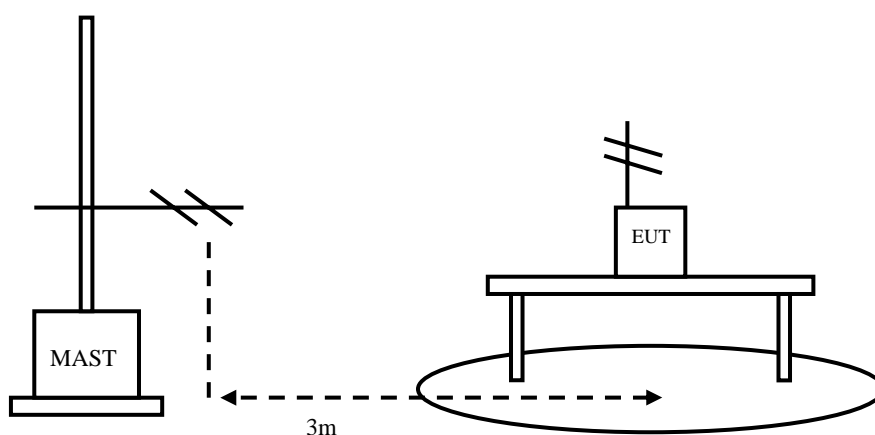

Test Procedure:

The EUT and receive antenna shall be placed to SAC (semi anechoic chamber) upon a non-metallic turn table. The receive antennas shall be moved from 1 to 4 meters. The distance between equipment and receive antenna shall be 3 meters.

Testing shall operate the EUT in typical modes of operation and cable positions in a test set-up which is representative of typical system configurations, as declared by the manufacturer. The output port shall be terminated with 50 ohms.

Then start the test software ES-K1. Sweep the whole frequency band through the range from 30MHz to 1GHz, using receive log period antenna HL562.

During the test, the height of receive antenna shall be moved from 1 to 4 meters, and the antenna shall be performed under horizontal and vertical polarization. The turn table shall be rotated from 0 to 360 degrees for detecting the maximum of radiated spurious signal level. The measurements shall be repeated with orthogonal polarization of the test antenna.

The data of cable loss and antenna factor has been calibrated in full testing frequency range before the testing.

Frequency of Emission(MHz)	Limits	
	Unit( $\mu\text{V}/\text{m}$ )	Average( $\text{dB}\mu\text{V}/\text{m}$ )
30~88	100	40
88~216	150	43.5
216~960	200	46
960~1000	500	54

Test result:  
 Refer to the following figures.

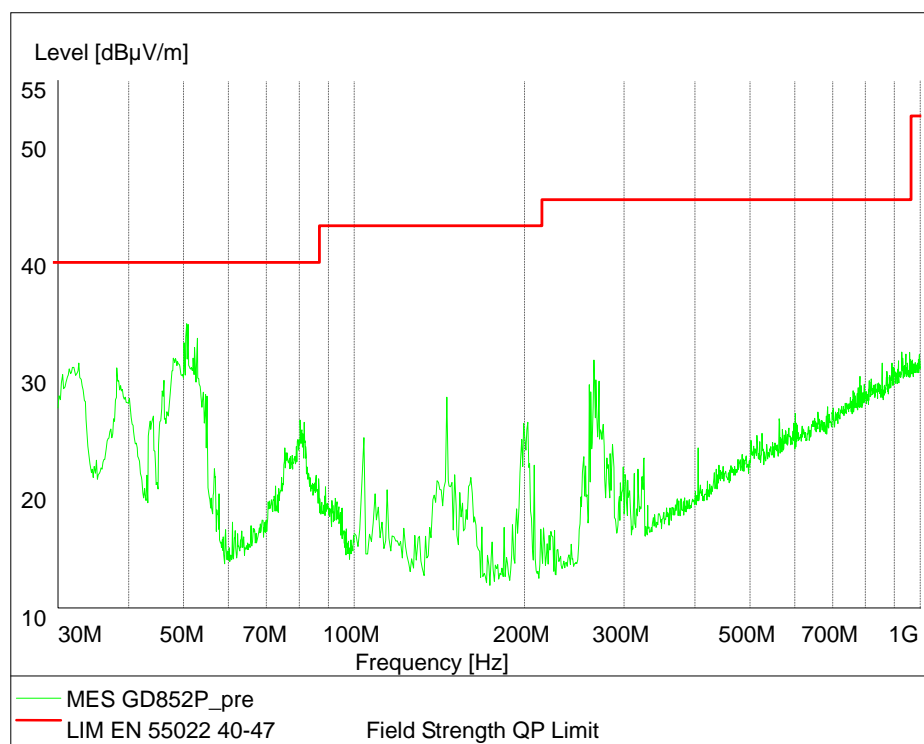

### 2.3. List of test equipments

No.	Name/Model	Manufacturer	S/N	Calibration Date
1	8960 E5515C Mobile Station Tester	Agilent	GB44050904	Mar. 2008
2	PSA E4440A Spectrum Analyzer	Agilent	MY41000183	Mar. 2008
5	66309B DC Power Supply	Agilent	MY43000461	Aug. 2007
6	1506A Power Splitter	Weinschel	MN154	Aug. 2007
7	9.080m×5.255m×3.525m Shielding room	FRANKONIA	-----	Aug. 2007
8	ESI 40 EMI test receiver	R&S	100015	Aug. 2007
9	SMR 20 Signal generator	R&S	100086	Aug. 2007
10	CMU 200 Radio tester	R&S	100313	Aug. 2007
11	12.65m*8.03m*7.50m Fully-Anechoic Chamber	FRANKONIA	-----	Aug. 2007
12	HL562 Ultra log test antenna	R&S	100016	Aug. 2007
13	ESH3-Z2 Pulse limiter	R&S	10002	Aug. 2007
14	ESH3-Z5 Attenuator	R&S	100020	Aug. 2007
15	ESH2Z11 LISN	R&S	50FH-020-10	Aug. 2007
16	CMU 200 Radio tester	R&S	100313	Aug. 2007
17	HF 906 Double-Ridged Waveguide Horn Antenna	R&S	100030	Aug. 2007
18	HF 906 Double-Ridged Waveguide Horn Antenna	R&S	100029	Aug. 2007
19	PS2000 Turn Table	FRANKONIA	-----	Aug. 2007
20	MA260 Antenna Master	FRANKONIA	-----	Aug. 2007
21	SH-241 Climatic Chamber	ESPEC	92000389	Aug. 2007
22	E5515C Mobile Station Tester	Agilent	GB45071696	Aug. 2007
23	ES-K1 EMI test software	R&S	-----	Aug. 2007
24	HL562 Receive antenna	R&S	100167	Aug. 2007

## Appendix

### Appendix1 Test Setup