

CETECOM ICT Services is now

CTC | **advanced**
member of RWTÜV group

TEST REPORT

Test report no.: 1-1238/16-02-10-B



Deutsche
Akkreditierungsstelle
D-PL-12076-01-01

Testing laboratory

CTC advanced GmbH

Untertuerkheimer Strasse 6 – 10
66117 Saarbruecken / Germany
Phone: + 49 681 5 98 - 0
Fax: + 49 681 5 98 - 9075
Internet: <http://www.ctcadvanced.com>
e-mail: mail@ctcadvanced.com

Accredited Testing Laboratory:

The testing laboratory (area of testing) is accredited according to DIN EN ISO/IEC 17025 (2005) by the Deutsche Akkreditierungsstelle GmbH (DAkkS). The accreditation is valid for the scope of testing procedures as stated in the accreditation certificate with the registration number: D-PL-12076-01-01

Applicant

Mitel Deutschland GmbH

Zeughofstr. 1
10997 Berlin / Deutschland
Phone: +49 30 6104-0
Fax: -/-
Contact: Andreas Papke
e-mail: andreas.papke@mitel.com
Phone: +49 43 11 69 65 20

Manufacturer

Mitel Deutschland GmbH

Zeughofstr. 1
10997 Berlin / Deutschland

Test standard/s

47 CFR Part 15	Title 47 of the Code of Federal Regulations; Chapter I; Part 15 - Radio frequency devices
RSS - 247 Issue 1	Digital Transmission Systems (DTSs), Frequency Hopping Systems (FHSs) and Licence - Exempt Local Area Network (LE-LAN) Devices
RSS - Gen Issue 4	Spectrum Management and Telecommunications Radio Standards Specifications - General Requirements and Information for the Certification of Radio Apparatus

For further applied test standards please refer to section 3 of this test report.

Test Item

Kind of test item:	Mitel 600 DECT Phone (3rd Gen)
Model name:	Mitel 632d v2
FCC ID:	UOU6X2DV2
IC:	1884E-6X2DV2
Frequency:	DTS band 2400 MHz to 2483.5 MHz
Technology tested:	Bluetooth® (basic rate)
Antenna:	Integrated PCB antenna
Power supply:	3.7 V DC by Li-Ion battery
Temperature range:	0°C to +40°C



This test report is electronically signed and valid without handwriting signature. For verification of the electronic signatures, the public keys can be requested at the testing laboratory.

Test report authorized:

p.o.

Andreas Luckenbill
Lab Manager
Radio Communications & EMC

Test performed:

p.o.

Marco Bertolino
Lab Manager
Radio Communications & EMC

1 Table of contents

1	Table of contents	2
2	General information	3
2.1	Notes and disclaimer	3
2.2	Application details.....	3
2.3	Test laboratories sub-contracted	3
3	Test standard/s and references	4
4	Test environment.....	5
5	Test item.....	5
5.1	General description.....	5
5.2	Additional information	5
6	Description of the test setup.....	6
6.1	Shielded semi anechoic chamber.....	7
6.2	Shielded fully anechoic chamber	8
6.3	Radiated measurements > 18 GHz.....	9
6.4	AC conducted	10
6.5	Conducted measurements C.BER system.....	11
7	Sequence of testing	12
7.1	Sequence of testing radiated spurious 9 kHz to 30 MHz.....	12
7.2	Sequence of testing radiated spurious 30 MHz to 1 GHz.....	13
7.3	Sequence of testing radiated spurious 1 GHz to 18 GHz	14
7.4	Sequence of testing radiated spurious above 18 GHz	15
8	Measurement uncertainty	16
9	Summary of measurement results	17
10	Additional comments	18
11	Measurement results.....	19
11.1	Antenna gain	19
11.2	Carrier frequency separation.....	20
11.3	Number of hopping channels	22
11.4	Time of occupancy (dwell time)	24
11.5	Spectrum bandwidth of a FHSS system.....	25
11.6	Maximum output power.....	28
11.7	Detailed spurious emissions @ the band edge - conducted	31
11.8	Band edge compliance radiated.....	34
11.9	Spurious emissions conducted	36
11.10	Spurious emissions radiated below 30 MHz.....	41
11.11	Spurious emissions radiated 30 MHz to 1 GHz.....	44
11.12	Spurious emissions radiated above 1 GHz.....	49
11.13	Spurious emissions conducted below 30 MHz (AC conducted).....	59
12	Observations	62
Annex A	Document history	62
Annex B	Further information.....	62
Annex C	Accreditation Certificate	63

2 General information

2.1 Notes and disclaimer

The test results of this test report relate exclusively to the test item specified in this test report. CTC advanced GmbH does not assume responsibility for any conclusions and generalizations drawn from the test results with regard to other specimens or samples of the type of the equipment represented by the test item.

The test report may only be reproduced or published in full. Reproduction or publication of extracts from the report requires the prior written approval of CTC advanced GmbH.

The testing service provided by CTC advanced GmbH has been rendered under the current "General Terms and Conditions for CTC advanced GmbH".

CTC advanced GmbH will not be liable for any loss or damage resulting from false, inaccurate, inappropriate or incomplete product information provided by the customer.

Under no circumstances does the CTC advanced GmbH test report include any endorsement or warranty regarding the functionality, quality or performance of any other product or service provided.

Under no circumstances does the CTC advanced GmbH test report include or imply any product or service warranties from CTC advanced GmbH, including, without limitation, any implied warranties of merchantability, fitness for purpose, or non-infringement, all of which are expressly disclaimed by CTC advanced GmbH.

All rights and remedies regarding vendor's products and services for which CTC advanced GmbH has prepared this test report shall be provided by the party offering such products or services and not by CTC advanced GmbH. In no case this test report can be considered as a Letter of Approval.

This test report is electronically signed and valid without handwritten signature. For verification of the electronic signatures, the public keys can be requested at the testing laboratory.

This test report replaces the test report 1-1238/16-02-10-A and dated 2017-01-04.

2.2 Application details

Date of receipt of order:	2016-10-17
Date of receipt of test item:	2016-10-17
Start of test:	2016-10-17
End of test:	2016-10-20
Person(s) present during the test:	-/-

2.3 Test laboratories sub-contracted

None

3 Test standard/s and references

Test standard	Date	Description
47 CFR Part 15	-/-	Title 47 of the Code of Federal Regulations; Chapter I; Part 15 - Radio frequency devices
RSS - 247 Issue 1	May 2015	Digital Transmission Systems (DTSs), Frequency Hopping Systems (FHSs) and Licence - Exempt Local Area Network (LE-LAN) Devices
RSS - Gen Issue 4	November 2014	Spectrum Management and Telecommunications Radio Standards Specifications - General Requirements and Information for the Certification of Radio Apparatus

Guidance	Version	Description
ANSI C63.4-2014	-/-	American national standard for methods of measurement of radio-noise emissions from low-voltage electrical and electronic equipment in the range of 9 kHz to 40 GHz
ANSI C63.10-2013	-/-	American national standard of procedures for compliance testing of unlicensed wireless devices

4 Test environment

Temperature	: T _{nom} T _{max} T _{min}	22 °C during room temperature tests No tests under extreme conditions required. No tests under extreme conditions required.
Relative humidity content	:	55 %
Barometric pressure	:	1021 hpa
Power supply	: V _{nom} V _{max} V _{min}	3.7 V DC by Li-Ion battery No tests under extreme conditions required. No tests under extreme conditions required.

5 Test item

5.1 General description

Kind of test item	:	Mitel 600 DECT Phone (3rd Gen)
Type identification	:	Mitel 632d v2
HMN	:	-/-
PMN	:	Mitel 632d v2
HVIN	:	Mitel 632d v2
FVIN	:	-/-
S/N serial number	:	Conducted units: IPEI 11041 0081063 1 Radiated units: IPEI 11041 0081047 5
HW hardware status	:	Beta 2
SW software status	:	7.0.SP1
FW firmware status	:	130.70.16
Frequency band	:	DTS band 2400 MHz to 2483.5 MHz (lowest channel 2402 MHz; highest channel 2480 MHz)
Type of radio transmission	:	FHSS
Use of frequency spectrum	:	
Type of modulation	:	GFSK
Number of channels	:	79
Antenna	:	Integrated PCB antenna
Power supply	:	3.7 V DC by Li-Ion battery
Temperature range	:	0°C to 40°C

5.2 Additional information

The content of the following annexes is defined in the QA. It may be that not all of the listed annexes are necessary for this report, thus some values in between may be missing.

Test setup- and EUT-photos are included in test report: 1-1238/16-02-35_AnnexA
 1-1238/16-02-35_AnnexB
 1-1238/16-02-35_AnnexD

6 Description of the test setup

Typically, the calibrations of the test apparatus are commissioned to and performed by an accredited calibration laboratory. The calibration intervals are determined in accordance with the DIN EN ISO/IEC 17025. In addition to the external calibrations, the laboratory executes comparison measurements with other calibrated test systems or effective verifications. Weekly chamber inspections and range calibrations are performed. Where possible, RF generating and signaling equipment as well as measuring receivers and analyzers are connected to an external high-precision 10 MHz reference (GPS-based or rubidium frequency standard).

In order to simplify the identification of the equipment used at some special tests, some items of test equipment and ancillaries can be provided with an identifier or number in the equipment list below (Lab/Item).

Agenda: Kind of Calibration

k	calibration / calibrated	EK	limited calibration
ne	not required (k, ev, izw, zw not required)	zw	cyclical maintenance (external cyclical maintenance)
ev	periodic self verification	izw	internal cyclical maintenance
Ve	long-term stability recognized	g	blocked for accredited testing
vlk!	Attention: extended calibration interval		
NK!	Attention: not calibrated	*)	next calibration ordered / currently in progress

6.1 Shielded semi anechoic chamber

The radiated measurements are performed in vertical and horizontal plane in the frequency range from 9 kHz to 1 GHz in semi-anechoic chambers. The EUT is positioned on a non-conductive support with a height of 0.80 m above a conductive ground plane that covers the whole chamber. The receiving antennas are confirmed with specifications ANSI C63. These antennas can be moved over the height range between 1.0 m and 4.0 m in order to search for maximum field strength emitted from EUT. The measurement distances between EUT and receiving antennas are indicated in the test setups for the various frequency ranges. For each measurement, the EUT is rotated in all three axes until the maximum field strength is received. The wanted and unwanted emissions are received by spectrum analyzers where the detector modes and resolution bandwidths over various frequency ranges are set according to requirement ANSI C63.

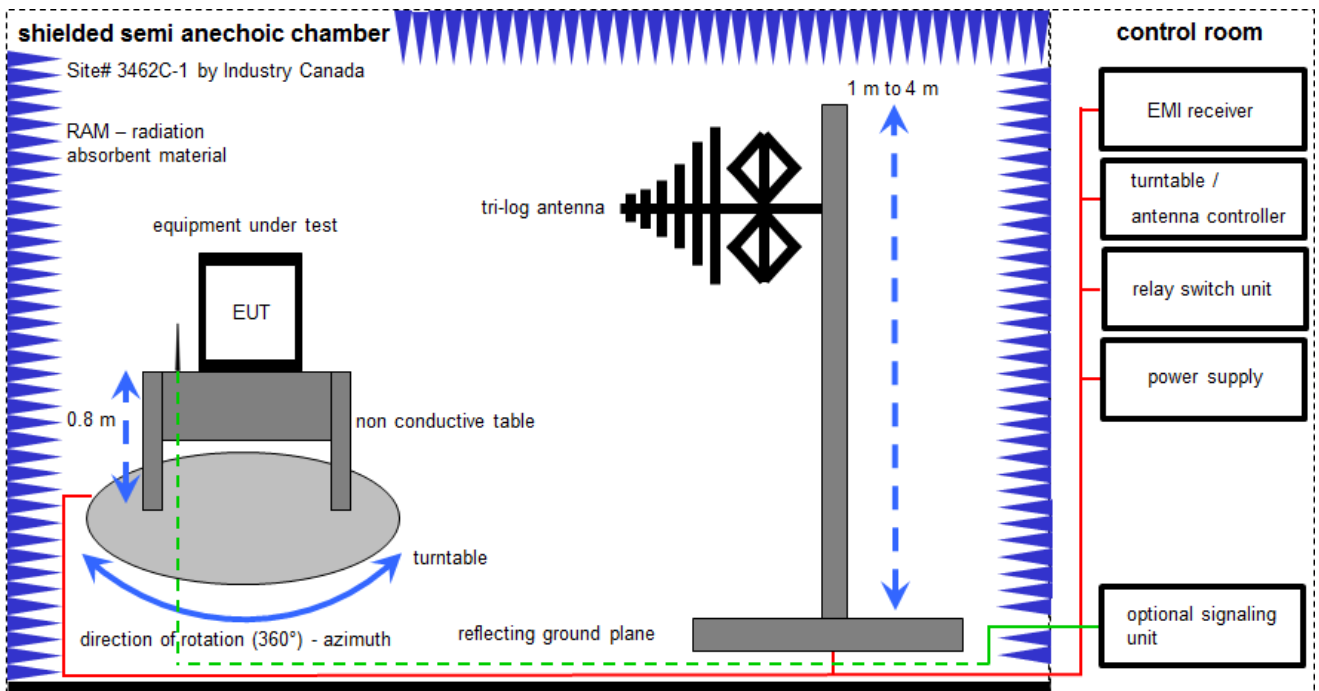

Measurement distance: tri-log antenna 10 meter

$$FS = UR + CL + AF$$

(FS-field strength; UR-voltage at the receiver; CL-loss of the cable; AF-antenna factor)

Example calculation:

$$FS [dB\mu V/m] = 12.35 [dB\mu V/m] + 1.90 [dB] + 16.80 [dB/m] = 31.05 [dB\mu V/m] (35.69 \mu V/m)$$

Equipment table:

No.	Lab / Item	Equipment	Type	Manufacturer	Serial No.	INV. No.	Kind of Calibration	Last Calibration	Next Calibration
1	A	Switch-Unit	3488A	HP	2719A14505	300000368	ev	-/-	-/-
2	A	EMI Test Receiver	ESCI 3	R&S	100083	300003312	k	08.03.2016	08.03.2017
3	A	Antenna Tower	Model 2175	ETS-Lindgren	64762	300003745	izw	-/-	-/-
4	A	Positioning Controller	Model 2090	ETS-Lindgren	64672	300003746	izw	-/-	-/-
5	A	Turntable Interface-Box	Model 105637	ETS-Lindgren	44583	300003747	izw	-/-	-/-
6	A	TRILOG Broadband Test-Antenna 30 MHz - 3 GHz	VULB9163	Schwarzbeck	295	300003787	k	25.04.2016	25.04.2018

6.2 Shielded fully anechoic chamber

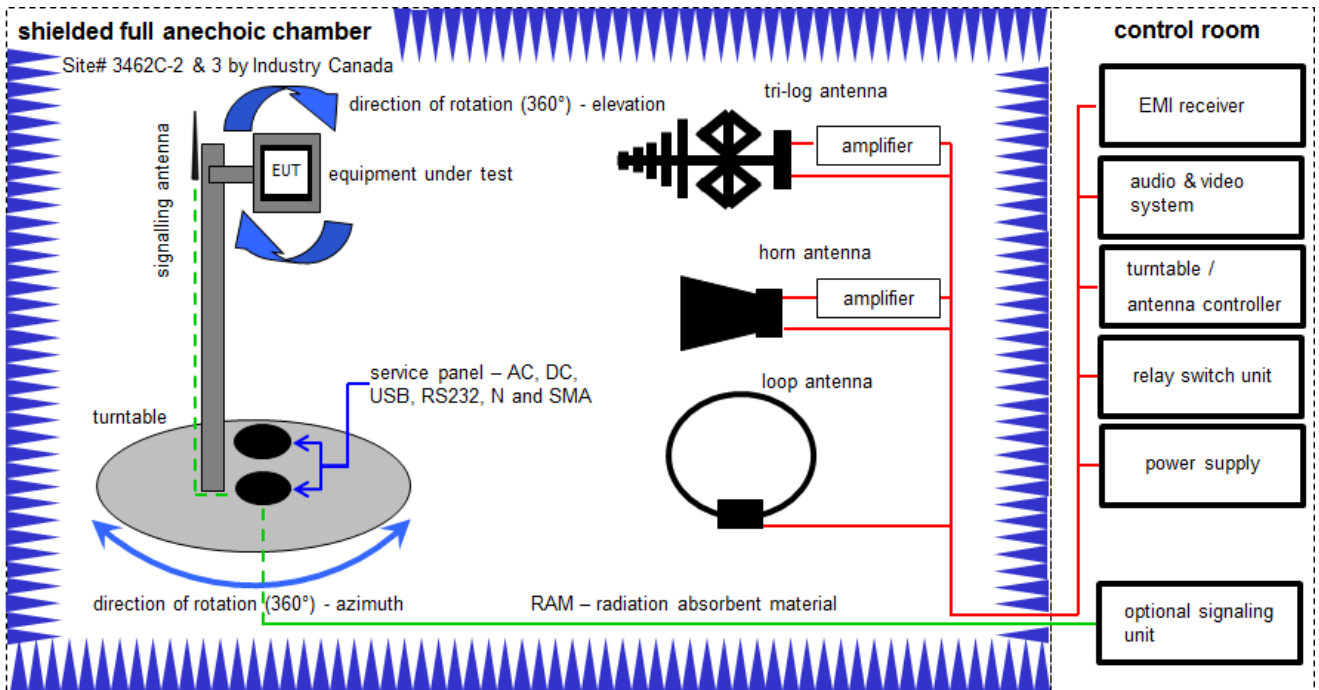

Measurement distance: tri-log antenna and horn antenna 3 meter; loop antenna 3 meter / 1 meter

$$FS = UR + CA + AF$$

(FS-field strength; UR-voltage at the receiver; CA-loss of the signal path; AF-antenna factor)

Example calculation:

$$FS [dB\mu V/m] = 40.0 [dB\mu V/m] + (-35.8) [dB] + 32.9 [dB/m] = 37.1 [dB\mu V/m] (71.61 \mu V/m)$$

$$OP = AV + D - G + CA$$

(OP-radiated output power; AV-analyzer value; D-free field attenuation of measurement distance; G-antenna gain+amplifier gain; CA-loss signal path)

Example calculation:

$$OP [dBm] = -65.0 [dBm] + 50 [dB] - 20 [dBi] + 5 [dB] = -30 [dBm] (1 \mu W)$$

Equipment table:

No.	Lab / Item	Equipment	Type	Manufacturer	Serial No.	INV. No.	Kind of Calibration	Last Calibration	Next Calibration
1	A, B	Double-Ridged Waveguide Horn Antenna 1-18.0GHz	3115	EMCO	8812-3088	300001032	vIKI!	20.05.2015	20.05.2017
2	A, B, C, D	Anechoic chamber	FAC 3/5m	MWB / TDK	87400/02	300000996	ev	-/-	-/-
3	A, B, C, D	Switch / Control Unit	3488A	HP	*	300000199	ne	-/-	-/-
4	C	Active Loop Antenna 10 kHz to 30 MHz	6502	EMCO/2	8905-2342	300000256	k	24.06.2015	24.06.2017
5	A	Amplifier	js42-00502650-28-5a	Parzich GMBH	928979	300003143	ne	-/-	-/-
6	A	Band Reject filter	WRCG2400/2483-2375/2505-50/10SS	Wainwright	11	300003351	ev	-/-	-/-
7	D	TRILOG Broadband Test-Antenna 30 MHz - 3 GHz	VULB9163	Schwarzbeck	371	300003854	vIKI!	29.10.2014	29.10.2017
8	A, B, C	4U RF Switch Platform	L4491A	Agilent Technologies	MY50000037	300004509	ne	-/-	-/-
9	A, B, C	EMI Test Receiver 9kHz-26,5GHz	ESR26	R&S	101376	300005063	vIKI!	13.09.2016	13.03.2018

6.3 Radiated measurements > 18 GHz

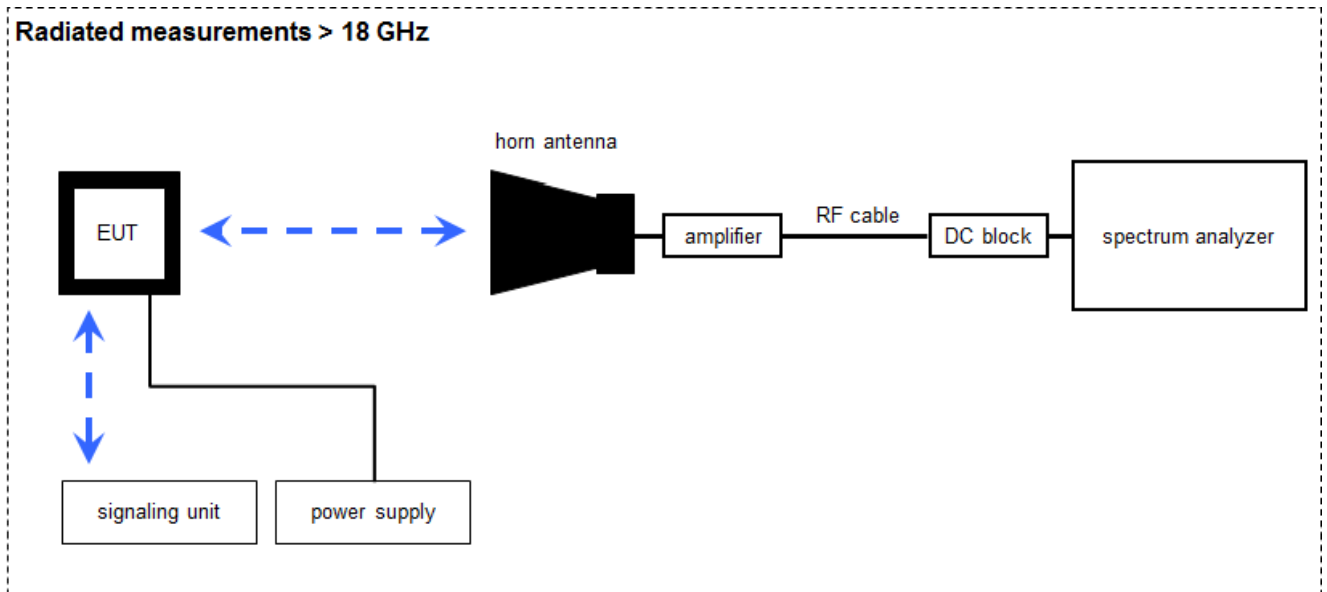

Measurement distance: horn antenna 50 cm

$$FS = U_R + CA + AF$$

(FS-field strength; U_R -voltage at the receiver; CA-loss signal path & distance correction; AF-antenna factor)

Example calculation:

$$FS [dB\mu V/m] = 40.0 [dB\mu V/m] + (-60.1) [dB] + 36.74 [dB/m] = 16.64 [dB\mu V/m] (6.79 \mu V/m)$$

Equipment table:

No.	Lab / Item	Equipment	Type	Manufacturer	Serial No.	INV. No.	Kind of Calibration	Last Calibration	Next Calibration
1	A	Std. Gain Horn Antenna 18.0 to 26.5 GHz	638	Narda	-/-	300000486	k	10.09.2015	10.09.2017
2	A	Signal Analyzer 40 GHz	FSV40	R&S	101042	300004517	k	21.01.2016	21.01.2017
3	A	Amplifier 2-40 GHz	JS32-02004000-57-5P	MITEQ	1777200	300004541	ev	-/-	-/-
4	A	RF-Cable	ST18/SMAm/SMAm/48	Huber & Suhner	Batch no. 600918	400001182	ev	-/-	-/-
5	A	RF-Cable	ST18/SMAm/SMm/48	Huber & Suhner	Batch no. 127377	400001183	ev	-/-	-/-
6	A	DC-Blocker 0.1-40 GHz	8141A	Inmet	Batch no. 127377	400001185	ev	-/-	-/-

6.4 AC conducted

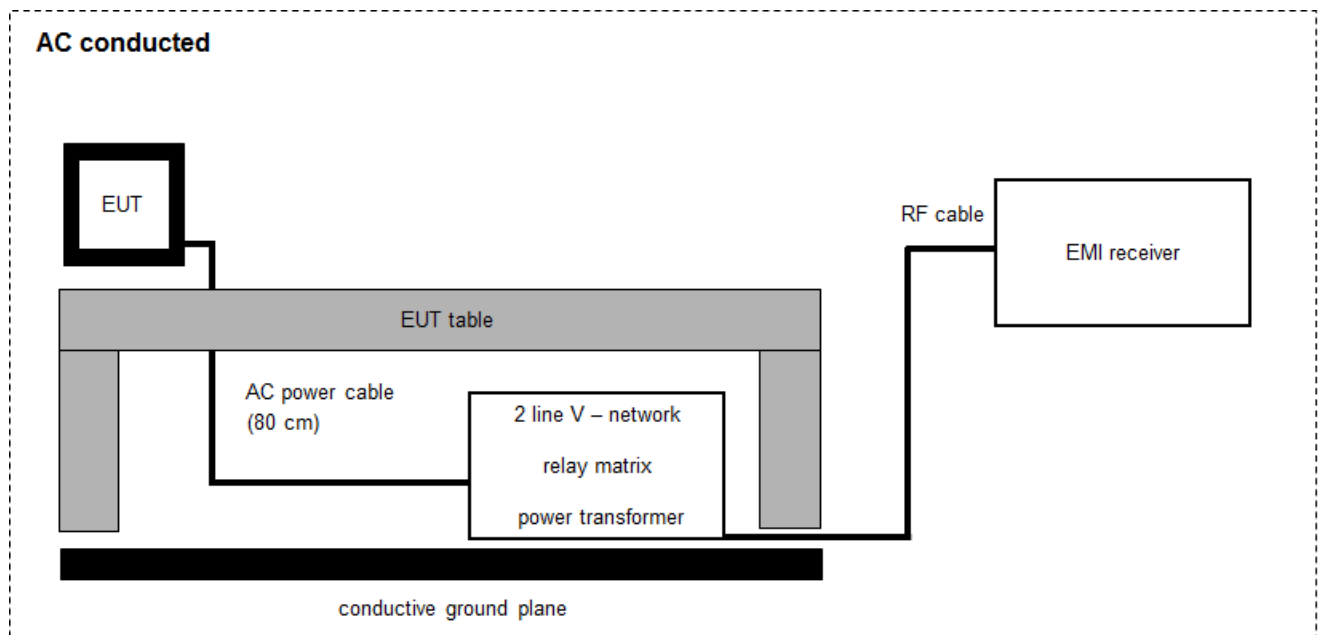

$$FS = UR + CF + VC$$

(FS-field strength; UR-voltage at the receiver; CR-loss of the cable and filter; VC-correction factor of the ISN)

Example calculation:

$$FS [dB\mu V/m] = 37.62 [dB\mu V/m] + 9.90 [dB] + 0.23 [dB] = 47.75 [dB\mu V/m] (244.06 \mu V/m)$$

Equipment table:

No.	Lab / Item	Equipment	Type	Manufacturer	Serial No.	INV. No.	Kind of Calibration	Last Calibration	Next Calibration
1	A	Two-line V-Network (LISN) 9 kHz to 30 MHz	ESH3-Z5	R&S	893045/004	300000584	k	02.02.2016	02.02.2017
2	A	RF-Filter-section	85420E	HP	3427A00162	300002214	k	27.11.2006	-/-
3	A	Power Supply	NGSM 32/10	R&S	3939	400000192	vIKI!	22.01.2015	22.01.2017
4	A	MXE EMI Receiver 20 Hz to 26,5 GHz	N9038A	Agilent Technologies	MY51210197	300004405	k	16.08.2016	16.08.2017
5	A	AC-Spannungsquelle variabel	MV2616-V	EM-Test	0397-12	300003259	k	11.12.2015	11.12.2017

6.5 Conducted measurements C.BER system

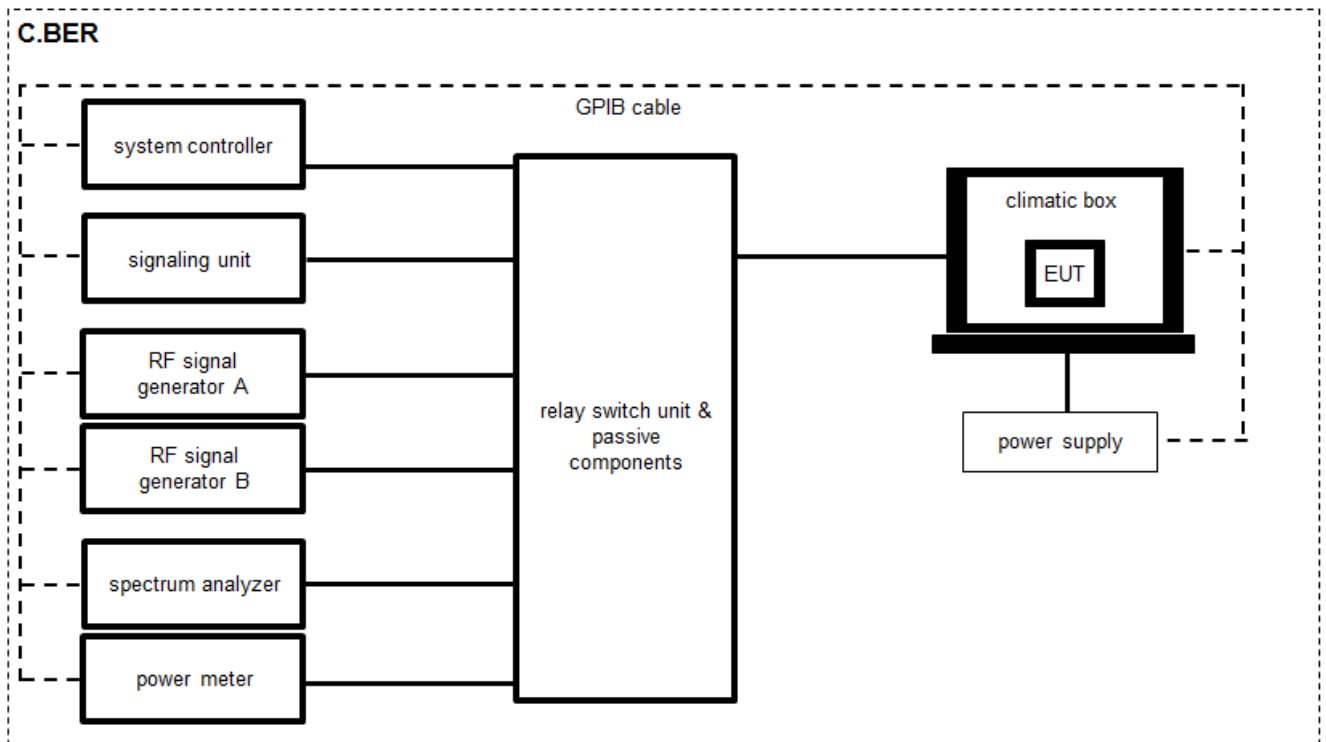

OP = AV + CA
 (OP-output power; AV-analyzer value; CA-loss signal path)

Example calculation:

OP [dBm] = 6.0 [dBm] + 11.7 [dB] = 17.7 [dBm] (58.88 mW)

Equipment table:

No.	Lab / Item	Equipment	Type	Manufacturer	Serial No.	INV. No.	Kind of Calibration	Last Calibration	Next Calibration
1	A	Switch / Control Unit	3488A	HP		300000929	ne	-/-	-/-
2	A	CBT (Bluetooth Tester + EDR Signalling)	CBT 1153.9000K35	R&S	100185	300003416	vKI!	28.01.2015	28.01.2017
3	A	USB/GPIB interface	82357B	Agilent Technologies	MY52103346	300004390	ne	-/-	-/-
4	A	Signal Analyzer 30GHz	FSV30	R&S	103170	300004855	k	25.01.2016	25.01.2017
5	A	USB-GPIB-Interface	82357B	Agilent Technologies	103170	300004852	ne	-/-	-/-
6	A	Power Sensor	NRP-Z81	R&S	100010	300003780	k	25.01.2016	25.01.2017
7	A	Directional Coupler	101020010	Krytar	70215	300002840	ev	-/-	-/-
8	A	DC-Blocker	8143	Inmet Corp.	none	300002842	ne	-/-	-/-
9	A	Powersplitter	6005-3	Inmet Corp.	none	300002841	ev	-/-	-/-
10	A	Messplatzrechner	Tecline	F+W	none	300003580	ne	-/-	-/-
11	A	RF-Cable	ST18/SMAm/SMAm/72	Huber & Suhner	Batch no. 605505	400001187	ev	-/-	-/-
12	A	RF-Cable	Sucoflex 104	Huber & Suhner	147636/4	400001188	ev	-/-	-/-
13	A	RF-Cable	ST18/SMAm/SMAm/48	Huber & Suhner	Batch no. 699866	400001189	ev	-/-	-/-
14	A	RF-Cable	ST18/SMAm/SMAm/48	Huber & Suhner	Batch no. 14844	400001190	ev	-/-	-/-

7 Sequence of testing

7.1 Sequence of testing radiated spurious 9 kHz to 30 MHz

Setup

- The equipment is set up to simulate normal operation mode as described in the user manual or defined by the manufacturer.
- If the EUT is a tabletop system, a 2-axis positioner with 1.5 m height is used.
- If the EUT is a floor standing device, it is placed directly on the turn table.
- Auxiliary equipment and cables are positioned to simulate normal operation conditions as described in ANSI C 63.4.
- The AC power port of the EUT (if available) is connected to a power outlet below the turntable.
- Measurement distance is 3 m (see ANSI C 63.4) – see test details.
- EUT is set into operation.

Premeasurement

- The turntable rotates from 0° to 315° using 45° steps.
- The antenna height is 1.5 m.
- At each turntable position the analyzer sweeps with positive-peak detector to find the maximum of all emissions.

Final measurement

- Identified emissions during the premeasurement are maximized by the software by rotating the turntable from 0° to 360°. In case of the 2-axis positioner is used the elevation axis is also rotated from 0° to 360°.
- The final measurement is done in the position (turntable and elevation) causing the highest emissions with quasi-peak (as described in ANSI C 63.4).
- Final levels, frequency, measuring time, bandwidth, turntable position, correction factor, margin to the limit and limit will be recorded. A plot with the graph of the premeasurement and the limit is stored.

7.2 Sequence of testing radiated spurious 30 MHz to 1 GHz

Setup

- The equipment is set up to simulate normal operation mode as described in the user manual or defined by the manufacturer.
- If the EUT is a tabletop system, a table with 0.8 m height is used, which is placed on the ground plane.
- If the EUT is a floor standing device, it is placed on the ground plane with insulation between both.
- Auxiliary equipment and cables are positioned to simulate normal operation conditions as described in ANSI C 63.4.
- The AC power port of the EUT (if available) is connected to a power outlet below the turntable.
- Measurement distance is 10 m or 3 m (see ANSI C 63.4) – see test details.
- EUT is set into operation.

Premeasurement

- The turntable rotates from 0° to 315° using 45° steps.
- The antenna is polarized vertical and horizontal.
- The antenna height changes from 1 m to 3 m.
- At each turntable position, antenna polarization and height the analyzer sweeps three times in peak to find the maximum of all emissions.

Final measurement

- The final measurement is performed for at least six highest peaks according to the requirements of the ANSI C63.4.
- Based on antenna and turntable positions at which the peak values are measured the software maximize the peaks by changing turntable position $\pm 45^\circ$ and antenna height between 1 and 4 m.
- The final measurement is done with quasi-peak detector (as described in ANSI C 63.4).
- Final levels, frequency, measuring time, bandwidth, antenna height, antenna polarization, turntable angle, correction factor, margin to the limit and limit are recorded. A plot with the graph of the premeasurement with marked maximum final results and the limit is stored.

7.3 Sequence of testing radiated spurious 1 GHz to 18 GHz

Setup

- The equipment is set up to simulate normal operation mode as described in the user manual or defined by the manufacturer.
- If the EUT is a tabletop system, a 2-axis positioner with 1.5 m height is used.
- If the EUT is a floor standing device, it is placed directly on the turn table.
- Auxiliary equipment and cables are positioned to simulate normal operation conditions as described in ANSI C 63.4.
- The AC power port of the EUT (if available) is connected to a power outlet below the turntable.
- Measurement distance is 3 m (see ANSI C 63.4) – see test details.
- EUT is set into operation.

Premeasurement

- The turntable rotates from 0° to 315° using 45° steps.
- The antenna is polarized vertical and horizontal.
- The antenna height is 1.5 m.
- At each turntable position and antenna polarization the analyzer sweeps with positive peak detector to find the maximum of all emissions.

Final measurement

- The final measurement is performed for at least six highest peaks according to the requirements of the ANSI C63.4.
- Based on antenna and turntable positions at which the peak values are measured the software maximizes the peaks by rotating the turntable from 0° to 360°. This measurement is repeated for different EUT-table positions (0° to 150° in 30°-steps) and for both antenna polarizations.
- The final measurement is done in the position (turntable, EUT-table and antenna polarization) causing the highest emissions with Peak and RMS detector (as described in ANSI C 63.4).
- Final levels, frequency, measuring time, bandwidth, turntable position, EUT-table position, antenna polarization, correction factor, margin to the limit and limit are recorded. A plot with the graph of the premeasurement with marked maximum final results and the limit is stored.

7.4 Sequence of testing radiated spurious above 18 GHz

Setup

- The equipment is set up to simulate normal operation mode as described in the user manual or defined by the manufacturer.
- Auxiliary equipment and cables are positioned to simulate normal operation conditions as described in ANSI C 63.4.
- The AC power port of the EUT (if available) is connected to a power outlet.
- The measurement distance is as appropriate (e.g. 0.5 m).
- The EUT is set into operation.

Premeasurement

- The test antenna is handheld and moved carefully over the EUT to cover the EUT's whole sphere and different polarizations of the antenna.

Final measurement

- The final measurement is performed at the position and antenna orientation causing the highest emissions with Peak and RMS detector (as described in ANSI C 63.4).
- Final levels, frequency, measuring time, bandwidth, correction factor, margin to the limit and limit are recorded. A plot with the graph of the premeasurement and the limit is stored.

8 Measurement uncertainty

Measurement uncertainty	
Test case	Uncertainty
Antenna gain	± 3 dB
Carrier frequency separation	± 21.5 kHz
Number of hopping channels	-/-
Time of occupancy	According BT Core specification
Spectrum bandwidth	± 21.5 kHz absolute; ± 15.0 kHz relative
Maximum output power	± 1 dB
Detailed conducted spurious emissions @ the band edge	± 1 dB
Band edge compliance radiated	± 3 dB
Spurious emissions conducted	± 3 dB
Spurious emissions radiated below 30 MHz	± 3 dB
Spurious emissions radiated 30 MHz to 1 GHz	± 3 dB
Spurious emissions radiated 1 GHz to 12.75 GHz	± 3.7 dB
Spurious emissions radiated above 12.75 GHz	± 4.5 dB
Spurious emissions conducted below 30 MHz (AC conducted)	± 2.6 dB

9 Summary of measurement results

<input checked="" type="checkbox"/>	No deviations from the technical specifications were ascertained
<input type="checkbox"/>	There were deviations from the technical specifications ascertained
<input type="checkbox"/>	This test report is only a partial test report. The content and verdict of the performed test cases are listed below.

TC Identifier	Description	Verdict	Date	Remark
RF-Testing	CFR Part 15 RSS - 247, Issue 1	See table!	2017-03-22	RF pretest according customer demand!

Test specification clause	Test case	Temperature conditions	Power source voltages	Mode	C	NC	NA	NP	Remark
§15.247(b)(4) RSS - 247 / 5.4 (2)	Antenna gain	Nominal	Nominal	GFSK	<input checked="" type="checkbox"/>	<input type="checkbox"/>	<input type="checkbox"/>	<input type="checkbox"/>	-/-
§15.247(a)(1) RSS - 247 / 5.1 (2)	Carrier frequency separation	Nominal	Nominal	GFSK	<input checked="" type="checkbox"/>	<input type="checkbox"/>	<input type="checkbox"/>	<input type="checkbox"/>	-/-
§15.247(a)(1) RSS - 247 / 5.1 (4)	Number of hopping channels	Nominal	Nominal	GFSK	<input checked="" type="checkbox"/>	<input type="checkbox"/>	<input type="checkbox"/>	<input type="checkbox"/>	-/-
§15.247(a)(1) (iii) RSS - 247 / 5.1 (4)	Time of occupancy (dwell time)	Nominal	Nominal	GFSK	<input checked="" type="checkbox"/>	<input type="checkbox"/>	<input type="checkbox"/>	<input type="checkbox"/>	-/-
§15.247(a)(1) RSS - 247 / 5.1 (1)	Spectrum bandwidth of a FHSS system bandwidth	Nominal	Nominal	GFSK	<input checked="" type="checkbox"/>	<input type="checkbox"/>	<input type="checkbox"/>	<input type="checkbox"/>	-/-
§15.247(b)(1) RSS - 247 / 5.4 (2)	Maximum output power	Nominal	Nominal	GFSK	<input checked="" type="checkbox"/>	<input type="checkbox"/>	<input type="checkbox"/>	<input type="checkbox"/>	-/-
§15.247(d) RSS - 247 / 5.5	Detailed spurious emissions @ the band edge - conducted	Nominal	Nominal	GFSK	<input checked="" type="checkbox"/>	<input type="checkbox"/>	<input type="checkbox"/>	<input type="checkbox"/>	-/-
§15.205 RSS - 247 / 5.5 RSS - Gen	Band edge compliance radiated	Nominal	Nominal	GFSK	<input checked="" type="checkbox"/>	<input type="checkbox"/>	<input type="checkbox"/>	<input type="checkbox"/>	-/-
§15.247(d) RSS - 247 / 5.5	Spurious emissions conducted	Nominal	Nominal	GFSK	<input checked="" type="checkbox"/>	<input type="checkbox"/>	<input type="checkbox"/>	<input type="checkbox"/>	-/-
§15.209(a) RSS - Gen	Spurious emissions radiated below 30 MHz	Nominal	Nominal	GFSK	<input checked="" type="checkbox"/>	<input type="checkbox"/>	<input type="checkbox"/>	<input type="checkbox"/>	-/-
§15.247(d) RSS - 247 / 5.5 §15.109 RSS - Gen	Spurious emissions radiated 30 MHz to 1 GHz	Nominal	Nominal	GFSK RX mode	<input checked="" type="checkbox"/>	<input type="checkbox"/>	<input type="checkbox"/>	<input type="checkbox"/>	-/-
§15.247(d) RSS - 247 / 5.5 §15.109 RSS - Gen	Spurious emissions radiated above 1 GHz	Nominal	Nominal	GFSK RX mode	<input checked="" type="checkbox"/>	<input type="checkbox"/>	<input type="checkbox"/>	<input type="checkbox"/>	-/-
§15.107(a) §15.207	Conducted emissions below 30 MHz (AC conducted)	Nominal	Nominal	GFSK / RX mode	<input checked="" type="checkbox"/>	<input type="checkbox"/>	<input type="checkbox"/>	<input type="checkbox"/>	-/-

Note: C = Compliant; NC = Not compliant; NA = Not applicable; NP = Not performed

10 Additional comments

The Bluetooth® word mark and logos are owned by the Bluetooth SIG Inc. and any use of such marks by CTC advanced GmbH is under license.

Reference documents: None

Special test descriptions: RF pretests according customer demand!

Configuration descriptions: TX tests: were performed with x-DH5 packets and static PRBS pattern payload.
 RX/Standby tests: BT test mode enabled, scan enabled, TX Idle

Test mode:

- Bluetooth Test mode loop back enabled (EUT is controlled over CBT/CMU)
- Special software is used.
 EUT is transmitting pseudo random data by itself

Antennas and transmit operating modes:

- Operating mode 1 (single antenna)
 - Equipment with 1 antenna,
 - Equipment with 2 diversity antennas operating in switched diversity mode by which at any moment in time only 1 antenna is used,
 - Smart antenna system with 2 or more transmit/receive chains, but operating in a mode where only 1 transmit/receive chain is used)

11 Measurement results

11.1 Antenna gain

Measurement:

The antenna gain of the complete system is calculated by the difference of radiated power in EIRP and the conducted power of the module. For normal Bluetooth® devices, the GFSK modulation is used.

Measurement parameters	
Detector	Peak
Sweep time	Auto
Resolution bandwidth	3 MHz
Video bandwidth	3 MHz
Span	5 MHz
Trace mode	Max hold
Test setup	See sub clause 6.2 D (radiated) See sub clause 6.5 A (conducted)
Measurement uncertainty	See sub clause 8

Limits:

FCC	IC
6 dBi / > 6 dBi output power and power density reduction required	

Results:

T _{nom}	V _{nom}	lowest channel 2402 MHz	middle channel 2441 MHz	highest channel 2480 MHz
Conducted power [dBm] Measured with GFSK modulation		-3.35	-0.75	0.00
Radiated power [dBm] Measured with GFSK modulation		-3.58	-2.16	-3.28
Gain [dBi] Calculated		-0.23	-1.41	-3.28

11.2 Carrier frequency separation

Description:

Measurement of the carrier frequency separation of a hopping system. The carrier frequency separation is constant for all modulation-modes. We use GFSK-modulation to show compliance. EUT in hopping mode.

Measurement parameters	
Detector	Peak
Sweep time	Auto
Resolution bandwidth	100 kHz
Video bandwidth	300 kHz
Span	4 MHz
Trace mode	Max hold
Test setup	See sub clause 6.5 A
Measurement uncertainty	See sub clause 8

Limits:

FCC	IC
Carrier frequency separation	
Minimum 25 kHz or two-thirds of the 20 dB bandwidth of the hopping system whichever is greater.	

Result:

Carrier frequency separation	~ 1 MHz
------------------------------	---------

Plot:

Plot 1: Carrier frequency separation (GFSK modulation)

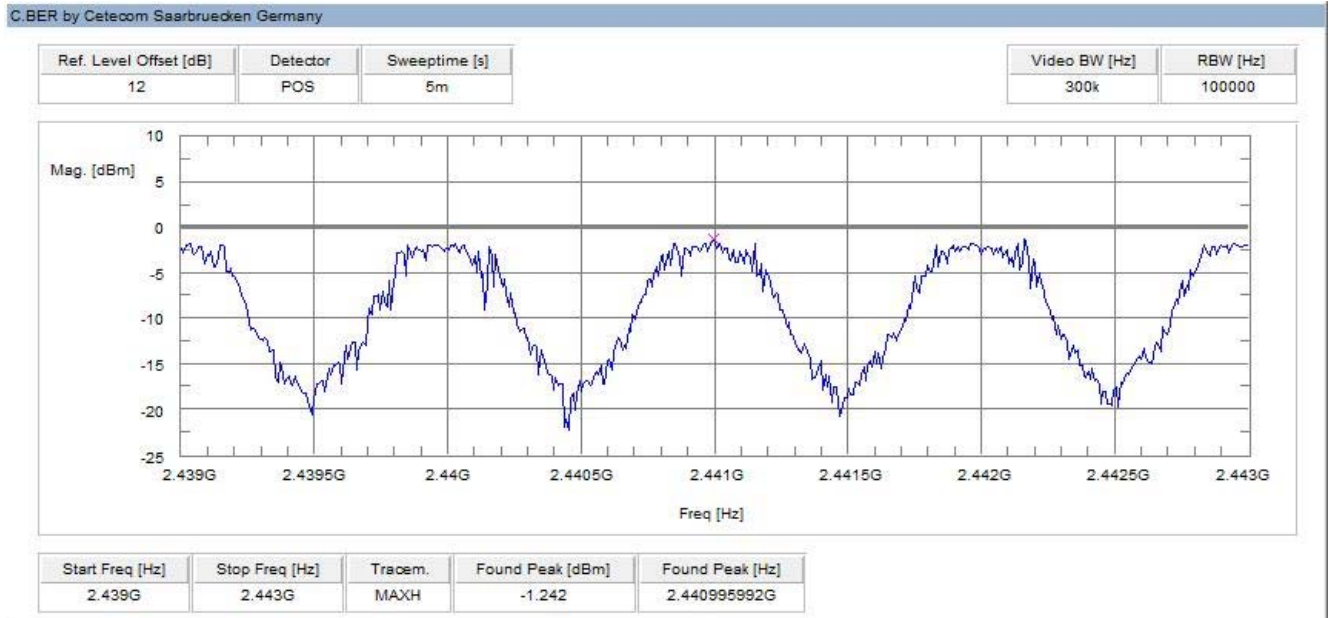

11.3 Number of hopping channels

Description:

Measurement of the total number of used hopping channels. The number of hopping channels is constant for all modulation-modes. We use GFSK-modulation to show compliance. EUT in hopping mode.

Measurement parameters	
Detector	Peak
Sweep time	Auto
Resolution bandwidth	500 kHz
Video bandwidth	500 kHz
Span	Plot 1: 2400 – 2445 MHz Plot 2: 2445 – 2485 MHz
Trace mode	Max hold
Test setup	See sub clause 6.5 A
Measurement uncertainty	See sub clause 8

Limits:

FCC	IC
Number of hopping channels	
At least 15 non overlapping hopping channels	

Result:

Number of hopping channels	79
----------------------------	----

Plots:

Plot 1: Number of hopping channels (GFSK modulation)

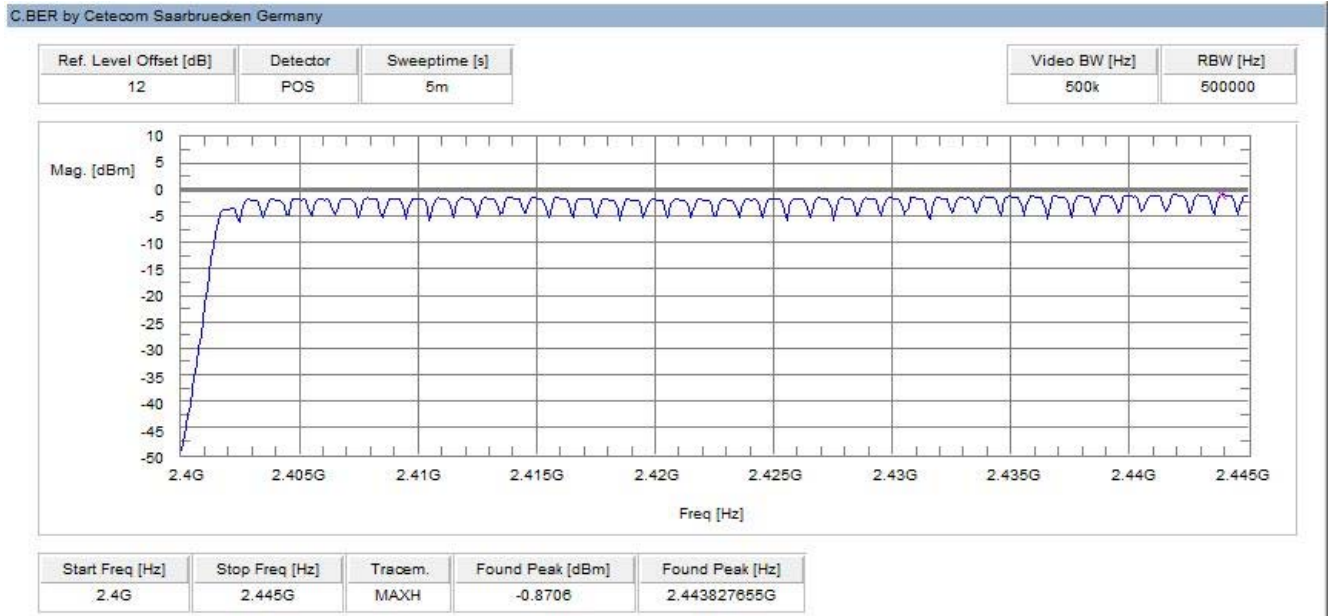

Plot 2: Number of hopping channels (GFSK modulation)

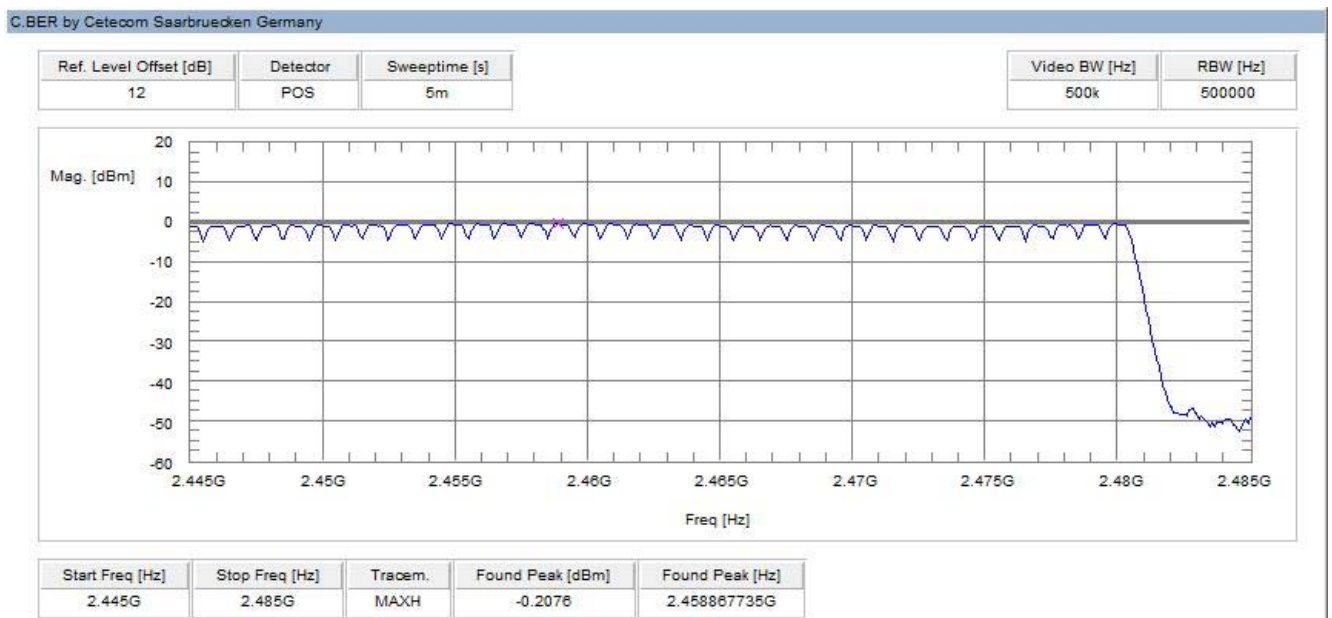

11.4 Time of occupancy (dwell time)

Measurement:

For Bluetooth® devices no measurements mandatory depending on the fixed requirements according to the Bluetooth® Core Specifications!

For Bluetooth® devices:

The channel staying time of 0.4 s within a 31.6 second period in data mode is constant for Bluetooth® devices and independent from the packet type (packet length). The calculation for a 31.6 second period is as follows:

Channel staying time = time slot length * hop rate / number of hopping channels * 31.6 s

Example for a DH1 packet (with a maximum length of one time slot)
 Channel staying time = $625 \mu\text{s} * 1600 * 1/\text{s} / 79 * 31.6 \text{ s} = 0.4 \text{ s}$ (in a 31.6 s period)

For multi-slot packets the hopping is reduced according to the length of the packet.

Example for a DH3 packet (with a maximum length of three time slots)
 Channel staying time = $3 * 625 \mu\text{s} * 1600/3 * 1/\text{s} / 79 * 31.6 \text{ s} = 0.4 \text{ s}$ (in a 31.6 s period)

Example for a DH5 packet (with a maximum length of five time slots)
 Channel staying time = $5 * 625 \mu\text{s} * 1600/5 * 1/\text{s} / 79 * 31.6 \text{ s} = 0.4 \text{ s}$ (in a 31.6 s period)

This is according to the Bluetooth® Core Specification V2.0 & V2.1 & V3.0 & V4.0 (+ critical errata) for all Bluetooth® devices and all modulations.

The following table shows the relations:

Packet Size	Pulse Width [ms] *	Max. number of transmissions per channel in 31.6 sec
DH1	0.366	640
DH3	1.622	214
DH5	2.870	128

* according Bluetooth® specification

Results:

Packet Size	Pulse Width [ms]*	Max. number of transmissions in 31.6 sec	Dwell time [Pulse width * Number of transmissions]
DH1	0.366	640	234.2 ms
DH3	1.622	214	347.1 ms
DH5	2.870	128	367.4 ms

Limits:

FCC	IC
Time of occupancy (dwell time)	
The frequency hopping operation shall have an average time of occupancy on any frequency not exceeding 0.4 seconds within a duration in seconds equal to the number of hopping frequencies multiplied by 0.4.	

11.5 Spectrum bandwidth of a FHSS system

Description:

Measurement of the 20dB bandwidth and 99% bandwidth of the modulated signal. The measurement is performed according to the "Measurement Guidelines" (DA 00-705, March 30, 2000). EUT in single channel mode.

Measurement parameters	
Detector	Peak
Sweep time	Auto
Resolution bandwidth	30 kHz
Video bandwidth	100 kHz
Span	3 MHz
Trace mode	Max hold
Test setup	See sub clause 6.5 A
Measurement uncertainty	See sub clause 8

Limits:

FCC	IC
Spectrum bandwidth of a FHSS system	
GFSK < 1500 kHz	

Results:

Modulation	20 dB bandwidth [kHz]		
	2402 MHz	2441 MHz	2480 MHz
Frequency			
GFSK	954	946	954

Results:

Modulation	99 % bandwidth [kHz]		
	2402 MHz	2441 MHz	2480 MHz
Frequency			
GFSK	889.7	857.7	857.7

Plots:

Plot 1: lowest channel – 2402 MHz, GFSK modulation

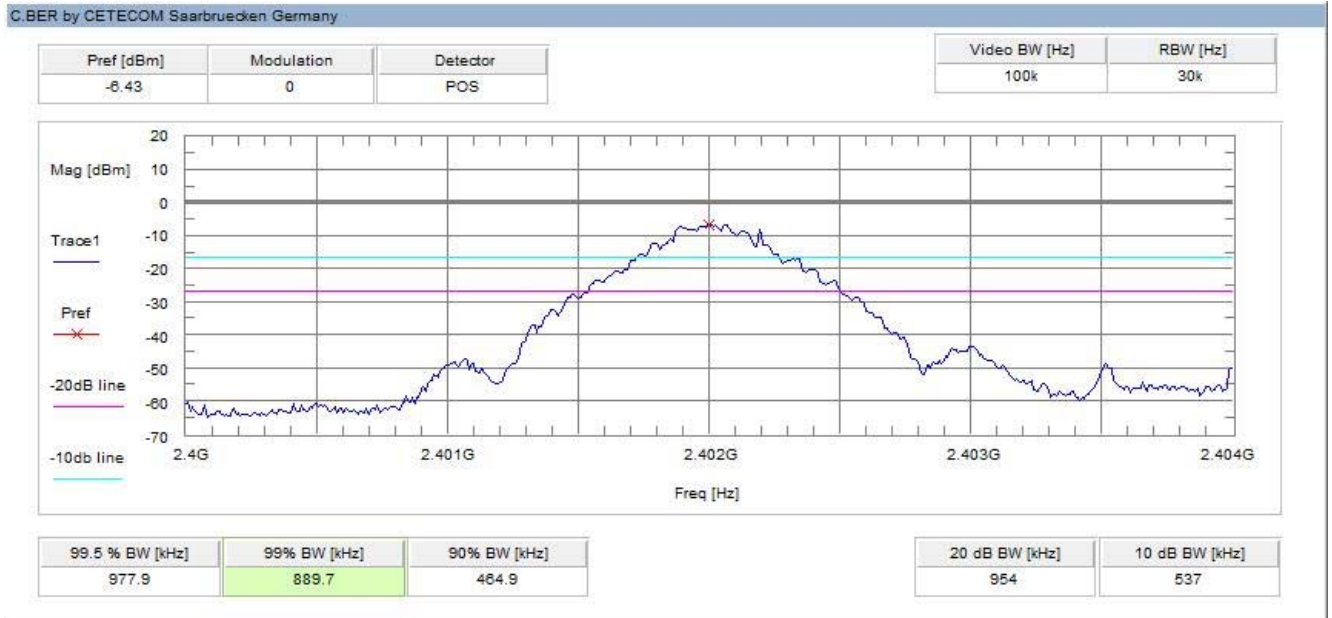

Plot 2: middle channel – 2441 MHz, GFSK modulation

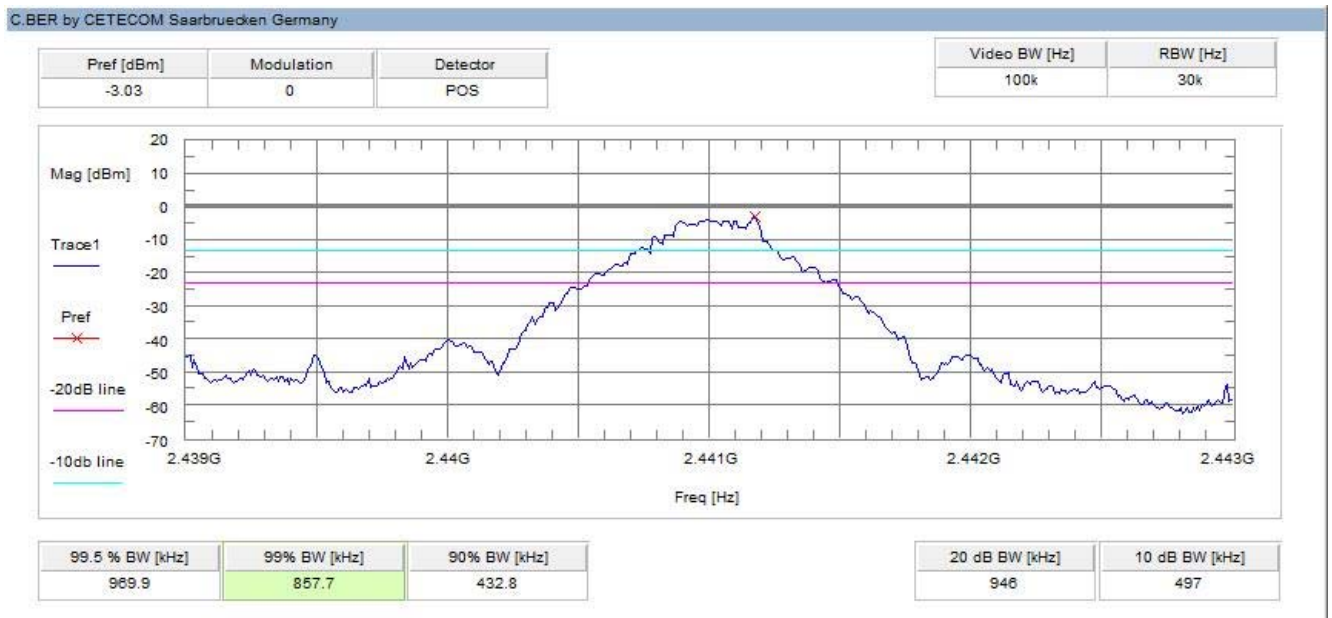

Plot 3: highest channel – 2480 MHz, GFSK modulation

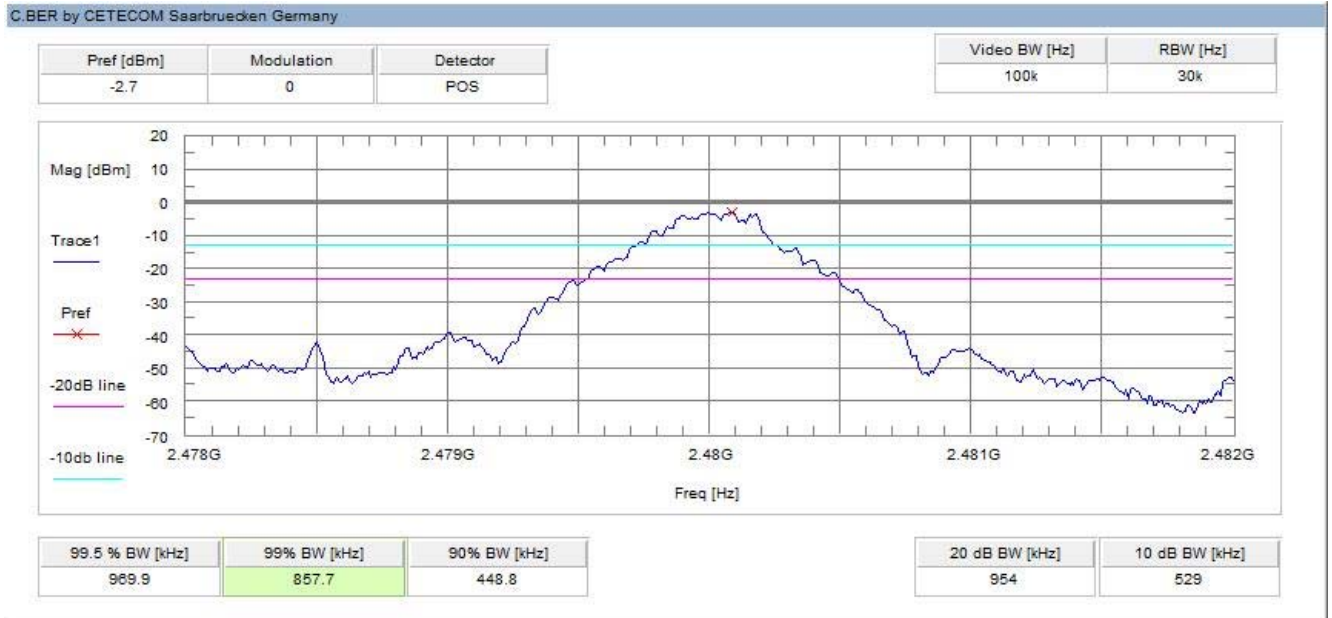

11.6 Maximum output power

Description:

Measurement of the maximum output power conducted and radiated. EUT in single channel mode. The measurement is performed according to the ANSI C63.10.

Measurement parameters	
Detector	Peak
Sweep time	Auto
Resolution bandwidth	3 MHz
Video bandwidth	10 MHz
Span	6 MHz
Trace mode	Max hold
Test setup	See sub clause 6.5 A
Measurement uncertainty	See sub clause 8

Limits:

FCC	IC
Maximum output power	
[Conducted: 0.125 W – antenna gain max. 6 dBi] Systems using more than 75 hopping channels: Conducted: 1.0 W – antenna gain max. 6 dBi	

Results:

Modulation	Maximum output power conducted [dBm]			
	Frequency	2402 MHz	2441 MHz	2480 MHz
GFSK		-3.35	-0.75	0.00

Plots:

Plot 1: lowest channel – 2402 MHz, GFSK modulation

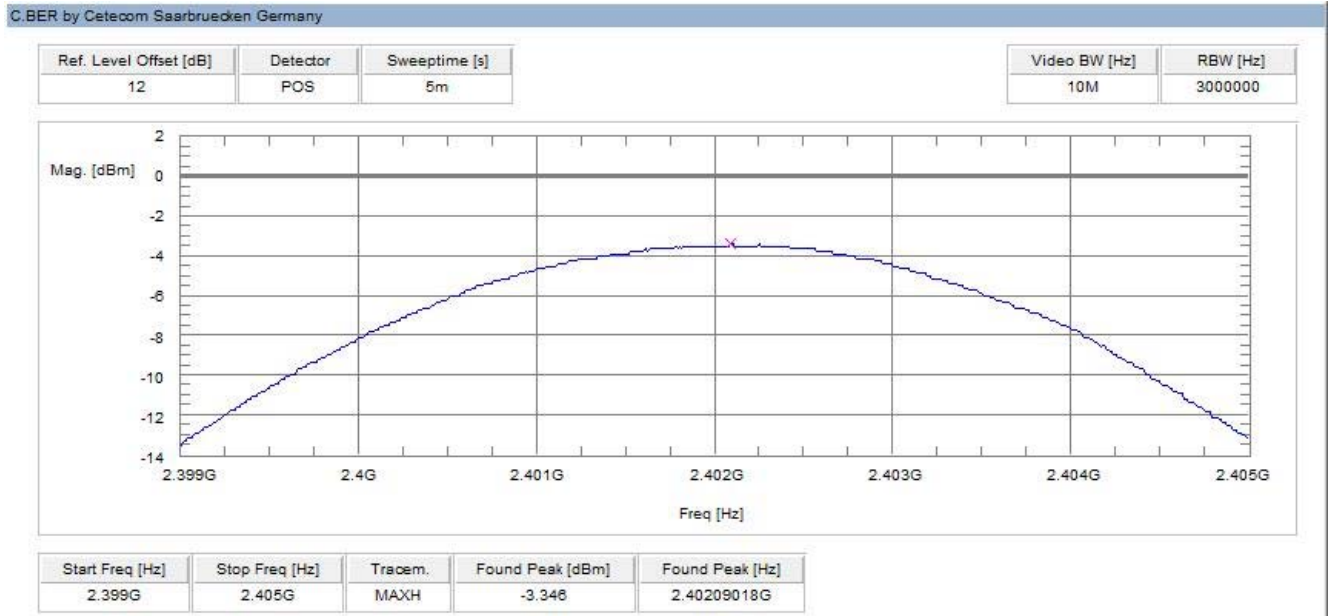

Plot 2: middle channel – 2441 MHz, GFSK modulation

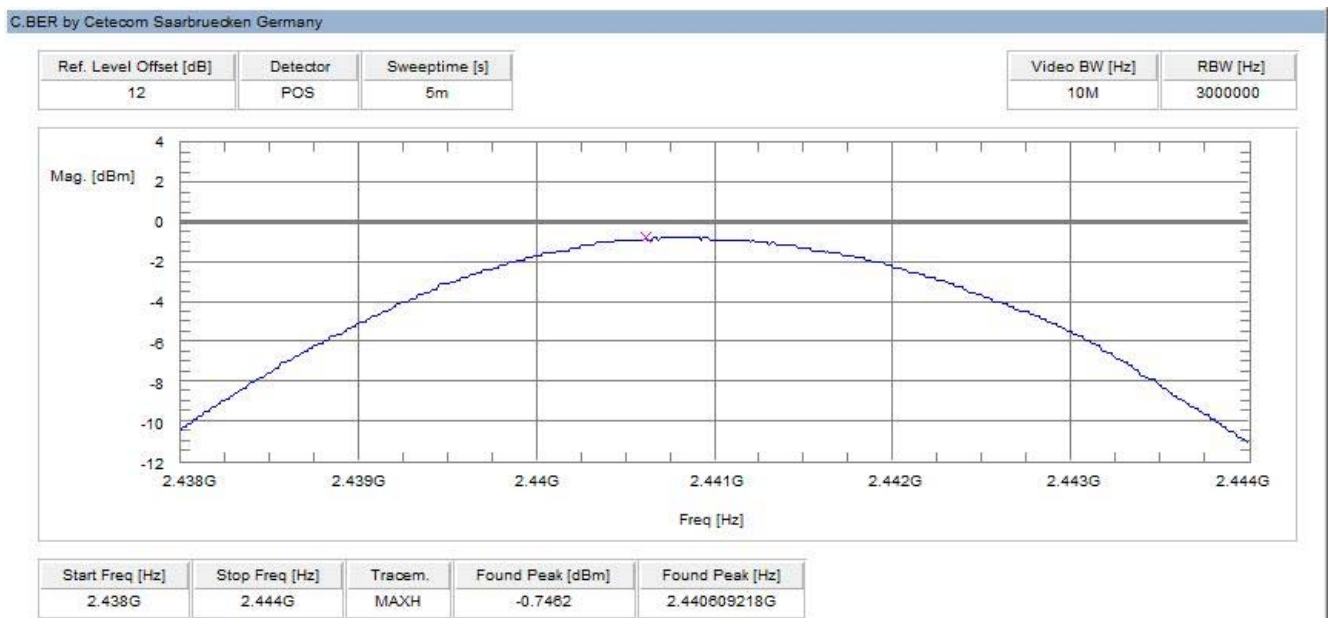

Plot 3: highest channel – 2480 MHz, GFSK modulation

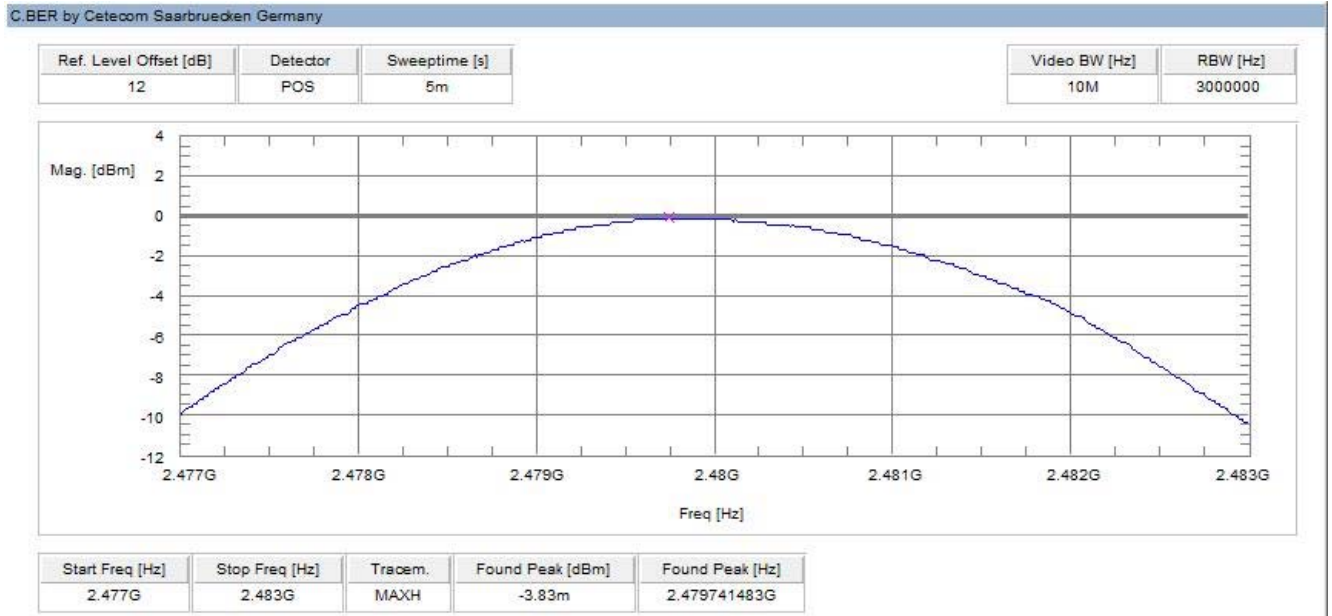

11.7 Detailed spurious emissions @ the band edge - conducted

Description:

Measurement of the conducted band edge compliance. EUT is measured at the lower and upper band edge in single channel and hopping mode. The measurement is repeated for all modulations.

Measurement parameters	
Detector	Peak
Sweep time	Auto
Resolution bandwidth	100 kHz
Video bandwidth	300 kHz / 500 kHz
Span	Lower Band Edge: 2395 – 2405 MHz Upper Band Edge: 2478 – 2489 MHz
Trace mode	Max hold
Test setup	See sub clause 6.5 A
Measurement uncertainty	See sub clause 8

Limits:

FCC	IC
In any 100 kHz bandwidth outside the frequency band in which the spread spectrum or digitally modulated intentional radiator is operating, the radio frequency power that is produced by the intentional radiator shall be at least 20 dB below that in the 100 kHz bandwidth within the band that contains the highest level of the desired power, based on either an RF conducted or a radiated measurement. Attenuation below the general limits specified in Section 15.209(a) is not required.	

Results:

Scenario	Spurious band edge conducted [dB]
Modulation	GFSK
Lower band edge – hopping off	> 20 dB
Lower band edge – hopping on	> 20 dB
Upper band edge – hopping off	> 20 dB
Upper band edge – hopping on	> 20 dB

Plots:

Plot 1: Lower band edge – hopping on, GFSK modulation

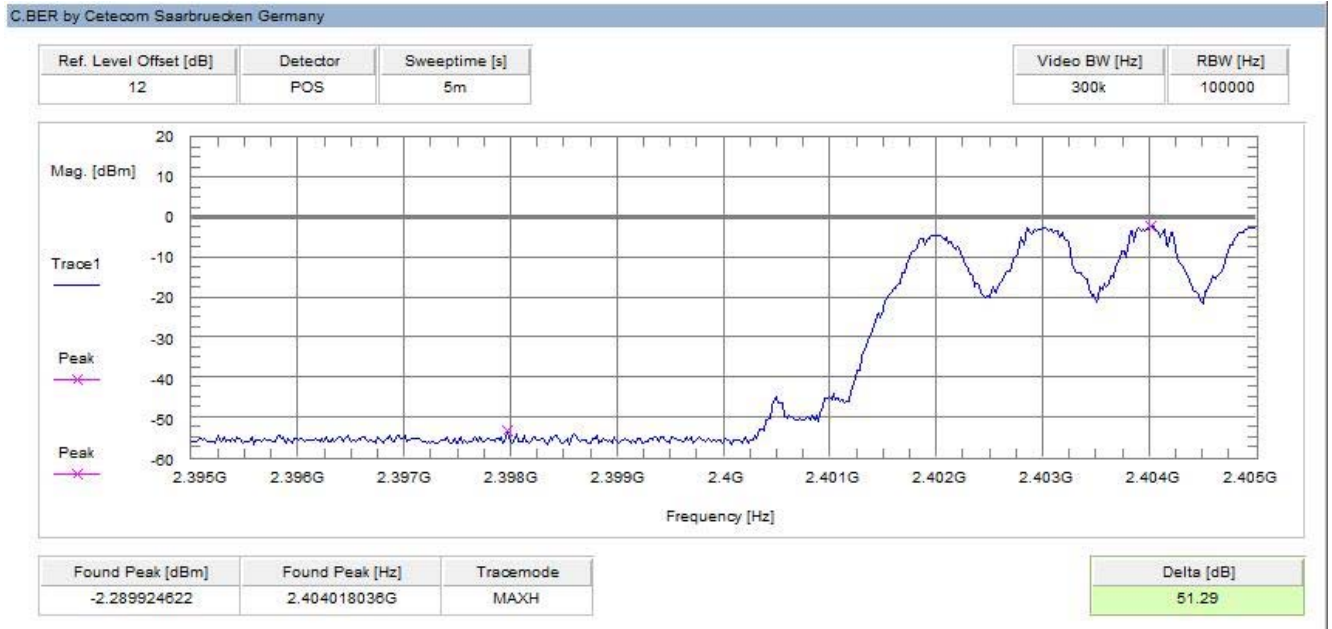

Plot 2: Upper band edge – hopping on, GFSK modulation

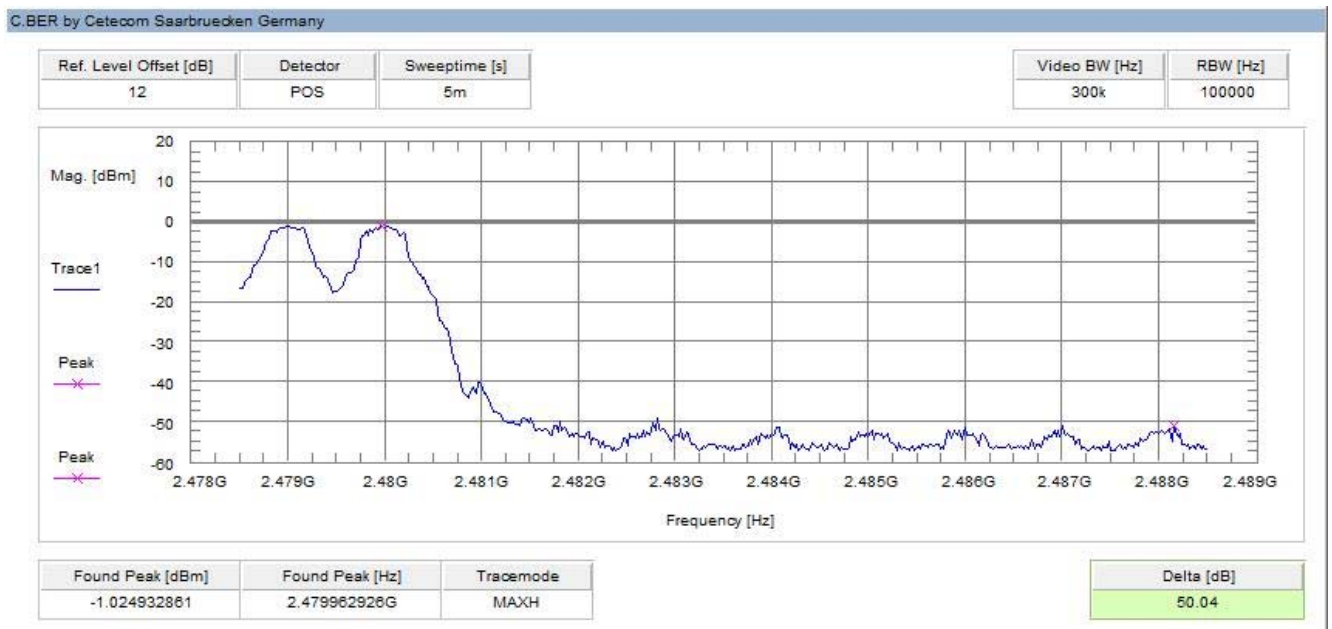

Plot 3: Lower band edge – hopping off, GFSK modulation

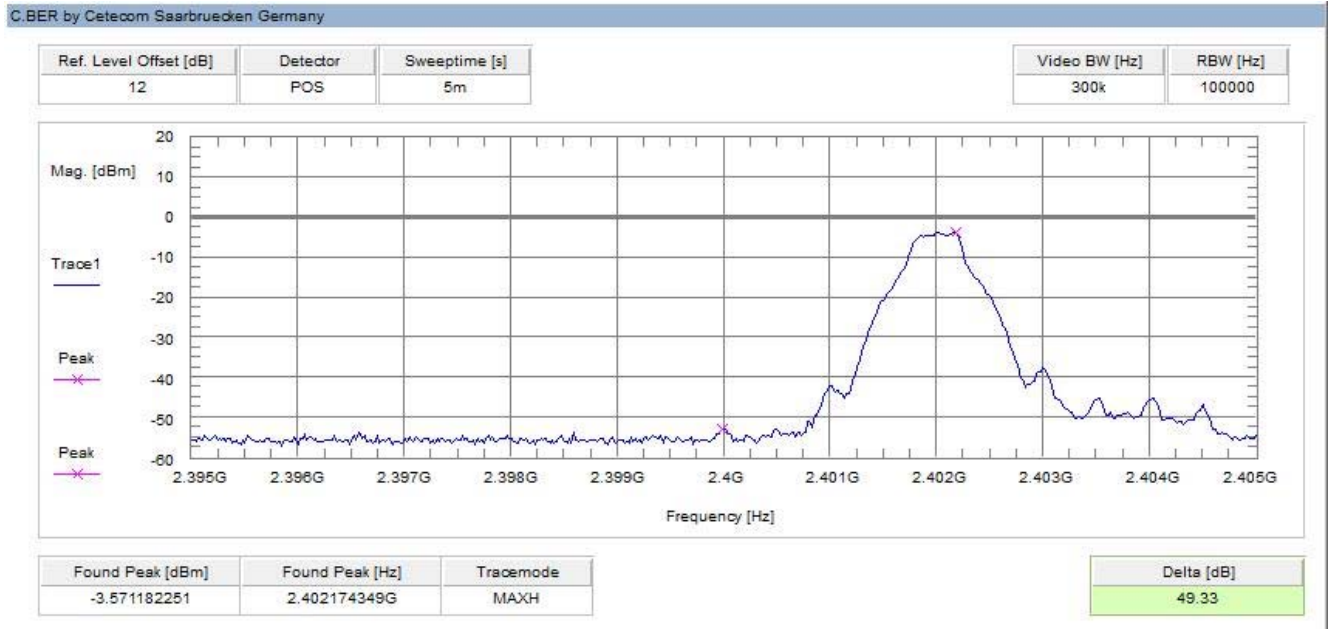

Plot 4: Upper band edge – hopping off, GFSK modulation

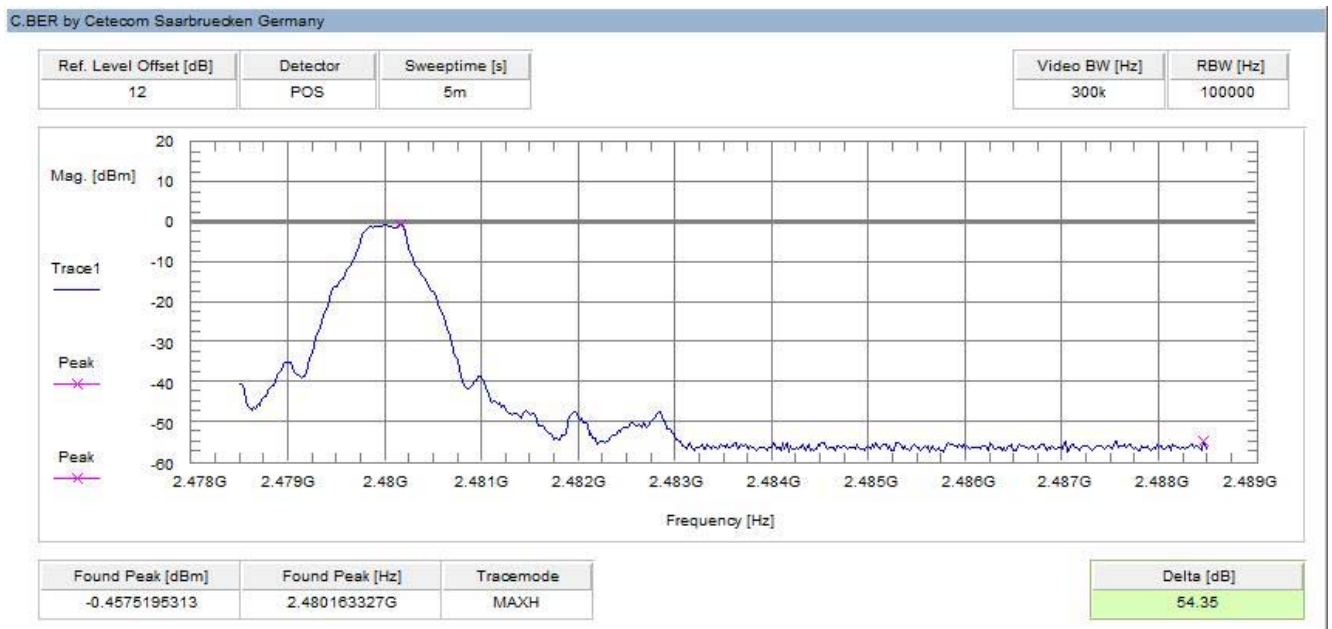

11.8 Band edge compliance radiated

Description:

Measurement of the radiated band edge compliance. The EUT is turned in the position that results in the maximum level at the band edge. Then a sweep over the corresponding restricted band is performed. The EUT is set to single channel mode and the transmit channel is channel 00 for the lower restricted band and channel 78 for the upper restricted band. The measurement is repeated for all modulations. Measurement distance is 3m.

Measurement parameters	
Detector	Peak / RMS
Sweep time	Auto
Resolution bandwidth	1 MHz
Video bandwidth	3 MHz
Span	Lower Band: 2370 – 2400 MHz Upper Band: 2480 – 2500 MHz
Trace mode	Max hold
Test setup	See sub clause 6.2 B
Measurement uncertainty	See sub clause 8

Limits:

FCC	IC
Band edge compliance radiated	
<p>In any 100 kHz bandwidth outside the frequency band in which the spread spectrum or digitally modulated intentional radiator is operating, the radio frequency power that is produced by the intentional radiator shall be at least 20 dB below that in the 100 kHz bandwidth within the band that contains the highest level of the desired power, based on either an RF conducted or a radiated measurement. Attenuation below the general limits specified in Section 15.209(a) is not required. In addition, radiated emissions which fall in the restricted bands, as defined in Section 15.205(a), must also comply with the radiated emission limits specified in Section 15.209(a) (see Section 5.205(c)).</p>	
54 dBµV/m AVG 74 dBµV/m Peak	

Results:

Scenario	Band edge compliance radiated [dBµV/m]
Modulation	GFSK
Lower restricted band	< 54 AVG / < 74 PP
Upper restricted band	< 54 AVG / < 74 PP

Plots:

Plot 1: Lower band edge, GFSK modulation, vertical & horizontal polarization

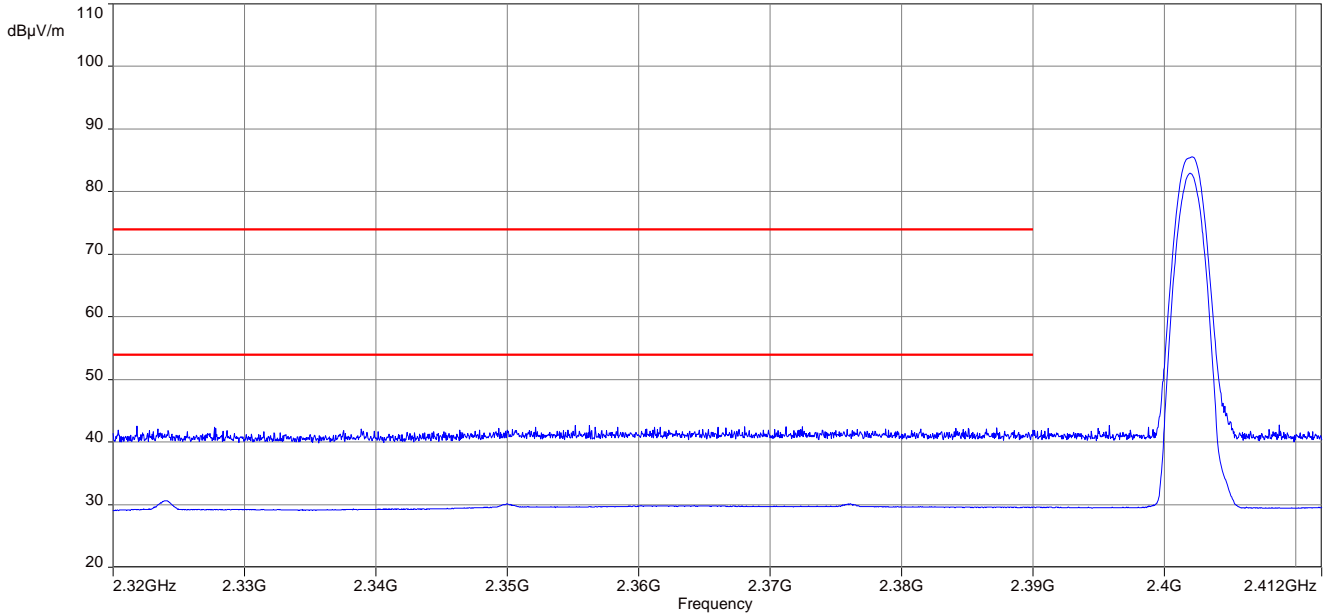

Plot 2: Upper band edge, GFSK modulation, vertical & horizontal polarization

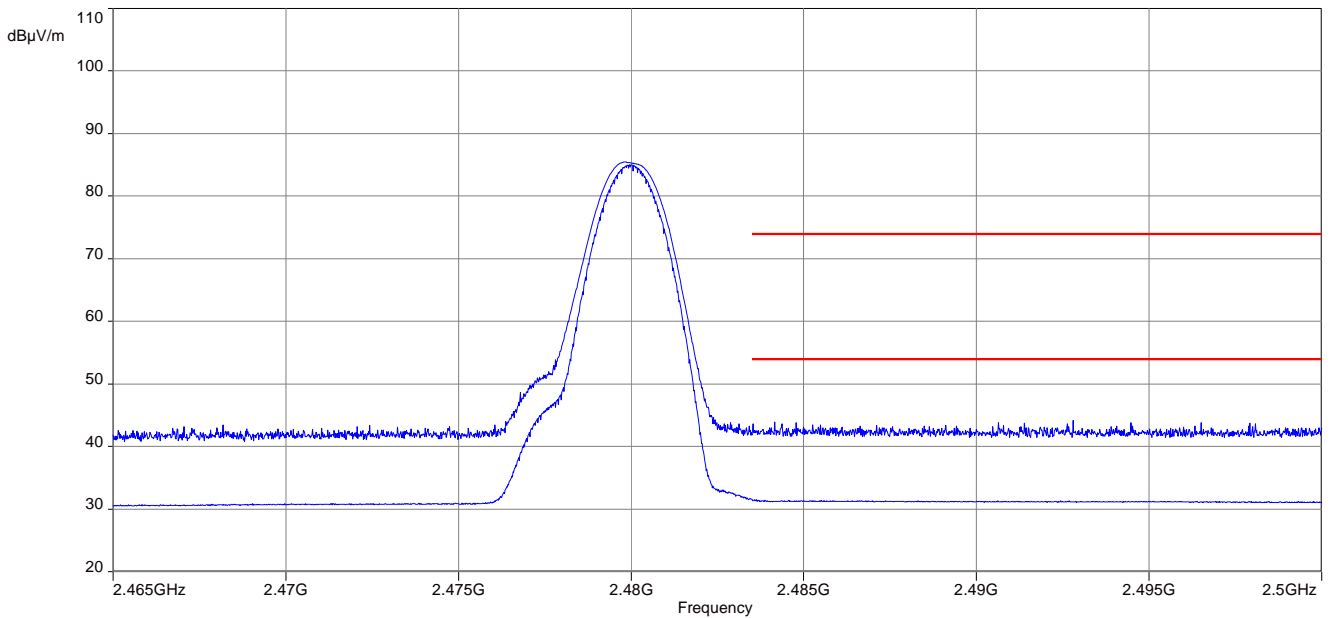

11.9 Spurious emissions conducted

Description:

Measurement of the conducted spurious emissions in transmit mode. The EUT is set to single channel mode and the transmit channel is channel 00, channel 39 and channel 78. The measurement is repeated for all modulations.

Measurement parameters	
Detector	Peak
Sweep time	Auto
Resolution bandwidth	100 kHz
Video bandwidth	300 kHz
Span	9 kHz to 25 GHz
Trace mode	Max hold
Test setup	See sub clause 6.5 A
Measurement uncertainty	See sub clause 8

Limits:

FCC	IC
TX spurious emissions conducted	
<p>In any 100 kHz bandwidth outside the frequency band in which the spread spectrum or digitally modulated intentional radiator is operating, the radio frequency power that is produced by the intentional radiator shall be at least 20 dB below that in the 100 kHz bandwidth within the band that contains the highest level of the desired power, based on either an RF conducted or a radiated measurement. Attenuation below the general limits specified in Section 15.209(a) is not required</p>	

Results:

TX spurious emissions conducted					
GFSK - mode					
f [MHz]		amplitude of emission [dBm]	limit max. allowed emission power	actual attenuation below frequency of operation [dB]	results
2402		-3.7	30 dBm		Operating frequency
All detected emissions are below the -20 dBc criteria. Please take a look at the plot!			-20 dBc		compliant
2441		-1.6	30 dBm		Operating frequency
All detected emissions are below the -20 dBc criteria. Please take a look at the plot!			-20 dBc		compliant
2480		-1.1	30 dBm		Operating frequency
All detected emissions are below the -20 dBc criteria. Please take a look at the plot!			-20 dBc		compliant

Plots:

Plot 1: lowest channel – 2402 MHz, GFSK modulation

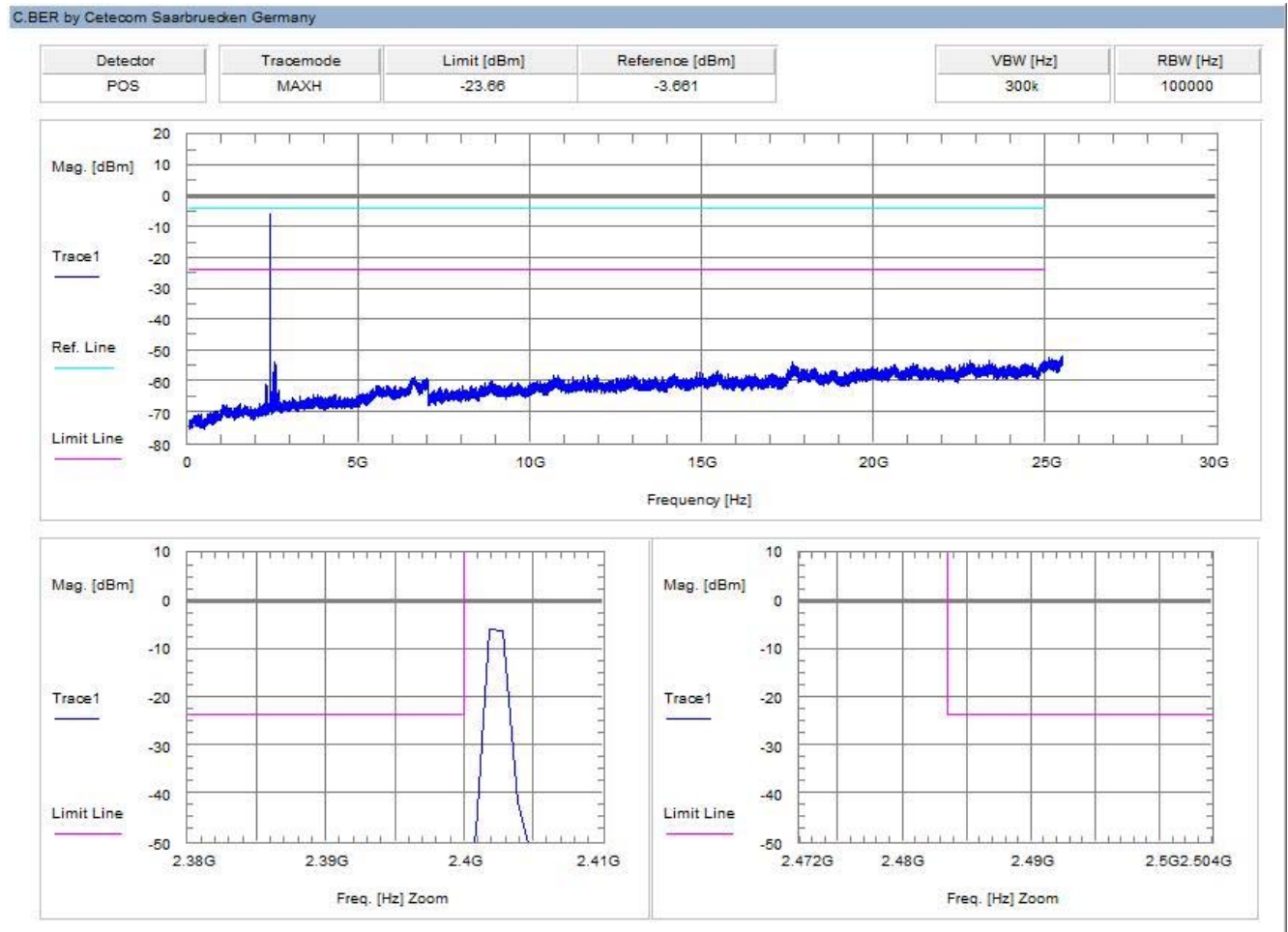

Plot 2: middle channel – 2441 MHz, GFSK modulation

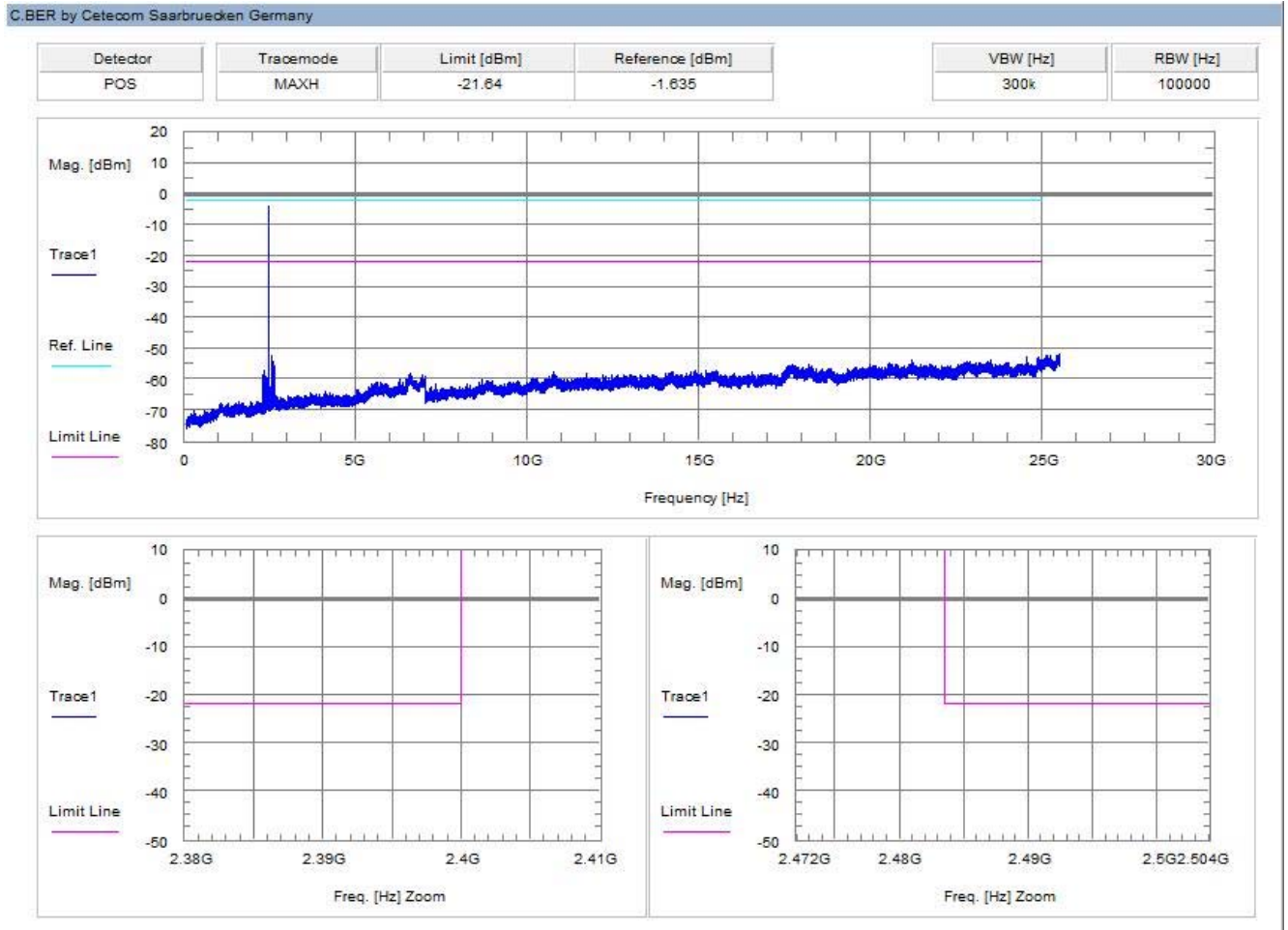

Plot 3: highest channel – 2480 MHz, GFSK modulation

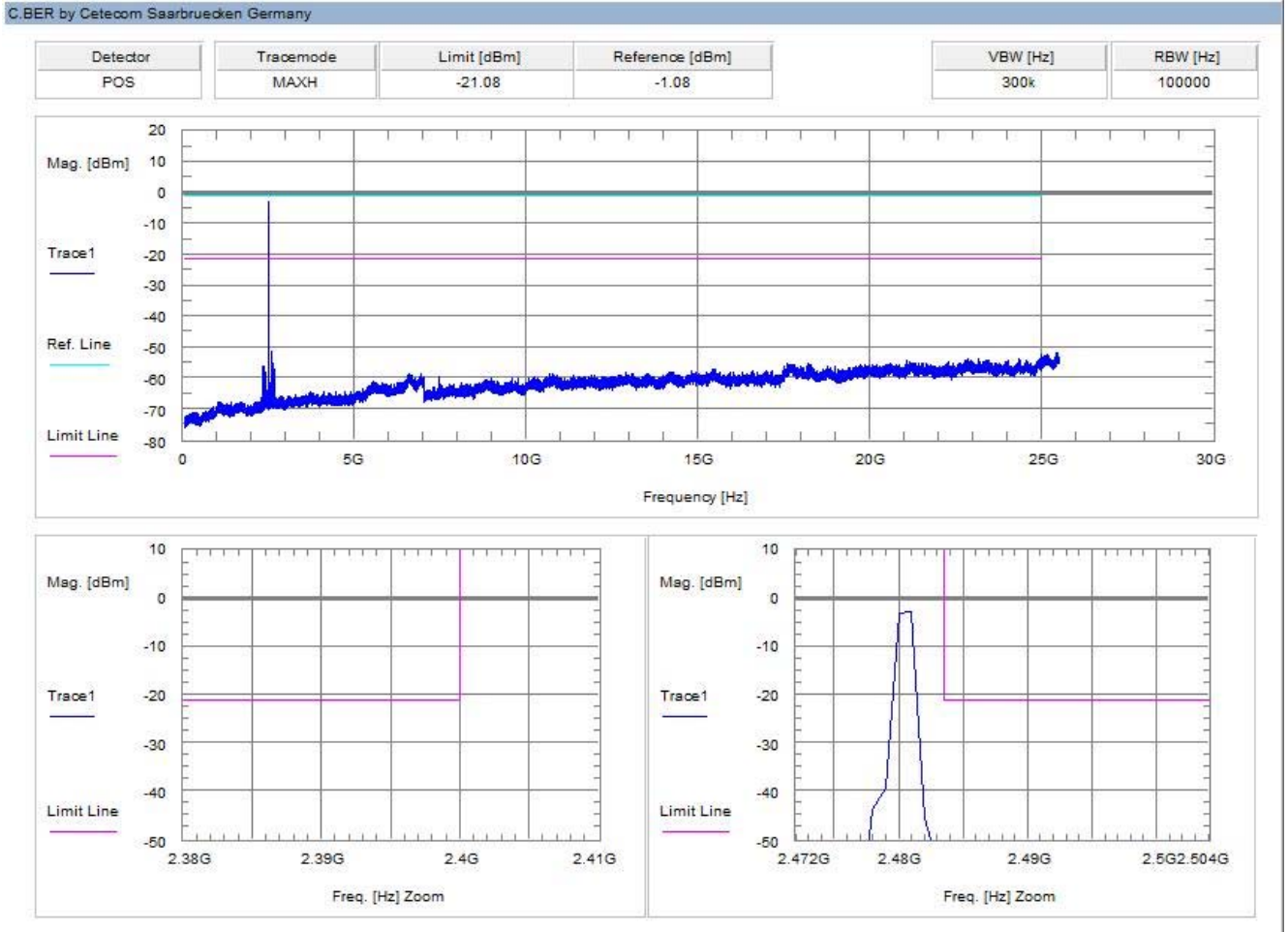

11.10 Spurious emissions radiated below 30 MHz

Description:

Measurement of the radiated spurious emissions in transmit mode below 30 MHz. The EUT is set to single channel mode and the transmit channels are 00; 39 and 78. The measurement is performed in the mode with the highest output power. The limits are recalculated to a measurement distance of 3 m according the ANSI C63.10.

Measurement parameters	
Detector	Peak / Quasi peak
Sweep time	Auto
Resolution bandwidth	F < 150 kHz: 200 Hz F > 150 kHz: 9 kHz
Video bandwidth	F < 150 kHz: 1 kHz F > 150 kHz: 100 kHz
Span	9 kHz to 30 MHz
Trace mode	Max hold
Test setup	See sub clause 6.2 C
Measurement uncertainty	See sub clause 8

Limits:

FCC		IC
TX spurious emissions radiated below 30 MHz		
Frequency (MHz)	Field strength (dBµV/m)	Measurement distance
0.009 – 0.490	2400/F(kHz)	300
0.490 – 1.705	24000/F(kHz)	30
1.705 – 30.0	30	30

Results:

TX spurious emissions radiated below 30 MHz [dBµV/m]		
F [MHz]	Detector	Level [dBµV/m]
All detected emissions are more than 20 dB below the limit.		

Plots:

Plot 1: 9 kHz to 30 MHz, channel 00, transmit mode

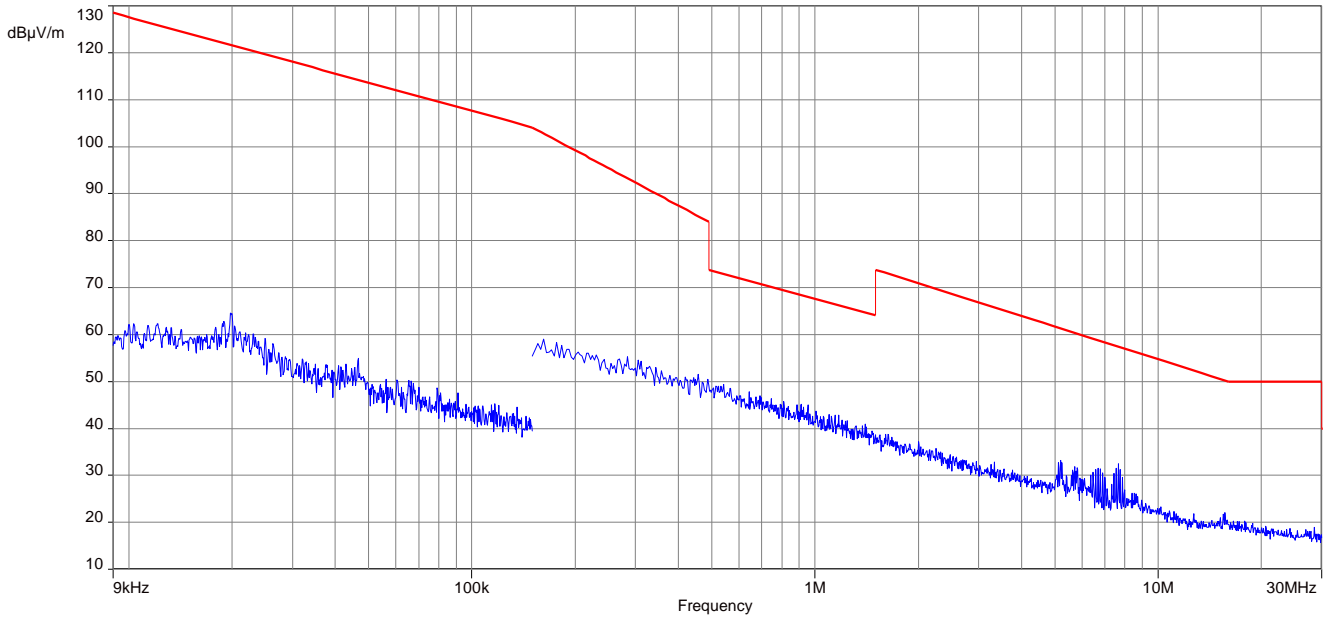

Plot 2: 9 kHz to 30 MHz, channel 39, transmit mode

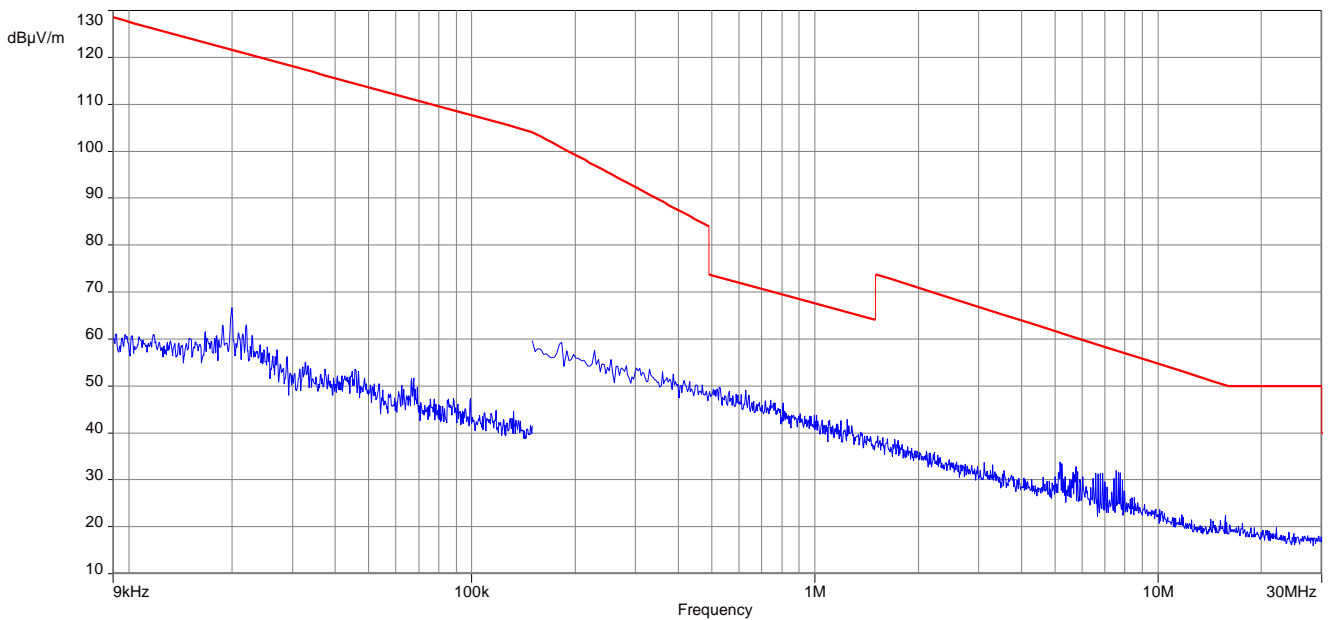

Plot 3: 9 kHz to 30 MHz, channel 78, transmit mode

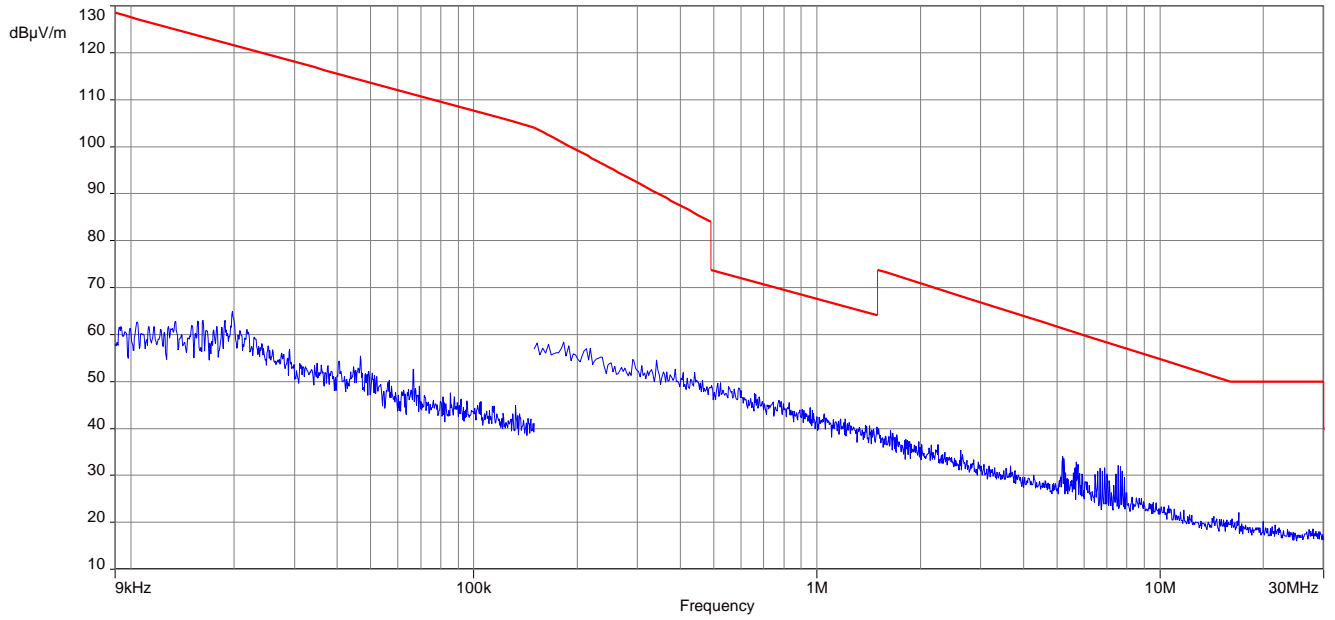

11.11 Spurious emissions radiated 30 MHz to 1 GHz

Description:

Measurement of the radiated spurious emissions in transmit mode. The EUT is set to single channel mode and the transmit channel is channel 00, channel 39 and channel 78. The measurement is performed in the mode with the highest output power.

Measurement parameters	
Detector	Peak / Quasi Peak
Sweep time	Auto
Resolution bandwidth	120 kHz
Video bandwidth	3 x RBW
Span	30 MHz to 1 GHz
Trace mode	Max hold
Measured modulation	<input checked="" type="checkbox"/> GFSK <input type="checkbox"/> Pi/4 DQPSK <input type="checkbox"/> 8DPSK
Test setup	See sub clause 6.1 A
Measurement uncertainty	See sub clause 8

The modulation with the highest output power was used to perform the transmitter spurious emissions. If spurious were detected a re-measurement was performed on the detected frequency with each modulation.

Limits:

FCC		IC	
TX spurious emissions radiated			
In any 100 kHz bandwidth outside the frequency band in which the spread spectrum or digitally modulated intentional radiator is operating, the radio frequency power that is produced by the intentional radiator shall be at least 20 dB below that in the 100 kHz bandwidth within the band that contains the highest level of the desired power, based on either an RF conducted or a radiated measurement. Attenuation below the general limits specified in Section 15.209(a) is not required. In addition, radiated emissions which fall in the restricted bands, as defined in §15.205(a), must also comply with the radiated emission limits specified in §15.209(a) (see §15.205(c)).			
§15.209			
Frequency (MHz)	Field strength (dBµV/m)	Measurement distance	
30 - 88	30.0	10	
88 – 216	33.5	10	
216 – 960	36.0	10	
Above 960	54.0	3	

Plots: Transmit mode

Plot 1: 30 MHz to 1 GHz, TX mode, channel 00, vertical & horizontal polarization

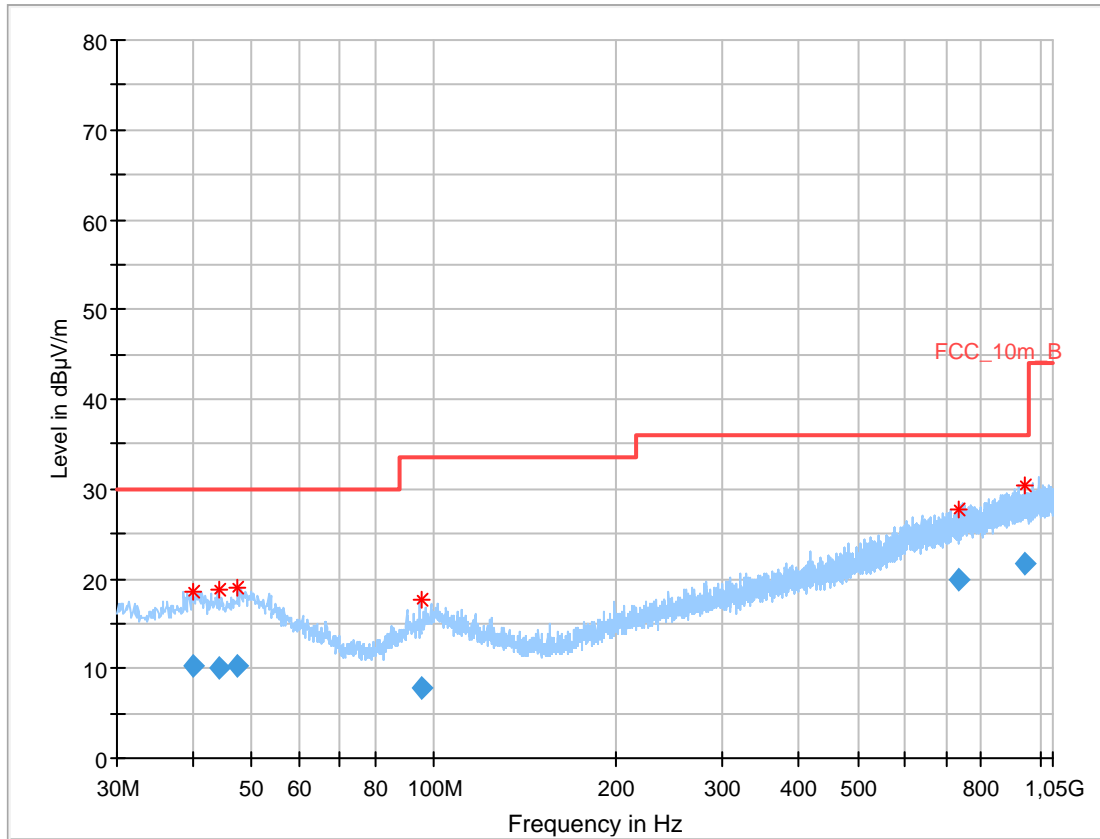

Final_Result:

Frequency (MHz)	QuasiPeak (dBµV/m)	Limit (dBµV/m)	Margin (dB)	Meas. Time (ms)	Bandwidth (kHz)	Height (cm)	Pol	Azimuth (deg)	Corr. (dB)
39.934200	10.26	30.00	19.74	1000.0	120.000	101.0	H	114.0	13.2
44.192700	10.09	30.00	19.91	1000.0	120.000	101.0	H	99.0	12.8
47.440200	10.32	30.00	19.68	1000.0	120.000	101.0	V	352.0	13.2
95.098650	7.77	33.50	25.73	1000.0	120.000	101.0	V	352.0	11.3
731.679450	19.88	36.00	16.12	1000.0	120.000	177.0	V	305.0	22.3
942.343200	21.71	36.00	14.29	1000.0	120.000	185.0	V	329.0	24.2

Plot 2: 30 MHz to 1 GHz, TX mode, channel 39, vertical & horizontal polarization

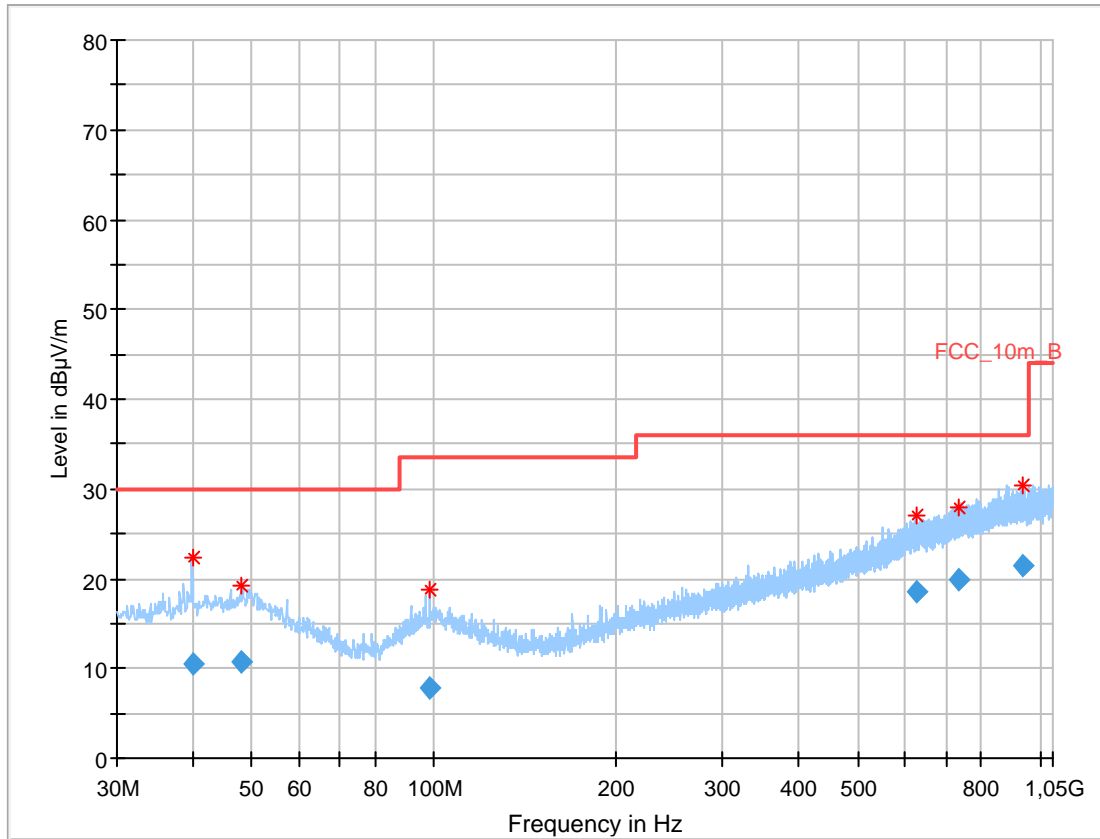

Final_Result:

Frequency (MHz)	QuasiPeak (dBµV/m)	Limit (dBµV/m)	Margin (dB)	Meas. Time (ms)	Bandwidth (kHz)	Height (cm)	Pol	Azimuth (deg)	Corr. (dB)
40.060200	10.43	30.00	19.57	1000.0	120.000	178.0	H	46.0	13.2
48.201900	10.73	30.00	19.27	1000.0	120.000	101.0	V	98.0	13.4
98.249100	7.84	33.50	25.66	1000.0	120.000	101.0	H	201.0	11.9
623.397150	18.44	36.00	17.56	1000.0	120.000	185.0	H	224.0	20.9
731.509050	19.83	36.00	16.17	1000.0	120.000	98.0	H	34.0	22.3
934.656150	21.55	36.00	14.45	1000.0	120.000	185.0	H	97.0	24.2

Plot 3: 30 MHz to 1 GHz, TX mode, channel 78, vertical & horizontal polarization

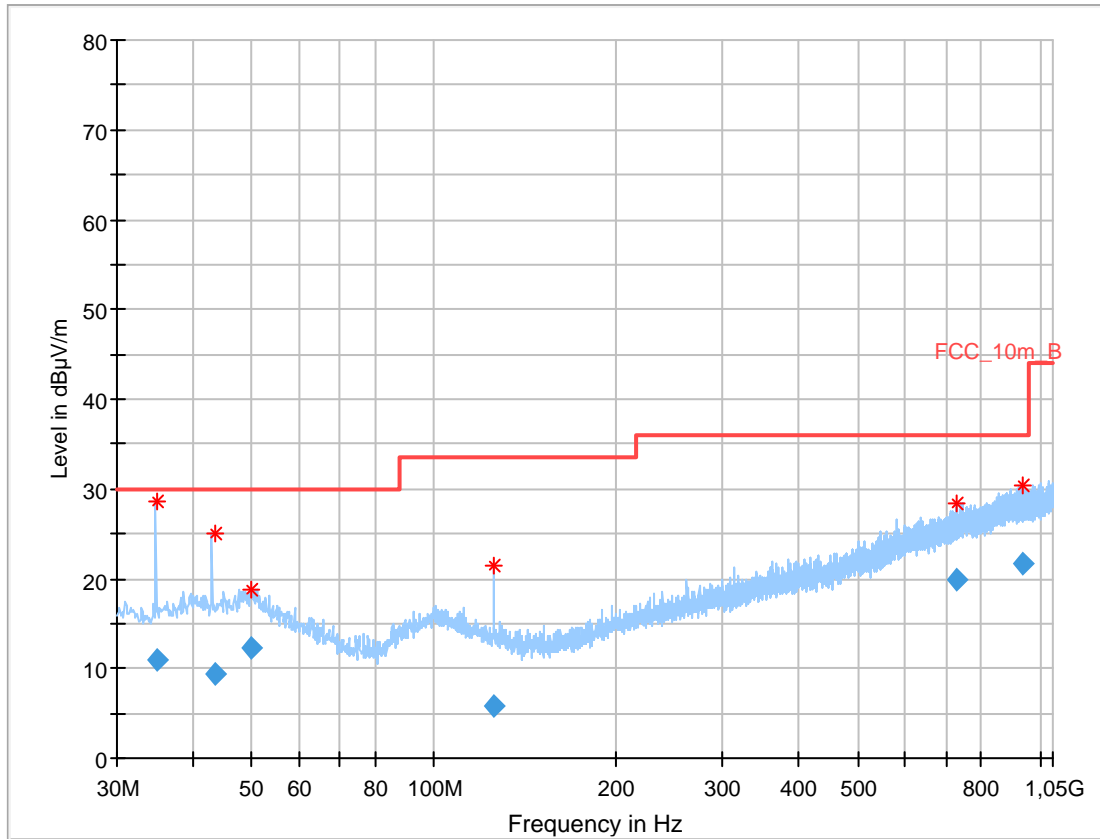

Final_Result:

Frequency (MHz)	QuasiPeak (dBµV/m)	Limit (dBµV/m)	Margin (dB)	Meas. Time (ms)	Bandwidth (kHz)	Height (cm)	Pol	Azimuth (deg)	Corr. (dB)
35.026050	11.05	30.00	18.95	1000.0	120.000	101.0	V	70.0	11.7
43.487550	9.34	30.00	20.66	1000.0	120.000	101.0	V	70.0	12.9
50.032200	12.38	30.00	17.62	1000.0	120.000	101.0	H	236.0	13.7
125.111700	5.90	33.50	27.60	1000.0	120.000	101.0	V	66.0	9.8
730.859250	19.86	36.00	16.14	1000.0	120.000	185.0	V	6.0	22.3
939.187950	21.58	36.00	14.42	1000.0	120.000	185.0	V	36.0	24.2

Plots: Receiver mode

Plot 1: 30 MHz to 1 GHz, RX / idle – mode, vertical & horizontal polarization

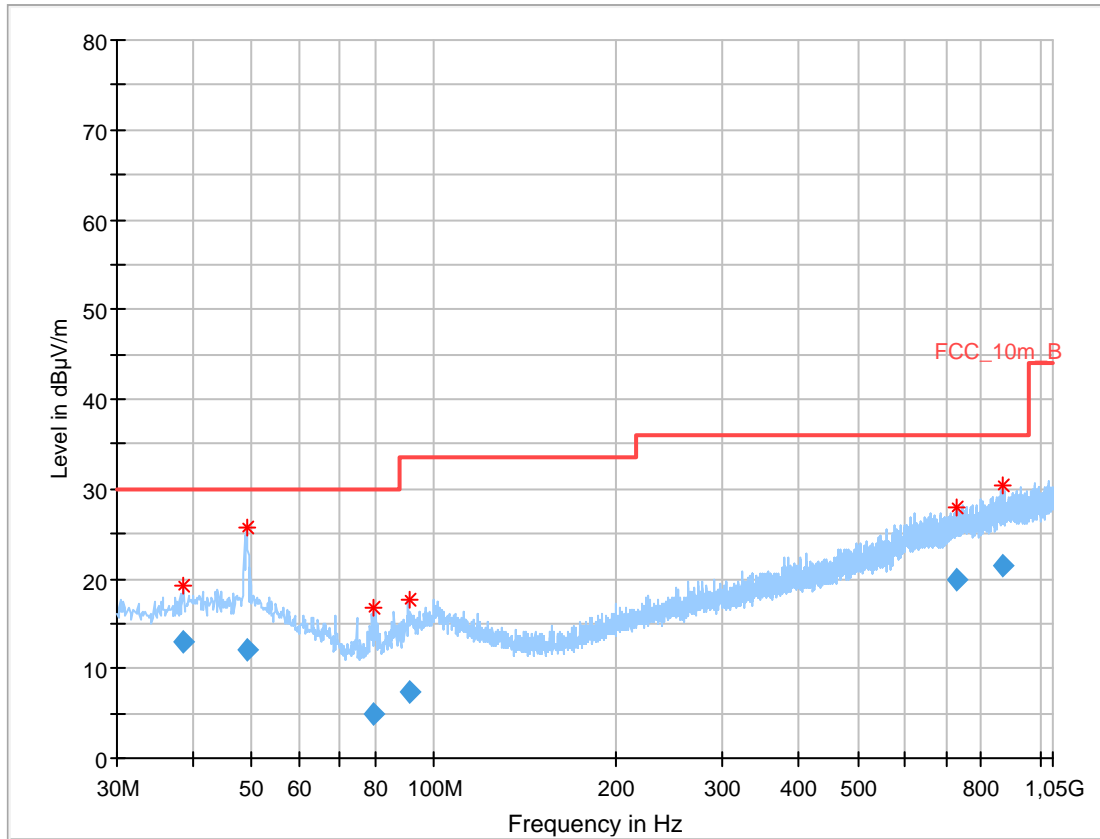

Final_Result:

Frequency (MHz)	QuasiPeak (dBµV/m)	Limit (dBµV/m)	Margin (dB)	Meas. Time (ms)	Bandwidth (kHz)	Height (cm)	Pol	Azimuth (deg)	Corr. (dB)
38.682300	13.01	30.00	16.99	1000.0	120.000	179.0	H	67.0	12.8
49.169250	11.97	30.00	18.03	1000.0	120.000	185.0	H	0.0	13.5
79.790850	4.96	30.00	25.04	1000.0	120.000	101.0	H	13.0	8.1
91.024200	7.38	33.50	26.12	1000.0	120.000	101.0	H	13.0	10.6
729.264900	19.84	36.00	16.16	1000.0	120.000	185.0	V	262.0	22.2
866.838750	21.46	36.00	14.54	1000.0	120.000	178.0	H	231.0	23.7

11.12 Spurious emissions radiated above 1 GHz

Description:

Measurement of the radiated spurious emissions in transmit mode. The EUT is set to single channel mode and the transmit channel is channel 00, channel 39 and channel 78. The measurement is performed in the mode with the highest output power.

Measurement parameters	
Detector	Peak / RMS
Sweep time	Auto
Resolution bandwidth	1 MHz
Video bandwidth	3 x RBW
Span	1 GHz to 26 GHz
Trace mode	Max hold
Measured modulation	<input checked="" type="checkbox"/> GFSK <input type="checkbox"/> Pi/4 DQPSK <input type="checkbox"/> 8DPSK
Test setup	See sub clause 6.2 A (1 GHz - 18 GHz) See sub clause 6.3 A (18 GHz - 26 GHz)
Measurement uncertainty	See sub clause 8

The modulation with the highest output power was used to perform the transmitter spurious emissions. If spurious were detected a re-measurement was performed on the detected frequency with each modulation.

Limits:

FCC		IC	
TX spurious emissions radiated			
In any 100 kHz bandwidth outside the frequency band in which the spread spectrum or digitally modulated intentional radiator is operating, the radio frequency power that is produced by the intentional radiator shall be at least 20 dB below that in the 100 kHz bandwidth within the band that contains the highest level of the desired power, based on either an RF conducted or a radiated measurement. Attenuation below the general limits specified in Section 15.209(a) is not required. In addition, radiated emissions which fall in the restricted bands, as defined in §15.205(a), must also comply with the radiated emission limits specified in §15.209(a) (see §15.205(c)).			
§15.209			
Frequency (MHz)	Field strength (dBµV/m)	Measurement distance	
Above 960	54.0	3	

Results: Transmitter mode

TX spurious emissions radiated [dBµV/m]								
2402 MHz			2441 MHz			2480 MHz		
F [MHz]	Detector	Level [dBµV/m]	F [MHz]	Detector	Level [dBµV/m]	F [MHz]	Detector	Level [dBµV/m]
1078.1	Peak	41.2	1078.1	Peak	41.2	1078.1	Peak	41.2
	AVG	-/-		AVG	-/-		AVG	-/-
1160.5	Peak	41.5	1160.5	Peak	41.5	1160.5	Peak	41.5
	AVG	-/-		AVG	-/-		AVG	-/-
-/-	Peak	-/-	7326	Peak	45.4	1832.8	Peak	41.5
	AVG	-/-		AVG	-/-		No RB!	AVG
						2584	Peak	50.1
						No RB!	AVG	-/-

Results: Receiver mode

RX spurious emissions radiated [dBµV/m]		
F [MHz]	Detector	Level [dBµV/m]
1078.5	Peak	39.6
	AVG	-/-
1161.6	Peak	43.7
	AVG	

Note: The limit was recalculated with 20 dB / decade (Part 15.31) for all radiated spurious emissions 30 MHz to 1 GHz from 3 meter limit to a 10 meter distance. (40dB/decade for emissions < 30MHz)

Plots: Transmitter mode

Plot 1: 1 GHz to 7 GHz, TX mode, channel 00, vertical & horizontal polarization

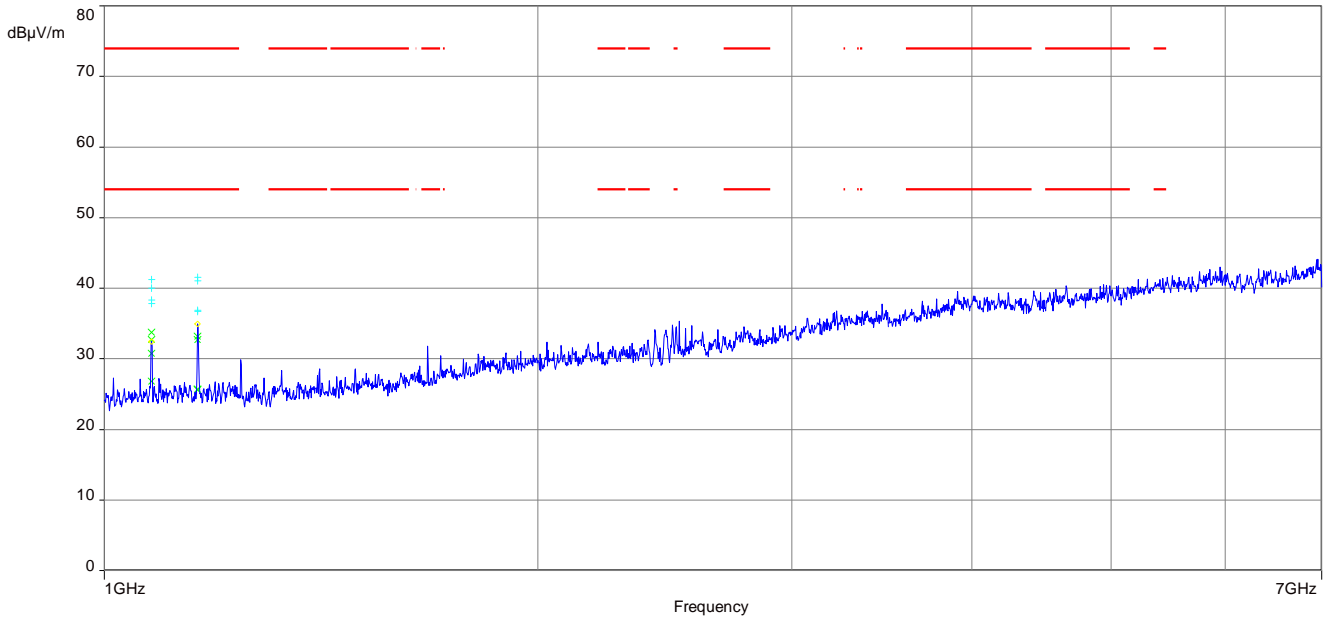

The carrier signal is notched with a 2.4 GHz band rejection filter.

Plot 2: 7 GHz to 18 GHz, TX mode, channel 00, vertical & horizontal polarization

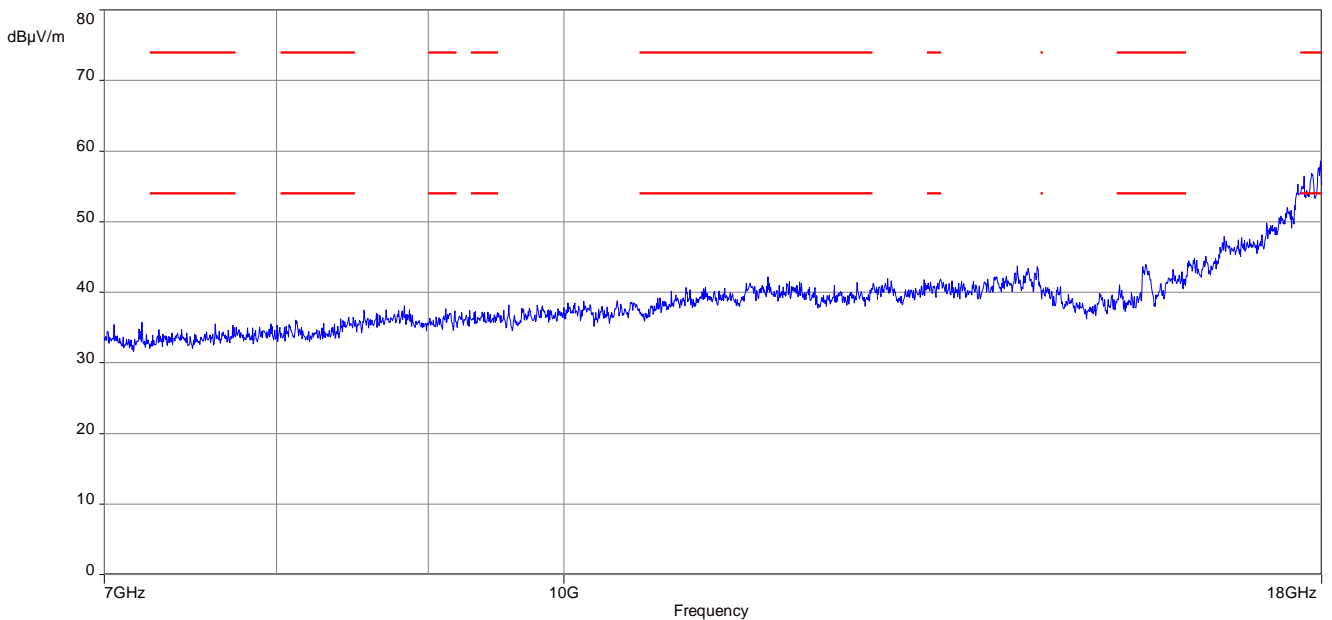

Plot 3: 17.7 GHz to 18 GHz, TX mode, channel 00, vertical & horizontal polarization

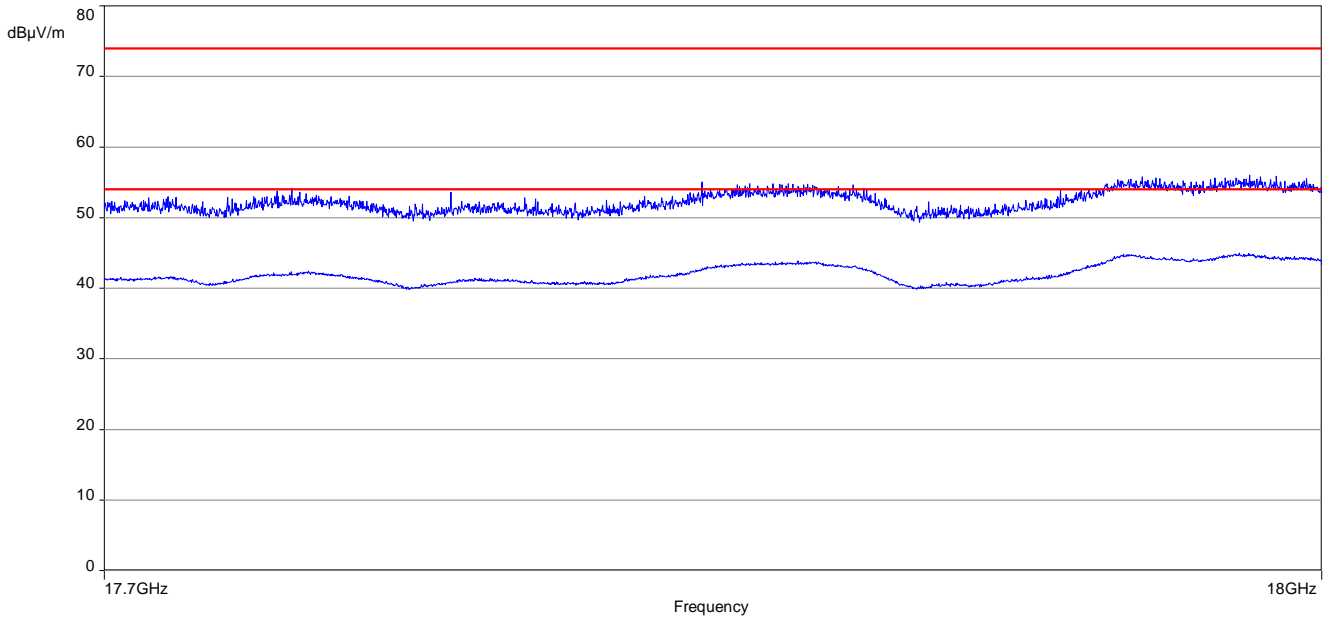

Plot 4: 18 GHz to 26 GHz, TX mode, channel 00, vertical & horizontal polarization

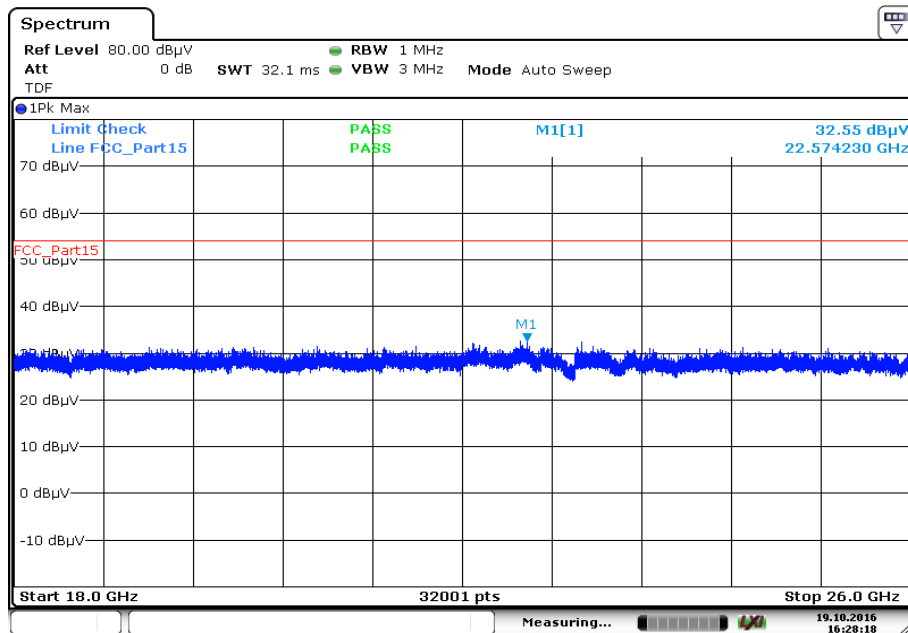

Date: 19.OCT.2016 16:28:18

Plot 5: 1 GHz to 7 GHz, TX mode, channel 19, vertical & horizontal polarization

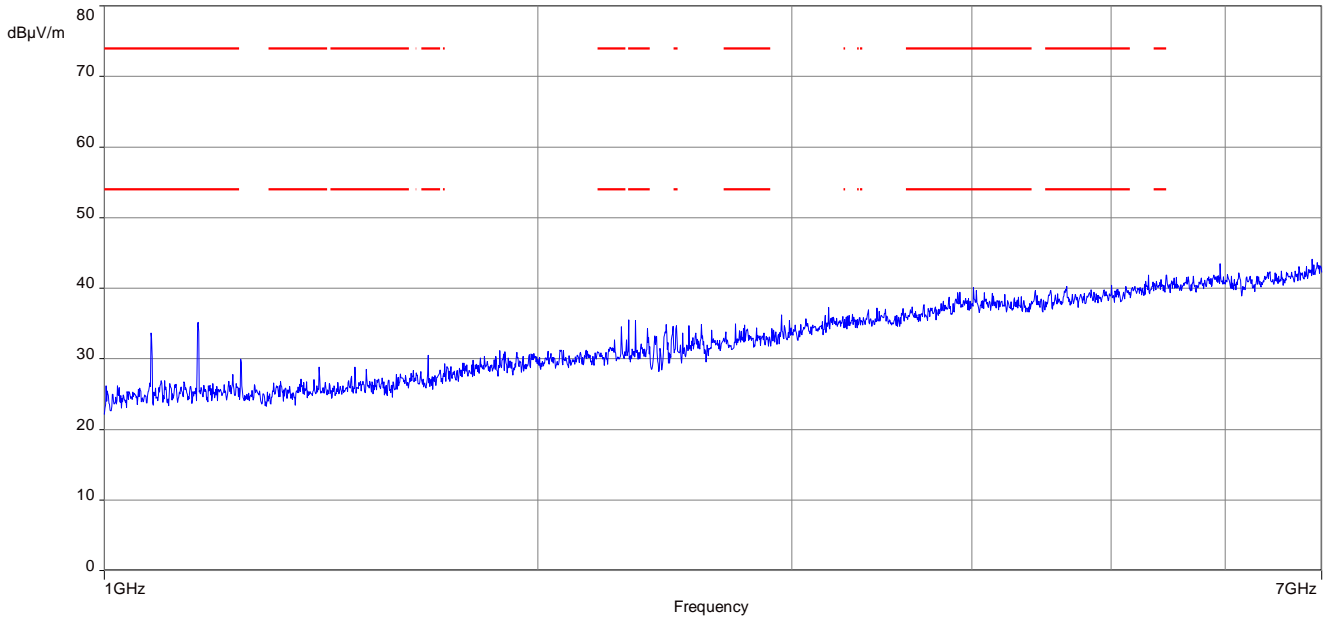

The carrier signal is notched with a 2.4 GHz band rejection filter.

Plot 6: 7 GHz to 18 GHz, TX mode, channel 19, vertical & horizontal polarization

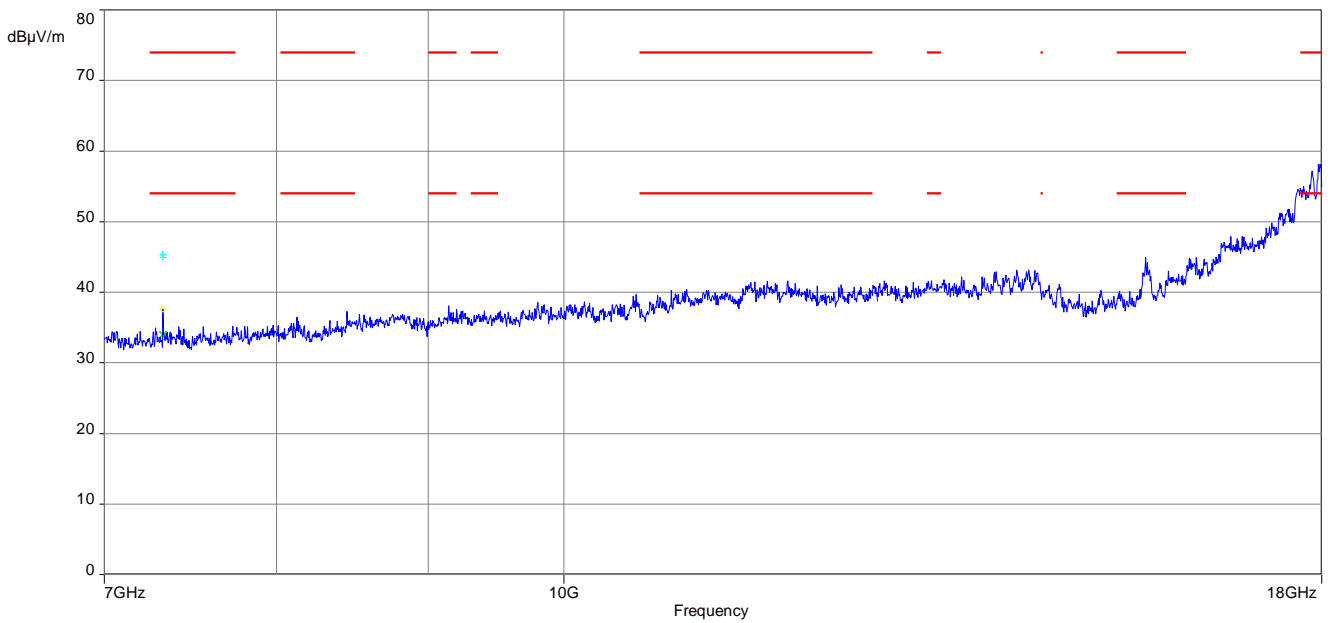

Plot 7: 17.7 GHz to 18 GHz, TX mode, channel 19, vertical & horizontal polarization

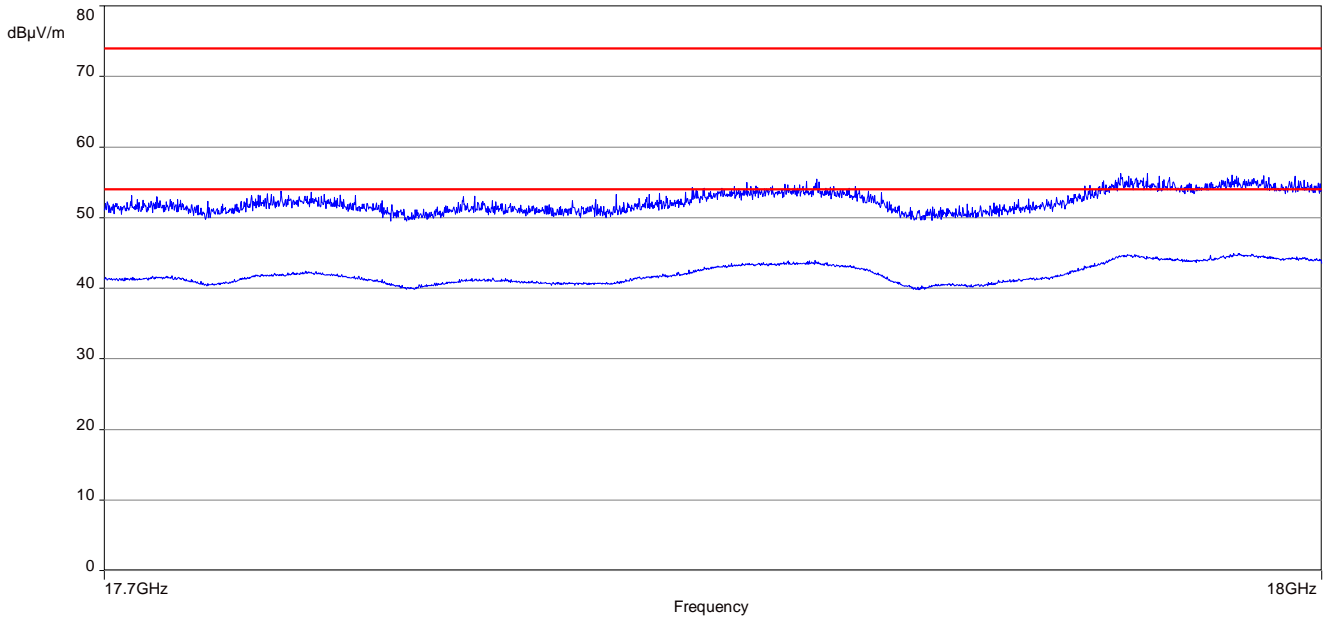

Plot 8: 18 GHz to 26 GHz, TX mode, channel 19, vertical & horizontal polarization

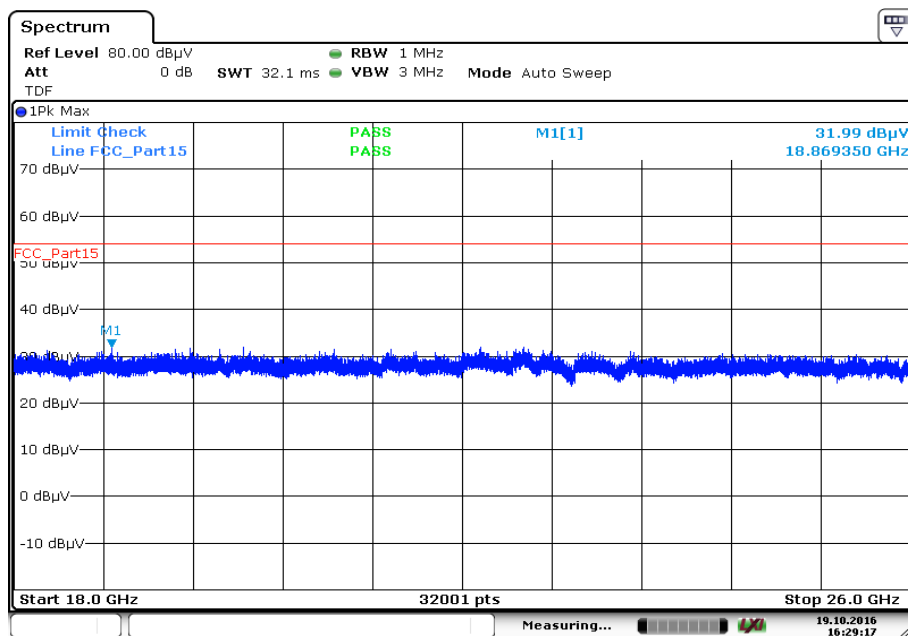

Plot 9: 1 GHz to 7 GHz, TX mode, channel 39, vertical & horizontal polarization

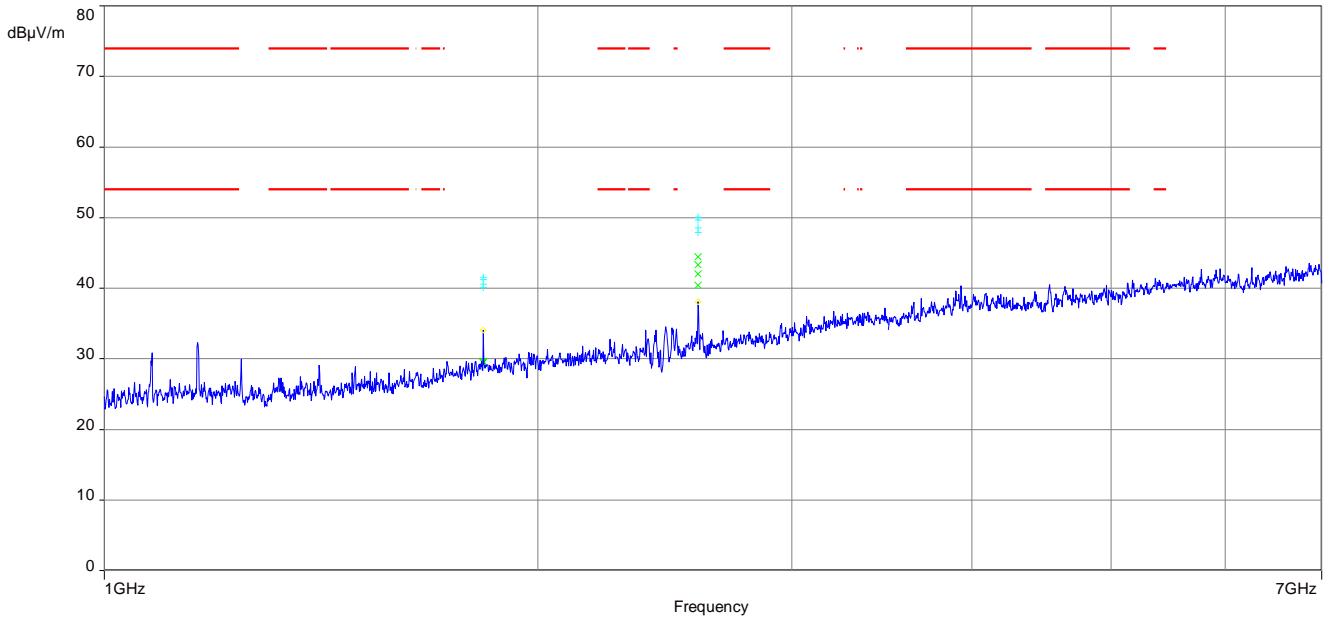

The carrier signal is notched with a 2.4 GHz band rejection filter.

Plot 10: 7 GHz to 18 GHz, TX mode, channel 39, vertical & horizontal polarization

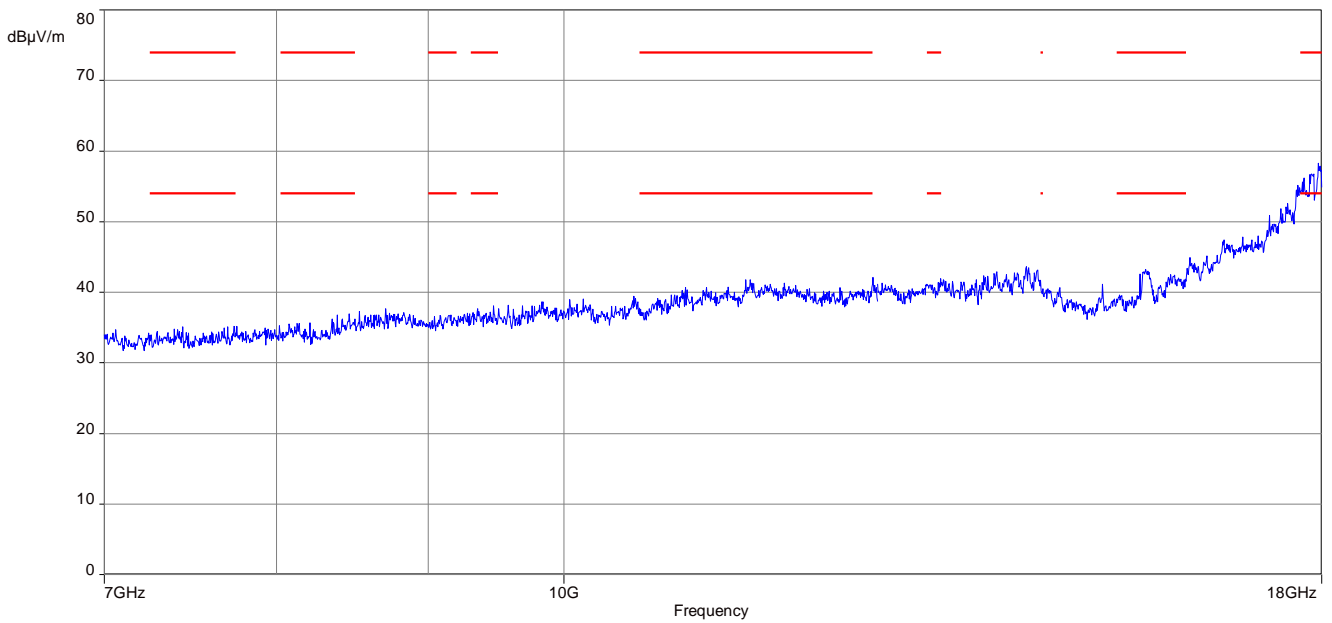

Plot 11: 17.7 GHz to 18 GHz, TX mode, channel 39, vertical & horizontal polarization

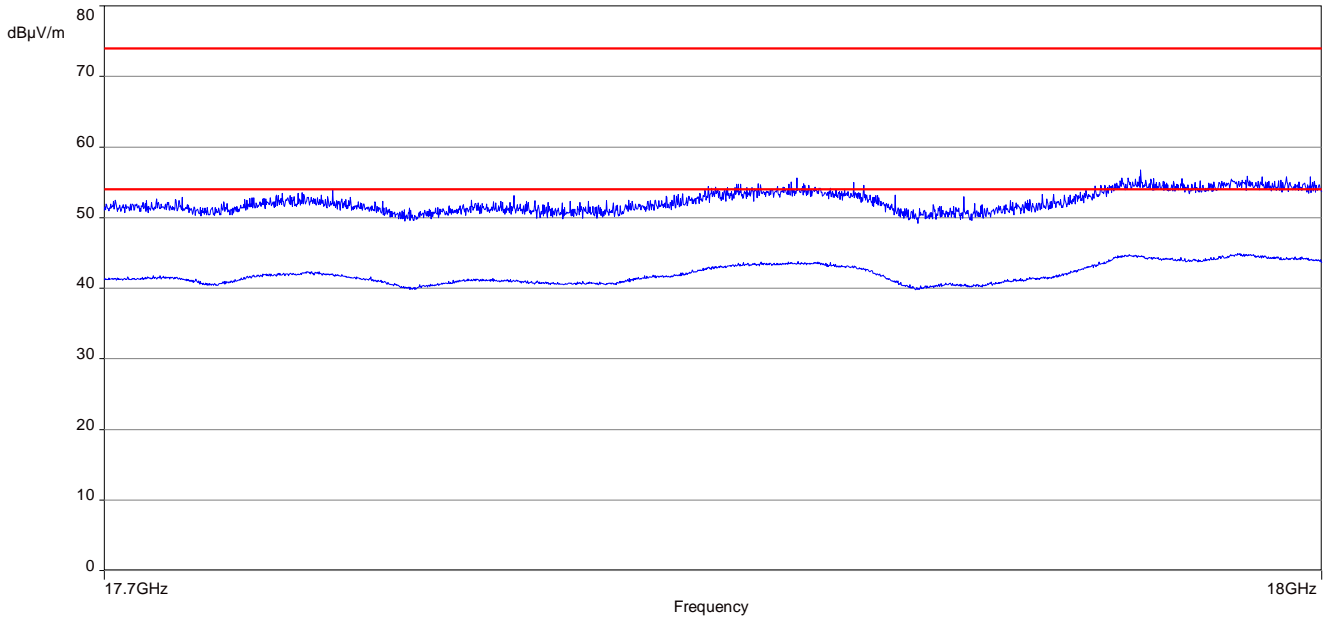

Plot 12: 18 GHz to 26 GHz, TX mode, channel 39, vertical & horizontal polarization

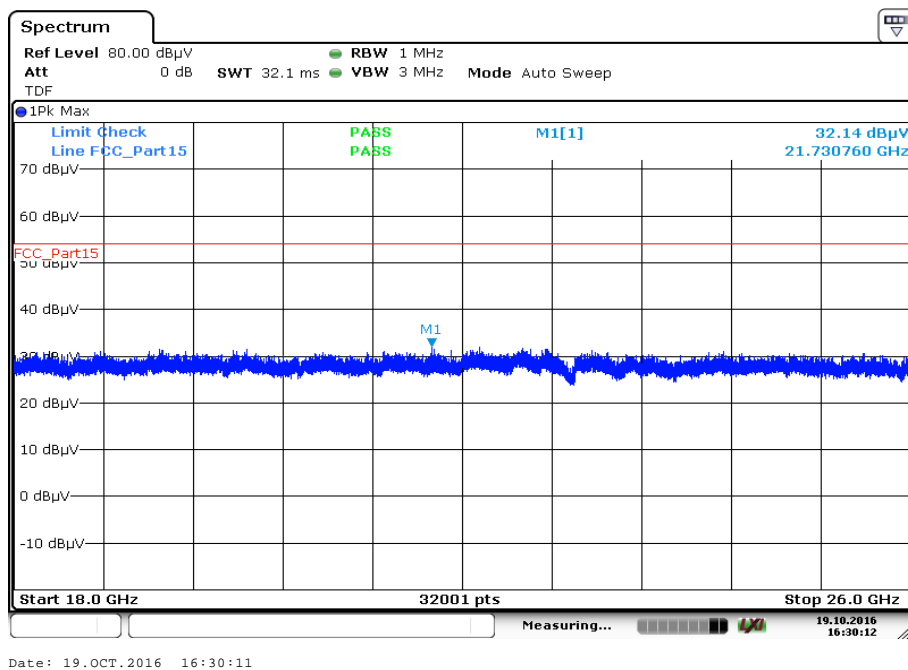

Plots: Receiver mode

Plot 1: 1 GHz to 7 GHz, RX / idle – mode, vertical & horizontal polarization

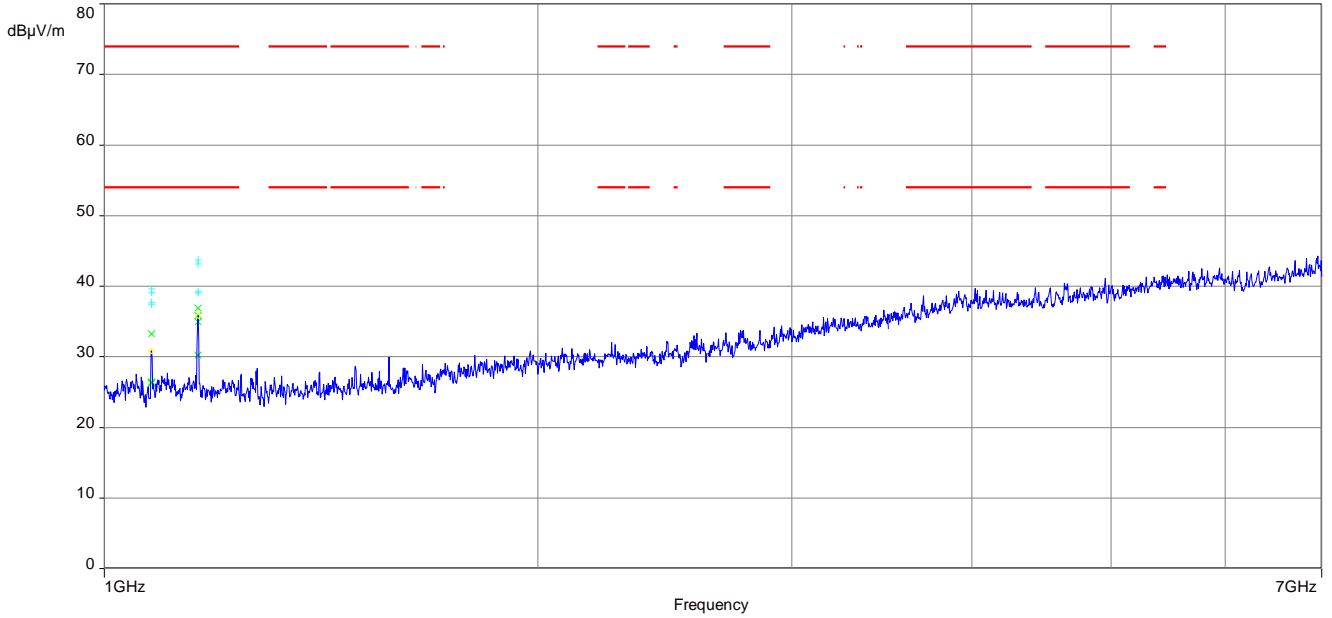

Plot 2: 7 GHz to 18 GHz, RX / idle – mode, vertical & horizontal polarization

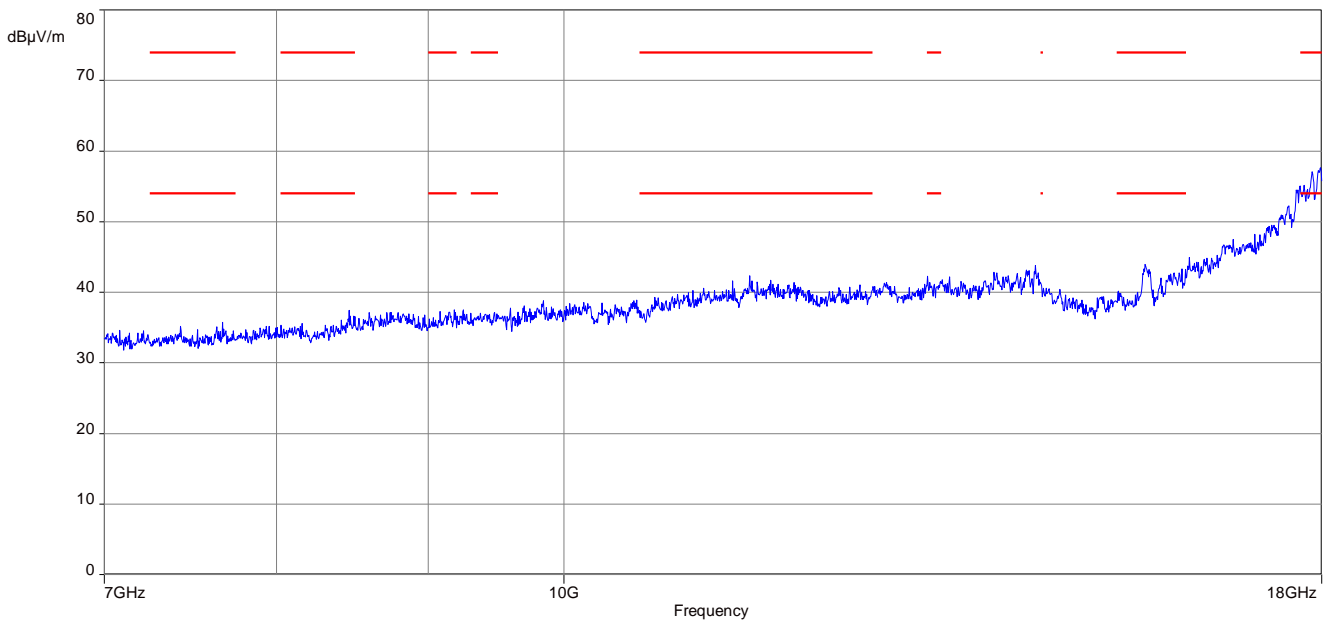

Plot 3: 17.7 GHz to 18 GHz, RX / idle – mode, vertical & horizontal polarization

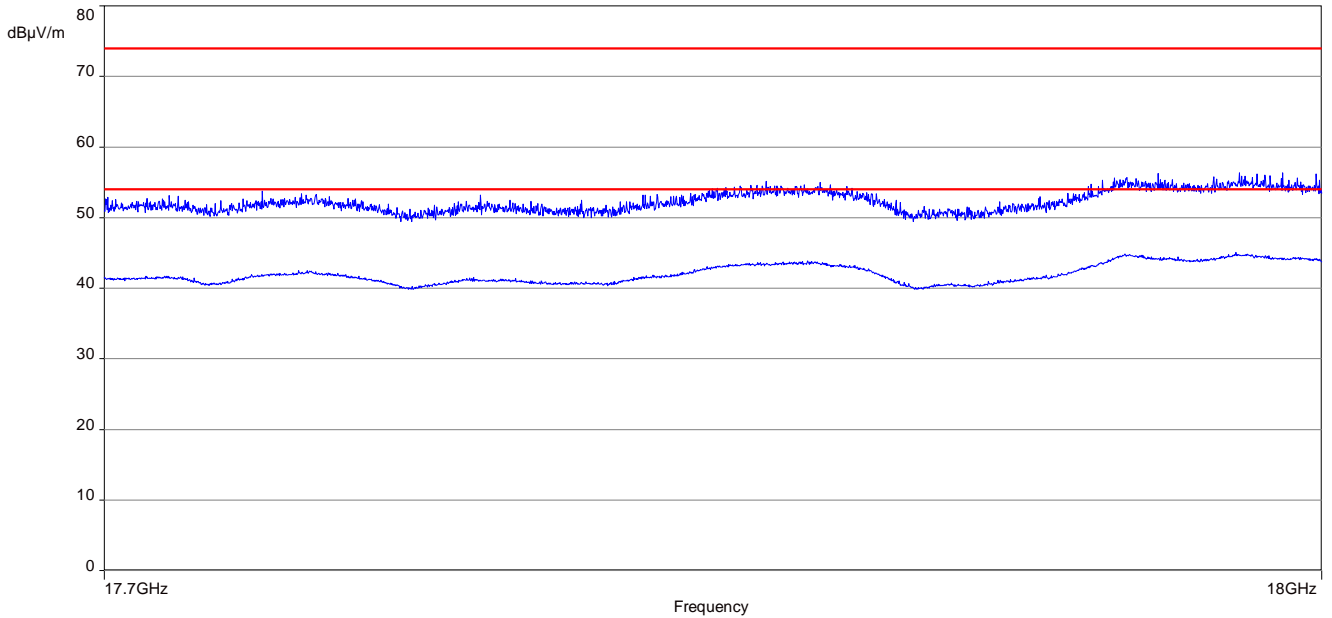

Plot 4: 18 GHz to 26 GHz, RX / idle – mode, vertical & horizontal polarization

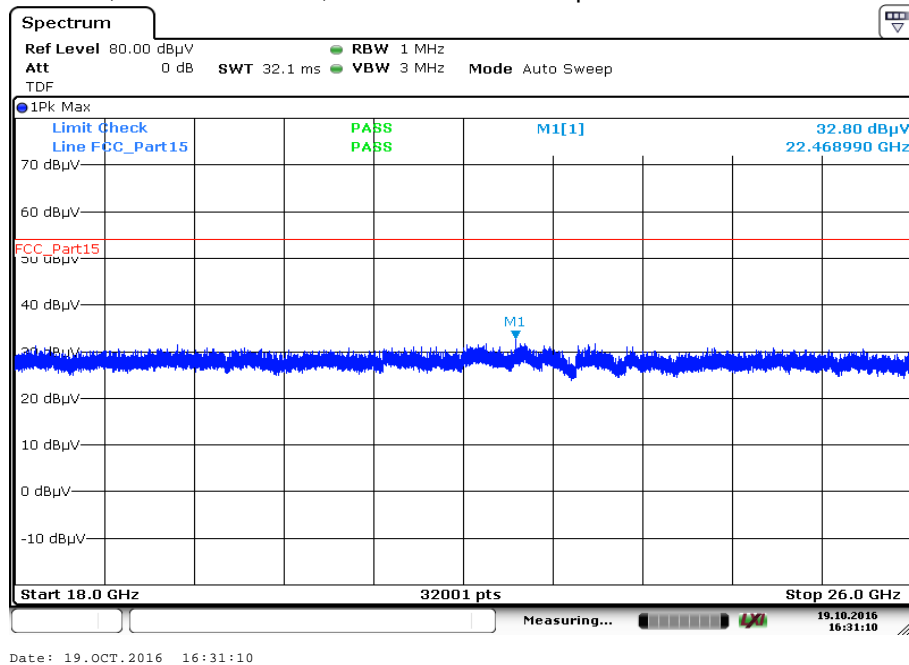

11.13 Spurious emissions conducted below 30 MHz (AC conducted)

Description:

Measurement of the conducted spurious emissions in transmit mode below 30 MHz. The EUT is set to single channel mode and the transmit channel is channel 39. This measurement is representative for all channels and modes. If critical peaks are found channel 00 and channel 78 will be measured too. The measurement is performed in the mode with the highest output power. Both power lines, phase and neutral line, are measured. Found peaks are remeasured with average and quasi peak detection to show compliance to the limits.

Measurement parameters	
Detector	Peak - Quasi peak / average
Sweep time	Auto
Resolution bandwidth	F < 150 kHz: 200 Hz F > 150 kHz: 9 kHz
Video bandwidth	F < 150 kHz: 1 kHz F > 150 kHz: 100 kHz
Span	9 kHz to 30 MHz
Trace mode	Max hold
Test setup	See sub clause 6.4 A
Measurement uncertainty	See sub clause 8

Limits:

FCC		IC	
TX spurious emissions conducted < 30 MHz			
Frequency (MHz)	Quasi-peak (dBµV/m)	Average (dBµV/m)	
0.15 – 0.5	66 to 56*	56 to 46*	
0.5 – 5	56	46	
5 – 30.0	60	50	

*Decreases with the logarithm of the frequency

Results:

Spurious emissions conducted < 30 MHz [dBµV/m]		
F [MHz]	Detector	Level [dBµV/m]
See table below the plots.		

Plots:

Plot 1: 150 kHz to 30 MHz, phase line

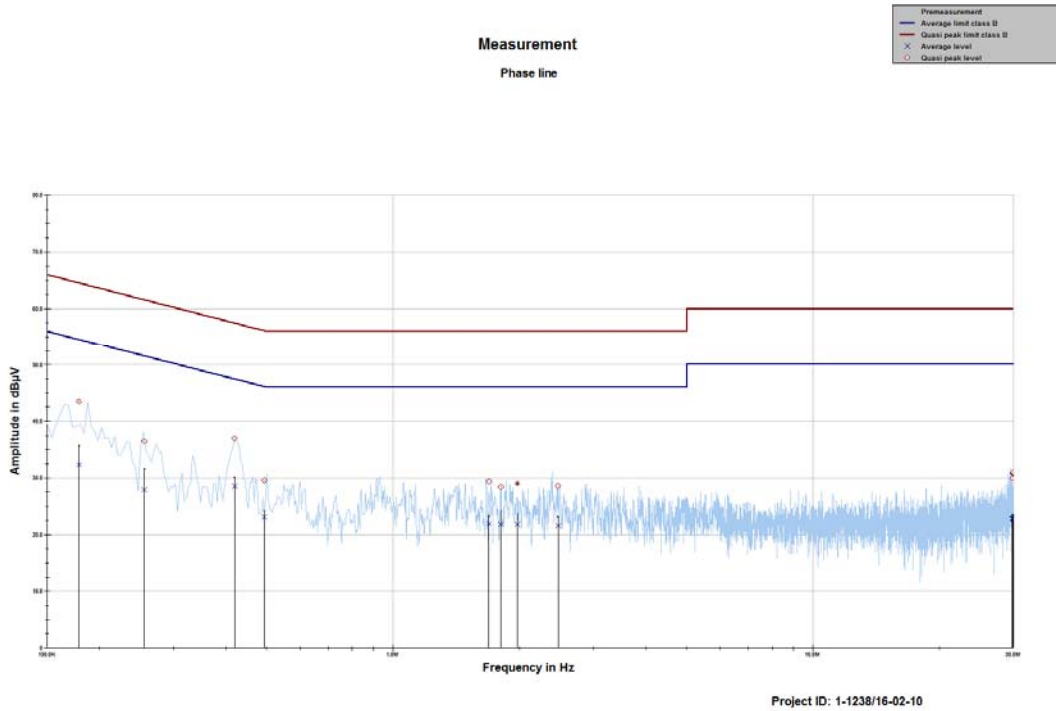

Frequency MHz	Quasi peak level dBµV	Margin quasi peak dB	Limit QP dBµV	Average level dBµV	Margin average dB	Limit AV dBµV
0.178810	43.44	21.10	64.541	32.31	22.87	55.177
0.255776	36.46	25.11	61.567	27.90	25.07	52.978
0.419325	37.01	20.45	57.462	28.55	19.75	48.305
0.493574	29.54	26.56	56.107	23.14	23.04	46.184
1.690266	29.39	26.61	56.000	21.86	24.14	46.000
1.805413	28.41	27.59	56.000	21.78	24.22	46.000
1.976325	28.99	27.01	56.000	21.83	24.17	46.000
2.470504	28.62	27.38	56.000	21.56	24.44	46.000
29.798643	29.99	30.01	60.000	22.88	27.12	50.000
29.901760	30.81	29.19	60.000	22.84	27.16	50.000
29.966737	30.89	29.11	60.000	22.67	27.33	50.000
29.972574	30.98	29.02	60.000	22.76	27.24	50.000

Plot 2: 150 kHz to 30 MHz, neutral line

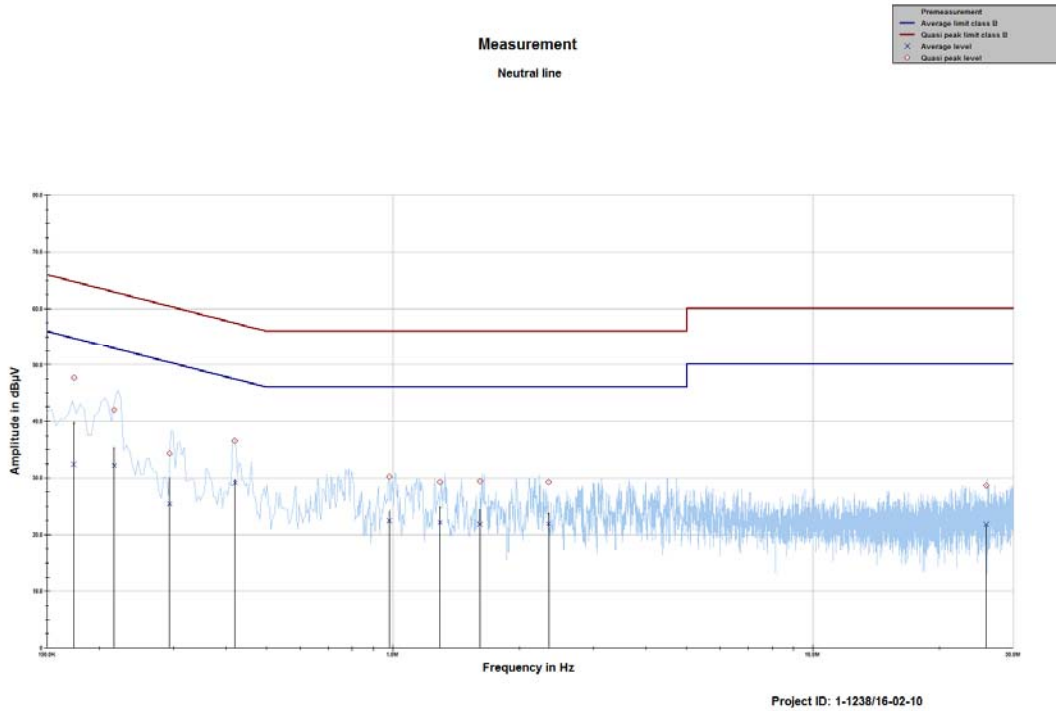

Frequency MHz	Quasi peak level dBµV	Margin quasi peak dB	Limit QP dBµV	Average level dBµV	Margin average dB	Limit AV dBµV
0.173707	47.67	17.11	64.781	32.38	22.94	55.323
0.216556	41.98	20.97	62.950	32.18	21.92	54.098
0.293403	34.32	26.11	60.428	25.44	26.46	51.903
0.420202	36.55	20.90	57.444	29.11	19.17	48.280
0.980523	30.22	25.78	56.000	22.50	23.50	46.000
1.293770	29.24	26.76	56.000	22.09	23.91	46.000
1.610632	29.44	26.56	56.000	21.81	24.19	46.000
2.347577	29.30	26.70	56.000	21.89	24.11	46.000
25.827353	28.64	31.36	60.000	21.85	28.15	50.000

12 Observations

No observations except those reported with the single test cases have been made.

Annex A Document history

Version	Applied changes	Date of release
-	Initial release	2016-10-24
A	Editorial changes	2017-01-04
B	Editorial changes	2017-03-22

Annex B Further information

Glossary

AVG	-	Average
DUT	-	Device under test
EMC	-	Electromagnetic Compatibility
EN	-	European Standard
EUT	-	Equipment under test
ETSI	-	European Telecommunications Standard Institute
FCC	-	Federal Communication Commission
FCC ID	-	Company Identifier at FCC
HW	-	Hardware
IC	-	Industry Canada
Inv. No.	-	Inventory number
N/A	-	Not applicable
PP	-	Positive peak
QP	-	Quasi peak
S/N	-	Serial number
SW	-	Software
PMN	-	Product marketing name
HMN	-	Host marketing name
HVIN	-	Hardware version identification number
FVIN	-	Firmware version identification number

Annex C Accreditation Certificate

first page

last page



Deutsche Akkreditierungsstelle GmbH

Befehlens gemäß § 8 Absatz 1 AkkStelleG i.V.m. § 1 Absatz 1 AkkStelleGBV
Unterzeichnerin der Multilateralen Abkommen
von EA, ILAC und IAF zur gegenseitigen Anerkennung

Akkreditierung



Die Deutsche Akkreditierungsstelle GmbH bestätigt hiermit, dass das Prüflaboratorium

CTC advanced GmbH
Untertürkheimer Straße 6-10, 66117 Saarbrücken

die Kompetenz nach DIN EN ISO/IEC 17025:2005 besitzt, Prüfungen in folgenden Bereichen durchzuführen:

Funk
Mobilfunk (GSM / DCS) + OTA
Elektromagnetische Verträglichkeit (EMV)
Produktsicherheit
SAR / EMF
Umwelt
Smart Card Technology
Bluetooth*
Automotive
Wi-Fi-Services
Kanadische Anforderungen
US-Anforderungen
Akustik
Near Field Communication (NFC)

Die Akkreditierungsurkunde gilt nur in Verbindung mit dem Bescheid vom 25.11.2016 mit der Akkreditierungsnummer D-PL-12076-01 und ist gültig bis 17.01.2018. Sie besteht aus diesem Deckblatt, der Rückseite des Deckblatts und der folgenden Anlage mit insgesamt 63 Seiten.

Registrierungsnummer der Urkunde: D-PL-12076-01-01

Frankfurt, 25.11.2016
Stabschreiber auf der Rückseite

Im Auftrag Dipl.-Ing. Ralf Egner
Abteilungsleiter

Deutsche Akkreditierungsstelle GmbH

Standort Berlin
Spittelmarkt 10
10117 Berlin

Standort Frankfurt am Main
Europa-Allee 52
60327 Frankfurt am Main

Standort Braunschweig
Bundesallee 100
38116 Braunschweig

Die ausstufweise Veröffentlichung der Akkreditierungsurkunde bedarf der vorherigen schriftlichen Zustimmung der Deutsche Akkreditierungsstelle GmbH (DAkkS). Ausgenommen davon ist die separate Weiterverbreitung des Deckblattes durch die umseitig genannte Konformitätsbewertungsstelle in unveränderter Form.

Es darf nicht der Anschein erweckt werden, dass sich die Akkreditierung auch auf Bereiche erstreckt, die über den durch die DAkkS bestätigten Akkreditierungsbereich hinausgehen.

Die Akkreditierung erfolgte gemäß des Gesetzes über die Akkreditierungsstelle (AkkStelleG) vom 31. Juli 2009 (BGBl. I S. 2625) sowie der Verordnung (EG) Nr. 765/2008 des Europäischen Parlaments und des Rates vom 9. Juli 2008 über die Vorschriften für die Akkreditierung und Marktüberwachung im Zusammenhang mit der Vermarktung von Produkten (Abl. L 218 vom 9. Juli 2008, S. 30). Die DAkkS ist Unterzeichnerin der Multilateralen Abkommen zur gegenseitigen Anerkennung der European co-operation for Accreditation (EA), des International Accreditation Forum (IAF) und der International Laboratory Accreditation Cooperation (ILAC). Die Unterzeichner dieser Abkommen erkennen ihre Akkreditierungen gegenseitig an.

Der aktuelle Stand der Mitgliedschaft kann folgenden Webseiten entnommen werden:
EA: www.european-accreditation.org
ILAC: www.ilac.org
IAF: www.iaf.nu

Note:
The current certificate including annex can be received on request.