

FCC TEST REPORT

according to

FCC Rules and Regulations

Part 15 Subpart C

Applicant	Digital Data Communications Asia Co. Ltd
Address	8F No.41 Lane 221 Kang-Ching Rd. Nei-Hu Dis. 114 Taipei Taiwan R.O.C.
Equipment	11g Wireless Broadband Router
Model No.	WBR-3408
FCC ID	ULT540558060901
Trade Name	LevelOne

Laboratory Accreditation



1332

- The test result refers exclusively to the test presented test model / sample.,
- Without written approval of *Exclusive Certification Corp.* the test report shall not be reproduced except in full.
- The EUT is also considered as a kind of computer peripheral, because the connection to computer is necessary for typical use. It has been verified to comply with the requirements of FCC Part 15, Subpart B, Class B (DoC). The test report has been issued separately.

Contents

1. Report of Measurements and Examinations	5
1.1 List of Measurements and Examinations.....	5
2. Test Configuration of Equipment under Test	6
2.1 Feature of Equipment under Test.....	6
2.2 RF Specifications	6
2.3 Test Mode and Test Software.....	7
2.4 Description of Test System.....	7
2.5 Connection Diagram of Test System.....	8
2.6 General Information of Test.....	9
2.7 History of this test report	9
3. Antenna Requirements	10
3.1 Standard Applicable	10
3.2 Antenna Construction and Directional Gain.....	10
4. Test of Conducted Emission	11
4.1 Test Limit.....	11
4.2 Test Procedures.....	11
4.3 Typical Test Setup	12
4.4 Measurement equipment	12
4.5 Test Result and Data.....	13
5. Test of Radiated Emission	18
5.1 Test Limit.....	18
5.2 Test Procedures.....	19
5.3 Typical Test Setup	20
5.4 Measurement equipment	20
5.5 Test Result and Data.....	21
6. 6dB Bandwidth Measurement Data	54
6.1 Test Limit	54
6.2 Test Procedures	54
6.3 Test Setup Layout	54
6.4 Measurement equipment	54
6.5 Test Result and Data.....	54
7. Maximum Peak Output Power	58
7.1 Test Limit	58
7.2 Test Procedures	58
7.3 Test Setup Layout	58
7.4 List of Measuring Equipment Used.....	58
7.5 Test Result and Data.....	58
8. Band Edges Measurement	62
8.1 Test Limit	62
8.2 Test Procedure :	62
8.3 Test Setup Layout	62
8.4 List of Measuring Equipment Used.....	62
8.5 Test Result and Data.....	62
8.6 Restrict band emission Measurement Data.....	67
9. Power Spectral Density	69
9.1 Test Limit	69

9.2	Test Procedures	69
9.3	Test Setup Layout :	69
9.4	List of Measuring Equipment Used	69
9.5	Test Result and Data	69
10.	Restricted Bands of Operation	73
10.1	Labeling Requirement	73
Appendix A.	Photographs of EUT	A1 ~ A8

CERTIFICATE OF COMPLIANCE

according to

FCC Rules and Regulations

Part 15 Subpart C

Applicant	Digital Data Communications Asia Co. Ltd
Address	8F No.41 Lane 221 Kang-Ching Rd. Nei-Hu Dis. 114 Taipei Taiwan R.O.C.
Equipment	11g Wireless Broadband Router
Model No.	WBR-3408
FCC ID	ULT540558060901

I HEREBY CERTIFY THAT :

The measurements shown in this test report were made in accordance with the procedures given in **ANSI C63.4** The equipment was **passed** the test performed according to **FCC Rules and Regulations Part 15 Subpart C (2003)**.

The test was carried out on Dec. 22, 2005 at **Exclusive Certification Corp.**

Signature



Eric Chan / Manager

1. Report of Measurements and Examinations

1.1 List of Measurements and Examinations

FCC Rule	Description of Test	Result
15.203	. Antenna Requirement	Pass
15.207	. Conducted Emission	Pass
15.209	. Radiated Emission	Pass
15.247(a)(2)	. 6dB Bandwidth	Pass
15.247(b)	. Maximum Peak Output Power	Pass
15.247(c)	. 100kHz Bandwidth of Frequency Band Edges	Pass
15.247(d)	. Power Spectral Density	Pass
1.1307 1.1310 2.1091 2.1093	. RF Exposure Compliance	Pass

Test engineer: _____

Jerry

2. Test Configuration of Equipment under Test

2.1 Feature of Equipment under Test

Integrated 802.11g Wireless Access Point

802.11g is an exciting new wireless technology that achieves data rates up to 54Mbps, nearly five times faster than 802.11b.

Works with Both PCs and Mac® Computers

The Router supports a variety of networking environments including Mac® OS 8.x, 9.x, X v10.x, AppleTalk®, Linux®, Windows® 95, 98, Me, NT®, 2000, and XP, and others. All that is needed is an Internet browser and a network adapter that supports TCP/IP (the standard language of the Internet).

Integrated 10/100 4-Port Switch

The Router has a built-in, 4-port network switch to allow your wired computers to share printers, data and MP3 files, digital photos, and much more. The switch features automatic detection so it will adjust to the speed of connected devices.

The switch will transfer data between computers and the Internet simultaneously without interrupting or consuming resources.

2.2 RF Specifications

A) General			
Item	Specification	Item	Specification
Frequency Range	Tx: 2.4 GHz ISM Band (2,412 - 2,462MHz) Rx: 2.4 GHz ISM Band (2,412 - 2,462MHz)	Type of Modulation	CCK and OFDM
Channel Spacing	5MHz	Channel Capacity	54Mbps
B) Receiver			
RF Sensitivity	-72dBm at 54Mbps -80dBm at 11Mbps	Rx Band:	2.412GHz~2.462GHz
C) Transmitter			
RF Output Power	dBm: +14~+16dBm at 54Mbps and +17~+19dBm at 11Mbps	Spurious Emission	FCC 15.247
Frequency Stability	ppm: 40MHz +/- 20ppm	Tx Band:	2.412GHz~2.462GHz
Frequency Deviation Limiting	(2.412GHz~2.462GHz) +/- 20ppm		

2.3 Test Mode and Test Software

The following test mode and test software was performed for conduction and radiation test:

- 802.11b (CH LO: 2412MHz) • 802.11b (CH MID: 2437MHz) • 802.11b (CH HI: 2462MHz)
- 802.11g (CH LO: 2412MHz) • 802.11g (CH MID: 2437MHz) • 802.11g (CH HI: 2462MHz)
- An executive programs, "DutApi_ApDualBand.exe" Application under WIN XP.

The test mode including two kind of power adaptor

- Test Adapter 1: AD-041A5
- Test Adapter 2: MU12-2050200-A1

2.4 Description of Test System

Device	Manufacturer	Model No.	Description
PC	IBM	IGV	Power Cable, Unshielding 1.8 m
Monitor	SlimAGE	510A	Power Cable, Adapter Unshielding 1.8 m Data Cable, VGA shielding 1.35 m
Keyboard	IBM	KB-0225	Data Cable, PS2 shielding 1.85 m
Mouse	IBM	MO28VO	Data Cable, USB shielding 1.85 m
Modem	ACEXX	DM-1414	Power Cable, Adapter Unshielding 1.8 m Data Cable, RS232 Unshielding 1.35 m
Printer	HP	Desk Jet400	Power Cable, Adapter Unshielding 1.8 m Data Cable, PRINT Shielding 1.6 m

Use Cable:

Cable	Description
RJ-45	Unshielding, 0.5m

2.5 Connection Diagram of Test System

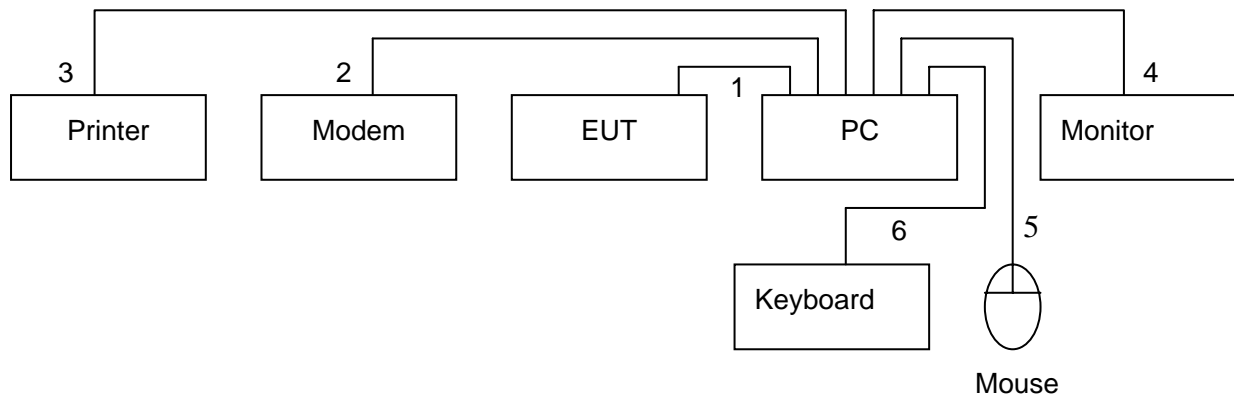

1. The RJ 45 cable is connected from PC to the EUT.
2. The I/O cable is connected from PC to the Modem.
3. The I/O cable is connected from PC to the Printer.
4. The I/O cable is connected from PC to the Monitor.
5. The I/O cable is connected from PC to the Mouse.
6. The I/O cable is connected from PC to the Keyboard.

2.6 General Information of Test

Test Site:	Exclusive Certification Corp. 4F-2, No. 28, Lane 78, Xing-Ai Rd. Nei-hu, Taipei City 114 Taiwan R.O.C.
Test Site Location (OATS1-SD):	No.68-1, Shihbachongsi, shihding Township, Taipei County 223, Taiwan, R.O.C.
Test Voltage:	AC 120V/ 60Hz
Test in Compliance with:	ANSI C63.4-2003 FCC Part 15 Subpart C
Frequency Range Investigated:	Conducted: from 150kHz to 30 MHz Radiation: from 30 MHz to 24620MHz
Test Distance:	The test distance of radiated emission from antenna to EUT is 3 M.

2.7 History of this test report

The Model No.: F5D7230-4 (Report No: CE05121401-A) and Model No. : WBR-3408 (Report No: CE05121401-B) are the same and they only differ from the outside cosmetic. The function and specifications are the same.

3. Antenna Requirements

3.1 Standard Applicable

For intentional device, according to FCC 47 CFR Section 15.203, an intentional radiator shall be designed to ensure that no antenna other than that furnished by the responsible party shall be used with the device.

And according to FCC 47 CFR Section 15.247 (b), if transmitting antennas of directional gain greater than 6dBi are used, the power shall be reduced by the amount in dB that the directional gain of the antenna exceeds 6dBi.

3.2 Antenna Construction and Directional Gain

Antenna type: Integral Dipole Antenna

Antenna Gain: 1.8 dBi.

4. Test of Conducted Emission

4.1 Test Limit

Conducted Emissions were measured from 150 kHz to 30 MHz with a bandwidth of 9 KHz on the 120 VAC power and return leads of the EUT according to the methods defined in ANSI C63.4-2003 Section 3.1. The EUT was placed on a nonmetallic stand in a shielded room 0.8 meters above the ground plane as shown in section 2.2. The interface cables and equipment positioning were varied within limits of reasonable applications to determine the position produced maximum conducted emissions.

Frequency (MHz)	Quasi Peak (dB μ V)	Average (dB μ V)
0.15 – 0.5	66-56*	56-46*
0.5 – 5.0	56	46
5.0 – 30.0	60	50

*Decreases with the logarithm of the frequency.

4.2 Test Procedures

- a. The EUT was placed 0.4 meter from the conducting wall of the shielding room was kept at least 80 centimeters from any other grounded conducting surface.
- b. Connect EUT to the power mains through a line impedance stabilization network (LISN).
- c. All the support units are connecting to the other LISN.
- d. The LISN provides 50 ohm coupling impedance for the measuring instrument.
- e. The FCC states that a 50 ohm, 50 micro-Henry LISN should be used.
- f. Both sides of AC line were checked for maximum conducted interference.
- g. The frequency range from 150 kHz to 30 MHz was searched.
- h. Set the test-receiver system to Peak Detect Function and Specified Bandwidth with Maximum Hold Mode.

4.3 Typical Test Setup

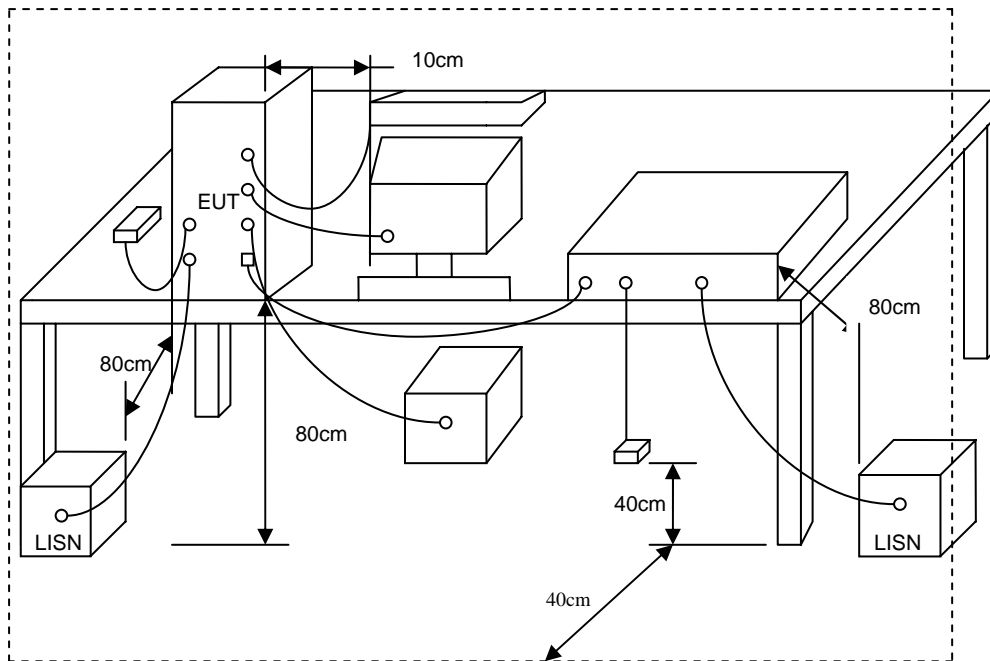

4.4 Measurement equipment

Instrument/Ancillary	Type	Manufacturer	Next Cal. Date
Receiver	SCR3501	Schaffner	2006/11/03
LISN	NNB-2/16Z	MESS TEC	2006/03/30
LISN	NNB-2/16Z	ROLF HEINE	2006/05/01

4.5 Test Result and Data

Test Adapter 1:

EUT : F5D7230-4
 Power : AC 120V
 Test Mode : 802.11g CH1
 Memo : AD-041A5
 Pol/Phase : NEUTRAL
 Temperature : 64 °C
 Humidity : 23 %

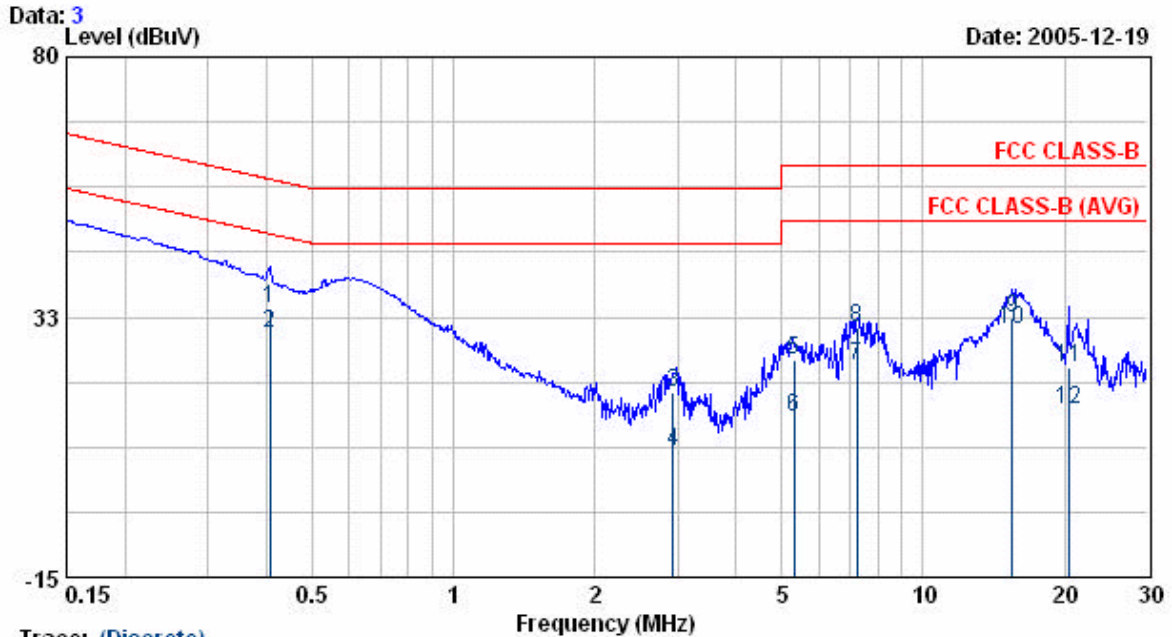

Trace: (Discrete)

Freq MHz	Read Level dBuV	Factor dB	Level dBuV	Limit dBuV	Over Limit dBuV	Remark
0.41	33.53	0.50	34.03	57.73	-23.70	QP
0.41	28.94	0.50	29.44	47.73	-18.29	AVERAGE
2.94	18.24	0.60	18.84	56.00	-37.16	QP
2.94	7.29	0.60	7.89	46.00	-38.11	AVERAGE
5.30	24.22	0.60	24.82	60.00	-35.18	QP
5.30	13.70	0.60	14.30	50.00	-35.70	AVERAGE
7.24	22.89	0.60	23.49	50.00	-26.51	AVERAGE
7.24	29.93	0.60	30.53	60.00	-29.47	QP
15.48	31.37	0.89	32.26	60.00	-27.74	QP
15.48	29.41	0.89	30.30	50.00	-19.70	AVERAGE
20.38	22.44	0.80	23.24	60.00	-36.76	QP
20.38	14.78	0.80	15.58	50.00	-34.42	AVERAGE

- Remarks:
- Level = Read Level + Factor
 - Factor = LISN(ISN) Factor + Cable Loss
 - All emission below 1GHz at 802.11g mode are all the same,so the 802.11g mode chosen as representative in final test.
 - According to technical experiences,all spurious emission of 802.11g mode at channel 1,6,11 are almost the same below 1GHz,so that the channel 1 was chosen as representative in final test.
 - The data is worse case.

EUT : F5D7230-4
 Power : AC 120V
 Test Mode : 802.11g CH1
 Memo : AD-041A5

Pol/Phase : LINE
 Temperature : 64 °C
 Humidity : 23 %

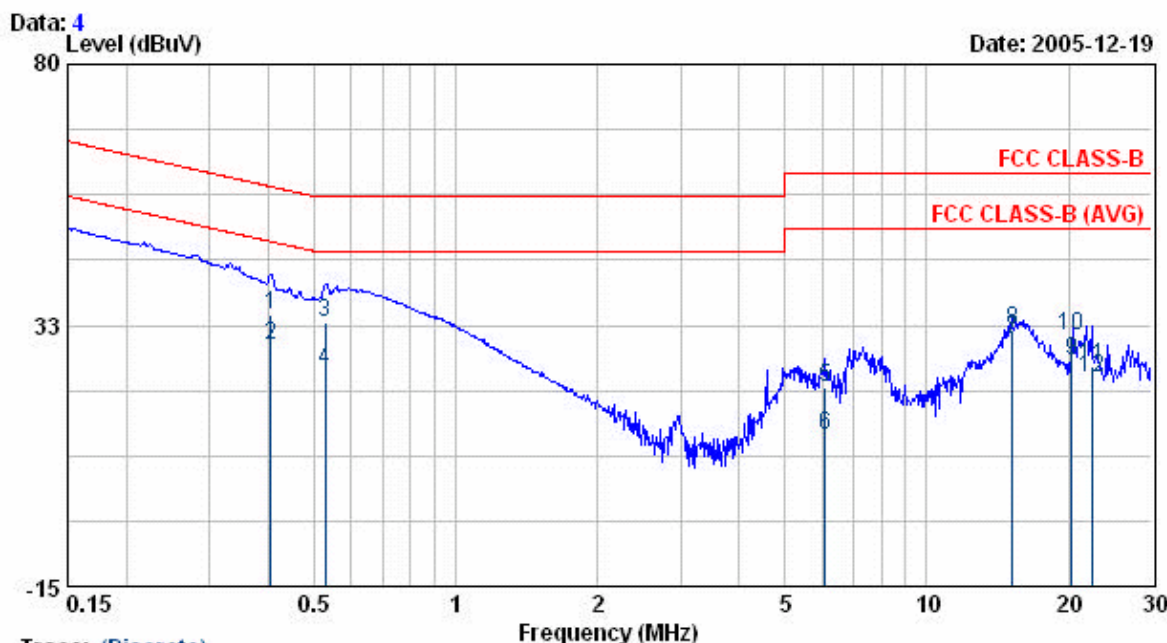

Trace: (Discrete)

Freq	Read Level	Factor	Level	Limit	Over Limit	Remark
MHz	dBuV	dB	dBuV	dBuV	dBuV	
0.40	33.94	0.60	34.54	57.77	-23.23	QP
0.40	28.28	0.60	28.88	47.77	-18.89	AVERAGE
0.53	32.29	0.57	32.86	56.00	-23.14	QP
0.53	23.75	0.57	24.32	46.00	-21.68	AVERAGE
6.08	20.41	0.65	21.06	60.00	-38.94	QP
6.08	11.97	0.65	12.62	50.00	-37.38	AVERAGE
15.18	28.88	0.89	29.77	50.00	-20.23	AVERAGE
15.18	30.82	0.89	31.71	60.00	-28.29	QP
20.33	25.54	0.61	26.15	50.00	-23.85	AVERAGE
20.33	29.82	0.61	30.43	60.00	-29.57	QP
22.50	24.32	0.71	25.03	60.00	-34.97	QP
22.50	22.39	0.71	23.10	50.00	-26.90	AVERAGE

- Remarks:
- Level = Read Level + Factor
 - Factor = LISN(ISN) Factor + Cable Loss
 - All emission below 1GHz at 802.11b/g mode are all the same,so the 802.11g mode chosen as representative in final test.
 - According to technical experiences,all spurious emission of 802.11g mode at channel 1,6,11 are almost the same below 1GHz,so that the channel 1 was chosen as representative in final test.
 - The data is worse case.

Test Adapter 2:

EUT : F5D7230-4
 Power : AC 120V
 Test Mode : 802.11g CH1
 Memo : MV12-2050200-A1

Pol/Phase : NEUTRAL
 Temperature : 64 °C
 Humidity : 23 %

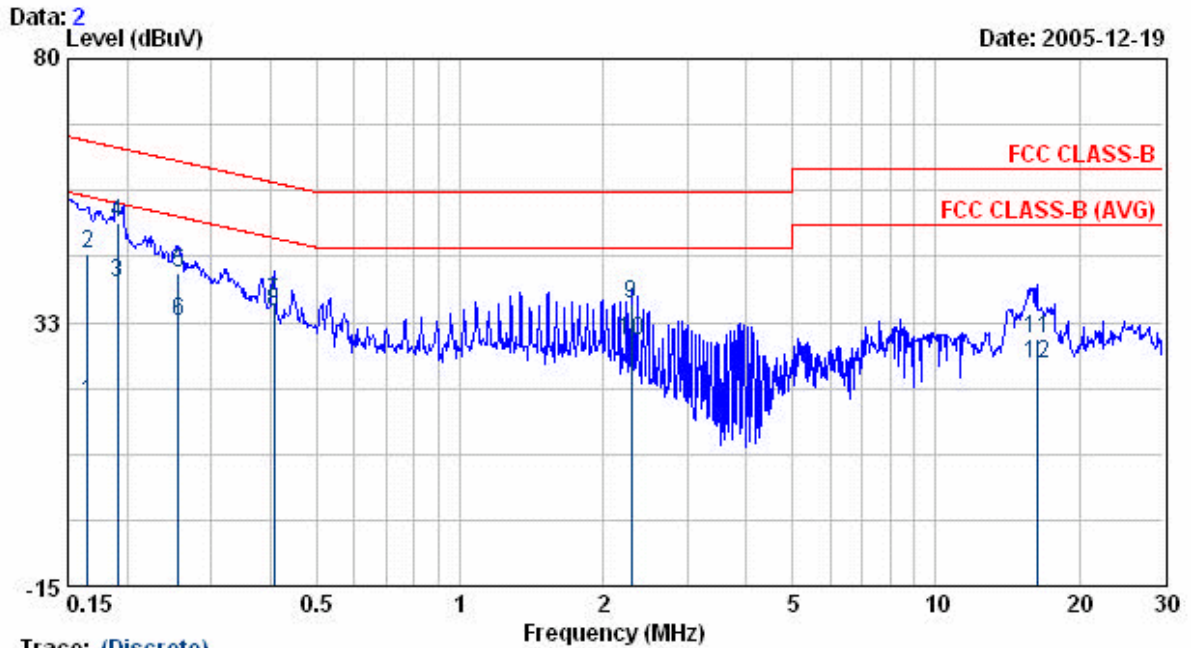

Trace: (Discrete)

Freq	Read Level	Factor	Level	Limit	Over Limit	Remark
MHz	dBuV	dB	dBuV	dBuV	dBuV	
0.17	17.92	0.28	18.20	55.21	-37.01	AVERAGE
0.17	44.40	0.28	44.68	65.21	-20.53	QP
0.19	39.44	0.22	39.66	54.02	-14.36	AVERAGE
0.19	50.11	0.22	50.33	64.02	-13.69	QP
0.26	41.00	0.31	41.31	61.55	-20.25	QP
0.26	32.49	0.31	32.80	51.55	-18.76	AVERAGE
0.41	35.55	0.50	36.05	57.73	-21.68	QP
0.41	33.99	0.50	34.49	47.73	-13.24	AVERAGE
2.29	35.37	0.60	35.97	56.00	-20.03	QP
2.29	28.74	0.60	29.34	46.00	-16.66	AVERAGE
16.27	28.58	0.87	29.45	60.00	-30.55	QP
16.27	24.14	0.87	25.01	50.00	-24.99	AVERAGE

- Remarks:
- Level = Read Level + Factor
 - Factor = LISN(ISN) Factor + Cable Loss
 - All emission below 1GHz at 802.11g mode are all the same,so the 802.11g mode chosen as representative in final test.
 - According to technical experiences,all spurious emission of 802.11g mode at channel 1,6,11 are almost the same below 1GHZ,so that the channel 1 was chosen as representative in final test.
 - The data is worse case.

EUT : F5D7230-4
 Power : AC 120V
 Test Mode : 802.11g CH1
 Memo : MU12-2050200-A1

Pol/Phase : LINE
 Temperature : 64 °C
 Humidity : 23 %

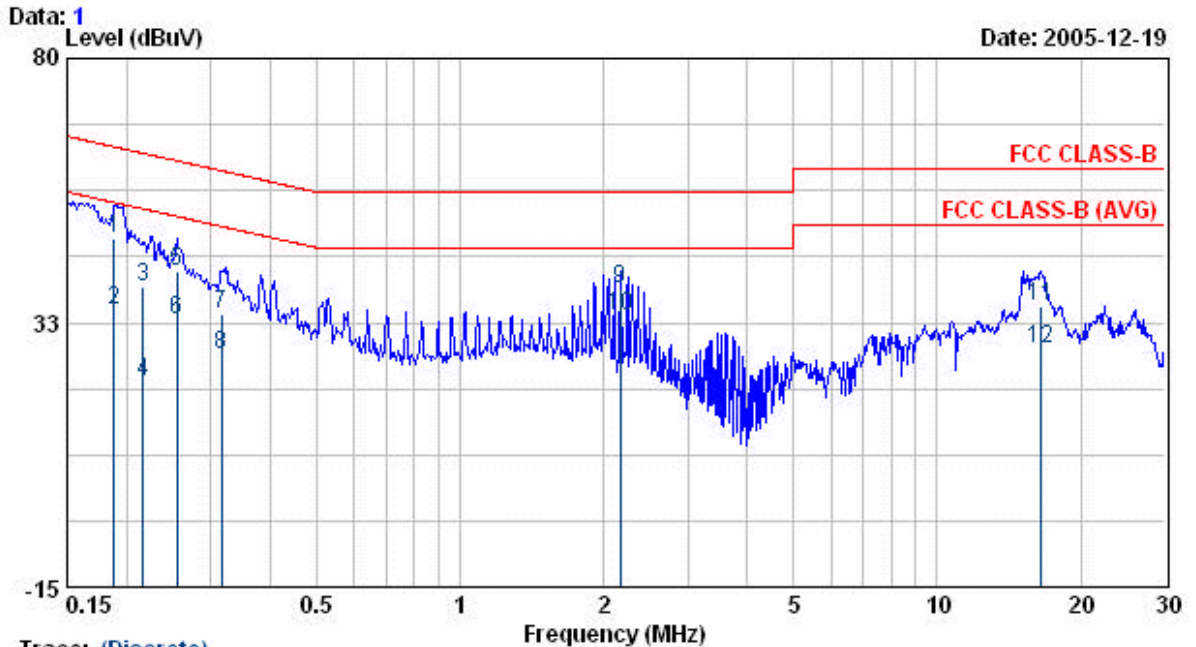

Trace: (Discrete)

Freq	Read Level	Factor	Level	Limit	Over Limit	Remark
MHz	dBuV	dB	dBuV	dBuV	dBuV	
0.19	47.20	0.32	47.52	64.11	-16.59	QP
0.19	34.41	0.32	34.73	54.11	-19.38	AVERAGE
0.22	38.50	0.33	38.83	62.96	-24.12	QP
0.22	21.50	0.33	21.83	52.96	-31.12	AVERAGE
0.25	41.23	0.40	41.63	61.60	-19.96	QP
0.25	32.62	0.40	33.02	51.60	-18.57	AVERAGE
0.32	33.56	0.50	34.06	59.83	-25.77	QP
0.32	26.23	0.50	26.73	49.83	-23.10	AVERAGE
2.17	37.74	0.70	38.44	56.00	-17.56	QP
2.17	32.85	0.70	33.55	46.00	-12.45	AVERAGE
16.56	34.73	0.80	35.53	60.00	-24.47	QP
16.56	26.99	0.80	27.79	50.00	-22.21	AVERAGE

- Remarks:
1. Level = Read Level + Factor
 2. Factor = LISN(ISN) Factor + Cable Loss
 3. All emission below 1GHz at 802.11b/g mode are all the same,so the 802.11g mode chosen as representative in final test.
 4. According to technical experiences,all spurious emission of 802.11g mode at channel 1,6,11 are almost the same below 1GHz,so that the channel 1 was chosen as representative in final test.
 5. The data is worse case.

Ben

Test engineer: _____

5. Test of Radiated Emission

5.1 Test Limit

Radiated emissions from 30 MHz to 25 GHz were measured according to the methods defines in ANSI C63.4-2003. The EUT was placed, 0.8 meter above the ground plane, as shown in section 5.6.3. The interface cables and equipment positions were varied within limits of reasonable applications to determine the positions producing maximum radiated emissions.

For unintentional device, according to § 15.109(a), except for Class A digital devices, the field strength of radiated emissions from unintentional radiators at a distance of 3 meters shall not exceed the following values:

Frequency (MHz)	Distance Meters	Radiated (μ V / M)	Radiated (dB μ V/ M)
30-88	3	100	40.0
88-216	3	150	43.5
216-960	3	200	46.0
Above 960	3	500	54.0

For unintentional device, according to CISPR PUB.22, for Class B digital devices, the general requirement of field strength of radiated emissions from intentional radiators at a distance of 10 meters shall not exceed the above table.

Frequency (MHz)	Distance Meters	Radiated (dB μ V/ M)
30-230	10	30
230-1000	10	37

5.2 Test Procedures

1. The EUT was placed on a rotatable table top 0.8 meter above ground.
2. The EUT was set 3 meters from the interference receiving antenna which was mounted on the top of a variable height antenna tower.
3. The table was rotated 360 degrees to determine the position of the highest radiation.
4. The antenna is a broadband antenna and its height is varied between one meter and four meters above ground to find the maximum value of the field strength both horizontal polarization and vertical polarization of the antenna are set to make the measurement.
5. For each suspected emission the EUT was arranged to its worst case and then tune the antenna tower (from 1 M to 4 M) and turn table (from 0 degree to 360 degrees) to find the maximum reading.
6. Set the test-receiver system to Peak or CISPR quasi-peak Detect Function and specified bandwidth with Maximum Hold Mode.
7. If the emission level of the EUT in peak mode was 3 dB lower than the limit specified, then testing will be stopped and peak values of EUT will be reported, otherwise, the emissions which do not have 3 dB margin will be repeated one by one using the quasi-peak method and reported.
8. For testing above 1GHz, the emission level of the EUT in peak mode was 20dB lower than average limit (that means the emission level in peak mode also complies with the limit in average mode), then testing will be stopped and peak values of EUT will be reported, otherwise, the emissions will be measured in average mode again and reported.

5.3 Typical Test Setup

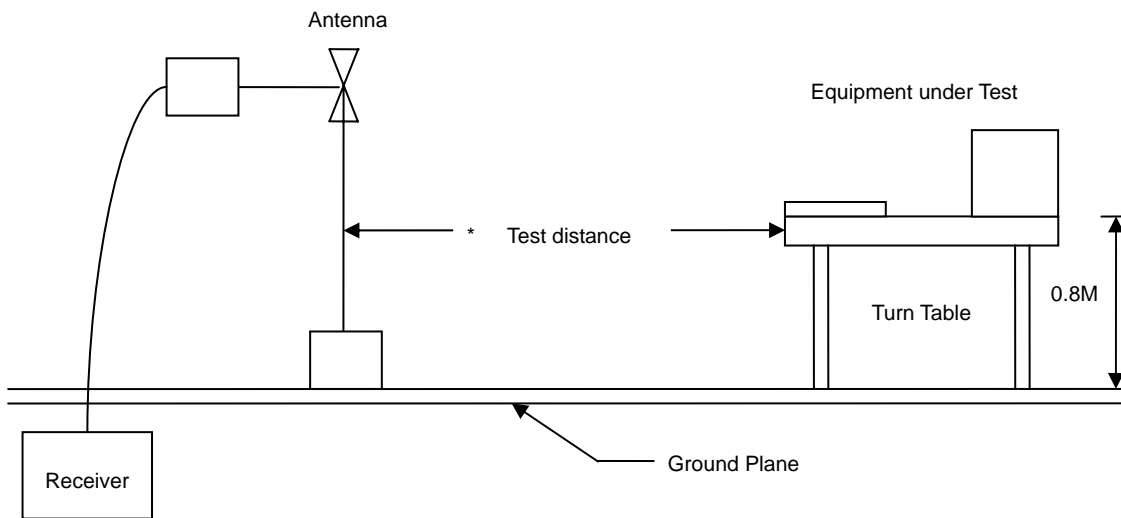

5.4 Measurement equipment

Instrument/Ancillary	Type	Manufacturer	Valid Date
EMI Receiver	8546A	HP	2006/04/13
Spectrum Analyzer	FSP40	R&S	2005/12/28
Horn Antenna	3115	EMCO	2006/02/21
Horn Antenna	3116	EMCO	2006/02/21
Bilog Antenna	CBL6112B	Schaffner	2006/04/11
Amplifier	8447D	Agilent	2006/02/14
Amplifier	8447D	Agilent	2006/02/22

5.5 Test Result and Data

Test Adapter 1:

EUT	: F5D7230-4	Pol/Phase	: HORIZONTAL
Power	: AC 120V	Temperature	: 18 °C
Test Mode	: Transmit/Receive	Humidity	: 54 %
Operation Channel	: 1	Atmospheric Pressure	: 1030 mmHg
Modulation Type	: 802.11g		
Rate	: 54 Mbps		
Memo	: AD-041A5		

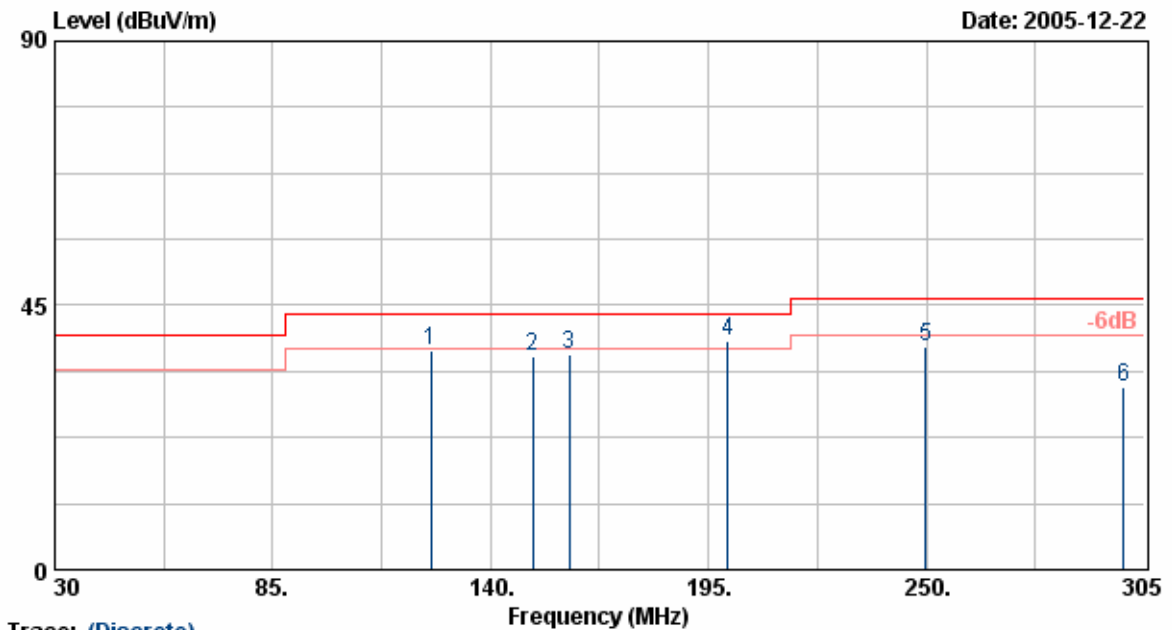

Trace: (Discrete)

Frequency (MHz)	Meter Reading (dBuV)	Corrected Factor (dBuV/m)	Result (dBuV/m)	Limit (dB)	Margin (dB)	Remark	Table Deg.	Ant High (cm)
124.90	53.13	-15.87	37.26	43.50	-6.24	Peak	222	200
150.55	52.39	-15.98	36.41	43.50	-7.09	Peak	60	200
159.98	53.46	-16.77	36.69	43.50	-6.81	Peak	300	200
199.92	56.32	-17.53	38.79	43.50	-4.71	QP	282	200
249.73	51.87	-13.96	37.90	46.00	-8.10	Peak	360	200
299.88	42.68	-11.67	31.00	46.00	-15.00	Peak	360	200

- Notes:
1. Result = Meter Reading + Corrected Factor
 2. Corrected Factor = Antenna Factor + Cable Loss - Amplifier
 3. The resolution bandwidth of test receiver/spectrum analyzer is 120KHz and video bandwidth is 300kHz for Peak detection and Quasi-peak detection at frequency below 1GHz.
 4. All emission below 1GHz at 802.11g mode are all the same,so the 802.11g mode chosen as representative in final test.
 5. According to technical experiences,all spurious emission of 802.11g mode at channel 1,6,11 are almost the same below 1GHz,so that the channel 1 was chosen as representative in final test.
 6. The data is worse case.

EUT : F5D7230-4
 Power : AC 120V
 Test Mode : Transmit/Receive
 Operation Channel: 1
 Modulation Type : 802.11g
 Rate : 54 Mbps
 Memo : AD-041A5
 Pol/Phase : HORIZONTAL
 Temperature : 18 °C
 Humidity : 54 %
 Atmospheric Pressure: 1030 mmHg

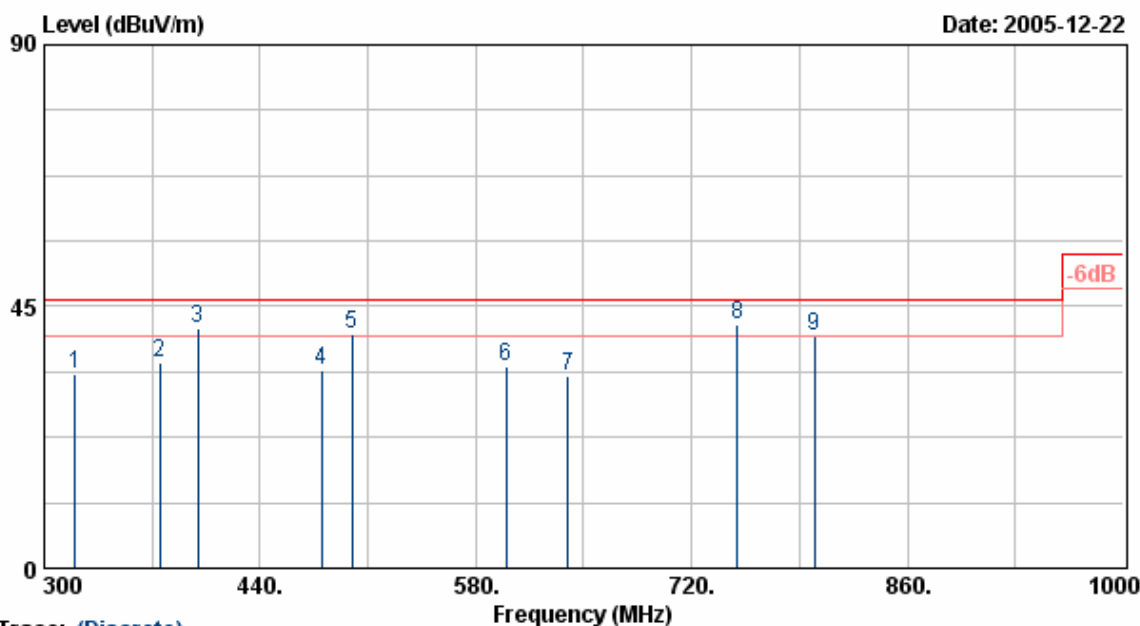

Frequency (MHz)	Meter Reading (dBUV)	Corrected Factor (dBUV/m)	Result (dBUV/m)	Limit (dB)	Margin (dB)	Remark	Table Deg.	Ant High (cm)
319.90	44.79	-11.46	33.34	46.00	-12.66	Peak	80	100
374.90	45.73	-10.35	35.38	46.00	-10.62	Peak	360	100
399.98	50.79	-9.69	41.10	46.00	-4.90	QP	300	100
479.90	42.23	-8.07	34.16	46.00	-11.84	Peak	360	100
499.80	47.83	-7.51	40.32	46.00	-5.68	QP	70	100
599.90	39.76	-5.04	34.72	46.00	-11.28	Peak	300	100
639.80	37.79	-4.81	32.98	46.00	-13.02	Peak	360	100
749.87	43.82	-1.88	41.94	46.00	-4.06	QP	90	100
799.80	42.11	-2.04	40.07	46.00	-5.93	QP	360	100

Notes:

1. Result = Meter Reading + Corrected Factor
2. Corrected Factor = Antenna Factor + Cable Loss - Amplifier
3. The resolution bandwidth of test receiver/spectrum analyzer is 120KHz and video bandwidth is 300kHz for Peak detection and Quasi-peak detection at frequency below 1GHz.
4. All emission below 1GHz at 802.11b/g mode are all the same,so the 802.11g mode chosen as representative in final test.
5. According to technical experiences,all spurious emission of 802.11g mode at channel 1,6,11 are almost the same below 1GHz,so that the channel 1 was chosen as representative in final test.
6. The data is worse case.

EUT : F5D7230-4
 Power : AC 120V
 Test Mode : Transmit/Receive
 Operation Channel : 1
 Modulation Type : 802.11g
 Rate : 54 Mbps
 Memo : AD-041A5
 Pol/Phase : VERTICAL
 Temperature : 18 °C
 Humidity : 54 %
 Atmospheric Pressure : 1030 mmHg

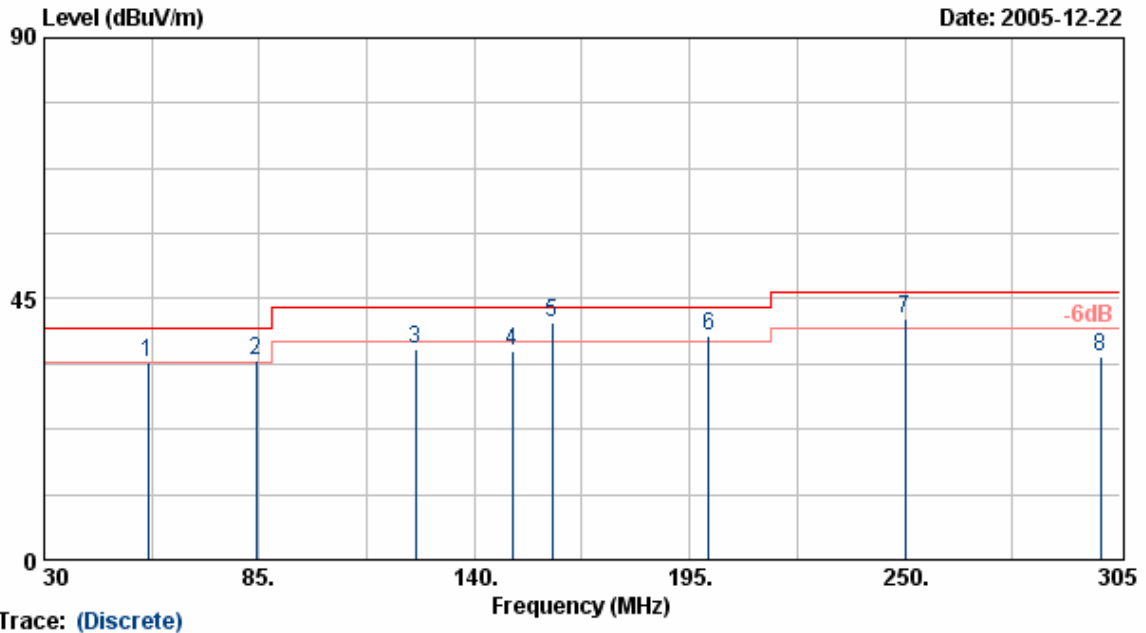

Trace: (Discrete)

Frequency (MHz)	Meter Reading (dBuV)	Corrected Factor (dBuV/m)	Result (dBuV/m)	Limit (dB)	Margin (dB)	Remark	Table Deg.	Ant High (cm)
56.53	55.32	-21.12	34.20	40.00	-5.80	QP	360	100
84.18	53.67	-19.28	34.39	40.00	-5.61	QP	360	100
124.99	52.25	-15.87	36.38	43.50	-7.12	Peak	327	100
149.70	51.76	-15.92	35.84	43.50	-7.66	Peak	217	100
159.98	57.71	-16.77	40.94	43.50	-2.56	QP	184	100
199.96	56.24	-17.53	38.71	43.50	-4.79	QP	0	100
250.00	55.40	-13.92	41.49	46.00	-4.51	QP	66	100
299.99	46.68	-11.67	35.01	46.00	-10.99	Peak	294	100

Notes:

1. Result = Meter Reading + Corrected Factor
2. Corrected Factor = Antenna Factor + Cable Loss - Amplifier
3. The resolution bandwidth of test receiver/spectrum analyzer is 120KHz and video bandwidth is 300kHz for Peak detection and Quasi-peak detection at frequency below 1GHz.
4. All emission below 1GHz at 802.11b/g mode are all the same, so the 802.11g mode chosen as representative in final test.
5. According to technical experiences, all spurious emission of 802.11g mode at channel 1, 6, 11 are almost the same below 1GHz, so that the channel 1 was chosen as representative in final test.
6. The data is worse case.

EUT	: F5D7230-4	Pol/Phase	: VERTICAL
Power	: AC 120V	Temperature	: 18 °C
Test Mode	: Transmit/Receive	Humidity	: 54 %
Operation Channel	: 1	Atmospheric Pressure	: 1030 mmHg
Modulation Type	: 802.11g		
Rate	: 54 Mbps		
Memo	: AD-041A5		

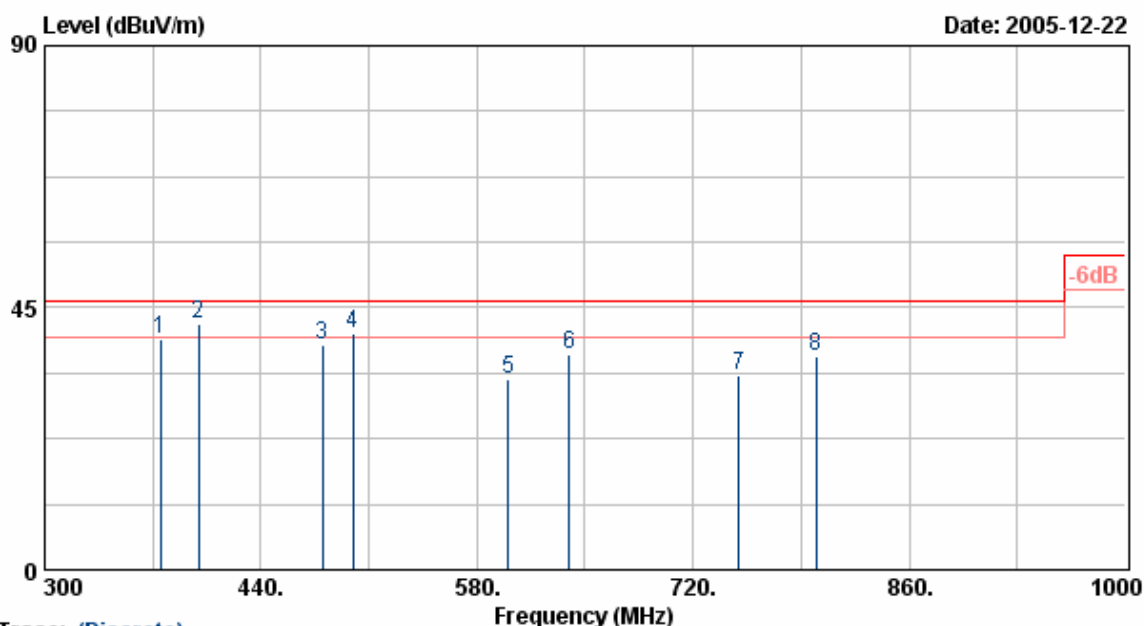

Trace: (Discrete)

Frequency (MHz)	Meter Reading (dBuV)	Corrected Factor (dBuV/m)	Result (dBuV/m)	Limit (dB)	Margin (dB)	Remark	Table Deg.	Ant High (cm)
374.90	49.85	-10.35	39.50	46.00	-6.50	Peak	50	100
399.40	52.03	-9.71	42.32	46.00	-3.68	QP	66	100
479.90	46.53	-8.07	38.46	46.00	-7.54	Peak	220	100
499.80	48.11	-7.51	40.60	46.00	-5.40	QP	0	100
600.40	37.61	-5.04	32.57	46.00	-13.43	Peak	77	100
639.80	41.77	-4.81	36.96	46.00	-9.04	Peak	155	100
749.80	35.36	-1.88	33.48	46.00	-12.52	Peak	0	100
799.80	38.76	-2.04	36.72	46.00	-9.28	Peak	0	100

Notes:

1. Result = Meter Reading + Corrected Factor
2. Corrected Factor = Antenna Factor + Cable Loss - Amplifier
3. The resolution bandwidth of test receiver/spectrum analyzer is 120KHz and video bandwidth is 300kHz for Peak detection and Quasi-peak detection at frequency below 1GHz.
4. All emission below 1GHz at 802.11b/g mode are all the same, so the 802.11g mode chosen as representative in final test.
5. According to technical experiences, all spurious emission of 802.11g mode at channel 1,6,11 are almost the same below 1GHz, so that the channel 1 was chosen as representative in final test.
6. The data is worse case.

EUT : F5D7230-4
 Power : AC 120V
 Test Mode : Transmit/Receive
 Operation Channel : 1
 Modulation Type : 802.11b
 Rate : 11 Mbps
 Memo : AD-041A5
 Pol/Phase : HORIZONTAL
 Temperature : 18 °C
 Humidity : 54 %
 Atmospheric Pressure : 1030 mmHg

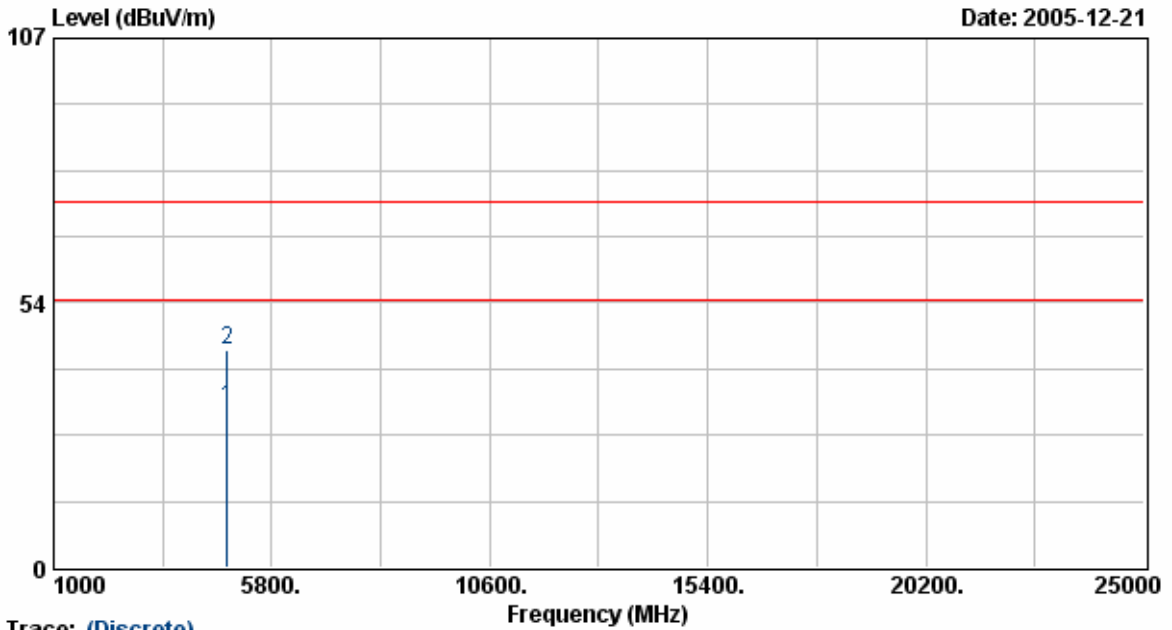

Trace: (Discrete)

Frequency (MHz)	Meter Reading (dBuV)	Corrected Factor (dBuV/m)	Result (dBuV/m)	Limit (dB)	Margin (dB)	Remark	Table Deg.	Ant High (cm)
4823.88	27.42	4.86	32.28	54.00	-21.72	Average	80	100
4823.88	39.25	4.86	44.11	74.00	-29.89	Peak	80	100

Notes:

1. Result = Meter Reading + Corrected Factor
2. Corrected Factor = Antenna Factor + Cable Loss - Amplifier
3. The resolution bandwidth of test receiver/spectrum analyzer is 120KHz and video bandwidth is 300kHz for Peak detection and Quasi-peak detection at frequency below 1GHz.
4. The resolution bandwidth of test receiver/spectrum analyzer is 1MHz and video bandwidth is 3MHz for Peak detection at frequency above 1GHz.
5. The resolution bandwidth of test receiver/spectrum analyzer is 1MHz and video bandwidth is 10Hz for Average detection at frequency above 1GHz.
6. The other emissions is too low to be measured.

EUT : F5D7230-4
 Power : AC 120V
 Test Mode : Transmit/Receive
 Operation Channel : 1
 Modulation Type : 802.11b
 Rate : 11 Mbps
 Memo : AD-041A5
 Pol/Phase : VERTICAL
 Temperature : 18 °C
 Humidity : 54 %
 Atmospheric Pressure : 1030 mmHg

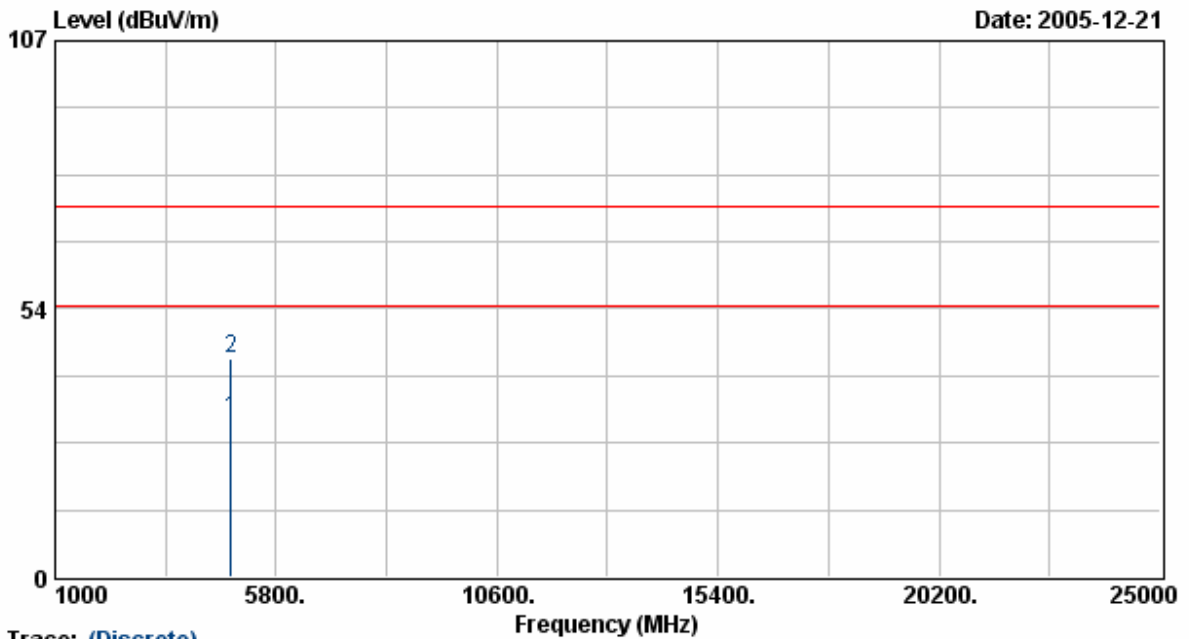

Trace: (Discrete)

Frequency (MHz)	Meter Reading (dBuV)	Corrected Factor (dBuV/m)	Result (dBuV/m)	Limit (dB)	Margin (dB)	Remark	Table Deg.	Ant High (cm)
4823.25	26.67	4.86	31.52	54.00	-22.48	Average	133	100
4823.25	38.53	4.86	43.39	74.00	-30.61	Peak	133	100

Notes:

1. Result = Meter Reading + Corrected Factor
2. Corrected Factor = Antenna Factor + Cable Loss - Amplifier
3. The resolution bandwidth of test receiver/spectrum analyzer is 120KHz and video bandwidth is 300kHz for Peak detection and Quasi-peak detection at frequency below 1GHz.
4. The resolution bandwidth of test receiver/spectrum analyzer is 1MHz and video bandwidth is 3MHz for Peak detection at frequency above 1GHz.
5. The resolution bandwidth of test receiver/spectrum analyzer is 1MHz and video bandwidth is 10Hz for Average detection at frequency above 1GHz.
6. The other emissions is too low to be measured.

```

EUT           : F5D7230-4
Power         : AC 120V
Test Mode     : Transmit/Receive
Operation Channel: 6
Modulation Type : 802.11b
Rate          : 11 Mbps
Memo         : AD-041A5

Pol/Phase     : HORIZONTAL
Temperature   : 18 °C
Humidity      : 54 %
Atmospheric Pressure: 1030 mmHg
    
```

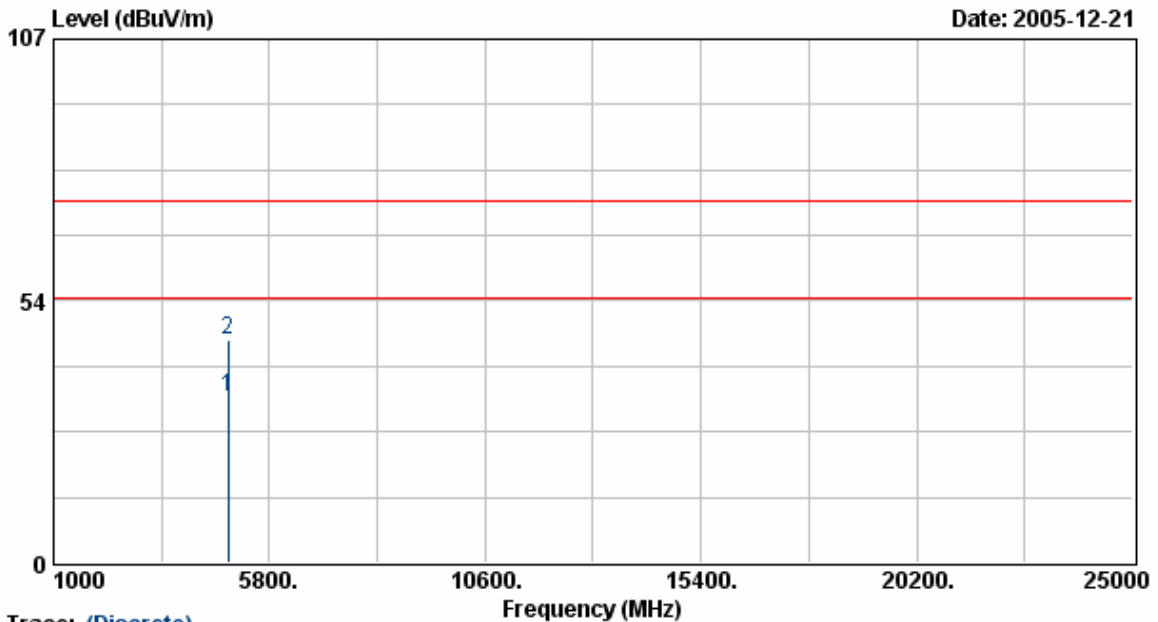

Trace: (Discrete)

Frequency (MHz)	Meter Reading (dBuV)	Corrected Factor (dBuV/m)	Result (dBuV/m)	Limit (dB)	Margin (dB)	Remark	Table Deg.	Ant High (cm)
4873.21	28.73	5.04	33.77	54.00	-20.23	Average	80	100
4873.21	40.42	5.04	45.45	74.00	-28.55	Peak	80	100

Notes:

1. Result = Meter Reading + Corrected Factor
2. Corrected Factor = Antenna Factor + Cable Loss - Amplifier
3. The resolution bandwidth of test receiver/spectrum analyzer is 120KHz and video bandwidth is 300kHz for Peak detection and Quasi-peak detection at frequency below 1GHz.
4. The resolution bandwidth of test receiver/spectrum analyzer is 1MHz and video bandwidth is 3MHz for Peak detection at frequency above 1GHz.
5. The resolution bandwidth of test receiver/spectrum analyzer is 1MHz and video bandwidth is 10Hz for Average detection at frequency above 1GHz.
6. The other emissions is too low to be measured.

EUT	: F5D7230-4	Pol/Phase	: VERTICAL
Power	: AC 120V	Temperature	: 18 °C
Test Mode	: Transmit/Receive	Humidity	: 54 %
Operation Channel	: 6	Atmospheric Pressure	: 1030 mmHg
Modulation Type	: 802.11b		
Rate	: 11 Mbps		
Memo	: AD-041A5		

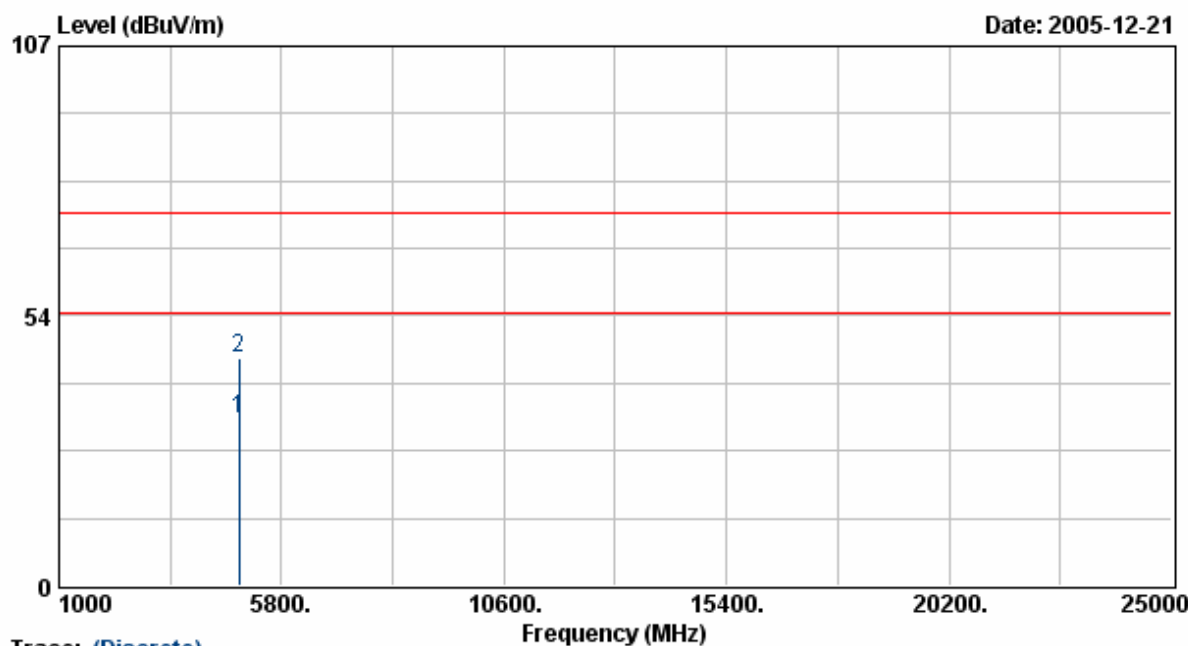

Trace: (Discrete)

Frequency (MHz)	Meter Reading (dBuV)	Corrected Factor (dBuV/m)	Result (dBuV/m)	Limit (dB)	Margin (dB)	Remark	Table Deg.	Ant High (cm)
4873.24	28.12	5.04	33.16	54.00	-20.84	Average	133	100
4873.24	40.26	5.04	45.30	74.00	-28.70	Peak	133	100

Notes:

1. Result = Meter Reading + Corrected Factor
2. Corrected Factor = Antenna Factor + Cable Loss - Amplifier
3. The resolution bandwidth of test receiver/spectrum analyzer is 120KHz and video bandwidth is 300kHz for Peak detection and Quasi-peak detection at frequency below 1GHz.
4. The resolution bandwidth of test receiver/spectrum analyzer is 1MHz and video bandwidth is 3MHz for Peak detection at frequency above 1GHz.
5. The resolution bandwidth of test receiver/spectrum analyzer is 1MHz and video bandwidth is 10Hz for Average detection at frequency above 1GHz.
6. The other emissions is too low to be measured.

EUT	: F5D7230-4	Pol/Phase	: HORIZONTAL
Power	: AC 120V	Temperature	: 18 °C
Test Mode	: Transmit/Receive	Humidity	: 54 %
Operation Channel	: 11	Atmospheric Pressure	: 1030 mmHg
Modulation Type	: 802.11b		
Rate	: 11 Mbps		
Memo	: AD-041A5		

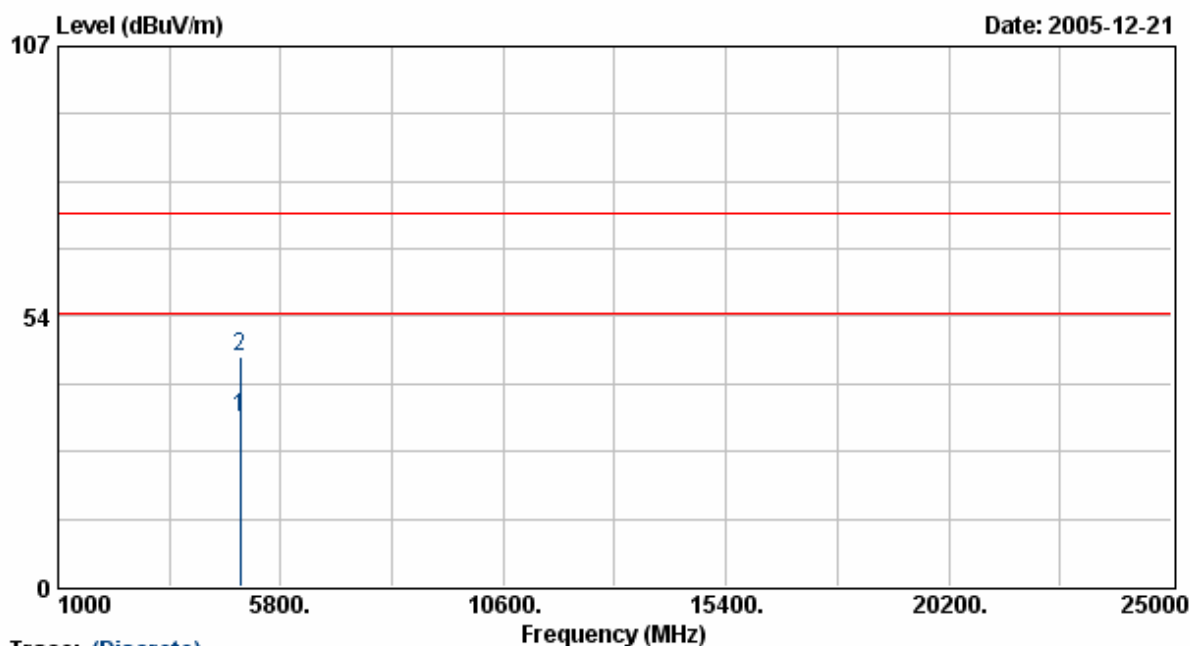

Trace: (Discrete)

Frequency (MHz)	Meter Reading (dBuV)	Corrected Factor (dBuV/m)	Result (dBuV/m)	Limit (dB)	Margin (dB)	Remark	Table Deg.	Ant High (cm)
4924.00	28.37	5.22	33.59	54.00	-20.41	Average	80	100
4924.00	40.37	5.22	45.59	74.00	-28.41	Peak	80	100

Notes:

1. Result = Meter Reading + Corrected Factor
2. Corrected Factor = Antenna Factor + Cable Loss - Amplifier
3. The resolution bandwidth of test receiver/spectrum analyzer is 120KHz and video bandwidth is 300kHz for Peak detection and Quasi-peak detection at frequency below 1GHz.
4. The resolution bandwidth of test receiver/spectrum analyzer is 1MHz and video bandwidth is 3MHz for Peak detection at frequency above 1GHz.
5. The resolution bandwidth of test receiver/spectrum analyzer is 1MHz and video bandwidth is 10Hz for Average detection at frequency above 1GHz.
6. The other emissions is too low to be measured.

EUT : F5D7230-4
 Power : AC 120V
 Test Mode : Transmit/Receive
 Operation Channel : 11
 Modulation Type : 802.11b
 Rate : 11 Mbps
 Memo : AD-041A5
 Pol/Phase : VERTICAL
 Temperature : 18 °C
 Humidity : 54 %
 Atmospheric Pressure: 1030 mmHg

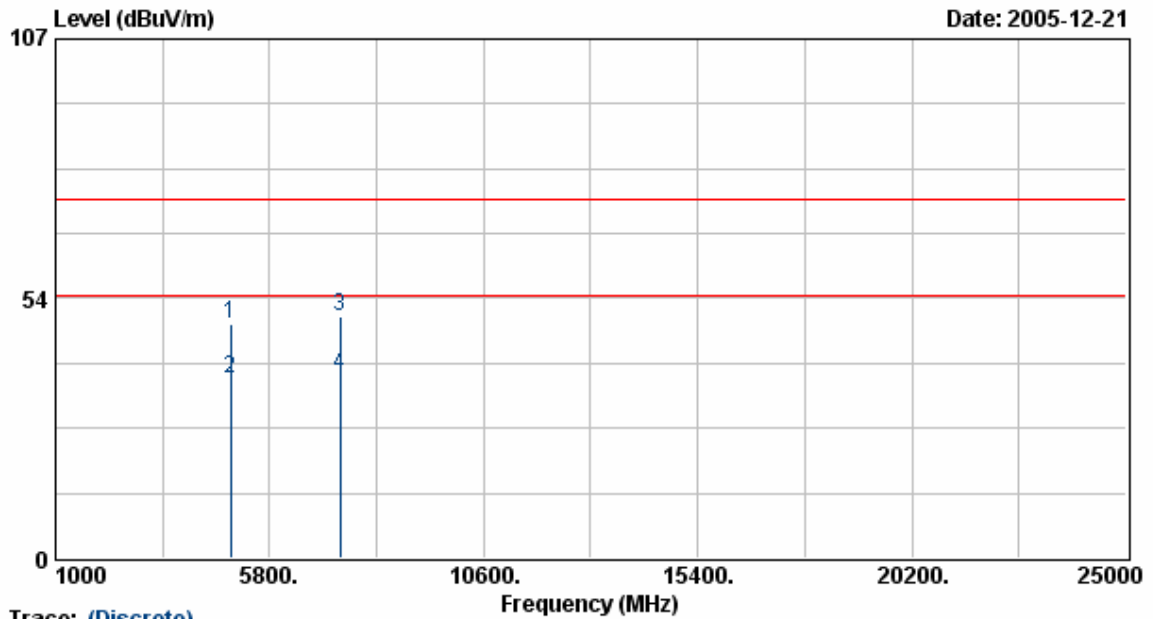

Trace: (Discrete)

Frequency (MHz)	Meter Reading (dBUV)	Corrected Factor (dBUV/m)	Result (dBUV/m)	Limit (dB)	Margin (dB)	Remark	Table Deg.	Ant High (cm)
4927.61	43.19	5.24	48.42	74.00	-25.58	Peak	133	100
4927.61	31.70	5.24	36.94	54.00	-17.06	Average	133	100
7385.47	40.56	9.06	49.62	74.00	-24.38	Peak	133	100
7385.47	28.77	9.06	37.83	54.00	-16.17	Average	133	100

Notes:

1. Result = Meter Reading + Corrected Factor
2. Corrected Factor = Antenna Factor + Cable Loss - Amplifier
3. The resolution bandwidth of test receiver/spectrum analyzer is 120KHz and video bandwidth is 300kHz for Peak detection and Quasi-peak detection at frequency below 1GHz.
4. The resolution bandwidth of test receiver/spectrum analyzer is 1MHz and video bandwidth is 3MHz for Peak detection at frequency above 1GHz.
5. The resolution bandwidth of test receiver/spectrum analyzer is 1MHz and video bandwidth is 10Hz for Average detection at frequency above 1GHz.
6. The other emissions is too low to be measured.

EUT	: F5D7230-4	Pol/Phase	: HORIZONTAL
Power	: AC 120V	Temperature	: 18 °C
Test Mode	: Transmit/Receive	Humidity	: 54 %
Operation Channel	: 1	Atmospheric Pressure	: 1030 mmHg
Modulation Type	: 802.11g		
Rate	: 54 Mbps		
Memo	: AD-041A5		

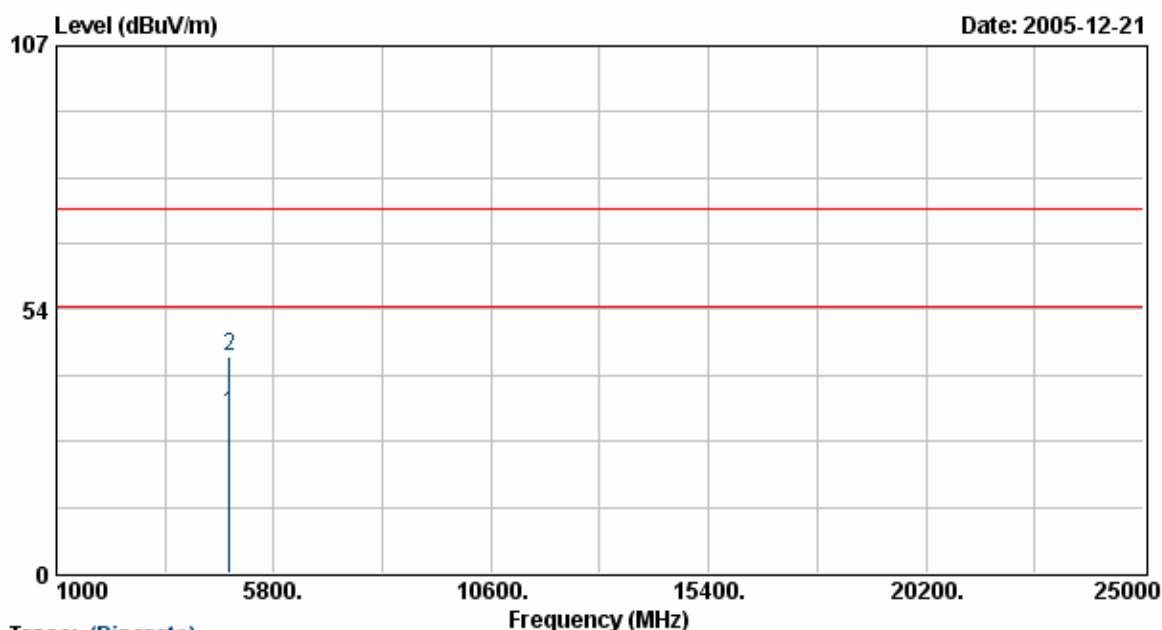

Frequency (MHz)	Meter Reading (dBuV)	Corrected Factor (dBuV/m)	Result (dBuV/m)	Limit (dB)	Margin (dB)	Remark	Table Deg.	Ant High (cm)
4824.00	27.49	4.86	32.35	54.00	-21.65	Average	80	100
4824.00	39.12	4.86	43.98	74.00	-30.02	Peak	80	100

Notes:

1. Result = Meter Reading + Corrected Factor
2. Corrected Factor = Antenna Factor + Cable Loss - Amplifier
3. The resolution bandwidth of test receiver/spectrum analyzer is 120KHz and video bandwidth is 300kHz for Peak detection and Quasi-peak detection at frequency below 1GHz.
4. The resolution bandwidth of test receiver/spectrum analyzer is 1MHz and video bandwidth is 3MHz for Peak detection at frequency above 1GHz.
5. The resolution bandwidth of test receiver/spectrum analyzer is 1MHz and video bandwidth is 10Hz for Average detection at frequency above 1GHz.
6. The other emissions is too low to be measured.

EUT	: F5D7230-4	Pol/Phase	: VERTICAL
Power	: AC 120V	Temperature	: 18 °C
Test Mode	: Transmit/Receive	Humidity	: 54 %
Operation Channel	: 1	Atmospheric Pressure	: 1030 mmHg
Modulation Type	: 802.11g		
Rate	: 54 Mbps		
Memo	: AD-041A5		

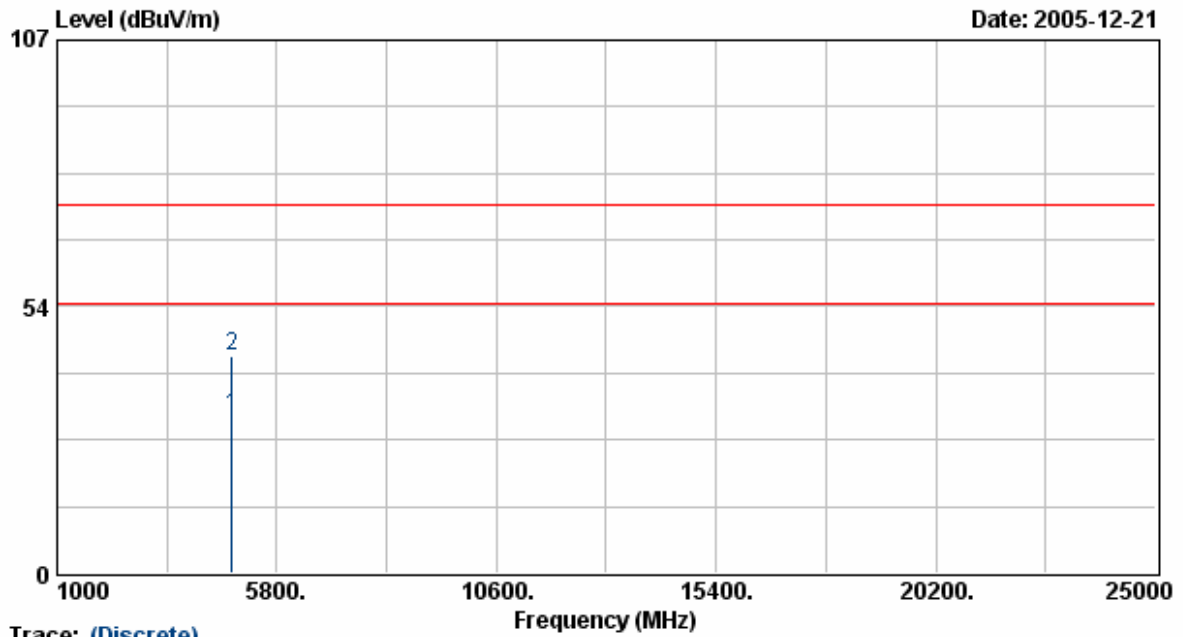

Trace: (Discrete)

Frequency (MHz)	Meter Reading (dBuV)	Corrected Factor (dBuV/m)	Result (dBuV/m)	Limit (dB)	Margin (dB)	Remark	Table Deg.	Ant High (cm)
4824.00	26.65	4.86	31.51	54.00	-22.49	Average	133	100
4824.00	38.73	4.86	43.59	74.00	-30.41	Peak	133	100

Notes:

1. Result = Meter Reading + Corrected Factor
2. Corrected Factor = Antenna Factor + Cable Loss - Amplifier
3. The resolution bandwidth of test receiver/spectrum analyzer is 120KHz and video bandwidth is 300kHz for Peak detection and Quasi-peak detection at frequency below 1GHz.
4. The resolution bandwidth of test receiver/spectrum analyzer is 1MHz and video bandwidth is 3MHz for Peak detection at frequency above 1GHz.
5. The resolution bandwidth of test receiver/spectrum analyzer is 1MHz and video bandwidth is 10Hz for Average detection at frequency above 1GHz.
6. The other emissions is too low to be measured.

EUT	: F5D7230-4	Pol/Phase	: HORIZONTAL
Power	: AC 120V	Temperature	: 18 °C
Test Mode	: Transmit/Receive	Humidity	: 54 %
Operation Channel	: 6	Atmospheric Pressure	: 1030 mmHg
Modulation Type	: 802.11g		
Rate	: 54 Mbps		
Memo	: AD-041A5		

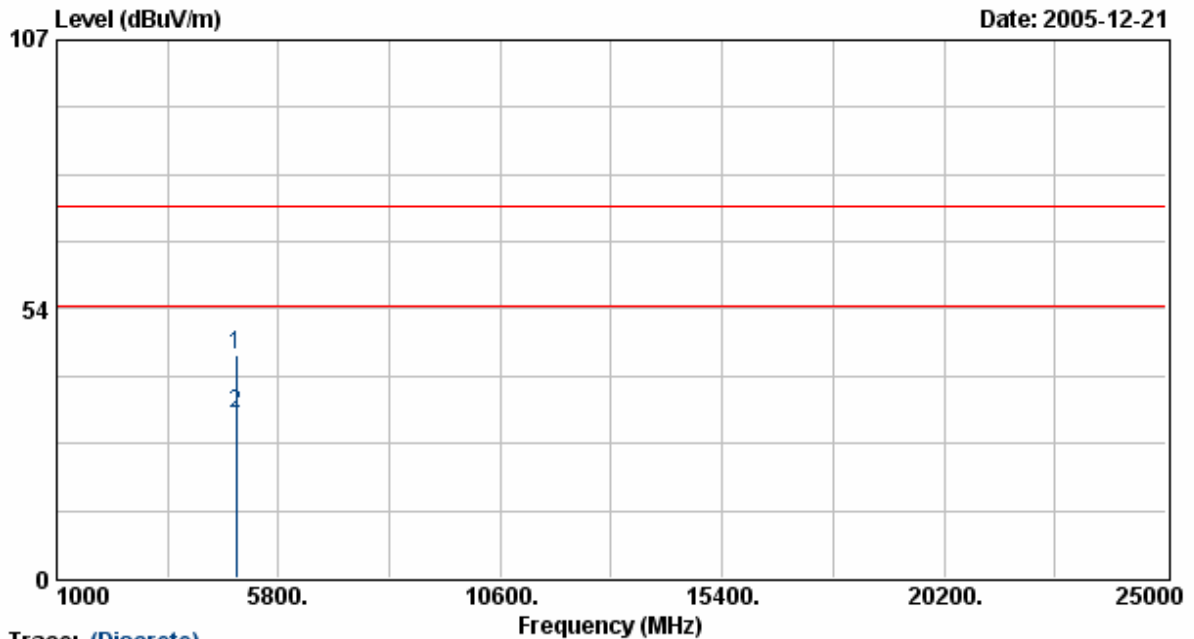

Trace: (Discrete)

Frequency (MHz)	Meter Reading (dBuV)	Corrected Factor (dBuV/m)	Result (dBuV/m)	Limit (dB)	Margin (dB)	Remark	Table Deg.	Ant High (cm)
4874.13	39.16	5.04	44.20	74.00	-29.80	Peak	80	100
4874.13	27.56	5.04	32.60	54.00	-21.40	Average	80	100

Notes:

1. Result = Meter Reading + Corrected Factor
2. Corrected Factor = Antenna Factor + Cable Loss - Amplifier
3. The resolution bandwidth of test receiver/spectrum analyzer is 120KHz and video bandwidth is 300kHz for Peak detection and Quasi-peak detection at frequency below 1GHz.
4. The resolution bandwidth of test receiver/spectrum analyzer is 1MHz and video bandwidth is 3MHz for Peak detection at frequency above 1GHz.
5. The resolution bandwidth of test receiver/spectrum analyzer is 1MHz and video bandwidth is 10Hz for Average detection at frequency above 1GHz.
6. The other emissions is too low to be measured.

EUT	: F5D7230-4	Pol/Phase	: VERTICAL
Power	: AC 120V	Temperature	: 18 °C
Test Mode	: Transmit/Receive	Humidity	: 54 %
Operation Channel	: 6	Atmospheric Pressure	: 1030 mmHg
Modulation Type	: 802.11g		
Rate	: 54 Mbps		
Memo	: AD-041A5		

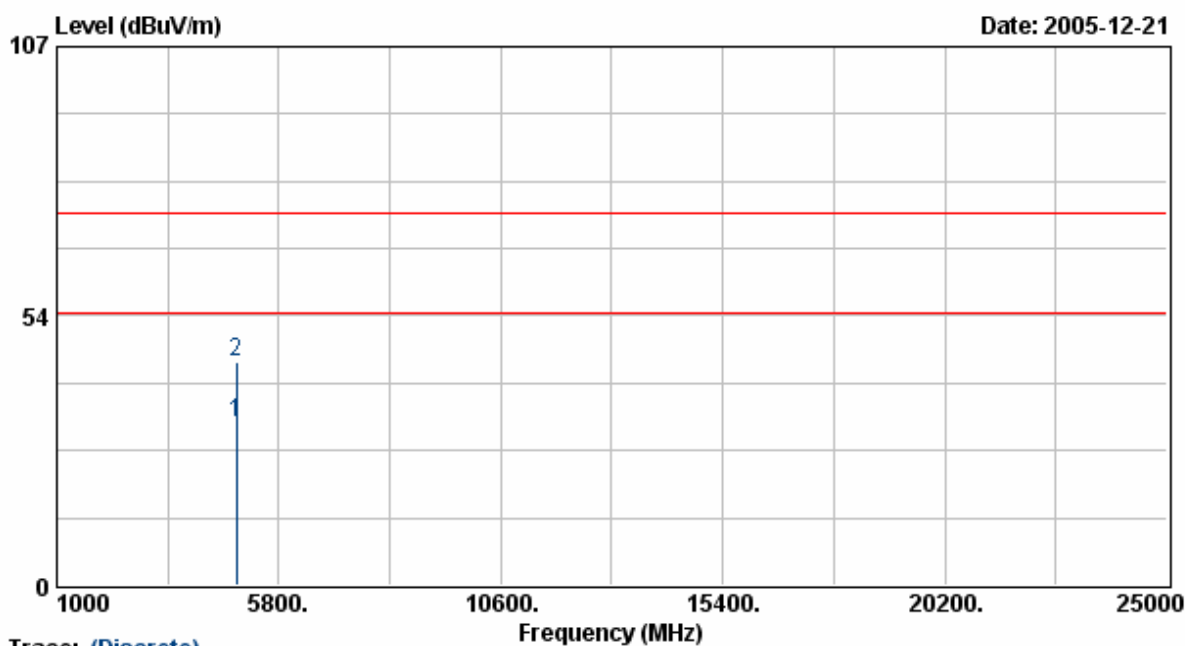

Trace: (Discrete)

Frequency (MHz)	Meter Reading (dBUV)	Corrected Factor (dBUV/m)	Result (dBUV/m)	Limit (dB)	Margin (dB)	Remark	Table Deg.	Ant High (cm)
4874.00	27.22	5.04	32.26	54.00	-21.74	Average	133	100
4874.00	39.35	5.04	44.39	74.00	-29.61	Peak	133	100

Notes:

1. Result = Meter Reading + Corrected Factor
2. Corrected Factor = Antenna Factor + Cable Loss - Amplifier
3. The resolution bandwidth of test receiver/spectrum analyzer is 120KHz and video bandwidth is 300kHz for Peak detection and Quasi-peak detection at frequency below 1GHz.
4. The resolution bandwidth of test receiver/spectrum analyzer is 1MHz and video bandwidth is 3MHz for Peak detection at frequency above 1GHz.
5. The resolution bandwidth of test receiver/spectrum analyzer is 1MHz and video bandwidth is 10Hz for Average detection at frequency above 1GHz.
6. The other emissions is too low to be measured.

EUT : F5D7230-4
 Power : AC 120V
 Test Mode : Transmit/Receive
 Operation Channel: 11
 Modulation Type : 802.11g
 Rate : 54 Mbps
 Memo : AD-041A5
 Pol/Phase : HORIZONTAL
 Temperature : 18 °C
 Humidity : 54 %
 Atmospheric Pressure: 1030 mmHg

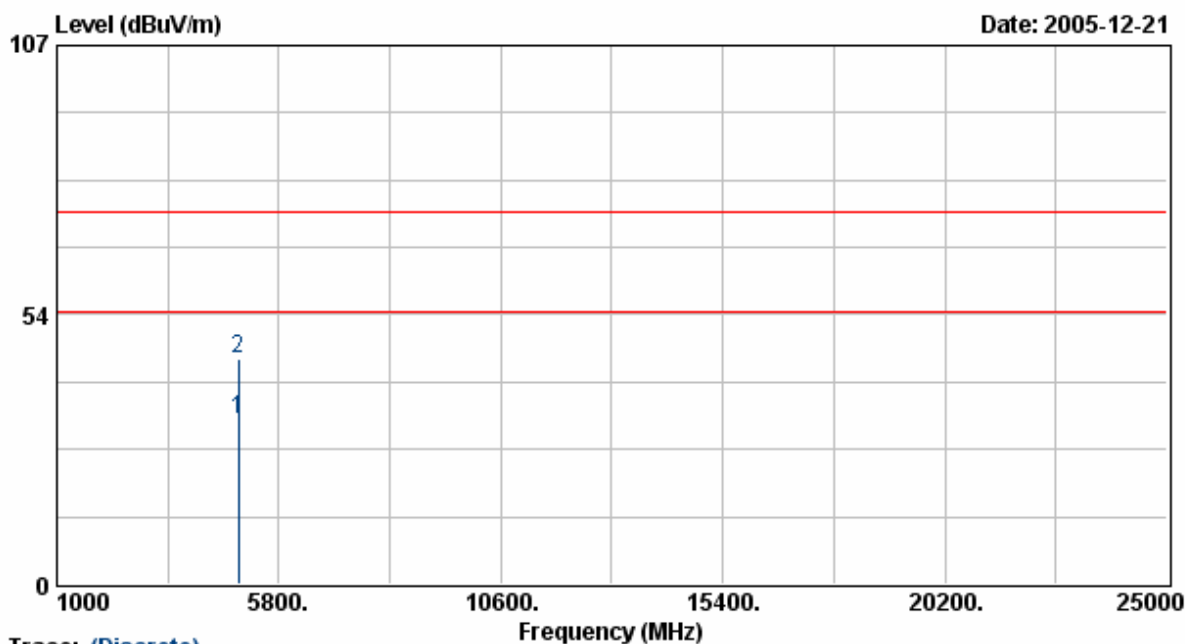

Trace: (Discrete)

Frequency (MHz)	Meter Reading (dBuV)	Corrected Factor (dBuV/m)	Result (dBuV/m)	Limit (dB)	Margin (dB)	Remark	Table Deg.	Ant High (cm)
4923.13	27.42	5.22	32.64	54.00	-21.36	Average	80	100
4923.13	39.65	5.22	44.87	74.00	-29.13	Peak	80	100

Notes:

1. Result = Meter Reading + Corrected Factor
2. Corrected Factor = Antenna Factor + Cable Loss - Amplifier
3. The resolution bandwidth of test receiver/spectrum analyzer is 120KHz and video bandwidth is 300kHz for Peak detection and Quasi-peak detection at frequency below 1GHz.
4. The resolution bandwidth of test receiver/spectrum analyzer is 1MHz and video bandwidth is 3MHz for Peak detection at frequency above 1GHz.
5. The resolution bandwidth of test receiver/spectrum analyzer is 1MHz and video bandwidth is 10Hz for Average detection at frequency above 1GHz.
6. The other emissions is too low to be measured.

EUT	: F5D7230-4	Pol/Phase	: VERTICAL
Power	: AC 120V	Temperature	: 18 °C
Test Mode	: Transmit/Receive	Humidity	: 54 %
Operation Channel	: 11	Atmospheric Pressure	: 1030 mmHg
Modulation Type	: 802.11g		
Rate	: 54 Mbps		
Memo	: AD-041A5		

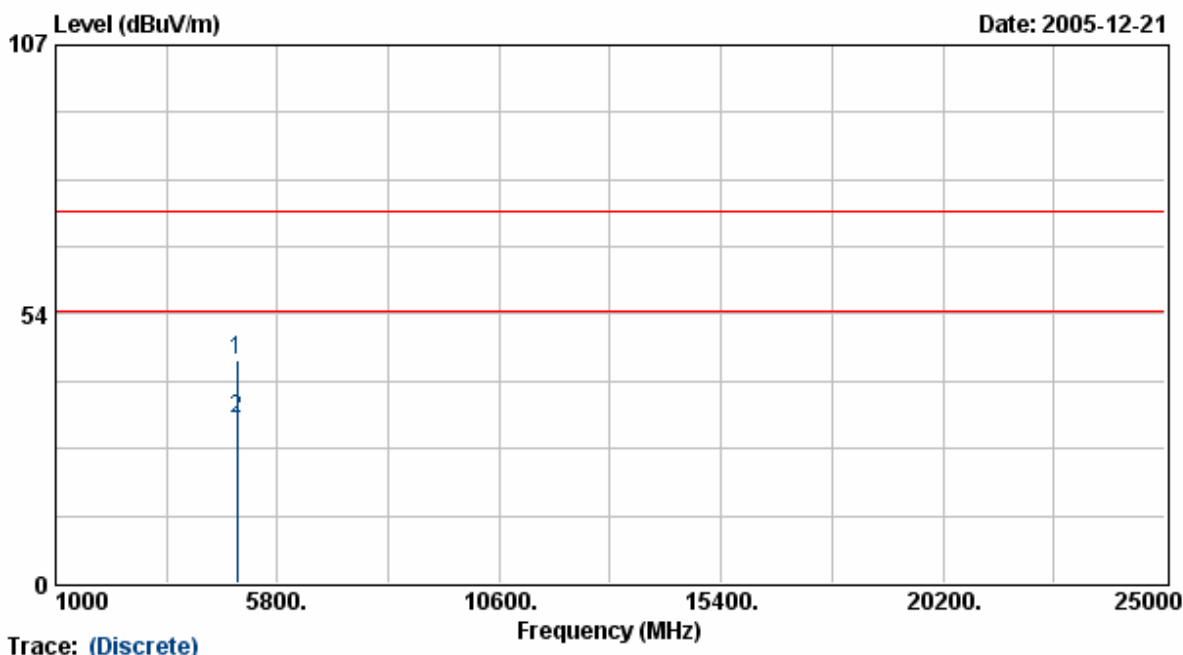

Trace: (Discrete)

Frequency (MHz)	Meter Reading (dBuV)	Corrected Factor (dBuV/m)	Result (dBuV/m)	Limit (dB)	Margin (dB)	Remark	Table Deg.	Ant High (cm)
4925.88	39.21	5.23	44.44	74.00	-29.56	Peak	133	100
4925.88	27.28	5.23	32.51	54.00	-21.49	Average	133	100

Notes:

1. Result = Meter Reading + Corrected Factor
2. Corrected Factor = Antenna Factor + Cable Loss - Amplifier
3. The resolution bandwidth of test receiver/spectrum analyzer is 120KHz and video bandwidth is 300kHz for Peak detection and Quasi-peak detection at frequency below 1GHz.
4. The resolution bandwidth of test receiver/spectrum analyzer is 1MHz and video bandwidth is 3MHz for Peak detection at frequency above 1GHz.
5. The resolution bandwidth of test receiver/spectrum analyzer is 1MHz and video bandwidth is 10Hz for Average detection at frequency above 1GHz.
6. The other emissions is too low to be measured.

Test Adapter 2:

EUT	: F5D7230-4	Pol/Phase	: HORIZONTAL
Power	: AC 120V	Temperature	: 18 °C
Test Mode	: Transmit/Receive	Humidity	: 54 %
Operation Channel	: 1	Atmospheric Pressure	: 1030 mmHg
Modulation Type	: 802.11g		
Rate	: 54 Mbps		
Memo	: MU12-2050200-A1		

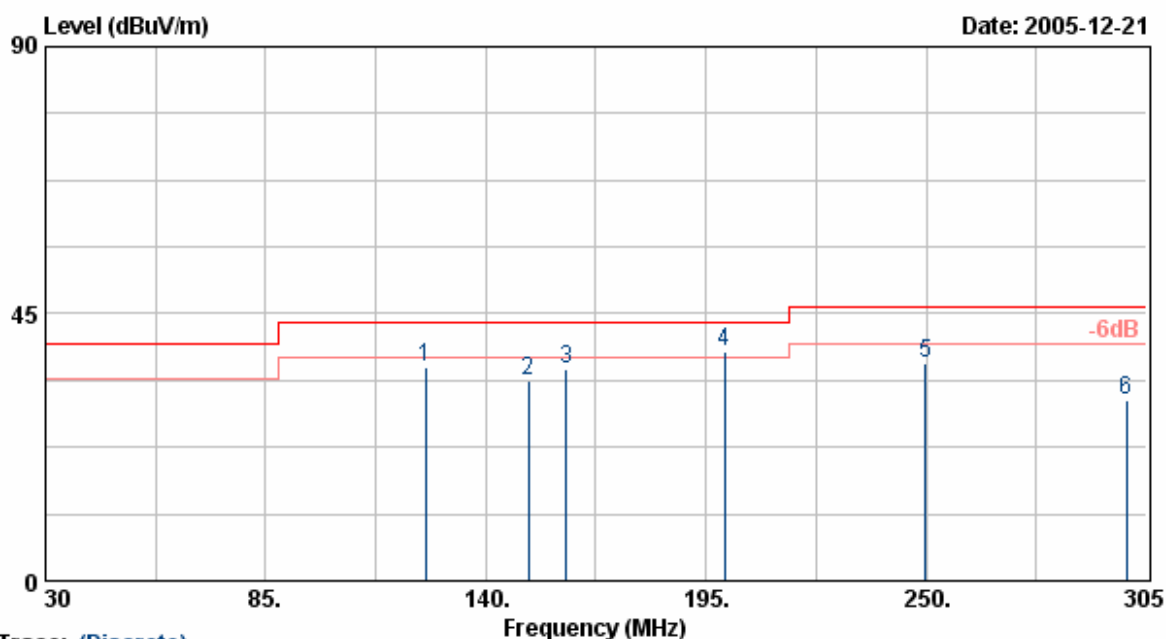

Trace: (Discrete)

Frequency (MHz)	Meter Reading (dBuV)	Corrected Factor (dBuV/m)	Result (dBuV/m)	Limit (dB)	Margin (dB)	Remark	Table Deg.	Ant High (cm)
125.00	51.77	-15.87	35.91	43.50	-7.59	Peak	96	200
150.73	49.56	-15.99	33.57	43.50	-9.93	Peak	20	200
160.08	52.36	-16.78	35.59	43.50	-7.91	Peak	360	200
199.64	56.02	-17.53	38.48	43.50	-5.02	QP	360	200
249.73	50.58	-13.96	36.61	46.00	-9.39	Peak	80	200
300.05	42.22	-11.67	30.55	46.00	-15.45	Peak	150	200

Notes:

1. Result = Meter Reading + Corrected Factor
2. Corrected Factor = Antenna Factor + Cable Loss - Amplifier
3. The resolution bandwidth of test receiver/spectrum analyzer is 120KHz and video bandwidth is 300kHz for Peak detection and Quasi-peak detection at frequency below 1GHz.
4. All emission below 1GHz at 802.11b/g mode are all the same, so the 802.11g mode chosen as representative in final test.
5. According to technical experiences, all spurious emission of 802.11g mode at channel 1, 6, 11 are almost the same below 1GHz, so that the channel 1 was chosen as representative in final test.
6. The data is worse case.

EUT	: F5D7230-4	Pol/Phase	: HORIZONTAL
Power	: AC 120V	Temperature	: 18 °C
Test Mode	: Transmit/Receive	Humidity	: 54 %
Operation Channel	: 1	Atmospheric Pressure	: 1030 mmHg
Modulation Type	: 802.11g		
Rate	: 54 Mbps		
Memo	: MU12-2050200-A1		

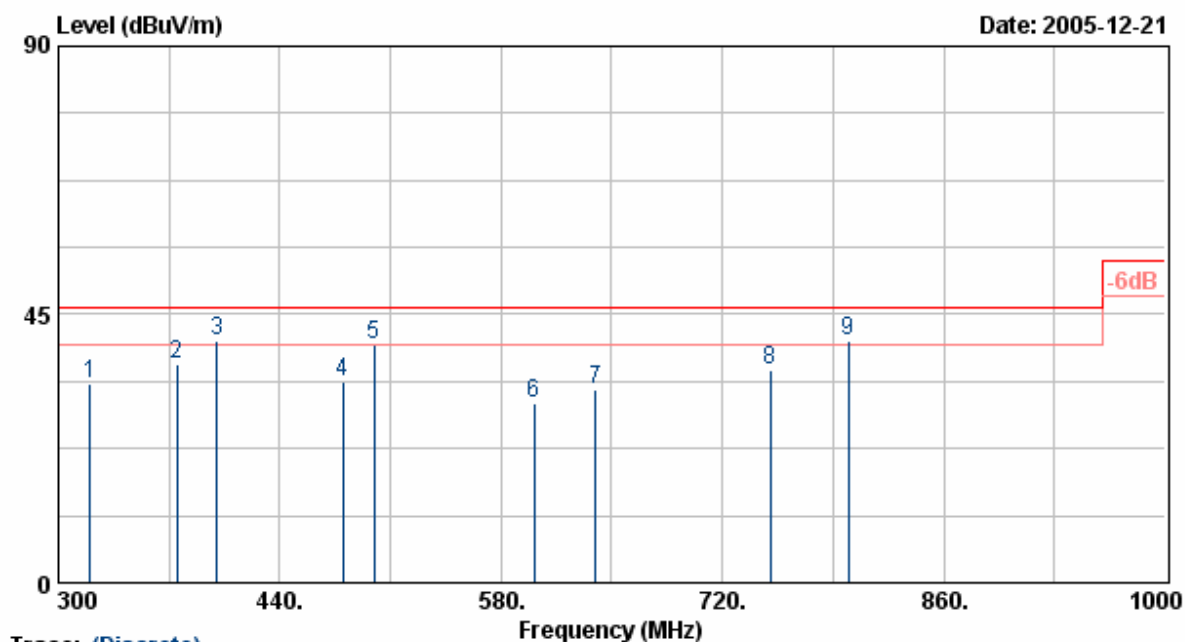

Trace: (Discrete)

Frequency (MHz)	Meter Reading (dBuV)	Corrected Factor (dBuV/m)	Result (dBuV/m)	Limit (dB)	Margin (dB)	Remark	Table Deg.	Ant High (cm)
319.90	44.94	-11.46	33.48	46.00	-12.52	Peak	360	100
374.97	46.97	-10.35	36.63	46.00	-9.37	Peak	80	100
400.01	50.39	-9.69	40.70	46.00	-5.30	QP	256	100
479.90	41.64	-8.07	33.57	46.00	-12.43	Peak	320	100
499.80	47.47	-7.51	39.97	46.00	-6.03	Peak	240	100
600.80	35.16	-5.04	30.12	46.00	-15.88	Peak	45	100
639.80	37.05	-4.81	32.24	46.00	-13.76	Peak	360	100
750.09	37.61	-1.88	35.73	46.00	-10.27	Peak	90	100
799.80	42.55	-2.04	40.51	46.00	-5.49	QP	360	100

Notes:

1. Result = Meter Reading + Corrected Factor
2. Corrected Factor = Antenna Factor + Cable Loss - Amplifier
3. The resolution bandwidth of test receiver/spectrum analyzer is 120KHz and video bandwidth is 300kHz for Peak detection and Quasi-peak detection at frequency below 1GHz.
4. All emission below 1GHz at 802.11g mode are all the same, so the 802.11g mode chosen as representative in final test.
5. According to technical experiences, all spurious emission of 802.11g mode at channel 1, 6, 11 are almost the same below 1GHz, so that the channel 1 was chosen as representative in final test.
6. The data is worse case.

EUT	: F5D7230-4	Pol/Phase	: VERTICAL
Power	: AC 120V	Temperature	: 18 °C
Test Mode	: Transmit/Receive	Humidity	: 54 %
Operation Channel	: 1	Atmospheric Pressure	: 1030 mmHg
Modulation Type	: 802.11g		
Rate	: 54 Mbps		
Memo	: MU12-2050200-A1		

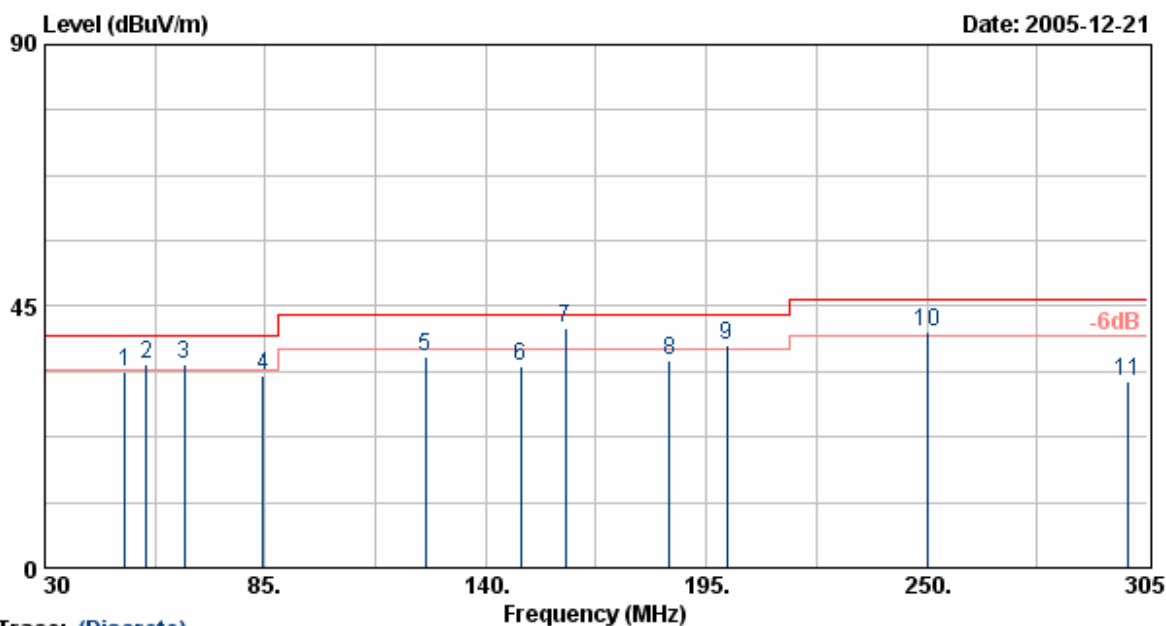

Frequency (MHz)	Meter Reading (dBuV)	Corrected Factor (dBuV/m)	Result (dBuV/m)	Limit (dB)	Margin (dB)	Remark	Table Deg.	Ant High (cm)
50.00	53.39	-19.77	33.62	40.00	-6.38	QP	360	100
55.35	55.92	-20.91	35.01	40.00	-4.99	QP	0	100
64.80	56.94	-21.97	34.98	40.00	-5.02	QP	216	100
84.38	52.30	-19.26	33.04	40.00	-6.96	Peak	79	100
124.99	52.12	-15.87	36.26	43.50	-7.24	Peak	134	100
148.60	50.71	-15.87	34.84	43.50	-8.66	Peak	0	100
159.98	57.88	-16.77	41.11	43.50	-2.39	QP	360	100
185.83	53.43	-17.66	35.78	43.50	-7.72	Peak	0	100
200.01	55.66	-17.53	38.13	43.50	-5.37	QP	360	100
250.02	54.41	-13.91	40.50	46.00	-5.50	QP	360	100
300.05	43.89	-11.67	32.22	46.00	-13.78	Peak	360	100

- Notes:
1. Result = Meter Reading + Corrected Factor
 2. Corrected Factor = Antenna Factor + Cable Loss - Amplifier
 3. The resolution bandwidth of test receiver/spectrum analyzer is 120KHz and video bandwidth is 300kHz for Peak detection and Quasi-peak detection at frequency below 1GHz.
 4. All emission below 1GHz at 802.11b/g mode are all the same,so the 802.11g mode chosen as representative in final test.
 5. According to technical experiences,all spurious emission of 802.11g mode at channel 1,6,11 are almost the same below 1GHz,so that the channel 1 was chosen as representative in final test.
 6. The data is worse case.

EUT	: F5D7230-4	Pol/Phase	: VERTICAL
Power	: AC 120V	Temperature	: 18 °C
Test Mode	: Transmit/Receive	Humidity	: 54 %
Operation Channel	: 1	Atmospheric Pressure	: 1030 mmHg
Modulation Type	: 802.11g		
Rate	: 54 Mbps		
Memo	: MU12-2050200-A1		

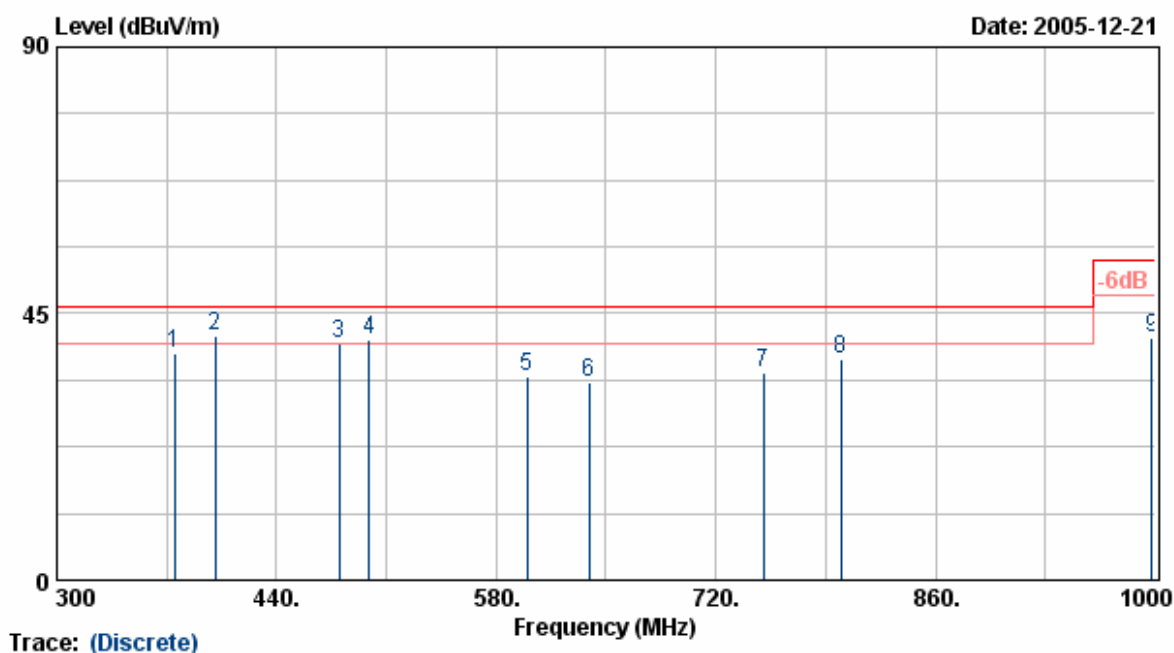

Trace: (Discrete)

Frequency (MHz)	Meter Reading (dBuV)	Corrected Factor (dBuV/m)	Result (dBuV/m)	Limit (dB)	Margin (dB)	Remark	Table Deg.	Ant High (cm)
374.90	48.80	-10.35	38.45	46.00	-7.55	Peak	0	100
400.80	50.99	-9.67	41.31	46.00	-4.69	QP	0	100
479.99	47.90	-8.07	39.83	46.00	-6.17	Peak	55	100
498.80	48.12	-7.54	40.58	46.00	-5.42	QP	110	100
599.90	39.28	-5.04	34.23	46.00	-11.77	Peak	66	100
639.50	38.31	-4.82	33.49	46.00	-12.51	Peak	220	100
750.04	37.00	-1.88	35.13	46.00	-10.87	Peak	300	100
799.99	39.36	-2.04	37.32	46.00	-8.68	Peak	0	100
997.90	38.89	1.94	40.83	54.00	-13.17	Peak	0	100

Notes:

1. Result = Meter Reading + Corrected Factor
2. Corrected Factor = Antenna Factor + Cable Loss - Amplifier
3. The resolution bandwidth of test receiver/spectrum analyzer is 120KHz and video bandwidth is 300kHz for Peak detection and Quasi-peak detection at frequency below 1GHz.
4. All emission below 1GHz at 802.11b/g mode are all the same,so the 802.11g mode chosen as representative in final test.
5. According to technical experiences,all spurious emission of 802.11g mode at channel 1,6,11 are almost the same below 1GHz,so that the channel 1 was chosen as representative in final test.
6. The data is worse case.

EUT : F5D7230-4
 Power : AC 120V
 Test Mode : Transmit/Receive
 Operation Channel : 1
 Modulation Type : 802.11b
 Rate : 11 Mbps
 Memo : MU12-2050200-A1

Pol/Phase : HORIZONTAL
 Temperature : 18 °C
 Humidity : 54 %
 Atmospheric Pressure: 1030 mmHg

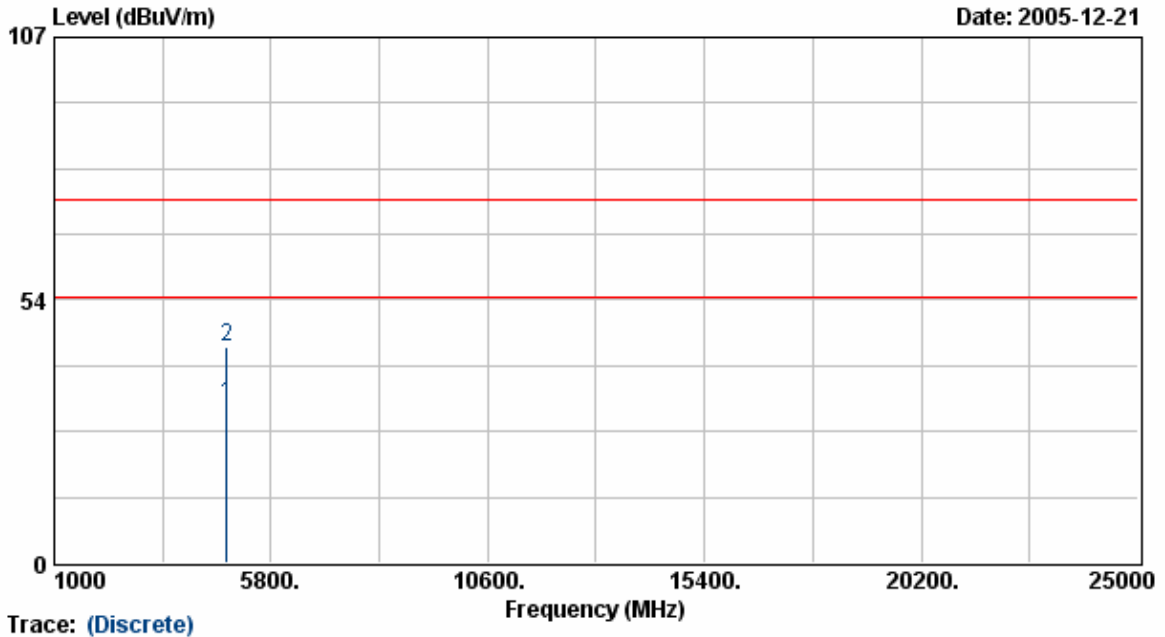

Trace: (Discrete)

Frequency (MHz)	Meter Reading (dBUV)	Corrected Factor (dBUV/m)	Result (dBUV/m)	Limit (dB)	Margin (dB)	Remark	Table Deg.	Ant High (cm)
4823.88	27.54	4.86	32.40	54.00	-21.60	Average	80	100
4823.88	39.13	4.86	43.98	74.00	-30.02	Peak	80	100

Notes:

1. Result = Meter Reading + Corrected Factor
2. Corrected Factor = Antenna Factor + Cable Loss - Amplifier
3. The resolution bandwidth of test receiver/spectrum analyzer is 120KHz and video bandwidth is 300kHz for Peak detection and Quasi-peak detection at frequency below 1GHz.
4. The resolution bandwidth of test receiver/spectrum analyzer is 1MHz and video bandwidth is 3MHz for Peak detection at frequency above 1GHz.
5. The resolution bandwidth of test receiver/spectrum analyzer is 1MHz and video bandwidth is 10Hz for Average detection at frequency above 1GHz.
6. The other emissions is too low to be measured.

EUT	: F5D7230-4	Pol/Phase	: VERTICAL
Power	: AC 120V	Temperature	: 18 °C
Test Mode	: Transmit/Receive	Humidity	: 54 %
Operation Channel	: 1	Atmospheric Pressure	: 1030 mmHg
Modulation Type	: 802.11b		
Rate	: 11 Mbps		
Memo	: MU12-2050200-A1		

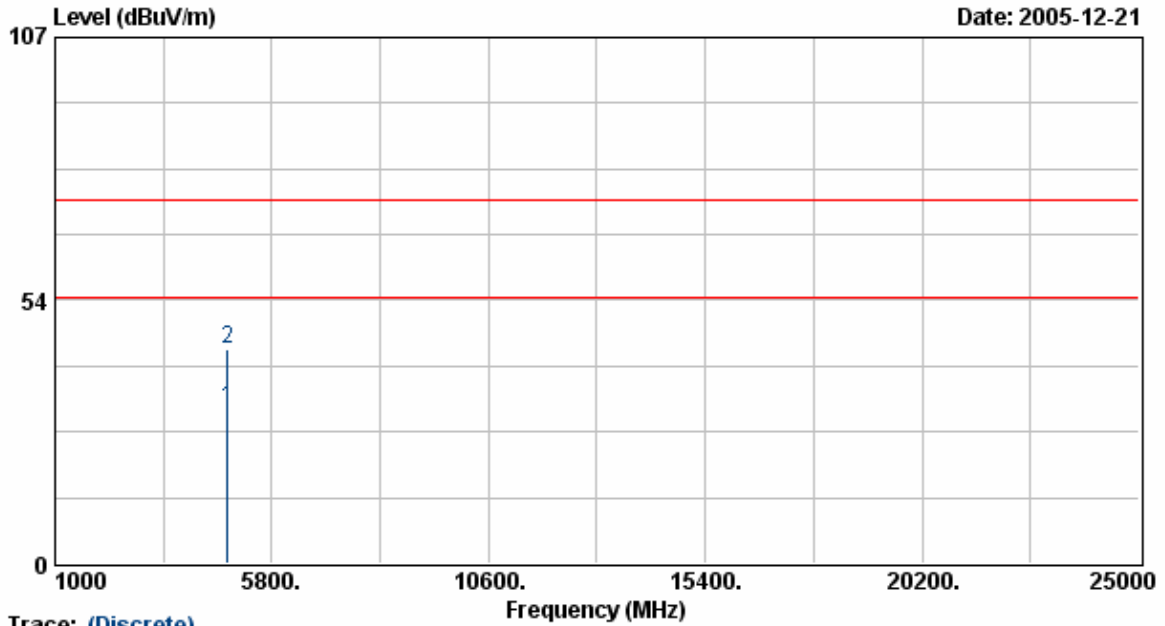

Trace: (Discrete)

Frequency (MHz)	Meter Reading (dBuV)	Corrected Factor (dBuV/m)	Result (dBuV/m)	Limit (dB)	Margin (dB)	Remark	Table Deg.	Ant High (cm)
4823.25	26.78	4.86	31.63	54.00	-22.37	Average	133	100
4823.25	38.88	4.86	43.73	74.00	-30.27	Peak	133	100

- Notes:
1. Result = Meter Reading + Corrected Factor
 2. Corrected Factor = Antenna Factor + Cable Loss - Amplifier
 3. The resolution bandwidth of test receiver/spectrum analyzer is 120KHz and video bandwidth is 300kHz for Peak detection and Quasi-peak detection at frequency below 1GHz.
 4. The resolution bandwidth of test receiver/spectrum analyzer is 1MHz and video bandwidth is 3MHz for Peak detection at frequency above 1GHz.
 5. The resolution bandwidth of test receiver/spectrum analyzer is 1MHz and video bandwidth is 10Hz for Average detection at frequency above 1GHz.
 6. The other emissions is too low to be measured.

EUT	: F5D7230-4	Pol/Phase	: HORIZONTAL
Power	: AC 120V	Temperature	: 18 °C
Test Mode	: Transmit/Receive	Humidity	: 54 %
Operation Channel	: 6	Atmospheric Pressure	: 1030 mmHg
Modulation Type	: 802.11b		
Rate	: 11 Mbps		
Memo	: MU12-2050200-A1		

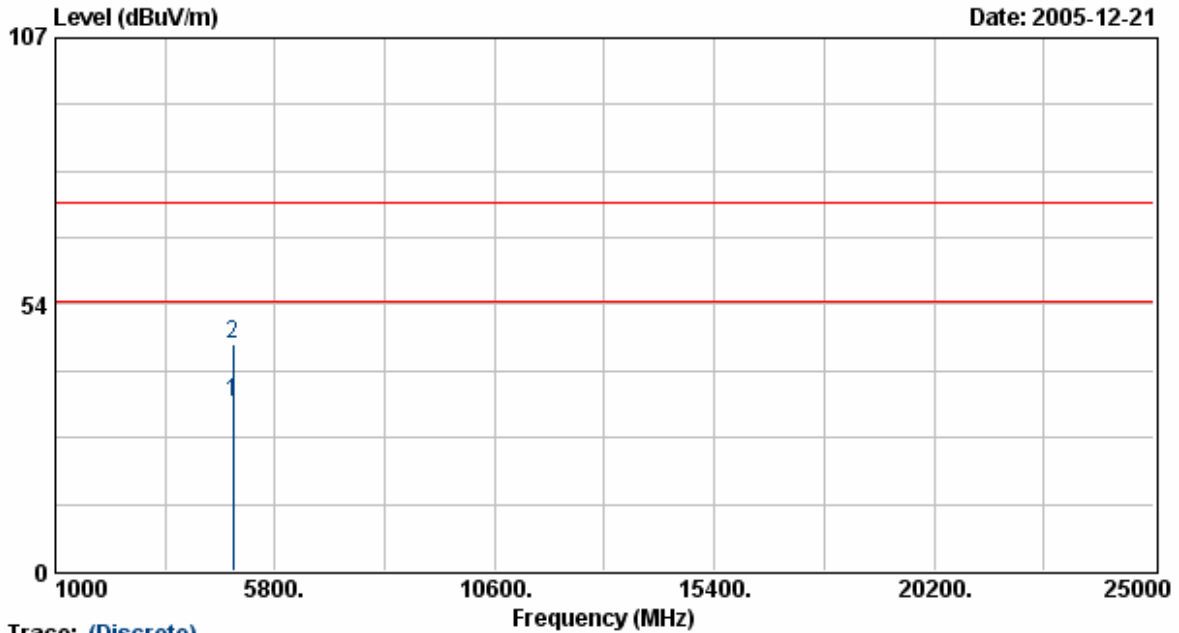

Trace: (Discrete)

Frequency (MHz)	Meter Reading (dBuV)	Corrected Factor (dBuV/m)	Result (dBuV/m)	Limit (dB)	Margin (dB)	Remark	Table Deg.	Ant High (cm)
4873.21	28.78	5.04	33.82	54.00	-20.18	Average	80	100
4873.21	40.40	5.04	45.44	74.00	-28.56	Peak	80	100

Notes:

1. Result = Meter Reading + Corrected Factor
2. Corrected Factor = Antenna Factor + Cable Loss - Amplifier
3. The resolution bandwidth of test receiver/spectrum analyzer is 120KHz and video bandwidth is 300kHz for Peak detection and Quasi-peak detection at frequency below 1GHz.
4. The resolution bandwidth of test receiver/spectrum analyzer is 1MHz and video bandwidth is 3MHz for Peak detection at frequency above 1GHz.
5. The resolution bandwidth of test receiver/spectrum analyzer is 1MHz and video bandwidth is 10Hz for Average detection at frequency above 1GHz.
6. The other emissions is too low to be measured.

EUT	: F5D7230-4	Pol/Phase	: VERTICAL
Power	: AC 120V	Temperature	: 18 °C
Test Mode	: Transmit/Receive	Humidity	: 54 %
Operation Channel	: 6	Atmospheric Pressure	: 1030 mmHg
Modulation Type	: 802.11b		
Rate	: 11 Mbps		
Memo	: MU12-2050200-A1		

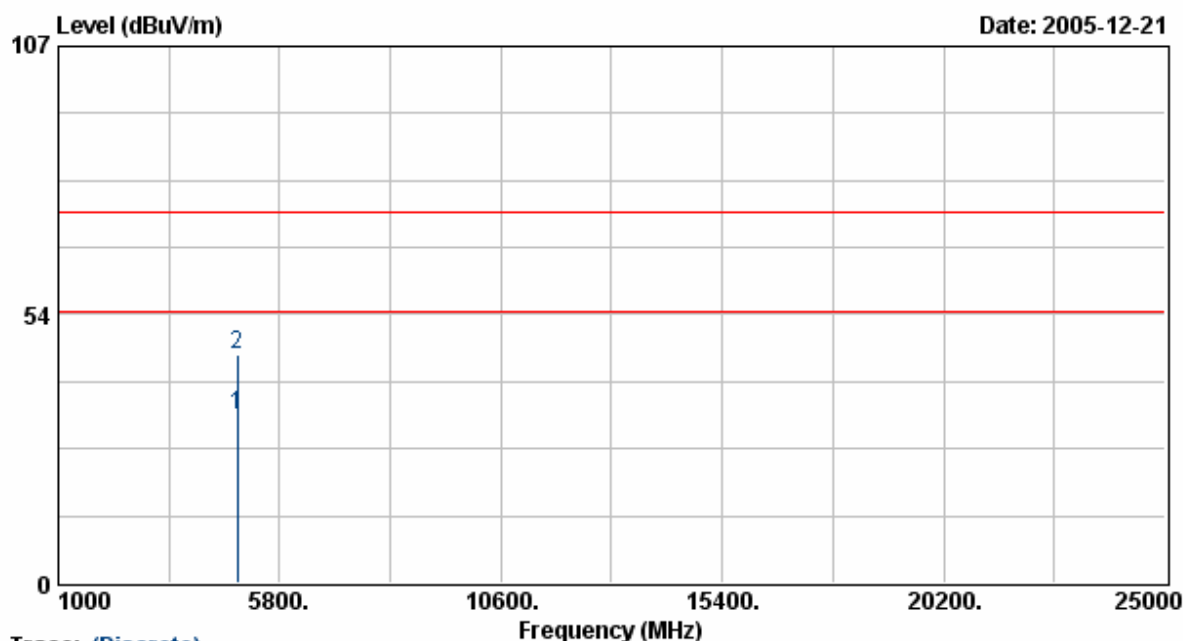

Trace: (Discrete)

Frequency (MHz)	Meter Reading (dBUV)	Corrected Factor (dBUV/m)	Result (dBUV/m)	Limit (dB)	Margin (dB)	Remark	Table Deg.	Ant High (cm)
4873.24	28.61	5.04	33.65	54.00	-20.35	Average	133	100
4873.24	40.47	5.04	45.50	74.00	-28.50	Peak	133	100

Notes:

1. Result = Meter Reading + Corrected Factor
2. Corrected Factor = Antenna Factor + Cable Loss - Amplifier
3. The resolution bandwidth of test receiver/spectrum analyzer is 120KHz and video bandwidth is 300kHz for Peak detection and Quasi-peak detection at frequency below 1GHz.
4. The resolution bandwidth of test receiver/spectrum analyzer is 1MHz and video bandwidth is 3MHz for Peak detection at frequency above 1GHz.
5. The resolution bandwidth of test receiver/spectrum analyzer is 1MHz and video bandwidth is 10Hz for Average detection at frequency above 1GHz.
6. The other emissions is too low to be measured.

EUT	: F5D7230-4	Pol/Phase	: HORIZONTAL
Power	: AC 120V	Temperature	: 18 °C
Test Mode	: Transmit/Receive	Humidity	: 54 %
Operation Channel	: 11	Atmospheric Pressure	: 1030 mmHg
Modulation Type	: 802.11b		
Rate	: 11 Mbps		
Memo	: MU12-2050200-A1		

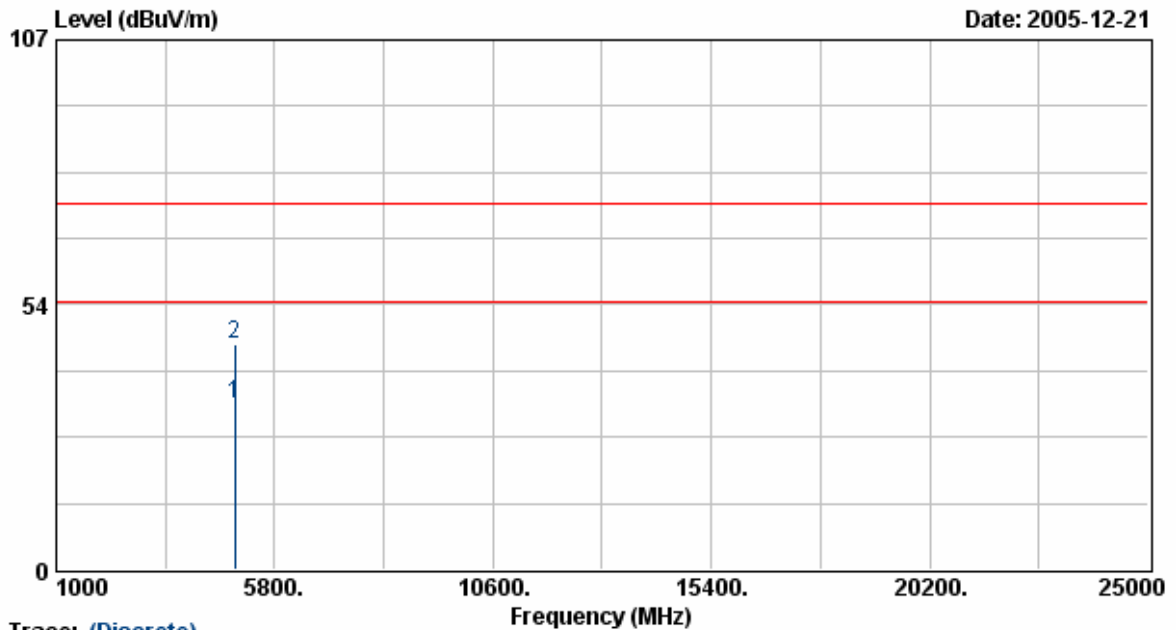

Trace: (Discrete)

Frequency (MHz)	Meter Reading (dBuV)	Corrected Factor (dBuV/m)	Result (dBuV/m)	Limit (dB)	Margin (dB)	Remark	Table Deg.	Ant High (cm)
4924.00	28.40	5.22	33.62	54.00	-20.38	Average	80	100
4924.00	40.34	5.22	45.56	74.00	-28.44	Peak	80	100

Notes:

1. Result = Meter Reading + Corrected Factor
2. Corrected Factor = Antenna Factor + Cable Loss - Amplifier
3. The resolution bandwidth of test receiver/spectrum analyzer is 120KHz and video bandwidth is 300kHz for Peak detection and Quasi-peak detection at frequency below 1GHz.
4. The resolution bandwidth of test receiver/spectrum analyzer is 1MHz and video bandwidth is 3MHz for Peak detection at frequency above 1GHz.
5. The resolution bandwidth of test receiver/spectrum analyzer is 1MHz and video bandwidth is 10Hz for Average detection at frequency above 1GHz.
6. The other emissions is too low to be measured.

EUT : F5D7230-4
 Power : AC 120V
 Test Mode : Transmit/Receive
 Operation Channel: 11
 Modulation Type : 802.11b
 Rate : 11 Mbps
 Memo : MU12-2050200-A1

Pol/Phase : VERTICAL
 Temperature : 18 °C
 Humidity : 54 %
 Atmospheric Pressure: 1030 mmHg

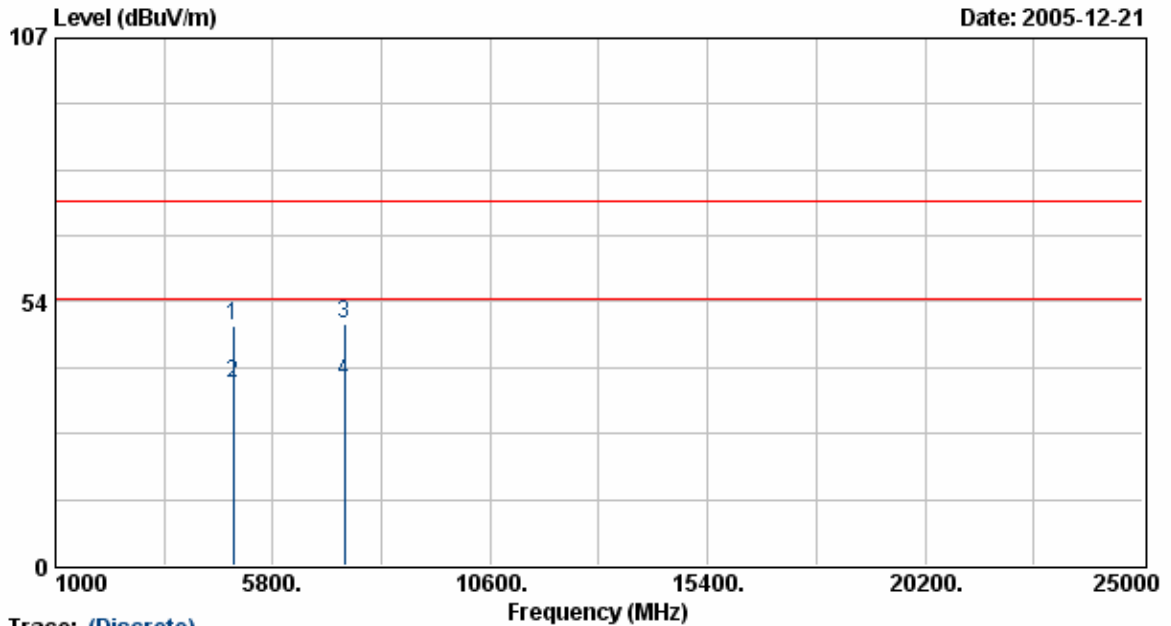

Trace: (Discrete)

Frequency (MHz)	Meter Reading (dBuV)	Corrected Factor (dBuV/m)	Result (dBuV/m)	Limit (dB)	Margin (dB)	Remark	Table Deg.	Ant High (cm)
4927.61	43.44	5.24	48.68	74.00	-25.32	Peak	133	100
4927.61	31.88	5.24	37.12	54.00	-16.88	Average	133	100
7385.47	40.16	9.06	49.22	74.00	-24.78	Peak	133	100
7385.47	28.34	9.06	37.40	54.00	-16.60	Average	133	100

- Notes:
1. Result = Meter Reading + Corrected Factor
 2. Corrected Factor = Antenna Factor + Cable Loss - Amplifier
 3. The resolution bandwidth of test receiver/spectrum analyzer is 120KHz and video bandwidth is 300kHz for Peak detection and Quasi-peak detection at frequency below 1GHz.
 4. The resolution bandwidth of test receiver/spectrum analyzer is 1MHz and video bandwidth is 3MHz for Peak detection at frequency above 1GHz.
 5. The resolution bandwidth of test receiver/spectrum analyzer is 1MHz and video bandwidth is 10Hz for Average detection at frequency above 1GHz.
 6. The other emissions is too low to be measured.

EUT	: F5D7230-4	Pol/Phase	: HORIZONTAL
Power	: AC 120V	Temperature	: 18 °C
Test Mode	: Transmit/Receive	Humidity	: 54 %
Operation Channel	: 1	Atmospheric Pressure	: 1030 mmHg
Modulation Type	: 802.11g		
Rate	: 54 Mbps		
Memo	: MU12-2050200-A1		

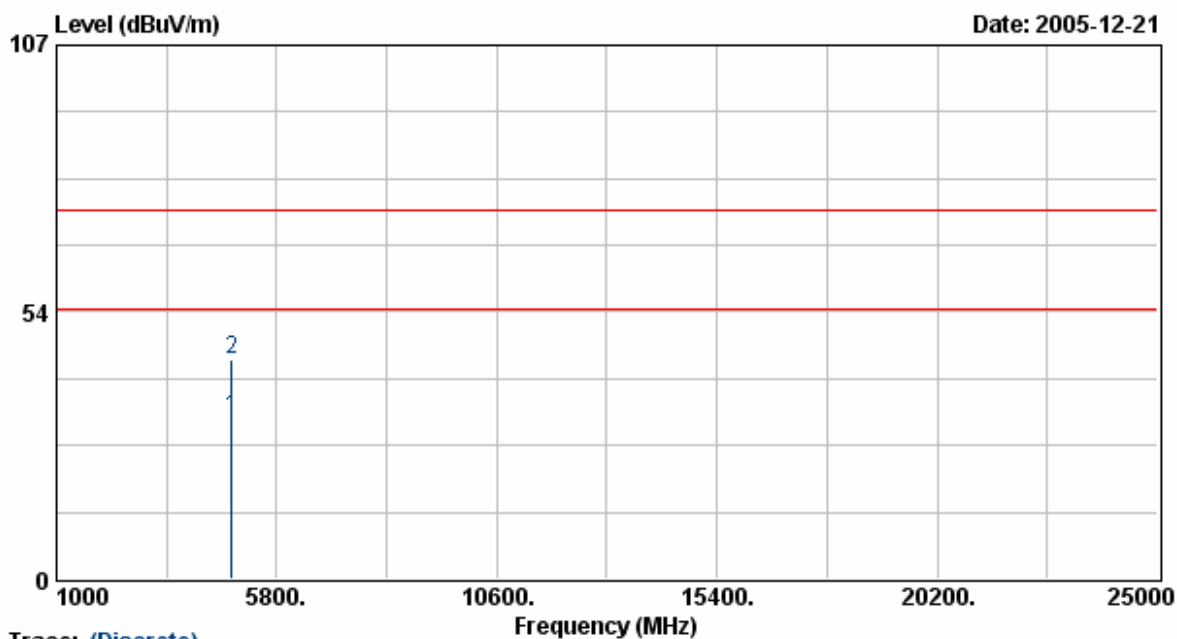

Trace: (Discrete)

Frequency (MHz)	Meter Reading (dBuV)	Corrected Factor (dBuV/m)	Result (dBuV/m)	Limit (dB)	Margin (dB)	Remark	Table Deg.	Ant High (cm)
4824.00	27.50	4.86	32.36	54.00	-21.64	Average	80	100
4824.00	39.12	4.86	43.98	74.00	-30.02	Peak	80	100

Notes:

1. Result = Meter Reading + Corrected Factor
2. Corrected Factor = Antenna Factor + Cable Loss - Amplifier
3. The resolution bandwidth of test receiver/spectrum analyzer is 120kHz and video bandwidth is 300kHz for Peak detection and Quasi-peak detection at frequency below 1GHz.
4. The resolution bandwidth of test receiver/spectrum analyzer is 1MHz and video bandwidth is 3MHz for Peak detection at frequency above 1GHz.
5. The resolution bandwidth of test receiver/spectrum analyzer is 1MHz and video bandwidth is 10Hz for Average detection at frequency above 1GHz.
6. The other emissions is too low to be measured.

EUT	: F5D7230-4	Pol/Phase	: VERTICAL
Power	: AC 120V	Temperature	: 18 °C
Test Mode	: Transmit/Receive	Humidity	: 54 %
Operation Channel	: 1	Atmospheric Pressure	: 1030 mmHg
Modulation Type	: 802.11g		
Rate	: 54 Mbps		
Memo	: MU12-2050200-A1		

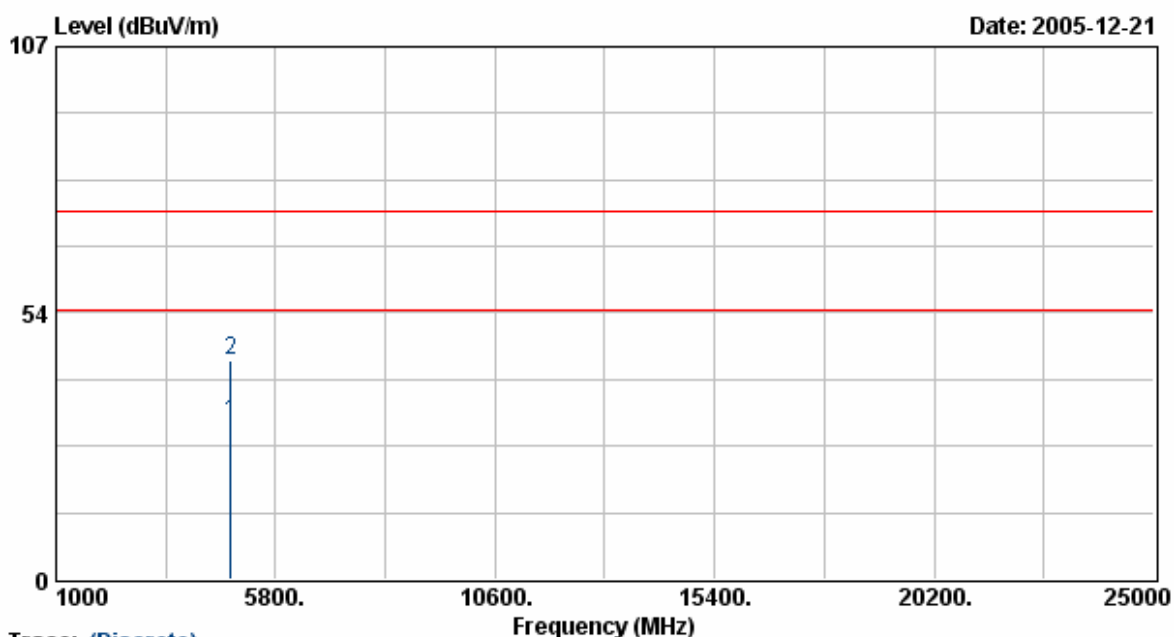

Trace: (Discrete)

Frequency (MHz)	Meter Reading (dBuV)	Corrected Factor (dBuV/m)	Result (dBuV/m)	Limit (dB)	Margin (dB)	Remark	Table Deg.	Ant High (cm)
4824.00	26.76	4.86	31.62	54.00	-22.38	Average	133	100
4824.00	38.97	4.86	43.83	74.00	-30.17	Peak	133	100

Notes:

1. Result = Meter Reading + Corrected Factor
2. Corrected Factor = Antenna Factor + Cable Loss - Amplifier
3. The resolution bandwidth of test receiver/spectrum analyzer is 120KHz and video bandwidth is 300kHz for Peak detection and Quasi-peak detection at frequency below 1GHz.
4. The resolution bandwidth of test receiver/spectrum analyzer is 1MHz and video bandwidth is 3MHz for Peak detection at frequency above 1GHz.
5. The resolution bandwidth of test receiver/spectrum analyzer is 1MHz and video bandwidth is 10Hz for Average detection at frequency above 1GHz.
6. The other emissions is too low to be measured.

```

EUT           : F5D7230-4
Power         : AC 120V
Test Mode     : Transmit/Receive
Operation Channel: 6
Modulation Type : 802.11g
Rate         : 54 Mbps
Memo         : MU12-2050200-A1

Pol/Phase     : HORIZONTAL
Temperature   : 18 °C
Humidity      : 54 %
Atmospheric Pressure: 1030 mmHg
    
```

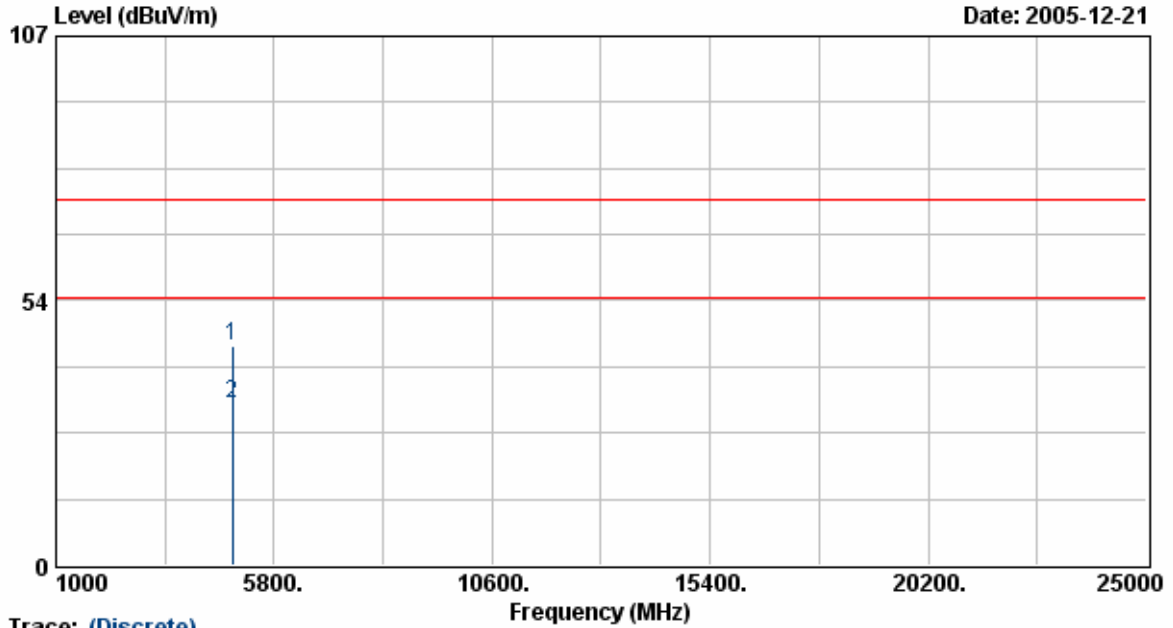

Trace: (Discrete)

Frequency (MHz)	Meter Reading (dBuV)	Corrected Factor (dBuV/m)	Result (dBuV/m)	Limit (dB)	Margin (dB)	Remark	Table Deg.	Ant High (cm)
4874.13	39.19	5.04	44.23	74.00	-29.77	Peak	80	100
4874.13	27.59	5.04	32.63	54.00	-21.37	Average	80	100

Notes:

1. Result = Meter Reading + Corrected Factor
2. Corrected Factor = Antenna Factor + Cable Loss - Amplifier
3. The resolution bandwidth of test receiver/spectrum analyzer is 120KHz and video bandwidth is 300kHz for Peak detection and Quasi-peak detection at frequency below 1GHz.
4. The resolution bandwidth of test receiver/spectrum analyzer is 1MHz and video bandwidth is 3MHz for Peak detection at frequency above 1GHz.
5. The resolution bandwidth of test receiver/spectrum analyzer is 1MHz and video bandwidth is 10Hz for Average detection at frequency above 1GHz.
6. The other emissions is too low to be measured.

EUT	: F5D7230-4	Pol/Phase	: VERTICAL
Power	: AC 120V	Temperature	: 18 °C
Test Mode	: Transmit/Receive	Humidity	: 54 %
Operation Channel	: 6	Atmospheric Pressure	: 1030 mmHg
Modulation Type	: 802.11g		
Rate	: 54 Mbps		
Memo	: MU12-2050200-A1		

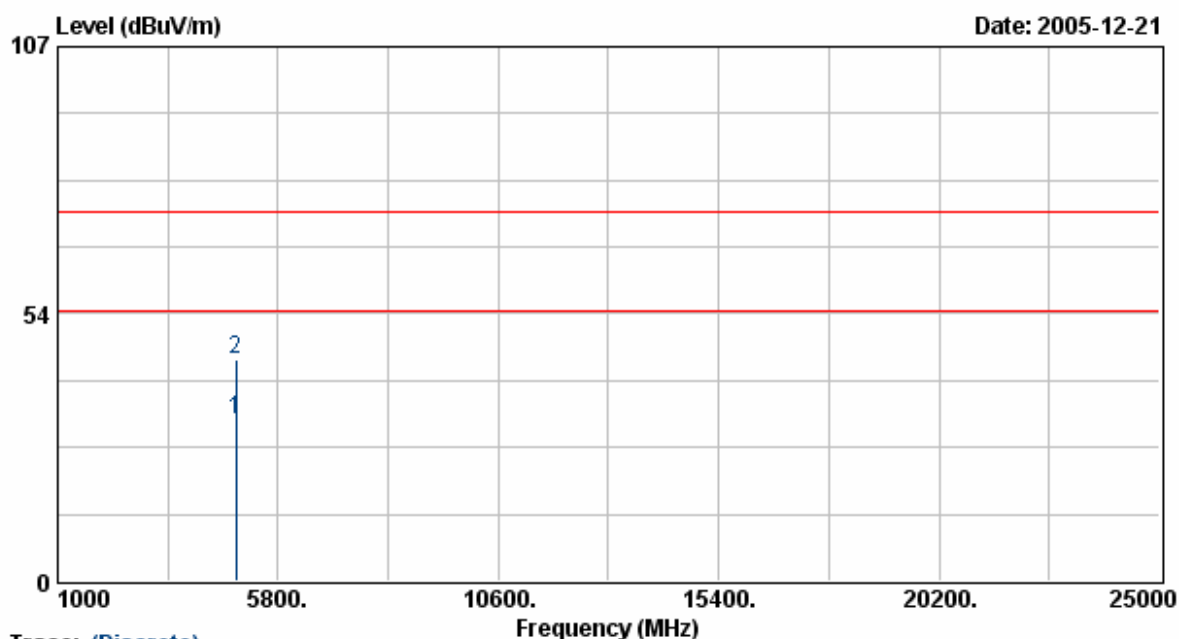

Trace: (Discrete)

Frequency (MHz)	Meter Reading (dBuV)	Corrected Factor (dBuV/m)	Result (dBuV/m)	Limit (dB)	Margin (dB)	Remark	Table Deg.	Ant High (cm)
4874.00	27.12	5.04	32.16	54.00	-21.84	Average	133	100
4874.00	39.36	5.04	44.41	74.00	-29.59	Peak	133	100

Notes:

1. Result = Meter Reading + Corrected Factor
2. Corrected Factor = Antenna Factor + Cable Loss - Amplifier
3. The resolution bandwidth of test receiver/spectrum analyzer is 120KHz and video bandwidth is 300kHz for Peak detection and Quasi-peak detection at frequency below 1GHz.
4. The resolution bandwidth of test receiver/spectrum analyzer is 1MHz and video bandwidth is 3MHz for Peak detection at frequency above 1GHz.
5. The resolution bandwidth of test receiver/spectrum analyzer is 1MHz and video bandwidth is 10Hz for Average detection at frequency above 1GHz.
6. The other emissions is too low to be measured.

```

EUT           : F5D7230-4
Power         : AC 120V
Test Mode     : Transmit/Receive
Operation Channel: 11
Modulation Type : 802.11g
Rate         : 54 Mbps
Memo         : MU12-2050200-A1

Pol/Phase     : HORIZONTAL
Temperature   : 18 °C
Humidity      : 54 %
Atmospheric Pressure: 1030 mmHg
    
```

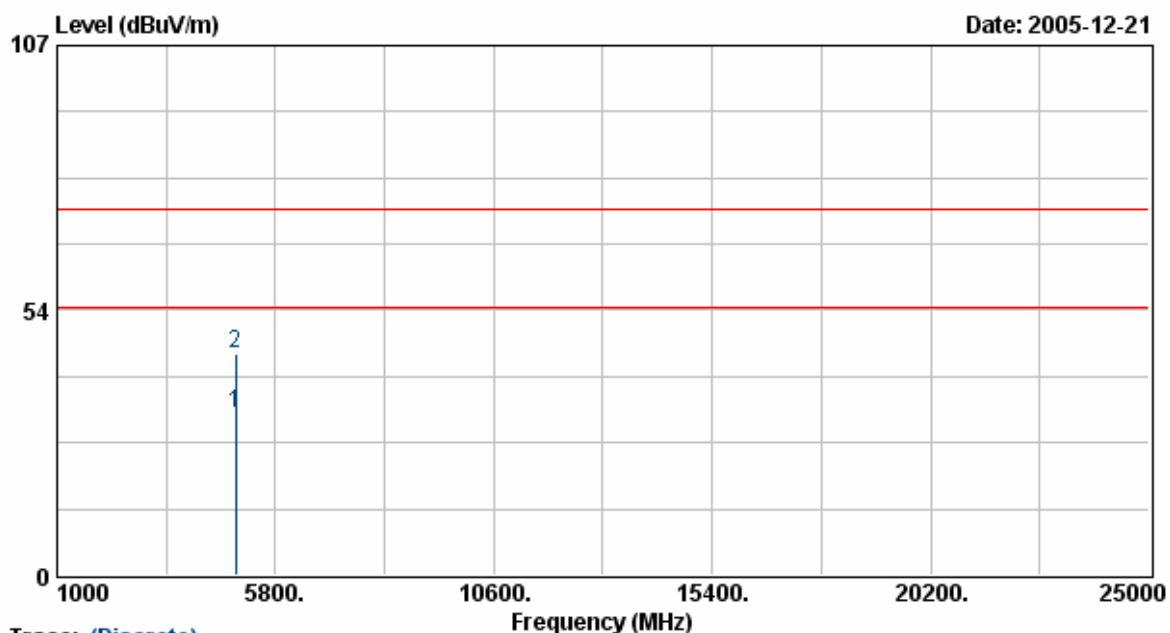

Trace: (Discrete)

Frequency (MHz)	Meter Reading (dBuV)	Corrected Factor (dBuV/m)	Result (dBuV/m)	Limit (dB)	Margin (dB)	Remark	Table Deg.	Ant High (cm)
4923.13	27.44	5.22	32.66	54.00	-21.34	Average	80	100
4923.13	39.60	5.22	44.83	74.00	-29.17	Peak	80	100

Notes:

1. Result = Meter Reading + Corrected Factor
2. Corrected Factor = Antenna Factor + Cable Loss - Amplifier
3. The resolution bandwidth of test receiver/spectrum analyzer is 120KHz and video bandwidth is 300kHz for Peak detection and Quasi-peak detection at frequency below 1GHz.
4. The resolution bandwidth of test receiver/spectrum analyzer is 1MHz and video bandwidth is 3MHz for Peak detection at frequency above 1GHz.
5. The resolution bandwidth of test receiver/spectrum analyzer is 1MHz and video bandwidth is 10Hz for Average detection at frequency above 1GHz.
6. The other emissions is too low to be measured.

EUT	: F5D7230-4	Pol/Phase	: VERTICAL
Power	: AC 120V	Temperature	: 18 °C
Test Mode	: Transmit/Receive	Humidity	: 54 %
Operation Channel	: 11	Atmospheric Pressure	: 1030 mmHg
Modulation Type	: 802.11g		
Rate	: 54 Mbps		
Memo	: MU12-2050200-A1		

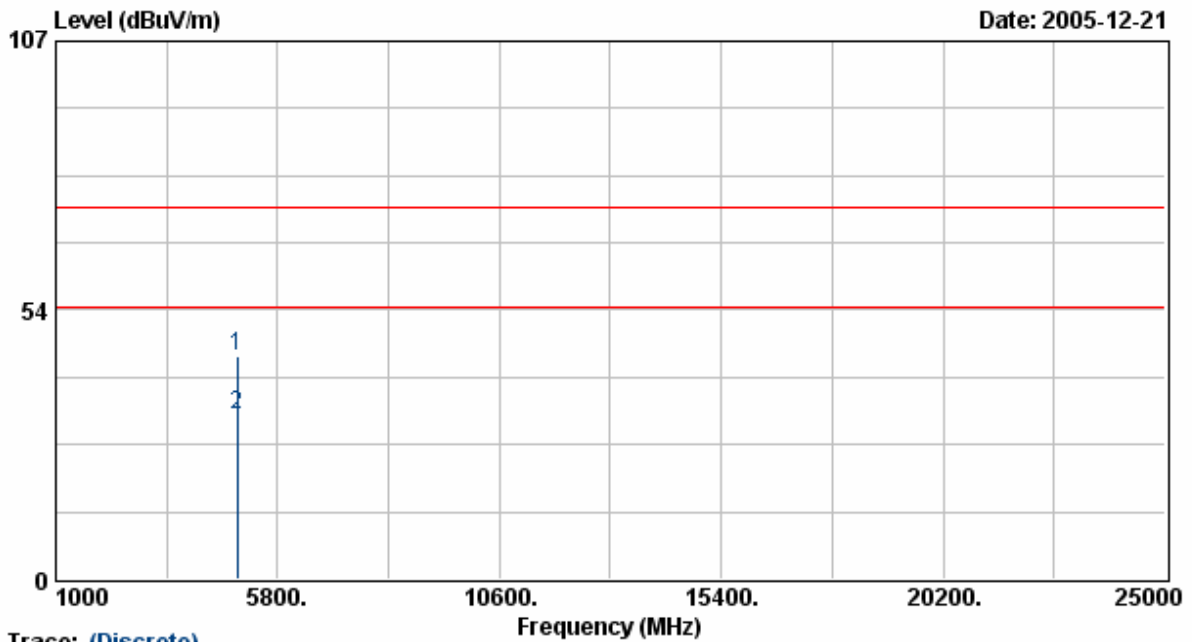

Trace: (Discrete)

Frequency (MHz)	Meter Reading (dBUV)	Corrected Factor (dBUV/m)	Result (dBUV/m)	Limit (dB)	Margin (dB)	Remark	Table Deg.	Ant High (cm)
4925.88	39.28	5.23	44.51	74.00	-29.49	Peak	133	100
4925.88	27.63	5.23	32.86	54.00	-21.14	Average	133	100

Notes:

1. Result = Meter Reading + Corrected Factor
2. Corrected Factor = Antenna Factor + Cable Loss - Amplifier
3. The resolution bandwidth of test receiver/spectrum analyzer is 120KHz and video bandwidth is 300kHz for Peak detection and Quasi-peak detection at frequency below 1GHz.
4. The resolution bandwidth of test receiver/spectrum analyzer is 1MHz and video bandwidth is 3MHz for Peak detection at frequency above 1GHz.
5. The resolution bandwidth of test receiver/spectrum analyzer is 1MHz and video bandwidth is 10Hz for Average detection at frequency above 1GHz.
6. The other emissions is too low to be measured.

6. 6dB Bandwidth Measurement Data

6.1 Test Limit

The minimum of 6dB Bandwidth Measurement is 0.5 MHz.

6.2 Test Procedures

1. The transmitter output was connected to the spectrum analyzer.
2. Set RBW of spectrum analyzer to 100 KHz and VBW to 100 KHz.
3. The 6 dB bandwidth is defined as the total spectrum the power of which is higher than peak power minus 6 dB.

6.3 Test Setup Layout

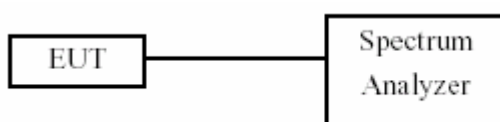

6.4 Measurement equipment

Instrument/Ancillary	Type	Manufacturer	Serial No.	Valid Date.
Spectrum Analyzer	FSP40	R&S	100047	2005/12/28

6.5 Test Result and Data

(1) Modulation Standard: IEEE 802.11b (11Mbps)

Test Date: Dec. 20, 2005 Temperature: 24 Humidity: 58% Atmospheric pressure: 1030 mmHg

Channel	Frequency (MHz)	6dB Bandwidth (MHz)
01	2412	8.7
06	2437	9.6
11	2462	8.9

(2) Modulation Standard: IEEE 802.11g (54Mbps)

Test Date: Dec. 20, 2005 Temperature: 24 Humidity: 58% Atmospheric pressure: 1030 mmHg

Channel	Frequency (MHz)	6dB Bandwidth (MHz)
01	2412	16.5
06	2437	16.5
11	2462	16.6

Modulation Standard: 802.11b (11Mbps)

Channel: 01

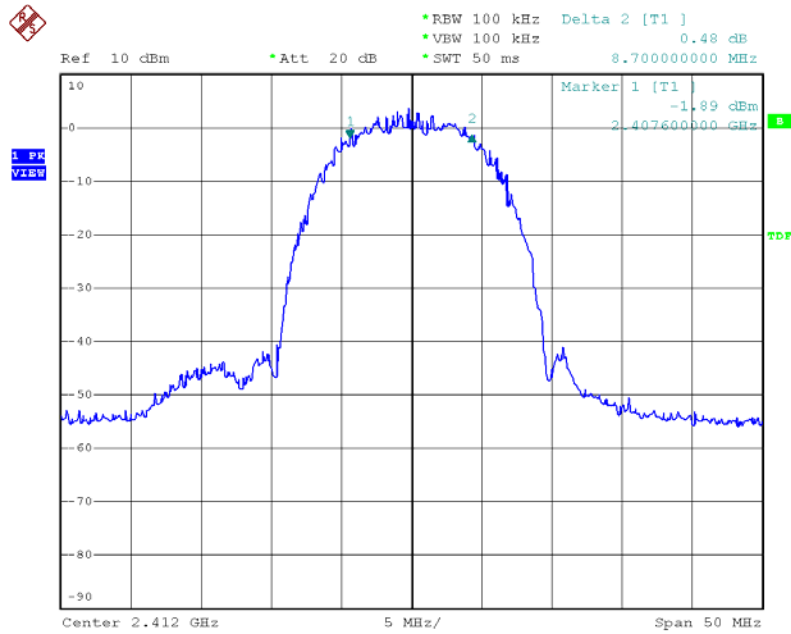

Date: 20.DEC.2005 14:58:43

Channel:06

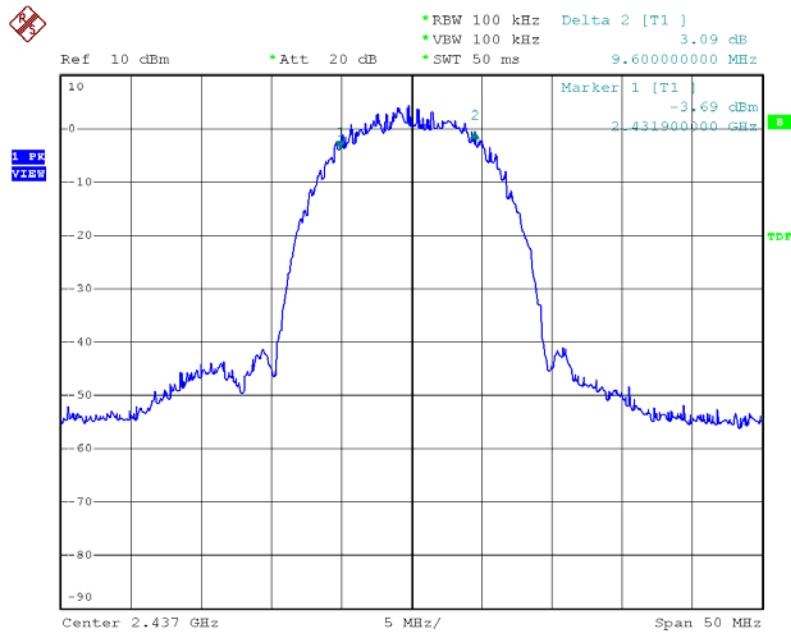

Date: 20.DEC.2005 15:08:08

Channel: 11

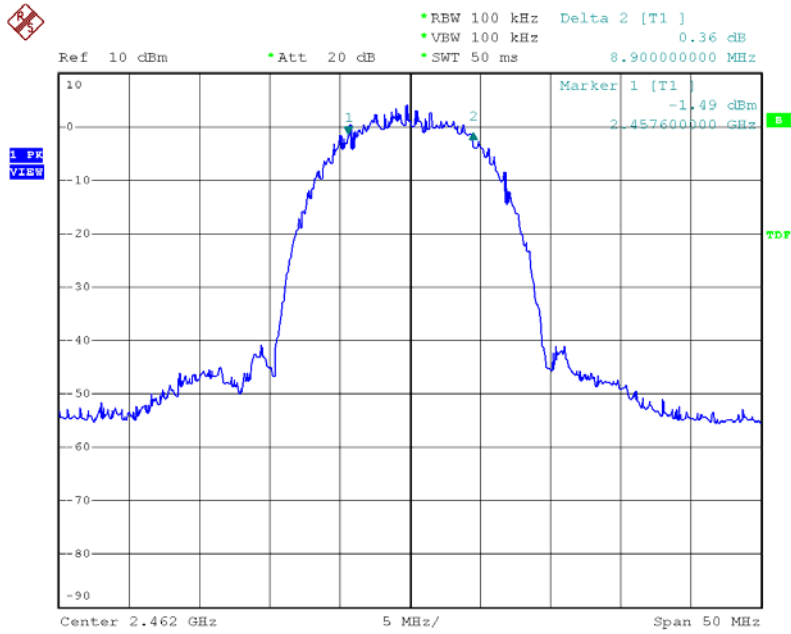

Date: 20.DEC.2005 15:05:17

Modulation Standard:802.11g (54Mbps)

Channel:01

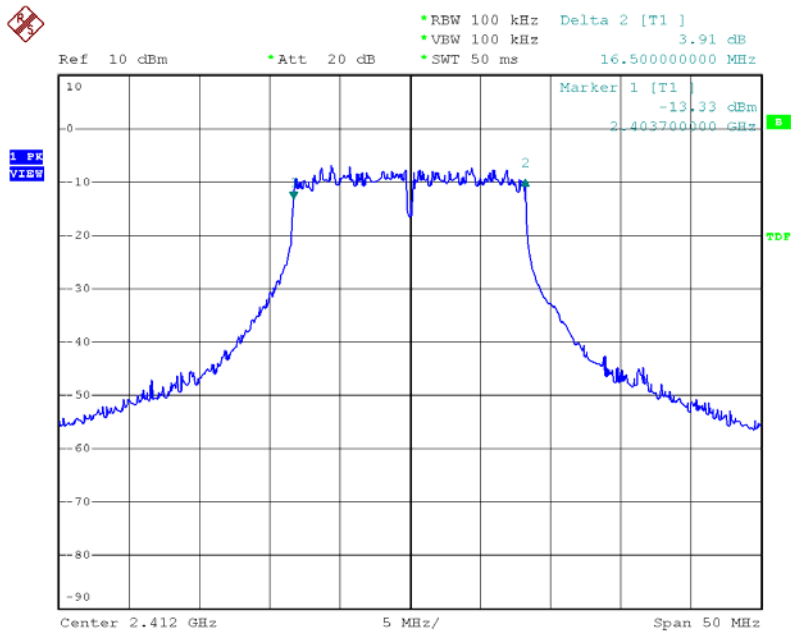

Date: 20.DEC.2005 15:10:33

Channel: 06

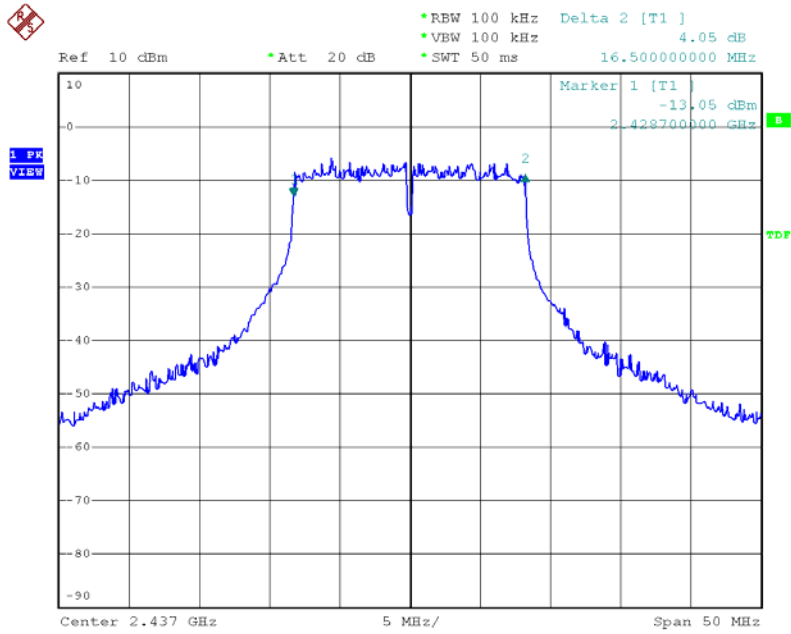

Date: 20.DEC.2005 15:12:52

Channel:11

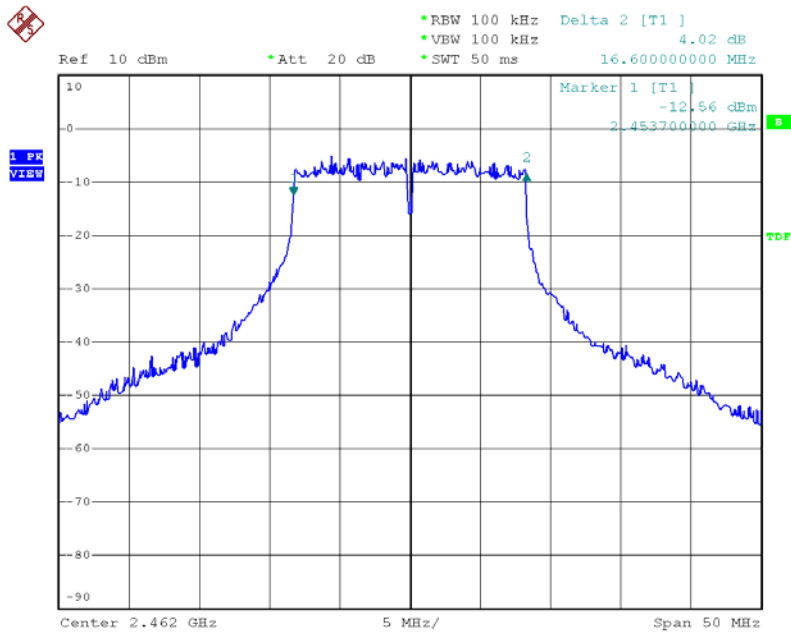

Date: 20.DEC.2005 15:14:44

7. Maximum Peak Output Power

7.1 Test Limit

The Maximum Peak Output Power Measurement is 30dBm.

7.2 Test Procedures

The antenna port(RF output)of the EUT was connected to the input(RF input)of a power meter. Power was read directly from the meter and cable loss connection was added to the reading to obtain power at the EUT antenna terminal. The EUT Output Power was set to maximum to produce the worse case test result.

7.3 Test Setup Layout

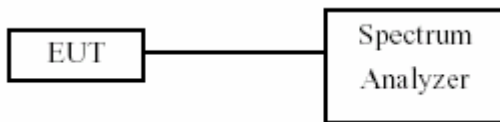

7.4 List of Measuring Equipment Used

Instrument/Ancillary	Type	Manufacturer	Serial No.	Valid Date.
Spectrum Analyzer	FSP40	R&S	100047	2005/12/28

7.5 Test Result and Data

(1) Modulation Standard: IEEE 802.11b (11Mbps)

Test Date: Dec. 20, 2005 Temperature: 24 Humidity: 58% Atmospheric pressure: 1030 mmHg

Channel	Frequency (MHz)	Peak Power Output (dBm)	Peak Power Output (mW)
01	2412	18.75	74.989
06	2437	19.33	85.704
11	2462	19.37	86.497

(2) Modulation Standard: IEEE 802.11g (54Mbps)

Test Date: Dec. 20, 2005 Temperature: 24 Humidity: 58% Atmospheric pressure: 1030 mmHg

Channel	Frequency (MHz)	Peak Power Output (dBm)	Peak Power Output (mW)
01	2412	13.92	24.660
06	2437	14.68	29.376
11	2462	15.74	37.497

Modulation Standard: 802.11b (11Mbps)
 Channel: 01

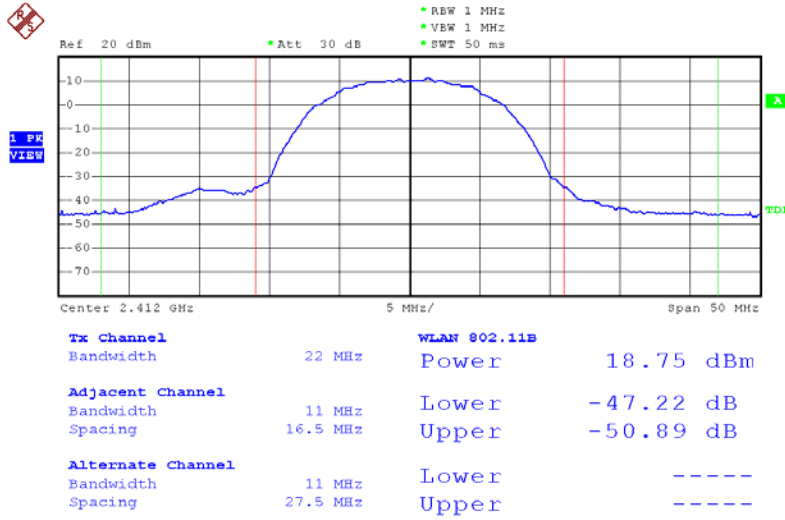

Date: 20.DEC.2005 14:50:22

Channel:06

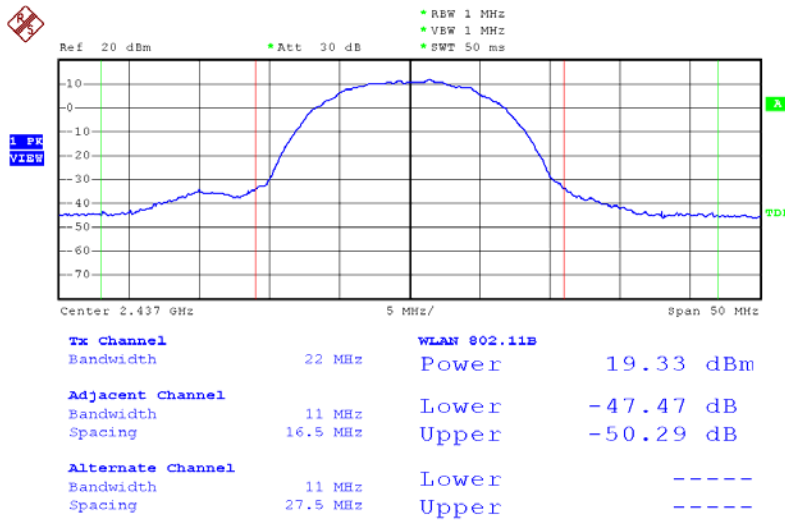

Date: 20.DEC.2005 14:51:40

Channel: 11

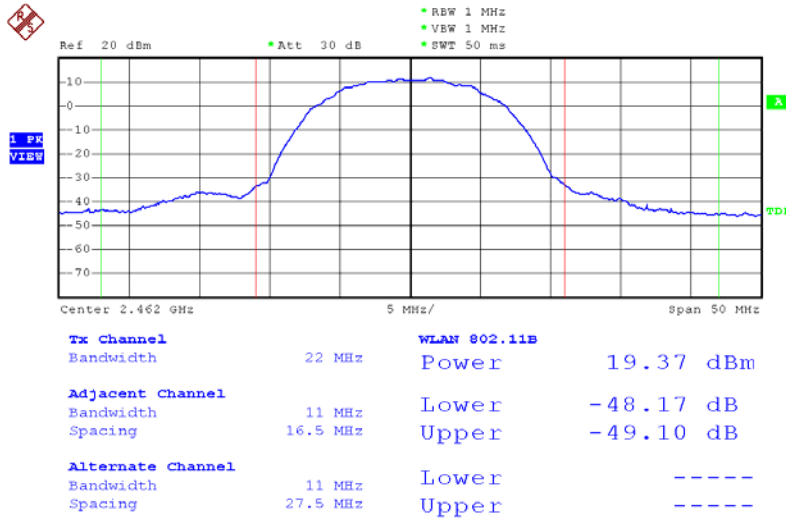

Date: 20.DEC.2005 14:48:12

Modulation Standard:802.11g (54Mbps)
Channel:01

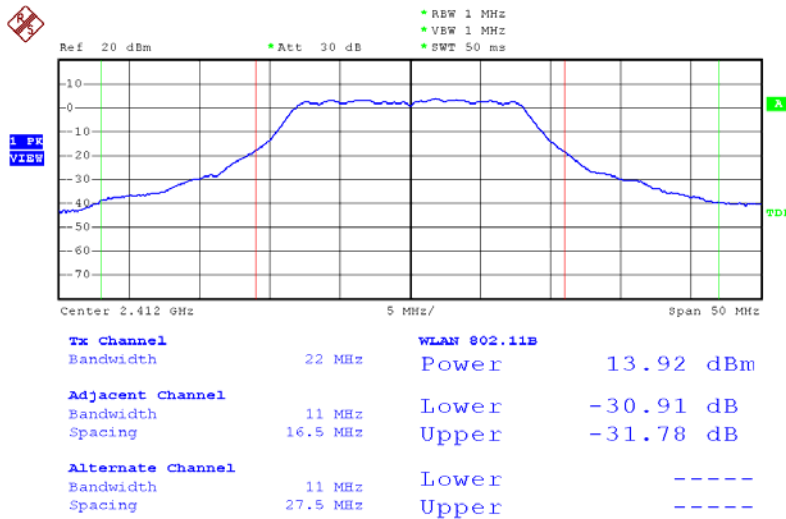

Date: 20.DEC.2005 14:42:00

Channel: 06

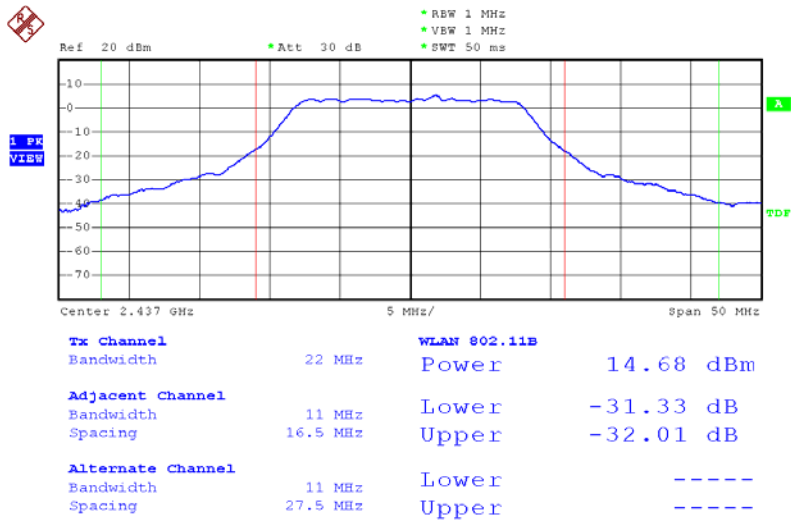

Date: 20.DEC.2005 14:40:39

Channel:11

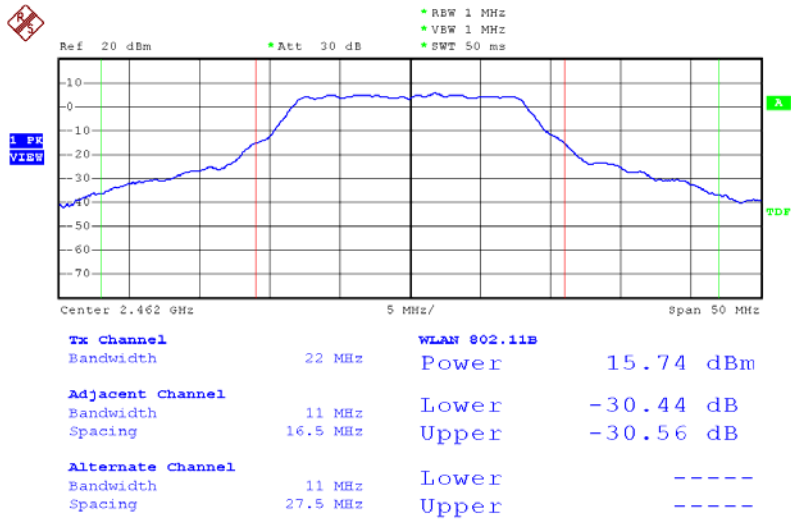

Date: 20.DEC.2005 14:39:08

8. Band Edges Measurement

8.1 Test Limit

Below -20dB of the highest emission level of operating band
(in 100kHz Resolution Bandwidth).

8.2 Test Procedure :

- 1.The transmitter output was connected to the spectrum analyzer via a low lose cable.
- 2.Set both RBW and VBW of spectrum analyzer to 100 KHz with convenient frequency span including 100 KHz bandwidth from band edge.
- 3.The band edges was measured and recorded.

8.3 Test Setup Layout

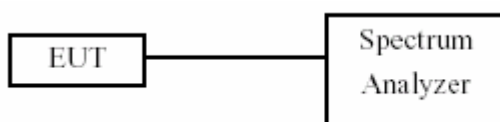

8.4 List of Measuring Equipment Used

Instrument/Ancillary	Type	Manufacturer	Serial No.	Valid Date.
Spectrum Analyzer	FSP40	R&S	100047	2005/12/28

8.5 Test Result and Data

(1) Modulation Standard: IEEE 802.11b (11Mbps)

Test Date: Dec. 20, 2005 Temperature: 24 Humidity: 58% Atmospheric pressure: 1030 mmHg

Channel	Frequency	maximum value in frequency (MHz)	maximum value is (dBm)
01	2412	2.3986	-44.19
11	2462	2.5021	-52.00

(2) Modulation Standard: IEEE 802.11g (54Mbps)

Test Date: Dec. 20, 2005 Temperature: 24 Humidity: 58% Atmospheric pressure: 1030 mmHg

Channel	Frequency	maximum value in frequency (MHz)	maximum value is (dBm)
01	2412	2.3998	-39.38
11	2462	2.4837	-51.30

Modulation Standard: 802.11b (11Mbps)

Channel: 01

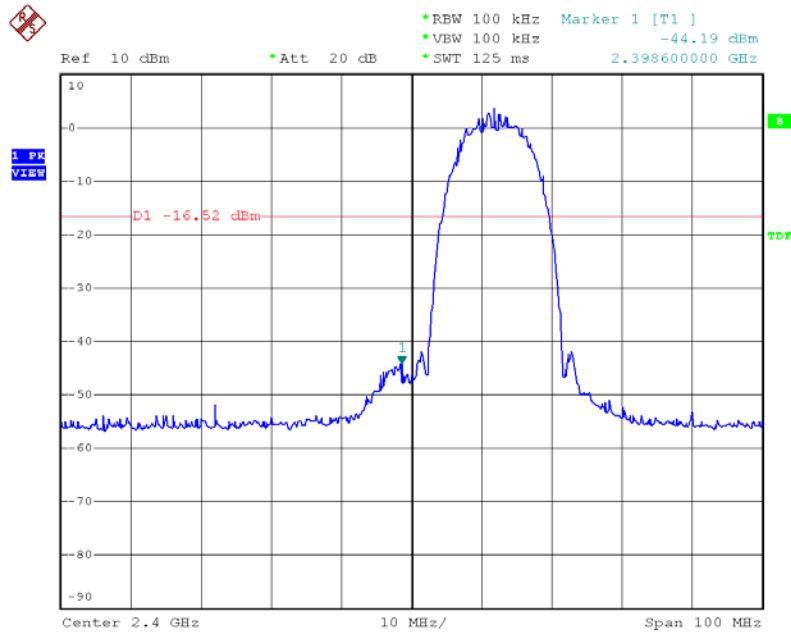

Date: 20.DEC.2005 15:22:07

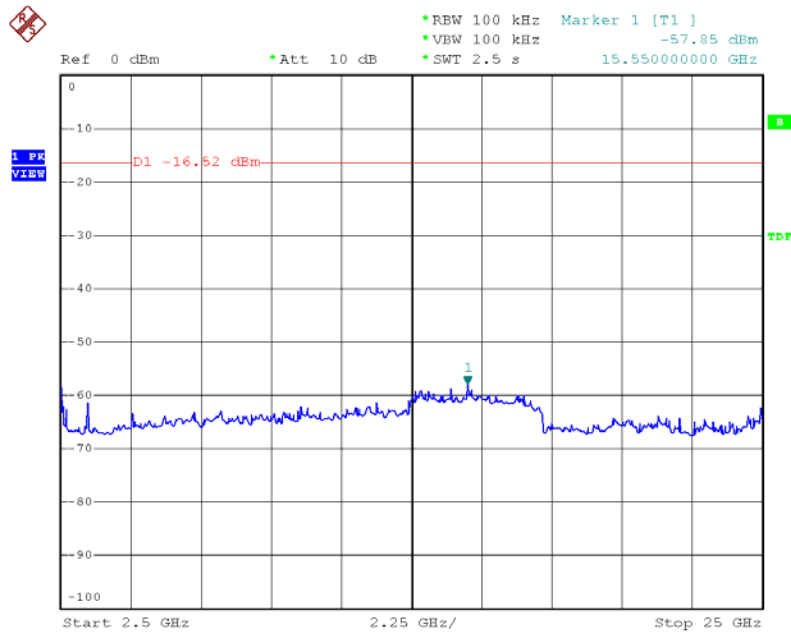

Date: 20.DEC.2005 15:25:20

Channel: 11

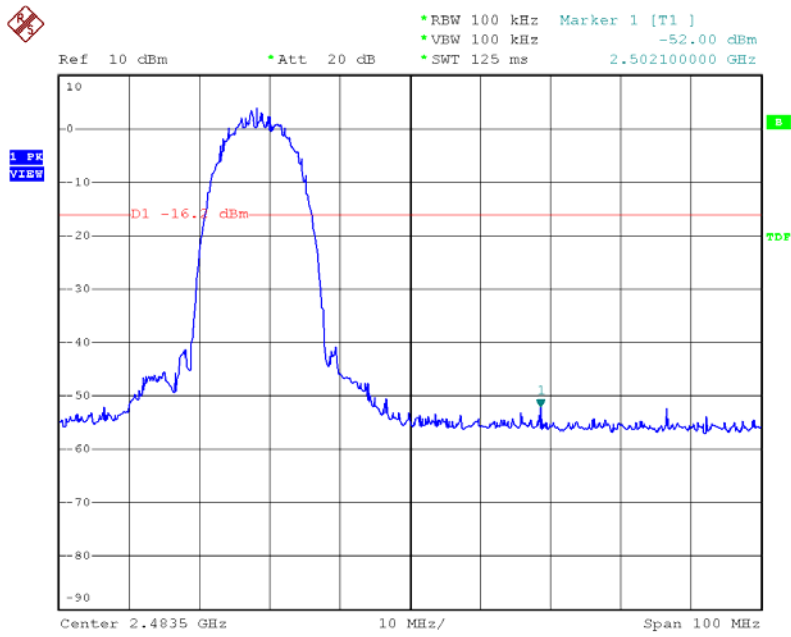

Date: 20.DEC.2005 15:31:12

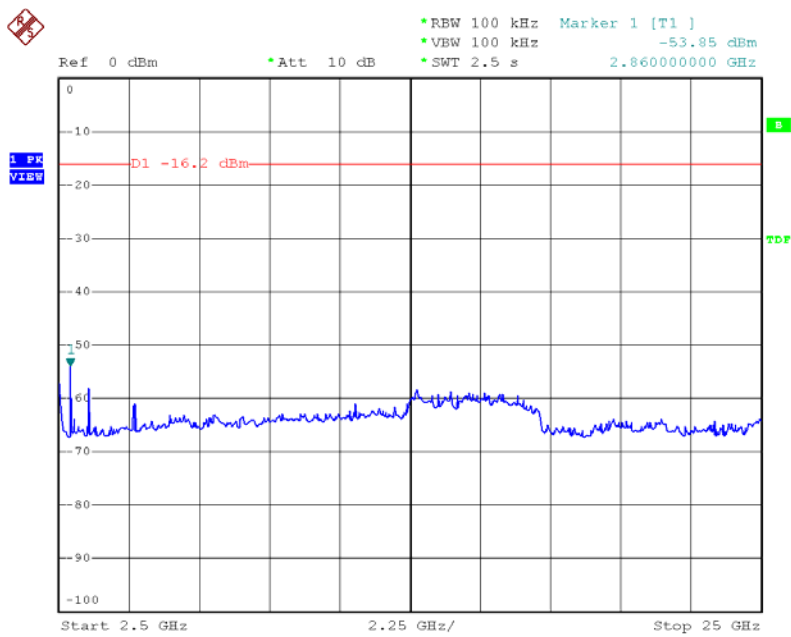

Date: 20.DEC.2005 15:33:20

Modulation Standard: 802.11g (54Mbps)

Channel: 01

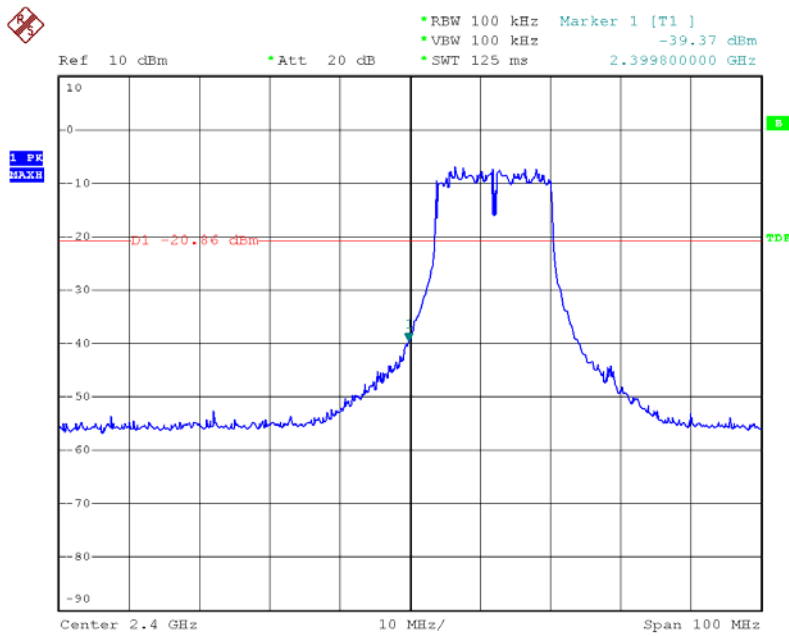

Date: 20.DEC.2005 15:37:30

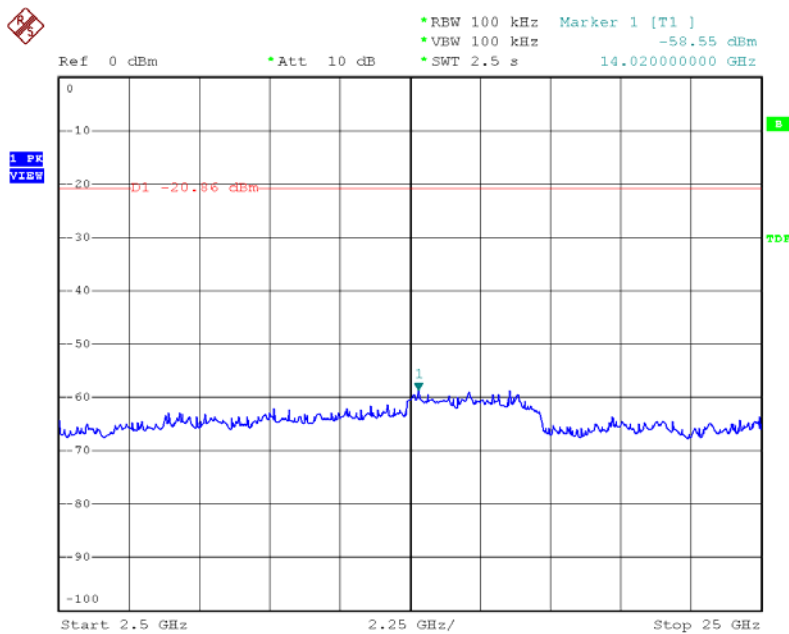

Date: 20.DEC.2005 15:39:14

Channel: 11

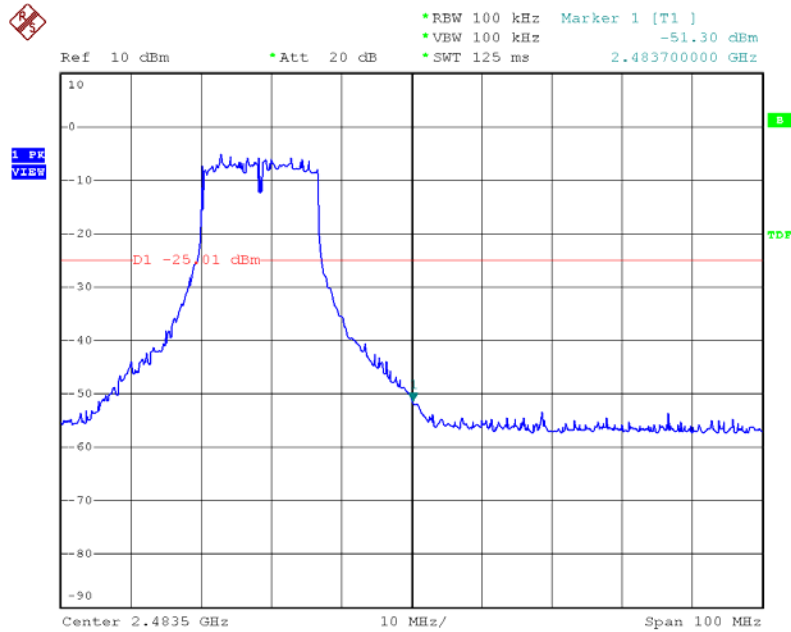

Date: 20.DEC.2005 15:42:35

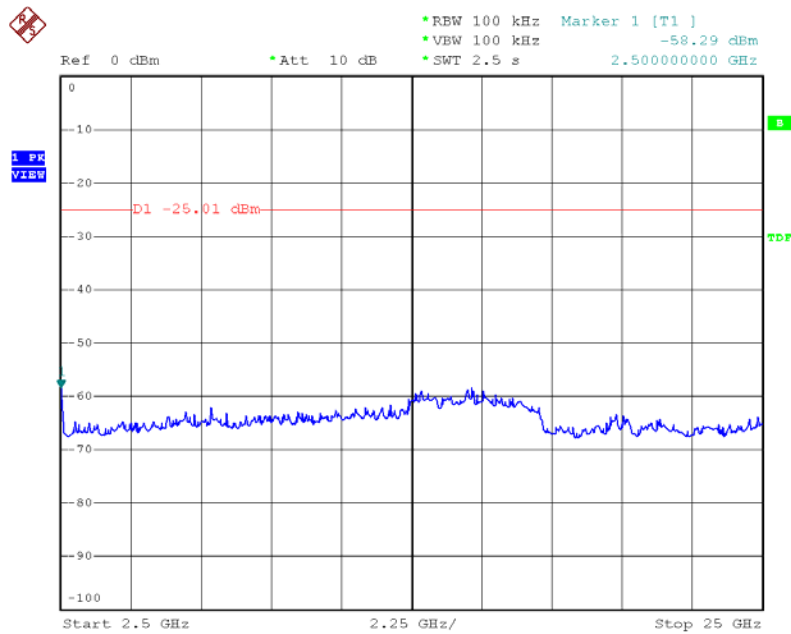

Date: 20.DEC.2005 15:44:34

8.6 Restrict band emission Measurement Data

Test Adapter 1:

Modulation Standard: IEEE 802.11b (11Mbps)

Test Date: Dec. 21, 2005 Temperature: 18 Humidity: 54% Atmospheric pressure: 1030 mmHg

a) Channel 1

Frequency (MHz)	Ant-Pol H/V	Meter Reading	Corrected Factor	Result (dBuV/m)	Remark	Limit@3m (dBuV/m)		Margin (dB)	Table (Deg.)	Ant High (m)
						Peak	Ave.			
2388.744	H	51.62	-2.05	49.57	Peak	74	54	-24.43	80.	1.1
2371.914	H	38.72	-2.11	36.61	Ave	74	54	-17.39	80.	1.1
2388.234	V	52.05	-2.06	49.99	Peak	74	54	-24.01	133	1.0
2319.894	V	39.84	-2.29	37.55	Ave	74	54	-16.45	133	1.0

b) Channel 11

Frequency (MHz)	Ant-Pol H/V	Meter Reading	Corrected Factor	Result (dBuV/m)	Remark	Limit@3m (dBuV/m)		Margin (dB)	Table (Deg.)	Ant High (m)
						Peak	Ave.			
2484.952	H	52.15	-1.72	50.43	Peak	74	54	-23.57	80	1.1
2487.232	H	38.11	-1.71	36.40	Ave	74	54	-17.60	80	1.1
2495.022	V	50.83	-1.69	49.14	Peak	74	54	-24.86	133	1.0
2483.926	V	37.93	-1.73	36.20	Ave	74	54	-17.80	133	1.0

Modulation Standard: 802.11g (54Mbps)

Test Date: Dec. 21, 2005 Temperature: 18 Humidity: 54% Atmospheric pressure: 1030 mmHg

a) Channel 1

Frequency (MHz)	Ant-Pol H/V	Meter Reading	Corrected Factor	Result (dBuV/m)	Remark	Limit@3m (dBuV/m)		Margin (dB)	Table (Deg.)	Ant High (m)
						Peak	Ave.			
2388.948	H	50.26	-2.05	48.21	Peak	74	54	-25.79	80	1.1
2389.968	H	37.14	-2.05	35.09	Ave	74	54	-18.91	80	1.1
2389.968	V	51.72	-2.05	49.67	Peak	74	54	-24.33	133	1.0
2389.968	V	37.90	-2.05	35.85	Ave	74	54	-18.15	133	1.0

b) Channel 11

Frequency (MHz)	Ant-Pol H/V	Meter Reading	Corrected Factor	Result (dBuV/m)	Remark	Limit@3m (dBuV/m)		Margin (dB)	Table (Deg.)	Ant High (m)
						Peak	Ave.			
2483.812	H	52.97	-1.73	51.24	Peak	74	54	-22.76	80	1.1
2483.508	H	41.92	-1.73	40.19	Ave	74	54	-13.81	80	1.1
2483.736	V	51.30	-1.73	49.57	Peak	74	54	-24.43	133	1.0
2483.508	V	37.66	-1.73	35.93	Ave	74	54	-18.07	133	1.0

Notes:

1. Result = Meter Reading + Factor
2. Factor = Antenna Factor + Cable Loss – Amplifier
3. The resolution bandwidth of test receiver/spectrum analyzer is 1 MHz and video bandwidth is 3 MHz for Peak detection at frequency above 1GHz.
4. The resolution bandwidth of test receiver/spectrum analyzer is 1MHz and video bandwidth is 10Hz for Average detection at frequency above 1GHz

Test Adapter 2:

Modulation Standard: IEEE 802.11b (11Mbps)

Test Date: Dec. 21, 2005 Temperature: 18 Humidity: 54% Atmospheric pressure: 1030 mmHg

a) Channel 1

Frequency (MHz)	Ant-Pol H/V	Meter Reading	Corrected Factor	Result (dBuV/m)	Remark	Limit@3m (dBuV/m)		Margin (dB)	Table (Deg.)	Ant High (m)
						Peak	Ave.			
2388.744	H	51.38	-2.05	49.33	Peak	74	54	-24.67	80.	1.1
2371.914	H	38.68	-2.11	36.57	Ave	74	54	-17.43	80.	1.1
2388.234	V	51.87	-2.06	49.81	Peak	74	54	-24.19	133	1.0
2319.894	V	39.62	-2.29	37.33	Ave	74	54	-16.67	133	1.0

b) Channel 11

Frequency (MHz)	Ant-Pol H/V	Meter Reading	Corrected Factor	Result (dBuV/m)	Remark	Limit@3m (dBuV/m)		Margin (dB)	Table (Deg.)	Ant High (m)
						Peak	Ave.			
2484.952	H	51.87	-1.72	50.15	Peak	74	54	-23.85	80	1.1
2487.232	H	37.81	-1.71	36.10	Ave	74	54	-17.90	80	1.1
2495.022	V	50.49	-1.69	48.80	Peak	74	54	-25.20	133	1.0
2483.926	V	37.50	-1.73	35.77	Ave	74	54	-18.23	133	1.0

Modulation Standard: 802.11g (54Mbps)

Test Date: Dec. 21, 2005 Temperature: 18 Humidity: 54% Atmospheric pressure: 1030 mmHg

a) Channel 1

Frequency (MHz)	Ant-Pol H/V	Meter Reading	Corrected Factor	Result (dBuV/m)	Remark	Limit@3m (dBuV/m)		Margin (dB)	Table (Deg.)	Ant High (m)
						Peak	Ave.			
2388.948	H	50.65	-2.05	48.60	Peak	74	54	-25.40	80	1.1
2389.968	H	37.26	-2.05	35.21	Ave	74	54	-18.79	80	1.1
2389.968	V	51.65	-2.05	49.60	Peak	74	54	-24.40	133	1.0
2389.968	V	37.67	-2.05	35.62	Ave	74	54	-18.38	133	1.0

b) Channel 11

Frequency (MHz)	Ant-Pol H/V	Meter Reading	Corrected Factor	Result (dBuV/m)	Remark	Limit@3m (dBuV/m)		Margin (dB)	Table (Deg.)	Ant High (m)
						Peak	Ave.			
2483.812	H	53.10	-1.73	51.37	Peak	74	54	-22.63	80	1.1
2483.508	H	41.73	-1.73	40.00	Ave	74	54	-34.00	80	1.1
2483.736	V	51.45	-1.73	49.72	Peak	74	54	-24.28	133	1.0
2483.508	V	37.51	-1.73	35.78	Ave	74	54	-18.22	133	1.0

Notes:

1. Result = Meter Reading + Factor
2. Factor = Antenna Factor + Cable Loss – Amplifier
3. The resolution bandwidth of test receiver/spectrum analyzer is 1 MHz and video bandwidth is 3 MHz for Peak detection at frequency above 1GHz.
4. The resolution bandwidth of test receiver/spectrum analyzer is 1MHz and video bandwidth is 10Hz for Average detection at frequency above 1GHz

9. Power Spectral Density

9.1 Test Limit

The Maximum of Power Spectral Density Measurement is 8dBm.

9.2 Test Procedures

- 1.The transmitter output was connected to spectrum analyzer.
- 2.The spectrum analyzer's resolution bandwidth were set at 3KHz RBW and 30KHz VBW as that of the fundamental frequency. Set the sweep time=span/3KHz.
- 3.The power spectral density was measured and recorded.
- 4.The Sweep time is allowed to be longer than span/3KHz for a full response of the mixer in the spectrum analyzer.

9.3 Test Setup Layout :

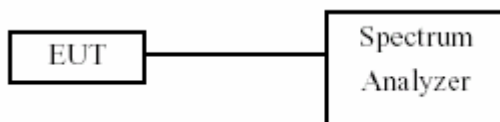

9.4 List of Measuring Equipment Used

Instrument/Ancillary	Type	Manufacturer	Serial No.	Valid Date.
Spectrum Analyzer	FSP40	R&S	100047	2005/12/28

9.5 Test Result and Data

(1) Modulation Standard: IEEE 802.11b (11Mbps)

Test Date: Dec. 20, 2005 Temperature: 24 Humidity: 58% Atmospheric pressure: 1030 mmHg

Channel	Frequency	Maximum Power Density of 3 kHz Bandwidth (dBm)
01	2412	-6.18
06	2437	-9.42
11	2462	-9.86

(2) Modulation Standard: IEEE 802.11g (54Mbps)

Test Date: Dec. 20, 2005 Temperature: 24 Humidity: 58% Atmospheric pressure: 1030 mmHg

Channel	Frequency	Maximum Power Density of 3 kHz Bandwidth (dBm)
01	2412	-20.85
06	2437	-19.47
11	2462	-19.20

Modulation Standard: 802.11b (11Mbps)
 Channel: 01

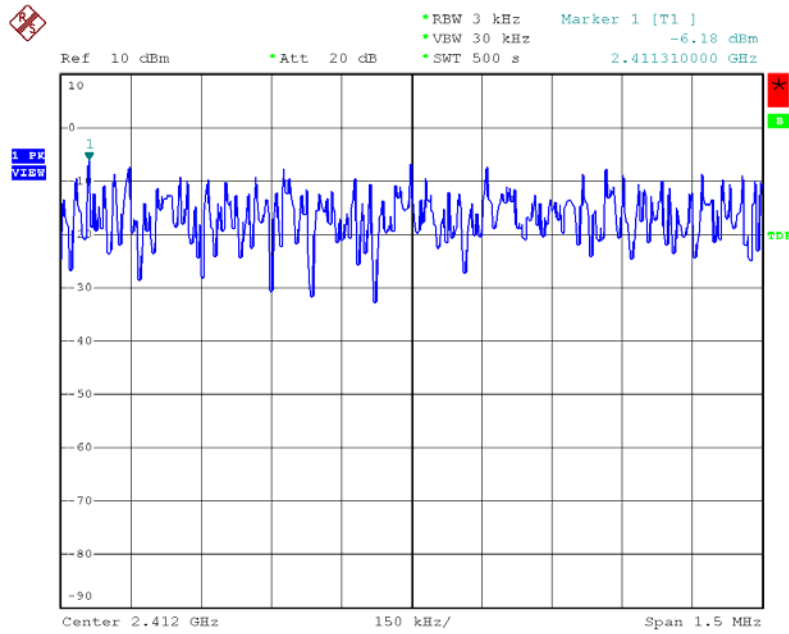

Date: 20.DEC.2005 15:58:23

Channel:06

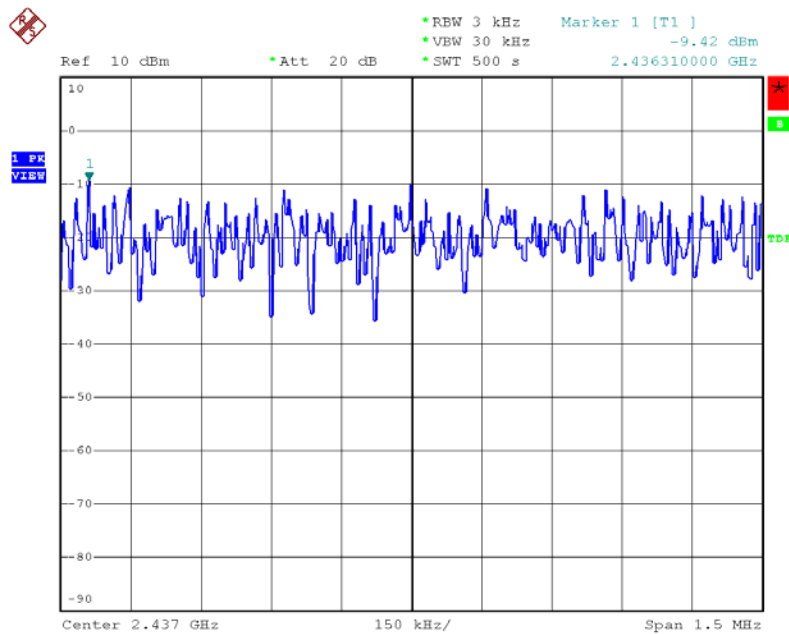

Date: 20.DEC.2005 16:10:54

Channel: 11

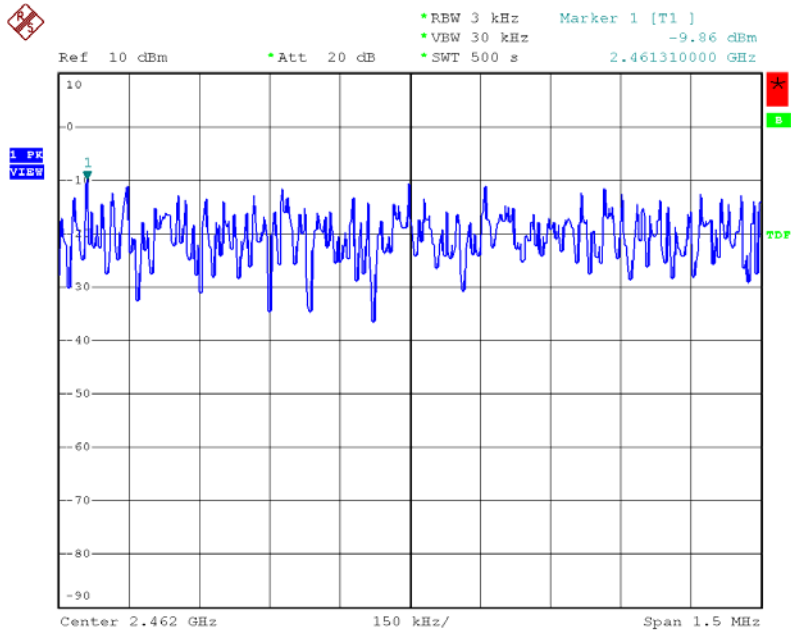

Date: 20.DEC.2005 16:21:00

Modulation Standard:802.11g (54Mbps)

Channel:01

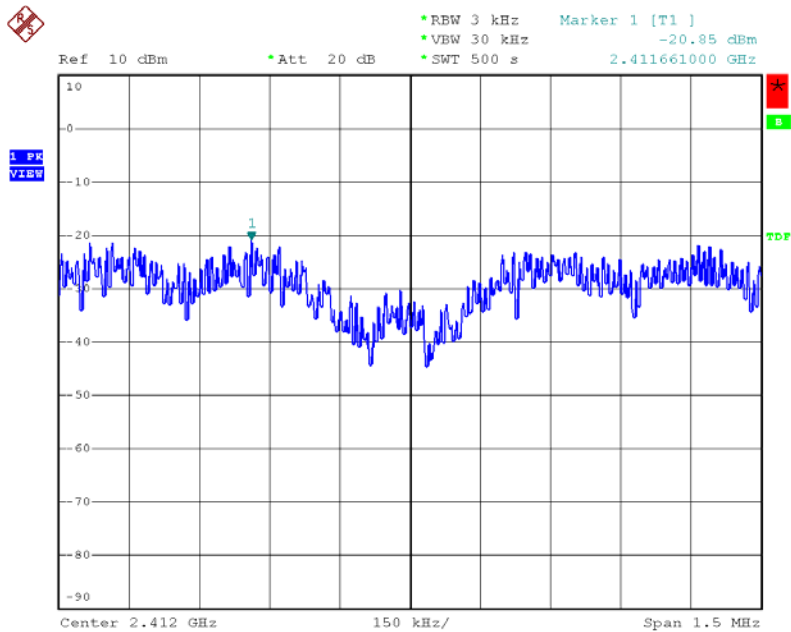

Date: 20.DEC.2005 16:32:01

Channel: 06

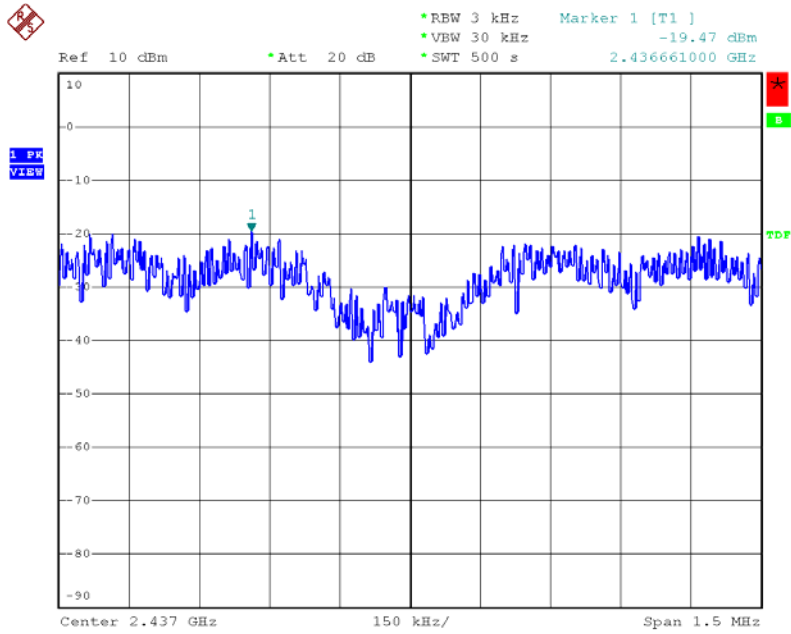

Date: 20.DEC.2005 16:41:36

Channel:11

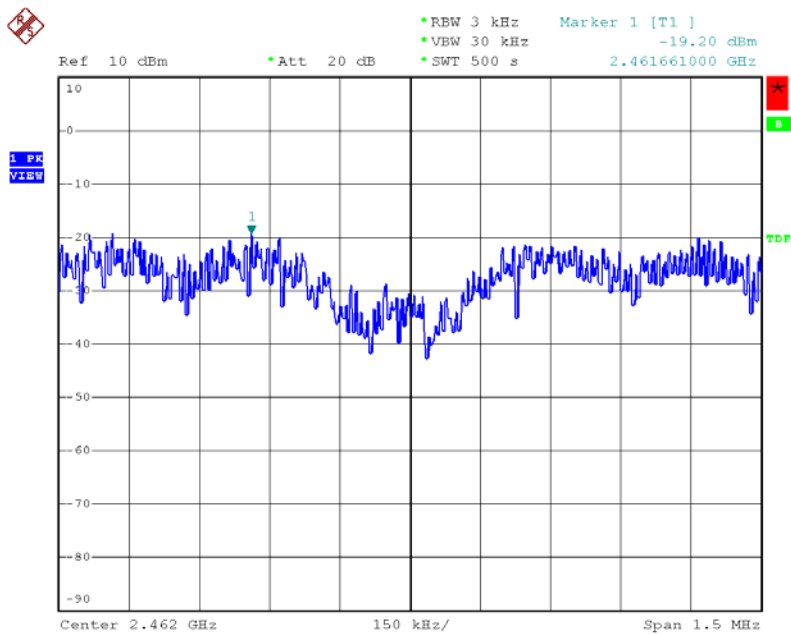

Date: 20.DEC.2005 16:51:34

10. Restricted Bands of Operation

Only spurious emissions are permitted in any of the frequency bands listed below:

MHz	MHz	MHz	GHz
0.09000 – 0.11000	16.42000 – 16.42300	399.9 – 410.0	4.500 – 5.250
0.49500 – 0.505**	16.69475 – 16.69525	608.0 – 614.0	5.350 – 5.460
2.17350 – 2.19050	16.80425 – 16.80475	960.0 – 1240.0	7.250 – 7.750
4.12500 – 4.12800	25.50000 – 25.67000	1300.0 – 1427.0	8.025 – 8.500
4.17725 – 4.17775	37.50000 – 38.25000	1435.0 – 1626.5	9.000 – 9.200
4.20725 – 4.20775	73.00000 – 74.60000	1645.5 – 1646.5	9.300 – 9.500
6.21500 – 6.21800	74.80000 – 75.20000	1660.0 – 1710.0	10.600 – 12.700
6.26775 – 6.26825	108.00000 – 121.94000	1718.8 – 1722.2	13.250 – 13.400
6.31175 – 6.31225	123.00000 – 138.00000	2200.0 – 2300.0	14.470 – 14.500
8.29100 – 8.29400	149.90000 – 150.05000	2310.0 – 2390.0	15.350 – 16.200
8.36200 – 8.36600	156.52475 – 156.52525	2483.5 – 2500.0	17.700 – 21.400
8.37625 – 8.38675	156.70000 – 156.90000	2655.0 – 2900.0	22.010 – 23.120
8.41425 – 8.41475	162.01250 – 167.17000	3260.0 – 3267.0	23.600 – 24.000
12.29000 – 12.29300	167.72000 – 173.20000	3332.0 – 3339.0	31.200 – 31.800
12.51975 – 12.52025	240.00000 – 285.00000	3345.8 – 3358.0	36.430 – 36.500
12.57675 – 12.57725	322.00000 – 335.40000	3600.0 – 4400.0	Above 38.6
13.36000 – 13.41000			

** : Until February 1, 1999, this restricted band shall be 0.490-0.510 MHz

10.1 Labeling Requirement

The device shall bear the following statement in a conspicuous location on the device:

This device complies with part 15 of the FCC Rules. Operation is subject to the following two conditions: (1) This device may not cause harmful interference, and (2) this device must accept any interference received, including interference that may cause undesired operation.