

## FCC Test Report

**Report No.:** RF150122E07-1

**FCC ID:** UIDSBG6900

**Test Model:** SBG6900-AC

**Received Date:** Jan. 22, 2015

**Test Date:** Feb. 26 to Mar. 12, 2015

**Issued Date:** Mar. 24, 2015

**Applicant:** ARRIS Group, Inc.

**Address:** 3871 Lakefield Drive Suite 300 Suwanee, GA30024

**Issued By:** Bureau Veritas Consumer Products Services (H.K.) Ltd., Taoyuan Branch  
Hsin Chu Laboratory

**Lab Address:** No. 81-1, Lu Liao Keng, 9th Ling, Wu Lung Tsuen, Chiung Lin Hsiang, Hsin  
Chu Hsien 307, Taiwan R.O.C.

**Test Location (1):** No. 81-1, Lu Liao Keng, 9th Ling, Wu Lung Tsuen, Chiung Lin Hsiang, Hsin  
Chu Hsien 307, Taiwan R.O.C.

**Test Location (2):** No. 49, Ln. 206, Wende Rd., Shangshan Tsuen, Chiung Lin Hsiang, Hsin  
Chu Hsien 307, Taiwan R.O.C.



This report is for your exclusive use. Any copying or replication of this report to or for any other person or entity, or use of our name or trademark, is permitted only with our prior written permission. This report sets forth our findings solely with respect to the test samples identified herein. The results set forth in this report are not indicative or representative of the quality or characteristics of the lot from which a test sample was taken or any similar or identical product unless specifically and expressly noted. Our report includes all of the tests requested by you and the results thereof based upon the information that you provided to us. You have 60 days from date of issuance of this report to notify us of any material error or omission caused by our negligence, provided, however, that such notice shall be in writing and shall specifically address the issue you wish to raise. A failure to raise such issue within the prescribed time shall constitute your unqualified acceptance of the completeness of this report, the tests conducted and the correctness of the report contents. Unless specific mention, the uncertainty of measurement has been explicitly taken into account to declare the compliance or non-compliance to the specification. The report must not be used by the client to claim product certification, approval, or endorsement by TAF or any government agencies.

## Table of Contents

<b>Release Control Record</b> .....	<b>4</b>
<b>1 Certificate of Conformity</b> .....	<b>5</b>
<b>2 Summary of Test Results</b> .....	<b>6</b>
2.1 Measurement Uncertainty .....	6
2.2 Modification Record .....	6
<b>3 General Information</b> .....	<b>7</b>
3.1 General Description of EUT .....	7
3.2 Description of Test Modes .....	10
3.2.1 Test Mode Applicability and Tested Channel Detail.....	11
3.3 Duty Cycle of Test Signal .....	13
3.4 Description of Support Units .....	14
3.4.1 Configuration of System under Test .....	15
3.5 General Description of Applied Standard.....	16
<b>4 Test Types and Results</b> .....	<b>17</b>
4.1 Radiated Emission and Bandedge Measurement.....	17
4.1.1 Limits of Radiated Emission and Bandedge Measurement .....	17
4.1.2 Test Instruments .....	18
4.1.3 Test Procedure .....	20
4.1.4 Deviation from Test Standard .....	20
4.1.5 Test Setup.....	21
4.1.6 EUT Operating Condition .....	21
4.1.7 Test Results .....	22
4.2 Conducted Emission Measurement .....	53
4.2.1 Limits of Conducted Emission Measurement .....	53
4.2.2 Test Instruments .....	53
4.2.3 Test Procedure .....	54
4.2.4 Deviation from Test Standard .....	54
4.2.5 Test Setup.....	54
4.2.6 EUT Operating Condition .....	54
4.2.7 Test Results .....	55
4.3 Transmit Power Measurement .....	57
4.3.1 Limits of Transmit Power Measurement .....	57
4.3.2 Test Setup.....	57
4.3.3 Test Instruments .....	57
4.3.4 Test Procedure .....	58
4.3.5 Deviation from Test Standard .....	58
4.3.6 EUT Operating Condition .....	58
4.3.7 Test Result.....	59
4.4 Peak Power Spectral Density Measurement .....	62
4.4.1 Limits of Peak Power Spectral Density Measurement .....	62
4.4.2 Test Setup.....	62
4.4.3 Test Instruments .....	62
4.4.4 Test Procedure .....	63
4.4.5 Deviation from Test Standard .....	63
4.4.6 EUT Operating Condition .....	63
4.4.7 Test Results .....	64
4.5 Frequency Stability Measurement .....	75
4.5.1 Limits of Frequency Stability Measurement .....	75
4.5.2 Test Setup.....	75
4.5.3 Test Instruments .....	75
4.5.4 Test Procedure .....	75
4.5.5 Deviation from Test Standard .....	75
4.5.6 EUT Operating Condition .....	76



4.5.7 Test Results .....	77
4.6 6dB Bandwidth Measurement.....	78
4.6.1 Limits of 6dB Bandwidth Measurement.....	78
4.6.2 Test Setup.....	78
4.6.3 Test Instruments .....	78
4.6.4 Test Procedure .....	78
4.6.5 Deviation from Test Standard .....	78
4.6.6 EUT Operating Condition .....	78
4.6.7 Test Results .....	79
<b>5 Pictures of Test Arrangements.....</b>	<b>83</b>
<b>Appendix – Information on the Testing Laboratories .....</b>	<b>84</b>



A D T

### Release Control Record

Issue No.	Description	Date Issued
RF150122E07-1	Original release.	Mar. 24, 2015



A D T

## 1 Certificate of Conformity

**Product:** Wireless Cable Modem & Router

**Brand:** ARRIS

**Test Model:** SBG6900-AC

**Sample Status:** ENGINEERING SAMPLE

**Applicant:** ARRIS Group, Inc.

**Test Date:** Feb. 26 to Mar. 12, 2015

**Standard:** 47 CFR FCC Part 15, Subpart E (Section 15.407)  
ANSI C63.10:2009

The above equipment has been tested by **Bureau Veritas Consumer Products Services (H.K.) Ltd., Taoyuan Branch**, and found compliance with the requirement of the above standards. The test record, data evaluation & Equipment Under Test (EUT) configurations represented herein are true and accurate accounts of the measurements of the sample's EMC characteristics under the conditions specified in this report.

**Prepared by :** , **Date:** Mar. 24, 2015  
Lori Chung / Specialist

**Approved by :** , **Date:** Mar. 24, 2015  
May Chen / Manager

## 2 Summary of Test Results

47 CFR FCC Part 15, Subpart E (SECTION 15.407)			
FCC Clause	Test Item	Result	Remarks
15.407(b)(6)	AC Power Conducted Emissions	PASS	Meet the requirement of limit. Minimum passing margin is -18.46dB at 0.46250MHz.
15.407(b) (1/2/3/4/6)	Radiated Emissions & Band Edge Measurement	PASS	Meet the requirement of limit. Minimum passing margin is -0.1dB at 5395.00MHz, 5850.00MHz, 5725.00MHz, 5360.00MHz, 5376.00MHz, 5715.00MHz & 5626.00MHz.
15.407(a)(1/2 /3)	Max Average Transmit Power	PASS	Meet the requirement of limit.
15.407(a)(1/2 /3)	Peak Power Spectral Density	PASS	Meet the requirement of limit.
15.407(e)	6dB bandwidth	PASS	Meet the requirement of limit. (U-NII-3 Band only)
15.407(g)	Frequency Stability	PASS	Meet the requirement of limit.
15.203	Antenna Requirement	PASS	Antenna connector is i-pex(MHF) not a standard connector.

### 2.1 Measurement Uncertainty

Where relevant, the following measurement uncertainty levels have been estimated for tests performed on the EUT as specified in CISPR 16-4-2:

Measurement	Frequency	Expanded Uncertainty (k=2) (±)
Conducted Emissions at mains ports	150kHz ~ 30MHz	2.86 dB
Radiated Emissions up to 1 GHz	30MHz ~ 1GHz	5.43 dB
Radiated Emissions above 1 GHz	1GHz ~ 6GHz	3.65 dB
	6GHz ~ 18GHz	3.88 dB
	18GHz ~ 40GHz	4.11 dB

### 2.2 Modification Record

There were no modifications required for compliance.

### 3 General Information

#### 3.1 General Description of EUT

Product	Wireless Cable Modem & Router
Brand	ARRIS
Test Model	SBG6900-AC
Status of EUT	ENGINEERING SAMPLE
Power Supply Rating	100~240Vac, 50/60Hz
Modulation Type	CCK, DQPSK, DBPSK for DSSS 64QAM, 16QAM, QPSK, BPSK for OFDM 256QAM for OFDM in 11ac mode and VHT (20/40) mode in 2.4GHz
Modulation Technology	DSSS, OFDM
Transfer Rate	802.11b: up to 11Mbps 802.11a / g: up to 54Mbps 802.11n: up to 450Mbps 802.11ac: up to 1300Mbps
Operating Frequency	<b>For 15.407</b> 5.18 ~ 5.24GHz, 5.745 ~ 5.825GHz
	<b>For 15.247</b> 2.412 ~ 2.462GHz
Number of Channel	<b>For 15.407</b> 9 for 802.11a, 802.11n (HT20), 802.11ac (VHT20) 4 for 802.11n (HT40), 802.11ac (VHT40) 2 for 802.11ac (VHT80)
	<b>For 15.247</b> 11 for 802.11b, 802.11g, 802.11n (HT20), VHT20 7 for 802.11n (HT40), VHT40
Output Power	<b>For 15.407</b> <b>CDD Mode:</b> 802.11a: 638.049mW 802.11ac (VHT20): 651.264mW 802.11ac (VHT40): 531.625mW 802.11ac (VHT80): 160.238mW <b>Beamforming Mode:</b> 802.11ac (VHT20): 306.853mW 802.11ac (VHT40): 352.462mW 802.11ac (VHT80): 105.496mW
	<b>For 15.247</b> <b>CDD Mode:</b> 802.11b: 300.9mW 802.11g: 541.786mW VHT20: 598.855mW VHT40: 223.357mW <b>Beamforming Mode:</b> VHT20: 489.08mW VHT40: 186.699mW
Antenna Type	Refer to Note
Antenna Connector	Refer to Note
Accessory Device	NA
Data Cable Supplied	NA

**Note:**

1. The emission of the simultaneous operation (2.4GHz & 5GHz) has been evaluated and no non-compliance was found.
2. The antennas provided to the EUT, please refer to the following table:

2.4GHz								
Antenna No.	PCB Chain No.	Brand	Model	Ant. Gain(dBi) <Including cable loss>	Frequency range (GHz to GHz)	Ant. Type	Connector Type	Cable Length (mm)
361.00624.005	1	FIT	FX02A04-0G-EF	3.72	2.4~2.4835	PCB	i-pex(MHF)	185
361.00625.005	2	FIT	FX02A05-0G-EF	4.59	2.4~2.4835	PCB	i-pex(MHF)	111
361.00626.005	0	FIT	FX02A06-0G-EF	4.2	2.4~2.4835	PCB	i-pex(MHF)	210
5GHz								
Antenna No.	PCB Chain No.	Brand	Model	Ant. Gain(dBi) <Including cable loss>	Frequency range (GHz to GHz)	Ant. Type	Connector Type	Cable Length (mm)
361.00628.005	1	FIT	FX02A07-0G-EF	5.59	5.15~5.85	PCB	i-pex(MHF)	120
361.00629.005	2	FIT	FX02A08-0G-EF	3.42	5.15~5.85	PCB	i-pex(MHF)	190
361.00630.005	0	FIT	FX02A10-0G-EF	3.88	5.15~5.85	PCB	i-pex(MHF)	255

3. The EUT must be supplied with an internal power supply as below table :

Brand	Model No.	Spec.
DVE	DSO-36PFE-12 2 120300	AC Input: 100~240V, 1.3A, 50/60Hz DC Output: 12V, 3A



4. The EUT incorporates a MIMO function.

<b>2.4GHz Band</b>			
<b>MODULATION MODE</b>	<b>DATA RATE (MCS)</b>	<b>TX &amp; RX CONFIGURATION</b>	
<b>802.11b</b>	1 ~ 11Mbps	3TX	3RX
<b>802.11g</b>	6 ~ 54Mbps	3TX	3RX
<b>802.11n (HT20)</b>	MCS 0~7	3TX	3RX
	MCS 8~15	3TX	3RX
	MCS 16~23	3TX	3RX
<b>802.11n (HT40)</b>	MCS 0~7	3TX	3RX
	MCS 8~15	3TX	3RX
	MCS 16~23	3TX	3RX
<b>VHT20</b>	MCS 0~8, Nss=1	3TX	3RX
	MCS 0~8, Nss=2	3TX	3RX
	MCS 0~9, Nss=3	3TX	3RX
<b>VHT40</b>	MCS 0~9, Nss=1	3TX	3RX
	MCS 0~9, Nss=2	3TX	3RX
	MCS 0~9, Nss=3	3TX	3RX
<b>5GHz Band</b>			
<b>MODULATION MODE</b>	<b>DATA RATE (MCS)</b>	<b>TX &amp; RX CONFIGURATION</b>	
<b>802.11a</b>	6 ~ 54Mbps	3TX	3RX
<b>802.11n (HT20)</b>	MCS 0~7	3TX	3RX
	MCS 8~15	3TX	3RX
	MCS 16~23	3TX	3RX
<b>802.11n (HT40)</b>	MCS 0~7	3TX	3RX
	MCS 8~15	3TX	3RX
	MCS 16~23	3TX	3RX
<b>802.11ac (VHT20)</b>	MCS 0~8, Nss=1	3TX	3RX
	MCS 0~8, Nss=2	3TX	3RX
	MCS 0~9, Nss=3	3TX	3RX
<b>802.11ac (VHT40)</b>	MCS 0~9, Nss=1	3TX	3RX
	MCS 0~9, Nss=2	3TX	3RX
	MCS 0~9, Nss=3	3TX	3RX
<b>802.11ac (VHT80)</b>	MCS 0~9, Nss=1	3TX	3RX
	MCS 0~9, Nss=2	3TX	3RX
	MCS 0~9, Nss=3	3TX	3RX

Note: The modulation and bandwidth are similar for 802.11n mode for 20MHz (40MHz) and 802.11ac mode for 20MHz (40MHz), therefore investigated worst case to representative mode in test report. (Final test mode refer section 3.2.1)

5. The above EUT information is declared by manufacturer and for more detailed features description, please refer to the manufacturer's specifications or user's manual.

### 3.2 Description of Test Modes

#### FOR 5180 ~ 5240MHz

4 channels are provided for 802.11a, 802.11n (HT20), 802.11ac (VHT20):

Channel	Frequency	Channel	Frequency
36	5180 MHz	44	5220 MHz
40	5200 MHz	48	5240 MHz

2 channels are provided for 802.11n (HT40), 802.11ac (VHT40):

Channel	Frequency	Channel	Frequency
38	5190 MHz	46	5230 MHz

1 channel is provided for 802.11ac (VHT80):

Channel	Frequency
42	5210MHz

#### FOR 5745 ~ 5825MHz:

5 channels are provided for 802.11a, 802.11n (HT20), 802.11ac (VHT20):

Channel	Frequency	Channel	Frequency
149	5745MHz	161	5805MHz
153	5765MHz	165	5825MHz
157	5785MHz		

2 channels are provided for 802.11n (HT40), 802.11ac (VHT40):

Channel	Frequency	Channel	Frequency
151	5755MHz	159	5795MHz

1 channel is provided for 802.11ac (VHT80):

Channel	Frequency
155	5775MHz

### 3.2.1 Test Mode Applicability and Tested Channel Detail

EUT CONFIGURE MODE	APPLICABLE TO				DESCRIPTION
	RE≥1G	RE<1G	PLC	APCM	
*	√	√	√	√	*

Where **RE≥1G**: Radiated Emission above 1GHz      **RE<1G**: Radiated Emission below 1GHz  
**PLC**: Power Line Conducted Emission      **APCM**: Antenna Port Conducted Measurement

#### Radiated Emission Test (Above 1GHz):

- Pre-Scan has been conducted to determine the worst-case mode from all possible combinations between available modulations, data rates and antenna ports (if EUT with antenna diversity architecture).
- Following channel(s) was (were) selected for the final test as listed below.

CDD MODE						
MODE	FREQ. BAND (MHz)	AVAILABLE CHANNEL	TESTED CHANNEL	MODULATION TECHNOLOGY	MODULATION TYPE	DATA RATE (Mbps)
802.11a	5180-5240	36 to 48	36, 40, 48	OFDM	BPSK	6
802.11ac (VHT20)		36 to 48	36, 40, 48	OFDM	BPSK	6.5
802.11ac (VHT40)		38 to 46	38, 46	OFDM	BPSK	13.5
802.11ac (VHT80)		42	42	OFDM	BPSK	29.3
802.11a	5745-5825	149 to 165	149, 157, 165	OFDM	BPSK	6
802.11ac (VHT20)		149 to 165	149, 157, 165	OFDM	BPSK	6.5
802.11ac (VHT40)		151 to 159	151, 159	OFDM	BPSK	13.5
802.11ac (VHT80)		155	155	OFDM	BPSK	29.3
Beamforming MODE						
MODE	FREQ. BAND (MHz)	AVAILABLE CHANNEL	TESTED CHANNEL	MODULATION TECHNOLOGY	MODULATION TYPE	DATA RATE (Mbps)
802.11ac (VHT20)	5180-5240	36 to 48	36, 40, 48	OFDM	BPSK	6.5
802.11ac (VHT40)		38 to 46	38, 46	OFDM	BPSK	13.5
802.11ac (VHT80)		42	42	OFDM	BPSK	29.3
802.11ac (VHT20)	5745-5825	149 to 165	149, 157, 165	OFDM	BPSK	6.5
802.11ac (VHT40)		151 to 159	151, 159	OFDM	BPSK	13.5
802.11ac (VHT80)		155	155	OFDM	BPSK	29.3

#### Radiated Emission Test (Below 1GHz):

- Pre-Scan has been conducted to determine the worst-case mode from all possible combinations between available modulations, data rates and antenna ports (if EUT with antenna diversity architecture).
- Following channel(s) was (were) selected for the final test as listed below.

CDD MODE						
MODE	FREQ. BAND (MHz)	AVAILABLE CHANNEL	TESTED CHANNEL	MODULATION TECHNOLOGY	MODULATION TYPE	DATA RATE (Mbps)
802.11ac (VHT20)	5745-5825	149 to 165	157	OFDM	BPSK	6.5

**Power Line Conducted Emission Test:**

- Pre-Scan has been conducted to determine the worst-case mode from all possible combinations between available modulations, data rates and antenna ports (if EUT with antenna diversity architecture).
- Following channel(s) was (were) selected for the final test as listed below.

<b>CDD MODE</b>						
<b>MODE</b>	<b>FREQ. BAND (MHz)</b>	<b>AVAILABLE CHANNEL</b>	<b>TESTED CHANNEL</b>	<b>MODULATION TECHNOLOGY</b>	<b>MODULATION TYPE</b>	<b>DATA RATE (Mbps)</b>
802.11ac (VHT20)	5745-5825	149 to 165	157	OFDM	BPSK	6.5

**Antenna Port Conducted Measurement:**

- This item includes all test value of each mode, but only includes spectrum plot of worst value of each mode.
- Pre-Scan has been conducted to determine the worst-case mode from all possible combinations between available modulations, data rates and antenna ports (if EUT with antenna diversity architecture).
- Following channel(s) was (were) selected for the final test as listed below.

<b>CDD MODE</b>						
<b>MODE</b>	<b>FREQ. BAND (MHz)</b>	<b>AVAILABLE CHANNEL</b>	<b>TESTED CHANNEL</b>	<b>MODULATION TECHNOLOGY</b>	<b>MODULATION TYPE</b>	<b>DATA RATE (Mbps)</b>
802.11a	5180-5240	36 to 48	36, 40, 48	OFDM	BPSK	6
802.11ac (VHT20)		36 to 48	36, 40, 48	OFDM	BPSK	6.5
802.11ac (VHT40)		38 to 46	38, 46	OFDM	BPSK	13.5
802.11ac (VHT80)		42	42	OFDM	BPSK	29.3
802.11a	5745-5825	149 to 165	149, 157, 165	OFDM	BPSK	6
802.11ac (VHT20)		149 to 165	149, 157, 165	OFDM	BPSK	6.5
802.11ac (VHT40)		151 to 159	151, 159	OFDM	BPSK	13.5
802.11ac (VHT80)		155	155	OFDM	BPSK	29.3
<b>Beamforming MODE</b>						
<b>MODE</b>	<b>FREQ. BAND (MHz)</b>	<b>AVAILABLE CHANNEL</b>	<b>TESTED CHANNEL</b>	<b>MODULATION TECHNOLOGY</b>	<b>MODULATION TYPE</b>	<b>DATA RATE (Mbps)</b>
802.11ac (VHT20)	5180-5240	36 to 48	36, 40, 48	OFDM	BPSK	6.5
802.11ac (VHT40)		38 to 46	38, 46	OFDM	BPSK	13.5
802.11ac (VHT80)		42	42	OFDM	BPSK	29.3
802.11ac (VHT20)	5745-5825	149 to 165	149, 157, 165	OFDM	BPSK	6.5
802.11ac (VHT40)		151 to 159	151, 159	OFDM	BPSK	13.5
802.11ac (VHT80)		155	155	OFDM	BPSK	29.3

**Test Condition:**

<b>APPLICABLE TO</b>	<b>ENVIRONMENTAL CONDITIONS</b>	<b>INPUT POWER</b>	<b>TESTED BY</b>
<b>RE<sub>≥</sub>1G</b>	25deg. C, 65%RH	120Vac, 60Hz	Chris Lin
<b>RE<sub>&lt;</sub>1G</b>	25deg. C, 65%RH	120Vac, 60Hz	Chris Lin
<b>PLC</b>	25deg. C, 68%RH	120Vac, 60Hz	Sun Lin
<b>APCM</b>	21deg. C, 60%RH	120Vac, 60Hz	Nick Chen

### 3.3 Duty Cycle of Test Signal

If duty cycle of test signal is  $\geq 98\%$ , duty factor is not required.

If duty cycle of test signal is  $< 98\%$ , duty factor shall be considered.

**802.11a:** Duty cycle =  $2.059 \text{ ms} / 2.096 \text{ ms} = 0.982$

**802.11ac (VHT20):** Duty cycle =  $1.924 \text{ ms} / 1.957 \text{ ms} = 0.983$

**802.11ac (VHT40):** Duty cycle =  $0.941 \text{ ms} / 0.981 \text{ ms} = 0.959$ , Duty factor =  $10 * \log(1/0.959) = 0.18$

**802.11ac (VHT80):** Duty cycle =  $0.46 \text{ ms} / 0.49 \text{ ms} = 0.939$ , Duty factor =  $10 * \log(1/0.939) = 0.27$

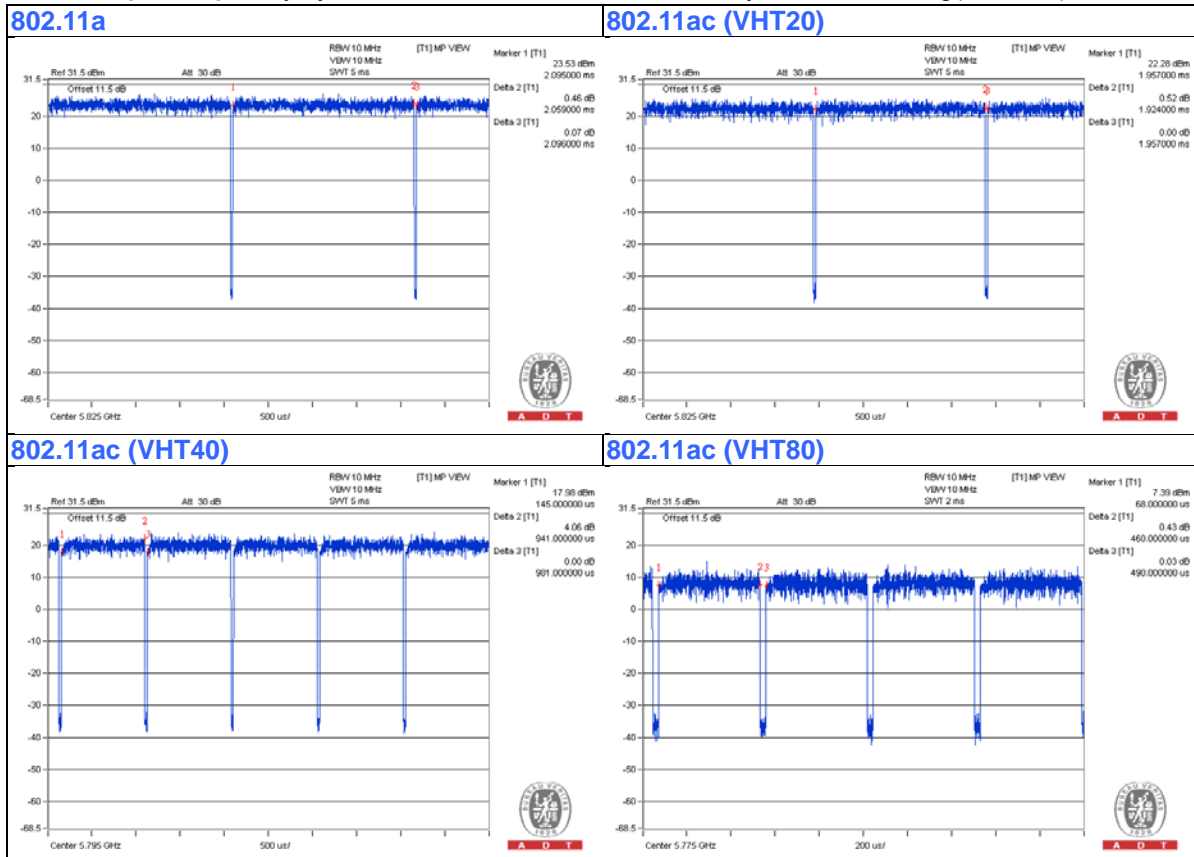

### 3.4 Description of Support Units

The EUT has been tested as an independent unit together with other necessary accessories or support units. The following support units or accessories were used to form a representative test configuration during the tests.

No.	Product	Brand	Model No.	Serial No.	FCC ID	Remark
A	iPod shuffle	Apple	MC749TA/A	CC4DMFJUDFDM	NA	Provided by Lab
B	iPod shuffle	Apple	MC749TA/A	CC4DN25WDFDM	NA	Provided by Lab
C	NOTEBOOK COMPUTER	DELL	E6420	H62T3R1	FCC DoC	Supplied by Client
D	HUB	ZyXEL	ES-116P	S060H02000215	FCC DoC	Provided by Lab

**NOTE:**

1. All power cords of the above support units are non-shielded (1.8 m).

No.	Cable	Qty.	Length (m)	Shielded (Yes/ No)	Cores (Number)	Remark
1	AC	1	1.5	No	0	Supplied by Client
2	Coaxial	1	10	No	0	Provided by Lab
3	UTP	1	10	No	0	Provided by Lab
4	UTP	1	10	No	0	Provided by Lab
5	USB	1	0.1	No	0	Provided by Lab

### 3.4.1 Configuration of System under Test

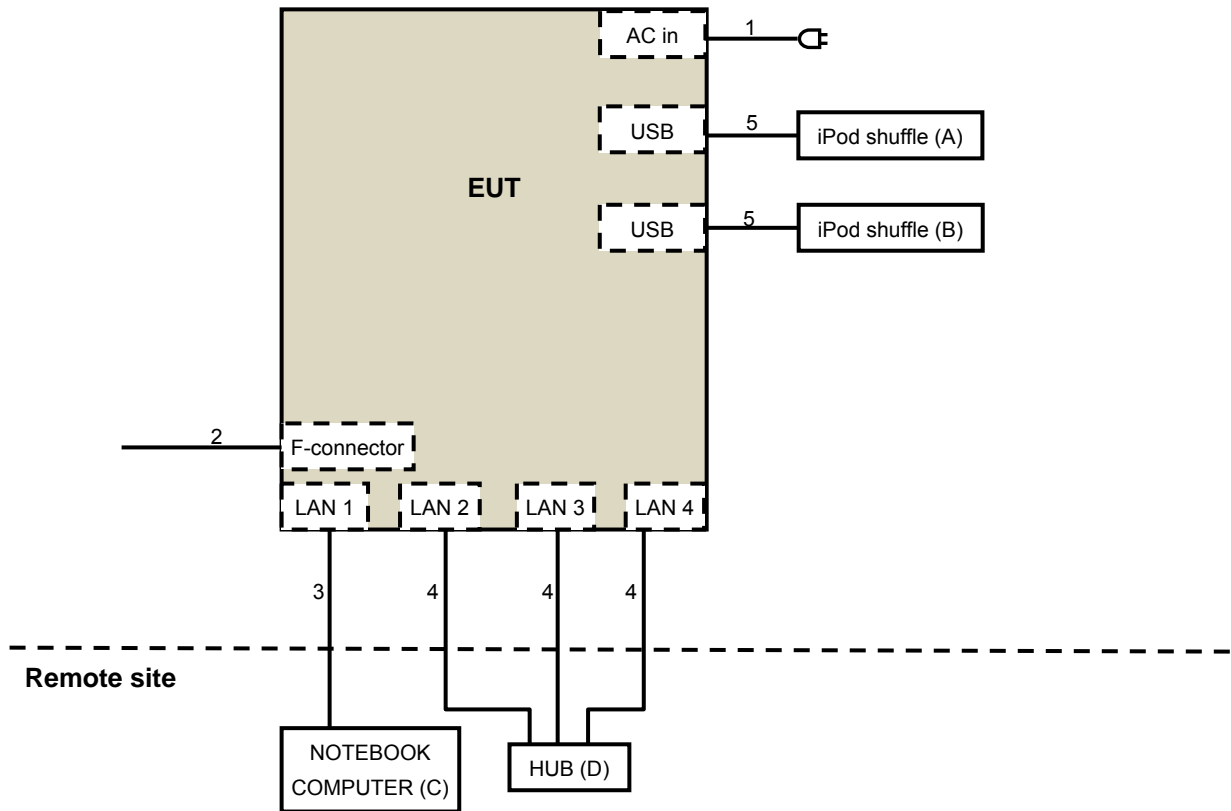

### 3.5 General Description of Applied Standard

The EUT is a RF Product. According to the specifications of the manufacturer, it must comply with the requirements of the following standards:

**FCC Part 15, Subpart E (15.407)**  
**789033 D02 General UNII Test Procedure New Rules v01**  
**662911 D01 Multiple Transmitter Output v02r01**  
ANSI C63.10-2009

All test items have been performed and recorded as per the above standards.

**NOTE:** The EUT has been verified to comply with the requirements of FCC Part 15, Subpart B, Class B (DoC). The test report has been issued separately.



## 4 Test Types and Results

### 4.1 Radiated Emission and Bandedge Measurement

#### 4.1.1 Limits of Radiated Emission and Bandedge Measurement

Radiated emissions which fall in the restricted bands must comply with the radiated emission limits specified as below table.

Frequencies (MHz)	Field Strength (microvolts/meter)	Measurement Distance (meters)
0.009 ~ 0.490	2400/F(kHz)	300
0.490 ~ 1.705	24000/F(kHz)	30
1.705 ~ 30.0	30	30
30 ~ 88	100	3
88 ~ 216	150	3
216 ~ 960	200	3
Above 960	500	3

#### NOTE:

1. The lower limit shall apply at the transition frequencies.
2. Emission level (dBuV/m) = 20 log Emission level (uV/m).
3. For frequencies above 1000MHz, the field strength limits are based on average detector, however, the peak field strength of any emission shall not exceed the maximum permitted average limits, specified above by more than 20dB under any condition of modulation.

#### LIMITS OF UNWANTED EMISSION OUT OF THE RESTRICTED BANDS

APPLICABLE TO	LIMIT	
789033 D02 General UNII Test Procedure New Rules v01	FIELD STRENGTH AT 3m	
	PK:74 (dBuV/m)	AV:54 (dBuV/m)
APPLICABLE TO	EIRP LIMIT	EQUIVALENT FIELD STRENGTH AT 3m
15.407(b)(1)	PK:-27 (dBm/MHz)	PK:68.2(dBuV/m)
15.407(b)(2)		
15.407(b)(3)		
15.407(b)(4)	PK:-27 (dBm/MHz) <sup>*1</sup> PK:-17 (dBm/MHz) <sup>*2</sup>	PK: 68.2(dBuV/m) <sup>*1</sup> PK:78.2 (dBuV/m) <sup>*2</sup>

**NOTE:** <sup>\*1</sup> beyond 10MHz of the band edge <sup>\*2</sup> within 10 MHz of band edge

The following formula is used to convert the equipment isotropic radiated power (eirp) to field strength:

$$E = \frac{1000000\sqrt{30P}}{3} \mu\text{V/m, where P is the eirp (Watts).}$$

#### 4.1.2 Test Instruments

##### For Below 1GHz test:

DESCRIPTION & MANUFACTURER	MODEL NO.	SERIAL NO.	CALIBRATED DATE	CALIBRATED UNTIL
MXE EMI Receiver Agilent	N9038A	MY50010156	Aug. 11, 2014	Aug. 10, 2015
Pre-Amplifier Mini-Circuits	ZFL-1000VH2 B	AMP-ZFL-04	Nov. 12, 2014	Nov. 11, 2015
Trilog Broadband Antenna SCHWARZBECK	VULB 9168	9168-361	Feb. 27, 2014	Feb. 26, 2015
RF Cable	NA	CHHCAB_001	Oct. 05, 2014	Oct. 04, 2015
Horn_Antenna AISI	AIH.8018	0000220091110	Aug. 26, 2014	Aug. 25, 2015
Pre-Amplifier Agilent	8449B	300801923	Oct. 28, 2014	Oct. 27, 2015
RF Cable	NA	131206 131215 SNMY23685/4	Jan. 16, 2015	Jan. 15, 2016
Spectrum Analyzer R&S	FSV40	100964	July 05, 2014	July 04, 2015
Pre-Amplifier EMCI	EMC184045	980143	Jan. 16, 2015	Jan. 15, 2016
Horn_Antenna SCHWARZBECK	BBHA 9170	9170-424	Aug. 26, 2014	Aug. 25, 2015
RF Cable	NA	RF104-121 RF104-204	Dec. 11, 2014	Dec. 10, 2015
Software	ADT_Radiated _V8.7.07	NA	NA	NA
Antenna Tower & Turn Table CT	NA	NA	NA	NA

##### Note:

1. The calibration interval of the above test instruments is 12 months and the calibrations are traceable to NML/ROC and NIST/USA.
2. The horn antenna, preamplifier (model: 8449B) are used only for the measurement of emission frequency above 1GHz if tested.
- 3 The test was performed in 966 Chamber No. H.
4. The FCC Site Registration No. is 797305.
- 5 The CANADA Site Registration No. is IC 7450H-3.
- 6 Tested Date: Feb. 26, 2015

**For Above 1GHz test:**

DESCRIPTION & MANUFACTURER	MODEL NO.	SERIAL NO.	CALIBRATED DATE	CALIBRATED UNTIL
MXE EMI Receiver Agilent	N9038A	MY51210105	July 21, 2014	July 20, 2015
Pre-Amplifier Mini-Circuits	ZFL-1000VH2 B	AMP-ZFL-03	Nov. 12, 2014	Nov. 11, 2015
Trilog Broadband Antenna SCHWARZBECK	VULB 9168	9168-360	Feb. 06, 2015	Feb. 05, 2016
RF Cable	NA	CHGCAB_001	Oct. 04, 2014	Oct. 03, 2015
Horn_Antenna AISI	AIH.8018	0000320091110	Aug. 27, 2014	Aug. 26, 2015
Pre-Amplifier Agilent	8449B	3008A02578	June 24, 2014	June 23, 2015
RF Cable	NA	131205 131214 SNMY23684/4	Jan. 16, 2015	Jan. 15, 2016
Spectrum Analyzer R&S	FSV40	100964	July 05, 2014	July 04, 2015
Pre-Amplifier EMCI	EMC184045	980143	Jan. 16, 2015	Jan. 15, 2016
Horn_Antenna SCHWARZBECK	BBHA 9170	9170-424	Aug. 26, 2014	Aug. 25, 2015
RF Cable	NA	RF104-121 RF104-204	Dec. 11, 2014	Dec. 10, 2015
Antenna Tower & Turn Table CT	NA	NA	NA	NA

**Note:**

1. The calibration interval of the above test instruments is 12 months and the calibrations are traceable to NML/ROC and NIST/USA.
2. The horn antenna, preamplifier (model: 8449B) are used only for the measurement of emission frequency above 1GHz if tested.
3. The test was performed in 966 Chamber No. G.
4. The FCC Site Registration No. is 966073.
5. The VCCI Site Registration No. is G-137.
6. The CANADA Site Registration No. is IC 7450H-2.
7. Tested Date: Mar. 05 to 06, 2015

#### 4.1.3 Test Procedure

- a. The EUT was placed on the top of a rotating table 0.8 meters above the ground at 3 meter chamber room for test. The table was rotated 360 degrees to determine the position of the highest radiation.
- b. The EUT was set 3 meters away from the interference-receiving antenna, which was mounted on the top of a variable-height antenna tower.
- c. The height of antenna is varied from one meter to four meters above the ground to determine the maximum value of the field strength. Both horizontal and vertical polarizations of the antenna are set to make the measurement.
- d. For each suspected emission, the EUT was arranged to its worst case and then the antenna was tuned to heights from 1 meter to 4 meters and the rotatable table was turned from 0 degrees to 360 degrees to find the maximum reading.
- e. The test-receiver system was set to quasi-peak detect function and specified bandwidth with maximum hold mode when the test frequency is below 1 GHz.
- f. The test-receiver system was set to peak and average detect function and specified bandwidth with maximum hold mode when the test frequency is above 1 GHz. If the peak reading value also meets average limit, measurement with the average detector is unnecessary.

#### Note:

1. For emission measurements above 1 GHz, the EUT shall be placed at a height of 1.5 m above the ground at 3 meter chamber room for test
2. The resolution bandwidth and video bandwidth of test receiver/spectrum analyzer is 120kHz for Quasi-peak detection (QP) at frequency below 1GHz.
3. The resolution bandwidth of test receiver/spectrum analyzer is 1 MHz and the video bandwidth is 3 MHz for Peak detection (PK) at frequency above 1GHz.
4. The resolution bandwidth of test receiver/spectrum analyzer is 1MHz and the video bandwidth is 3MHz for RMS Average (Duty cycle < 98%) for Average detection (AV) at frequency above 1GHz, then the measurement results was added to a correction factor ( $10 \log(1/\text{duty cycle})$ ).
5. The resolution bandwidth of test receiver/spectrum analyzer is 1MHz and the video bandwidth is 10Hz (Duty cycle  $\geq 98\%$ ) for Average detection (AV) at frequency above 1GHz.
6. All modes of operation were investigated and the worst-case emissions are reported.

#### 4.1.4 Deviation from Test Standard

No deviation.

#### 4.1.5 Test Setup

##### <Frequency Range below 1GHz>

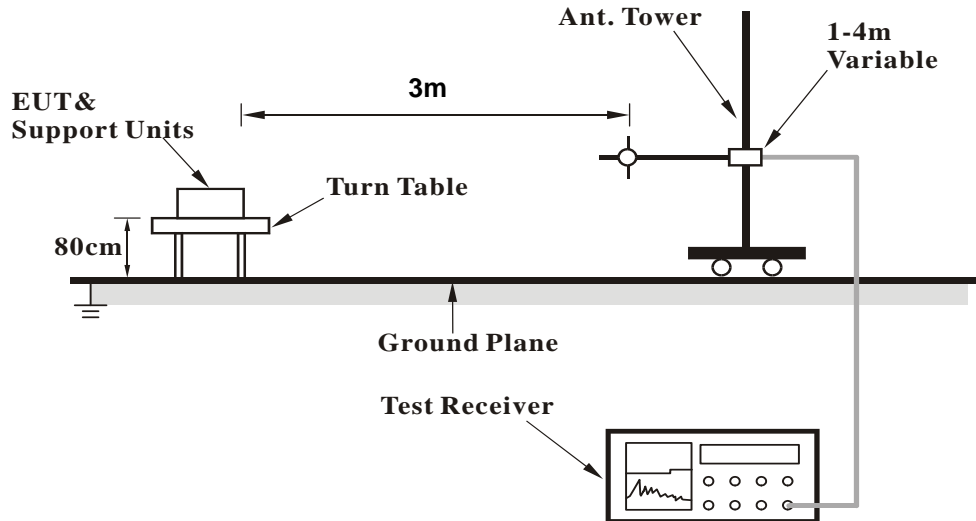

##### <Frequency Range above 1GHz>

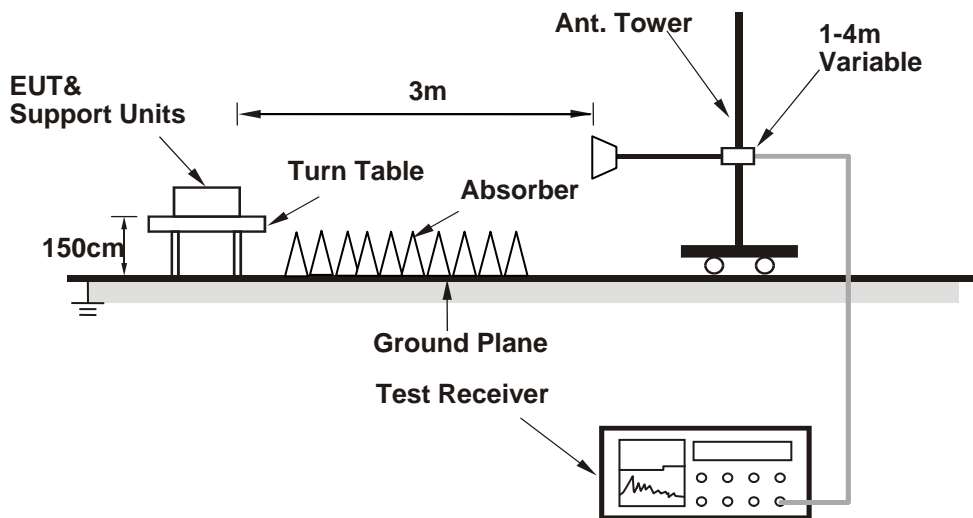

For the actual test configuration, please refer to the attached file (Test Setup Photo).

#### 4.1.6 EUT Operating Condition

1. Connect the EUT with the support unit C (NOTEBOOK COMPUTER) which is placed on remote site.
2. Controlling software (MTool 2.0.1.0.exe) has been activated to set the EUT on specific status.

**4.1.7 Test Results**
**CDD MODE**
**Above 1GHz Data:**
**802.11a**

<b>CHANNEL</b>	TX Channel 36	<b>DETECTOR FUNCTION</b>	Peak (PK)
<b>FREQUENCY RANGE</b>	1GHz ~ 40GHz		Average (AV)

**ANTENNA POLARITY & TEST DISTANCE: HORIZONTAL AT 3 M**

NO.	FREQ. (MHz)	EMISSION LEVEL (dBuV/m)	LIMIT (dBuV/m)	MARGIN (dB)	ANTENNA HEIGHT (m)	TABLE ANGLE (Degree)	RAW VALUE (dBuV)	CORRECTION FACTOR (dB/m)
1	5023.00	60.5 PK	74.0	-13.5	2.19 H	139	57.37	3.13
2	5023.00	50.4 AV	54.0	-3.6	2.19 H	139	47.27	3.13
3	5150.00	71.7 PK	74.0	-2.3	1.56 H	147	68.07	3.63
4	5150.00	53.1 AV	54.0	-0.9	1.56 H	147	49.47	3.63
5	*5180.00	119.1 PK			1.96 H	135	115.33	3.77
6	*5180.00	109.4 AV			1.96 H	135	105.63	3.77
7	5395.00	62.6 PK	74.0	-11.4	1.86 H	119	58.32	4.28
<b>8</b>	<b>5395.00</b>	<b>53.9 AV</b>	<b>54.0</b>	<b>-0.1</b>	<b>1.86 H</b>	<b>119</b>	<b>49.62</b>	<b>4.28</b>
9	#5611.00	59.1 PK	74.0	-14.9	1.62 H	147	54.23	4.87
10	#5611.00	52.3 AV	54.0	-1.7	1.62 H	147	47.43	4.87
11	#5827.00	56.9 PK	74.0	-17.1	1.68 H	115	51.78	5.12
12	#5827.00	50.9 AV	54.0	-3.1	1.68 H	115	45.78	5.12
13	#10360.00	59.8 PK	74.0	-14.2	1.68 H	114	50.43	9.37
14	#10360.00	48.4 AV	54.0	-5.6	1.68 H	114	39.03	9.37
15	15540.00	63.1 PK	74.0	-10.9	1.68 H	185	48.69	14.41
16	15540.00	50.8 AV	54.0	-3.2	1.68 H	185	36.39	14.41

**ANTENNA POLARITY & TEST DISTANCE: VERTICAL AT 3 M**

NO.	FREQ. (MHz)	EMISSION LEVEL (dBuV/m)	LIMIT (dBuV/m)	MARGIN (dB)	ANTENNA HEIGHT (m)	TABLE ANGLE (Degree)	RAW VALUE (dBuV)	CORRECTION FACTOR (dB/m)
1	5023.00	56.7 PK	74.0	-17.3	2.32 V	16	53.57	3.13
2	5023.00	46.5 AV	54.0	-7.5	2.32 V	16	43.37	3.13
3	5150.00	65.5 PK	74.0	-8.5	2.37 V	29	61.87	3.63
4	5150.00	50.6 AV	54.0	-3.4	2.37 V	29	46.97	3.63
5	*5180.00	115.4 PK			1.10 V	84	111.63	3.77
6	*5180.00	105.6 AV			1.10 V	84	101.83	3.77
7	5395.00	58.7 PK	74.0	-15.3	2.95 V	360	54.42	4.28
8	5395.00	47.0 AV	54.0	-7.0	2.95 V	360	42.72	4.28
9	#5611.00	57.6 PK	74.0	-16.4	2.65 V	245	52.73	4.87
10	#5611.00	49.3 AV	54.0	-4.7	2.65 V	245	44.43	4.87
11	#5827.00	54.4 PK	74.0	-19.6	2.58 V	314	49.28	5.12
12	#5827.00	45.3 AV	54.0	-8.7	2.58 V	314	40.18	5.12
13	#10360.00	57.5 PK	74.0	-16.5	1.94 V	300	48.13	9.37
14	#10360.00	46.2 AV	54.0	-7.8	1.94 V	300	36.83	9.37
15	15540.00	67.4 PK	74.0	-6.6	1.81 V	314	52.99	14.41
16	15540.00	53.0 AV	54.0	-1.0	1.81 V	314	38.59	14.41

**REMARKS:**

1. Emission Level(dBuV/m) = Raw Value(dBuV) + Correction Factor(dB/m)
2. Correction Factor(dB/m) = Antenna Factor(dB/m) + Cable Factor(dB) – Pre-Amplifier Factor(dB)
3. The other emission levels were very low against the limit.
4. Margin value = Emission Level – Limit value
5. " \* ": Fundamental frequency.
6. " # ": The radiated frequency is out of the restricted band.

<b>CHANNEL</b>	TX Channel 40	<b>DETECTOR FUNCTION</b>	Peak (PK)
<b>FREQUENCY RANGE</b>	1GHz ~ 40GHz		Average (AV)

**ANTENNA POLARITY & TEST DISTANCE: HORIZONTAL AT 3 M**

NO.	FREQ. (MHz)	EMISSION LEVEL (dBuV/m)	LIMIT (dBuV/m)	MARGIN (dB)	ANTENNA HEIGHT (m)	TABLE ANGLE (Degree)	RAW VALUE (dBuV)	CORRECTION FACTOR (dB/m)
1	5040.00	57.8 PK	74.0	-16.2	2.03 H	183	54.60	3.20
2	5040.00	47.8 AV	54.0	-6.2	2.03 H	183	44.60	3.20
3	*5200.00	117.2 PK			1.67 H	145	113.34	3.86
4	*5200.00	107.2 AV			1.67 H	145	103.34	3.86
5	5360.00	65.3 PK	74.0	-8.7	2.37 H	297	61.17	4.13
6	5360.00	53.5 AV	54.0	-0.5	2.37 H	297	49.37	4.13
7	#5633.00	57.8 PK	74.0	-16.2	1.52 H	146	52.92	4.88
8	#5633.00	50.9 AV	54.0	-3.1	1.52 H	146	46.02	4.88
9	#10400.00	59.3 PK	74.0	-14.7	1.67 H	112	49.88	9.42
10	#10400.00	48.0 AV	54.0	-6.0	1.67 H	112	38.58	9.42
11	15600.00	63.8 PK	74.0	-10.2	1.61 H	191	49.11	14.69
12	15600.00	51.7 AV	54.0	-2.3	1.61 H	191	37.01	14.69

**ANTENNA POLARITY & TEST DISTANCE: VERTICAL AT 3 M**

NO.	FREQ. (MHz)	EMISSION LEVEL (dBuV/m)	LIMIT (dBuV/m)	MARGIN (dB)	ANTENNA HEIGHT (m)	TABLE ANGLE (Degree)	RAW VALUE (dBuV)	CORRECTION FACTOR (dB/m)
1	5040.00	53.6 PK	74.0	-20.4	1.48 V	135	50.40	3.20
2	5040.00	43.4 AV	54.0	-10.6	1.48 V	135	40.20	3.20
3	*5200.00	112.5 PK			1.41 V	132	108.64	3.86
4	*5200.00	103.3 AV			1.41 V	132	99.44	3.86
5	5360.00	64.2 PK	74.0	-9.8	1.79 V	360	60.07	4.13
6	5360.00	52.9 AV	54.0	-1.1	1.79 V	360	48.77	4.13
7	#5633.00	55.3 PK	74.0	-18.7	1.76 V	249	50.42	4.88
8	#5633.00	46.5 AV	54.0	-7.5	1.76 V	249	41.62	4.88
9	#10400.00	56.8 PK	74.0	-17.2	1.99 V	292	47.38	9.42
10	#10400.00	45.8 AV	54.0	-8.2	1.99 V	292	36.38	9.42
11	15600.00	67.5 PK	74.0	-6.5	1.88 V	322	52.81	14.69
12	15600.00	52.1 AV	54.0	-1.9	1.88 V	322	37.41	14.69

**REMARKS:**

1. Emission Level(dBuV/m) = Raw Value(dBuV) + Correction Factor(dB/m)
2. Correction Factor(dB/m) = Antenna Factor(dB/m) + Cable Factor(dB) – Pre-Amplifier Factor(dB)
3. The other emission levels were very low against the limit.
4. Margin value = Emission Level – Limit value
5. " \* ": Fundamental frequency.
6. " # ": The radiated frequency is out of the restricted band.



<b>CHANNEL</b>	TX Channel 48	<b>DETECTOR FUNCTION</b>	Peak (PK)
<b>FREQUENCY RANGE</b>	1GHz ~ 40GHz		Average (AV)

**ANTENNA POLARITY & TEST DISTANCE: HORIZONTAL AT 3 M**

NO.	FREQ. (MHz)	EMISSION LEVEL (dBUV/m)	LIMIT (dBUV/m)	MARGIN (dB)	ANTENNA HEIGHT (m)	TABLE ANGLE (Degree)	RAW VALUE (dBUV)	CORRECTION FACTOR (dB/m)
1	5078.00	56.7 PK	74.0	-17.3	1.50 H	154	53.36	3.34
2	5078.00	46.2 AV	54.0	-7.8	1.50 H	154	42.86	3.34
3	*5240.00	113.8 PK			2.01 H	133	109.92	3.88
4	*5240.00	105.4 AV			2.01 H	133	101.52	3.88
5	5398.00	61.7 PK	74.0	-12.3	1.71 H	118	57.40	4.30
6	5398.00	53.7 AV	54.0	-0.3	1.71 H	118	49.40	4.30
7	5458.00	57.8 PK	74.0	-16.2	2.00 H	115	53.46	4.34
8	5458.00	52.8 AV	54.0	-1.2	2.00 H	115	48.46	4.34
9	#5894.00	55.4 PK	74.0	-18.6	1.27 H	139	50.09	5.31
10	#5894.00	48.3 AV	54.0	-5.7	1.27 H	139	42.99	5.31
11	#10480.00	59.9 PK	74.0	-14.1	1.69 H	93	50.30	9.60
12	#10480.00	48.5 AV	54.0	-5.5	1.69 H	93	38.90	9.60
13	15720.00	63.1 PK	74.0	-10.9	1.67 H	181	48.95	14.15
14	15720.00	50.9 AV	54.0	-3.1	1.67 H	181	36.75	14.15

**ANTENNA POLARITY & TEST DISTANCE: VERTICAL AT 3 M**

NO.	FREQ. (MHz)	EMISSION LEVEL (dBUV/m)	LIMIT (dBUV/m)	MARGIN (dB)	ANTENNA HEIGHT (m)	TABLE ANGLE (Degree)	RAW VALUE (dBUV)	CORRECTION FACTOR (dB/m)
1	5078.00	54.9 PK	74.0	-19.1	1.32 V	84	51.56	3.34
2	5078.00	43.1 AV	54.0	-10.9	1.32 V	84	39.76	3.34
3	*5240.00	109.2 PK			1.46 V	84	105.32	3.88
4	*5240.00	101.8 AV			1.46 V	84	97.92	3.88
5	5398.00	60.7 PK	74.0	-13.3	1.00 V	84	56.40	4.30
6	5398.00	48.2 AV	54.0	-5.8	1.00 V	84	43.90	4.30
7	5458.00	54.7 PK	74.0	-19.3	1.34 V	79	50.36	4.34
8	5458.00	49.8 AV	54.0	-4.2	1.34 V	79	45.46	4.34
9	#5894.00	54.3 PK	74.0	-19.7	1.00 V	75	48.99	5.31
10	#5894.00	45.3 AV	54.0	-8.7	1.00 V	75	39.99	5.31
11	#10480.00	57.4 PK	74.0	-16.6	2.01 V	313	47.80	9.60
12	#10480.00	45.8 AV	54.0	-8.2	2.01 V	313	36.20	9.60
13	15720.00	67.8 PK	74.0	-6.2	1.85 V	310	53.65	14.15
14	15720.00	52.4 AV	54.0	-1.6	1.85 V	310	38.25	14.15

**REMARKS:**

1. Emission Level(dBUV/m) = Raw Value(dBUV) + Correction Factor(dB/m)
2. Correction Factor(dB/m) = Antenna Factor(dB/m) + Cable Factor(dB) – Pre-Amplifier Factor(dB)
3. The other emission levels were very low against the limit.
4. Margin value = Emission Level – Limit value
5. " \* ": Fundamental frequency.
6. " # ": The radiated frequency is out of the restricted band.





<b>CHANNEL</b>	TX Channel 149	<b>DETECTOR FUNCTION</b>	Peak (PK)
<b>FREQUENCY RANGE</b>	1GHz ~ 40GHz		Average (AV)

**ANTENNA POLARITY & TEST DISTANCE: HORIZONTAL AT 3 M**

NO.	FREQ. (MHz)	EMISSION LEVEL (dBuV/m)	LIMIT (dBuV/m)	MARGIN (dB)	ANTENNA HEIGHT (m)	TABLE ANGLE (Degree)	RAW VALUE (dBuV)	CORRECTION FACTOR (dB/m)
1	#5586.00	61.8 PK	74.0	-12.2	1.55 H	152	57.01	4.79
2	#5586.00	52.8 AV	54.0	-1.2	1.55 H	152	48.01	4.79
3	#5715.00	60.1 PK	74.0	-13.9	1.44 H	149	55.17	4.93
4	#5715.00	46.3 AV	54.0	-7.7	1.44 H	149	41.37	4.93
5	#5725.00	77.9 PK	78.2	-0.3	1.49 H	147	72.94	4.96
6	*5745.00	116.9 PK			1.39 H	146	111.93	4.97
7	*5745.00	107.1 AV			1.39 H	146	102.13	4.97
8	#5906.00	61.5 PK	74.0	-12.5	2.47 H	148	56.16	5.34
9	#5906.00	51.8 AV	54.0	-2.2	2.47 H	148	46.46	5.34
10	#5984.00	58.8 PK	74.0	-15.2	2.37 H	144	53.26	5.54
11	#5984.00	52.3 AV	54.0	-1.7	2.37 H	144	46.76	5.54
12	11490.00	59.4 PK	74.0	-14.6	1.04 H	259	48.80	10.60
13	11490.00	46.6 AV	54.0	-7.4	1.04 H	259	36.00	10.60
14	#17235.00	69.8 PK	74.0	-4.2	1.66 H	111	51.59	18.21
15	#17235.00	50.8 AV	54.0	-3.2	1.66 H	111	32.59	18.21

**ANTENNA POLARITY & TEST DISTANCE: VERTICAL AT 3 M**

NO.	FREQ. (MHz)	EMISSION LEVEL (dBuV/m)	LIMIT (dBuV/m)	MARGIN (dB)	ANTENNA HEIGHT (m)	TABLE ANGLE (Degree)	RAW VALUE (dBuV)	CORRECTION FACTOR (dB/m)
1	#5586.00	58.6 PK	74.0	-15.4	1.28 V	193	53.81	4.79
2	#5586.00	46.7 AV	54.0	-7.3	1.28 V	193	41.91	4.79
3	#5715.00	59.6 PK	74.0	-14.4	1.44 V	178	54.67	4.93
4	#5715.00	45.9 AV	54.0	-8.1	1.44 V	178	40.97	4.93
5	#5725.00	76.2 PK	78.2	-2.0	1.54 V	94	71.24	4.96
6	*5745.00	113.2 PK			1.58 V	181	108.23	4.97
7	*5745.00	103.8 AV			1.58 V	181	98.83	4.97
8	#5906.00	61.4 PK	74.0	-12.6	1.40 V	185	56.06	5.34
9	#5906.00	51.6 AV	54.0	-2.4	1.40 V	185	46.26	5.34
10	#5984.00	57.2 PK	74.0	-16.8	1.23 V	154	51.66	5.54
11	#5984.00	48.1 AV	54.0	-5.9	1.23 V	154	42.56	5.54
12	11490.00	56.9 PK	74.0	-17.1	1.46 V	153	46.30	10.60
13	11490.00	47.0 AV	54.0	-7.0	1.46 V	153	36.40	10.60
14	#17235.00	68.3 PK	74.0	-5.7	1.40 V	127	50.09	18.21
15	#17235.00	49.7 AV	54.0	-4.3	1.40 V	127	31.49	18.21

**REMARKS:**

1. Emission Level(dBuV/m) = Raw Value(dBuV) + Correction Factor(dB/m)
2. Correction Factor(dB/m) = Antenna Factor(dB/m) + Cable Factor(dB) – Pre-Amplifier Factor(dB)
3. The other emission levels were very low against the limit.
4. Margin value = Emission Level – Limit value
5. " \* ": Fundamental frequency.
6. " # ": The radiated frequency is out of the restricted band.

<b>CHANNEL</b>	TX Channel 157	<b>DETECTOR FUNCTION</b>	Peak (PK)
<b>FREQUENCY RANGE</b>	1GHz ~ 40GHz		Average (AV)

**ANTENNA POLARITY & TEST DISTANCE: HORIZONTAL AT 3 M**

NO.	FREQ. (MHz)	EMISSION LEVEL (dBuV/m)	LIMIT (dBuV/m)	MARGIN (dB)	ANTENNA HEIGHT (m)	TABLE ANGLE (Degree)	RAW VALUE (dBuV)	CORRECTION FACTOR (dB/m)
1	#5626.00	67.8 PK	68.2	-0.4	1.48 H	151	62.93	4.87
2	*5785.00	120.7 PK			1.48 H	181	115.67	5.03
3	*5785.00	111.2 AV			1.48 H	181	106.17	5.03
4	11570.00	59.3 PK	74.0	-14.7	1.14 H	287	48.74	10.56
5	11570.00	46.7 AV	54.0	-7.3	1.14 H	287	36.14	10.56
6	#17355.00	69.4 PK	74.0	-4.6	1.56 H	109	50.58	18.82
7	#17355.00	50.7 AV	54.0	-3.3	1.56 H	109	31.88	18.82

**ANTENNA POLARITY & TEST DISTANCE: VERTICAL AT 3 M**

NO.	FREQ. (MHz)	EMISSION LEVEL (dBuV/m)	LIMIT (dBuV/m)	MARGIN (dB)	ANTENNA HEIGHT (m)	TABLE ANGLE (Degree)	RAW VALUE (dBuV)	CORRECTION FACTOR (dB/m)
1	#5626.00	65.0 PK	68.2	-3.2	1.52 V	212	60.13	4.87
2	*5785.00	117.0 PK			1.04 V	154	111.97	5.03
3	*5785.00	107.9 AV			1.04 V	154	102.87	5.03
4	11570.00	57.6 PK	74.0	-16.4	1.61 V	141	47.04	10.56
5	11570.00	46.7 AV	54.0	-7.3	1.61 V	141	36.14	10.56
6	#17355.00	69.0 PK	74.0	-5.0	1.51 V	128	50.18	18.82
7	#17355.00	50.2 AV	54.0	-3.8	1.51 V	128	31.38	18.82

**REMARKS:**

- Emission Level(dBuV/m) = Raw Value(dBuV) + Correction Factor(dB/m)
- Correction Factor(dB/m) = Antenna Factor(dB/m) + Cable Factor(dB) – Pre-Amplifier Factor(dB)
- The other emission levels were very low against the limit.
- Margin value = Emission Level – Limit value
- " \* ": Fundamental frequency.
- " # ": The radiated frequency is out of the restricted band.

<b>CHANNEL</b>	TX Channel 165	<b>DETECTOR FUNCTION</b>	Peak (PK)
<b>FREQUENCY RANGE</b>	1GHz ~ 40GHz		Average (AV)

**ANTENNA POLARITY & TEST DISTANCE: HORIZONTAL AT 3 M**

NO.	FREQ. (MHz)	EMISSION LEVEL (dBuV/m)	LIMIT (dBuV/m)	MARGIN (dB)	ANTENNA HEIGHT (m)	TABLE ANGLE (Degree)	RAW VALUE (dBuV)	CORRECTION FACTOR (dB/m)
1	#5663.00	66.0 PK	68.2	-2.2	1.71 H	120	61.10	4.90
2	*5825.00	119.7 PK			1.36 H	146	114.59	5.11
3	*5825.00	112.1 AV			1.36 H	146	106.99	5.11
<b>4</b>	<b>#5850.00</b>	<b>78.1 PK</b>	<b>78.2</b>	<b>-0.1</b>	<b>2.41 H</b>	<b>120</b>	<b>72.92</b>	<b>5.18</b>
5	#5860.00	67.1 PK	74.0	-6.9	2.15 H	120	61.89	5.21
6	#5860.00	51.8 AV	54.0	-2.2	2.15 H	120	46.59	5.21
7	#5986.00	66.1 PK	68.2	-2.1	2.40 H	145	60.55	5.55
8	11650.00	59.4 PK	74.0	-14.6	1.09 H	297	48.95	10.45
9	11650.00	46.5 AV	54.0	-7.5	1.09 H	297	36.05	10.45
10	#17475.00	69.1 PK	74.0	-4.9	1.65 H	100	49.87	19.23
11	#17475.00	50.4 AV	54.0	-3.6	1.65 H	100	31.17	19.23

**ANTENNA POLARITY & TEST DISTANCE: VERTICAL AT 3 M**

NO.	FREQ. (MHz)	EMISSION LEVEL (dBuV/m)	LIMIT (dBuV/m)	MARGIN (dB)	ANTENNA HEIGHT (m)	TABLE ANGLE (Degree)	RAW VALUE (dBuV)	CORRECTION FACTOR (dB/m)
1	#5663.00	62.8 PK	68.2	-5.4	1.36 V	190	57.90	4.90
2	*5825.00	116.0 PK			1.04 V	155	110.89	5.11
3	*5825.00	108.8 AV			1.04 V	155	103.69	5.11
4	#5850.00	76.4 PK	78.2	-1.8	1.57 V	107	71.22	5.18
5	#5860.00	66.6 PK	74.0	-7.4	1.50 V	189	61.39	5.21
6	#5860.00	51.4 AV	54.0	-2.6	1.50 V	189	46.19	5.21
7	#5986.00	64.5 PK	68.2	-3.7	1.29 V	187	58.95	5.55
8	11650.00	57.1 PK	74.0	-16.9	1.47 V	138	46.65	10.45
9	11650.00	46.8 AV	54.0	-7.2	1.47 V	138	36.35	10.45
10	#17475.00	68.1 PK	74.0	-5.9	1.49 V	127	48.87	19.23
11	#17475.00	49.6 AV	54.0	-4.4	1.49 V	127	30.37	19.23

**REMARKS:**

- Emission Level(dBuV/m) = Raw Value(dBuV) + Correction Factor(dB/m)
- Correction Factor(dB/m) = Antenna Factor(dB/m) + Cable Factor(dB) – Pre-Amplifier Factor(dB)
- The other emission levels were very low against the limit.
- Margin value = Emission Level – Limit value
- " \* ": Fundamental frequency.
- " # ": The radiated frequency is out of the restricted band.

**802.11ac (VHT20)**

<b>CHANNEL</b>	TX Channel 36	<b>DETECTOR FUNCTION</b>	Peak (PK)
<b>FREQUENCY RANGE</b>	1GHz ~ 40GHz		Average (AV)

<b>ANTENNA POLARITY &amp; TEST DISTANCE: HORIZONTAL AT 3 M</b>								
NO.	FREQ. (MHz)	EMISSION LEVEL (dBuV/m)	LIMIT (dBuV/m)	MARGIN (dB)	ANTENNA HEIGHT (m)	TABLE ANGLE (Degree)	RAW VALUE (dBuV)	CORRECTION FACTOR (dB/m)
1	5018.00	58.9 PK	74.0	-15.1	1.25 H	139	55.79	3.11
2	5018.00	50.2 AV	54.0	-3.8	1.25 H	139	47.09	3.11
3	5150.00	72.5 PK	74.0	-1.5	1.29 H	145	68.87	3.63
4	5150.00	53.7 AV	54.0	-0.3	1.29 H	145	50.07	3.63
5	*5180.00	119.0 PK			1.79 H	151	115.23	3.77
6	*5180.00	108.8 AV			1.79 H	151	105.03	3.77
7	5395.00	60.1 PK	74.0	-13.9	1.82 H	128	55.82	4.28
8	5395.00	52.3 AV	54.0	-1.7	1.82 H	128	48.02	4.28
9	#5611.00	58.8 PK	74.0	-15.2	1.62 H	148	53.93	4.87
10	#5611.00	51.8 AV	54.0	-2.2	1.62 H	148	46.93	4.87
11	#5827.00	57.8 PK	74.0	-16.2	1.61 H	110	52.68	5.12
12	#5827.00	47.2 AV	54.0	-6.8	1.61 H	110	42.08	5.12
13	#10360.00	59.4 PK	74.0	-14.6	1.65 H	99	50.03	9.37
14	#10360.00	48.2 AV	54.0	-5.8	1.65 H	99	38.83	9.37
15	15540.00	62.9 PK	74.0	-11.1	1.64 H	181	48.49	14.41
16	15540.00	50.4 AV	54.0	-3.6	1.64 H	181	35.99	14.41

<b>ANTENNA POLARITY &amp; TEST DISTANCE: VERTICAL AT 3 M</b>								
NO.	FREQ. (MHz)	EMISSION LEVEL (dBuV/m)	LIMIT (dBuV/m)	MARGIN (dB)	ANTENNA HEIGHT (m)	TABLE ANGLE (Degree)	RAW VALUE (dBuV)	CORRECTION FACTOR (dB/m)
1	5018.00	56.8 PK	74.0	-17.2	2.15 V	20	53.69	3.11
2	5018.00	46.6 AV	54.0	-7.4	2.15 V	20	43.49	3.11
3	5150.00	70.1 PK	74.0	-3.9	1.90 V	19	66.47	3.63
4	5150.00	52.8 AV	54.0	-1.2	1.90 V	19	49.17	3.63
5	*5180.00	115.6 PK			1.97 V	19	111.83	3.77
6	*5180.00	106.1 AV			1.97 V	19	102.33	3.77
7	5395.00	51.0 PK	74.0	-23.0	1.86 V	19	46.72	4.28
8	5395.00	46.3 AV	54.0	-7.7	1.86 V	19	42.02	4.28
9	#5611.00	54.5 PK	74.0	-19.5	1.81 V	79	49.63	4.87
10	#5611.00	46.4 AV	54.0	-7.6	1.81 V	79	41.53	4.87
11	#5827.00	53.9 PK	74.0	-20.1	2.11 V	181	48.78	5.12
12	#5827.00	43.8 AV	54.0	-10.2	2.11 V	181	38.68	5.12
13	#10360.00	57.4 PK	74.0	-16.6	1.92 V	288	48.03	9.37
14	#10360.00	46.0 AV	54.0	-8.0	1.92 V	288	36.63	9.37
15	15540.00	67.6 PK	74.0	-6.4	1.84 V	316	53.19	14.41
16	15540.00	53.5 AV	54.0	-0.5	1.84 V	316	39.09	14.41

**REMARKS:**

1. Emission Level(dBuV/m) = Raw Value(dBuV) + Correction Factor(dB/m)
2. Correction Factor(dB/m) = Antenna Factor(dB/m) + Cable Factor(dB) – Pre-Amplifier Factor(dB)
3. The other emission levels were very low against the limit.
4. Margin value = Emission Level – Limit value
5. " \* ": Fundamental frequency.
6. " # ": The radiated frequency is out of the restricted band.



<b>CHANNEL</b>	TX Channel 40	<b>DETECTOR FUNCTION</b>	Peak (PK)
<b>FREQUENCY RANGE</b>	1GHz ~ 40GHz		Average (AV)

**ANTENNA POLARITY & TEST DISTANCE: HORIZONTAL AT 3 M**

NO.	FREQ. (MHz)	EMISSION LEVEL (dBuV/m)	LIMIT (dBuV/m)	MARGIN (dB)	ANTENNA HEIGHT (m)	TABLE ANGLE (Degree)	RAW VALUE (dBuV)	CORRECTION FACTOR (dB/m)
1	5041.00	58.2 PK	74.0	-15.8	1.82 H	166	55.00	3.20
2	5041.00	47.7 AV	54.0	-6.3	1.82 H	166	44.50	3.20
3	*5200.00	114.6 PK			1.79 H	152	110.74	3.86
4	*5200.00	104.5 AV			1.79 H	152	100.64	3.86
5	5359.00	63.2 PK	74.0	-10.8	1.84 H	128	59.07	4.13
6	5359.00	53.7 AV	54.0	-0.3	1.84 H	128	49.57	4.13
7	5416.00	58.8 PK	74.0	-15.2	1.80 H	127	54.50	4.30
8	5416.00	52.1 AV	54.0	-1.9	1.80 H	127	47.80	4.30
9	#5633.00	56.8 PK	74.0	-17.2	1.84 H	150	51.92	4.88
10	#5633.00	50.2 AV	54.0	-3.8	1.84 H	150	45.32	4.88
11	#10400.00	59.4 PK	74.0	-14.6	1.81 H	116	49.98	9.42
12	#10400.00	48.4 AV	54.0	-5.6	1.81 H	116	38.98	9.42
13	15600.00	64.2 PK	74.0	-9.8	1.61 H	185	49.51	14.69
14	15600.00	51.6 AV	54.0	-2.4	1.61 H	185	36.91	14.69

**ANTENNA POLARITY & TEST DISTANCE: VERTICAL AT 3 M**

NO.	FREQ. (MHz)	EMISSION LEVEL (dBuV/m)	LIMIT (dBuV/m)	MARGIN (dB)	ANTENNA HEIGHT (m)	TABLE ANGLE (Degree)	RAW VALUE (dBuV)	CORRECTION FACTOR (dB/m)
1	5041.00	57.1 PK	74.0	-16.9	1.72 V	289	53.90	3.20
2	5041.00	46.8 AV	54.0	-7.2	1.72 V	289	43.60	3.20
3	*5200.00	111.2 PK			1.80 V	360	107.34	3.86
4	*5200.00	101.8 AV			1.80 V	360	97.94	3.86
5	5359.00	62.3 PK	74.0	-11.7	1.74 V	360	58.17	4.13
6	5359.00	52.8 AV	54.0	-1.2	1.74 V	360	48.67	4.13
7	5416.00	57.3 PK	74.0	-16.7	1.55 V	221	53.00	4.30
8	5416.00	50.8 AV	54.0	-3.2	1.55 V	221	46.50	4.30
9	#5633.00	55.7 PK	74.0	-18.3	1.70 V	249	50.82	4.88
10	#5633.00	45.8 AV	54.0	-8.2	1.70 V	249	40.92	4.88
11	#10400.00	57.0 PK	74.0	-17.0	2.11 V	306	47.58	9.42
12	#10400.00	45.6 AV	54.0	-8.4	2.11 V	306	36.18	9.42
13	15600.00	66.7 PK	74.0	-7.3	1.91 V	308	52.01	14.69
14	15600.00	51.9 AV	54.0	-2.1	1.91 V	308	37.21	14.69

**REMARKS:**

1. Emission Level(dBuV/m) = Raw Value(dBuV) + Correction Factor(dB/m)
2. Correction Factor(dB/m) = Antenna Factor(dB/m) + Cable Factor(dB) – Pre-Amplifier Factor(dB)
3. The other emission levels were very low against the limit.
4. Margin value = Emission Level – Limit value
5. " \* ": Fundamental frequency.
6. " # ": The radiated frequency is out of the restricted band.

<b>CHANNEL</b>	TX Channel 48	<b>DETECTOR FUNCTION</b>	Peak (PK)
<b>FREQUENCY RANGE</b>	1GHz ~ 40GHz		Average (AV)

**ANTENNA POLARITY & TEST DISTANCE: HORIZONTAL AT 3 M**

NO.	FREQ. (MHz)	EMISSION LEVEL (dBuV/m)	LIMIT (dBuV/m)	MARGIN (dB)	ANTENNA HEIGHT (m)	TABLE ANGLE (Degree)	RAW VALUE (dBuV)	CORRECTION FACTOR (dB/m)
1	5081.00	54.8 PK	74.0	-19.2	1.78 H	153	51.46	3.34
2	5081.00	46.9 AV	54.0	-7.1	1.78 H	153	43.56	3.34
3	*5240.00	114.7 PK			1.58 H	148	110.82	3.88
4	*5240.00	104.8 AV			1.58 H	148	100.92	3.88
5	5399.00	62.4 PK	74.0	-11.6	1.77 H	125	58.10	4.30
6	5399.00	53.6 AV	54.0	-0.4	1.77 H	125	49.30	4.30
7	#5676.00	58.2 PK	74.0	-15.8	1.55 H	143	53.29	4.91
8	#5676.00	50.2 AV	54.0	-3.8	1.55 H	143	45.29	4.91
9	#10480.00	60.5 PK	74.0	-13.5	1.65 H	86	50.90	9.60
10	#10480.00	48.8 AV	54.0	-5.2	1.65 H	86	39.20	9.60
11	15720.00	63.0 PK	74.0	-11.0	1.62 H	193	48.85	14.15
12	15720.00	50.9 AV	54.0	-3.1	1.62 H	193	36.75	14.15

**ANTENNA POLARITY & TEST DISTANCE: VERTICAL AT 3 M**

NO.	FREQ. (MHz)	EMISSION LEVEL (dBuV/m)	LIMIT (dBuV/m)	MARGIN (dB)	ANTENNA HEIGHT (m)	TABLE ANGLE (Degree)	RAW VALUE (dBuV)	CORRECTION FACTOR (dB/m)
1	5081.00	52.5 PK	74.0	-21.5	1.31 V	87	49.16	3.34
2	5081.00	43.3 AV	54.0	-10.7	1.31 V	87	39.96	3.34
3	*5240.00	111.3 PK			1.20 V	100	107.42	3.88
4	*5240.00	102.1 AV			1.20 V	100	98.22	3.88
5	5399.00	60.9 PK	74.0	-13.1	1.01 V	86	56.60	4.30
6	5399.00	48.4 AV	54.0	-5.6	1.01 V	86	44.10	4.30
7	#5676.00	54.8 PK	74.0	-19.2	1.32 V	87	49.89	4.91
8	#5676.00	50.2 AV	54.0	-3.8	1.32 V	87	45.29	4.91
9	#10480.00	57.3 PK	74.0	-16.7	2.00 V	300	47.70	9.60
10	#10480.00	45.9 AV	54.0	-8.1	2.00 V	300	36.30	9.60
11	15720.00	67.6 PK	74.0	-6.4	1.84 V	303	53.45	14.15
12	15720.00	52.1 AV	54.0	-1.9	1.84 V	303	37.95	14.15

**REMARKS:**

1. Emission Level(dBuV/m) = Raw Value(dBuV) + Correction Factor(dB/m)
2. Correction Factor(dB/m) = Antenna Factor(dB/m) + Cable Factor(dB) – Pre-Amplifier Factor(dB)
3. The other emission levels were very low against the limit.
4. Margin value = Emission Level – Limit value
5. " \* ": Fundamental frequency.
6. " # ": The radiated frequency is out of the restricted band.

<b>CHANNEL</b>	TX Channel 149	<b>DETECTOR FUNCTION</b>	Peak (PK)
<b>FREQUENCY RANGE</b>	1GHz ~ 40GHz		Average (AV)

**ANTENNA POLARITY & TEST DISTANCE: HORIZONTAL AT 3 M**

NO.	FREQ. (MHz)	EMISSION LEVEL (dBuV/m)	LIMIT (dBuV/m)	MARGIN (dB)	ANTENNA HEIGHT (m)	TABLE ANGLE (Degree)	RAW VALUE (dBuV)	CORRECTION FACTOR (dB/m)
1	#5580.00	61.6 PK	74.0	-12.4	1.83 H	114	56.84	4.76
2	#5580.00	51.2 AV	54.0	-2.8	1.83 H	114	46.44	4.76
3	#5715.00	51.7 PK	74.0	-22.3	1.83 H	115	46.77	4.93
4	#5715.00	43.9 AV	54.0	-10.1	1.83 H	115	38.97	4.93
<b>5</b>	<b>#5725.00</b>	<b>78.1 PK</b>	<b>78.2</b>	<b>-0.1</b>	<b>1.83 H</b>	<b>117</b>	<b>73.14</b>	<b>4.96</b>
6	*5745.00	114.5 PK			1.87 H	114	109.53	4.97
7	*5745.00	104.2 AV			1.87 H	114	99.23	4.97
8	#5905.00	60.3 PK	74.0	-13.7	1.99 H	111	54.96	5.34
9	#5905.00	50.1 AV	54.0	-3.9	1.99 H	111	44.76	5.34
10	11490.00	59.0 PK	74.0	-15.0	1.10 H	225	48.40	10.60
11	11490.00	46.2 AV	54.0	-7.8	1.10 H	225	35.60	10.60
12	#17235.00	70.5 PK	74.0	-3.5	1.62 H	113	52.29	18.21
13	#17235.00	51.3 AV	54.0	-2.7	1.62 H	113	33.09	18.21

**ANTENNA POLARITY & TEST DISTANCE: VERTICAL AT 3 M**

NO.	FREQ. (MHz)	EMISSION LEVEL (dBuV/m)	LIMIT (dBuV/m)	MARGIN (dB)	ANTENNA HEIGHT (m)	TABLE ANGLE (Degree)	RAW VALUE (dBuV)	CORRECTION FACTOR (dB/m)
1	#5580.00	58.3 PK	74.0	-15.7	1.15 V	206	53.54	4.76
2	#5580.00	45.0 AV	54.0	-9.0	1.15 V	206	40.24	4.76
3	#5715.00	51.1 PK	74.0	-22.9	1.43 V	155	46.17	4.93
4	#5715.00	43.5 AV	54.0	-10.5	1.43 V	155	38.57	4.93
5	#5725.00	76.3 PK	78.2	-1.9	1.56 V	79	71.34	4.96
6	*5745.00	111.3 PK			1.65 V	144	106.33	4.97
7	*5745.00	100.9 AV			1.65 V	144	95.93	4.97
8	#5905.00	60.1 PK	74.0	-13.9	1.36 V	167	54.76	5.34
9	#5905.00	49.8 AV	54.0	-4.2	1.36 V	167	44.46	5.34
10	11490.00	57.7 PK	74.0	-16.3	1.33 V	141	47.10	10.60
11	11490.00	47.5 AV	54.0	-6.5	1.33 V	141	36.90	10.60
12	#17235.00	68.4 PK	74.0	-5.6	1.36 V	135	50.19	18.21
13	#17235.00	50.0 AV	54.0	-4.0	1.36 V	135	31.79	18.21

**REMARKS:**

1. Emission Level(dBuV/m) = Raw Value(dBuV) + Correction Factor(dB/m)
2. Correction Factor(dB/m) = Antenna Factor(dB/m) + Cable Factor(dB) – Pre-Amplifier Factor(dB)
3. The other emission levels were very low against the limit.
4. Margin value = Emission Level – Limit value
5. " \* ": Fundamental frequency.
6. " # ": The radiated frequency is out of the restricted band.

<b>CHANNEL</b>	TX Channel 157	<b>DETECTOR FUNCTION</b>	Peak (PK)
<b>FREQUENCY RANGE</b>	1GHz ~ 40GHz		Average (AV)

**ANTENNA POLARITY & TEST DISTANCE: HORIZONTAL AT 3 M**

NO.	FREQ. (MHz)	EMISSION LEVEL (dBuV/m)	LIMIT (dBuV/m)	MARGIN (dB)	ANTENNA HEIGHT (m)	TABLE ANGLE (Degree)	RAW VALUE (dBuV)	CORRECTION FACTOR (dB/m)
1	#5626.00	68.1 PK	68.2	-0.1	1.80 H	114	63.23	4.87
2	*5785.00	121.2 PK			1.59 H	121	116.17	5.03
3	*5785.00	110.4 AV			1.59 H	121	105.37	5.03
4	#5944.00	66.5 PK	68.2	-1.7	2.33 H	117	61.06	5.44
5	11570.00	59.0 PK	74.0	-15.0	1.10 H	293	48.44	10.56
6	11570.00	46.4 AV	54.0	-7.6	1.10 H	293	35.84	10.56
7	#17355.00	69.3 PK	74.0	-4.7	1.61 H	95	50.48	18.82
8	#17355.00	50.6 AV	54.0	-3.4	1.61 H	95	31.78	18.82

**ANTENNA POLARITY & TEST DISTANCE: VERTICAL AT 3 M**

NO.	FREQ. (MHz)	EMISSION LEVEL (dBuV/m)	LIMIT (dBuV/m)	MARGIN (dB)	ANTENNA HEIGHT (m)	TABLE ANGLE (Degree)	RAW VALUE (dBuV)	CORRECTION FACTOR (dB/m)
1	#5626.00	64.9 PK	68.2	-3.3	1.90 V	115	60.03	4.87
2	*5785.00	117.5 PK			1.65 V	122	112.47	5.03
3	*5785.00	107.1 AV			1.65 V	122	102.07	5.03
4	#5944.00	63.2 PK	68.2	-5.0	2.00 V	122	57.76	5.44
5	11570.00	56.8 PK	74.0	-17.2	1.59 V	145	46.24	10.56
6	11570.00	46.2 AV	54.0	-7.8	1.59 V	145	35.64	10.56
7	#17355.00	68.7 PK	74.0	-5.3	1.47 V	114	49.88	18.82
8	#17355.00	50.3 AV	54.0	-3.7	1.47 V	114	31.48	18.82

**REMARKS:**

1. Emission Level(dBuV/m) = Raw Value(dBuV) + Correction Factor(dB/m)
2. Correction Factor(dB/m) = Antenna Factor(dB/m) + Cable Factor(dB) – Pre-Amplifier Factor(dB)
3. The other emission levels were very low against the limit.
4. Margin value = Emission Level – Limit value
5. " \* ": Fundamental frequency.
6. " # ": The radiated frequency is out of the restricted band.



<b>CHANNEL</b>	TX Channel 165	<b>DETECTOR FUNCTION</b>	Peak (PK)
<b>FREQUENCY RANGE</b>	1GHz ~ 40GHz		Average (AV)

**ANTENNA POLARITY & TEST DISTANCE: HORIZONTAL AT 3 M**

NO.	FREQ. (MHz)	EMISSION LEVEL (dBuV/m)	LIMIT (dBuV/m)	MARGIN (dB)	ANTENNA HEIGHT (m)	TABLE ANGLE (Degree)	RAW VALUE (dBuV)	CORRECTION FACTOR (dB/m)
1	#5663.00	65.5 PK	68.2	-2.7	1.72 H	122	60.60	4.90
2	*5825.00	118.8 PK			1.68 H	121	113.69	5.11
3	*5825.00	108.2 AV			1.68 H	121	103.09	5.11
<b>4</b>	<b>#5850.00</b>	<b>78.1 PK</b>	<b>78.2</b>	<b>-0.1</b>	<b>1.77 H</b>	<b>111</b>	<b>72.92</b>	<b>5.18</b>
5	#5860.00	56.6 PK	74.0	-17.4	2.32 H	119	51.39	5.21
6	#5860.00	48.2 AV	54.0	-5.8	2.32 H	119	42.99	5.21
7	#5983.00	65.7 PK	68.2	-2.5	2.32 H	119	60.15	5.55
8	11650.00	58.7 PK	74.0	-15.3	1.09 H	293	48.25	10.45
9	11650.00	46.2 AV	54.0	-7.8	1.09 H	293	35.75	10.45
10	#17475.00	68.9 PK	74.0	-5.1	1.61 H	83	49.67	19.23
11	#17475.00	50.4 AV	54.0	-3.6	1.61 H	83	31.17	19.23

**ANTENNA POLARITY & TEST DISTANCE: VERTICAL AT 3 M**

NO.	FREQ. (MHz)	EMISSION LEVEL (dBuV/m)	LIMIT (dBuV/m)	MARGIN (dB)	ANTENNA HEIGHT (m)	TABLE ANGLE (Degree)	RAW VALUE (dBuV)	CORRECTION FACTOR (dB/m)
1	#5663.00	62.1 PK	68.2	-6.1	1.78 V	210	57.20	4.90
2	*5825.00	115.2 PK			1.70 V	211	110.09	5.11
3	*5825.00	104.8 AV			1.70 V	211	99.69	5.11
4	#5850.00	76.2 PK	78.2	-2.0	1.80 V	222	71.02	5.18
5	#5860.00	55.9 PK	74.0	-18.1	1.77 V	221	50.69	5.21
6	#5860.00	47.6 AV	54.0	-6.4	1.77 V	221	42.39	5.21
7	#5983.00	63.9 PK	68.2	-4.3	1.65 V	213	58.35	5.55
8	11650.00	56.1 PK	74.0	-17.9	1.39 V	150	45.65	10.45
9	11650.00	46.0 AV	54.0	-8.0	1.39 V	150	35.55	10.45
10	#17475.00	68.2 PK	74.0	-5.8	1.50 V	136	48.97	19.23
11	#17475.00	49.9 AV	54.0	-4.1	1.50 V	136	30.67	19.23

**REMARKS:**

- Emission Level(dBuV/m) = Raw Value(dBuV) + Correction Factor(dB/m)
- Correction Factor(dB/m) = Antenna Factor(dB/m) + Cable Factor(dB) – Pre-Amplifier Factor(dB)
- The other emission levels were very low against the limit.
- Margin value = Emission Level – Limit value
- " \* ": Fundamental frequency.
- " # ": The radiated frequency is out of the restricted band.

**802.11ac (VHT40)**

<b>CHANNEL</b>	TX Channel 38	<b>DETECTOR FUNCTION</b>	Peak (PK)
<b>FREQUENCY RANGE</b>	1GHz ~ 40GHz		Average (AV)

**ANTENNA POLARITY & TEST DISTANCE: HORIZONTAL AT 3 M**

NO.	FREQ. (MHz)	EMISSION LEVEL (dBuV/m)	LIMIT (dBuV/m)	MARGIN (dB)	ANTENNA HEIGHT (m)	TABLE ANGLE (Degree)	RAW VALUE (dBuV)	CORRECTION FACTOR (dB/m)
1	5150.00	68.6 PK	74.0	-5.4	1.50 H	144	64.97	3.63
2	5150.00	53.5 AV	54.0	-0.5	1.50 H	144	49.87	3.63
3	*5190.00	112.2 PK			1.81 H	150	108.38	3.82
4	*5190.00	101.7 AV			1.81 H	150	97.88	3.82
5	5350.00	60.4 PK	74.0	-13.6	1.50 H	145	56.32	4.08
6	5350.00	50.2 AV	54.0	-3.8	1.50 H	145	46.12	4.08
7	#5622.00	62.3 PK	68.2	-5.9	1.82 H	115	57.43	4.87
8	#10380.00	58.6 PK	68.2	-9.6	1.82 H	82	49.20	9.40
9	15570.00	64.7 PK	74.0	-9.3	1.67 H	181	50.15	14.55
10	15570.00	51.6 AV	54.0	-2.4	1.67 H	181	37.05	14.55

**ANTENNA POLARITY & TEST DISTANCE: VERTICAL AT 3 M**

NO.	FREQ. (MHz)	EMISSION LEVEL (dBuV/m)	LIMIT (dBuV/m)	MARGIN (dB)	ANTENNA HEIGHT (m)	TABLE ANGLE (Degree)	RAW VALUE (dBuV)	CORRECTION FACTOR (dB/m)
1	5150.00	65.7 PK	74.0	-8.3	2.12 V	19	62.07	3.63
2	5150.00	50.4 AV	54.0	-3.6	2.12 V	19	46.77	3.63
3	*5190.00	108.3 PK			2.06 V	17	104.48	3.82
4	*5190.00	98.7 AV			2.06 V	17	94.88	3.82
5	5350.00	60.1 PK	74.0	-13.9	1.90 V	18	56.02	4.08
6	5350.00	48.9 AV	54.0	-5.1	1.90 V	18	44.82	4.08
7	#5622.00	57.5 PK	68.2	-10.7	2.26 V	10	52.63	4.87
8	#10380.00	57.0 PK	68.2	-11.2	2.09 V	324	47.60	9.40
9	15570.00	67.1 PK	74.0	-6.9	1.94 V	329	52.55	14.55
10	15570.00	52.0 AV	54.0	-2.0	1.94 V	329	37.45	14.55

**REMARKS:**

- Emission Level(dBuV/m) = Raw Value(dBuV) + Correction Factor(dB/m)
- Correction Factor(dB/m) = Antenna Factor(dB/m) + Cable Factor(dB) – Pre-Amplifier Factor(dB)
- The other emission levels were very low against the limit.
- Margin value = Emission Level – Limit value
- " \* ": Fundamental frequency.
- " # ": The radiated frequency is out of the restricted band.

<b>CHANNEL</b>	TX Channel 46	<b>DETECTOR FUNCTION</b>	Peak (PK)
<b>FREQUENCY RANGE</b>	1GHz ~ 40GHz		Average (AV)

**ANTENNA POLARITY & TEST DISTANCE: HORIZONTAL AT 3 M**

NO.	FREQ. (MHz)	EMISSION LEVEL (dBuV/m)	LIMIT (dBuV/m)	MARGIN (dB)	ANTENNA HEIGHT (m)	TABLE ANGLE (Degree)	RAW VALUE (dBuV)	CORRECTION FACTOR (dB/m)
1	5075.00	56.2 PK	74.0	-17.8	2.00 H	166	52.87	3.33
2	5075.00	44.4 AV	54.0	-9.6	2.00 H	166	41.07	3.33
3	*5230.00	111.1 PK			1.66 H	150	107.24	3.86
4	*5230.00	104.6 AV			1.66 H	150	100.74	3.86
5	5385.00	61.8 PK	74.0	-12.2	1.88 H	122	57.57	4.23
6	5385.00	53.6 AV	54.0	-0.4	1.88 H	122	49.37	4.23
7	#5665.00	61.5 PK	68.2	-6.7	1.63 H	120	56.60	4.90
8	#10460.00	60.2 PK	68.2	-8.0	1.82 H	96	50.64	9.56
9	15690.00	64.6 PK	74.0	-9.4	1.59 H	195	50.43	14.17
10	15690.00	51.6 AV	54.0	-2.4	1.59 H	195	37.43	14.17

**ANTENNA POLARITY & TEST DISTANCE: VERTICAL AT 3 M**

NO.	FREQ. (MHz)	EMISSION LEVEL (dBuV/m)	LIMIT (dBuV/m)	MARGIN (dB)	ANTENNA HEIGHT (m)	TABLE ANGLE (Degree)	RAW VALUE (dBuV)	CORRECTION FACTOR (dB/m)
1	5075.00	53.7 PK	74.0	-20.3	1.66 V	221	50.37	3.33
2	5075.00	40.9 AV	54.0	-13.1	1.66 V	221	37.57	3.33
3	*5230.00	107.2 PK			2.10 V	204	103.34	3.86
4	*5230.00	101.5 AV			2.10 V	204	97.64	3.86
5	5385.00	61.2 PK	74.0	-12.8	1.77 V	211	56.97	4.23
6	5385.00	48.6 AV	54.0	-5.4	1.77 V	211	44.37	4.23
7	#5665.00	59.7 PK	68.2	-8.5	1.55 V	322	54.80	4.90
8	#10460.00	58.7 PK	68.2	-9.5	2.05 V	286	49.14	9.56
9	15690.00	68.2 PK	74.0	-5.8	1.79 V	311	54.03	14.17
10	15690.00	52.5 AV	54.0	-1.5	1.79 V	311	38.33	14.17

**REMARKS:**

1. Emission Level(dBuV/m) = Raw Value(dBuV) + Correction Factor(dB/m)
2. Correction Factor(dB/m) = Antenna Factor(dB/m) + Cable Factor(dB) – Pre-Amplifier Factor(dB)
3. The other emission levels were very low against the limit.
4. Margin value = Emission Level – Limit value
5. " \* ": Fundamental frequency.
6. " # ": The radiated frequency is out of the restricted band.

<b>CHANNEL</b>	TX Channel 151	<b>DETECTOR FUNCTION</b>	Peak (PK)
<b>FREQUENCY RANGE</b>	1GHz ~ 40GHz		Average (AV)

**ANTENNA POLARITY & TEST DISTANCE: HORIZONTAL AT 3 M**

NO.	FREQ. (MHz)	EMISSION LEVEL (dBuV/m)	LIMIT (dBuV/m)	MARGIN (dB)	ANTENNA HEIGHT (m)	TABLE ANGLE (Degree)	RAW VALUE (dBuV)	CORRECTION FACTOR (dB/m)
1	#5590.00	59.3 PK	74.0	-14.7	1.84 H	118	54.49	4.81
2	#5590.00	48.2 AV	54.0	-5.8	1.84 H	118	43.39	4.81
3	#5715.00	65.8 PK	74.0	-8.2	1.80 H	146	60.87	4.93
4	#5715.00	52.1 AV	54.0	-1.9	1.80 H	146	47.17	4.93
5	#5725.00	77.8 PK	78.2	-0.4	1.58 H	122	72.84	4.96
6	*5755.00	110.9 PK			1.72 H	119	105.91	4.99
7	*5755.00	101.2 AV			1.72 H	119	96.21	4.99
8	#5919.00	58.9 PK	74.0	-15.1	2.29 H	116	53.53	5.37
9	#5919.00	47.8 AV	54.0	-6.2	2.29 H	116	42.43	5.37
10	11510.00	58.7 PK	74.0	-15.3	1.00 H	247	48.09	10.61
11	11510.00	46.3 AV	54.0	-7.7	1.00 H	247	35.69	10.61
12	#17265.00	69.5 PK	74.0	-4.5	1.53 H	90	51.15	18.35
13	#17265.00	50.4 AV	54.0	-3.6	1.53 H	90	32.05	18.35

**ANTENNA POLARITY & TEST DISTANCE: VERTICAL AT 3 M**

NO.	FREQ. (MHz)	EMISSION LEVEL (dBuV/m)	LIMIT (dBuV/m)	MARGIN (dB)	ANTENNA HEIGHT (m)	TABLE ANGLE (Degree)	RAW VALUE (dBuV)	CORRECTION FACTOR (dB/m)
1	#5590.00	55.5 PK	74.0	-18.5	1.64 V	203	50.69	4.81
2	#5590.00	41.6 AV	54.0	-12.4	1.64 V	203	36.79	4.81
3	#5715.00	64.9 PK	74.0	-9.1	1.82 V	227	59.97	4.93
4	#5715.00	51.3 AV	54.0	-2.7	1.82 V	227	46.37	4.93
5	#5725.00	75.7 PK	78.2	-2.5	1.81 V	224	70.74	4.96
6	*5755.00	108.9 PK			1.75 V	92	103.91	4.99
7	*5755.00	98.9 AV			1.75 V	92	93.91	4.99
8	#5919.00	56.8 PK	74.0	-17.2	1.76 V	213	51.43	5.37
9	#5919.00	43.1 AV	54.0	-10.9	1.76 V	213	37.73	5.37
10	11510.00	57.0 PK	74.0	-17.0	1.30 V	129	46.39	10.61
11	11510.00	47.1 AV	54.0	-6.9	1.30 V	129	36.49	10.61
12	#17265.00	68.3 PK	74.0	-5.7	1.32 V	116	49.95	18.35
13	#17265.00	50.1 AV	54.0	-3.9	1.32 V	116	31.75	18.35

**REMARKS:**

1. Emission Level(dBuV/m) = Raw Value(dBuV) + Correction Factor(dB/m)
2. Correction Factor(dB/m) = Antenna Factor(dB/m) + Cable Factor(dB) – Pre-Amplifier Factor(dB)
3. The other emission levels were very low against the limit.
4. Margin value = Emission Level – Limit value
5. " \* ": Fundamental frequency.
6. " # ": The radiated frequency is out of the restricted band.

<b>CHANNEL</b>	TX Channel 159	<b>DETECTOR FUNCTION</b>	Peak (PK)
<b>FREQUENCY RANGE</b>	1GHz ~ 40GHz		Average (AV)

**ANTENNA POLARITY & TEST DISTANCE: HORIZONTAL AT 3 M**

NO.	FREQ. (MHz)	EMISSION LEVEL (dBuV/m)	LIMIT (dBuV/m)	MARGIN (dB)	ANTENNA HEIGHT (m)	TABLE ANGLE (Degree)	RAW VALUE (dBuV)	CORRECTION FACTOR (dB/m)
1	#5638.00	63.9 PK	74.0	-10.1	2.70 H	124	59.01	4.89
2	#5638.00	53.1 AV	54.0	-0.9	2.70 H	124	48.21	4.89
3	*5795.00	116.9 PK			1.63 H	123	111.85	5.05
4	*5795.00	106.5 AV			1.63 H	123	101.45	5.05
5	#5850.00	77.9 PK	78.2	-0.3	1.78 H	114	72.72	5.18
6	#5860.00	70.1 PK	74.0	-3.9	1.75 H	113	64.89	5.21
7	#5860.00	53.4 AV	54.0	-0.6	1.75 H	113	48.19	5.21
8	#5949.00	63.5 PK	74.0	-10.5	2.34 H	117	58.04	5.46
9	#5949.00	53.1 AV	54.0	-0.9	2.34 H	117	47.64	5.46
10	11590.00	58.2 PK	74.0	-15.8	1.11 H	256	47.66	10.54
11	11590.00	45.7 AV	54.0	-8.3	1.11 H	256	35.16	10.54
12	#17385.00	68.7 PK	74.0	-5.3	1.56 H	69	49.70	19.00
13	#17385.00	50.3 AV	54.0	-3.7	1.56 H	69	31.30	19.00

**ANTENNA POLARITY & TEST DISTANCE: VERTICAL AT 3 M**

NO.	FREQ. (MHz)	EMISSION LEVEL (dBuV/m)	LIMIT (dBuV/m)	MARGIN (dB)	ANTENNA HEIGHT (m)	TABLE ANGLE (Degree)	RAW VALUE (dBuV)	CORRECTION FACTOR (dB/m)
1	#5638.00	60.7 PK	74.0	-13.3	1.70 V	218	55.81	4.89
2	#5638.00	50.3 AV	54.0	-3.7	1.70 V	218	45.41	4.89
3	*5795.00	114.9 PK			1.80 V	199	109.85	5.05
4	*5795.00	104.2 AV			1.80 V	199	99.15	5.05
5	#5850.00	75.9 PK	78.2	-2.3	1.72 V	226	70.72	5.18
6	#5860.00	67.0 PK	74.0	-7.0	1.80 V	241	61.79	5.21
7	#5860.00	50.5 AV	54.0	-3.5	1.80 V	241	45.29	5.21
8	#5949.00	60.2 PK	74.0	-13.8	1.60 V	207	54.74	5.46
9	#5949.00	50.3 AV	54.0	-3.7	1.60 V	207	44.84	5.46
10	11590.00	57.1 PK	74.0	-16.9	1.53 V	145	46.56	10.54
11	11590.00	46.5 AV	54.0	-7.5	1.53 V	145	35.96	10.54
12	#17385.00	67.4 PK	74.0	-6.6	1.38 V	124	48.40	19.00
13	#17385.00	49.4 AV	54.0	-4.6	1.38 V	124	30.40	19.00

**REMARKS:**

1. Emission Level(dBuV/m) = Raw Value(dBuV) + Correction Factor(dB/m)
2. Correction Factor(dB/m) = Antenna Factor(dB/m) + Cable Factor(dB) – Pre-Amplifier Factor(dB)
3. The other emission levels were very low against the limit.
4. Margin value = Emission Level – Limit value
5. " \* ": Fundamental frequency.
6. " # ": The radiated frequency is out of the restricted band.

**802.11ac (VHT80)**

<b>CHANNEL</b>	TX Channel 42	<b>DETECTOR FUNCTION</b>	Peak (PK)
<b>FREQUENCY RANGE</b>	1GHz ~ 40GHz		Average (AV)

**ANTENNA POLARITY & TEST DISTANCE: HORIZONTAL AT 3 M**

NO.	FREQ. (MHz)	EMISSION LEVEL (dBuV/m)	LIMIT (dBuV/m)	MARGIN (dB)	ANTENNA HEIGHT (m)	TABLE ANGLE (Degree)	RAW VALUE (dBuV)	CORRECTION FACTOR (dB/m)
1	5150.00	67.9 PK	74.0	-6.1	1.72 H	149	64.27	3.63
2	5150.00	53.6 AV	54.0	-0.4	1.72 H	149	49.97	3.63
3	*5210.00	107.7 PK			1.76 H	151	103.85	3.85
4	*5210.00	97.8 AV			1.76 H	151	93.95	3.85
5	5360.00	58.8 PK	74.0	-15.2	1.69 H	124	54.67	4.13
6	5360.00	47.8 AV	54.0	-6.2	1.69 H	124	43.67	4.13
7	#5788.00	59.0 PK	68.2	-9.2	1.65 H	127	53.96	5.04
8	#10420.00	55.2 PK	68.2	-13.0	1.89 H	125	45.74	9.46
9	15630.00	55.5 PK	74.0	-18.5	1.79 H	35	40.98	14.52
10	15630.00	44.1 AV	54.0	-9.9	1.79 H	35	29.58	14.52

**ANTENNA POLARITY & TEST DISTANCE: VERTICAL AT 3 M**

NO.	FREQ. (MHz)	EMISSION LEVEL (dBuV/m)	LIMIT (dBuV/m)	MARGIN (dB)	ANTENNA HEIGHT (m)	TABLE ANGLE (Degree)	RAW VALUE (dBuV)	CORRECTION FACTOR (dB/m)
1	5150.00	60.3 PK	74.0	-13.7	1.87 V	211	56.67	3.63
2	5150.00	49.3 AV	54.0	-4.7	1.87 V	211	45.67	3.63
3	*5210.00	104.9 PK			1.29 V	137	101.05	3.85
4	*5210.00	94.4 AV			1.29 V	137	90.55	3.85
5	5360.00	51.7 PK	74.0	-22.3	2.03 V	346	47.57	4.13
6	5360.00	43.6 AV	54.0	-10.4	2.03 V	346	39.47	4.13
7	#5788.00	58.8 PK	68.2	-9.4	2.04 V	92	53.76	5.04
8	#10420.00	57.1 PK	68.2	-11.1	1.45 V	131	47.64	9.46
9	15630.00	63.6 PK	74.0	-10.4	1.13 V	310	49.08	14.52
10	15630.00	51.6 AV	54.0	-2.4	1.13 V	310	37.08	14.52

**REMARKS:**

1. Emission Level(dBuV/m) = Raw Value(dBuV) + Correction Factor(dB/m)
2. Correction Factor(dB/m) = Antenna Factor(dB/m) + Cable Factor(dB) – Pre-Amplifier Factor(dB)
3. The other emission levels were very low against the limit.
4. Margin value = Emission Level – Limit value
5. " \* ": Fundamental frequency.
6. " # ": The radiated frequency is out of the restricted band.

<b>CHANNEL</b>	TX Channel 155	<b>DETECTOR FUNCTION</b>	Peak (PK)
<b>FREQUENCY RANGE</b>	1GHz ~ 40GHz		Average (AV)

**ANTENNA POLARITY & TEST DISTANCE: HORIZONTAL AT 3 M**

NO.	FREQ. (MHz)	EMISSION LEVEL (dBuV/m)	LIMIT (dBuV/m)	MARGIN (dB)	ANTENNA HEIGHT (m)	TABLE ANGLE (Degree)	RAW VALUE (dBuV)	CORRECTION FACTOR (dB/m)
1	#5715.00	70.2 PK	74.0	-3.8	1.72 H	122	65.27	4.93
2	#5715.00	53.7 AV	54.0	-0.3	1.72 H	122	48.77	4.93
3	#5725.00	76.3 PK	78.2	-1.9	1.72 H	112	71.34	4.96
4	*5775.00	106.1 PK			1.85 H	110	101.09	5.01
5	*5775.00	95.7 AV			1.85 H	110	90.69	5.01
6	#5850.00	66.8 PK	78.2	-11.4	1.75 H	112	61.62	5.18
7	#5860.00	59.8 PK	74.0	-14.2	1.69 H	110	54.59	5.21
8	#5860.00	48.5 AV	54.0	-5.5	1.69 H	110	43.29	5.21
9	11550.00	58.6 PK	74.0	-15.4	1.06 H	255	48.03	10.57
10	11550.00	46.1 AV	54.0	-7.9	1.06 H	255	35.53	10.57
11	#17325.00	68.3 PK	74.0	-5.7	1.62 H	64	49.64	18.66
12	#17325.00	49.9 AV	54.0	-4.1	1.62 H	64	31.24	18.66

**ANTENNA POLARITY & TEST DISTANCE: VERTICAL AT 3 M**

NO.	FREQ. (MHz)	EMISSION LEVEL (dBuV/m)	LIMIT (dBuV/m)	MARGIN (dB)	ANTENNA HEIGHT (m)	TABLE ANGLE (Degree)	RAW VALUE (dBuV)	CORRECTION FACTOR (dB/m)
1	#5715.00	66.9 PK	74.0	-7.1	1.73 V	231	61.97	4.93
2	#5715.00	50.2 AV	54.0	-3.8	1.73 V	231	45.27	4.93
3	#5725.00	72.7 PK	78.2	-5.5	1.73 V	236	67.74	4.96
4	*5775.00	103.6 PK			1.78 V	211	98.59	5.01
5	*5775.00	93.1 AV			1.78 V	211	88.09	5.01
6	#5850.00	63.9 PK	78.2	-14.3	1.57 V	193	58.72	5.18
7	#5860.00	56.1 PK	74.0	-17.9	1.72 V	230	50.89	5.21
8	#5860.00	43.9 AV	54.0	-10.1	1.72 V	230	38.69	5.21
9	11550.00	56.5 PK	74.0	-17.5	1.59 V	154	45.93	10.57
10	11550.00	46.2 AV	54.0	-7.8	1.59 V	154	35.63	10.57
11	#17325.00	66.7 PK	74.0	-7.3	1.42 V	116	48.04	18.66
12	#17325.00	48.9 AV	54.0	-5.1	1.42 V	116	30.24	18.66

**REMARKS:**

1. Emission Level(dBuV/m) = Raw Value(dBuV) + Correction Factor(dB/m)
2. Correction Factor(dB/m) = Antenna Factor(dB/m) + Cable Factor(dB) – Pre-Amplifier Factor(dB)
3. The other emission levels were very low against the limit.
4. Margin value = Emission Level – Limit value
5. " \* ": Fundamental frequency.
6. " # ": The radiated frequency is out of the restricted band.

**Below 1GHz Data:**
**802.11ac VHT20**

<b>CHANNEL</b>	TX Channel 157	<b>DETECTOR FUNCTION</b>	Quasi-Peak (QP)
<b>FREQUENCY RANGE</b>	Below 1GHz		

**ANTENNA POLARITY & TEST DISTANCE: HORIZONTAL AT 3 M**

NO.	FREQ. (MHz)	EMISSION LEVEL (dBuV/m)	LIMIT (dBuV/m)	MARGIN (dB)	ANTENNA HEIGHT (m)	TABLE ANGLE (Degree)	RAW VALUE (dBuV)	CORRECTION FACTOR (dB/m)
1	133.34	37.1 QP	43.5	-6.4	1.01 H	241	50.96	-13.84
2	249.81	41.5 QP	46.0	-4.5	1.34 H	304	55.43	-13.91
3	281.65	41.5 QP	46.0	-4.5	1.67 H	245	54.07	-12.56
4	500.24	42.2 QP	46.0	-3.8	1.65 H	97	49.42	-7.18
5	749.65	40.0 QP	46.0	-6.0	1.24 H	277	42.04	-2.00
6	800.01	38.3 QP	46.0	-7.7	1.64 H	345	39.76	-1.45

**ANTENNA POLARITY & TEST DISTANCE: VERTICAL AT 3 M**

NO.	FREQ. (MHz)	EMISSION LEVEL (dBuV/m)	LIMIT (dBuV/m)	MARGIN (dB)	ANTENNA HEIGHT (m)	TABLE ANGLE (Degree)	RAW VALUE (dBuV)	CORRECTION FACTOR (dB/m)
1	89.31	36.8 QP	43.5	-6.7	1.64 V	97	55.76	-18.95
2	133.21	37.1 QP	43.5	-6.4	1.45 V	164	50.98	-13.86
3	167.21	37.1 QP	43.5	-6.4	1.45 V	245	50.44	-13.32
4	199.65	36.1 QP	43.5	-7.4	1.34 V	214	52.15	-16.03
5	249.52	41.6 QP	46.0	-4.4	1.45 V	100	55.53	-13.91
6	282.24	42.3 QP	46.0	-3.7	1.24 V	100	54.88	-12.54

**REMARKS:**

1. Emission Level(dBuV/m) = Raw Value(dBuV) + Correction Factor(dB/m)
2. Correction Factor(dB/m) = Antenna Factor(dB/m) + Cable Factor(dB) – Pre-Amplifier Factor(dB)
3. The other emission levels were very low against the limit.
4. Margin value = Emission Level – Limit value



**Beamforming MODE**

Above 1GHz Data:

802.11ac (VHT20)

<b>CHANNEL</b>	TX Channel 36	<b>DETECTOR FUNCTION</b>	Peak (PK)
<b>FREQUENCY RANGE</b>	1GHz ~ 40GHz		Average (AV)

**ANTENNA POLARITY & TEST DISTANCE: HORIZONTAL AT 3 M**

NO.	FREQ. (MHz)	EMISSION LEVEL (dBuV/m)	LIMIT (dBuV/m)	MARGIN (dB)	ANTENNA HEIGHT (m)	TABLE ANGLE (Degree)	RAW VALUE (dBuV)	CORRECTION FACTOR (dB/m)
1	5023.00	59.7 PK	74.0	-14.3	1.12 H	184	56.57	3.13
2	5023.00	49.3 AV	54.0	-4.7	1.12 H	184	46.17	3.13
3	5150.00	72.1 PK	74.0	-1.9	2.06 H	177	68.47	3.63
4	5150.00	53.3 AV	54.0	-0.7	2.06 H	177	49.67	3.63
5	*5180.00	118.9 PK			1.98 H	175	115.13	3.77
6	*5180.00	108.3 AV			1.98 H	175	104.53	3.77
7	5395.00	62.1 PK	74.0	-11.9	1.66 H	143	57.82	4.28
8	5395.00	53.6 AV	54.0	-0.4	1.66 H	143	49.32	4.28
9	#10360.00	59.6 PK	74.0	-14.4	1.66 H	105	50.23	9.37
10	#10360.00	48.1 AV	54.0	-5.9	1.66 H	105	38.73	9.37
11	15540.00	63.1 PK	74.0	-10.9	1.59 H	182	48.69	14.41
12	15540.00	50.6 AV	54.0	-3.4	1.59 H	182	36.19	14.41

**ANTENNA POLARITY & TEST DISTANCE: VERTICAL AT 3 M**

NO.	FREQ. (MHz)	EMISSION LEVEL (dBuV/m)	LIMIT (dBuV/m)	MARGIN (dB)	ANTENNA HEIGHT (m)	TABLE ANGLE (Degree)	RAW VALUE (dBuV)	CORRECTION FACTOR (dB/m)
1	5023.00	56.8 PK	74.0	-17.2	2.16 V	21	53.67	3.13
2	5023.00	46.5 AV	54.0	-7.5	2.16 V	21	43.37	3.13
3	5150.00	69.2 PK	74.0	-4.8	1.94 V	22	65.57	3.63
4	5150.00	49.6 AV	54.0	-4.4	1.94 V	22	45.97	3.63
5	*5180.00	115.2 PK			1.88 V	20	111.43	3.77
6	*5180.00	106.1 AV			1.88 V	20	102.33	3.77
7	5395.00	58.2 PK	74.0	-15.8	1.26 V	131	53.92	4.28
8	5395.00	46.8 AV	54.0	-7.2	1.26 V	131	42.52	4.28
9	#10360.00	57.4 PK	74.0	-16.6	1.88 V	295	48.03	9.37
10	#10360.00	46.1 AV	54.0	-7.9	1.88 V	295	36.73	9.37
11	15540.00	68.0 PK	74.0	-6.0	1.79 V	332	53.59	14.41
12	15540.00	53.2 AV	54.0	-0.8	1.79 V	332	38.79	14.41

**REMARKS:**

1. Emission Level(dBuV/m) = Raw Value(dBuV) + Correction Factor(dB/m)
2. Correction Factor(dB/m) = Antenna Factor(dB/m) + Cable Factor(dB) – Pre-Amplifier Factor(dB)
3. The other emission levels were very low against the limit.
4. Margin value = Emission Level – Limit value
5. " \* ": Fundamental frequency.
6. " # ": The radiated frequency is out of the restricted band.

<b>CHANNEL</b>	TX Channel 40	<b>DETECTOR FUNCTION</b>	Peak (PK)
<b>FREQUENCY RANGE</b>	1GHz ~ 40GHz		Average (AV)

**ANTENNA POLARITY & TEST DISTANCE: HORIZONTAL AT 3 M**

NO.	FREQ. (MHz)	EMISSION LEVEL (dBuV/m)	LIMIT (dBuV/m)	MARGIN (dB)	ANTENNA HEIGHT (m)	TABLE ANGLE (Degree)	RAW VALUE (dBuV)	CORRECTION FACTOR (dB/m)
1	*5200.00	113.4 PK			1.98 H	172	109.54	3.86
2	*5200.00	103.4 AV			1.98 H	172	99.54	3.86
3	5360.00	64.1 PK	74.0	-9.9	1.85 H	168	59.97	4.13
4	<b>5360.00</b>	<b>53.9 AV</b>	<b>54.0</b>	<b>-0.1</b>	<b>1.85 H</b>	<b>168</b>	<b>49.77</b>	<b>4.13</b>
5	5416.00	60.2 PK	74.0	-13.8	1.87 H	125	55.90	4.30
6	5416.00	53.1 AV	54.0	-0.9	1.87 H	125	48.80	4.30
7	#10400.00	59.2 PK	74.0	-14.8	1.86 H	115	49.78	9.42
8	#10400.00	48.5 AV	54.0	-5.5	1.86 H	115	39.08	9.42
9	15600.00	64.5 PK	74.0	-9.5	1.57 H	191	49.81	14.69
10	15600.00	51.6 AV	54.0	-2.4	1.57 H	191	36.91	14.69

**ANTENNA POLARITY & TEST DISTANCE: VERTICAL AT 3 M**

NO.	FREQ. (MHz)	EMISSION LEVEL (dBuV/m)	LIMIT (dBuV/m)	MARGIN (dB)	ANTENNA HEIGHT (m)	TABLE ANGLE (Degree)	RAW VALUE (dBuV)	CORRECTION FACTOR (dB/m)
1	*5200.00	111.0 PK			1.79 V	360	107.14	3.86
2	*5200.00	101.5 AV			1.79 V	360	97.64	3.86
3	5360.00	57.3 PK	74.0	-16.7	1.71 V	291	53.17	4.13
4	5360.00	47.1 AV	54.0	-6.9	1.71 V	291	42.97	4.13
5	5416.00	61.8 PK	74.0	-12.2	1.80 V	360	57.50	4.30
6	5416.00	52.3 AV	54.0	-1.7	1.80 V	360	48.00	4.30
7	#10400.00	57.0 PK	74.0	-17.0	2.05 V	315	47.58	9.42
8	#10400.00	45.8 AV	54.0	-8.2	2.05 V	315	36.38	9.42
9	15600.00	66.7 PK	74.0	-7.3	1.90 V	299	52.01	14.69
10	15600.00	52.0 AV	54.0	-2.0	1.90 V	299	37.31	14.69

**REMARKS:**

1. Emission Level(dBuV/m) = Raw Value(dBuV) + Correction Factor(dB/m)
2. Correction Factor(dB/m) = Antenna Factor(dB/m) + Cable Factor(dB) – Pre-Amplifier Factor(dB)
3. The other emission levels were very low against the limit.
4. Margin value = Emission Level – Limit value
5. " \* ": Fundamental frequency.
6. " # ": The radiated frequency is out of the restricted band.

<b>CHANNEL</b>	TX Channel 48	<b>DETECTOR FUNCTION</b>	Peak (PK)
<b>FREQUENCY RANGE</b>	1GHz ~ 40GHz		Average (AV)

**ANTENNA POLARITY & TEST DISTANCE: HORIZONTAL AT 3 M**

NO.	FREQ. (MHz)	EMISSION LEVEL (dBuV/m)	LIMIT (dBuV/m)	MARGIN (dB)	ANTENNA HEIGHT (m)	TABLE ANGLE (Degree)	RAW VALUE (dBuV)	CORRECTION FACTOR (dB/m)
1	*5240.00	113.9 PK			1.62 H	146	110.02	3.88
2	*5240.00	103.6 AV			1.62 H	146	99.72	3.88
3	5400.00	64.6 PK	74.0	-9.4	1.79 H	134	60.30	4.30
4	5400.00	53.7 AV	54.0	-0.3	1.79 H	134	49.40	4.30
5	5458.00	59.3 PK	74.0	-14.7	1.51 H	144	54.96	4.34
6	5458.00	53.1 AV	54.0	-0.9	1.51 H	144	48.76	4.34
7	#10480.00	60.5 PK	74.0	-13.5	1.67 H	74	50.90	9.60
8	#10480.00	49.0 AV	54.0	-5.0	1.67 H	74	39.40	9.60
9	15720.00	62.5 PK	74.0	-11.5	1.59 H	186	48.35	14.15
10	15720.00	50.5 AV	54.0	-3.5	1.59 H	186	36.35	14.15

**ANTENNA POLARITY & TEST DISTANCE: VERTICAL AT 3 M**

NO.	FREQ. (MHz)	EMISSION LEVEL (dBuV/m)	LIMIT (dBuV/m)	MARGIN (dB)	ANTENNA HEIGHT (m)	TABLE ANGLE (Degree)	RAW VALUE (dBuV)	CORRECTION FACTOR (dB/m)
1	*5240.00	110.2 PK			1.23 V	97	106.32	3.88
2	*5240.00	101.0 AV			1.23 V	97	97.12	3.88
3	5400.00	52.9 PK	74.0	-21.1	1.27 V	94	48.60	4.30
4	5400.00	43.5 AV	54.0	-10.5	1.27 V	94	39.20	4.30
5	5458.00	61.1 PK	74.0	-12.9	1.00 V	73	56.76	4.34
6	5458.00	48.5 AV	54.0	-5.5	1.00 V	73	44.16	4.34
7	#10480.00	57.1 PK	74.0	-16.9	2.02 V	293	47.50	9.60
8	#10480.00	45.9 AV	54.0	-8.1	2.02 V	293	36.30	9.60
9	15720.00	67.7 PK	74.0	-6.3	1.81 V	309	53.55	14.15
10	15720.00	52.4 AV	54.0	-1.6	1.81 V	309	38.25	14.15

**REMARKS:**

1. Emission Level(dBuV/m) = Raw Value(dBuV) + Correction Factor(dB/m)
2. Correction Factor(dB/m) = Antenna Factor(dB/m) + Cable Factor(dB) – Pre-Amplifier Factor(dB)
3. The other emission levels were very low against the limit.
4. Margin value = Emission Level – Limit value
5. " \* ": Fundamental frequency.
6. " # ": The radiated frequency is out of the restricted band.

<b>CHANNEL</b>	TX Channel 149	<b>DETECTOR FUNCTION</b>	Peak (PK)
<b>FREQUENCY RANGE</b>	1GHz ~ 40GHz		Average (AV)

**ANTENNA POLARITY & TEST DISTANCE: HORIZONTAL AT 3 M**

NO.	FREQ. (MHz)	EMISSION LEVEL (dBuV/m)	LIMIT (dBuV/m)	MARGIN (dB)	ANTENNA HEIGHT (m)	TABLE ANGLE (Degree)	RAW VALUE (dBuV)	CORRECTION FACTOR (dB/m)
1	#5715.00	59.2 PK	74.0	-14.8	1.46 H	150	54.27	4.93
2	#5715.00	45.8 AV	54.0	-8.2	1.46 H	150	40.87	4.93
3	#5725.00	78.0 PK	78.2	-0.2	2.01 H	100	73.04	4.96
4	*5745.00	115.2 PK			1.31 H	144	110.23	4.97
5	*5745.00	107.2 AV			1.31 H	144	102.23	4.97
6	#5905.00	60.3 PK	74.0	-13.7	1.89 H	72	54.96	5.34
7	#5905.00	50.1 AV	54.0	-3.9	1.89 H	72	44.76	5.34
8	11490.00	59.9 PK	74.0	-14.1	1.64 H	125	49.30	10.60
9	11490.00	48.4 AV	54.0	-5.6	1.64 H	125	37.80	10.60
10	#17235.00	63.0 PK	74.0	-11.0	1.66 H	189	44.79	18.21
11	#17235.00	50.5 AV	54.0	-3.5	1.66 H	189	32.29	18.21

**ANTENNA POLARITY & TEST DISTANCE: VERTICAL AT 3 M**

NO.	FREQ. (MHz)	EMISSION LEVEL (dBuV/m)	LIMIT (dBuV/m)	MARGIN (dB)	ANTENNA HEIGHT (m)	TABLE ANGLE (Degree)	RAW VALUE (dBuV)	CORRECTION FACTOR (dB/m)
1	#5715.00	59.4 PK	74.0	-14.6	1.45 V	163	54.47	4.93
2	#5715.00	45.9 AV	54.0	-8.1	1.45 V	163	40.97	4.93
3	#5725.00	75.5 PK	78.2	-2.7	1.59 V	107	70.54	4.96
4	*5745.00	113.3 PK			1.61 V	197	108.33	4.97
5	*5745.00	103.8 AV			1.61 V	197	98.83	4.97
6	#5905.00	61.6 PK	74.0	-12.4	1.43 V	200	56.26	5.34
7	#5905.00	51.7 AV	54.0	-2.3	1.43 V	200	46.36	5.34
8	11490.00	56.6 PK	74.0	-17.4	1.44 V	156	46.00	10.60
9	11490.00	46.8 AV	54.0	-7.2	1.44 V	156	36.20	10.60
10	#17235.00	68.6 PK	74.0	-5.4	1.45 V	123	50.39	18.21
11	#17235.00	50.1 AV	54.0	-3.9	1.45 V	123	31.89	18.21

**REMARKS:**

1. Emission Level(dBuV/m) = Raw Value(dBuV) + Correction Factor(dB/m)
2. Correction Factor(dB/m) = Antenna Factor(dB/m) + Cable Factor(dB) – Pre-Amplifier Factor(dB)
3. The other emission levels were very low against the limit.
4. Margin value = Emission Level – Limit value
5. " \* ": Fundamental frequency.
6. " # ": The radiated frequency is out of the restricted band.

<b>CHANNEL</b>	TX Channel 157	<b>DETECTOR FUNCTION</b>	Peak (PK)
<b>FREQUENCY RANGE</b>	1GHz ~ 40GHz		Average (AV)

**ANTENNA POLARITY & TEST DISTANCE: HORIZONTAL AT 3 M**

NO.	FREQ. (MHz)	EMISSION LEVEL (dBuV/m)	LIMIT (dBuV/m)	MARGIN (dB)	ANTENNA HEIGHT (m)	TABLE ANGLE (Degree)	RAW VALUE (dBuV)	CORRECTION FACTOR (dB/m)
1	#5624.00	67.5 PK	68.2	-0.7	1.31 H	139	62.63	4.87
2	*5785.00	118.8 PK			1.30 H	176	113.77	5.03
3	*5785.00	111.1 AV			1.30 H	176	106.07	5.03
4	11570.00	59.5 PK	74.0	-14.5	1.09 H	279	48.94	10.56
5	11570.00	46.6 AV	54.0	-7.4	1.09 H	279	36.04	10.56
6	#17355.00	69.9 PK	74.0	-4.1	1.62 H	107	51.08	18.82
7	#17355.00	51.0 AV	54.0	-3.0	1.62 H	107	32.18	18.82

**ANTENNA POLARITY & TEST DISTANCE: VERTICAL AT 3 M**

NO.	FREQ. (MHz)	EMISSION LEVEL (dBuV/m)	LIMIT (dBuV/m)	MARGIN (dB)	ANTENNA HEIGHT (m)	TABLE ANGLE (Degree)	RAW VALUE (dBuV)	CORRECTION FACTOR (dB/m)
1	#5624.00	65.2 PK	68.2	-3.0	1.50 V	218	60.33	4.87
2	*5785.00	116.6 PK			1.00 V	139	111.57	5.03
3	*5785.00	107.5 AV			1.00 V	139	102.47	5.03
4	11570.00	57.9 PK	74.0	-16.1	1.60 V	141	47.34	10.56
5	11570.00	46.8 AV	54.0	-7.2	1.60 V	141	36.24	10.56
6	#17355.00	69.1 PK	74.0	-4.9	1.47 V	141	50.28	18.82
7	#17355.00	50.3 AV	54.0	-3.7	1.47 V	141	31.48	18.82

**REMARKS:**

1. Emission Level(dBuV/m) = Raw Value(dBuV) + Correction Factor(dB/m)
2. Correction Factor(dB/m) = Antenna Factor(dB/m) + Cable Factor(dB) – Pre-Amplifier Factor(dB)
3. The other emission levels were very low against the limit.
4. Margin value = Emission Level – Limit value
5. " \* ": Fundamental frequency.
6. " # ": The radiated frequency is out of the restricted band.

<b>CHANNEL</b>	TX Channel 165	<b>DETECTOR FUNCTION</b>	Peak (PK)
<b>FREQUENCY RANGE</b>	1GHz ~ 40GHz		Average (AV)

**ANTENNA POLARITY & TEST DISTANCE: HORIZONTAL AT 3 M**

NO.	FREQ. (MHz)	EMISSION LEVEL (dBuV/m)	LIMIT (dBuV/m)	MARGIN (dB)	ANTENNA HEIGHT (m)	TABLE ANGLE (Degree)	RAW VALUE (dBuV)	CORRECTION FACTOR (dB/m)
1	#5663.00	66.3 PK	68.2	-1.9	2.46 H	148	61.40	4.90
2	*5825.00	117.9 PK			1.48 H	142	112.79	5.11
3	*5825.00	109.6 AV			1.48 H	142	104.49	5.11
4	#5850.00	78.0 PK	78.2	-0.2	1.42 H	150	72.82	5.18
5	#5860.00	67.3 PK	74.0	-6.7	2.07 H	126	62.09	5.21
6	#5860.00	51.2 AV	54.0	-2.8	2.07 H	126	45.99	5.21
7	#5983.00	66.0 PK	68.2	-2.2	1.68 H	133	60.45	5.55
8	11650.00	59.6 PK	74.0	-14.4	1.11 H	302	49.15	10.45
9	11650.00	46.6 AV	54.0	-7.4	1.11 H	302	36.15	10.45
10	#17475.00	69.1 PK	74.0	-4.9	1.63 H	100	49.87	19.23
11	#17475.00	50.7 AV	54.0	-3.3	1.63 H	100	31.47	19.23

**ANTENNA POLARITY & TEST DISTANCE: VERTICAL AT 3 M**

NO.	FREQ. (MHz)	EMISSION LEVEL (dBuV/m)	LIMIT (dBuV/m)	MARGIN (dB)	ANTENNA HEIGHT (m)	TABLE ANGLE (Degree)	RAW VALUE (dBuV)	CORRECTION FACTOR (dB/m)
1	#5663.00	64.5 PK	68.2	-3.7	1.31 V	198	59.60	4.90
2	*5825.00	116.6 PK			1.07 V	142	111.49	5.11
3	*5825.00	109.2 AV			1.07 V	142	104.09	5.11
4	#5850.00	76.2 PK	78.2	-2.0	1.57 V	110	71.02	5.18
5	#5860.00	66.0 PK	74.0	-8.0	1.46 V	190	60.79	5.21
6	#5860.00	50.9 AV	54.0	-3.1	1.46 V	190	45.69	5.21
7	#5983.00	62.6 PK	68.2	-5.6	1.39 V	205	57.05	5.55
8	11650.00	57.0 PK	74.0	-17.0	1.48 V	153	46.55	10.45
9	11650.00	46.5 AV	54.0	-7.5	1.48 V	153	36.05	10.45
10	#17475.00	67.9 PK	74.0	-6.1	1.55 V	133	48.67	19.23
11	#17475.00	49.5 AV	54.0	-4.5	1.55 V	133	30.27	19.23

**REMARKS:**

1. Emission Level(dBuV/m) = Raw Value(dBuV) + Correction Factor(dB/m)
2. Correction Factor(dB/m) = Antenna Factor(dB/m) + Cable Factor(dB) – Pre-Amplifier Factor(dB)
3. The other emission levels were very low against the limit.
4. Margin value = Emission Level – Limit value
5. " \* ": Fundamental frequency.
6. " # ": The radiated frequency is out of the restricted band.

802.11ac (VHT40)

<b>CHANNEL</b>	TX Channel 38	<b>DETECTOR FUNCTION</b>	Peak (PK)
<b>FREQUENCY RANGE</b>	1GHz ~ 40GHz		Average (AV)

ANTENNA POLARITY & TEST DISTANCE: HORIZONTAL AT 3 M								
NO.	FREQ. (MHz)	EMISSION LEVEL (dBuV/m)	LIMIT (dBuV/m)	MARGIN (dB)	ANTENNA HEIGHT (m)	TABLE ANGLE (Degree)	RAW VALUE (dBuV)	CORRECTION FACTOR (dB/m)
1	5150.00	67.7 PK	74.0	-6.3	2.13 H	131	64.07	3.63
2	5150.00	53.6 AV	54.0	-0.4	2.13 H	131	49.97	3.63
3	*5190.00	111.1 PK			1.52 H	152	107.28	3.82
4	*5190.00	100.5 AV			1.52 H	152	96.68	3.82
5	#5622.00	62.9 PK	68.2	-5.3	1.81 H	107	58.03	4.87
6	#10380.00	58.9 PK	68.2	-9.3	1.81 H	94	49.50	9.40
7	15570.00	64.8 PK	74.0	-9.2	1.62 H	196	50.25	14.55
8	15570.00	51.6 AV	54.0	-2.4	1.62 H	196	37.05	14.55

ANTENNA POLARITY & TEST DISTANCE: VERTICAL AT 3 M								
NO.	FREQ. (MHz)	EMISSION LEVEL (dBuV/m)	LIMIT (dBuV/m)	MARGIN (dB)	ANTENNA HEIGHT (m)	TABLE ANGLE (Degree)	RAW VALUE (dBuV)	CORRECTION FACTOR (dB/m)
1	5150.00	65.6 PK	74.0	-8.4	2.07 V	31	61.97	3.63
2	5150.00	50.3 AV	54.0	-3.7	2.07 V	31	46.67	3.63
3	*5190.00	107.2 PK			1.22 V	72	103.38	3.82
4	*5190.00	96.7 AV			1.22 V	72	92.88	3.82
5	#5622.00	57.1 PK	68.2	-11.1	2.29 V	23	52.23	4.87
6	#10380.00	57.3 PK	68.2	-10.9	2.05 V	325	47.90	9.40
7	15570.00	67.1 PK	74.0	-6.9	1.98 V	340	52.55	14.55
8	15570.00	52.3 AV	54.0	-1.7	1.98 V	340	37.75	14.55

**REMARKS:**

1. Emission Level(dBuV/m) = Raw Value(dBuV) + Correction Factor(dB/m)
2. Correction Factor(dB/m) = Antenna Factor(dB/m) + Cable Factor(dB) – Pre-Amplifier Factor(dB)
3. The other emission levels were very low against the limit.
4. Margin value = Emission Level – Limit value
5. " \* ": Fundamental frequency.
6. " # ": The radiated frequency is out of the restricted band.

<b>CHANNEL</b>	TX Channel 46	<b>DETECTOR FUNCTION</b>	Peak (PK)
<b>FREQUENCY RANGE</b>	1GHz ~ 40GHz		Average (AV)

**ANTENNA POLARITY & TEST DISTANCE: HORIZONTAL AT 3 M**

NO.	FREQ. (MHz)	EMISSION LEVEL (dBuV/m)	LIMIT (dBuV/m)	MARGIN (dB)	ANTENNA HEIGHT (m)	TABLE ANGLE (Degree)	RAW VALUE (dBuV)	CORRECTION FACTOR (dB/m)
1	*5230.00	113.8 PK			1.78 H	98	109.94	3.86
2	*5230.00	103.7 AV			1.78 H	98	99.84	3.86
3	5376.00	63.7 PK	74.0	-10.3	1.35 H	48	59.50	4.20
<b>4</b>	<b>5376.00</b>	<b>53.9 AV</b>	<b>54.0</b>	<b>-0.1</b>	<b>1.35 H</b>	<b>48</b>	<b>49.70</b>	<b>4.20</b>
5	#5665.00	64.3 PK	68.2	-3.9	1.74 H	112	59.40	4.90
6	#10460.00	60.2 PK	68.2	-8.0	1.79 H	93	50.64	9.56
7	15690.00	63.9 PK	74.0	-10.1	1.57 H	191	49.73	14.17
8	15690.00	51.2 AV	54.0	-2.8	1.57 H	191	37.03	14.17

**ANTENNA POLARITY & TEST DISTANCE: VERTICAL AT 3 M**

NO.	FREQ. (MHz)	EMISSION LEVEL (dBuV/m)	LIMIT (dBuV/m)	MARGIN (dB)	ANTENNA HEIGHT (m)	TABLE ANGLE (Degree)	RAW VALUE (dBuV)	CORRECTION FACTOR (dB/m)
1	*5230.00	107.4 PK			2.06 V	191	103.54	3.86
2	*5230.00	101.9 AV			2.06 V	191	98.04	3.86
3	5376.00	61.0 PK	74.0	-13.0	1.72 V	198	56.80	4.20
4	5376.00	48.4 AV	54.0	-5.6	1.72 V	198	44.20	4.20
5	#5665.00	59.6 PK	68.2	-8.6	1.57 V	315	54.70	4.90
6	#10460.00	59.0 PK	68.2	-9.2	2.07 V	297	49.44	9.56
7	15690.00	68.3 PK	74.0	-5.7	1.77 V	317	54.13	14.17
8	15690.00	52.4 AV	54.0	-1.6	1.77 V	317	38.23	14.17

**REMARKS:**

1. Emission Level(dBuV/m) = Raw Value(dBuV) + Correction Factor(dB/m)
2. Correction Factor(dB/m) = Antenna Factor(dB/m) + Cable Factor(dB) – Pre-Amplifier Factor(dB)
3. The other emission levels were very low against the limit.
4. Margin value = Emission Level – Limit value
5. " \* ": Fundamental frequency.
6. " # ": The radiated frequency is out of the restricted band.



<b>CHANNEL</b>	TX Channel 151	<b>DETECTOR FUNCTION</b>	Peak (PK)
<b>FREQUENCY RANGE</b>	1GHz ~ 40GHz		Average (AV)

**ANTENNA POLARITY & TEST DISTANCE: HORIZONTAL AT 3 M**

NO.	FREQ. (MHz)	EMISSION LEVEL (dBuV/m)	LIMIT (dBuV/m)	MARGIN (dB)	ANTENNA HEIGHT (m)	TABLE ANGLE (Degree)	RAW VALUE (dBuV)	CORRECTION FACTOR (dB/m)
1	#5715.00	68.3 PK	74.0	-5.7	1.81 H	141	63.37	4.93
2	#5715.00	53.6 AV	54.0	-0.4	1.81 H	141	48.67	4.93
3	#5725.00	69.5 PK	78.2	-8.7	1.27 H	141	64.54	4.96
4	*5755.00	110.1 PK			1.26 H	146	105.11	4.99
5	*5755.00	100.8 AV			1.26 H	146	95.81	4.99
6	11510.00	58.8 PK	74.0	-15.2	1.02 H	248	48.19	10.61
7	11510.00	46.3 AV	54.0	-7.7	1.02 H	248	35.69	10.61
8	#17265.00	69.1 PK	74.0	-4.9	1.54 H	75	50.75	18.35
9	#17265.00	50.1 AV	54.0	-3.9	1.54 H	75	31.75	18.35

**ANTENNA POLARITY & TEST DISTANCE: VERTICAL AT 3 M**

NO.	FREQ. (MHz)	EMISSION LEVEL (dBuV/m)	LIMIT (dBuV/m)	MARGIN (dB)	ANTENNA HEIGHT (m)	TABLE ANGLE (Degree)	RAW VALUE (dBuV)	CORRECTION FACTOR (dB/m)
1	#5715.00	64.3 PK	74.0	-9.7	1.81 V	241	59.37	4.93
2	#5715.00	50.9 AV	54.0	-3.1	1.81 V	241	45.97	4.93
3	#5725.00	75.6 PK	78.2	-2.6	1.86 V	233	70.64	4.96
4	*5755.00	108.4 PK			1.71 V	102	103.41	4.99
5	*5755.00	98.5 AV			1.71 V	102	93.51	4.99
6	11510.00	56.8 PK	74.0	-17.2	1.26 V	135	46.19	10.61
7	11510.00	46.9 AV	54.0	-7.1	1.26 V	135	36.29	10.61
8	#17265.00	68.7 PK	74.0	-5.3	1.27 V	101	50.35	18.35
9	#17265.00	50.5 AV	54.0	-3.5	1.27 V	101	32.15	18.35

**REMARKS:**

1. Emission Level(dBuV/m) = Raw Value(dBuV) + Correction Factor(dB/m)
2. Correction Factor(dB/m) = Antenna Factor(dB/m) + Cable Factor(dB) – Pre-Amplifier Factor(dB)
3. The other emission levels were very low against the limit.
4. Margin value = Emission Level – Limit value
5. " \* ": Fundamental frequency.
6. " # ": The radiated frequency is out of the restricted band.

<b>CHANNEL</b>	TX Channel 159	<b>DETECTOR FUNCTION</b>	Peak (PK)
<b>FREQUENCY RANGE</b>	1GHz ~ 40GHz		Average (AV)

**ANTENNA POLARITY & TEST DISTANCE: HORIZONTAL AT 3 M**

NO.	FREQ. (MHz)	EMISSION LEVEL (dBuV/m)	LIMIT (dBuV/m)	MARGIN (dB)	ANTENNA HEIGHT (m)	TABLE ANGLE (Degree)	RAW VALUE (dBuV)	CORRECTION FACTOR (dB/m)
1	*5795.00	117.1 PK			1.53 H	138	112.05	5.05
2	*5795.00	106.7 AV			1.53 H	138	101.65	5.05
3	#5850.00	70.1 PK	78.2	-8.1	1.34 H	176	64.92	5.18
4	#5860.00	69.8 PK	74.0	-4.2	1.34 H	176	64.59	5.21
5	#5860.00	53.1 AV	54.0	-0.9	1.34 H	176	47.89	5.21
6	11590.00	58.8 PK	74.0	-15.2	1.14 H	250	48.26	10.54
7	11590.00	46.1 AV	54.0	-7.9	1.14 H	250	35.56	10.54
8	#17385.00	67.9 PK	74.0	-6.1	1.42 H	73	48.90	19.00
9	#17385.00	49.5 AV	54.0	-4.5	1.42 H	73	30.50	19.00

**ANTENNA POLARITY & TEST DISTANCE: VERTICAL AT 3 M**

NO.	FREQ. (MHz)	EMISSION LEVEL (dBuV/m)	LIMIT (dBuV/m)	MARGIN (dB)	ANTENNA HEIGHT (m)	TABLE ANGLE (Degree)	RAW VALUE (dBuV)	CORRECTION FACTOR (dB/m)
1	*5795.00	114.5 PK			1.78 V	190	109.45	5.05
2	*5795.00	103.8 AV			1.78 V	190	98.75	5.05
3	#5850.00	75.1 PK	78.2	-3.1	1.70 V	220	69.92	5.18
4	#5860.00	67.4 PK	74.0	-6.6	1.76 V	252	62.19	5.21
5	#5860.00	50.7 AV	54.0	-3.3	1.76 V	252	45.49	5.21
6	11590.00	57.0 PK	74.0	-17.0	1.53 V	138	46.46	10.54
7	11590.00	46.4 AV	54.0	-7.6	1.53 V	138	35.86	10.54
8	#17385.00	67.3 PK	74.0	-6.7	1.32 V	121	48.30	19.00
9	#17385.00	49.2 AV	54.0	-4.8	1.32 V	121	30.20	19.00

**REMARKS:**

1. Emission Level(dBuV/m) = Raw Value(dBuV) + Correction Factor(dB/m)
2. Correction Factor(dB/m) = Antenna Factor(dB/m) + Cable Factor(dB) – Pre-Amplifier Factor(dB)
3. The other emission levels were very low against the limit.
4. Margin value = Emission Level – Limit value
5. " \* ": Fundamental frequency.
6. " # ": The radiated frequency is out of the restricted band.

**802.11ac (VHT80)**

<b>CHANNEL</b>	TX Channel 42	<b>DETECTOR FUNCTION</b>	Peak (PK)
<b>FREQUENCY RANGE</b>	1GHz ~ 40GHz		Average (AV)

**ANTENNA POLARITY & TEST DISTANCE: HORIZONTAL AT 3 M**

NO.	FREQ. (MHz)	EMISSION LEVEL (dBuV/m)	LIMIT (dBuV/m)	MARGIN (dB)	ANTENNA HEIGHT (m)	TABLE ANGLE (Degree)	RAW VALUE (dBuV)	CORRECTION FACTOR (dB/m)
1	5150.00	64.1 PK	74.0	-9.9	1.32 H	142	60.47	3.63
2	5150.00	53.4 AV	54.0	-0.6	1.32 H	142	49.77	3.63
3	*5210.00	110.8 PK			1.51 H	143	106.95	3.85
4	*5210.00	99.0 AV			1.51 H	143	95.15	3.85
5	#5788.00	59.1 PK	68.2	-9.1	1.69 H	143	54.06	5.04
6	#10420.00	55.8 PK	68.2	-12.4	1.90 H	139	46.34	9.46
7	15630.00	55.2 PK	74.0	-18.8	1.77 H	35	40.68	14.52
8	15630.00	43.8 AV	54.0	-10.2	1.77 H	35	29.28	14.52

**ANTENNA POLARITY & TEST DISTANCE: VERTICAL AT 3 M**

NO.	FREQ. (MHz)	EMISSION LEVEL (dBuV/m)	LIMIT (dBuV/m)	MARGIN (dB)	ANTENNA HEIGHT (m)	TABLE ANGLE (Degree)	RAW VALUE (dBuV)	CORRECTION FACTOR (dB/m)
1	5150.00	60.0 PK	74.0	-14.0	1.82 V	199	56.37	3.63
2	5150.00	49.0 AV	54.0	-5.0	1.82 V	199	45.37	3.63
3	*5210.00	105.3 PK			1.24 V	150	101.45	3.85
4	*5210.00	94.8 AV			1.24 V	150	90.95	3.85
5	#5788.00	59.6 PK	68.2	-8.6	2.04 V	77	54.56	5.04
6	#10420.00	57.1 PK	68.2	-11.1	1.45 V	118	47.64	9.46
7	15630.00	64.2 PK	74.0	-9.8	1.15 V	295	49.68	14.52
8	15630.00	52.0 AV	54.0	-2.0	1.15 V	295	37.48	14.52

**REMARKS:**

- Emission Level(dBuV/m) = Raw Value(dBuV) + Correction Factor(dB/m)
- Correction Factor(dB/m) = Antenna Factor(dB/m) + Cable Factor(dB) – Pre-Amplifier Factor(dB)
- The other emission levels were very low against the limit.
- Margin value = Emission Level – Limit value
- " \* ": Fundamental frequency.
- " # ": The radiated frequency is out of the restricted band.

<b>CHANNEL</b>	TX Channel 155	<b>DETECTOR FUNCTION</b>	Peak (PK)
<b>FREQUENCY RANGE</b>	1GHz ~ 40GHz		Average (AV)

**ANTENNA POLARITY & TEST DISTANCE: HORIZONTAL AT 3 M**

NO.	FREQ. (MHz)	EMISSION LEVEL (dBuV/m)	LIMIT (dBuV/m)	MARGIN (dB)	ANTENNA HEIGHT (m)	TABLE ANGLE (Degree)	RAW VALUE (dBuV)	CORRECTION FACTOR (dB/m)
1	#5715.00	69.4 PK	74.0	-4.6	1.78 H	138	64.47	4.93
2	#5715.00	53.9 AV	54.0	-0.1	1.78 H	138	48.97	4.93
3	#5725.00	71.6 PK	78.2	-6.6	1.78 H	141	66.64	4.96
4	*5775.00	105.7 PK			1.76 H	120	100.69	5.01
5	*5775.00	95.4 AV			1.76 H	120	90.39	5.01
6	#5850.00	58.3 PK	78.2	-19.9	1.78 H	138	53.12	5.18
7	#5860.00	58.0 PK	74.0	-16.0	1.79 H	138	52.79	5.21
8	#5860.00	46.5 AV	54.0	-7.5	1.79 H	138	41.29	5.21
9	11550.00	58.8 PK	74.0	-15.2	1.04 H	249	48.23	10.57
10	11550.00	46.3 AV	54.0	-7.7	1.04 H	249	35.73	10.57
11	#17325.00	68.6 PK	74.0	-5.4	1.61 H	64	49.94	18.66
12	#17325.00	50.1 AV	54.0	-3.9	1.61 H	64	31.44	18.66

**ANTENNA POLARITY & TEST DISTANCE: VERTICAL AT 3 M**

NO.	FREQ. (MHz)	EMISSION LEVEL (dBuV/m)	LIMIT (dBuV/m)	MARGIN (dB)	ANTENNA HEIGHT (m)	TABLE ANGLE (Degree)	RAW VALUE (dBuV)	CORRECTION FACTOR (dB/m)
1	#5715.00	66.8 PK	74.0	-7.2	1.66 V	232	61.87	4.93
2	#5715.00	50.1 AV	54.0	-3.9	1.66 V	232	45.17	4.93
3	#5725.00	72.9 PK	78.2	-5.3	1.74 V	223	67.94	4.96
4	*5775.00	102.6 PK			1.78 V	207	97.59	5.01
5	*5775.00	92.3 AV			1.78 V	207	87.29	5.01
6	#5850.00	63.1 PK	78.2	-15.1	1.62 V	196	57.92	5.18
7	#5860.00	55.7 PK	74.0	-18.3	1.78 V	219	50.49	5.21
8	#5860.00	43.3 AV	54.0	-10.7	1.78 V	219	38.09	5.21
9	11550.00	56.9 PK	74.0	-17.1	1.56 V	123	46.33	10.57
10	11550.00	46.5 AV	54.0	-7.5	1.56 V	123	35.93	10.57
11	#17325.00	66.7 PK	74.0	-7.3	1.44 V	123	48.04	18.66
12	#17325.00	48.8 AV	54.0	-5.2	1.44 V	123	30.14	18.66

**REMARKS:**

1. Emission Level(dBuV/m) = Raw Value(dBuV) + Correction Factor(dB/m)
2. Correction Factor(dB/m) = Antenna Factor(dB/m) + Cable Factor(dB) – Pre-Amplifier Factor(dB)
3. The other emission levels were very low against the limit.
4. Margin value = Emission Level – Limit value
5. " \* ": Fundamental frequency.
6. " # ": The radiated frequency is out of the restricted band.

## 4.2 Conducted Emission Measurement

### 4.2.1 Limits of Conducted Emission Measurement

Frequency (MHz)	Conducted Limit (dBuV)	
	Quasi-peak	Average
0.15 - 0.5	66 - 56	56 - 46
0.50 - 5.0	56	46
5.0 - 30.0	60	50

Note: 1. The lower limit shall apply at the transition frequencies.

2. The limit decreases in line with the logarithm of the frequency in the range of 0.15 to 0.50MHz.

### 4.2.2 Test Instruments

DESCRIPTION & MANUFACTURER	MODEL NO.	SERIAL NO.	CALIBRATED DATE	CALIBRATED UNTIL
Test Receiver ROHDE & SCHWARZ	ESCS 30	100375	Apr. 29, 2014	Apr. 28, 2015
Line-Impedance Stabilization Network (for EUT) SCHWARZBECK	NSLK-8127	8127-522	Sep. 15, 2014	Sep. 14, 2015
Line-Impedance Stabilization Network (for Peripheral) ROHDE & SCHWARZ	ENV216	100071	Nov. 10, 2014	Nov. 09, 2015
RF Cable (JYEBAO)	5DFB	COCCAB-001	Mar. 10, 2014	Mar. 09, 2015
50 ohms Terminator	N/A	EMC-03	Sep. 22, 2014	Sep. 21, 2015
50 ohms Terminator	N/A	EMC-02	Sep. 30, 2014	Sep. 29, 2015
Software ADT	BV ADT_Cond_V7.3.7. 3	NA	NA	NA

**Note:**

1. The calibration interval of the above test instruments is 12 months and the calibrations are traceable to NML/ROC and NIST/USA.
2. The test was performed in Shielded Room No. C.
3. The VCCI Con C Registration No. is C-3611.
4. Tested Date: Feb. 26, 2015

#### 4.2.3 Test Procedure

- a. The EUT was placed 0.4 meters from the conducting wall of the shielded room with EUT being connected to the power mains through a line impedance stabilization network (LISN). Other support units were connected to the power mains through another LISN. The two LISNs provide 50 ohm/ 50uH of coupling impedance for the measuring instrument.
- b. Both lines of the power mains connected to the EUT were checked for maximum conducted interference.
- c. The frequency range from 150kHz to 30MHz was searched. Emission levels under (Limit - 20dB) was not recorded.

**NOTE:** All modes of operation were investigated and the worst-case emissions are reported.

#### 4.2.4 Deviation from Test Standard

No deviation.

#### 4.2.5 Test Setup

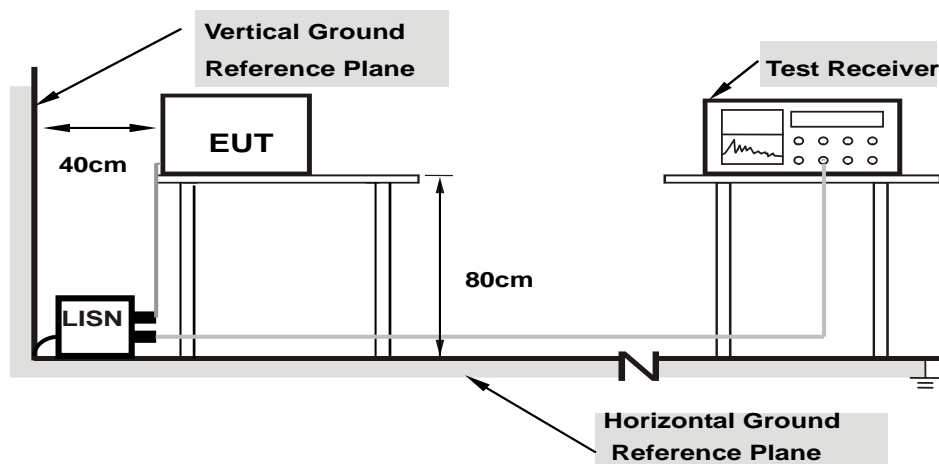

**Note: 1.Support units were connected to second LISN.**

For the actual test configuration, please refer to the attached file (Test Setup Photo).

#### 4.2.6 EUT Operating Condition

Same as 4.1.6.

#### 4.2.7 Test Results

Phase	Line (L)	Detector Function	Quasi-Peak (QP) / Average (AV)
-------	----------	-------------------	--------------------------------

No	Freq. [MHz]	Corr.	Reading Value		Emission Level		Limit		Margin	
		Factor	[dB (uV)]		[dB (uV)]		[dB (uV)]		(dB)	
	(dB)	Q.P.	AV.	Q.P.	AV.	Q.P.	AV.	Q.P.	AV.	
1	0.17734	0.07	39.99	26.33	40.06	26.40	64.61	54.61	-24.55	-28.21
2	0.20078	0.07	33.63	12.11	33.70	12.18	63.58	53.58	-29.88	-41.40
3	0.43125	0.09	31.74	27.95	31.83	28.04	57.23	47.23	-25.40	-19.19
4	0.76719	0.11	24.84	18.52	24.95	18.63	56.00	46.00	-31.05	-27.37
5	2.22656	0.19	22.68	16.66	22.87	16.85	56.00	46.00	-33.13	-29.15
6	15.48828	0.60	19.39	12.43	19.99	13.03	60.00	50.00	-40.01	-36.97

#### Remarks:

1. Q.P. and AV. are abbreviations of quasi-peak and average individually.
2. The emission levels of other frequencies were very low against the limit.
3. Margin value = Emission level – Limit value
4. Correction factor = Insertion loss + Cable loss
5. Emission Level = Correction Factor + Reading Value

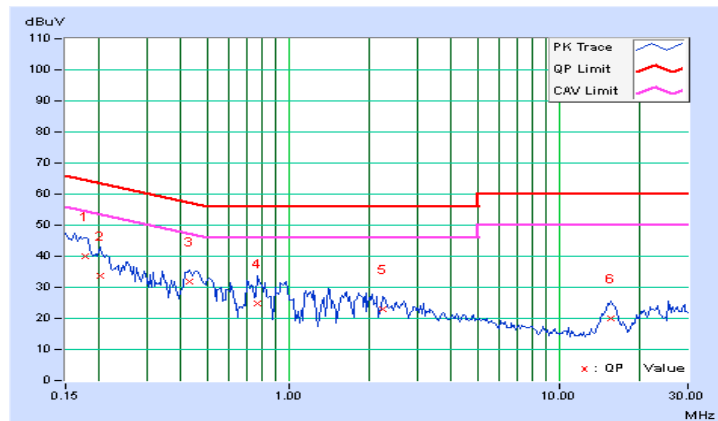

Phase	Neutral (N)	Detector Function	Quasi-Peak (QP) / Average (AV)
-------	-------------	-------------------	--------------------------------

No	Freq. [MHz]	Corr.	Reading Value		Emission Level		Limit		Margin	
		Factor	[dB (uV)]		[dB (uV)]		[dB (uV)]		(dB)	
	(dB)	Q.P.	AV.	Q.P.	AV.	Q.P.	AV.	Q.P.	AV.	
1	0.16562	0.06	43.00	31.02	43.06	31.08	65.18	55.18	-22.11	-24.09
2	0.25938	0.07	32.44	25.66	32.51	25.73	61.45	51.45	-28.94	-25.72
<b>3</b>	<b>0.46250</b>	<b>0.09</b>	<b>34.30</b>	<b>28.09</b>	<b>34.39</b>	<b>28.18</b>	<b>56.65</b>	<b>46.65</b>	<b>-22.25</b>	<b>-18.46</b>
4	0.78281	0.12	26.31	17.78	26.43	17.90	56.00	46.00	-29.57	-28.10
5	2.10938	0.18	22.23	15.32	22.41	15.50	56.00	46.00	-33.59	-30.50
6	14.95313	0.61	18.41	10.52	19.02	11.13	60.00	50.00	-40.98	-38.87

**Remarks:**

1. Q.P. and AV. are abbreviations of quasi-peak and average individually.
2. The emission levels of other frequencies were very low against the limit.
3. Margin value = Emission level – Limit value
4. Correction factor = Insertion loss + Cable loss
5. Emission Level = Correction Factor + Reading Value

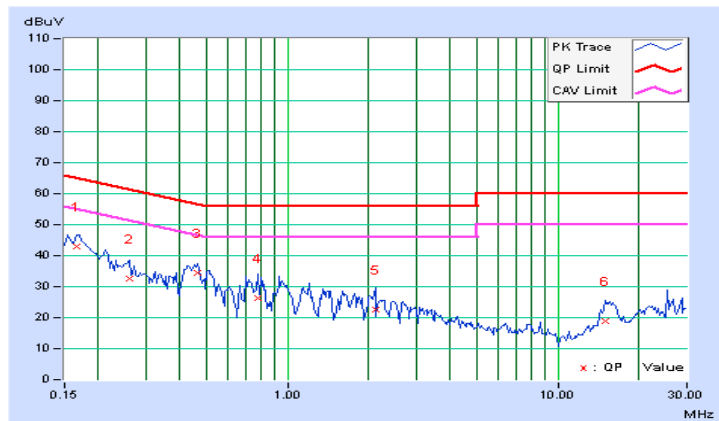



### 4.3 Transmit Power Measurement

#### 4.3.1 Limits of Transmit Power Measurement

Operation Band	EUT Category		LIMIT
U-NII-1		Outdoor Access Point	1 Watt (30 dBm) (Max. e.i.r.p $\leq$ 125mW(21 dBm) at any elevation angle above 30 degrees as measured from the horizon)
		Fixed point-to-point Access Point	1 Watt (30 dBm)
	√	Indoor Access Point	1 Watt (30 dBm)
		Mobile and Portable client device	250mW (24 dBm)
U-NII-2A	---		250mW (24 dBm) or 11 dBm+10 log B*
U-NII-2C	---		250mW (24 dBm) or 11 dBm+10 log B*
U-NII-3	√		1 Watt (30 dBm)

\*B is the 26 dB emission bandwidth in megahertz

Per KDB 662911 Method of conducted output power measurement on IEEE 802.11 devices,

Array Gain = 0 dB (i.e., no array gain) for  $N_{ANT} \leq 4$ ;

Array Gain = 0 dB (i.e., no array gain) for channel widths  $\geq 40$  MHz for any  $N_{ANT}$ ;

Array Gain =  $5 \log(N_{ANT}/N_{SS})$  dB or 3 dB, whichever is less for 20-MHz channel widths with  $N_{ANT} \geq 5$ .

For power measurements on all other devices: Array Gain =  $10 \log(N_{ANT}/N_{SS})$  dB.

#### 4.3.2 Test Setup

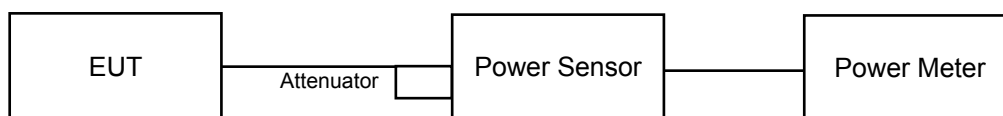

#### 4.3.3 Test Instruments

DESCRIPTION & MANUFACTURER	MODEL NO.	SERIAL NO.	CALIBRATED DATE	CALIBRATED UNTIL
Power meter Anritsu	ML2495A	1014008	Apr. 30, 2014	Apr. 29, 2015
Power sensor Anritsu	MA2411B	0917122	Apr. 30, 2014	Apr. 29, 2015

**Note:**

1. The calibration interval of the above test instruments is 12 months and the calibrations are traceable to NML/ROC and NIST/USA.
2. Tested date : Mar. 12, 2015

#### 4.3.4 Test Procedure

Method PM is used to perform output power measurement, trigger and gating function of wide band power meter is enabled to measure max output power of TX on burst. Duty factor is not added to measured value.

#### 4.3.5 Deviation from Test Standard

No deviation.

#### 4.3.6 EUT Operating Condition

The software provided by client to enable the EUT under transmission condition continuously at lowest, middle and highest channel frequencies individually.

**4.3.7 Test Result**
**CDD MODE**
**802.11a**

CHAN.	CHAN. FREQ. (MHz)	MAXIMUM CONDUCTED POWER (dBm)			TOTAL POWER (mW)	TOTAL POWER (dBm)	POWER LIMIT (dBm)	PASS / FAIL
		CHAIN 0	CHAIN 1	CHAIN 2				
36	5180	22.13	21.94	21.76	469.588	26.72	30	PASS
40	5200	20.17	20.20	20.13	311.744	24.94	30	PASS
48	5240	17.32	17.02	16.80	152.164	21.82	30	PASS
149	5745	19.66	19.06	18.90	250.633	23.99	30	PASS
157	5785	23.55	22.60	23.61	638.049	28.05	30	PASS
165	5825	22.95	22.02	23.30	570.259	27.56	30	PASS

**802.11ac (VHT20)**

CHAN.	CHAN. FREQ. (MHz)	MAXIMUM CONDUCTED POWER (dBm)			TOTAL POWER (mW)	TOTAL POWER (dBm)	POWER LIMIT (dBm)	PASS / FAIL
		CHAIN 0	CHAIN 1	CHAIN 2				
36	5180	21.99	22.15	22.09	483.992	26.85	30	PASS
40	5200	18.06	17.95	17.57	183.494	22.64	30	PASS
48	5240	18.86	18.76	18.56	223.854	23.50	30	PASS
149	5745	18.60	17.47	17.60	185.835	22.69	30	PASS
157	5785	23.51	22.60	23.89	651.264	28.14	30	PASS
165	5825	21.58	20.56	21.45	397.28	25.99	30	PASS

**802.11ac (VHT40)**

CHAN.	CHAN. FREQ. (MHz)	MAXIMUM CONDUCTED POWER (dBm)			TOTAL POWER (mW)	TOTAL POWER (dBm)	POWER LIMIT (dBm)	PASS / FAIL
		CHAIN 0	CHAIN 1	CHAIN 2				
38	5190	18.33	18.20	18.06	198.119	22.97	30	PASS
46	5230	19.55	19.41	19.53	267.197	24.27	30	PASS
151	5755	17.88	16.55	16.23	148.538	21.72	30	PASS
159	5795	22.65	21.91	22.84	531.625	27.26	30	PASS

**802.11ac (VHT80)**

CHAN.	CHAN. FREQ. (MHz)	MAXIMUM CONDUCTED POWER (dBm)			TOTAL POWER (mW)	TOTAL POWER (dBm)	POWER LIMIT (dBm)	PASS / FAIL
		CHAIN 0	CHAIN 1	CHAIN 2				
42	5210	17.40	17.38	17.04	160.238	22.05	30	PASS
155	5775	15.62	14.55	14.66	94.227	19.74	30	PASS

## Beamforming MODE

### 802.11ac (VHT20)

CHAN.	CHAN. FREQ. (MHz)	MAXIMUM CONDUCTED POWER (dBm)			TOTAL POWER (mW)	TOTAL POWER (dBm)	POWER LIMIT (dBm)	PASS / FAIL
		CHAIN 0	CHAIN 1	CHAIN 2				
36	5180	19.95	20.12	20.22	306.853	24.87	26.88	PASS
40	5200	15.55	15.96	15.94	114.602	20.59	26.88	PASS
48	5240	15.36	15.76	15.67	108.924	20.37	26.88	PASS
149	5745	15.24	15.62	16.67	116.347	20.66	26.88	PASS
157	5785	19.56	19.91	20.60	303.129	24.82	26.88	PASS
165	5825	17.56	17.84	18.42	187.332	22.73	26.88	PASS

**NOTE:** Directional gain =  $10 \log[(10^{G1/20} + 10^{G2/20} + 10^{G3/20})^2 / 3] = 9.12\text{dBi} > 6\text{dBi}$ , so the power limit shall be reduced to  $30 - (9.12 - 6) = 26.88\text{dBm}$ .

### 802.11ac (VHT40)

CHAN.	CHAN. FREQ. (MHz)	MAXIMUM CONDUCTED POWER (dBm)			TOTAL POWER (mW)	TOTAL POWER (dBm)	POWER LIMIT (dBm)	PASS / FAIL
		CHAIN 0	CHAIN 1	CHAIN 2				
38	5190	14.57	15.22	15.22	95.174	19.79	26.88	PASS
46	5230	19.01	19.24	19.27	248.09	23.95	26.88	PASS
151	5755	13.22	12.76	14.37	67.222	18.28	26.88	PASS
159	5795	20.31	20.62	21.13	352.462	25.47	26.88	PASS

**NOTE:** Directional gain =  $10 \log[(10^{G1/20} + 10^{G2/20} + 10^{G3/20})^2 / 3] = 9.12\text{dBi} > 6\text{dBi}$ , so the power limit shall be reduced to  $30 - (9.12 - 6) = 26.88\text{dBm}$ .

### 802.11ac (VHT80)

CHAN.	CHAN. FREQ. (MHz)	MAXIMUM CONDUCTED POWER (dBm)			TOTAL POWER (mW)	TOTAL POWER (dBm)	POWER LIMIT (dBm)	PASS / FAIL
		CHAIN 0	CHAIN 1	CHAIN 2				
42	5210	15.28	15.73	15.36	105.496	20.23	26.88	PASS
155	5775	11.58	11.80	13.26	50.708	17.05	26.88	PASS

**NOTE:** Directional gain =  $10 \log[(10^{G1/20} + 10^{G2/20} + 10^{G3/20})^2 / 3] = 9.12\text{dBi} > 6\text{dBi}$ , so the power limit shall be reduced to  $30 - (9.12 - 6) = 26.88\text{dBm}$ .

#### 4.4 Peak Power Spectral Density Measurement

##### 4.4.1 Limits of Peak Power Spectral Density Measurement

Operation Band	EUT Category		LIMIT
U-NII-1		Outdoor Access Point	17dBm/ MHz
		Fixed point-to-point Access Point	
	√	Indoor Access Point	
		Mobile and Portable client device	11dBm/ MHz
U-NII-2A	---		11dBm/ MHz
U-NII-2C	---		11dBm/ MHz
U-NII-3	√		30dBm/ 500kHz

##### 4.4.2 Test Setup

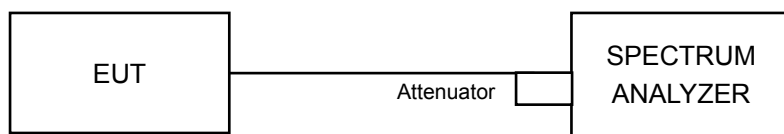

##### 4.4.3 Test Instruments

DESCRIPTION & MANUFACTURER	MODEL NO.	SERIAL NO.	CALIBRATED DATE	CALIBRATED UNTIL
SPECTRUM ANALYZER R&S	FSP 40	100060	May 08, 2014	May 07, 2015

**Note:**

1. The calibration interval of the above test instruments is 12 months and the calibrations are traceable to NML/ROC and NIST/USA.
2. Tested date: Mar. 12, 2015

#### 4.4.4 Test Procedure

##### For U-NII-1 band:

1. Set span to encompass the entire emission bandwidth (EBW) of the signal.
2. Set RBW = 1 MHz, Set VBW  $\geq$  3 MHz, Detector = RMS
3. Sweep time = auto, trigger set to "free run".
4. Trace average at least 100 traces in power averaging mode.
5. Record the max value and for duty cycle of test signal is  $<$  98% add 10 log (1/duty cycle)

##### For U-NII-3 band:

1. Set span to encompass the entire emission bandwidth (EBW) of the signal.
2. Set RBW = 300 kHz, Set VBW  $\geq$  1 MHz, Detector = RMS
3. Use the peak marker function to determine the maximum power level in any 300 kHz band segment within the fundamental EBW.
4. Scale the observed power level to an equivalent value in 500 kHz by adjusting (reducing) the measured power by a bandwidth correction factor (BWCF) where  $BWCF = 10\log(500 \text{ kHz}/300\text{kHz})$
5. Sweep time = auto, trigger set to "free run".
6. Trace average at least 100 traces in power averaging mode.
7. Record the max value and for duty cycle of test signal is  $<$  98% add 10 log (1/duty cycle)

#### 4.4.5 Deviation from Test Standard

No deviation.

#### 4.4.6 EUT Operating Condition

Same as Item 4.3.6.

#### 4.4.7 Test Results

##### CDD MODE For U-NII-1 Band 802.11a

CHAN.	CHAN. FREQ. (MHz)	PSD (dBm)			TOTAL POWER DENSITY (dBm)	MAX. LIMIT (dBm)	PASS / FAIL
		CHAIN 0	CHAIN 1	CHAIN 2			
36	5180	7.31	7.87	7.75	12.42	13.88	PASS
40	5200	5.85	6.41	6.38	10.99	13.88	PASS
48	5240	2.57	3.23	3.19	7.78	13.88	PASS

**NOTE:** 1. Method 1 of power density measurement of KDB 662911 is using for calculating total power density. Total power density is summing entire spectra across corresponding frequency bins on the various outputs by computer.

2. Directional gain =  $10 \log[(10^{G1/20} + 10^{G2/20} + 10^{G3/20})^2 / 3] = 9.12\text{dBi} > 6\text{dBi}$ , so the power density limit shall be reduced to  $17 - (9.12 - 6) = 13.88\text{dBm}$ .

##### 802.11ac (VHT20)

CHAN.	CHAN. FREQ. (MHz)	PSD (dBm)			TOTAL POWER DENSITY (dBm)	MAX. LIMIT (dBm)	PASS / FAIL
		CHAIN 0	CHAIN 1	CHAIN 2			
36	5180	7.72	7.84	7.12	12.34	13.88	PASS
40	5200	3.72	3.96	3.28	8.43	13.88	PASS
48	5240	4.54	5.10	4.34	9.44	13.88	PASS

**NOTE:** 1. Method 1 of power density measurement of KDB 662911 is using for calculating total power density. Total power density is summing entire spectra across corresponding frequency bins on the various outputs by computer.

2. Directional gain =  $10 \log[(10^{G1/20} + 10^{G2/20} + 10^{G3/20})^2 / 3] = 9.12\text{dBi} > 6\text{dBi}$ , so the power density limit shall be reduced to  $17 - (9.12 - 6) = 13.88\text{dBm}$ .



**802.11ac (VHT40)**

CHAN.	CHAN. FREQ. (MHz)	PSD (dBm)			DUTY FACTOR	TOTAL PSD WITH DUTY FACTOR (dBm)	MAX. LIMIT (dBm)	PASS / FAIL
		CHAIN 0	CHAIN 1	CHAIN 2				
38	5190	0.98	1.19	0.61	0.18	5.89	13.88	PASS
46	5230	2.56	2.63	2.01	0.18	7.36	13.88	PASS

- NOTE:** 1. Method 1 of power density measurement of KDB 662911 is using for calculating total power density. Total power density is summing entire spectra across corresponding frequency bins on the various outputs by computer.
2. Directional gain =  $10 \log[(10^{G1/20} + 10^{G2/20} + 10^{G3/20})^2 / 3] = 9.12\text{dBi} > 6\text{dBi}$  , so the power density limit shall be reduced to  $17-(9.12-6) = 13.88\text{dBm}$ .
3. Refer to section 3.3 for duty cycle spectrum plot.

**802.11ac (VHT80):**

CHAN.	CHAN. FREQ. (MHz)	PSD (dBm)			DUTY FACTOR	TOTAL PSD WITH DUTY FACTOR (dBm)	MAX. LIMIT (dBm)	PASS / FAIL
		CHAIN 0	CHAIN 1	CHAIN 2				
42	5210	-3.31	-2.77	-3.53	0.27	1.85	13.88	PASS

- NOTE:** 1. Method 1 of power density measurement of KDB 662911 is using for calculating total power density. Total power density is summing entire spectra across corresponding frequency bins on the various outputs by computer.
2. Directional gain =  $10 \log[(10^{G1/20} + 10^{G2/20} + 10^{G3/20})^2 / 3] = 9.12\text{dBi} > 6\text{dBi}$  , so the power density limit shall be reduced to  $17-(9.12-6) = 13.88\text{dBm}$ .
3. Refer to section 3.3 for duty cycle spectrum plot.

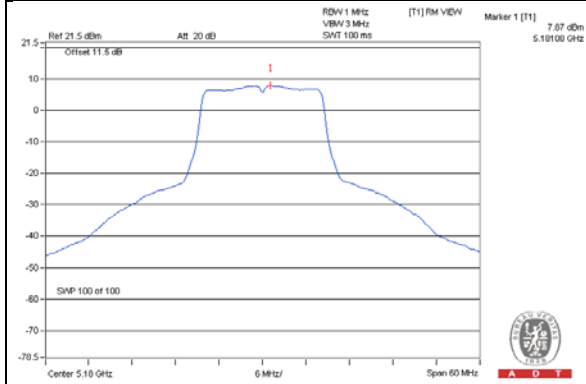
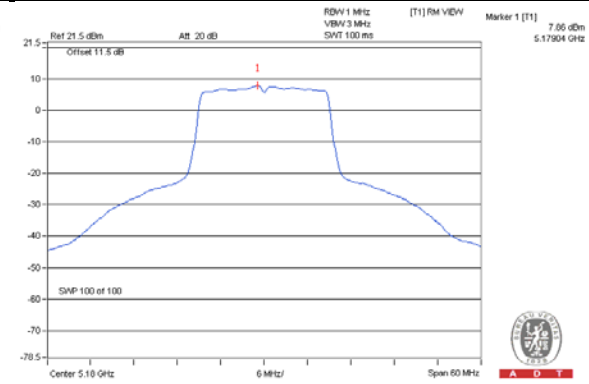
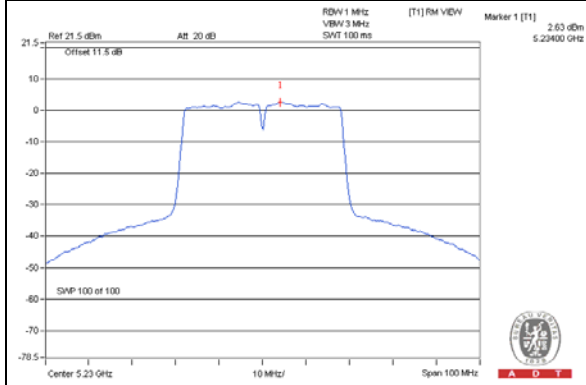
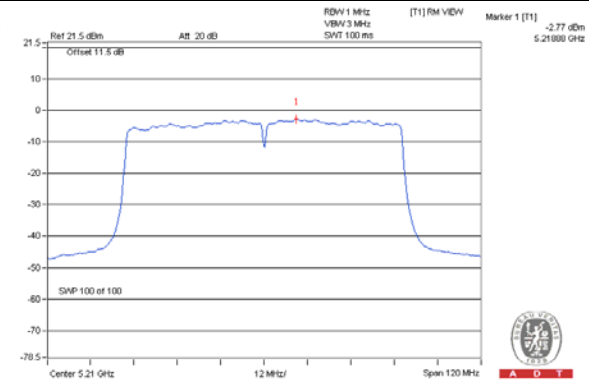
**SPECTRUM PLOT OF WORST VALUE****802.11a: Chain 1 / CH 36****802.11ac (VHT20): Chain 1 / CH 36****802.11ac (VHT40): Chain 1 / CH 46****802.11ac (VHT80): Chain 1 / CH 42**

## For U-NII-3 Band

### 802.11a

TX chain	Channel	Freq. (MHz)	PSD		10 log (N=3) dB	Total PSD (dBm/500kHz)	Limit (dBm/500kHz)	PASS /FAIL
			(dBm/300kHz)	(dBm/500kHz)				
0	149	5745	-1.12	1.10	4.77	5.87	26.88	PASS
	157	5785	2.54	4.76	4.77	9.53	26.88	PASS
	165	5825	1.93	4.15	4.77	8.92	26.88	PASS
1	149	5745	1.93	-0.22	4.77	4.55	26.88	PASS
	157	5785	-2.44	3.33	4.77	8.10	26.88	PASS
	165	5825	1.11	2.54	4.77	7.31	26.88	PASS
2	149	5745	0.32	-0.34	4.77	4.43	26.88	PASS
	157	5785	0.32	4.07	4.77	8.84	26.88	PASS
	165	5825	-2.56	3.39	4.77	8.16	26.88	PASS

**NOTE:** 1. Directional gain =  $10 \log[(10^{G1/20} + 10^{G2/20} + 10^{G3/20})^2 / 3] = 9.12\text{dBi} > 6\text{dBi}$ , so the power density limit shall be reduced to  $30 - (9.12 - 6) = 26.88\text{dBm}$ .

### 802.11ac (VHT20)

TX chain	Channel	Freq. (MHz)	PSD		10 log (N=3) dB	Total PSD (dBm/500kHz)	Limit (dBm/500kHz)	PASS /FAIL
			(dBm/300kHz)	(dBm/500kHz)				
0	149	5745	-2.84	-0.62	4.77	4.15	26.88	PASS
	157	5785	2.32	4.54	4.77	9.31	26.88	PASS
	165	5825	0.55	2.77	4.77	7.54	26.88	PASS
1	149	5745	-3.59	-1.37	4.77	3.40	26.88	PASS
	157	5785	1.53	3.75	4.77	8.52	26.88	PASS
	165	5825	-0.40	1.82	4.77	6.59	26.88	PASS
2	149	5745	-4.53	-2.31	4.77	2.46	26.88	PASS
	157	5785	1.66	3.88	4.77	8.65	26.88	PASS
	165	5825	-0.57	1.65	4.77	6.42	26.88	PASS

**NOTE:** 1. Directional gain =  $10 \log[(10^{G1/20} + 10^{G2/20} + 10^{G3/20})^2 / 3] = 9.12\text{dBi} > 6\text{dBi}$ , so the power density limit shall be reduced to  $30 - (9.12 - 6) = 26.88\text{dBm}$ .

802.11ac (VHT40)

TX CHAIN	CHANNEL	FREQUENCY (MHz)	PSD W/O DUTY FACTOR		10 log (N=3) dB	DUTY FACTOR (dB)	TOTAL PSD WITH DUTY FACTOR (dBm/500kHz)	LIMIT (dBm/500kHz)	PASS /FAIL
			(dBm/300kHz)	(dBm/500kHz)					
0	151	5755	-7.01	-4.79	4.77	0.18	0.16	26.88	PASS
	159	5795	-2.06	0.16	4.77	0.18	5.11	26.88	PASS
1	151	5755	-8.31	-6.09	4.77	0.18	-1.14	26.88	PASS
	159	5795	-3.05	-0.83	4.77	0.18	4.12	26.88	PASS
2	151	5755	-9.21	-6.99	4.77	0.18	-2.04	26.88	PASS
	159	5795	-2.93	-0.71	4.77	0.18	4.24	26.88	PASS

**NOTE:** 1. Directional gain =  $10 \log[(10^{G1/20} + 10^{G2/20} + 10^{G3/20})^2 / 3] = 9.12\text{dBi} > 6\text{dBi}$ , so the power density limit shall be reduced to  $30-(9.12-6) = 26.88\text{dBm}$ .  
 2. Refer to section 3.3 for duty cycle spectrum plot.

802.11ac (VHT80)

TX CHAIN	CHANNEL	FREQUENCY (MHz)	PSD W/O DUTY FACTOR		10 log (N=3) dB	DUTY FACTOR (dB)	TOTAL PSD WITH DUTY FACTOR (dBm/500kHz)	LIMIT (dBm/500kHz)	PASS /FAIL
			(dBm/300kHz)	(dBm/500kHz)					
0	155	5775	-12.58	-10.36	4.77	0.27	-5.32	26.88	PASS
1	155	5775	-13.61	-11.39	4.77	0.27	-6.35	26.88	PASS
2	155	5775	-14.35	-12.13	4.77	0.27	-7.09	26.88	PASS

**NOTE:** 1. Directional gain =  $10 \log[(10^{G1/20} + 10^{G2/20} + 10^{G3/20})^2 / 3] = 9.12\text{dBi} > 6\text{dBi}$ , so the power density limit shall be reduced to  $30-(9.12-6) = 26.88\text{dBm}$ .  
 2. Refer to section 3.3 for duty cycle spectrum plot.

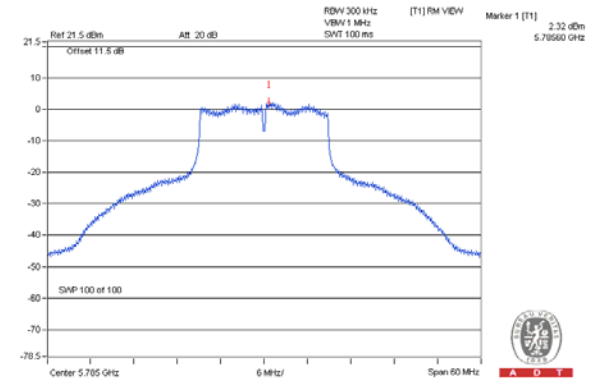
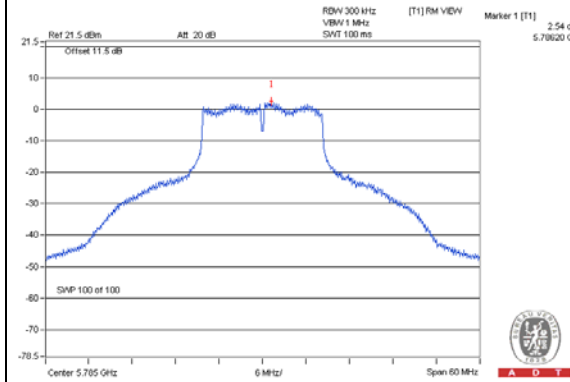
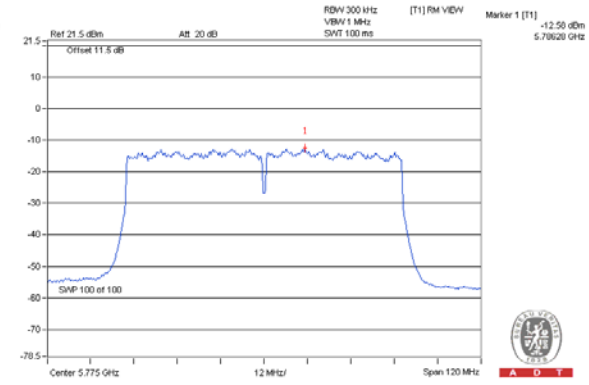
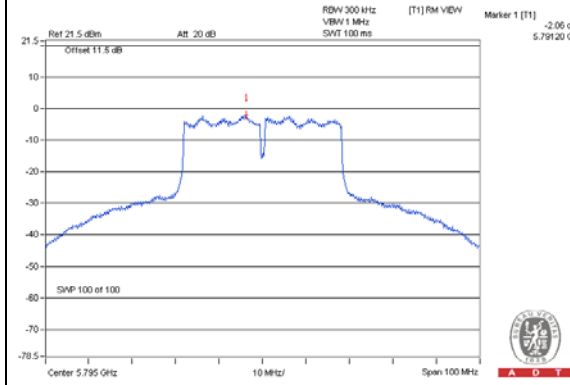
**SPECTRUM PLOT OF WORST VALUE****802.11a: Chain 0 / CH 157****802.11ac (VHT20): Chain 0 / CH 157****802.11ac (VHT40): Chain 0 / CH 159****802.11ac (VHT80): Chain 0 / CH 155**

## Beamforming MODE For U-NII-1 Band

### 802.11ac (VHT20)

CHAN.	CHAN. FREQ. (MHz)	PSD (dBm)			TOTAL POWER DENSITY (dBm)	MAX. LIMIT (dBm)	PASS / FAIL
		CHAIN 0	CHAIN 1	CHAIN 2			
36	5180	4.93	5.00	4.51	9.59	13.88	PASS
40	5200	1.05	1.35	0.49	5.75	13.88	PASS
48	5240	1.23	1.54	0.41	5.86	13.88	PASS

- NOTE:** 1. Method 1 of power density measurement of KDB 662911 is using for calculating total power density. Total power density is summing entire spectra across corresponding frequency bins on the various outputs by computer.
2. Directional gain =  $10 \log[(10^{G1/20} + 10^{G2/20} + 10^{G3/20})^2 / 3] = 9.12\text{dBi} > 6\text{dBi}$ , so the power density limit shall be reduced to  $17-(9.12-6) = 13.88\text{dBm}$ .

### 802.11ac (VHT40)

CHAN.	CHAN. FREQ. (MHz)	PSD (dBm)			DUTY FACTOR	TOTAL PSD WITH DUTY FACTOR (dBm)	MAX. LIMIT (dBm)	PASS / FAIL
		CHAIN 0	CHAIN 1	CHAIN 2				
38	5190	-2.91	-2.50	-3.58	0.18	1.98	13.88	PASS
46	5230	2.20	2.41	2.09	0.18	7.19	13.88	PASS

- NOTE:** 1. Method 1 of power density measurement of KDB 662911 is using for calculating total power density. Total power density is summing entire spectra across corresponding frequency bins on the various outputs by computer.
2. Directional gain =  $10 \log[(10^{G1/20} + 10^{G2/20} + 10^{G3/20})^2 / 3] = 9.12\text{dBi} > 6\text{dBi}$ , so the power density limit shall be reduced to  $17-(9.12-6) = 13.88\text{dBm}$ .
3. Refer to section 3.3 for duty cycle spectrum plot.

### 802.11ac (VHT80)

CHAN.	CHAN. FREQ. (MHz)	PSD (dBm)			DUTY FACTOR	TOTAL PSD WITH DUTY FACTOR (dBm)	MAX. LIMIT (dBm)	PASS / FAIL
		CHAIN 0	CHAIN 1	CHAIN 2				
42	5210	-5.47	-4.93	-5.95	0.27	-0.39	13.88	PASS

- NOTE:** 1. Method 1 of power density measurement of KDB 662911 is using for calculating total power density. Total power density is summing entire spectra across corresponding frequency bins on the various outputs by computer.
2. Directional gain =  $10 \log[(10^{G1/20} + 10^{G2/20} + 10^{G3/20})^2 / 3] = 9.12\text{dBi} > 6\text{dBi}$ , so the power density limit shall be reduced to  $17-(9.12-6) = 13.88\text{dBm}$ .
3. Refer to section 3.3 for duty cycle spectrum plot.

### SPECTRUM PLOT OF WORST VALUE

**802.11ac (VHT20): Chain 1 / CH 36**

**802.11ac (VHT40): Chain 1 / CH 46**

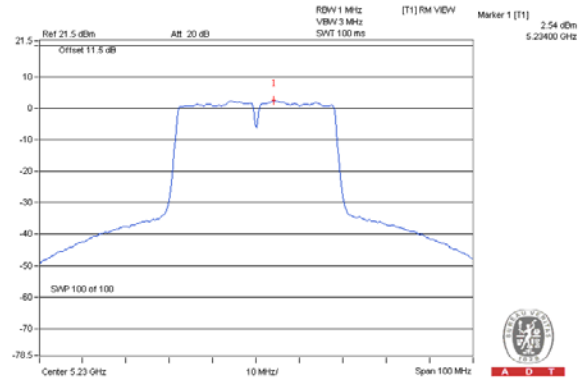
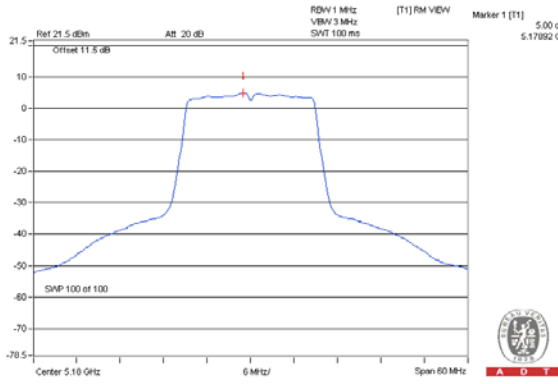

**802.11ac (VHT80): Chain 1 / CH 42**

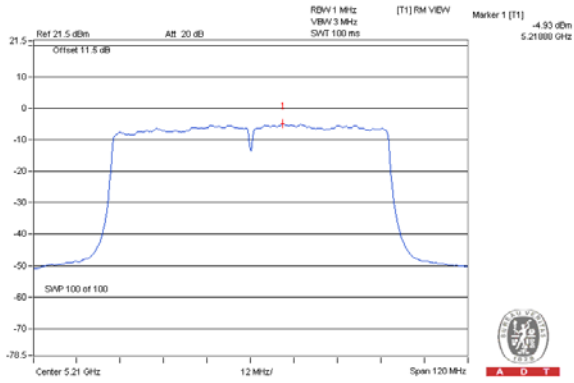

## For U-NII-3 Band

### 802.11ac (VHT20)

TX chain	Channel	Freq. (MHz)	PSD		10 log (N=3) dB	Total PSD (dBm/500kHz)	Limit (dBm/500kHz)	PASS /FAIL
			(dBm/300kHz)	(dBm/500kHz)				
0	149	5745	-5.72	-3.50	4.77	1.27	26.88	PASS
	157	5785	-1.25	0.97	4.77	5.74	26.88	PASS
	165	5825	-3.18	-0.96	4.77	3.81	26.88	PASS
1	149	5745	-6.33	-4.11	4.77	0.66	26.88	PASS
	157	5785	-2.03	0.19	4.77	4.96	26.88	PASS
	165	5825	-3.89	-1.67	4.77	3.10	26.88	PASS
2	149	5745	-7.24	-5.02	4.77	-0.25	26.88	PASS
	157	5785	-2.57	-0.35	4.77	4.42	26.88	PASS
	165	5825	-4.50	-2.28	4.77	2.49	26.88	PASS

**NOTE:** 1. Directional gain =  $10 \log[(10^{G1/20} + 10^{G2/20} + 10^{G3/20})^2 / 3] = 9.12\text{dBi} > 6\text{dBi}$ , so the power density limit shall be reduced to  $30 - (9.12 - 6) = 26.88\text{dBm}$ .

### 802.11ac (VHT40)

TX CHAIN	CHANNEL	FREQUENCY (MHz)	PSD W/O DUTY FACTOR		10 log (N=3) dB	DUTY FACTOR (dB)	TOTAL PSD WITH DUTY FACTOR (dBm/500kHz)	LIMIT (dBm/500kHz)	PASS /FAIL
			(dBm/300kHz)	(dBm/500kHz)					
0	151	5755	-10.36	-8.14	4.77	0.18	-3.19	26.88	PASS
	159	5795	-4.00	-1.78	4.77	0.18	3.17	26.88	PASS
1	151	5755	-12.44	-10.22	4.77	0.18	-5.27	26.88	PASS
	159	5795	-3.72	-1.50	4.77	0.18	3.45	26.88	PASS
2	151	5755	-12.56	-10.34	4.77	0.18	-5.39	26.88	PASS
	159	5795	-4.31	-2.09	4.77	0.18	2.86	26.88	PASS

**NOTE:** 1. Directional gain =  $10 \log[(10^{G1/20} + 10^{G2/20} + 10^{G3/20})^2 / 3] = 9.12\text{dBi} > 6\text{dBi}$ , so the power density limit shall be reduced to  $30 - (9.12 - 6) = 26.88\text{dBm}$ .

2. Refer to section 3.3 for duty cycle spectrum plot.



**802.11ac (VHT80)**

TX CHAIN	CHANNEL	FREQUENCY (MHz)	PSD W/O DUTY FACTOR		10 log (N=3) dB	DUTY FACTOR (dB)	TOTAL PSD WITH DUTY FACTOR (dBm/500kHz)	LIMIT (dBm/500kHz)	PASS /FAIL
			(dBm/300kHz)	(dBm/500kHz)					
0	155	5775	-14.76	-12.54	4.77	0.27	-7.50	26.88	PASS
1	155	5775	-16.60	-14.38	4.77	0.27	-9.34	26.88	PASS
2	155	5775	-17.28	-15.06	4.77	0.27	-10.02	26.88	PASS

**NOTE:** 1. Directional gain =  $10 \log[(10^{G1/20} + 10^{G2/20} + 10^{G3/20})^2 / 3] = 9.12\text{dBi} > 6\text{dBi}$ , so the power density limit shall be reduced to  $30 - (9.12 - 6) = 26.88\text{dBm}$ .  
 2. Refer to section 3.3 for duty cycle spectrum plot.

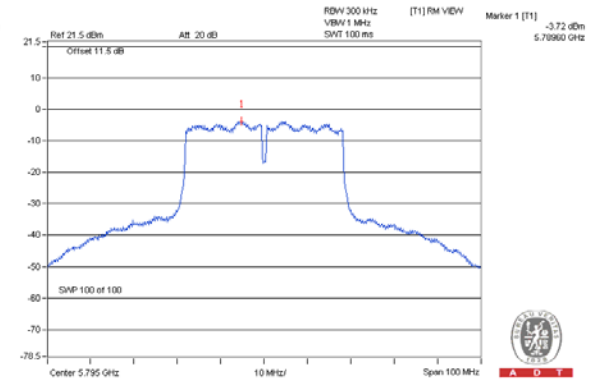
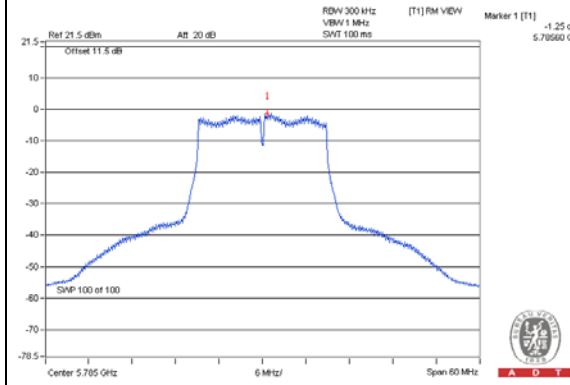
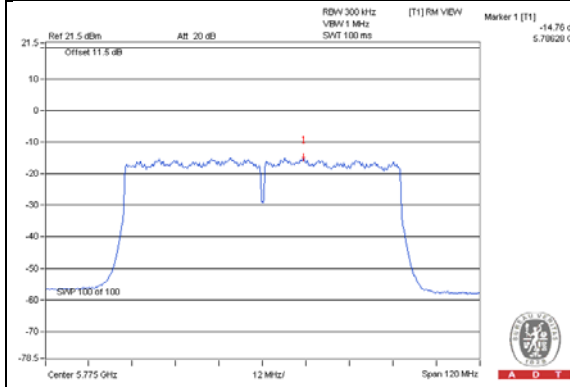
**SPECTRUM PLOT OF WORST VALUE****802.11ac (VHT20): Chain 0 / CH 157****802.11ac (VHT40): Chain 1 / CH 159****802.11ac (VHT80): Chain 0 / CH 155**

## 4.5 Frequency Stability Measurement

### 4.5.1 Limits of Frequency Stability Measurement

The frequency of the carrier signal shall be maintained within band of operation

### 4.5.2 Test Setup

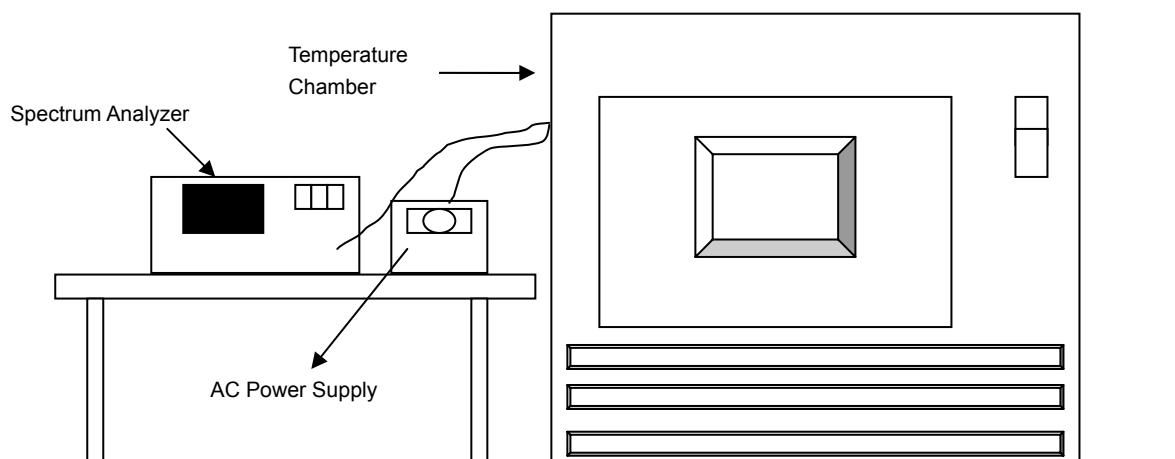

### 4.5.3 Test Instruments

DESCRIPTION & MANUFACTURER	MODEL NO.	SERIAL NO.	CALIBRATED DATE	CALIBRATED UNTIL
SPECTRUM ANALYZER R&S	FSP 40	100060	May 08, 2014	May 07, 2015
Temperature Humidity Chamber GIANTFORCE	& GTH-150-40-SP -AR	MAA0812-008	Jan. 12, 2015	Jan. 11, 2016

**Note:**

1. The calibration interval of the above test instruments is 12 months and the calibrations are traceable to NML/ROC and NIST/USA.
2. Tested date : Mar. 12, 2015

### 4.5.4 Test Procedure

- a. The EUT was placed inside the environmental test chamber and powered by nominal AC voltage.
- b. Turn the EUT on and couple its output to a spectrum analyzer.
- c. Turn the EUT off and set the chamber to the highest temperature specified.
- d. Allow sufficient time (approximately 30 min) for the temperature of the chamber to stabilize, turn the EUT on and measure the operating frequency after 2, 5, and 10 minutes.
- e. Repeat step 2 and 3 with the temperature chamber set to the lowest temperature.
- f. The test chamber was allowed to stabilize at +20 degree C for a minimum of 30 minutes. The supply voltage was then adjusted on the EUT from 85% to 115% and the frequency record.

### 4.5.5 Deviation from Test Standard

No deviation.

#### 4.5.6 EUT Operating Condition

Set the EUT transmit at un-modulation mode to test frequency stability.



**4.5.7 Test Results**

<b>FREQUENCY STABILITY VERSUS TEMP.</b>									
<b>OPERATING FREQUENCY: 5240MHz</b>									
<b>TEMP. (°C)</b>	<b>POWER SUPPLY (Vac)</b>	<b>0 MINUTE</b>		<b>2 MINUTE</b>		<b>5 MINUTE</b>		<b>10 MINUTE</b>	
		<b>Measured Frequency (MHz)</b>	<b>Frequency Drift (%)</b>	<b>Measured Frequency (MHz)</b>	<b>Frequency Drift (%)</b>	<b>Measured Frequency (MHz)</b>	<b>Frequency Drift (%)</b>	<b>Measured Frequency (MHz)</b>	<b>Frequency Drift (%)</b>
50	120	5239.9852	-0.00028	5239.9818	-0.00035	5239.9854	-0.00028	5239.9827	-0.00033
40	120	5239.9814	-0.00035	5239.9845	-0.00030	5239.984	-0.00031	5239.9798	-0.00039
30	120	5240.0217	0.00041	5240.0225	0.00043	5240.0209	0.00040	5240.0192	0.00037
20	120	5240.0038	0.00007	5240.0011	0.00002	5240.0029	0.00006	5240.0026	0.00005
10	120	5240.01	0.00019	5240.0117	0.00022	5240.0081	0.00015	5240.013	0.00025
0	120	5239.9966	-0.00006	5239.996	-0.00008	5239.9981	-0.00004	5240.0008	0.00002
-10	120	5239.9933	-0.00013	5239.9946	-0.00010	5239.9936	-0.00012	5239.9938	-0.00012
-20	120	5240.0084	0.00016	5240.0096	0.00018	5240.0086	0.00016	5240.006	0.00011
-30	120	5240.0048	0.00009	5240.0069	0.00013	5240.007	0.00013	5240.0066	0.00013

<b>FREQUENCY STABILITY VERSUS TEMP.</b>									
<b>OPERATING FREQUENCY: 5240MHz</b>									
<b>TEMP. (°C)</b>	<b>POWER SUPPLY (Vac)</b>	<b>0 MINUTE</b>		<b>2 MINUTE</b>		<b>5 MINUTE</b>		<b>10 MINUTE</b>	
		<b>Measured Frequency (MHz)</b>	<b>Frequency Drift (%)</b>	<b>Measured Frequency (MHz)</b>	<b>Frequency Drift (%)</b>	<b>Measured Frequency (MHz)</b>	<b>Frequency Drift (%)</b>	<b>Measured Frequency (MHz)</b>	<b>Frequency Drift (%)</b>
20	138	5240.0042	0.00008	5240.0001	0.00000	5240.0024	0.00005	5240.0036	0.00007
	120	5240.0038	0.00007	5240.0011	0.00002	5240.0029	0.00006	5240.0026	0.00005
	102	5240.0045	0.00009	5240.001	0.00002	5240.0034	0.00006	5240.0033	0.00006

#### 4.6 6dB Bandwidth Measurement

##### 4.6.1 Limits of 6dB Bandwidth Measurement

The minimum of 6dB Bandwidth Measurement is 0.5MHz.

##### 4.6.2 Test Setup

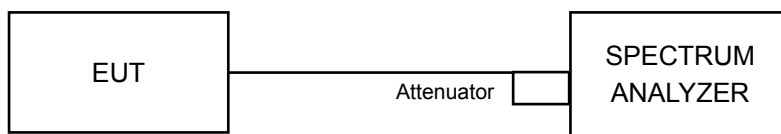

##### 4.6.3 Test Instruments

DESCRIPTION & MANUFACTURER	MODEL NO.	SERIAL NO.	CALIBRATED DATE	CALIBRATED UNTIL
SPECTRUM ANALYZER R&S	FSP 40	100060	May 08, 2014	May 07, 2015

**Note:**

1. The calibration interval of the above test instruments is 12 months and the calibrations are traceable to NML/ROC and NIST/USA.
2. Tested date : Mar. 12, 2015

##### 4.6.4 Test Procedure

#### MEASUREMENT PROCEDURE REF

- a. Set resolution bandwidth (RBW) = 100kHz
- b. Set the video bandwidth (VBW)  $\geq 3 \times$  RBW, Detector = Peak.
- c. Trace mode = max hold.
- d. Sweep = auto couple.
- e. Measure the maximum width of the emission that is constrained by the frequencies associated with the two amplitude points (upper and lower) that are attenuated by 6 dB relative to the maximum level measured in the fundamental emission

##### 4.6.5 Deviation from Test Standard

No deviation.

##### 4.6.6 EUT Operating Condition

The software provided by client to enable the EUT under transmission condition continuously at lowest, middle and highest channel frequencies individually.

#### 4.6.7 Test Results

#### CDD MODE

##### 802.11a

CHANNEL	FREQUENCY (MHz)	6dB BANDWIDTH (MHz)			MINIMUM LIMIT (MHz)	PASS / FAIL
		CHAIN 0	CHAIN 1	CHAIN 2		
149	5745	15.81	16.40	16.42	0.5	PASS
157	5785	15.80	16.39	16.41	0.5	PASS
165	5825	16.14	16.40	16.41	0.5	PASS

##### 802.11ac (VHT20)

CHANNEL	FREQUENCY (MHz)	6dB BANDWIDTH (MHz)			MINIMUM LIMIT (MHz)	PASS / FAIL
		CHAIN 0	CHAIN 1	CHAIN 2		
149	5745	17.23	17.66	17.65	0.5	PASS
157	5785	16.91	17.63	17.63	0.5	PASS
165	5825	16.96	17.65	17.63	0.5	PASS

##### 802.11ac (VHT40)

CHANNEL	FREQUENCY (MHz)	6dB BANDWIDTH (MHz)			MINIMUM LIMIT (MHz)	PASS / FAIL
		CHAIN 0	CHAIN 1	CHAIN 2		
151	5755	36.14	36.45	36.48	0.5	PASS
159	5795	36.12	36.45	36.42	0.5	PASS

##### 802.11ac (VHT80)

CHANNEL	FREQUENCY (MHz)	6dB BANDWIDTH (MHz)			MINIMUM LIMIT (MHz)	PASS / FAIL
		CHAIN 0	CHAIN 1	CHAIN 2		
155	5775	75.61	75.97	75.90	0.5	PASS

**SPECTRUM PLOT OF WORST VALUE**

**802.11a: Chain 0 / CH 157**

**802.11ac (VHT20): Chain 0 / CH 157**

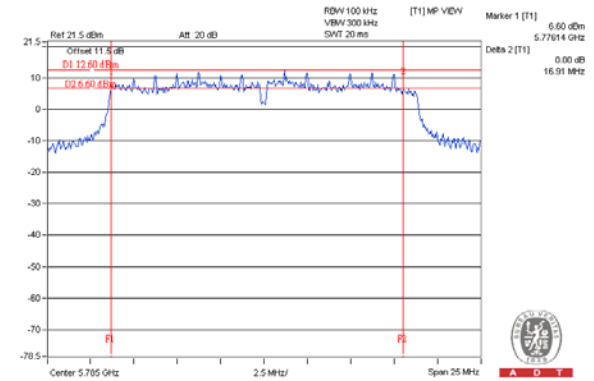
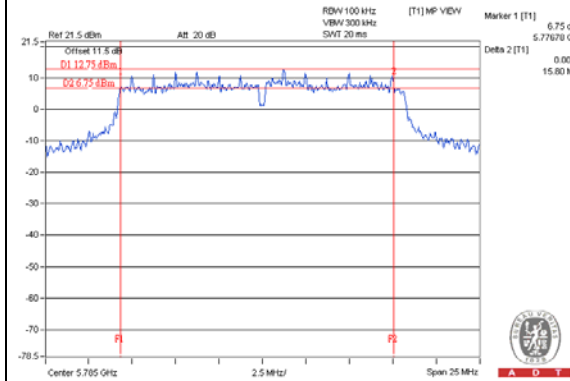

**802.11ac (VHT40): Chain 0 / CH 159**

**802.11ac (VHT80): Chain 0 / CH 155**

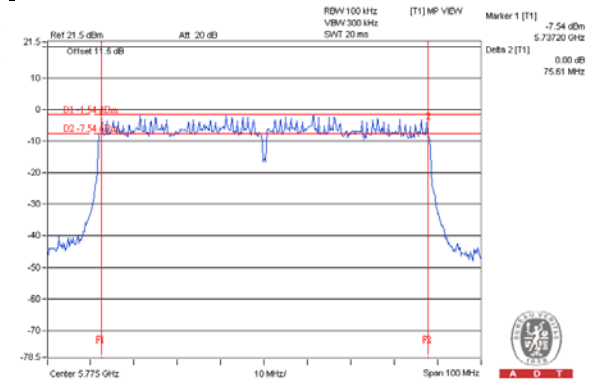
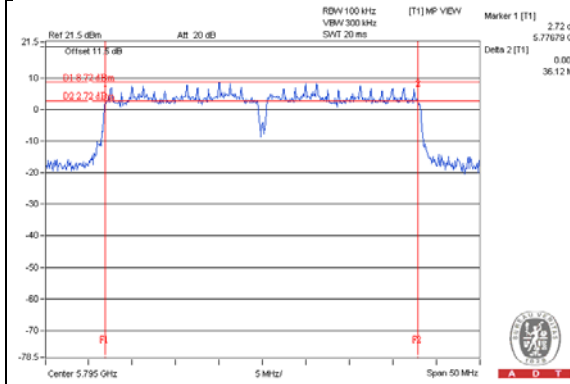



**Beamforming MODE**
**802.11ac (VHT20)**

CHANNEL	FREQUENCY (MHz)	6dB BANDWIDTH (MHz)			MINIMUM LIMIT (MHz)	PASS / FAIL
		CHAIN 0	CHAIN 1	CHAIN 2		
149	5745	17.36	17.67	17.67	0.5	PASS
157	5785	17.23	17.65	17.65	0.5	PASS
165	5825	17.64	17.64	17.66	0.5	PASS

**802.11ac (VHT40)**

CHANNEL	FREQUENCY (MHz)	6dB BANDWIDTH (MHz)			MINIMUM LIMIT (MHz)	PASS / FAIL
		CHAIN 0	CHAIN 1	CHAIN 2		
151	5755	36.15	36.44	36.45	0.5	PASS
159	5795	36.13	36.46	36.33	0.5	PASS

**802.11ac (VHT80)**

CHANNEL	FREQUENCY (MHz)	6dB BANDWIDTH (MHz)			MINIMUM LIMIT (MHz)	PASS / FAIL
		CHAIN 0	CHAIN 1	CHAIN 2		
155	5775	75.56	75.76	76.02	0.5	PASS

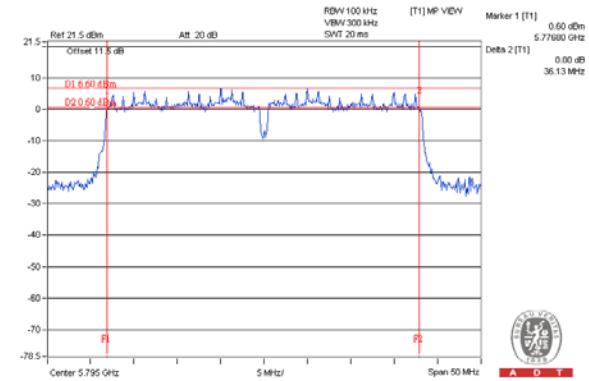
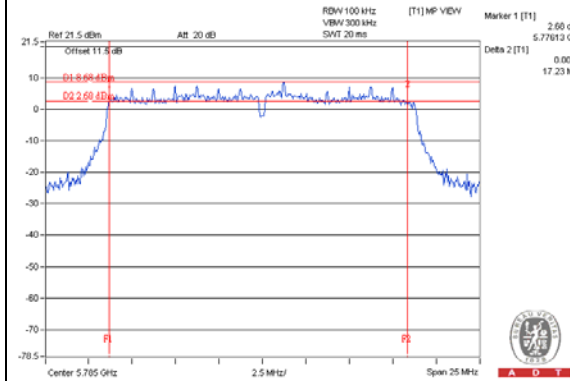
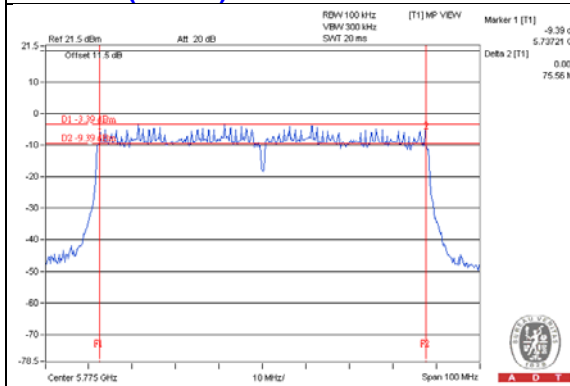
**SPECTRUM PLOT OF WORST VALUE****802.11ac (VHT20): Chain 0 / CH 157****802.11ac (VHT40): Chain 0 / CH 159****802.11ac (VHT80): Chain 0 / CH 155**

## 5 Pictures of Test Arrangements

Please refer to the attached file (Test Setup Photo).

## Appendix – Information on the Testing Laboratories

We, Bureau Veritas Consumer Products Services (H.K.) Ltd., Taoyuan Branch, were founded in 1988 to provide our best service in EMC, Radio, Telecom and Safety consultation. Our laboratories are accredited and approved according to ISO/IEC 17025.

If you have any comments, please feel free to contact us at the following:

### **Linko EMC/RF Lab**

Tel: 886-2-26052180

Fax: 886-2-26051924

### **Hsin Chu EMC/RF Lab/Telecom Lab**

Tel: 886-3-5935343

Fax: 886-3-5935342

### **Hwa Ya EMC/RF/Safety**

Tel: 886-3-3183232

Fax: 886-3-3270892

**Email:** [service.adt@tw.bureauveritas.com](mailto:service.adt@tw.bureauveritas.com)

**Web Site:** [www.bureauveritas-adt.com](http://www.bureauveritas-adt.com)

The address and road map of all our labs can be found in our web site also.

--- END ---