



SWEET PEEK MINI VIDEO BABY MONITOR

USER'S GUIDE

Version 1.0

ENGLISH

FRANÇAIS

ESPAÑOL



www.lorexbaby.com



Safety Precautions

- Adult assembly is required. Keep small parts away from children when assembling.
- This product is not a toy. Do not allow children or infants to play with it.
- This video monitor is not a substitute for responsible adult supervision.
- Test the video monitor before use. Become familiar with its functions.
- Keep the cords out of reach from children and infants.
- Never use extension cords with power adapters.
- Only use the chargers and power adapters provided. Do not use other chargers or power adapters as this may damage the device and battery pack.
- Only insert batteries/battery pack of the same type.
- Insert batteries with the correct polarity.
- Do not mix new and used batteries.
- Do not mix alkaline, standard, and rechargeable batteries.
- Remove exhausted batteries from the product.
- Keep all batteries away from children and infants.
- Dispose or recycle batteries in accordance with local laws, which may vary by location.
- Do not cover the video monitor with a towel or blanket.
- Do not use the video monitor near water.
- Do not install the video monitor near a heat source.
- Do not touch the plug contacts with sharp or metal objects.
- Keep this user's guide for future reference.



To Avoid Injury to Children & Infants:

- **MAKE SURE** to keep the camera and all power cords are least 3ft / 1m away from cribs and out of reach of your child.
- Use the included cable clips to help keep power cords away from your child.

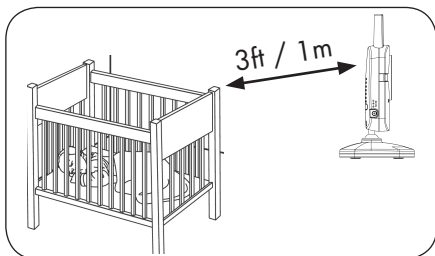
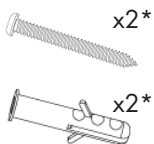

Table of Contents:

Product Includes.....	2
Monitor Overview.....	2
Camera Overview.....	3
Getting Started	4
Optional - Wall Mounting the Camera	7
Using Your Baby Monitor	8
Using the Menu.....	8
Talking to Your Baby.....	9
Adjusting Volume	9
Adjusting Screen Brightness.....	9
Turning on the Night-Light.....	10
Changing Channels.....	10
Enabling VOX Mode (Voice Trigger)	12
Video Off Mode (Audio Only Mode)	13
Pairing Additional Cameras	14
Disabling Channels	16
Technical Specifications	17
Camera	17
Monitor.....	17
Troubleshooting	18
Need Help?.....	18

Product Includes



Screws & Anchors

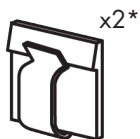

Cable Clips

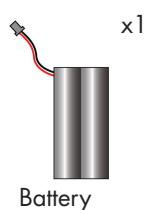

*Contents may vary by model

Monitor Overview

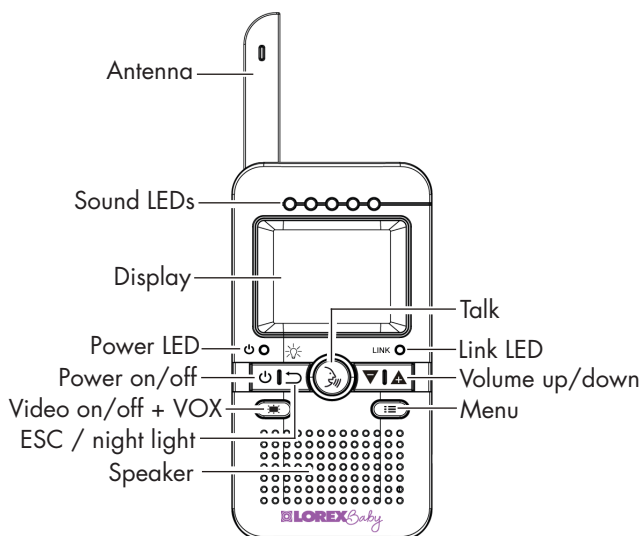

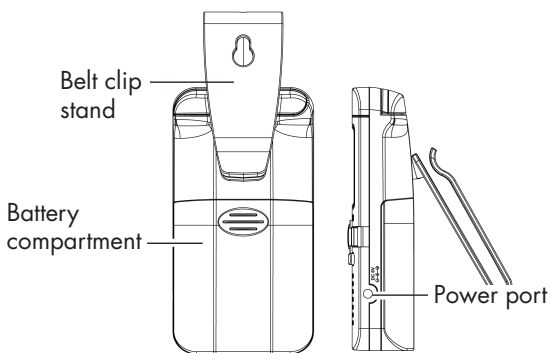

Camera Overview

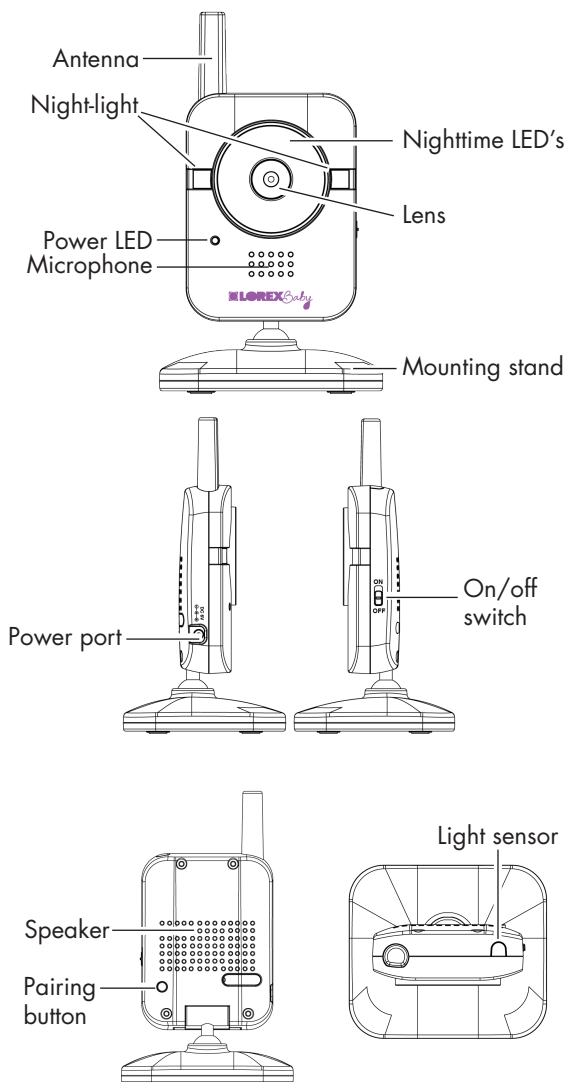

Getting Started

- 1 Connect the power adapter to the camera.

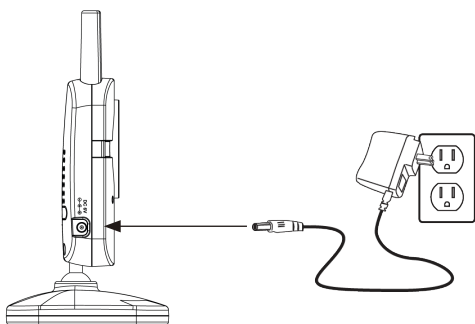

Make sure all power cables are at least 3ft / 1m away from the crib and out of reach of your child.

Use the included cable clips to help keep power cords away from your child.

- 2 Slide the power switch to **ON**.

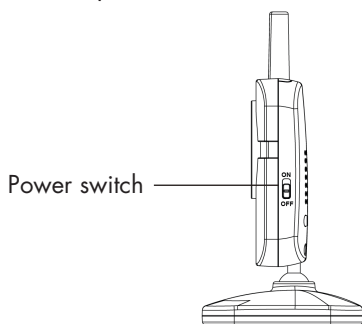

- 3 Press down on the battery compartment door and slide it off the monitor.

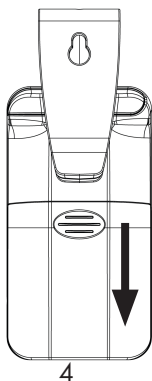

- 4 Connect the battery cable to the monitor.

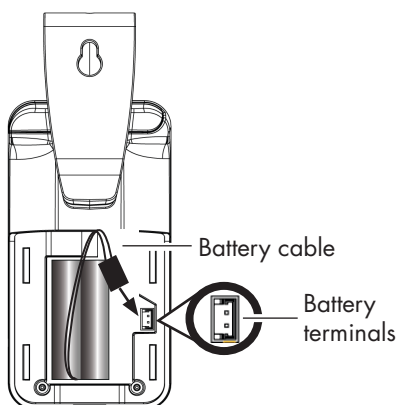

The battery cable only connects one way. Do not force the battery cable.

- 5 Replace the battery compartment door.

- 6 Connect the power adapter to the monitor.

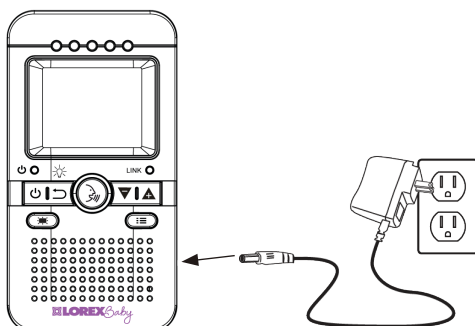

- 7 Press and hold the power button to turn on the monitor.

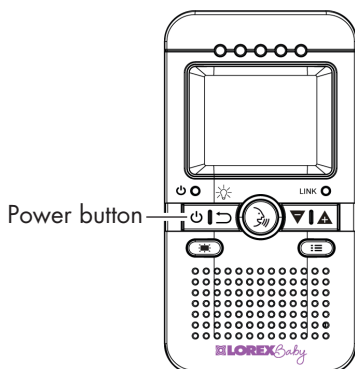

Tips

- It is recommended to charge the battery for 3 hours before use.
- For overnight monitoring, it is recommended to connect the power adapter. When fully charged, the monitor will stay on up to 5 hours in normal mode or X+ hours on Video OFF mode (see page 13).
- For better reception, flip up the antenna on the monitor.

Pull up to extend
antenna

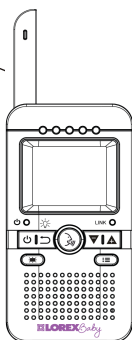

Optional - Wall Mounting the Camera

Before permanently mounting the camera:

- Determine where you will get the best view of your baby.
- Ensure the power cable is long enough to power the camera.



Make sure all power cables are at least 3ft / 1m away from the crib and out of reach of your child.

Use the included cable clips to help keep power cords away from your child.

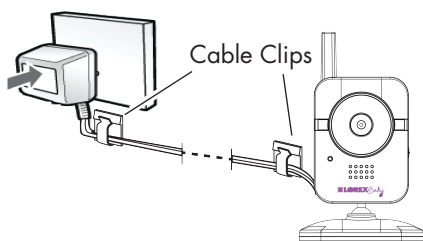

1

Drill 2 holes in the wall with centers exactly 48mm apart.

2

Tap anchors into holes with a hammer. Insert screws 2/3 of the way.

3

Align the mounting points with the screws and push the camera down.

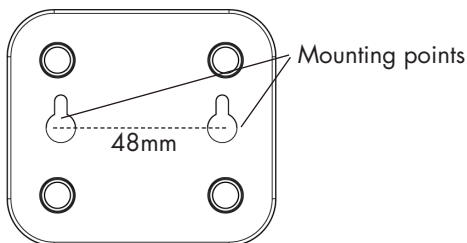
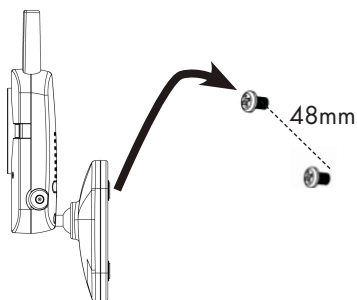

Using Your Baby Monitor

The monitor shows the following icons during use:

Icon	Meaning
	Signal strength
	Selected channel
	Battery full*
	Battery low
	Camera out of range or off

Icon	Meaning
	Talk activated
	Sequence mode activated
	Night-light activated
	Night vision activated
	VOX mode activated

*When battery is charging, icon will fill up.

Using the Menu

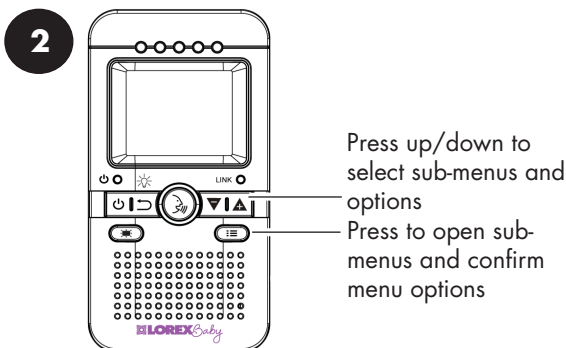
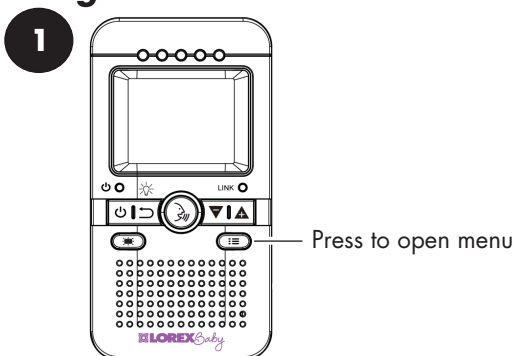

Talking to Your Baby

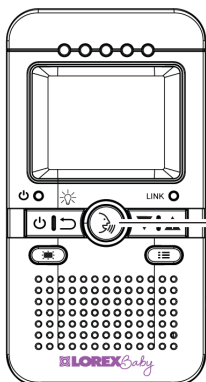

Press and hold to talk to the selected camera

Adjusting Volume

Press to adjust the volume

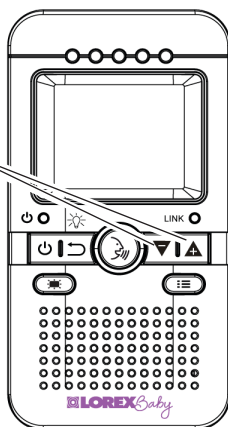

Adjusting Screen Brightness

1

Press to open menu. Then, press again to select Brightness sub-menu

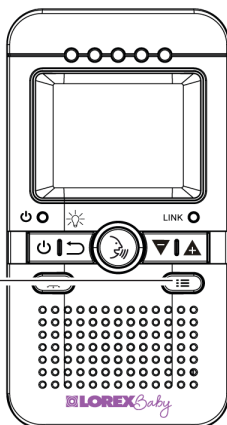

2

Press to adjust brightness

Press to confirm brightness

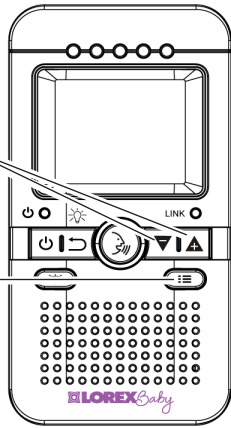



3

Press  to exit menu.

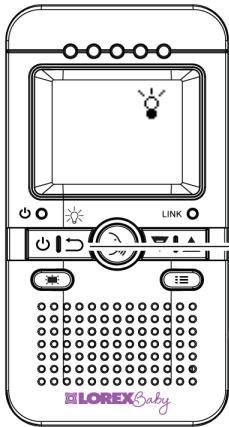
Turning on the Night-Light



Press and hold until  appears on the screen to turn on the night-light for the currently selected camera

Press and hold until  goes away to turn off the night light

Changing Channels

1

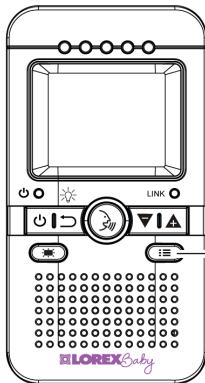

Press to open the menu

2

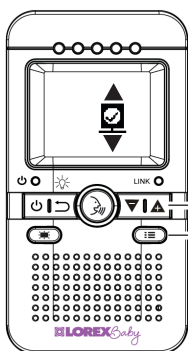

Press up/down to select 
Press to confirm

3

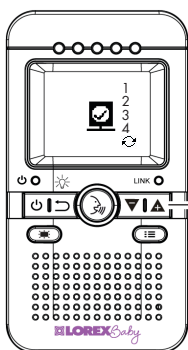

Press up/down to select
the channel you would like
to view

OR

Select  to select
Sequence mode. During
Sequence mode the
monitor will automatically
switch channels every 6
seconds

4

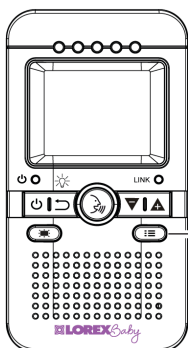

Press to confirm channel

To connect additional cameras to the monitor, see "Pairing Additional Cameras" on page 14.

Enabling VOX Mode (Voice Trigger)

In VOX mode, the monitor's screen and speaker will turn off after a minute unless sound is detected at the selected sensitivity level. This conserves battery power, and alerts you only when needed.

To activate VOX mode:

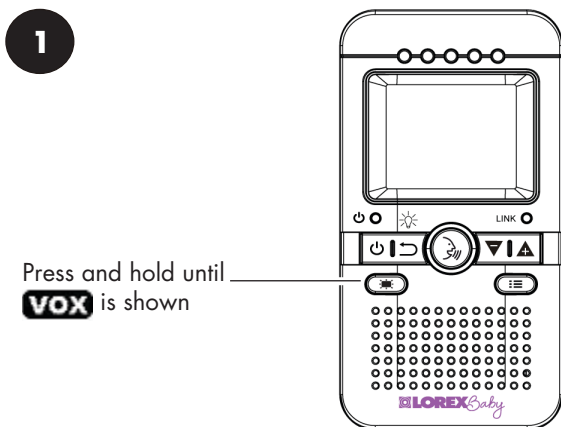

While VOX is activated, the monitor's screen and speaker will turn off **after a minute** unless sound is detected above the preset sensitivity level. Press any button to turn the screen back on. When VOX is on, a **VOX** icon is shown on the screen.

VOX mode will not work while Sequence mode is activated.

To deactivate VOX mode:



Video Off Mode (Audio Only Mode)

1

Press to turn the screen off and monitor sound only.

The monitor will play sound from the selected channel only.

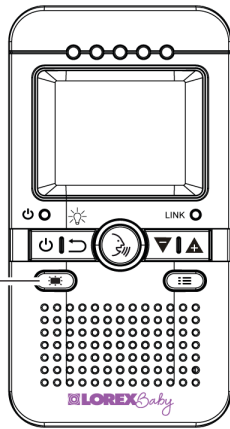

Notes

- If Sequence mode is enabled, the monitor will play sound from the channel that is currently selected.
- VOX mode will override Video Off mode. See "Enabling VOX Mode (Voice Trigger)" on page 12 for details.

2

Press any button to turn the screen back on.

Pairing Additional Cameras

The camera(s) included have already been paired with the monitor. If you have purchased additional add-on cameras (model# BB1811AC1), **OR** if your monitor and camera are not paired up, follow the steps below.

To pair a camera to your monitor:

1 Place the camera and monitor next to each other. Make sure the camera and monitor are turned on.

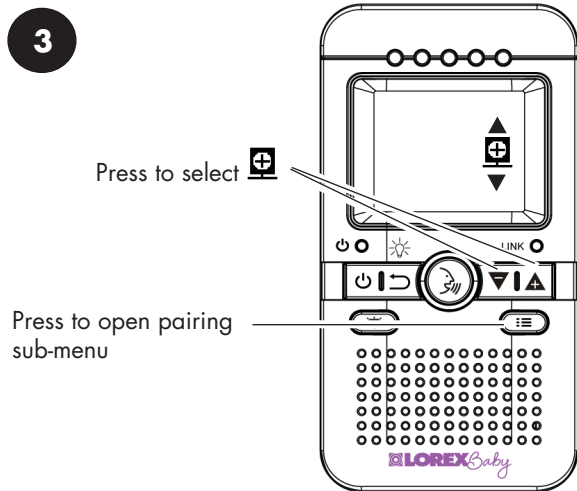
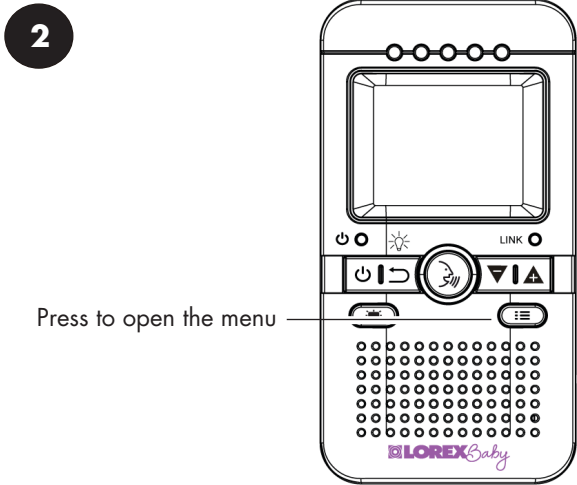

4

Press to select the channel you would like to pair the camera to

Press to begin pairing.

The LINK LED will start flashing

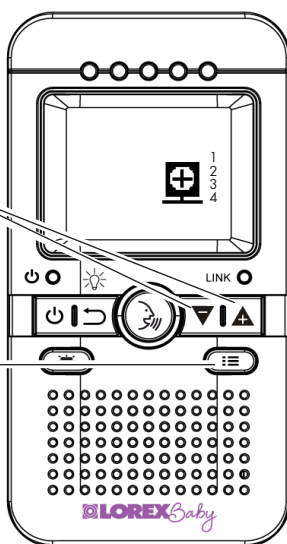

If a camera is already connected to this channel, the new camera will replace the existing camera.

5

Press the PAIR button on the back of the camera.

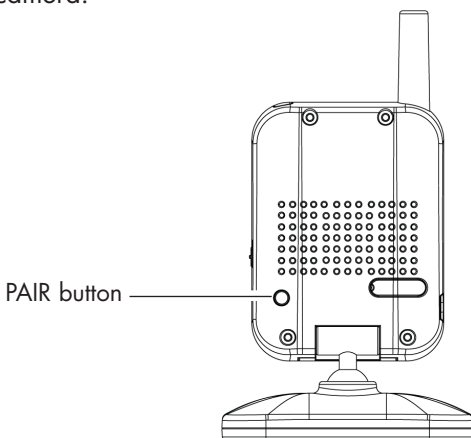

Images from the camera are immediately shown on the monitor once the camera is successfully paired.

5

Press  twice to exit menu.

Notes

- Immediately move the camera away from the monitor to avoid speaker feedback.
- The monitor can connect up to 4 cameras.

Disabling Channels

You can disable empty channels so they do not appear on the monitor when changing channels manually or using Sequence Mode. You only need to do this if you have moved a camera to a different channel using the pairing function.

To disable channels:

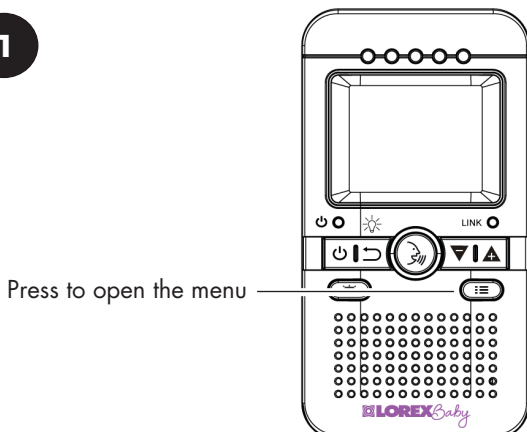

1

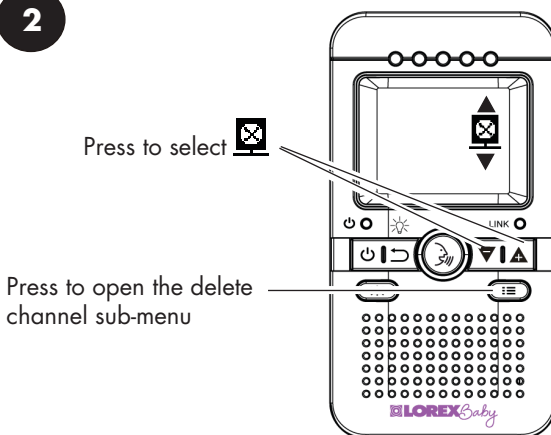

2



3

Press   to select the channel you would like to delete and press  to confirm.

If a camera is paired to a channel, a * will appear next to the channel number.

4

Press  twice to exit menu.

Technical Specifications

ENGLISH

Camera

Frequency	2.4GHz
Maximum Range	Up to 450ft / 138m outdoors* Up to 150ft / 46m indoors*
Image Sensor	1/5" Color CMOS
Lens	3.0mm F2.5
IR LED	6 pcs
Power Adapter	6.0V DC 800mA
Weight	0.3lbs / 0.1kg



Monitor

Frequency	2.4GHz
Display	1.8" TFT Color LCD
Power Adapter	6.0V DC 800mA
Battery	Li-ion Rechargeable Battery 3.6V DC 750mAh
Battery Life	Up to 5 hours in normal mode Up to X+ hours in Video Off
Weight	0.4lbs / 0.2kg

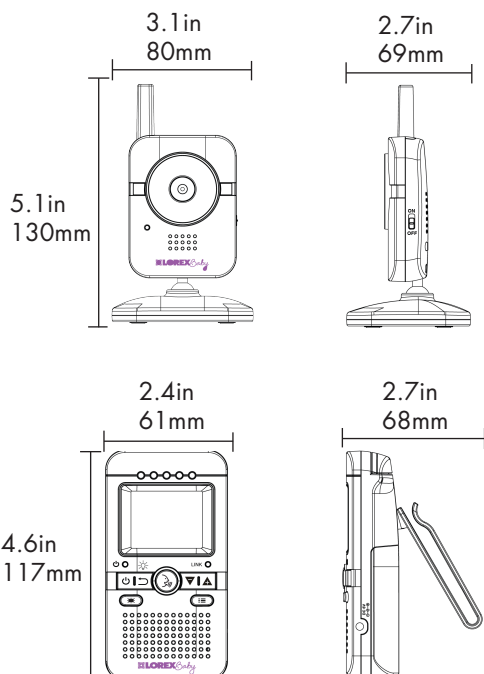
*Based on unobstructed line of sight. Actual range will vary based on surroundings.



Troubleshooting

Problem	Solution
No video displayed on the monitor	<ul style="list-style-type: none">• Press and hold the  button to power on the monitor.• Monitor is out of batteries. Plug in the monitor power adapter.• Video Off or VOX mode is on. Press any button to turn the screen back on.
Monitor screen keeps turning off	<ul style="list-style-type: none">• VOX mode is on. See "Enabling VOX Mode (Voice Trigger)" on page 12 for details on disabling VOX mode.• The monitor battery is low. Plug in the monitor power adapter
The camera is not detected; "Out of Range" is shown on the monitor	<ul style="list-style-type: none">• Wrong channel selected. To change the channel, see "Changing Channels" on page 10.• Make sure the camera is powered on.• The camera and monitor may be out of range. Extend the antennas on the monitor or move the monitor and camera closer together.• For optimal performance, avoid placing the monitor and camera near televisions, computers, cordless/mobile phones, or other electrical equipment.• You may need to pair the camera and the monitor again. See "Pairing Additional Cameras" on page 14 for details.
Feedback / squealing noise coming from the monitor	<ul style="list-style-type: none">• Your camera and monitor may be too close to each other. Move them further apart.• Press  to lower the monitor volume.

Need Help?

Product Support is available 24/7 including product information, user guides, quick start guides, and FAQ's at www.lorexbaby.com/support

CLEANING

Clean the monitor and camera with a slightly damp cloth or an anti-static cloth. Never use cleaning agents or abrasive solvents.

- Do not clean any part of the product with cleaners with thinners or other solvents and chemicals. This may cause permanent damage to the product, which is not covered by the Warranty. When necessary, clean it with a damp cloth.
- Keep your camera and monitor away from hot, humid areas or strong sunlight, and do not get it wet.
- Every effort has been made to ensure high standards of reliability for your baby monitor. However, if something does go wrong, please do not try to repair it yourself. Contact Customer Service for assistance.

DISPOSAL OF THE DEVICE

At the end of the product life cycle, you should not dispose of this product with normal household waste, but take the product to a collection point for the recycling of electrical and electronic equipment. The symbol on the product, user's guide, and/or box indicates this.



Some of the product materials can be re-used if you take them to a recycling point. By reusing some parts or raw materials from used products you make an important contribution to the protection of the environment.

Please contact your local authorities in case you need more information on the collection points in your area. Dispose of the battery pack in an environmentally-friendly manner according to your local regulations.

NOTICES

WARNING: Any changes or modifications not expressly approved by the grantee of this device could void the user's authority to operate the device.

FCC NOTICE

This equipment has been certified and found to comply with the limits regulated by the FCC part 15, subpart C. Operation is subject to the following two conditions: (1) this device may not cause harmful interference, and (2) this device must accept any interference received, including interference that may cause undesired operation. This equipment has been tested and found to comply with the limits for a Class B digital device, pursuant to Part 15 of the FCC rules. These limits are designed to provide reasonable protection against harmful interference in a residential installation. This equipment generates, uses and can radiate radio frequency energy and, if not installed and used in accordance with the instructions, may cause harmful interference to radio communications.

However, there is no guarantee that interference will not occur in a particular installation. If this equipment does cause harmful interference to radio or television reception (which can be determined by turning the equipment on and off), the user is encouraged to try to correct the interference by one or more of the following measures:

- Reorient or relocate the receiving antenna
- Increase the separation between the equipment and receiver
- Connect the equipment into an outlet on a circuit different from that to which the receiver is connected
- Consult the dealer or an experienced radio or television technician for assistance

CAUTION: To maintain compliance with the FCC(IC)'s RF exposure guidelines, place the camera at least 20cm (7.87in) from nearby persons.

The video monitor has been tested and meets the FCC(IC) RF exposure guidelines when used with the belt clip supplied with or designated for this product. Use of other accessories may not ensure compliance with FCC(IC) RF exposure guidelines.

CANADA/IC NOTICE

This device complies with Industry Canada licence-exempt RSS standard(s). Operation is subject to the following two conditions: (1) this device may not cause interference, and (2) this device must accept any interference, including interference that may cause undesired operation of the device.

Le présent appareil est conforme aux CNR d'Industrie Canada applicables aux appareils radio exempts de licence.

L'exploitation est autorisée aux deux conditions suivantes:

- (1) l'appareil ne doit pas produire de brouillage, et
- (2) l'utilisateur de l'appareil doit accepter tout brouillage radioélectrique subi, même si le brouillage est susceptible d'en compromettre le fonctionnement.

Under Industry Canada regulations, this radio transmitter may only operate using an antenna of a type and maximum (or lesser) gain approved for the transmitter by Industry Canada. To reduce potential radio interference to other users, the antenna type and its gain should be so chosen that the equivalent isotropically radiated power (e.i.r.p.) is not more than that necessary for successful communication.

Conformément à la réglementation d'Industrie Canada, le présent émetteur radio peut fonctionner avec une antenne d'un type et d'un gain maximal (ou inférieur) approuvé pour l'émetteur par Industrie Canada.

Dans le but de réduire les risques de brouillage radioélectrique à l'intention des autres utilisateurs, il faut choisir le type d'antenne et son gain de sorte que la puissance isotrope rayonnée équivalente (p.i.r.e.) ne dépasse pas l'intensité nécessaire à l'établissement d'une communication satisfaisante.



USER'S GUIDE
SWEET PEEK MINI

www.lorexbaby.com
Copyright © Lorex Technology Inc. 2013