



FCC 47 CFR PART 15 SUBPART C: 2009 AND ANSI C63.4: 2003

TEST REPORT

For

**N+ High Power Broadband Router - All
Broadbands**

Model Number: BR280n

Brand Name: ETOP

Issued for

E-Top Network Technology Inc.

No. 82 ,Gongye 2nd Rd.,Tainan City 70955,Taiwan,R.O.C.

Issued by

**Compliance Certification Services Inc.
Tainan Lab.**

**No. 8, Jiu Cheng Ling, Jiaokeng Village, Sinhua
Township, Tainan Hsien 712, Taiwan R.O.C.**

TEL: 886-6-580-2201

FAX: 886-6-580-2202



Note: *This report shall not be reproduced except in full, without the written approval of Compliance Certification Services Inc. Ltd. This document may be altered or revised by Compliance Certification Services Inc. personnel only, and shall be noted in the revision section of the document*

Total Page: 139



REVISION HISTORY

Rev.	Issue Date	Revisions	Effect Page	Revised By
00	February 14, 2011	Initial Issue	ALL	Leah Peng



TABLE OF CONTENTS

1. TEST REPORT CERTIFICATION4

2. EUT DESCRIPTION5

 2.1 DESCRIPTION OF EUT & POWER 5

3. DESCRIPTION OF TEST MODES7

4. TEST METHODOLOGY8

5. FACILITIES AND ACCREDITATIONS.....8

 5.1 FACILITIES..... 8

 5.2 EQUIPMENT..... 8

 5.3 LABORATORY ACCREDITATIONS LISTINGS 8

 5.4 TABLE OF ACCREDITATIONS AND LISTINGS 9

6. CALIBRATION AND UNCERTAINTY10

 6.1 MEASURING INSTRUMENT CALIBRATION..... 10

 6.2 MEASUREMENT UNCERTAINTY 10

7. SETUP OF EQUIPMENT UNDER TEST.....11

 7.1 SETUP CONFIGURATION OF EUT..... 11

 7.2 SUPPORT EQUIPMENT 12

 7.3 EUT OPERATING CONDITION 13

8. APPLICABLE LIMITS AND TEST RESULTS.....14

 8.1 6DB BANDWIDTH 14

 8.2 MAXIMUM PEAK OUTPUT POWER..... 29

 8.3 MAXIMUM PERMISSIBLE EXPOSURE..... 33

 8.4 POWER SPECTRAL DENSITY 35

 8.5 CONDUCTED SPURIOUS EMISSION..... 55

 8.6 RADIATED EMISSIONS..... 84

 8.7 POWERLINE CONDUCTED EMISSIONS 131

9. ANTENNA REQUIREMENT135

 9.1 STANDARD APPLICABLE 135

 9.2 ANTENNA CONNECTED CONSTRUCTION 135

APPENDIX I SETUP PHOTOS136

APPENDIX II PHOTOGRAPHS OF EUT.....A1



1. TEST REPORT CERTIFICATION

Applicant : E-Top Network Technology Inc.
Address : No. 82 ,Gongye 2nd Rd.,Tainan City 70955,Taiwan,R.O.C.
Manufacture : E-Top Network Technology Inc.
Address : No. 82 ,Gongye 2nd Rd.,Tainan City 70955,Taiwan,R.O.C.
Equipment Under Test : N+ High Power Broadband Router - All Broadbands
Model Number : BR280n
Brand Name : ETOP
Date of Test : January 7, 2011 – January 31, 2011

APPLICABLE STANDARD	
STANDARD	TEST RESULT
FCC Part 15 Subpart C : 2009 AND ANSI C63.4 : 2003	No non-compliance noted

Approved by:

Jeter Wu
Assistant Manager

Reviewed by:

Eric Huang
Assistant Section Manager



2. EUT DESCRIPTION

2.1 DESCRIPTION OF EUT & POWER

Product Name	N+ High Power Broadband Router - All Broadbands
Model Number	BR280n
Brand Name	ETOP
Frequency Range	IEEE 802.11b/g, 802.11n HT20 (DTS Band):2412MHz~2462MHz IEEE 802.11n HT40 (DTS Band):2422MHz~2452MHz
Conducted Output Power	IEEE 802.11b Mode : 19.01dBm (DTS Band) (79.616 mW) IEEE 802.11g Mode : 18.73dBm (DTS Band) (74.645 mW) IEEE 802.11n HT20 Mode : 20.33dBm (DTS Band) (107.87 mW) IEEE 802.11n HT40 Mode : 19.49dBm (DTS Band) (88.962 mW)
Channel Spacing	IEEE 802.11b/g, 802.11n HT20/HT40: 5MHz
Channel Number	IEEE 802.11b/g, 802.11n HT20:11 Channels IEEE 802.11n HT40 :7 Channels
Transmit Data Rate	IEEE 802.11b : 11, 5.5, 2, 1 Mbps IEEE 802.11g : 54, 48, 36, 24, 18, 12, 9, 6 Mbps IEEE 802.11n HT20 : 65, 58.5, 52, 39, 26, 19.5, 13, 6.5 Mbps IEEE 802.11n HT40 : 135, 121.5, 108, 81, 54, 40.5, 27, 13.5 Mbps
Type of Modulation	IEEE 802.11b : DSSS (CCK, DQPSK, DBPSK)
	IEEE 802.11g : OFDM (64QAM, 16QAM, QPSK, BPSK)
	IEEE 802.11n HT20/40 : OFDM (64QAM, 16QAM, QPSK, BPSK)
Frequency Selection	By software / firmware
Antenna Type	Two antennas 2Tx 2Rx Manufacture: XINXIE TECHNOLOGY (SHENZHEN) CO., LTD. Model: S22-XY30924 Type: Dipole Gain: 5 dBi
Power Source	SWITCHING ADAPTOR Manufacture: Keen Ocean Industrial Ltd. Model: S02-012-0120-01000 SWP-21426-00 Input: 100-240Vac, 50/60Hz, 0.40A max. Output: 12.0Vdc, 1A (one core on the power cord) Core Spec.: Manufacture: King core Model: M2 Size:16mm*28mm*9mm
Temperature Range	0 ~ 40°C



REMARK:

1. The sample selected for test was engineering sample that approximated to production product and was provided by manufacturer.
2. This submittal(s) (test report) is intended for FCC ID: **U6A-BR280N** filing to comply with Section 15.207, 15.209 and 15.247 of the FCC Part 15, Subpart C Rules.
3. Client consigns one model sample and two adapters to test (Model Number: BR280n). Therefore, the testing Lab. just guarantees the unit, which has been tested.
4. For more details, please refer to the User's manual of the EUT.
5. To add a series model is for business necessary, just for marketing purpose only.
6. The different of the each model is shown as below:

Multiple listing:

Company Name/Address	Brand name	Model	Product Name
E-Top Network Technology Inc. No. 82 ,Gongye 2nd Rd.,Tainan City 70955,Taiwan,R.O.C.	ETOP	BR280n	N+ High Power Broadband Router - All Broadbands
Amigo Technology Inc. 5F., No.63, Lane 77, Xing-Ai Road, Neihu Dist., Taipei City 114, Taiwan (R.O.C.)	Amigo	BR280n	High Power 11n Firewall Router
CNet Technology Inc. 1F,No.30,Industry E.RD.IX, Science-Based Industrial Park, Hsin-Chu, Taiwan,R.O.C.	CNet	CHR-980	High Power Wireless-N Broadband Router
Sapido Technology Inc. No. 383., Sec. 2, Minsheng Rd., West Central District, Tainan 700, Taiwan, R.O.C.	SAPIDO	RB-1732	N+ High Power Broadband Router - All Broadbands



3. DESCRIPTION OF TEST MODES

The EUT is a 11n router. It has two transmitter chains and two receive chains (2x2 configurations). The 2x2 configuration is implemented with two outside chains (Chain 0 and Chain 1).

The RF chipset is manufactured by Realtek Semiconductor Corp.

The antenna peak gain 5dBi (highest gain) were chosen for full testing.

IEEE 802.11 b ,802.11g ,802.11n HT20 mode (DTS Band)

The EUT had been tested under operating condition.

There are three channels have been tested as following:

Channel	Frequency (MHz)
Low	2412
Middle	2437
High	2462

IEEE 802.11b mode: 11Mbps data rate (worst case) were chosen for full testing.

IEEE 802.11g mode: 6Mbps data rate (worst case) were chosen for full testing.

IEEE 802.11n HT20 mode: 13Mbps data rate (worst case) were chosen for full testing.

IEEE 802.11n HT40 mode (DTS Band)

The EUT had been tested under operating condition.

There are three channels have been tested as following:

Channel	Frequency (MHz)
Low	2422
Middle	2437
High	2452

IEEE 802.11n HT40 mode: 27Mbps data rate (worst case) were chosen for full testing.

The worst-case data rates are determined according to the description above, based on the investigations by measuring the PSD, peak power and average power across all the data rates, bandwidths, modulations and spatial stream modes.

The worst-case channel is determined as the channel with the highest output power. The highest measured output power was at 2412 MHz.



4. TEST METHODOLOGY

The tests documented in this report were performed in accordance with ANSI C63.4 and FCC CFR 47 2.1046, 2046, 2.1047, 2.1049, 2.1051, 2.1053, 2.1055, 2.1057, 15.207, 15.209 and 15.247.

5. FACILITIES AND ACCREDITATIONS

5.1 FACILITIES

All measurement facilities used to collect the measurement data are located at No. 8, Jiu Cheng Ling, Jiaokeng Village, Sinhua Township, Tainan Hsien 712, Taiwan R.O.C.

The sites are constructed in conformance with the requirements of ANSI C63.7, ANSI C63.4 and CISPR Publication 22.

5.2 EQUIPMENT

Radiated emissions are measured with one or more of the following types of linearly polarized antennas: tuned dipole, biconical, log periodic, bi-log, and/or ridged waveguide, horn. Spectrum analyzers with preselectors and quasi-peak detectors are used to perform radiated measurements.

Conducted emissions are measured with Line Impedance Stabilization Networks and EMI Test Receivers.

Calibrated wideband preamplifiers, coaxial cables, and coaxial attenuators are also used for making measurements.





All receiving equipment conforms to CISPR Publication 16-1, "Radio Interference Measuring Apparatus and Measurement Methods."

5.3 LABORATORY ACCREDITATIONS LISTINGS

The test facilities used to perform radiated and conducted emissions tests are accredited by Taiwan Accreditation Foundation for the specific scope of accreditation under Lab Code: 1109 to perform Electromagnetic Interference tests according to FCC PART 15 AND CISPR 22 requirements. No part of this report may be used to claim or imply product endorsement by TAF or any agency of the Government. In addition, the test facilities are listed with Federal Communications Commission (registration no: TW-1037).



5.4 TABLE OF ACCREDITATIONS AND LISTINGS

Country	Agency	Scope of Accreditation	Logo
USA	FCC	3/10 meter Open Area Test Sites to perform FCC Part 15/18 measurements	 TW-1037
Taiwan	TAF	CISPR 11, FCC METHOD-47 CFR Part 18, EN 55011, EN 60601-1-2, CISPR 22, CNS 13438, EN 55022, EN 55024, AS/NZS CISPR 22 CISPR 14, EN 55014-1, EN 55014-2, CNS 13783-1, CISPR 22, CNS 13439, EN 55013, FCC Method-47 CFR Part 15 Subpart B, IC ICES-003, VCCI V-3 & V-4 FCC Method-47 CFR Part 15 Subpart C and ANSI C63.4, LP 0002 EN / IEC 61000-4-2 / -3 / -4 / -5 / -6 / -8 / -11 EN 61000-3-2, EN 61000-3-3 EN 61000-6-3, EN 61000-6-1, AS/NZS 4251.1, EN 61000-6-4, EN 61000-6-2, AS/NZS 4251.2, EN 61204-3, EN 50130-4, EN 62040-2, EN 50371, EN 50385, AS/NZS 4268, ETSI EN 300 386 ETSI EN 300 328, ETSI EN 301 489-1/-3/-9/-17 ETSI EN 301 893, ETSI EN 300 220-2/-1 ETSI EN 300 440-2/-1 ETSI EN 301 357-2/-1 RSS-310, RSS-210 Issue 7, RSS-Gen Issue 2	
Taiwan	BSMI	CNS 13438, CNS 13783-1, CNS13439	 SL2-IN-E-0039 SL2-R1/R2-0039 SL2-A1-E-0039
Canada	Industry Canada	RSS210, Issue 8	 IC 2324H-1

* No part of this report may be used to claim or imply product endorsement by TAF or any agency of the US Government.



6. CALIBRATION AND UNCERTAINTY

6.1 MEASURING INSTRUMENT CALIBRATION

The measuring equipment utilized to perform the tests documented in this report has been calibrated in accordance with the manufacturer's recommendations, and is traceable to recognized national standards.

6.2 MEASUREMENT UNCERTAINTY

Where relevant, the following measurement uncertainty levels have been estimated for tests performed on the apparatus:

PARAMETER	UNCERTAINTY
Radiated Emission, 30 to 200 MHz Test Site : OATS-6	±3.38dB
Radiated Emission, 200 to 1000 MHz Test Site : OATS-6	±3.04dB
Radiated Emission, 1 to 26.5 GHz	± 3.20dB
Power Line Conducted Emission	± 2.01dB

Uncertainty figures are valid to a confidence level of 95%, K=2



7. SETUP OF EQUIPMENT UNDER TEST

7.1 SETUP CONFIGURATION OF EUT

Above 1GHz Test Setup:

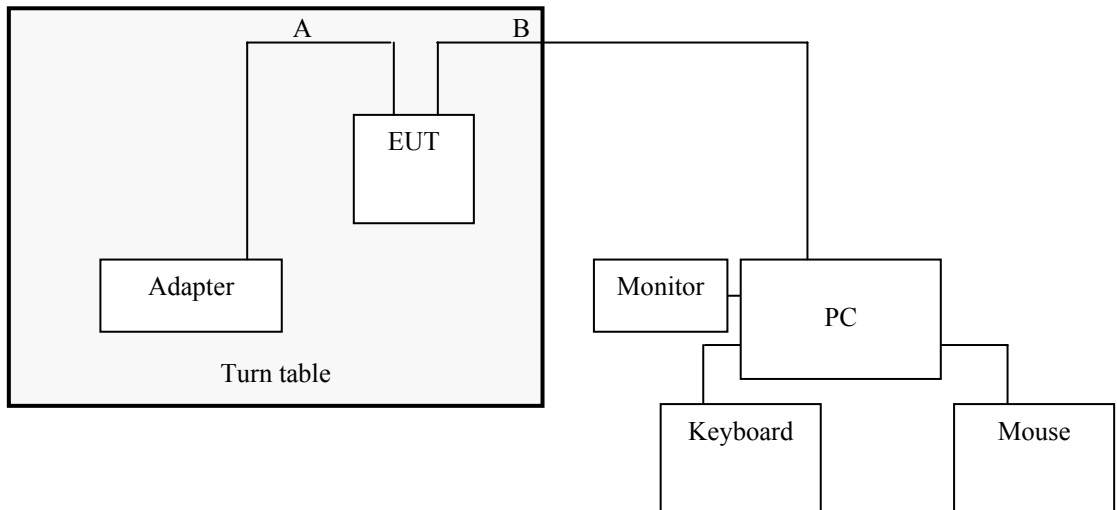

Below 1GHz Test Setup:

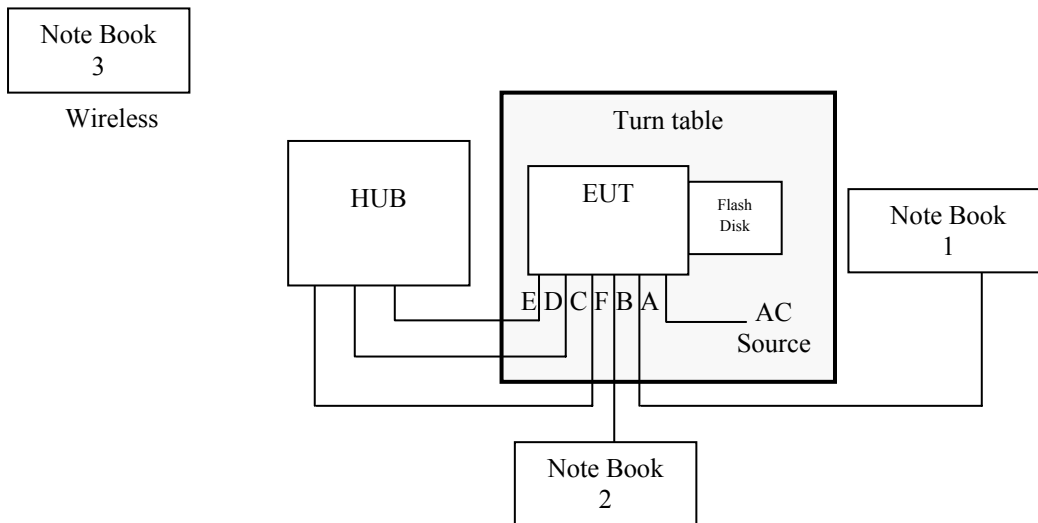



7.2 SUPPORT EQUIPMENT

Above 1GHz Test Setup:

No.	Product	Manufacturer	Model No.	Certify No.	Signal cable
1	PC	HP	D330uT	R33001	Power cable, unshd, 1.5m
2	LCD Monitor	BenQ	FP731	R43002	VGA cable, shd, 1.8m
3	Keyboard(USB)	DETROIS	KB-2181	T33097	Keyboard cable, shd, 1.4m
4	Mouse(USB)	I-DRIVER	P002	R35569	Mouse cable, shd, 1.4m

No.	Signal cable description	
A	DC input	Unshielded, 1.8m, 1pcs
B	LAN cable	Unshielded, 10m, 1pcs.

Below 1GHz Test Setup:

No.	Product	Manufacturer	Model No.	Certify No.	Signal cable
1	Note Book	IBM	R51	R33026	Power cable, unshd, 1.6m
2	Note Book	IBM	T43	DOC	Power cable, unshd, 1.6m
3	Note Book	MIS	MS-1452	DOC	Power cable, unshd, 1.6m
4	Flash Disk	Kingston	DTI/512	DOC	N/A
5	HUB	BARRICAD	SMC7008BR	DOC	Power cable, unshd, 1.6m

No.	Signal cable description	
A	DC input	Unshielded, 1.8m, 1pcs.
B	LAN cable	Unshielded, 10m, 1pcs.
C	LAN cable	Unshielded, 2m, 1pcs.
D	LAN cable	Unshielded, 2m, 1pcs.
E	LAN cable	Unshielded, 2m, 1pcs.
F	LAN cable	Unshielded, 10m, 1pcs.

REMARK:

1. All the above equipment/cables were placed in worse case positions to maximize emission signals during emission test.
2. Grounding was established in accordance with the manufacturer's requirements and conditions for the intended use.



7.3 EUT OPERATING CONDITION

RF Setup

1. Set up all computers like the setup diagram.
2. The "Ralink QA Test Program for RTL8192" software was used for testing
The EUT driver software installed in the host support equipment during testing was Ralink QA Test Program for RTL8192 Drive

TX Mode:

- ⇒ **Tx Mode:CCK 、 OFDM 、 HT MixMode** (Bandwidth: 20 、 40)
- ⇒ **Tx Data Rate: 11Mbps long** (IEEE 802.11b mode ,chain 0 TX)
6Mbps (IEEE 802.11g mode ,chain 0 TX)
13Mbps (IEEE 802.11n HT20 mode ,chain 0, chain 1 TX)
27Mbps (IEEE 802.11n HT40 mode, chain 0, chain 1 TX)

Power control mode

- Target Power:** IEEE 802.11b Channel Low (2412MHz) = **14 (Chain 0)**
IEEE 802.11b Channel Middle (2437MHz) = **14 (Chain 0)**
IEEE 802.11b Channel High (2462MHz) = **14 (Chain 0)**
- Target Power:** IEEE 802.11g Channel Low (2412MHz) = **14 (Chain 0)**
IEEE 802.11g Channel Middle (2437MHz) = **14 (Chain 0)**
IEEE 802.11g Channel High (2462MHz) = **14 (Chain 0)**
- Target Power:** IEEE 802.11n HT20 Channel Low (2412MHz) = **10 (Chain 0)**
IEEE 802.11 n HT20 Channel Middle (2437MHz) = **10 (Chain 0)**
IEEE 802.11 n HT20 Channel High (2462MHz) = **10 (Chain 0)**
IEEE 802.11n HT20 Channel Low (2412MHz) = **10 (Chain 1)**
IEEE 802.11 n HT20 Channel Middle (2437MHz) = **10 (Chain 1)**
IEEE 802.11 n HT20 Channel High (2462MHz) = **10 (Chain 1)**
- Target Power:** IEEE 802.11n HT40 Channel Low (2422MHz) = **10 (Chain 0)**
IEEE 802.11 n HT40 Channel Middle (2437MHz) = **10 (Chain 0)**
IEEE 802.11 n HT40 Channel High (2452MHz) = **10 (Chain 0)**
IEEE 802.11n HT40 Channel Low (2422MHz) = **10 (Chain 1)**
IEEE 802.11 n HT40 Channel Middle (2437MHz) = **10 (Chain 1)**
IEEE 802.11 n HT40 Channel High (2452MHz) = **10 (Chain 1)**

(2) **RX Mode :**

Start RX

3. All of the functions are under run.
4. Start test.

Normal Link Setup

1. Set up all computers like the setup diagram.
 2. All of the function are under run.
 3. Notebook PC (2) ping 192.168.0.10 -t to Notebook PC (1).
 4. Notebook PC (1) ping 192.168.0.20 -t to Notebook PC (2).
 5. Notebook PC (1) ping 192.168.0.50 -t to Wireless Access Point (3).
- Start test.



8. APPLICABLE LIMITS AND TEST RESULTS

8.1 6DB BANDWIDTH

LIMIT

§ 15.247(a) (2) For direct sequence systems, the minimum 6dB bandwidth shall be at least 500kHz

TEST EQUIPMENTS

Name of Equipment	Manufacturer	Model	Serial Number	Calibration Due
Spectrum Analyzer	R&S	FSEK 30	835253/002	JUL. 14, 2011

TEST SETUP

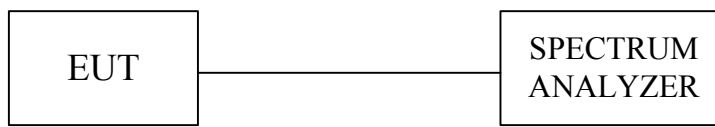

TEST PROCEDURE

The transmitter output was connected to a spectrum analyzer. The bandwidth of the fundamental frequency was measured by spectrum analyzer with 100 KHz RBW and 100 KHz VBW. The 6dB bandwidth is defined as the total spectrum the power of which is higher than peak power minus 6dB.



TEST RESULTS

No non-compliance noted.

IEEE 802.11b mode (Chain 0)

Channel	Channel Frequency (MHz)	6dB Bandwidth (kHz)	Minimum Limit (kHz)	Pass / Fail
Low	2412	10321	500	PASS
Middle	2437	10321	500	PASS
High	2462	10321	500	PASS

NOTE :

1. At final test to get the worst-case emission at 11Mbps.
2. The cable assembly insertion loss of 11.7dB (including 10 dB pad and 1.7 dB cable) was entered as an offset in the spectrum analyzer to allow for direct reading of power.

IEEE 802.11g mode (Chain 0)

Channel	Channel Frequency (MHz)	6dB Bandwidth (kHz)	Minimum Limit (kHz)	Pass / Fail
Low	2412	16633	500	PASS
Middle	2437	16633	500	PASS
High	2462	16633	500	PASS

NOTE :

1. At final test to get the worst-case emission at 6Mbps.
2. The cable assembly insertion loss of 11.7dB (including 10 dB pad and 1.7 dB cable) was entered as an offset in the spectrum analyzer to allow for direct reading of power.



IEEE 802.11n HT20 mode (Two TX)

Channel	Channel Frequency (MHz)	6dB Bandwidth (kHz)		Minimum Limit (kHz)	Pass / Fail
		Chain 0	Chain1		
Low	2412	17936	17936	500	PASS
Middle	2437	17936	17936	500	PASS
High	2462	17936	17836	500	PASS

NOTE :

1. At final test to get the worst-case emission at 13Mbps.
2. The cable assembly insertion loss of 11.7dB (including 10 dB pad and 1.7 dB cable) was entered as an offset in the spectrum analyzer to allow for direct reading of power.

IEEE 802.11n HT40 mode (Two TX)

Channel	Channel Frequency (MHz)	6dB Bandwidth (kHz)		Minimum Limit (kHz)	Pass / Fail
		Chain 0	Chain1		
Low	2422	36834	36673	500	PASS
Middle	2437	36814	36593	500	PASS
High	2452	36874	36673	500	PASS

NOTE :

1. At final test to get the worst-case emission at 27Mbps.
2. The cable assembly insertion loss of 11.7dB (including 10 dB pad and 1.7 dB cable) was entered as an offset in the spectrum analyzer to allow for direct reading of power.



6dB BANDWIDTH (802.11b MODE)

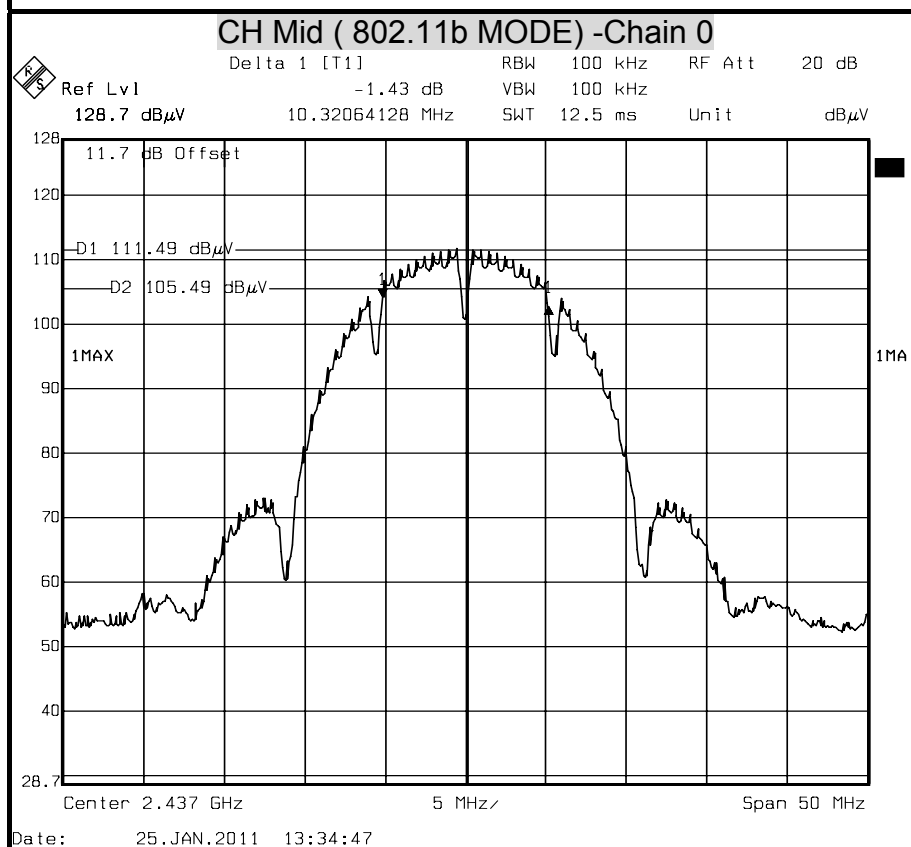
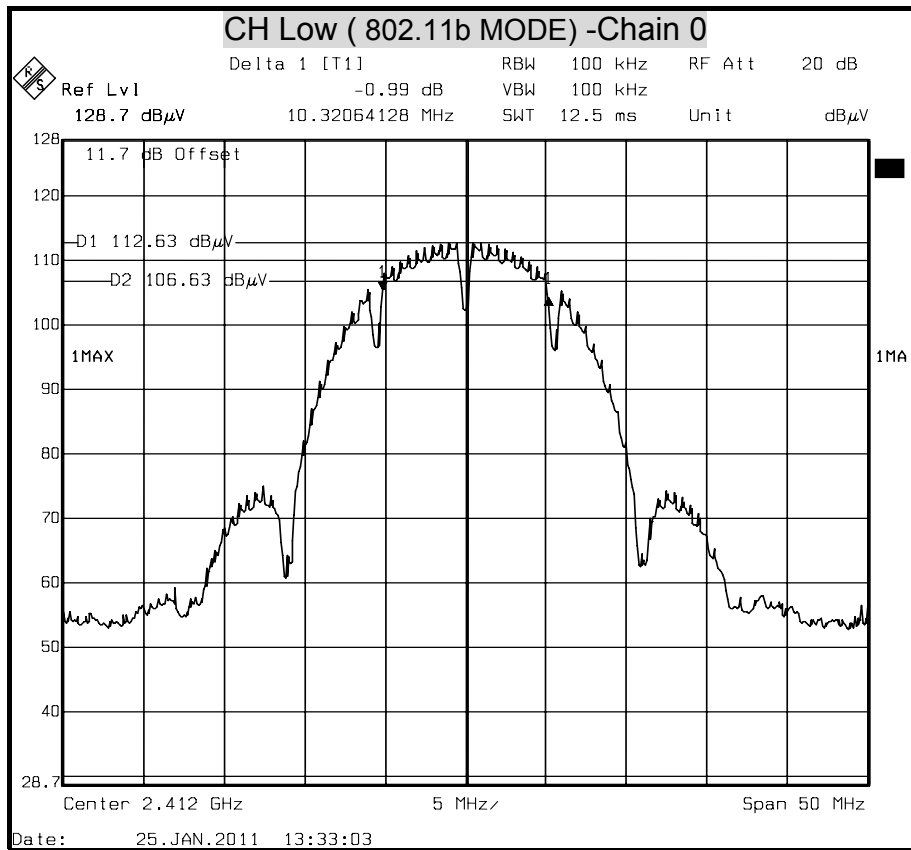

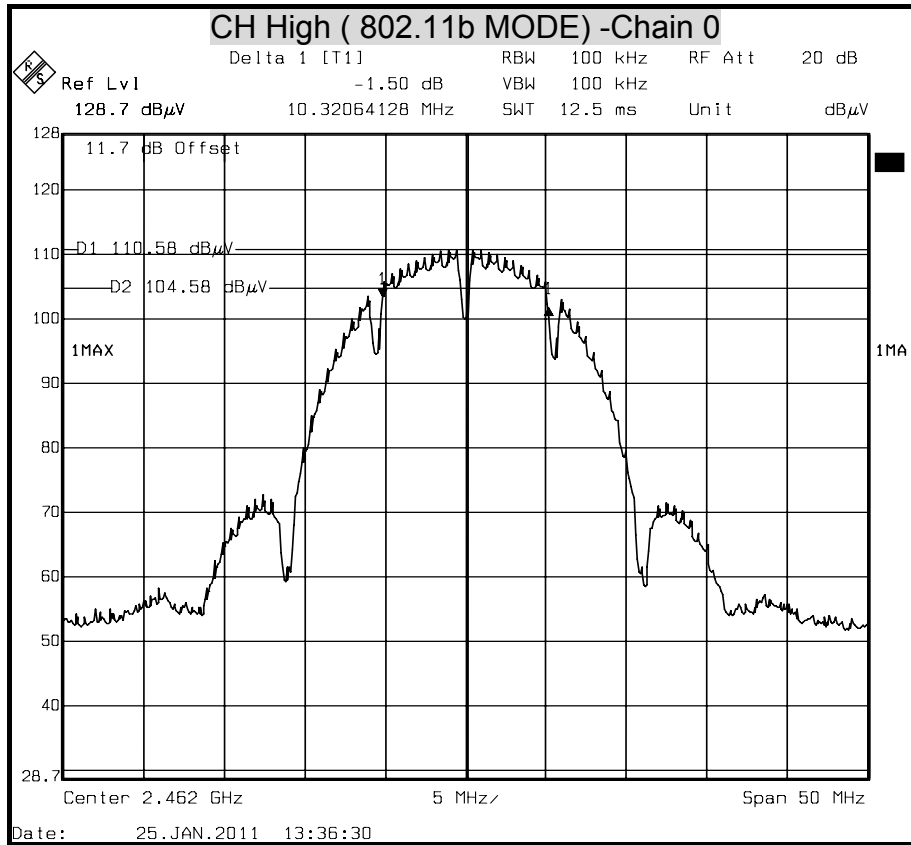



6dB BANDWIDTH (802.11g MODE)

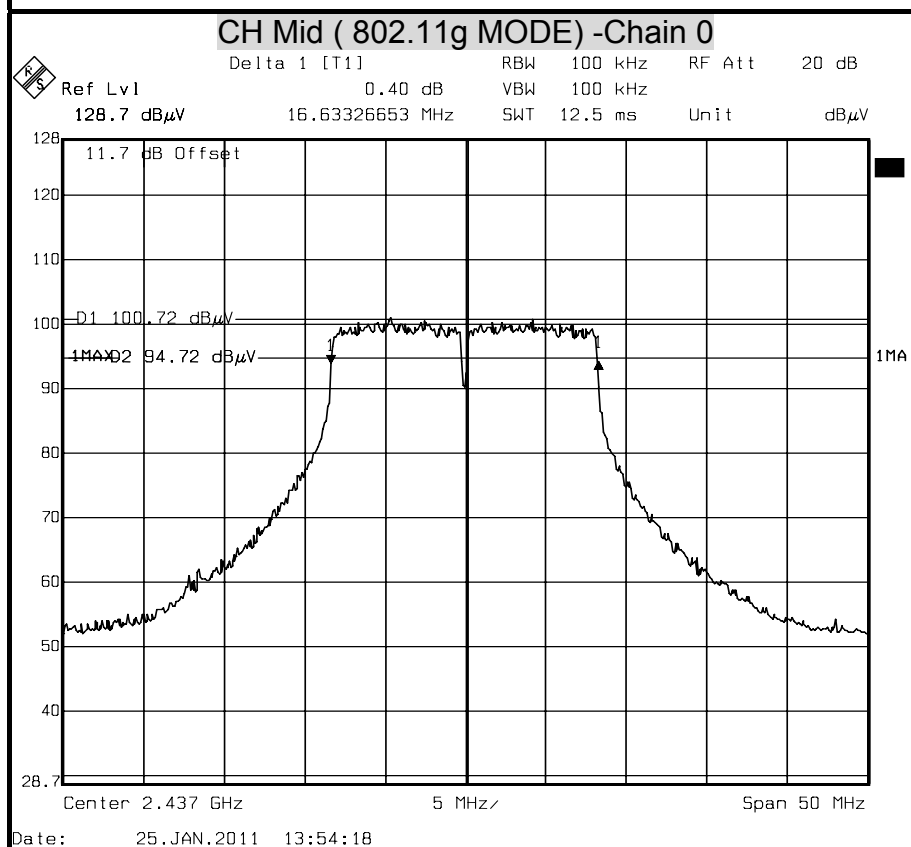
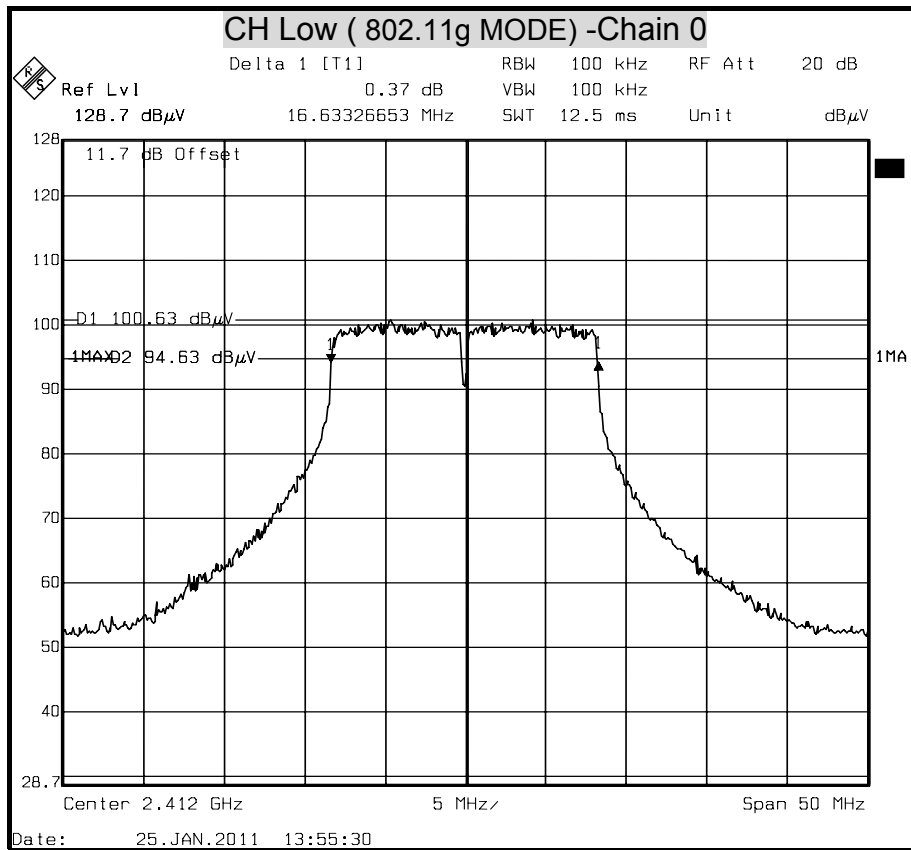

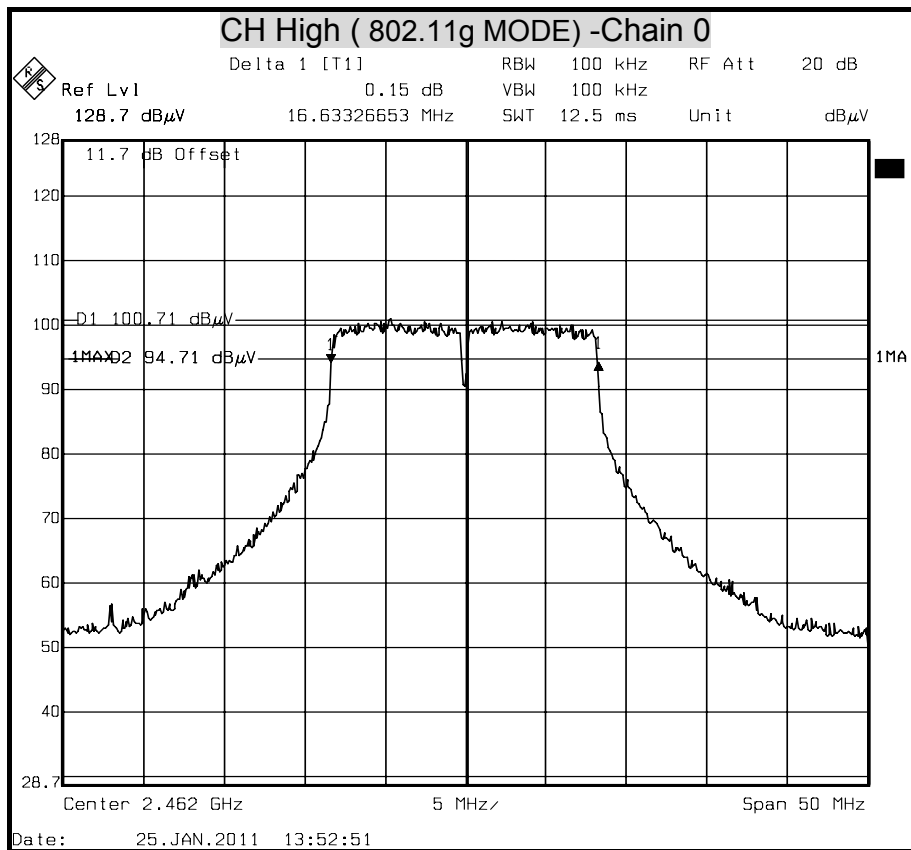



6dB BANDWIDTH (802.11n HT20 MODE) Chain 0

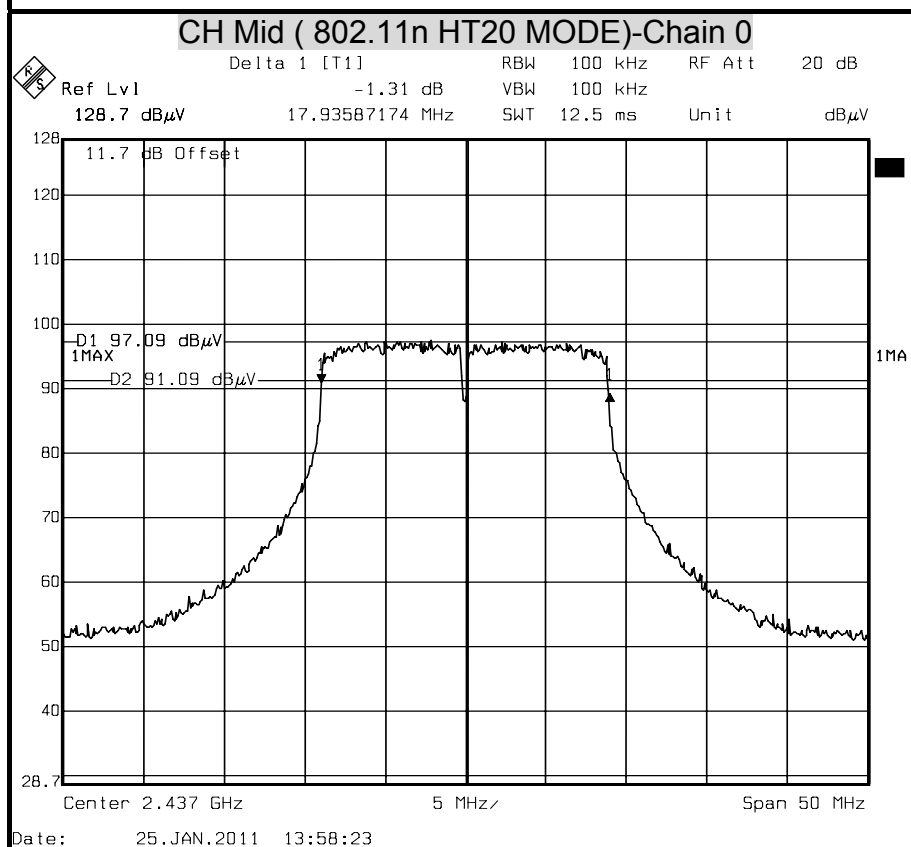
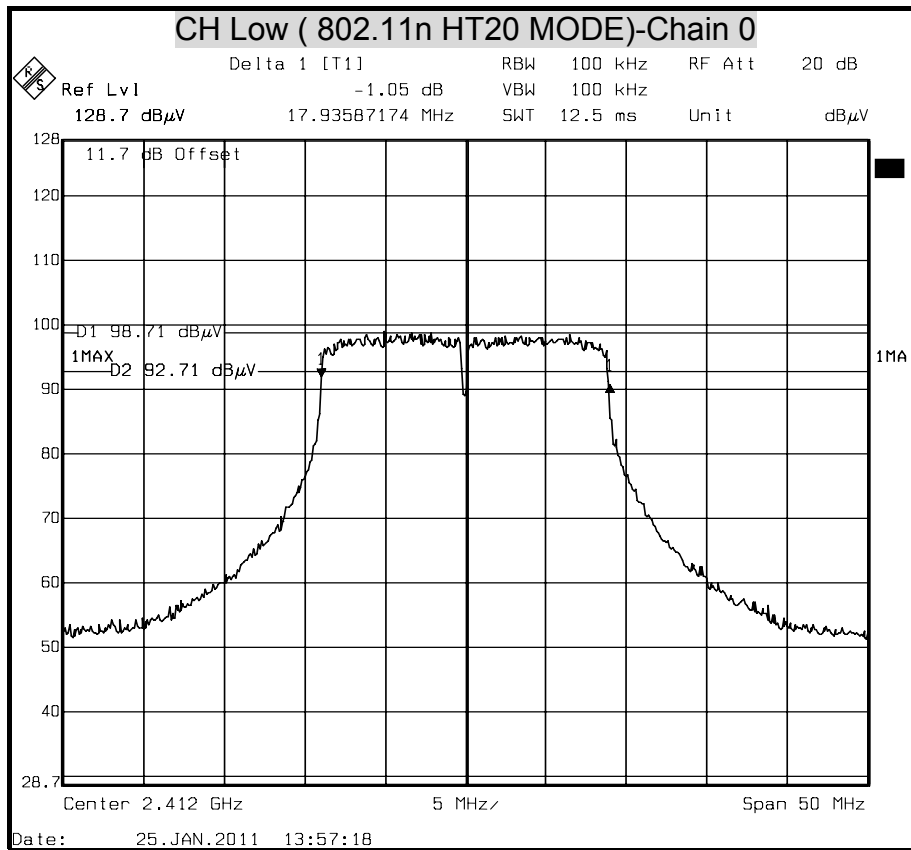

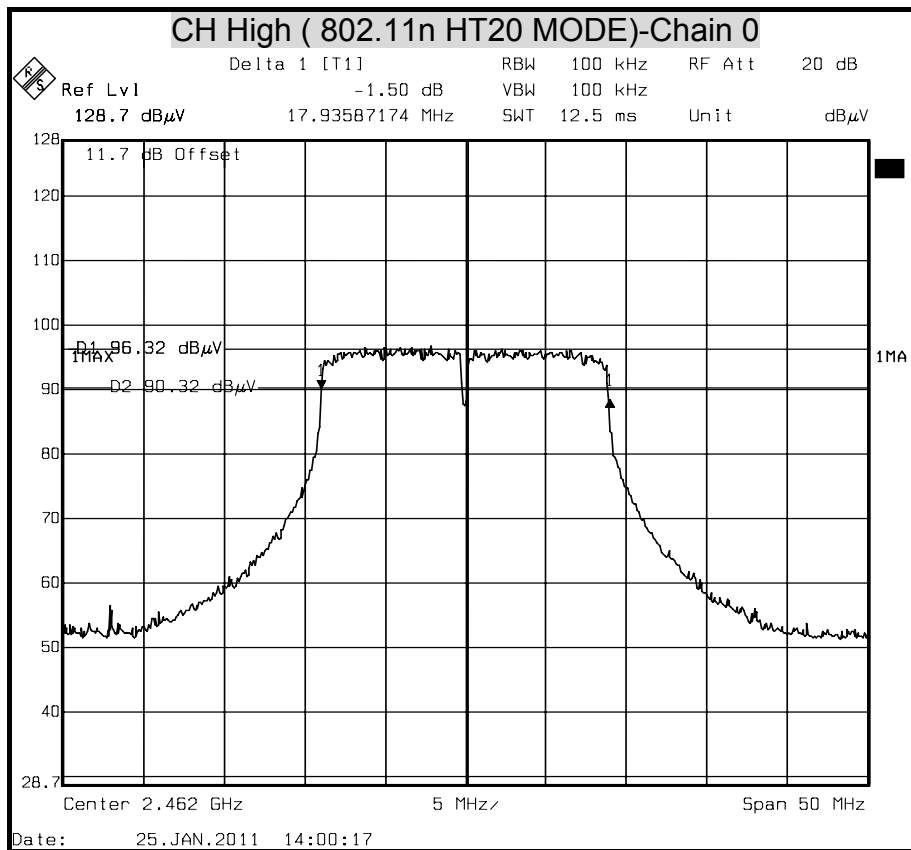



6dB BANDWIDTH (802.11n HT20 MODE) Chain 1

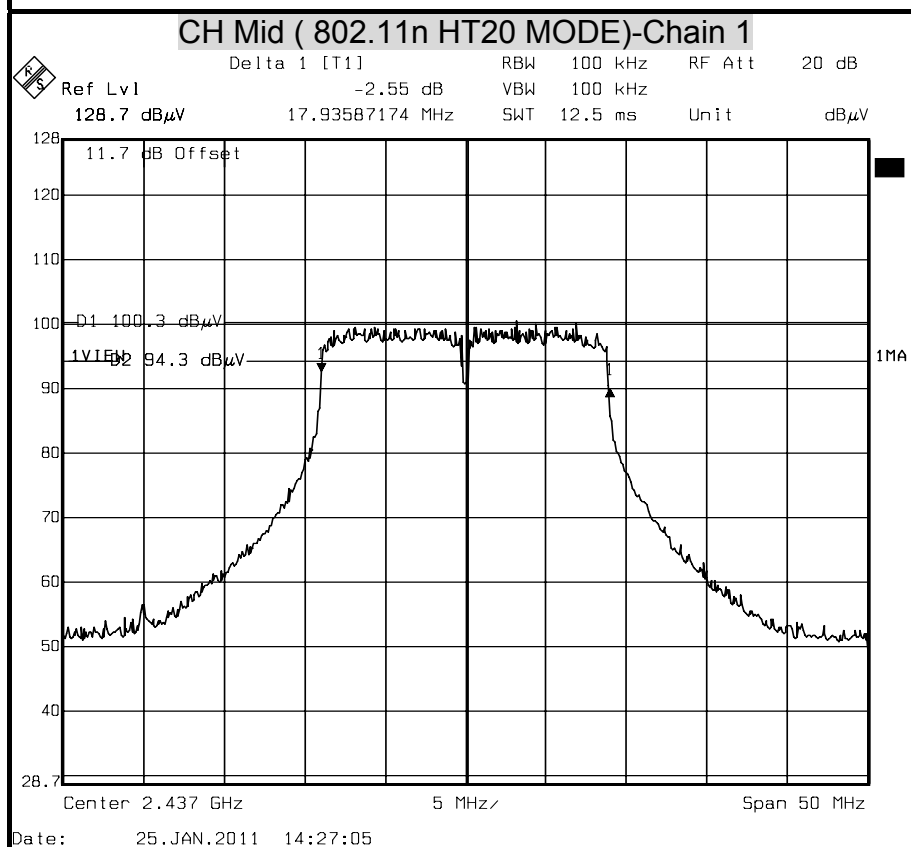
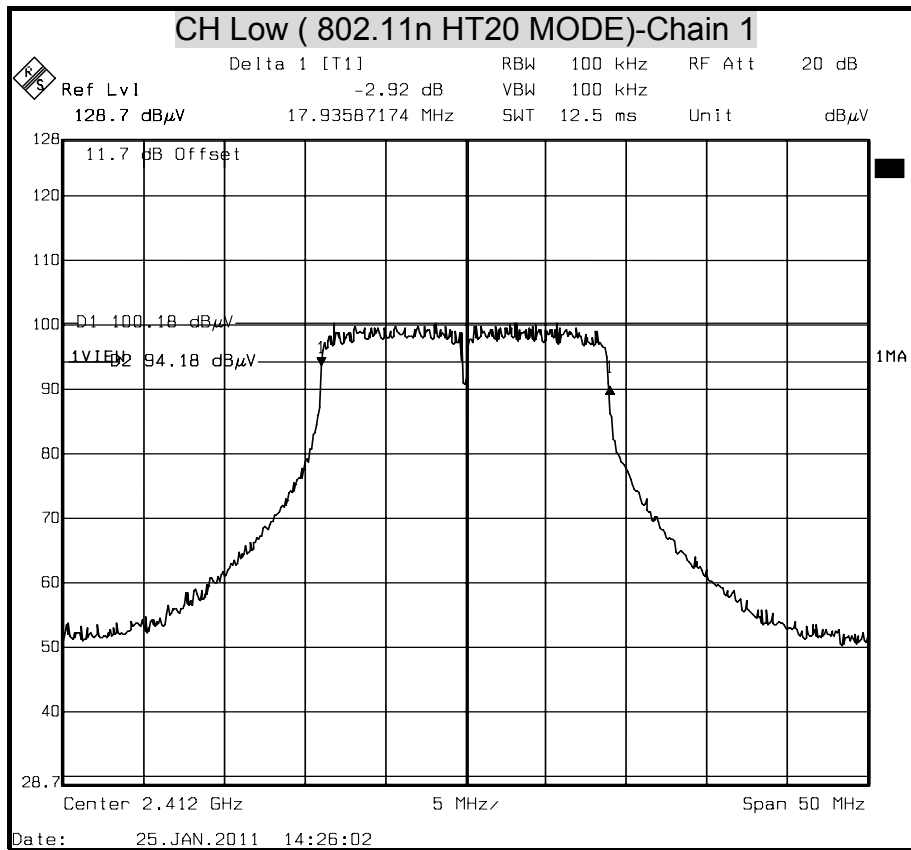

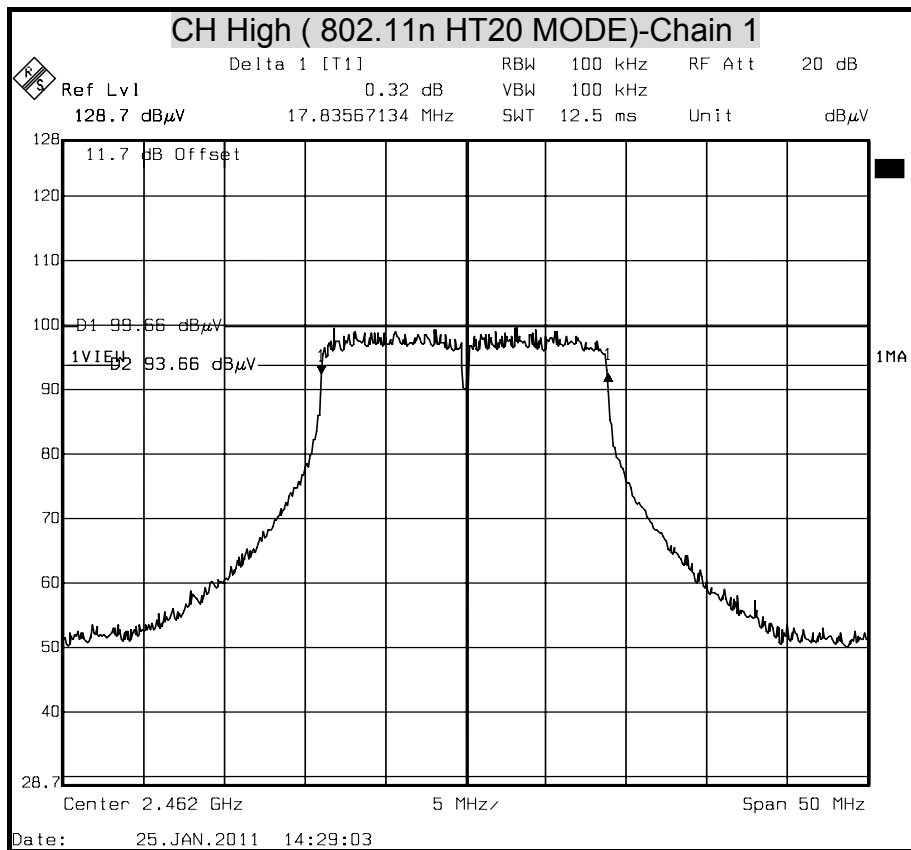



6dB BANDWIDTH (802.11n HT40 MODE) Chain 0

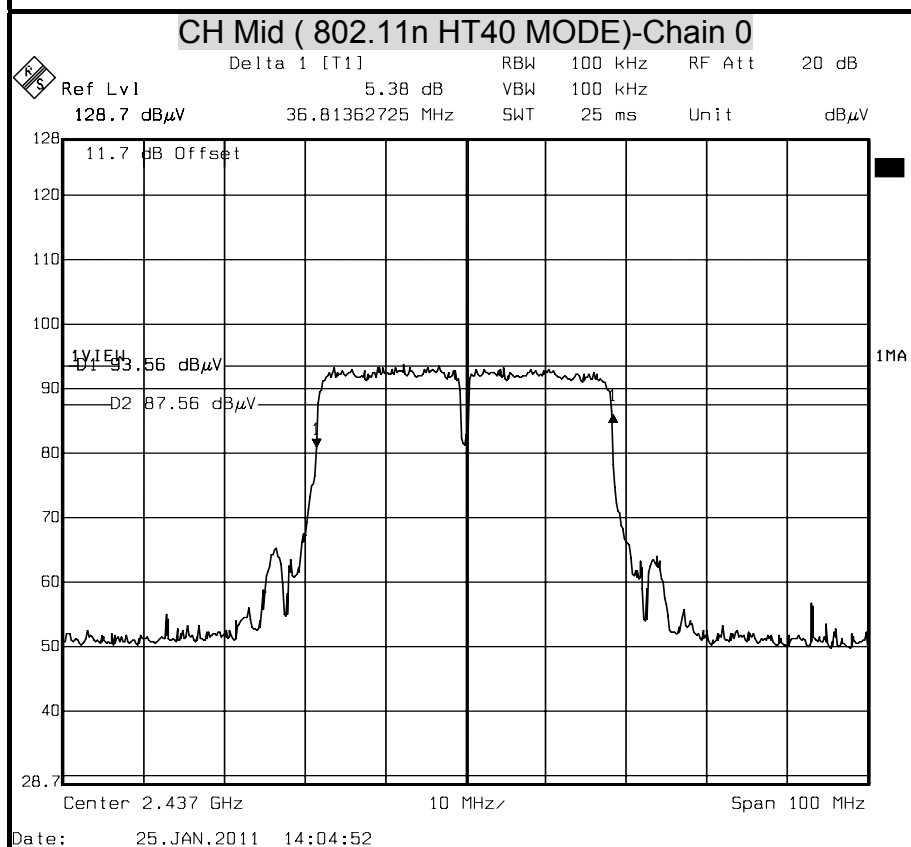
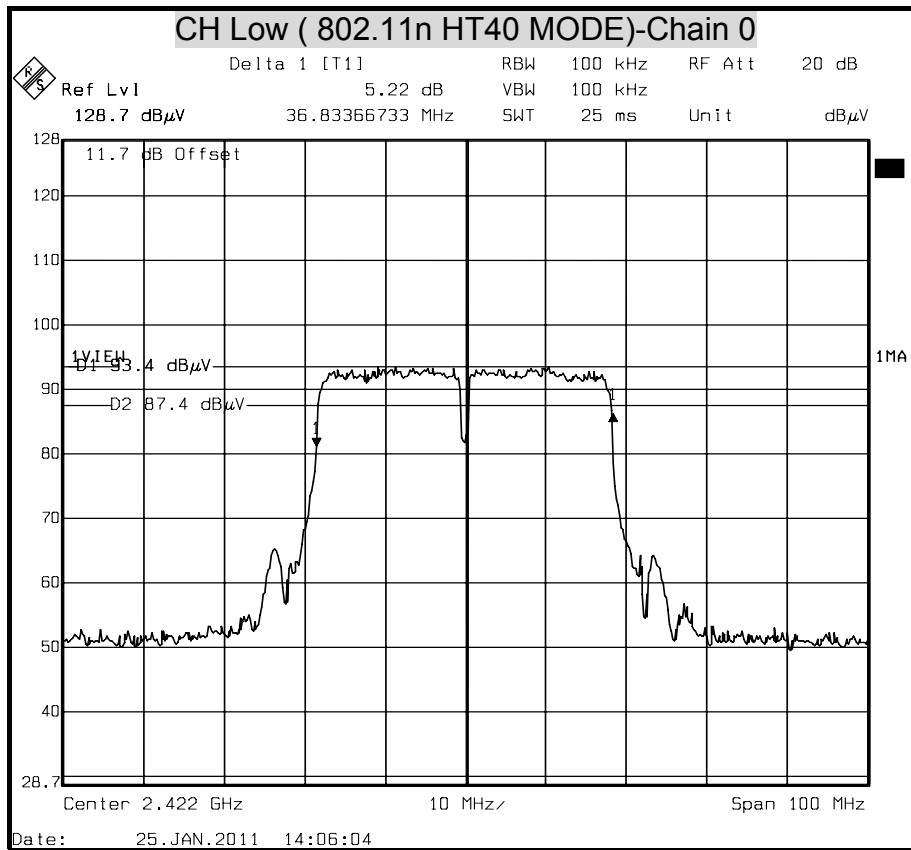

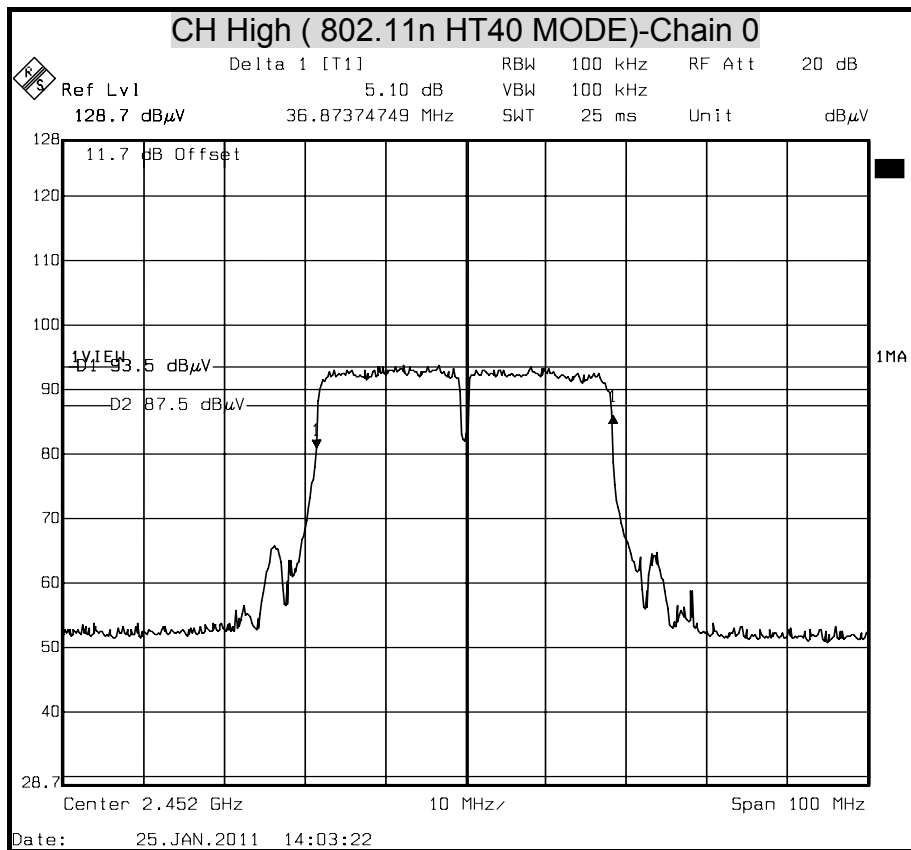



6dB BANDWIDTH (802.11n HT40 MODE) Chain 1

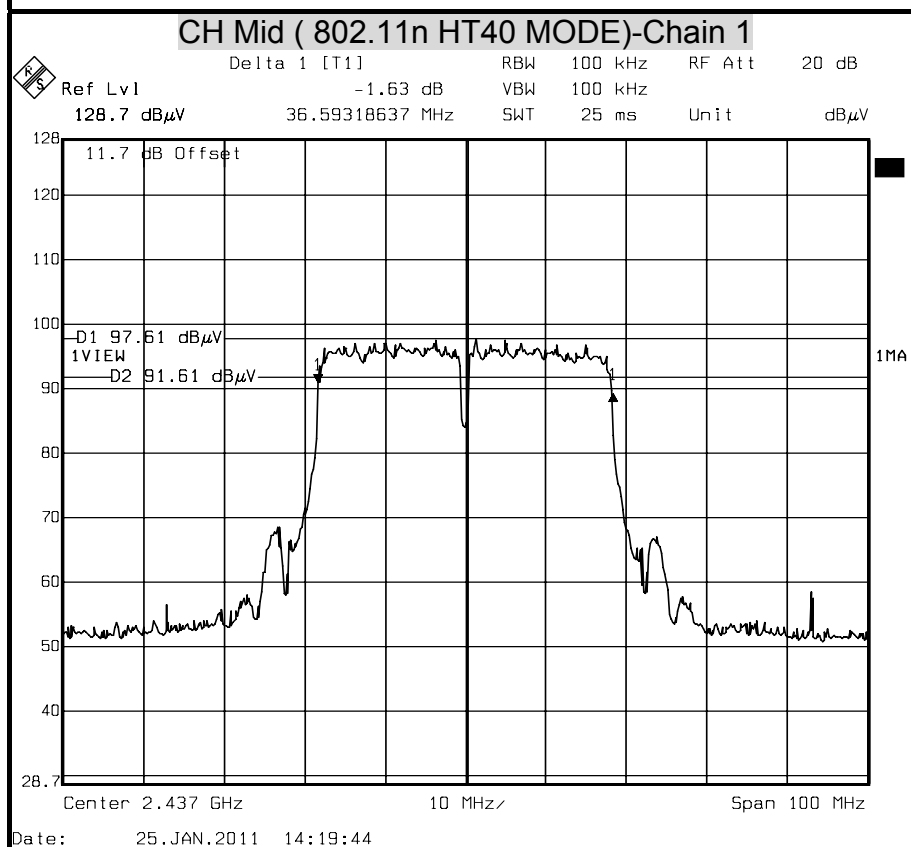
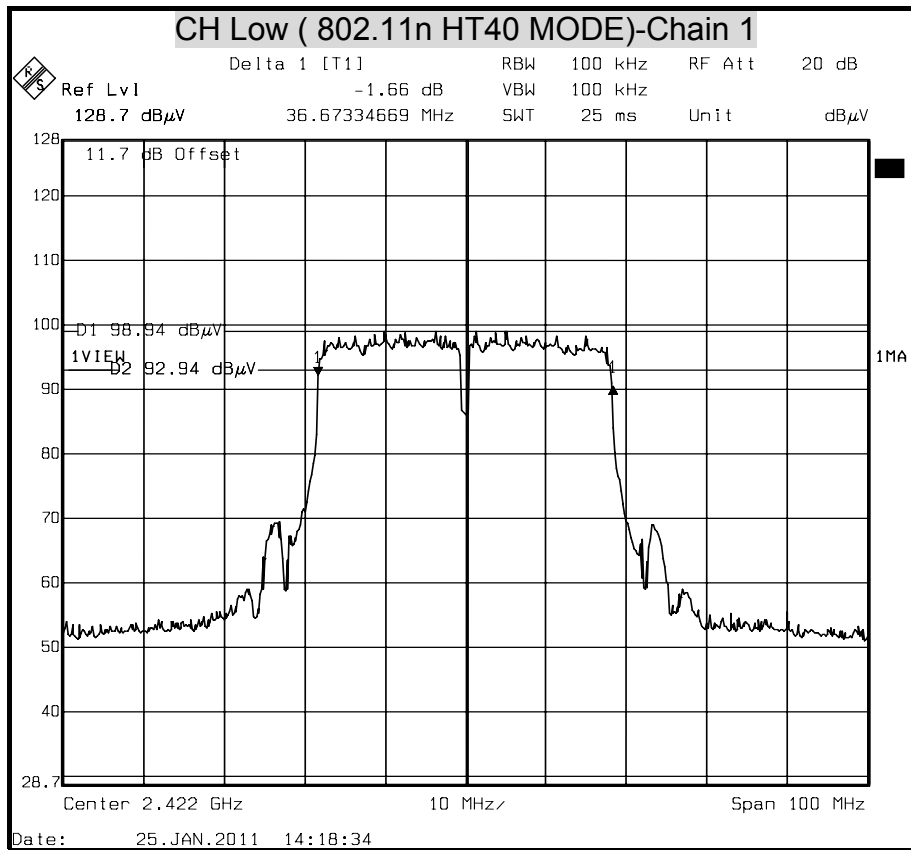

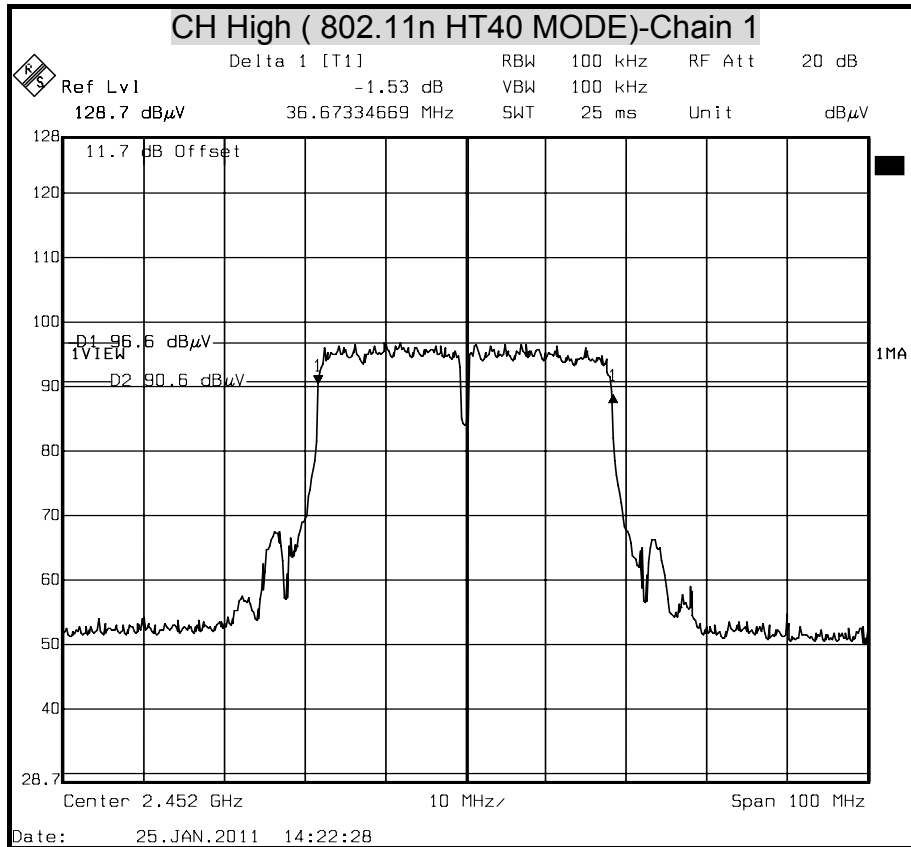



8.2 MAXIMUM PEAK OUTPUT POWER

LIMIT

§ 15.247(b) The maximum peak output power of the intentional radiator shall not exceed the following :

§ 15.247(b) (3) For systems using digital modulation in the 902-928 MHz, 2400-2483.5 MHz, and 5725-5850 MHz bands : 1 watt.

§ 15.247(b) (4) Except as shown in paragraphs (c) of this section , if transmitting antennas of directional gain greater than 6 dBi are used the peak output power from the intentional radiator shall be reduced below the stated values in paragraphs (b)(1) or (b)(2), and (b)(3) of this section , as appropriate, by the amount in dB that the directional gain of the antenna exceeds 6 dBi.

TEST EQUIPMENTS

Name of Equipment	Manufacturer	Model	Serial Number	Calibration Due
Power Meter	Anritsu	ML2487A	6K00003888	MAY. 11, 2011

TEST SETUP

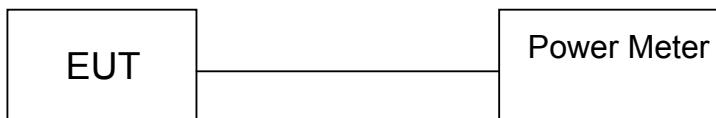

TEST PROCEDURE

Connect the EUT to spectrum analyzer, set the center frequency of the spectrum analyzer to the channel center frequency. Set the RBW to 1MHz and VBW to 3MHz.

Set sweep time=auto

Use detector max peak mode

Measurement of Digital Transmission Systems Operating under Section 15.247

TEST RESULTS

No non-compliance noted



IEEE 802.11b mode (Chain 0)

Channel	Channel Frequency (MHz)	Peak Power (dBm)	Peak Power Limit (dBm)	Margin (dBm)	Pass / Fail
Low	2412	19.01	30	-10.99	PASS
Middle	2437	18.64	30	-11.36	PASS
High	2462	18.05	30	-11.95	PASS

NOTE : 1. At final test to get the worst-case emission at 11Mbps.
 2. The cable assembly insertion loss of 11.7dB (including 10 dB pad and 1.7 dB cable) was
 Entered as an offset in the spectrum analyzer to allow for direct reading of power.

IEEE 802.11g mode (Chain 0)

Channel	Channel Frequency (MHz)	Peak Power (dBm)	Peak Power Limit (dBm)	Margin (dBm)	Pass / Fail
Low	2412	18.73	30	-11.27	PASS
Middle	2437	18.31	30	-11.69	PASS
High	2462	17.68	30	-12.32	PASS

NOTE : 1. At final test to get the worst-case emission at 6Mbps.
 2. The cable assembly insertion loss of 11.7dB (including 10 dB pad and 1.7 dB cable) was
 Entered as an offset in the spectrum analyzer to allow for direct reading of power.

**TOTAL GAIN**

Array Gain=10*LOG((10^(ANTENNA A/10)+10^(ANTENNA B/10)))=8.01

Limit=30-(8.01-6)=27.99 dBm

IEEE 802.11n HT20 mode(Two TX)

Channel	Channel Frequency (MHz)	Peak Power (dBm)		Peak Power Total (dBm)	Peak Power Limit (dBm)	Margin (dBm)	Pass / Fail
		Chain 0	Chain 1				
Low	2412	16.35	18.11	20.33	27.99	-7.66	PASS
Middle	2437	15.28	17.73	19.69	27.99	-8.30	PASS
High	2462	14.63	17.32	19.19	27.99	-8.80	PASS

- NOTE :**
1. At final test to get the worst-case emission at 13Mbps.
 2. The cable assembly insertion loss of 11.7dB (including 10 dB pad and 1.7 dB cable) was Entered as an offset in the spectrum analyzer to allow for direct reading of power.

IEEE 802.11n HT40 mode (Two TX)

Channel	Channel Frequency (MHz)	Peak Power (dBm)		Peak Power Total (dBm)	Peak Power Limit (dBm)	Margin (dBm)	Pass / Fail
		Chain 0	Chain 1				
Low	2422	15.05	17.17	19.25	27.99	-8.74	PASS
Middle	2437	14.99	17.59	19.49	27.99	-8.50	PASS
High	2452	14.66	16.28	18.56	27.99	-9.43	PASS

- NOTE :**
1. At final test to get the worst-case emission at 27Mbps.
 2. The cable assembly insertion loss of 11.7dB (including 10 dB pad and 1.7 dB cable) was Entered as an offset in the spectrum analyzer to allow for direct reading of power.



IEEE 802.11b mode

Average Power Data

Channel	Channel Frequency (MHz)	Average Power (dBm)
Low	2412	16.80
Middle	2437	16.43
High	2462	15.82

IEEE 802.11g mode

Average Power Data

Channel	Channel Frequency (MHz)	Average Power (dBm)
Low	2412	9.13
Middle	2437	8.66
High	2462	8.08

IEEE 802.11n HT20 mode

Average Power Data

Channel	Channel Frequency (MHz)	Average Power Chain A (dBm)	Average Power Chain B (dBm)
Low	2412	7.04	9.54
Middle	2437	6.63	9.09
High	2462	5.90	8.45

IEEE 802.11n HT40 mode

Average Power Data

Channel	Channel Frequency (MHz)	Average Power Chain A (dBm)	Average Power Chain B (dBm)
Low	2422	6.32	8.83
Middle	2437	6.04	8.70
High	2452	5.68	8.26



8.3 MAXIMUM PERMISSIBLE EXPOSURE

According to FCC 1.1310 : The criteria listed in the following table shall be used to evaluate the environment impact of human exposure to radio frequency (RF) radiation as specified in 1.1307(b) LIMITS FOR MAXIMUM PERMISSIBLE EXPOSURE (MPE)

Frequency Range (MHz)	Electric Field Strength (V/m)	Magnetic Field Strength (A/m)	Power Density (mW/cm ²)	Average Time
(A) Limits for Occupational / Control Exposures				
300-1,500	--	--	F/300	6
1,500-100,000	--	--	5	6
(B) Limits for General Population / Uncontrol Exposures				
300-1,500	--	--	F/1500	6
1,500-100,000	--	--	1	30

CALCULATIONS

Given $E = \frac{\sqrt{30 \times P \times G}}{d}$ & $S = \frac{E^2}{3770}$

Where E = Field strength in Volts / meter

P = Power in Watts

G = Numeric antenna gain

d = Distance in meters

S = Power density in milliwatts / square centimeter

Combining equations and re-arranging the terms to express the distance as a function of the remaining variables yields:

$$S = \frac{30 \times P \times G}{3770d^2}$$

Changing to units of mW and cm, using:

$$P (mW) = P (W) / 1000 \text{ and}$$

$$d (cm) = d(m) / 100$$

Yields

$$S = \frac{30 \times (P/1000) \times G}{3770 \times (d/100)^2} = 0.0796 \times \frac{P \times G}{d^2}$$

Where d = Distance in cm

P = Power in mW

G = Numeric antenna gain

S = Power density in mW / cm²



LIMIT

Power Density Limit, S=1.0mW/cm²

TEST RESULTS

No non-compliance noted.

$$S = \frac{30 \times (P/1000) \times G}{3770 \times (d/100)^2} = 0.0796 \times \frac{P \times G}{d^2}$$

G=5.0dBi=3.1622777mW

IEEE 802.11b =0.0796*79.61594*3.1622777/400= 0.050102

IEEE 802.11g =0.0796*74.64488*3.1622777/400= 0.046974

IEEE 802.11n HT20 =0.0796*107.8662*3.1622777/400= 0.067879

IEEE 802.11n HT40 =0.0796*88.96169*3.1622777/400= 0.055983

Mode	Minimum separation distance (cm)	Output Power (dBm)	Output Power (mw)	Antenna Gain (dBi)	Power Density Limit (mW/cm ²)	Power Density at 20cm (mW/cm ²)
IEEE 802.11b	20	19.01	79.62	5.00	1.00	0.050102
IEEE 802.11g	20	18.73	74.64	5.00	1.00	0.046974
IEEE 802.11n HT20	20	20.33	107.87	5.00	1.00	0.067879
IEEE 802.11n HT40	20	19.49	88.96	5.00	1.00	0.055983

REMARK: For mobile or fixed location transmitters, the maximum power density is 1.0 mW/cm² even if the calculation indicates that the power density would be larger.



8.4 POWER SPECTRAL DENSITY

LIMIT

§ 15.247(e) For digitally modulated systems, the power spectral density conducted from the intentional radiator to the antenna shall not greater than 8 dBm in any 3 kHz band during any time interval of continuous transmission.

TEST EQUIPMENTS

Name of Equipment	Manufacturer	Model	Serial Number	Calibration Due
Spectrum Analyzer	R&S	FSEK 30	835253/002	JUL. 14, 2011

TEST SETUP

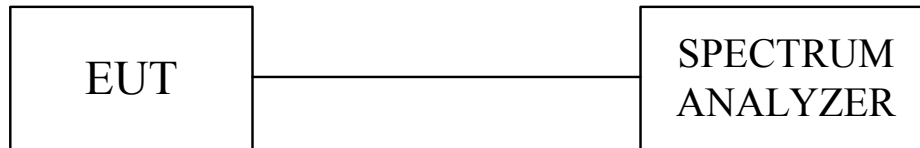

TEST PROCEDURE

The transmitter output was connected to the spectrum analyzer, the bandwidth of the fundamental frequency was measured with the spectrum analyzer using RBW=3KHz and VBW \geq RBW, set sweep time=span / 3KHz.

The power spectral density was measured and recorded.

The sweep time is allowed to be longer than span / 3KHz for a full response of the mixer in the spectrum analyzer.

TEST RESULTS

Total peak power calculation formula:
 $10 \log (10^{\wedge} (\text{Chain 0 PPSD} / 10))$.

No non-compliance noted.



TOTAL GAIN

Array Gain=10*LOG((10^(ANTENNA A/10)+10^(ANTENNA B/10)))=8.01

Limit=8-(8.01-6)=5.99 dBm

IEEE 802.11b mode

Channel	Channel Frequency (MHz)	PPSD Chain 0 (dBm)	Maximum Limit (dBm)	Margin (dB)	Pass / Fail
Low	2412	-12.80	8.00	-20.80	PASS
Middle	2437	-13.51	8.00	-21.51	PASS
High	2462	-14.19	8.00	-22.19	PASS

NOTE :

1. At final test to get the worst-case emission at 11Mbps.
2. The cable assembly insertion loss of 11.7dB (including 10 dB pad and 1.7 dB cable) was Entered as an offset in the spectrum analyzer to allow for direct reading of power.

IEEE 802.11g mode

Channel	Channel Frequency (MHz)	PPSD Chain 0 (dBm)	Maximum Limit (dBm)	Margin (dB)	Pass / Fail
Low	2412	-20.21	8.00	-28.21	PASS
Middle	2437	-20.58	8.00	-28.58	PASS
High	2462	-20.99	8.00	-28.99	PASS

NOTE :

1. At final test to get the worst-case emission at 6Mbps.
2. The cable assembly insertion loss of 11.7dB (including 10 dB pad and 1.7 dB cable) was Entered as an offset in the spectrum analyzer to allow for direct reading of power.



IEEE 802.11n HT20 mode

Channel	Channel Frequency (MHz)	PPSD(dBm)			Maximum Limit (dBm)	Margin (dB)	Pass / Fail
		Chain 0	Chain 1	Total			
Low	2412	-21.37	-19.84	-17.53	5.99	-23.52	PASS
Middle	2437	-22.21	-20.00	-17.96	5.99	-23.95	PASS
High	2462	-22.71	-21.13	-18.84	5.99	-24.83	PASS

NOTE : 1. At final test to get the worst-case emission at 13Mbps.
2. The cable assembly insertion loss of 11.7dB (including 10 dB pad and 1.7 dB cable) was Entered as an offset in the spectrum analyzer to allow for direct reading of power.

IEEE 802.11n HT40 mode

Channel	Channel Frequency (MHz)	PPSD(dBm)			Maximum Limit (dBm)	Margin (dB)	Pass / Fail
		Chain 0	Chain 1	Total			
Low	2422	-25.79	-23.76	-21.65	5.99	-27.64	PASS
Middle	2437	-26.86	-24.21	-22.33	5.99	-28.32	PASS
High	2452	-26.21	-24.58	-22.31	5.99	-28.30	PASS

NOTE : 1. At final test to get the worst-case emission at 27Mbps.
2. The cable assembly insertion loss of 11.7dB (including 10 dB pad and 1.7 dB cable) was Entered as an offset in the spectrum analyzer to allow for direct reading of power.



Combined mode

Channel		Channel Frequency (MHz)	PPSD (dBm)	Maximum Limit (dBm)	Margin (dB)	Pass / Fail
802.11n HT20 Combined mode	CH Low	2412	-19.37	5.99	-25.36	PASS
	CH Middle	2437	-19.35	5.99	-25.34	
	CH High	2462	-20.01	5.99	-26.00	
802.11n HT40 Combined mode	CH Low	2422	-21.69	5.99	-27.68	PASS
	CH Middle	2437	-21.95	5.99	-27.94	
	CH High	2452	-22.28	5.99	-28.27	



POWER SPECTRAL DENSITY (IEEE 802.11b MODE)

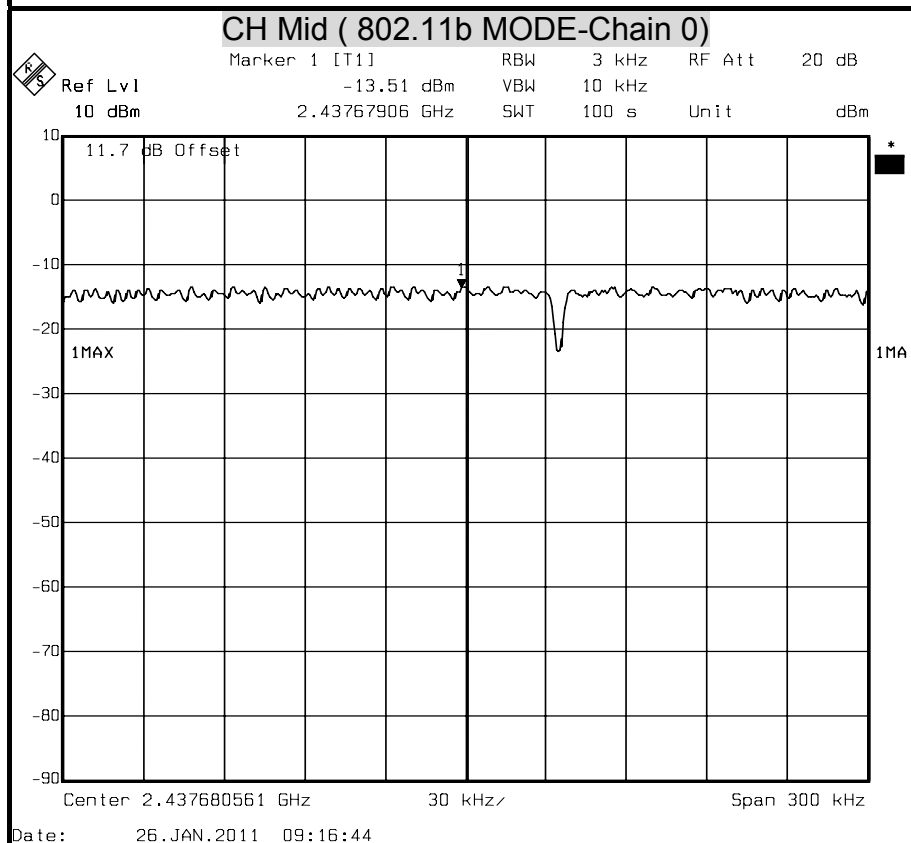
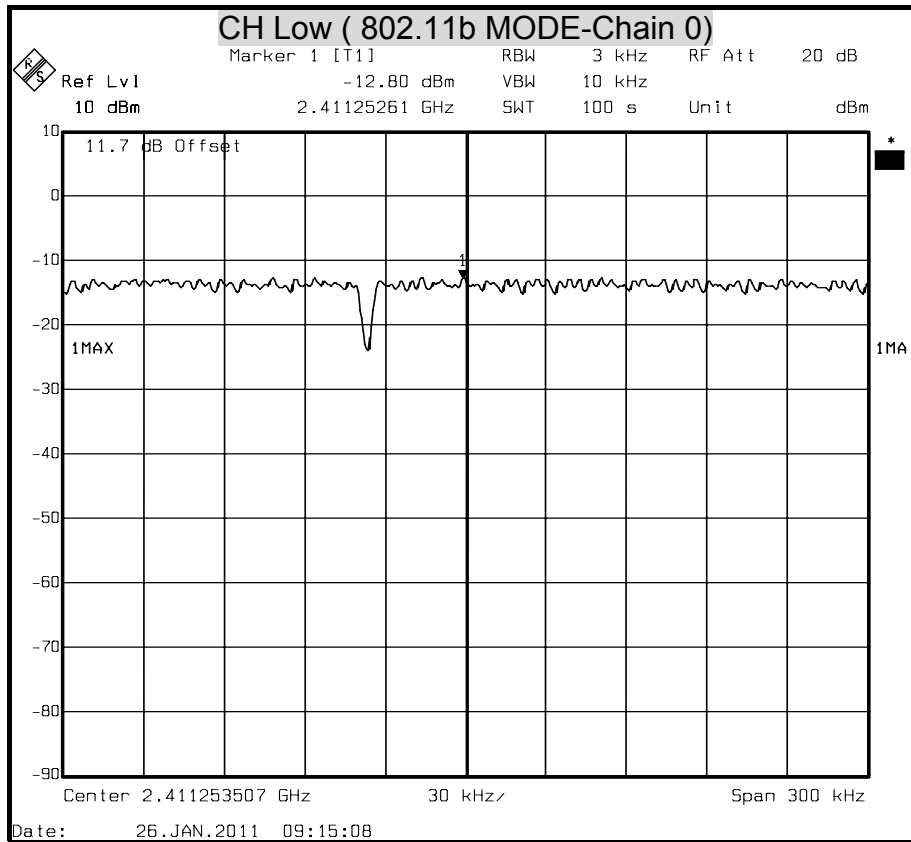

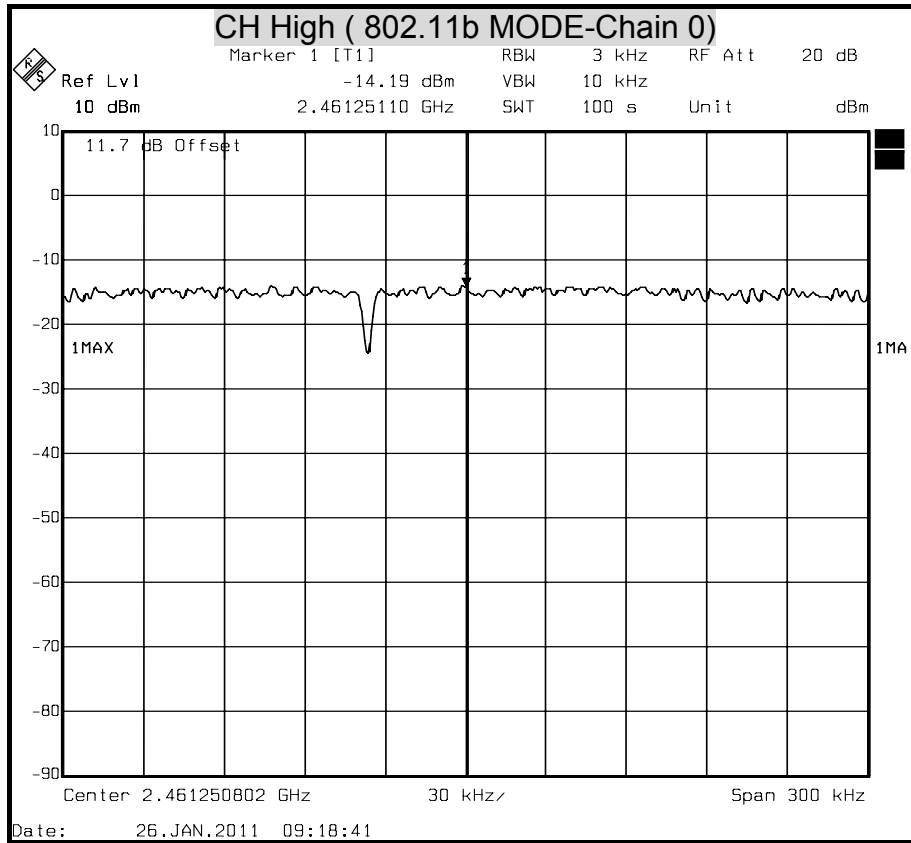



POWER SPECTRAL DENSITY (IEEE 802.11g MODE)

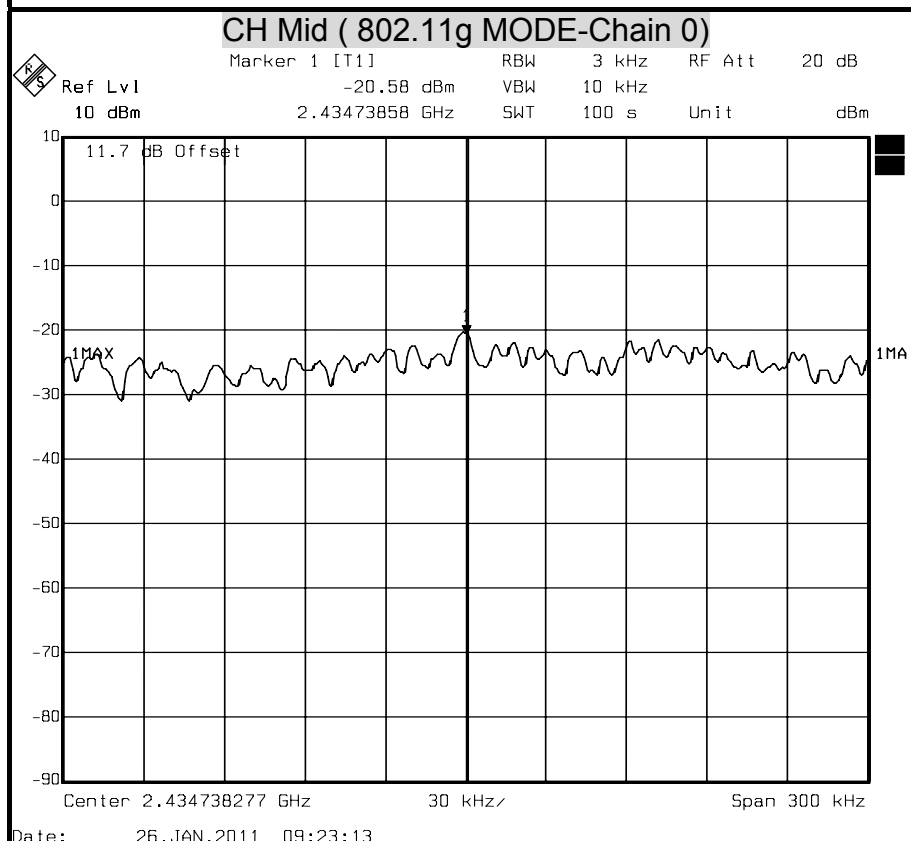
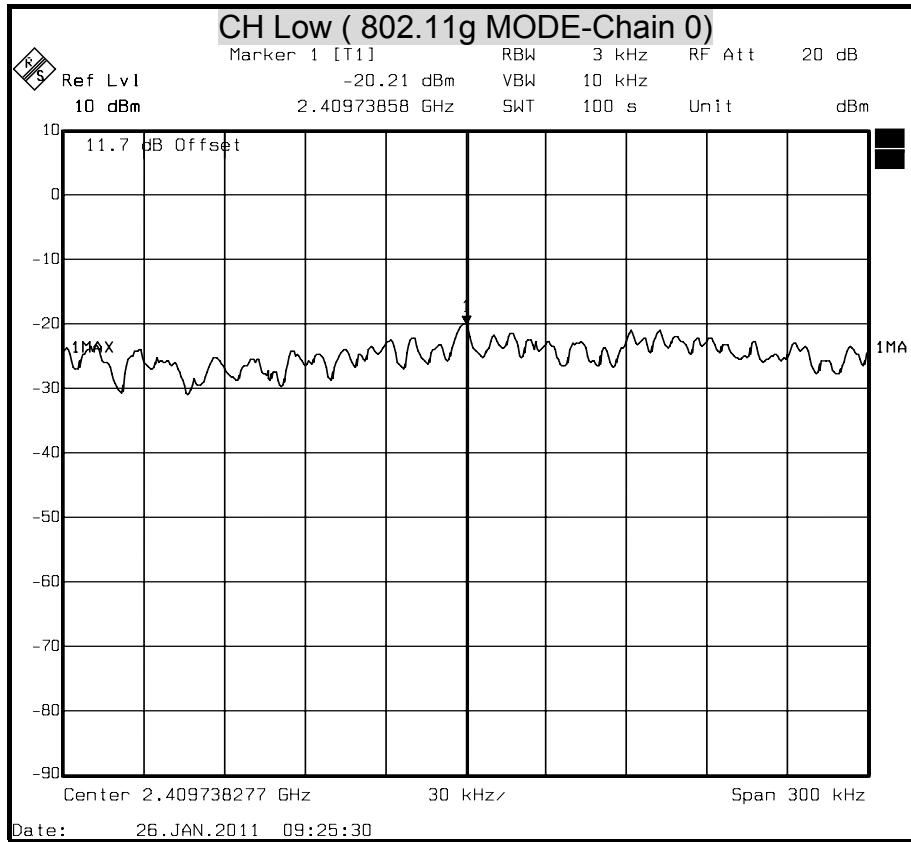

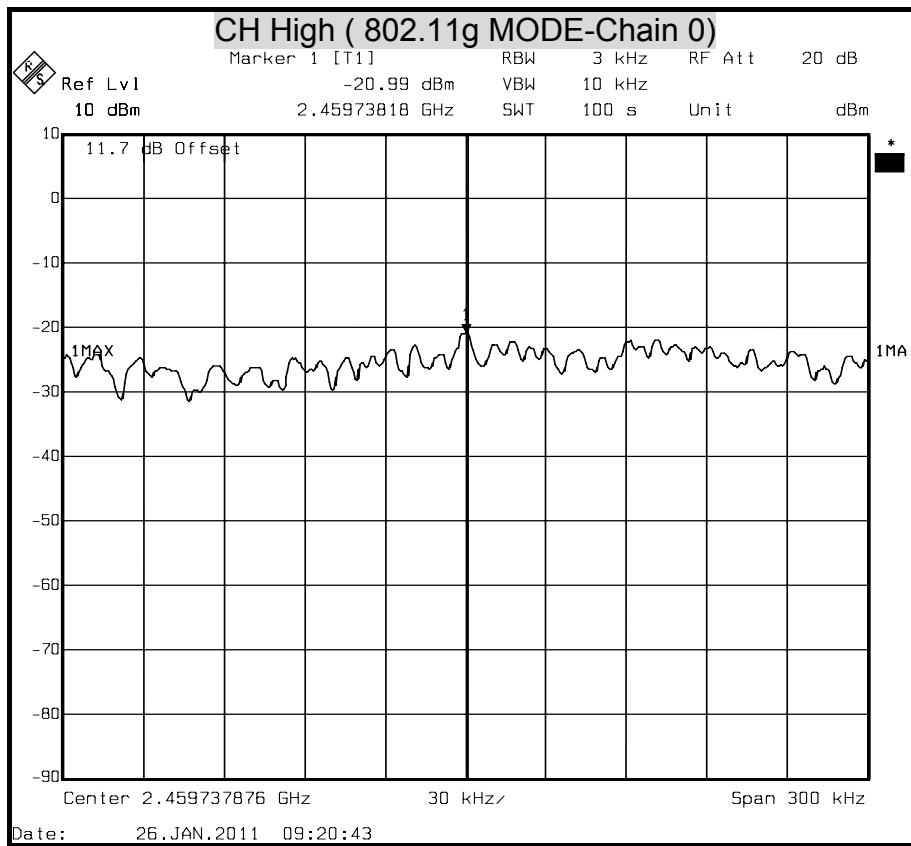



POWER SPECTRAL DENSITY (802.11n HT20 MODE)

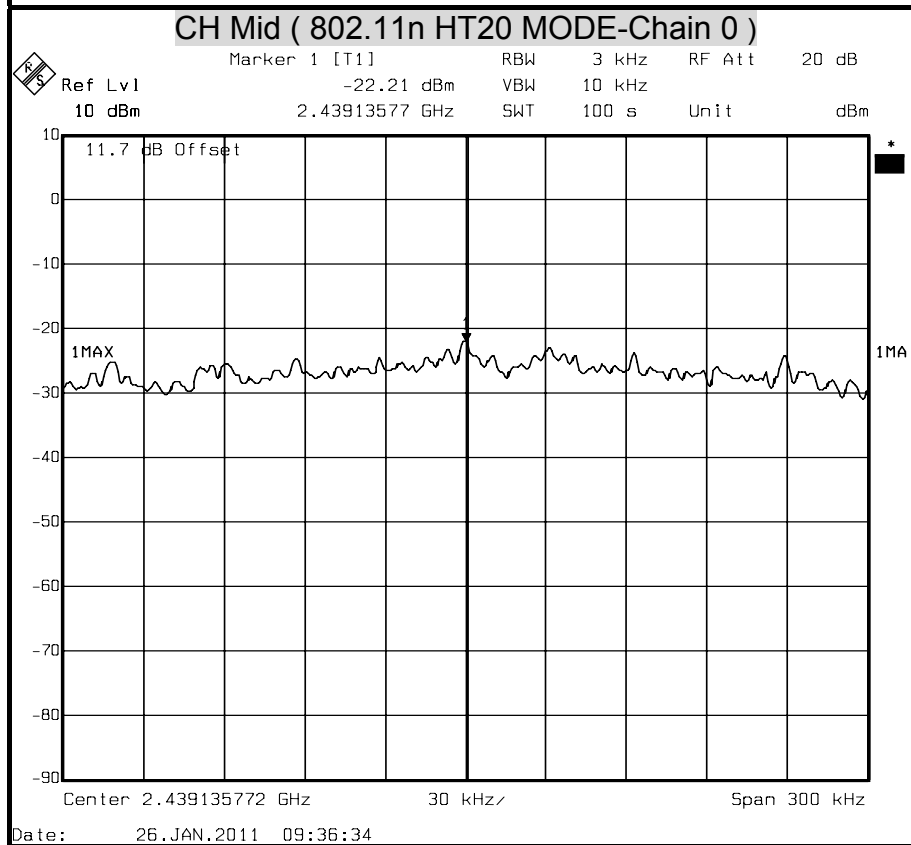
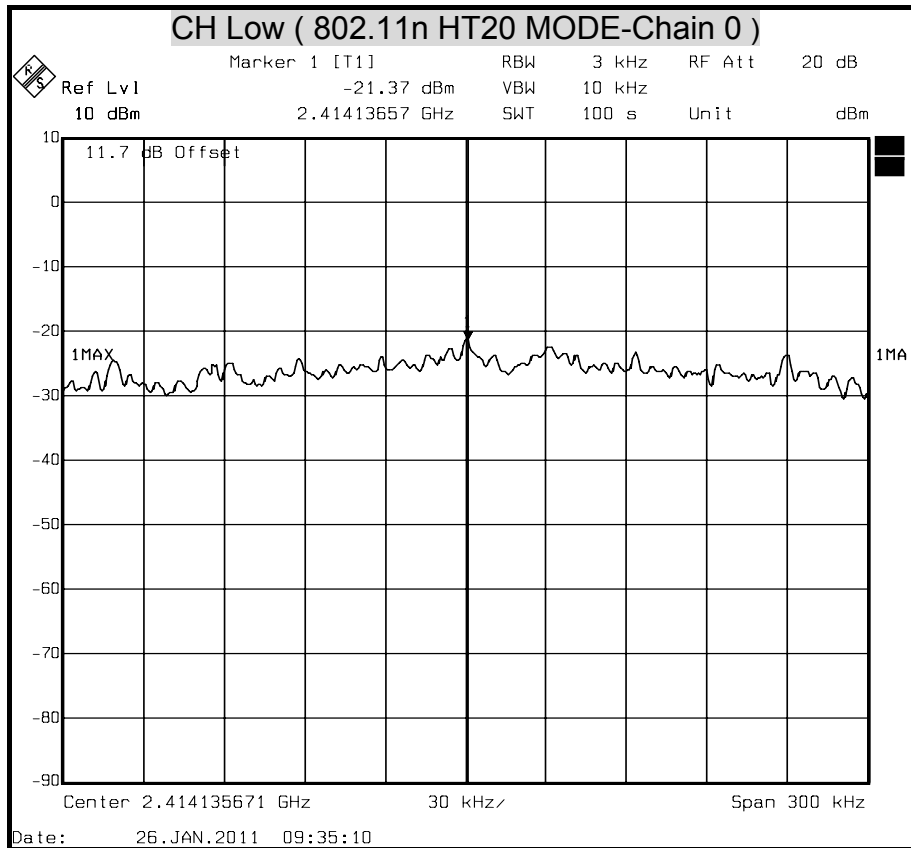

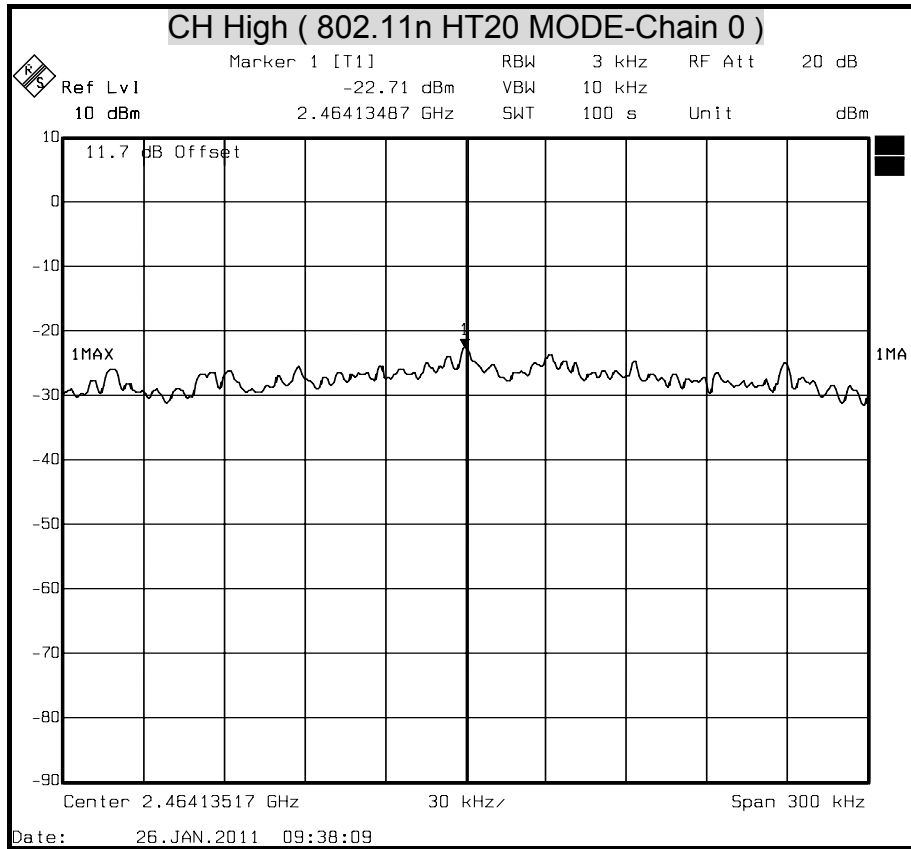



POWER SPECTRAL DENSITY (802.11n HT20 MODE)

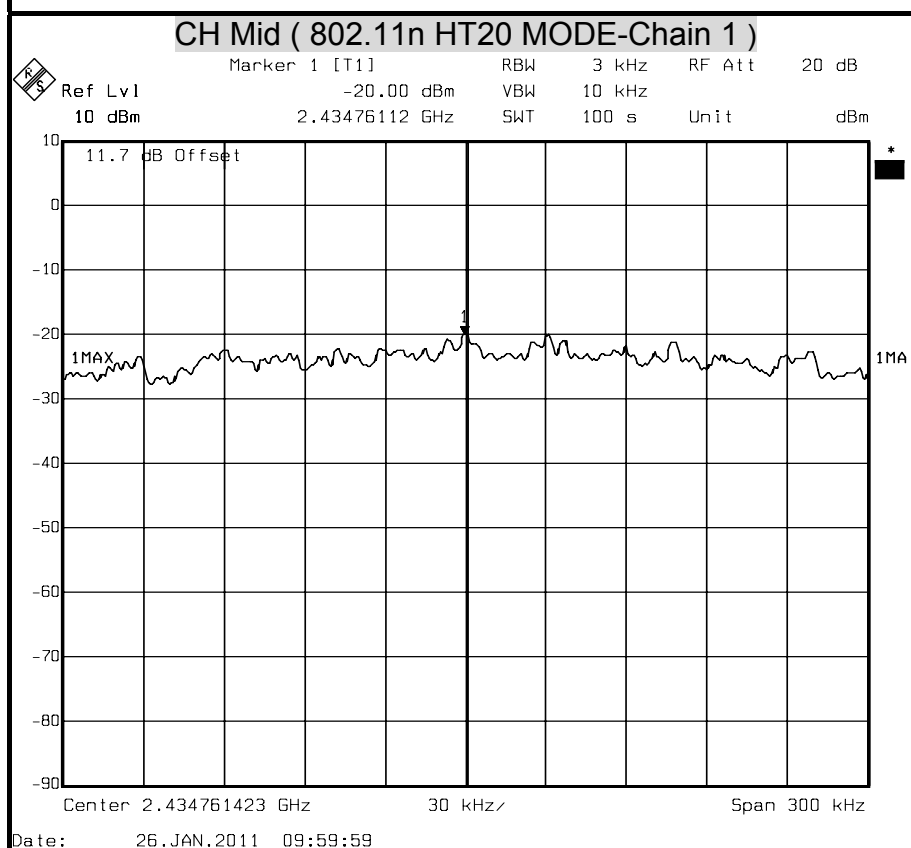
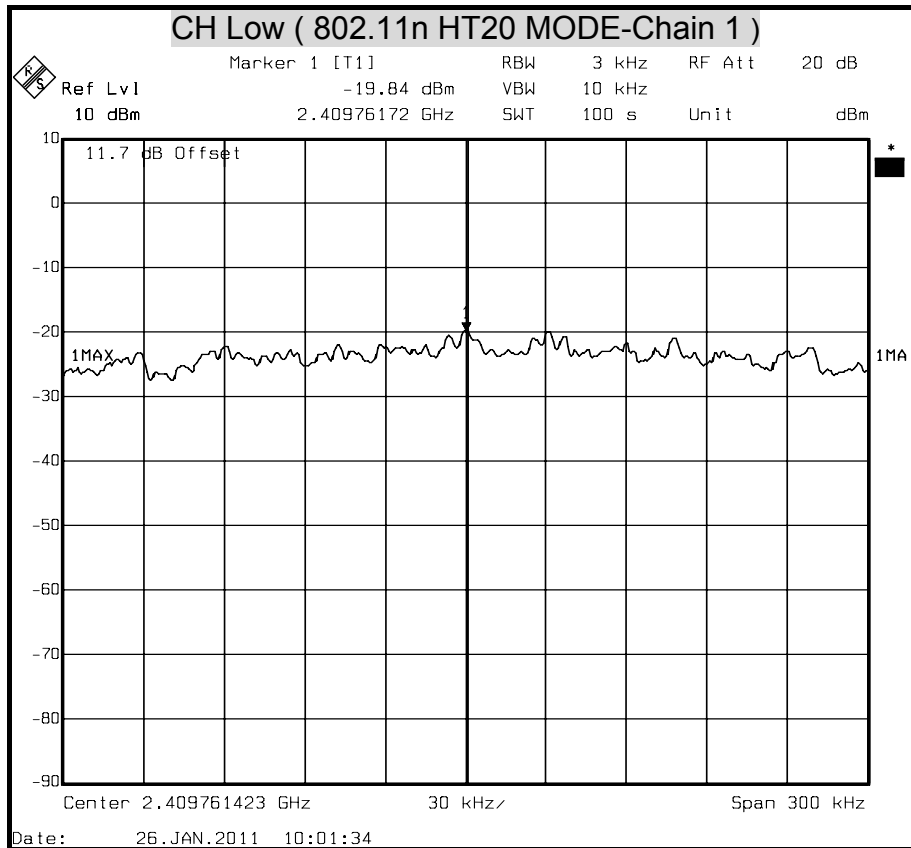

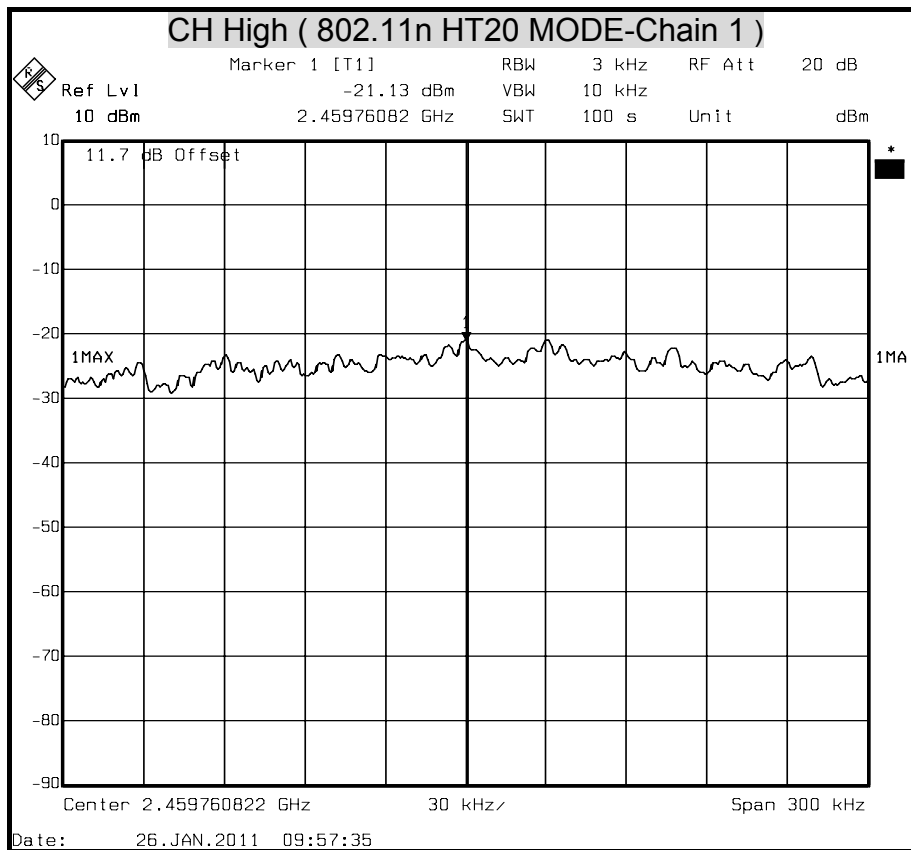



POWER SPECTRAL DENSITY (802.11n HT40 MODE)

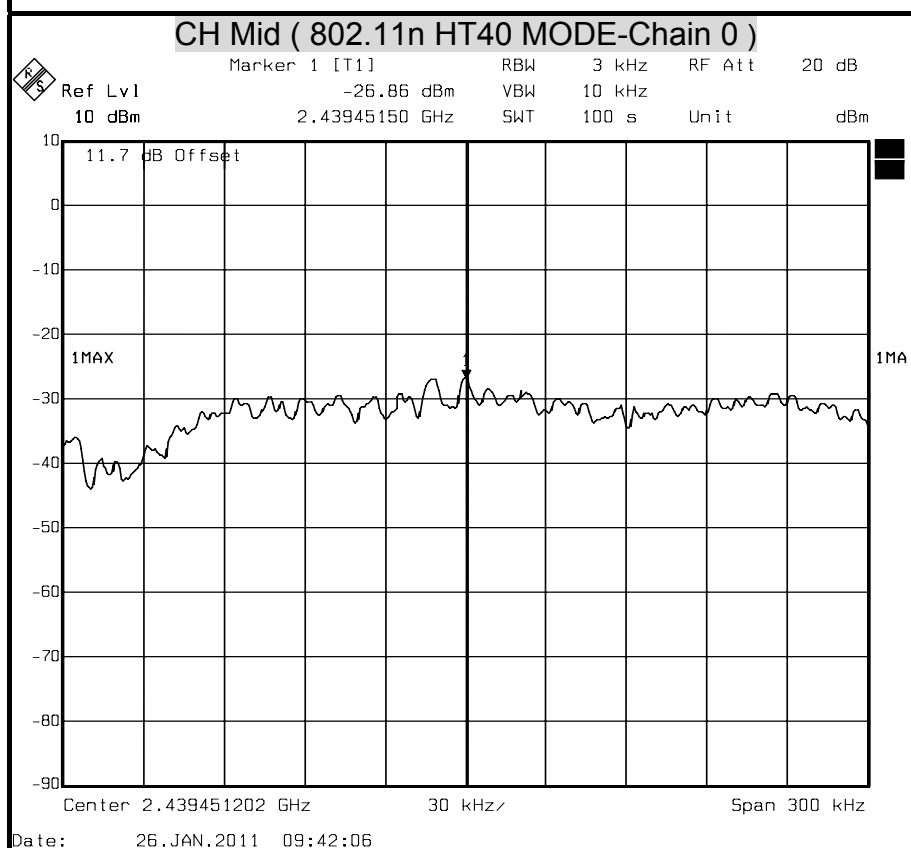
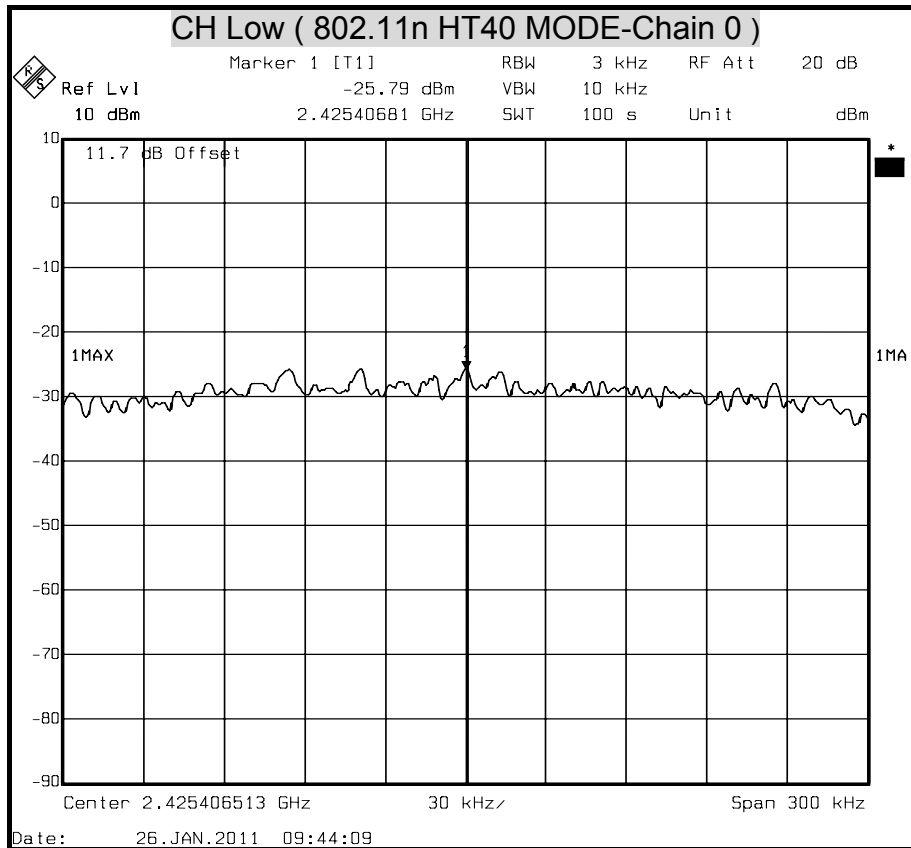

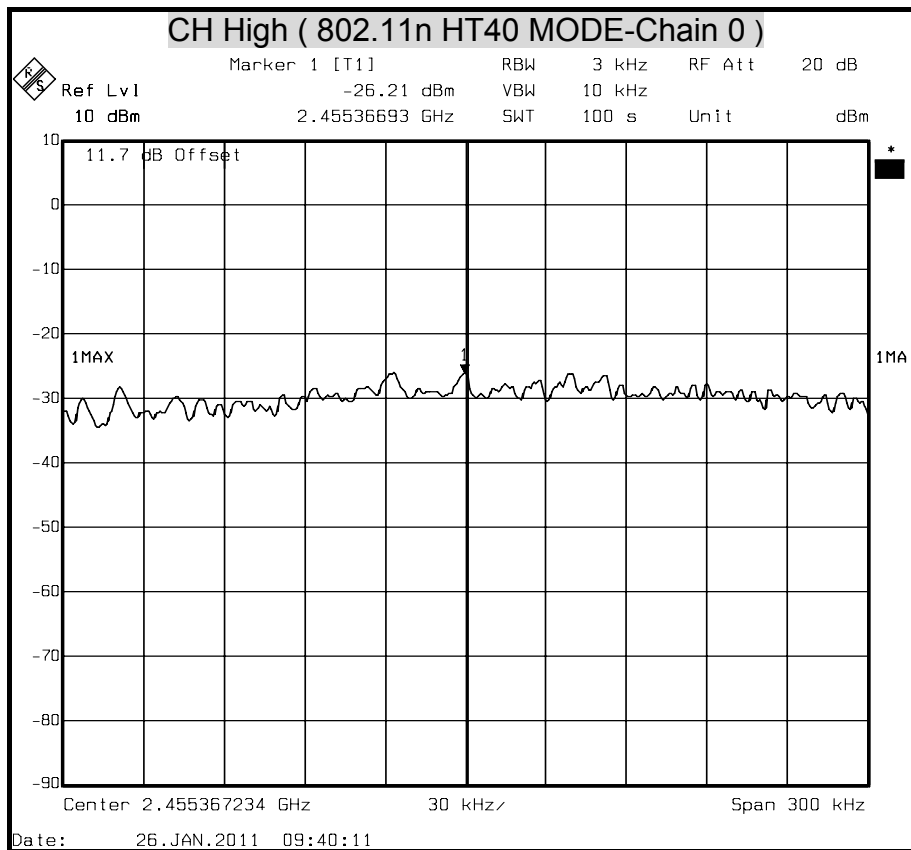



POWER SPECTRAL DENSITY (802.11n HT40 MODE)

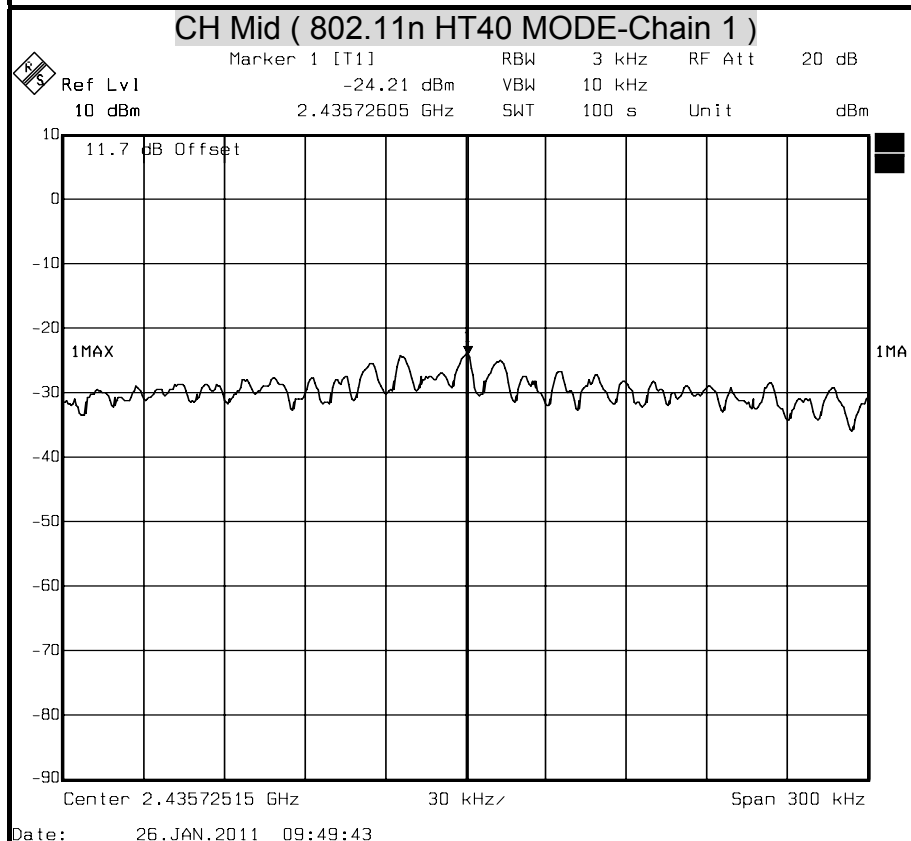
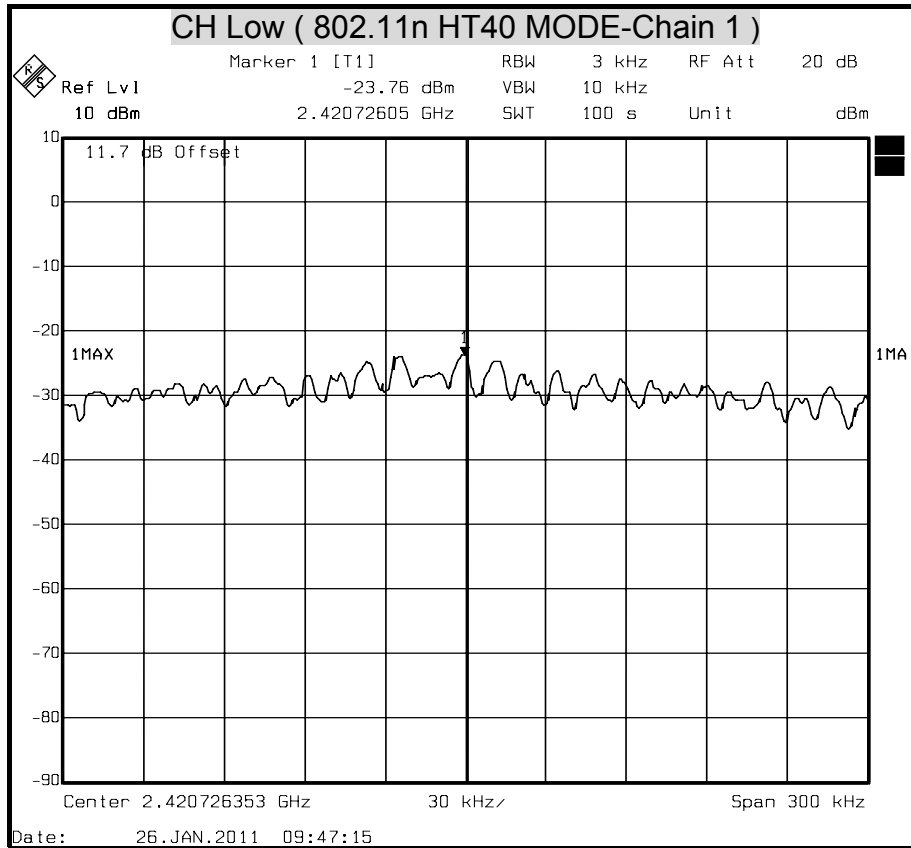

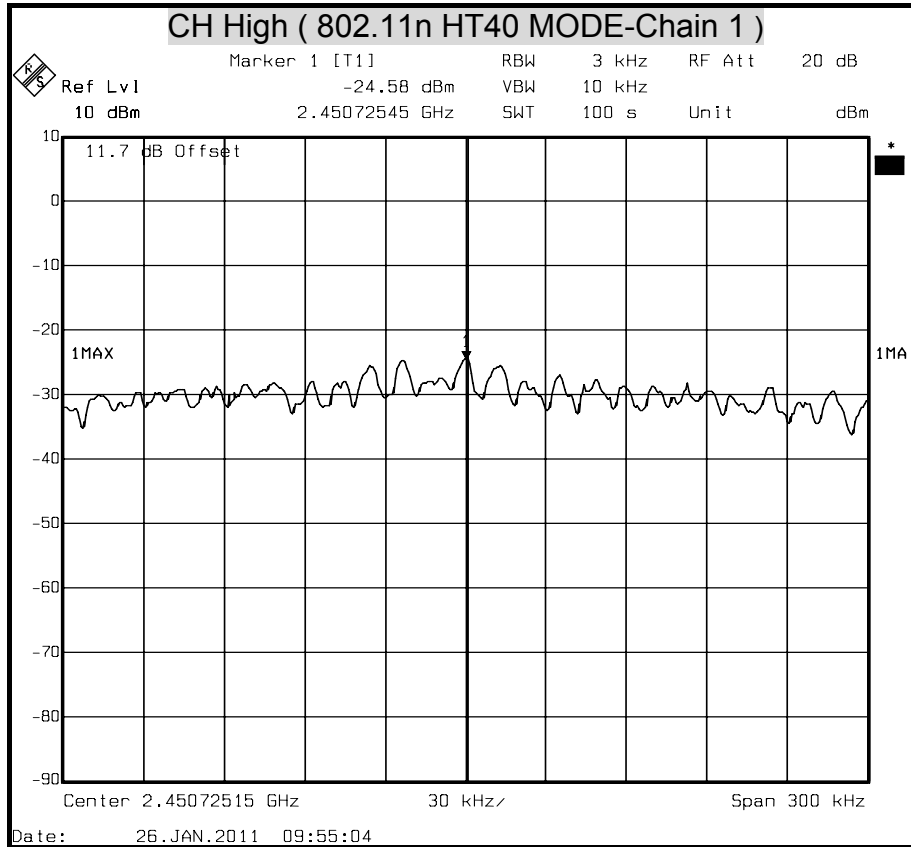



POWER SPECTRAL DENSITY (802.11n HT20 Combined MODE)

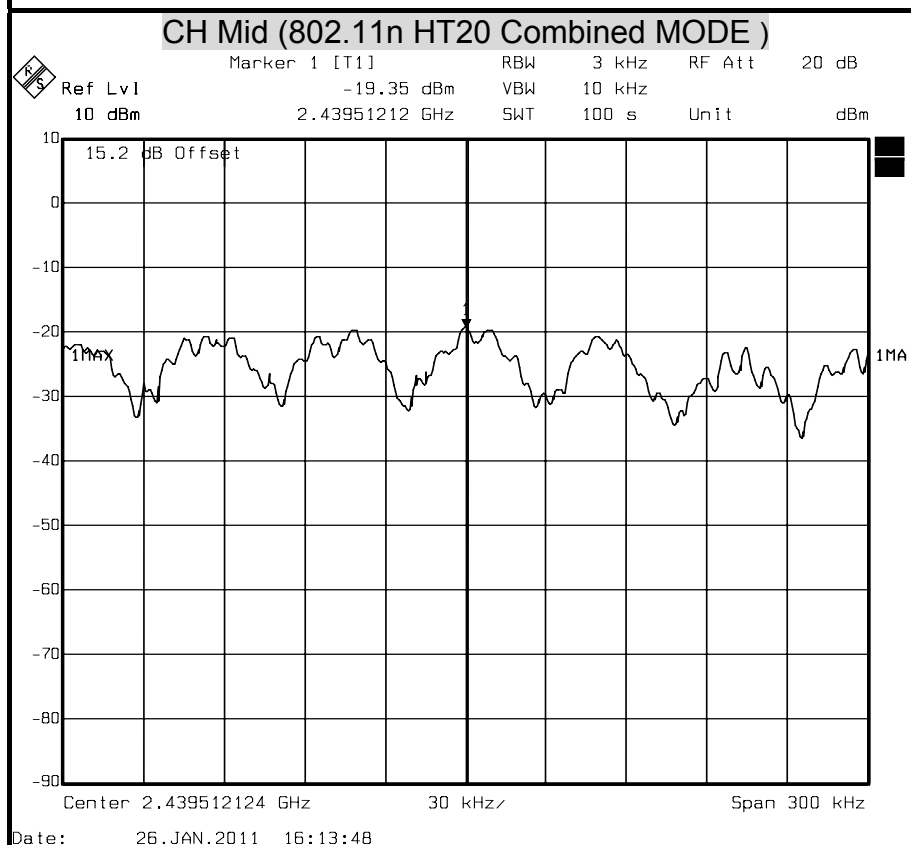
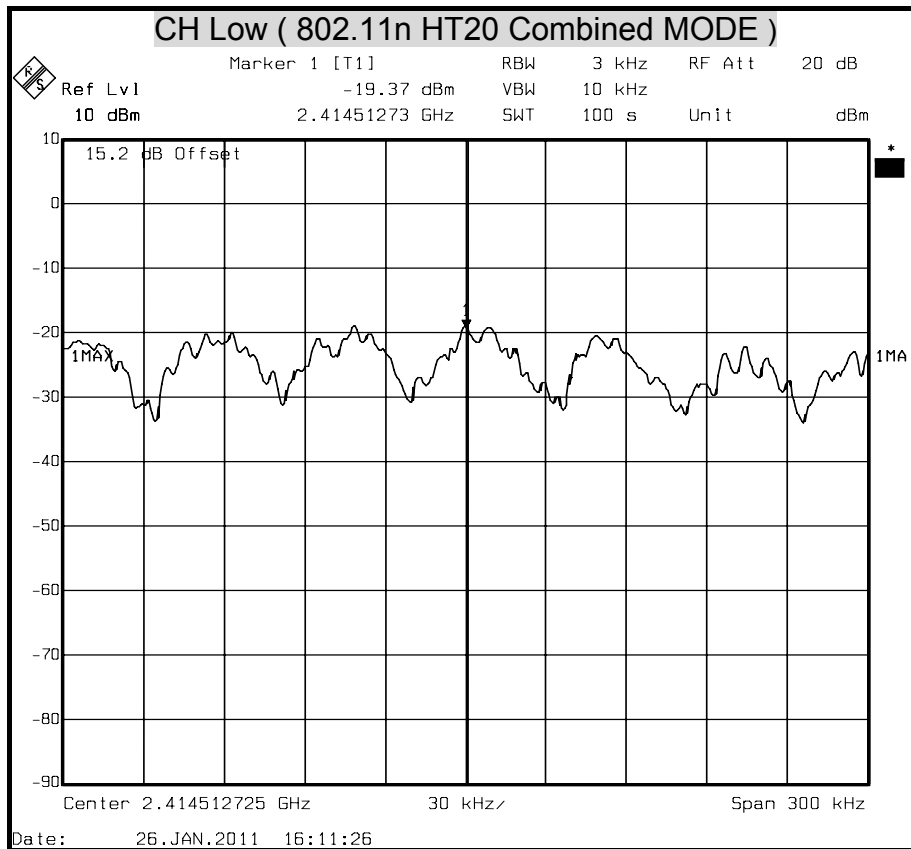

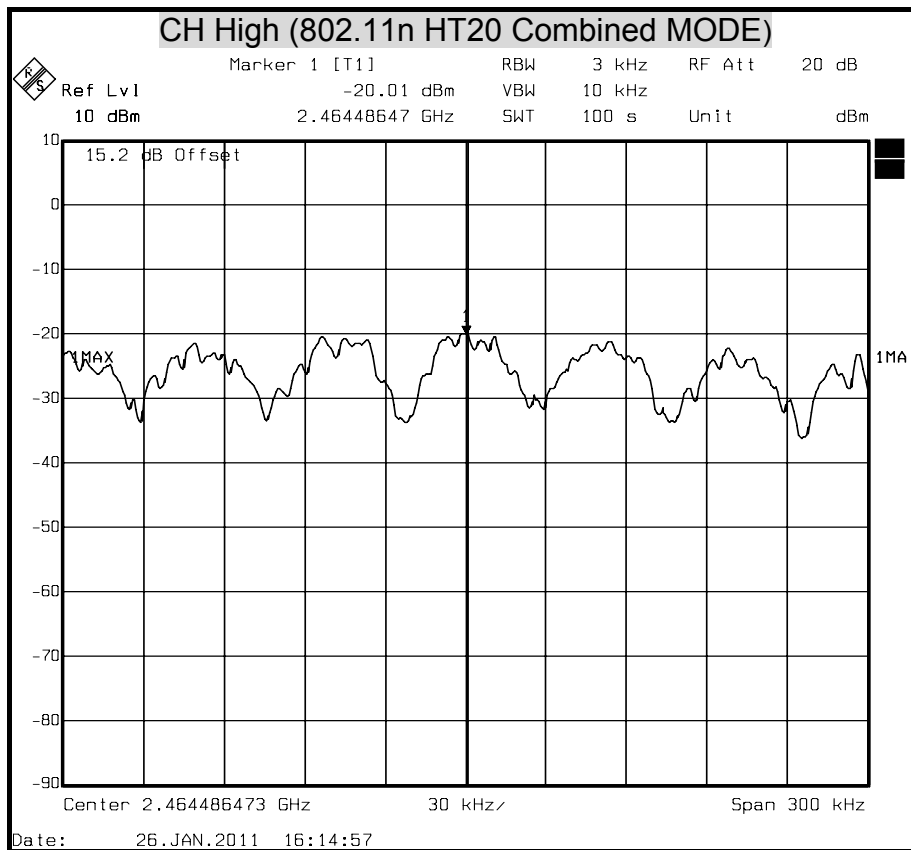



POWER SPECTRAL DENSITY (802.11n HT40 Combined MODE)

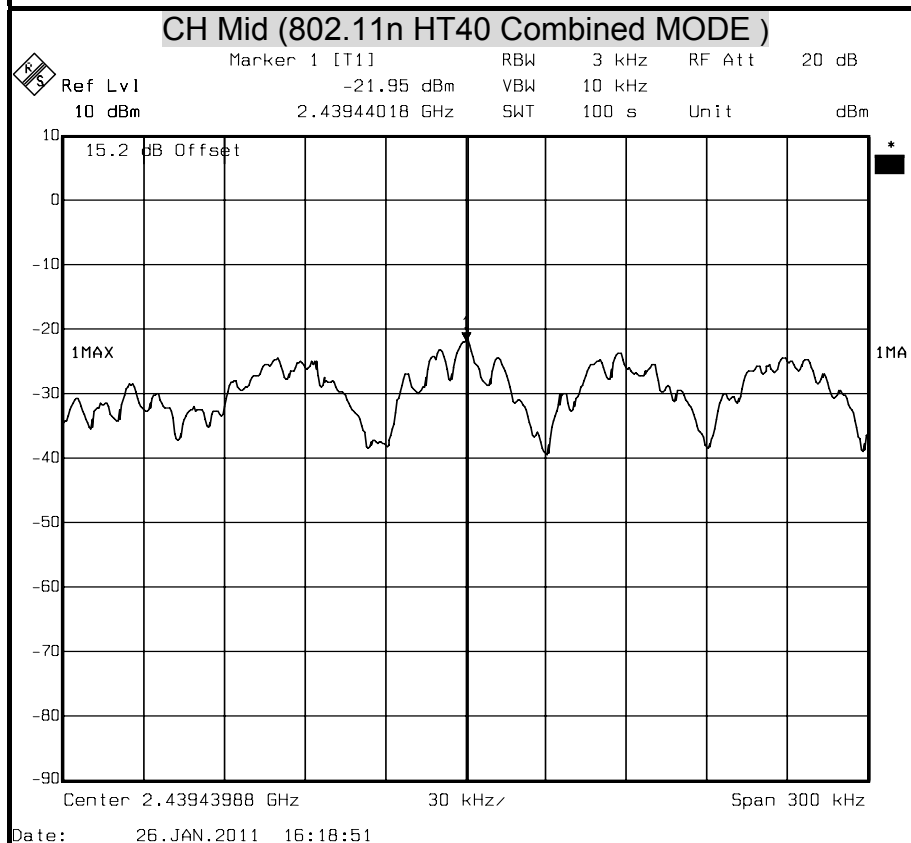
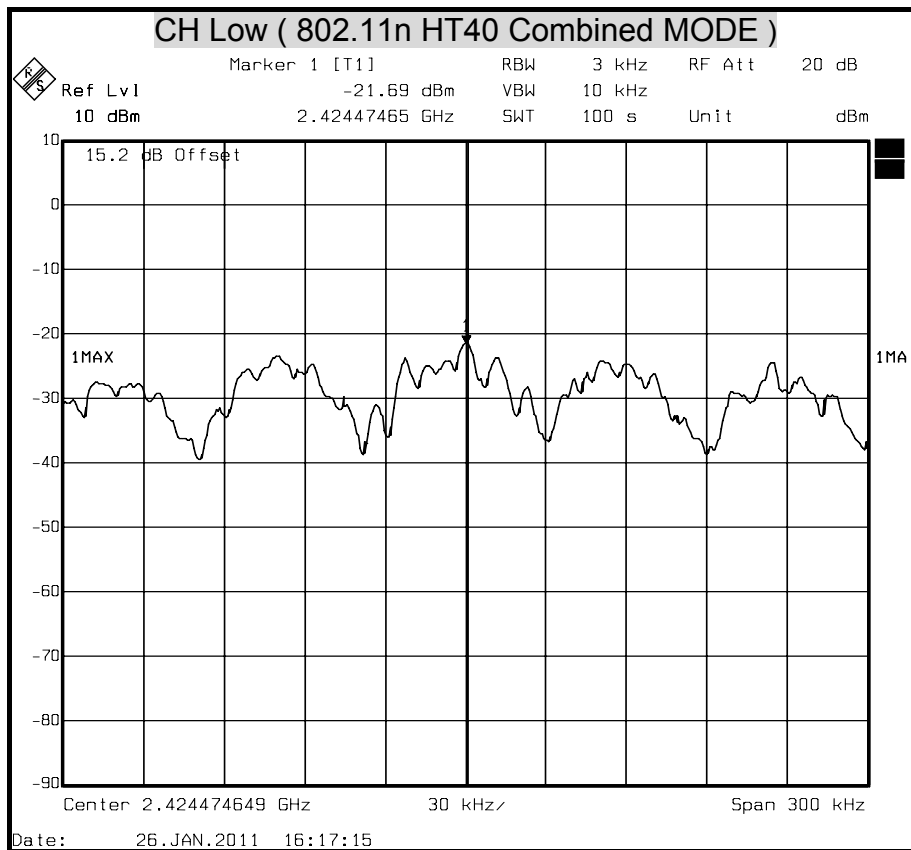

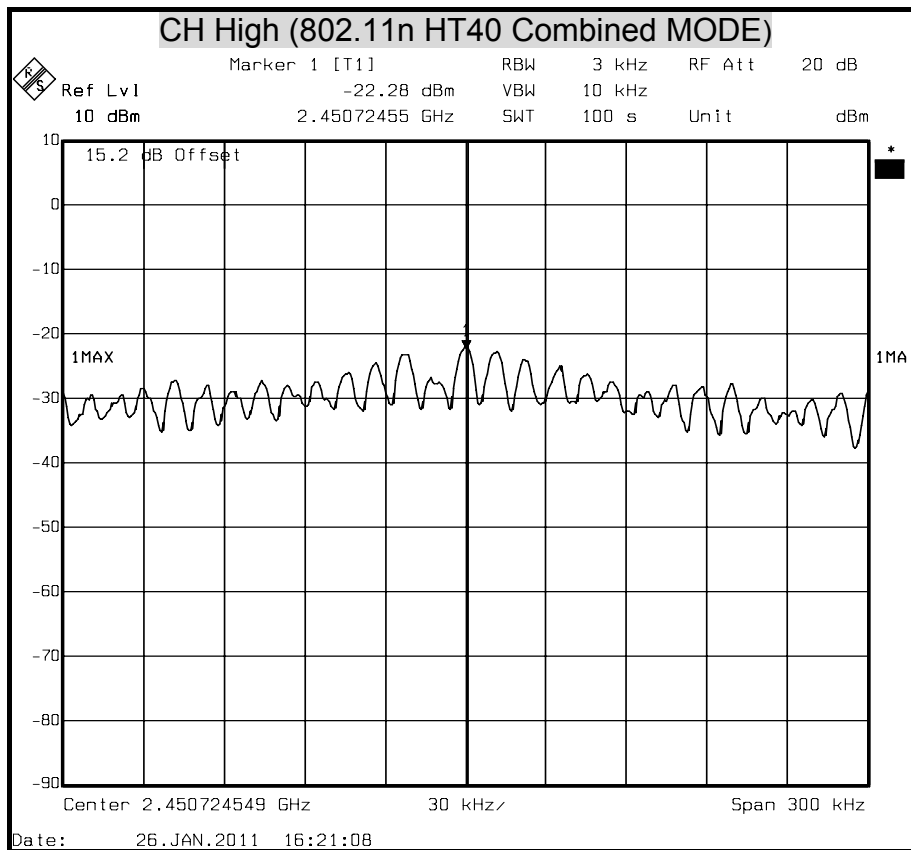



8.5 CONDUCTED SPURIOUS EMISSION

LIMITS

§ 15.247(d) In any 100 kHz bandwidth outside the frequency band in which the spread spectrum intentional radiator is operating, the radio frequency power that is produced by the intentional radiator shall be at least 20 dB below that in the 100 kHz bandwidth within the band that contains the highest level of the desired power, based on either an RF conducted or a radiated measurement. Attenuation below the general limits specified in § 15.209(a) is not required. In addition, radiated emissions which fall in the restricted bands, as defined in § 15.205(a), must also comply with the radiated emission limits specified in § 15.209(a) (see § 15.205(c)).

TEST PROCEDURE

The transmitter output is connected to a spectrum analyzer. The resolution bandwidth is set to 100 kHz. The video bandwidth is set to 100 kHz.

The spectrum from 30 MHz to 26.5 GHz is investigated with the transmitter set to the lowest, middle, and highest channels in the 2.4 GHz band.

TEST SETUP

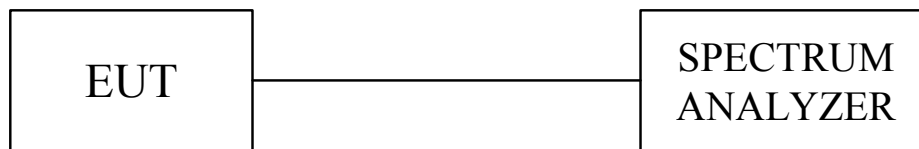

TEST RESULTS

No non-compliance noted.



802.11b Mode

CH Low

Frequency	Offset	Reading	Level	Limit	Margin
(MHz)	(dB)	(dBuV)	(dBuV)	(dBuV)	(dB)
2412	11.7	99.26	110.96	N/A	N/A
2400	11.7	60.25	71.95	90.96	-19.01
2601.22244	11.7	52.86	64.56	90.96	-26.40
6626.25251	11.7	45.65	57.35	90.96	-33.61

CH Mid

Frequency	Offset	Reading	Level	Limit	Margin
(MHz)	(dB)	(dBuV)	(dBuV)	(dBuV)	(dB)
2437	11.7	98.65	110.35	N/A	N/A
2400	11.7	42.77	54.47	90.35	-35.88
2601.22244	11.7	53.66	65.36	90.35	-24.99
6941.78357	11.7	44.51	56.21	90.35	-34.14

CH High

Frequency	Offset	Reading	Level	Limit	Margin
(MHz)	(dB)	(dBuV)	(dBuV)	(dBuV)	(dB)
2462	11.7	98.72	110.42	N/A	N/A
2400	11.7	43.36	55.06	90.42	-35.36
2601.22244	11.7	53.91	65.61	90.42	-24.81
6955.91182	11.7	45.67	57.37	90.42	-33.05

802.11g Mode

CH Low

Frequency	Offset	Reading	Level	Limit	Margin
(MHz)	(dB)	(dBuV)	(dBuV)	(dBuV)	(dB)
2412	11.7	87.82	99.52	N/A	N/A
2400	11.7	57.46	69.16	79.52	-10.36
2601.22244	11.7	53.50	65.2	79.52	-14.32
6955.91182	11.7	44.19	55.89	79.52	-23.63

CH Mid

Frequency	Offset	Reading	Level	Limit	Margin
(MHz)	(dB)	(dBuV)	(dBuV)	(dBuV)	(dB)
2437	11.7	87.75	99.45	N/A	N/A
2400	11.7	40.65	52.35	79.45	-27.10
2601.22244	11.7	54.09	65.79	79.45	-13.66
6847.59519	11.7	44.70	56.4	79.45	-23.05

CH High

Frequency	Offset	Reading	Level	Limit	Margin
(MHz)	(dB)	(dBuV)	(dBuV)	(dBuV)	(dB)
2462	11.7	87.30	99	N/A	N/A
2400	11.7	41.66	53.36	79.00	-25.64
2601.22244	11.7	54.16	65.86	79.00	-13.14
6955.91182	11.7	44.43	56.13	79.00	-22.87



802.11n HT20 Mode Chain 0

CH Low

Frequency	Offset	Reading	Level	Limit	Margin
(MHz)	(dB)	(dBuV)	(dBuV)	(dBuV)	(dB)
2412	11.7	86.52	98.22	N/A	N/A
2400	11.7	55.98	67.68	78.22	-10.54
2601.22244	11.7	54.59	66.29	78.22	-11.93
6955.91182	11.7	44.80	56.5	78.22	-21.72

CH Mid

Frequency	Offset	Reading	Level	Limit	Margin
(MHz)	(dB)	(dBuV)	(dBuV)	(dBuV)	(dB)
2437	11.7	86.01	97.71	N/A	N/A
2400	11.7	41.61	53.31	77.71	-24.40
2601.22244	11.7	54.44	66.14	77.71	-11.57
6955.91182	11.7	43.77	55.47	77.71	-22.24

CH High

Frequency	Offset	Reading	Level	Limit	Margin
(MHz)	(dB)	(dBuV)	(dBuV)	(dBuV)	(dB)
2462	11.7	84.79	96.49	N/A	N/A
2400	11.7	41.60	53.3	76.49	-23.19
2601.22244	11.7	54.14	65.84	76.49	-10.65
6955.91182	11.7	44.31	56.01	76.49	-20.48

802.11n HT20 Mode Chain 1

CH Low

Frequency	Offset	Reading	Level	Limit	Margin
(MHz)	(dB)	(dBuV)	(dBuV)	(dBuV)	(dB)
2412	11.7	87.73	99.43	N/A	N/A
638.236483	11.7	50.95	62.65	79.43	-16.78
2400	11.7	56.17	67.87	79.43	-11.56
2601.22244	11.7	51.06	62.76	79.43	-16.67

CH Mid

Frequency	Offset	Reading	Level	Limit	Margin
(MHz)	(dB)	(dBuV)	(dBuV)	(dBuV)	(dB)
2437	11.7	87.81	99.51	N/A	N/A
797.7955912	11.7	54.30	66	79.51	-13.51
2400	11.7	44.04	55.74	79.51	-23.77
2601.22244	11.7	51.90	63.6	79.51	-15.91

CH High

Frequency	Offset	Reading	Level	Limit	Margin
(MHz)	(dB)	(dBuV)	(dBuV)	(dBuV)	(dB)
2462	11.7	88.51	100.21	N/A	N/A
797.7955912	11.7	51.18	62.88	80.21	-17.33
2400	11.7	44.91	56.61	80.21	-23.60
2601.22244	11.7	53.27	64.97	80.21	-15.24



802.11n HT40 Mode Chain 0

CH Low

Frequency	Offset	Reading	Level	Limit	Margin
(MHz)	(dB)	(dBuV)	(dBuV)	(dBuV)	(dB)
2422	11.7	82.26	93.96	N/A	N/A
2400	11.7	52.64	64.34	73.96	-9.62
2601.22244	11.7	55.39	67.09	73.96	-6.87
13737.47495	11.7	44.85	56.55	73.96	-17.41

CH Mid

Frequency	Offset	Reading	Level	Limit	Margin
(MHz)	(dB)	(dBuV)	(dBuV)	(dBuV)	(dB)
2437	11.7	81.21	92.91	N/A	N/A
2400	11.7	41.64	53.34	72.91	-19.57
2601.22244	11.7	55.09	66.79	33.34	33.45
6937.07415	11.7	47.37	59.07	72.91	-13.84

CH High

Frequency	Offset	Reading	Level	Limit	Margin
(MHz)	(dB)	(dBuV)	(dBuV)	(dBuV)	(dB)
2452	11.7	80.81	92.51	N/A	N/A
2400	11.7	41.12	52.82	72.51	-19.69
2601.22244	11.7	54.70	66.4	72.51	-6.11
6955.91182	11.7	47.79	59.49	72.51	-13.02

802.11n HT40 Mode Chain 1

CH Low

Frequency	Offset	Reading	Level	Limit	Margin
(MHz)	(dB)	(dBuV)	(dBuV)	(dBuV)	(dB)
2422	11.7	86.02	97.72	N/A	N/A
637.0941884	11.7	51.10	62.8	77.72	-14.92
2400	11.7	55.56	67.26	77.72	-10.46
2601.22244	11.7	53.22	64.92	77.72	-12.80

CH Mid

Frequency	Offset	Reading	Level	Limit	Margin
(MHz)	(dB)	(dBuV)	(dBuV)	(dBuV)	(dB)
2437	11.7	84.37	96.07	N/A	N/A
797.7955912	11.7	54.74	66.44	76.07	-9.63
2400	11.7	44.50	56.2	76.07	-19.87
2601.22244	11.7	52.96	64.66	76.07	-11.41

CH High

Frequency	Offset	Reading	Level	Limit	Margin
(MHz)	(dB)	(dBuV)	(dBuV)	(dBuV)	(dB)
2452	11.7	84.43	96.13	N/A	N/A
797.7955912	11.7	49.56	61.26	76.13	-14.87
2400	11.7	43.30	55	76.13	-21.13
2601.22244	11.7	52.95	64.65	76.13	-11.48



802.11n HT20 Combined Mode

CH Low

Frequency	Offset	Reading	Level	Limit	Margin
(MHz)	(dB)	(dBuV)	(dBuV)	(dBuV)	(dB)
2412	15.2	87.56	102.76	N/A	N/A
637.0941884	15.2	48.21	63.41	82.76	-19.35
2400	15.2	56.98	72.18	82.76	-10.58
2601.22244	15.2	52.28	67.48	82.76	-15.28

CH Mid

Frequency	Offset	Reading	Level	Limit	Margin
(MHz)	(dB)	(dBuV)	(dBuV)	(dBuV)	(dB)
2437	15.2	86.63	101.83	N/A	N/A
797.7955.9118	15.2	51.30	66.5	81.83	-15.33
2400	15.2	41.91	57.11	81.83	-24.72
2601.22244	15.2	52.33	67.53	81.83	-14.30

CH High

Frequency	Offset	Reading	Level	Limit	Margin
(MHz)	(dB)	(dBuV)	(dBuV)	(dBuV)	(dB)
2462	15.2	86.92	102.12	N/A	N/A
797.7955912	15.2	48.24	63.44	82.12	-18.68
2400	15.2	41.29	56.49	82.12	-25.63
2601.22244	15.2	52.09	67.29	82.12	-14.83

802.11n HT40 Combined Mode

CH Low

Frequency	Offset	Reading	Level	Limit	Margin
(MHz)	(dB)	(dBuV)	(dBuV)	(dBuV)	(dB)
2422	15.2	84.04	99.24	N/A	N/A
634.7134269	15.2	48.82	64.02	79.24	-15.22
2400	15.2	53.75	68.95	79.24	-10.29
2601.22244	15.2	54.39	69.59	79.24	-9.65

CH Mid

Frequency	Offset	Reading	Level	Limit	Margin
(MHz)	(dB)	(dBuV)	(dBuV)	(dBuV)	(dB)
2437	15.2	83.00	98.2	N/A	N/A
800.7715431	15.2	52.11	67.31	78.20	-10.89
2400	15.2	42.69	57.89	78.20	-20.31
2601.22244	15.2	53.67	68.87	78.20	-9.33

CH High

Frequency	Offset	Reading	Level	Limit	Margin
(MHz)	(dB)	(dBuV)	(dBuV)	(dBuV)	(dB)
2452	15.2	82.94	98.14	N/A	N/A
795.4148297	15.2	45.87	61.07	78.14	-17.07
2400	15.2	42.38	57.58	78.14	-20.56
2601.22244	15.2	53.62	68.82	78.14	-9.32



OUT-OF-BAND SPURIOUS EMISSIONS-CONDUCTED MEASUREMENT (IEEE 802.11b MODE)

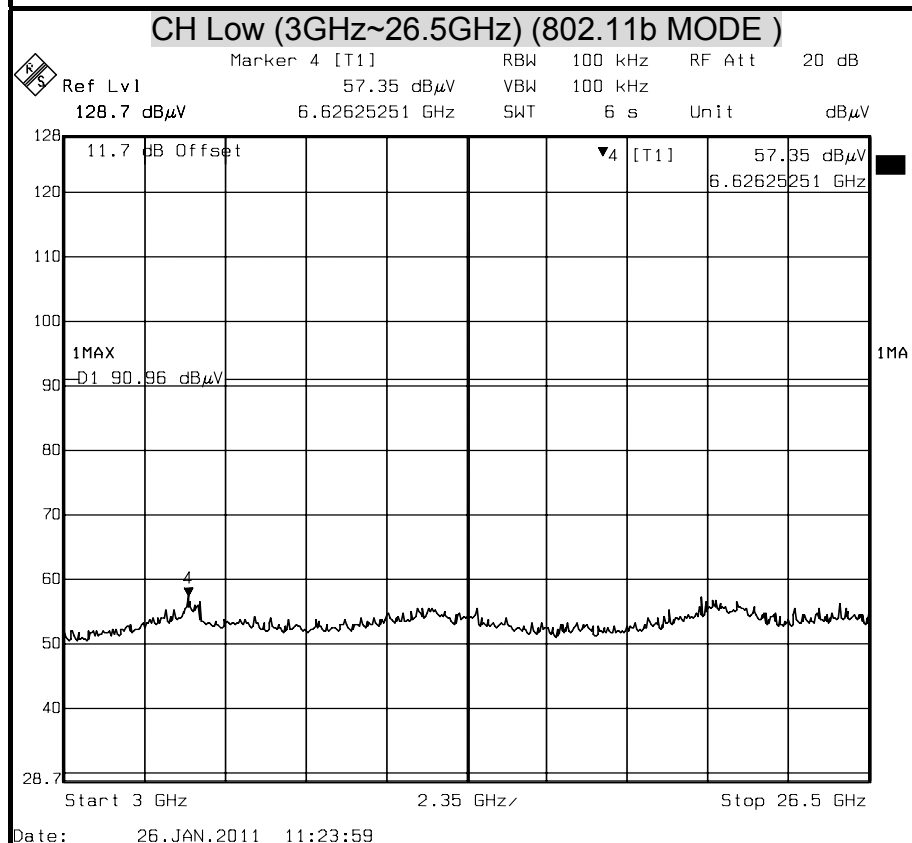
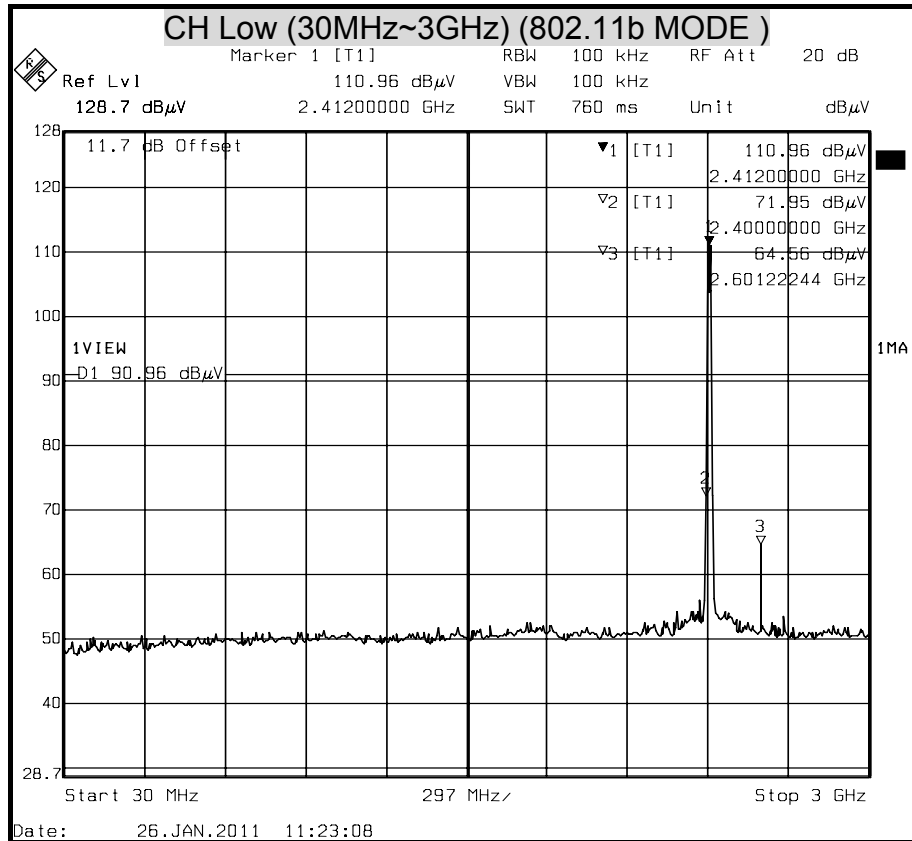

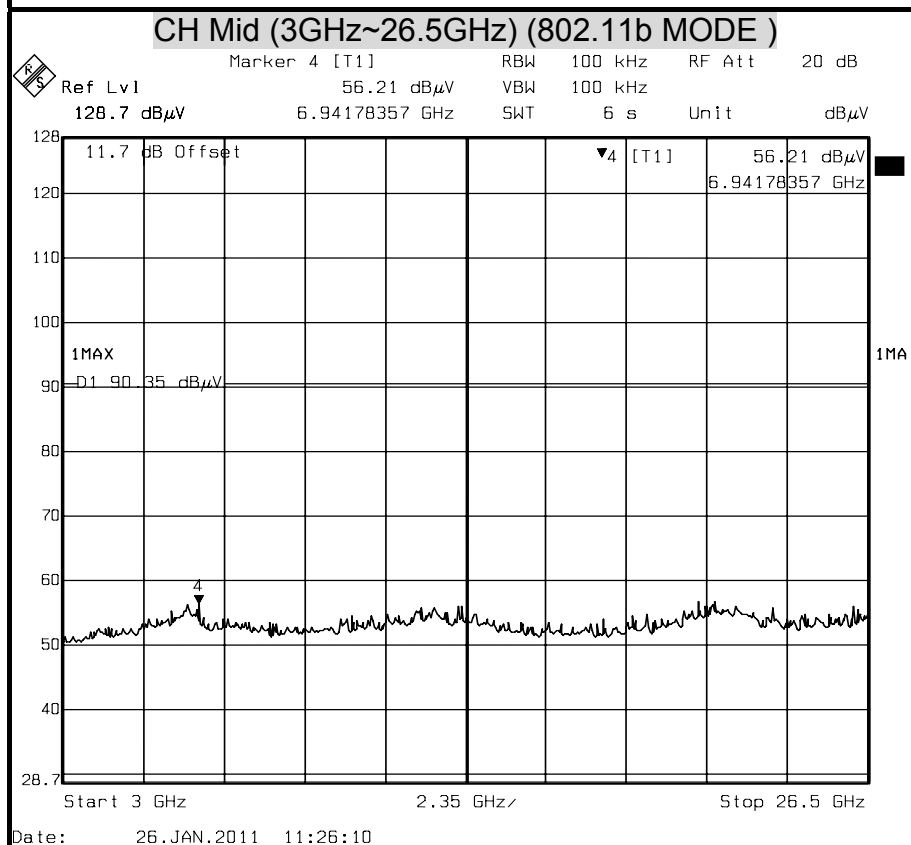
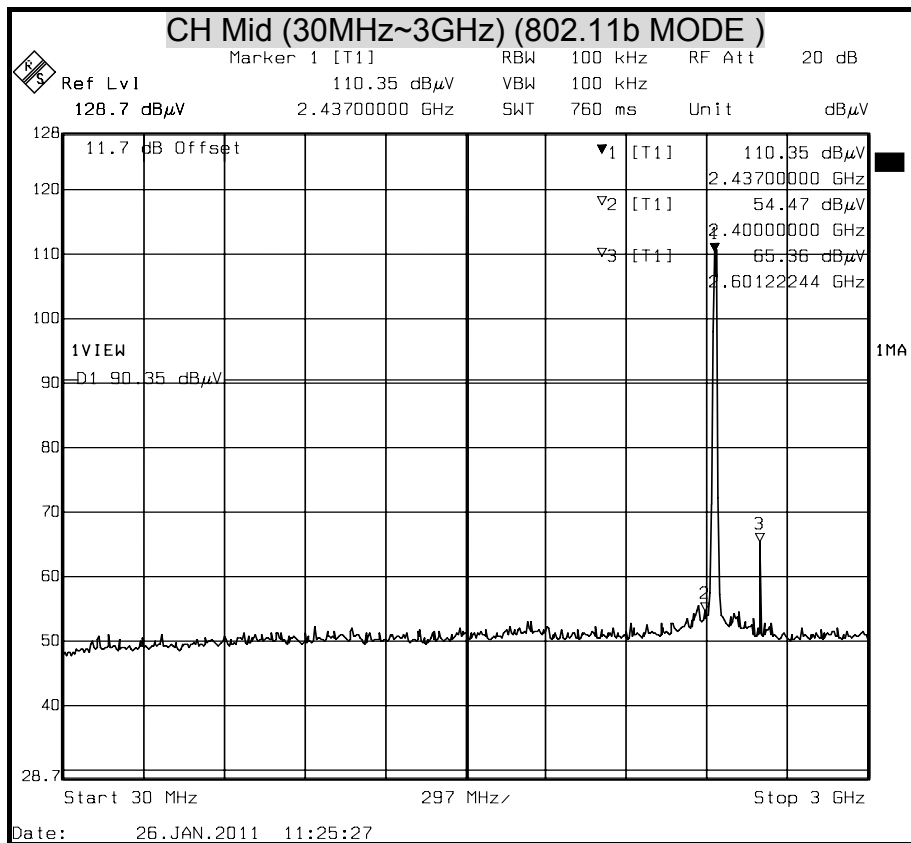

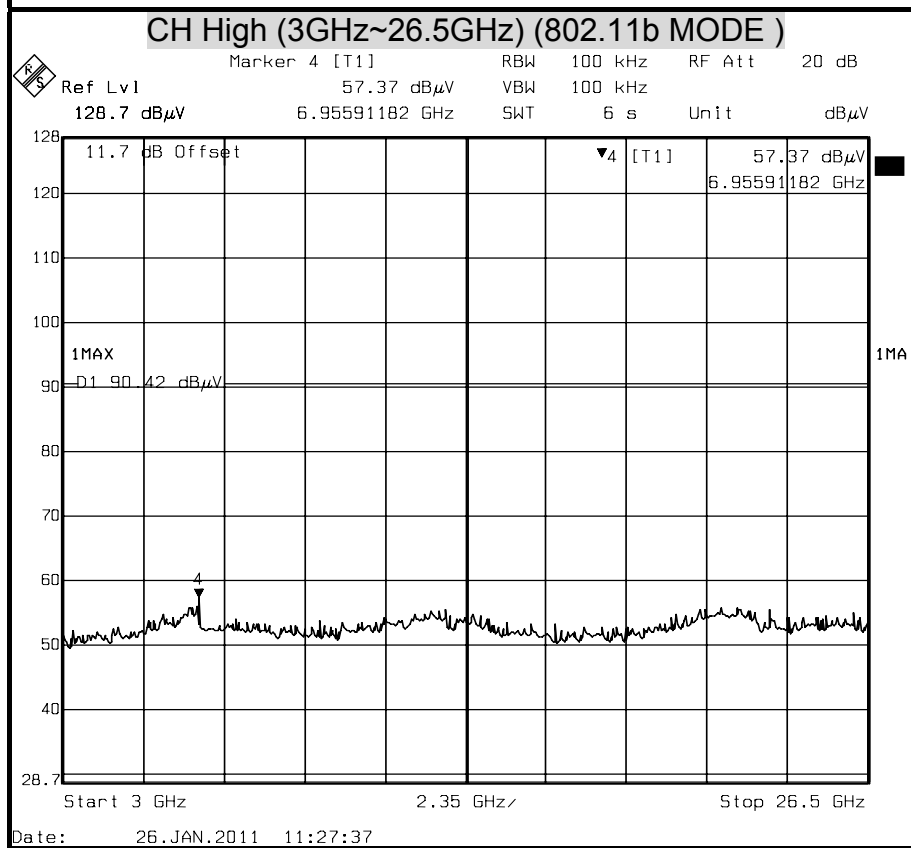
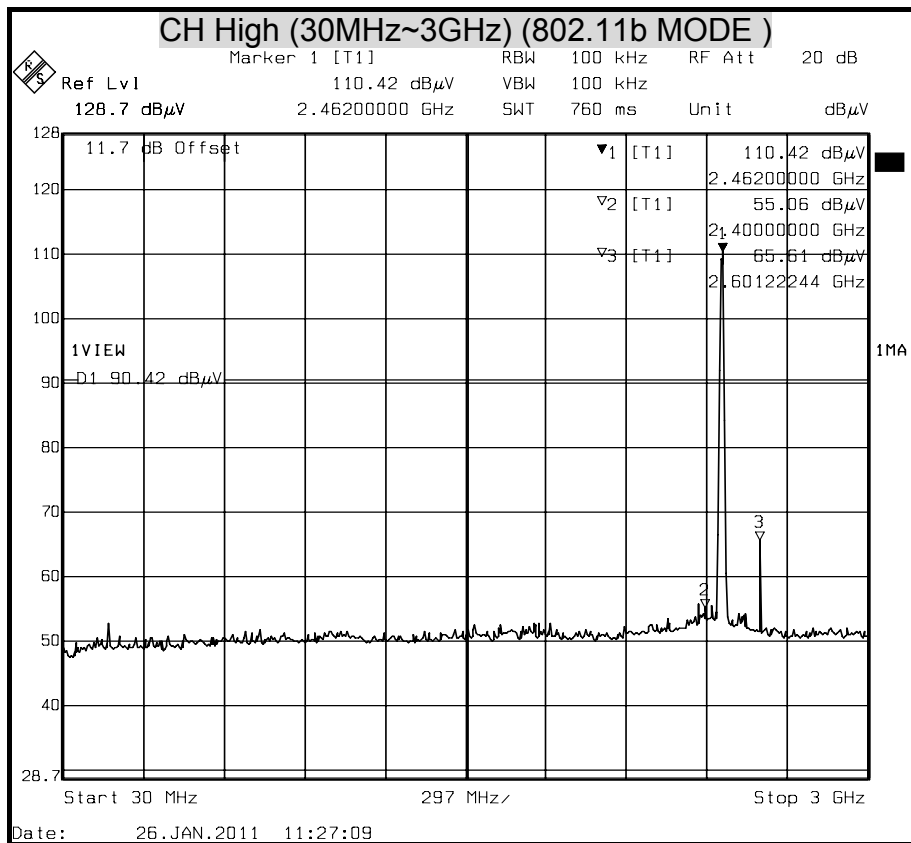



OUT-OF-BAND SPURIOUS EMISSIONS-CONDUCTED MEASUREMENT (802.11g MODE)

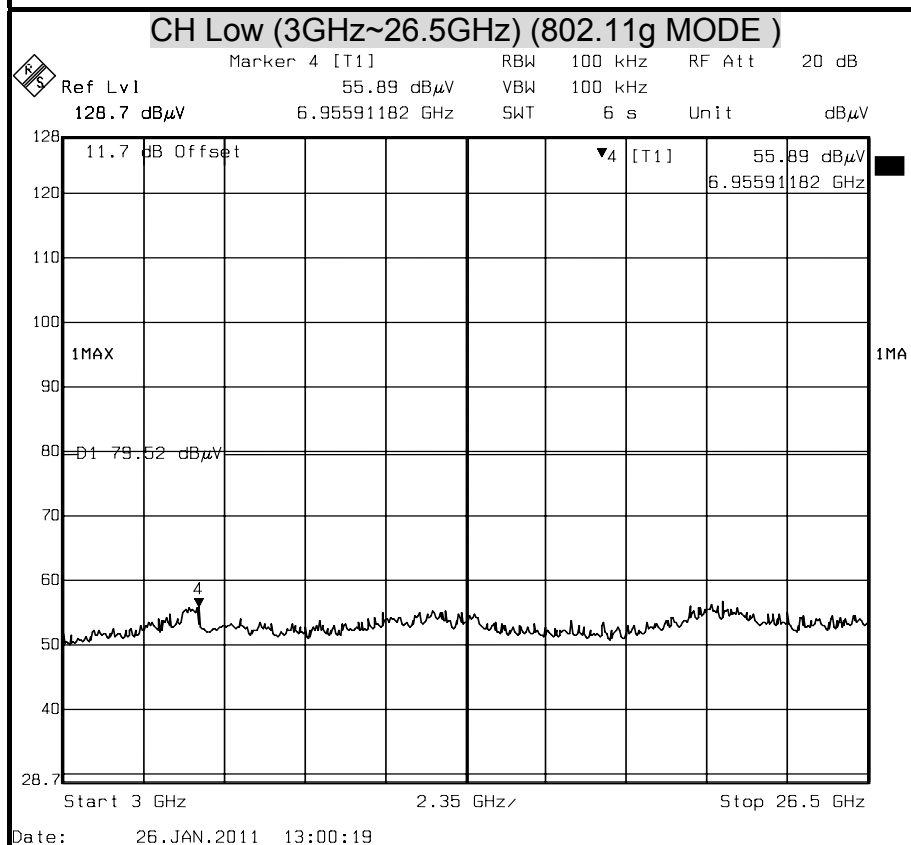
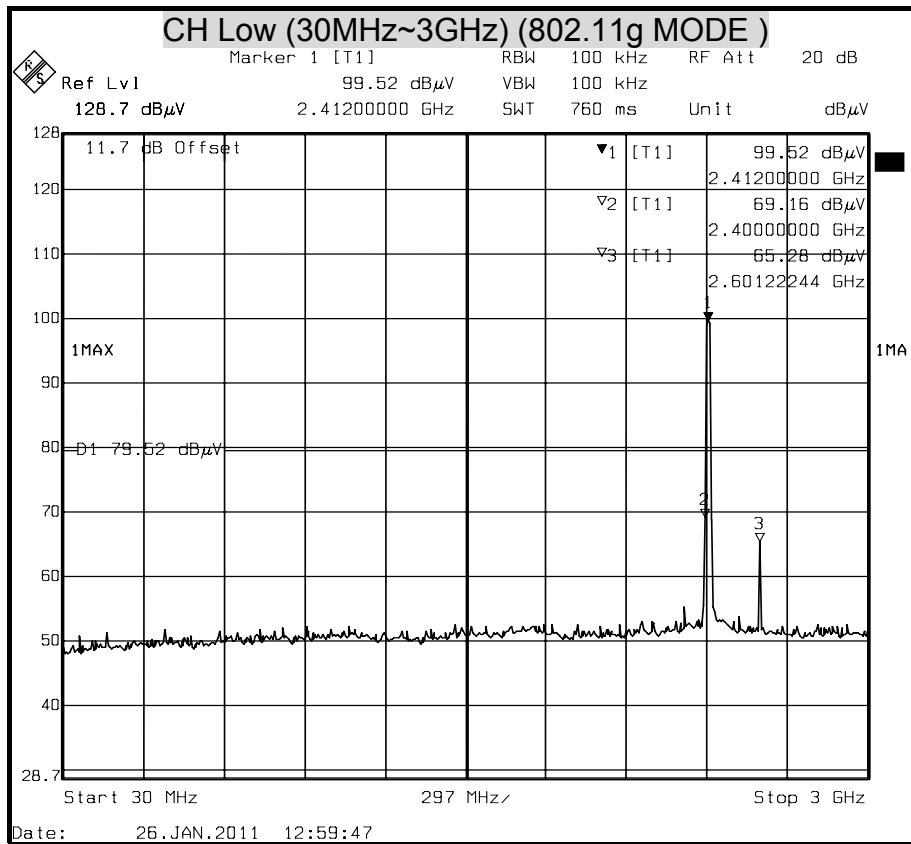

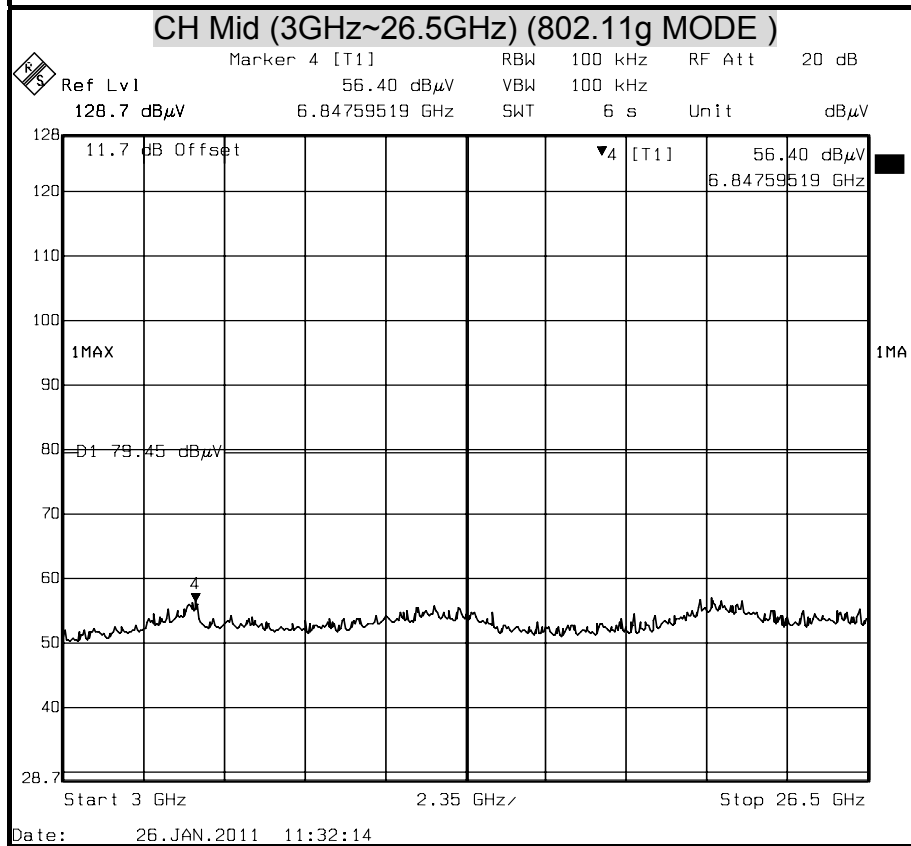
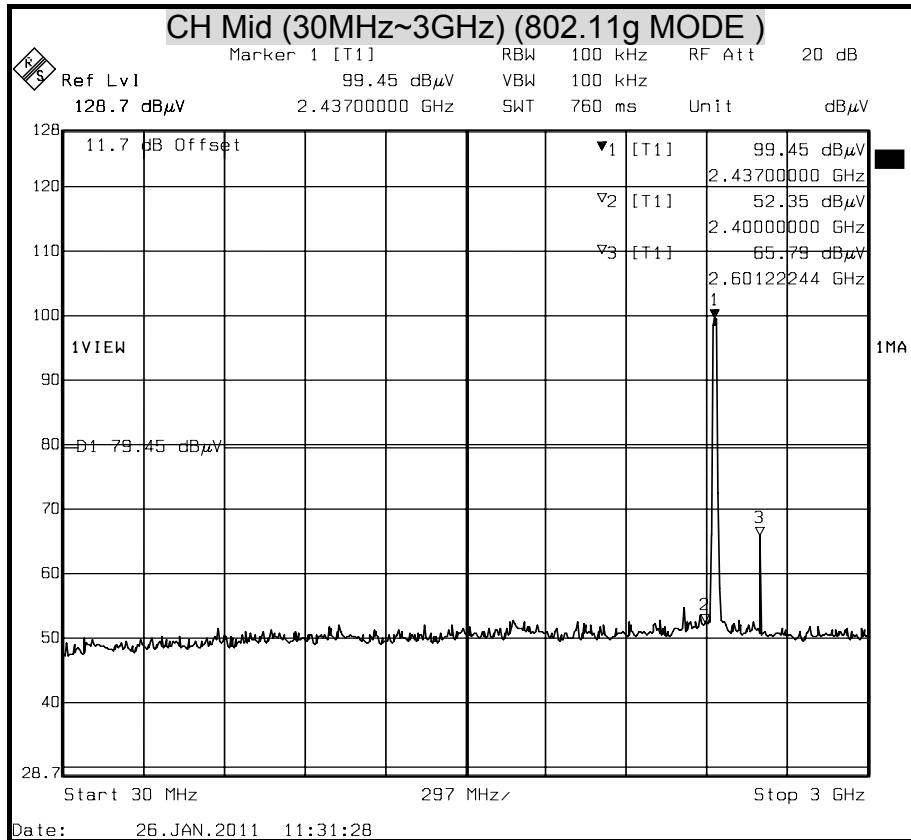

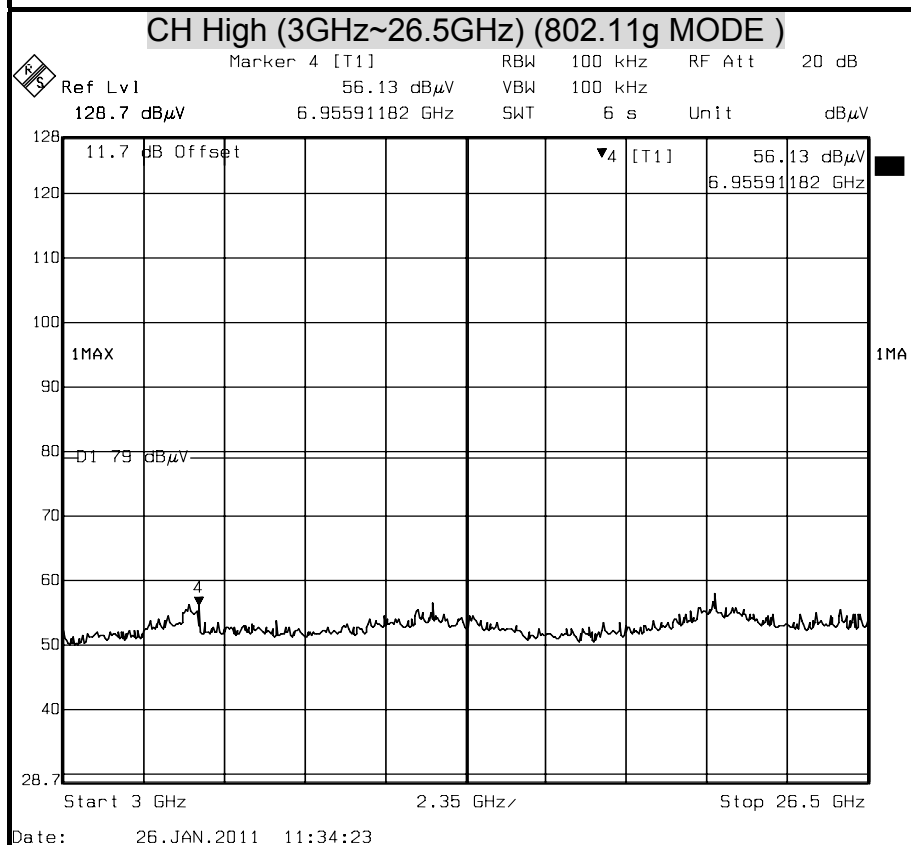
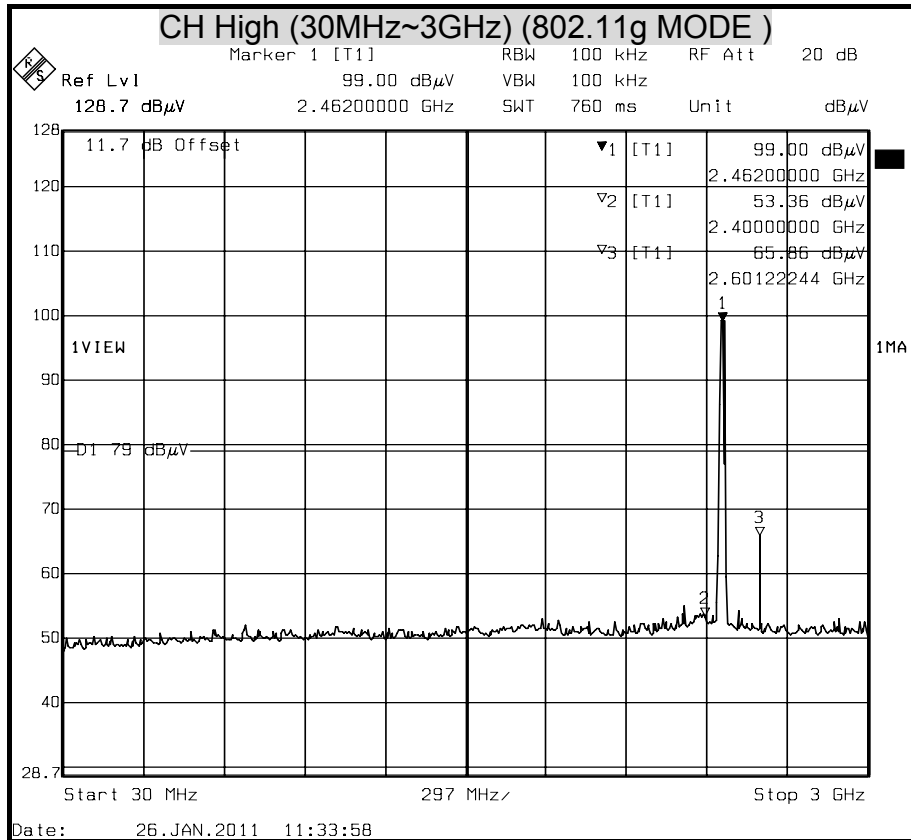



OUT-OF-BAND SPURIOUS EMISSIONS-CONDUCTED MEASUREMENT (802.11n HT20 MODE)

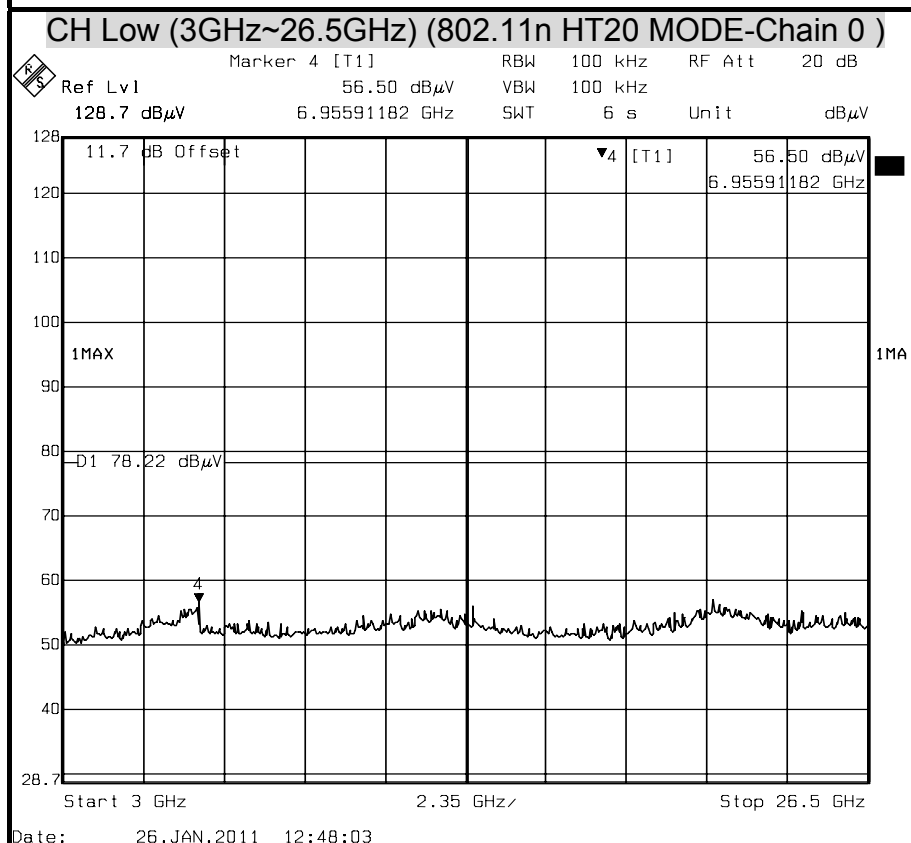
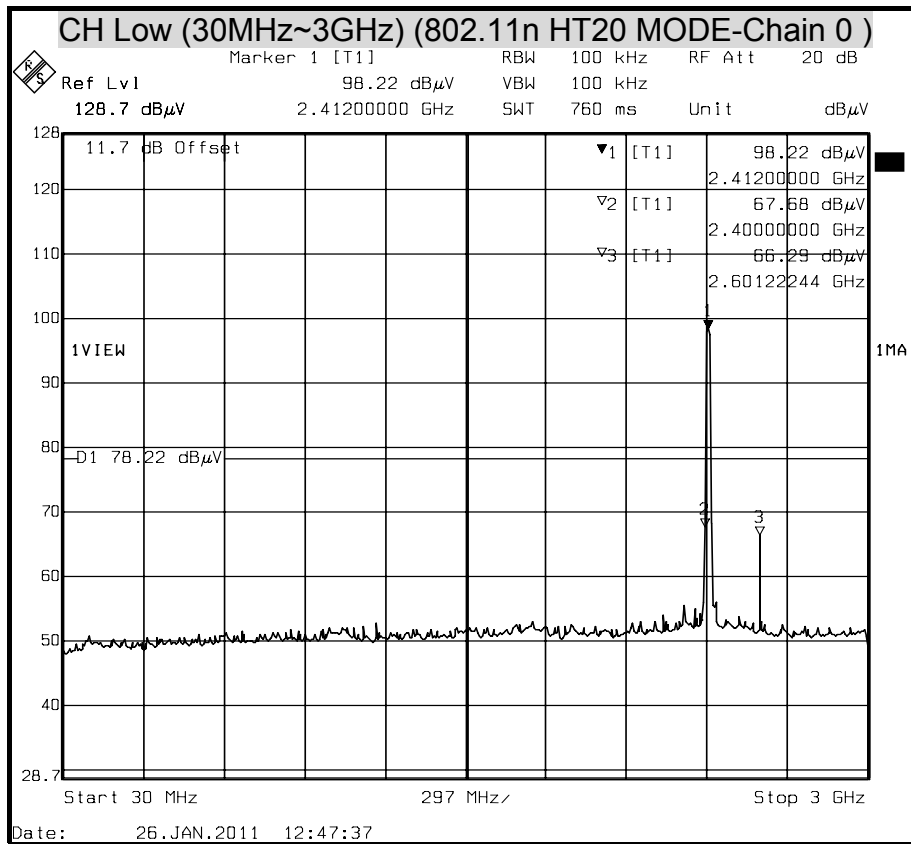

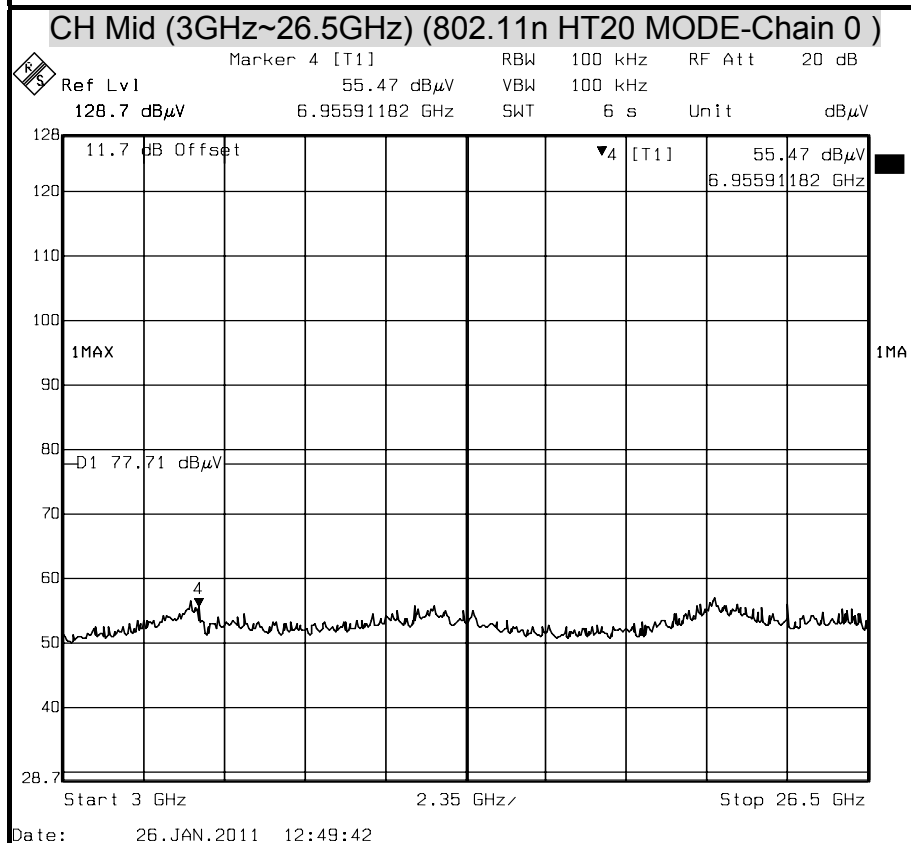
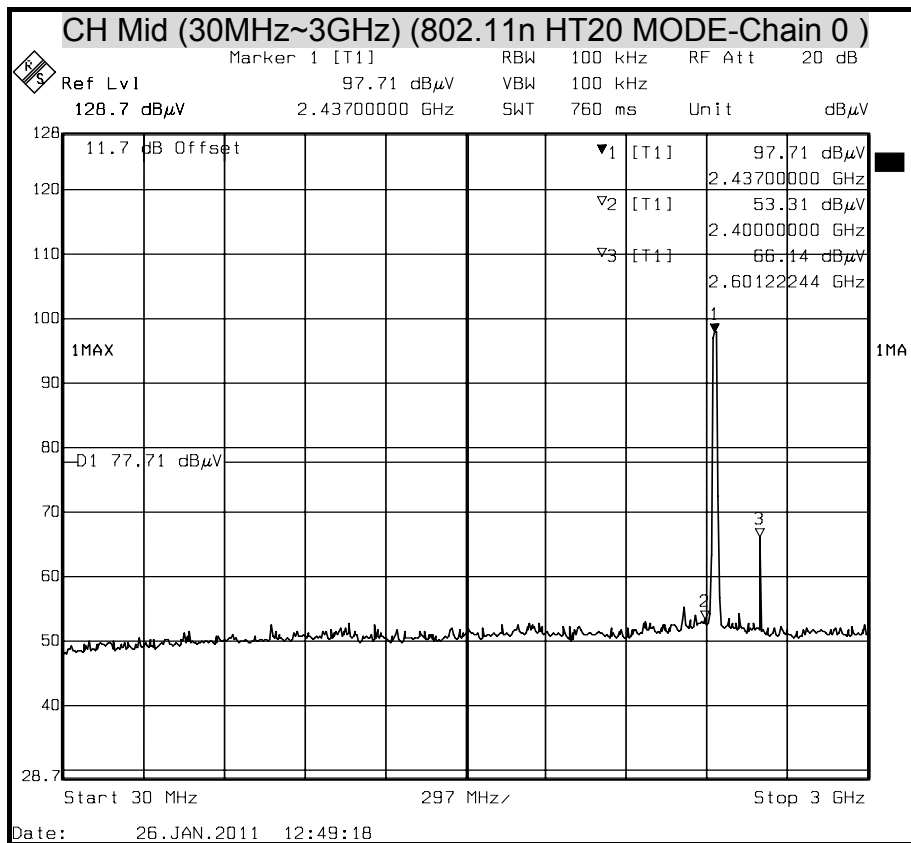

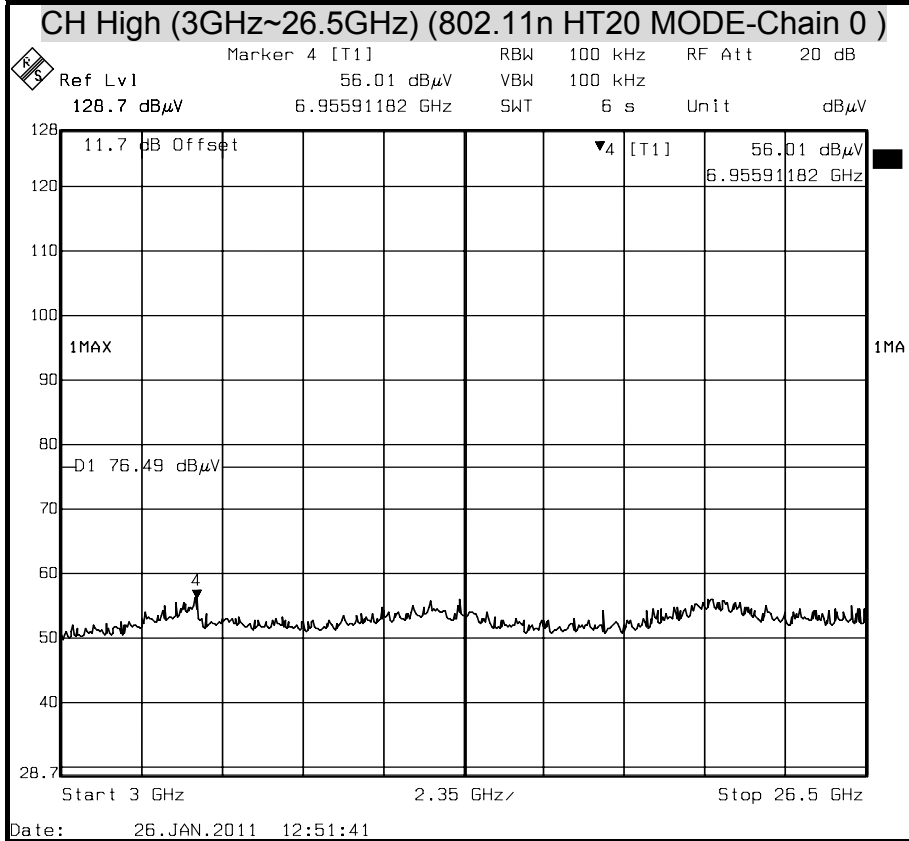
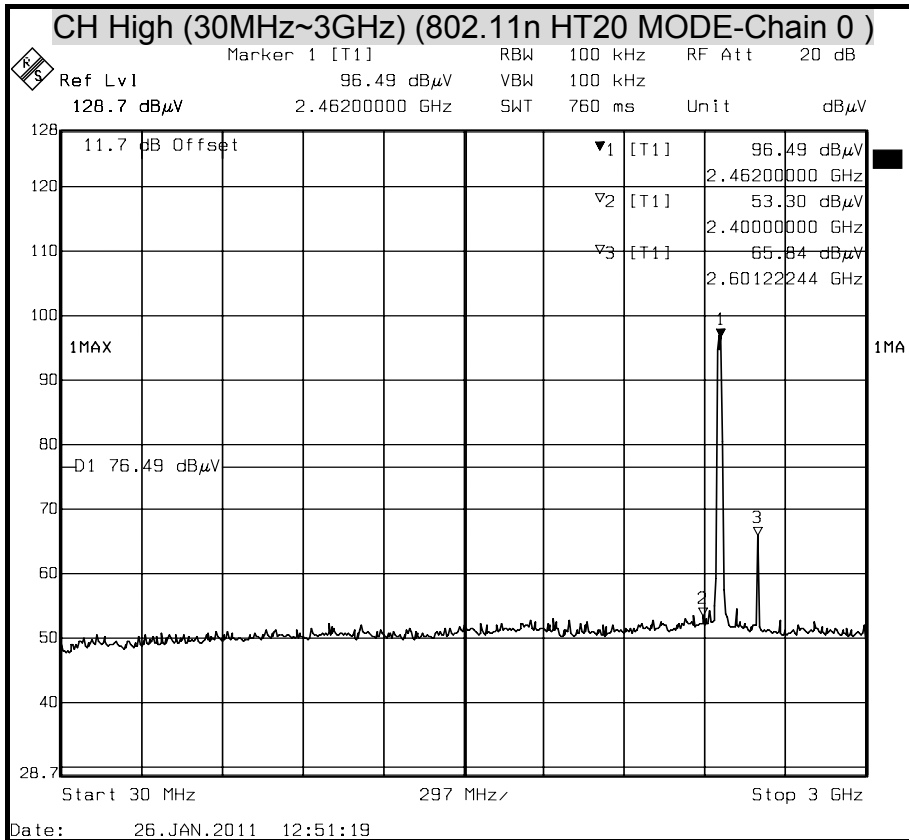



OUT-OF-BAND SPURIOUS EMISSIONS-CONDUCTED MEASUREMENT (802.11n HT20 MODE)

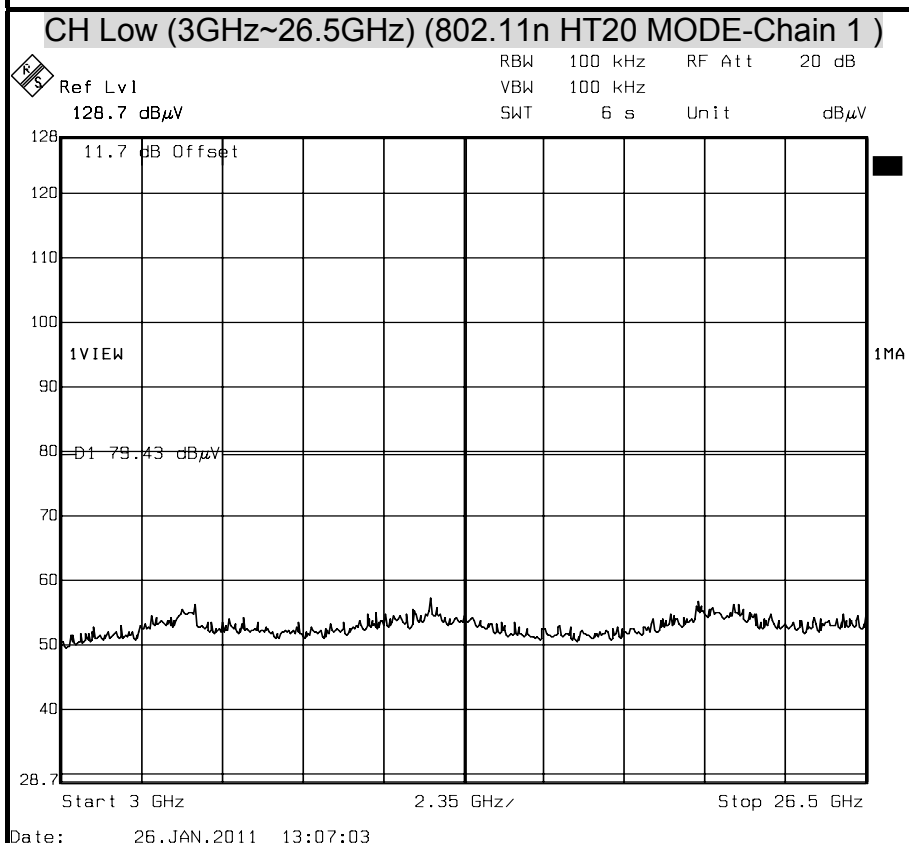
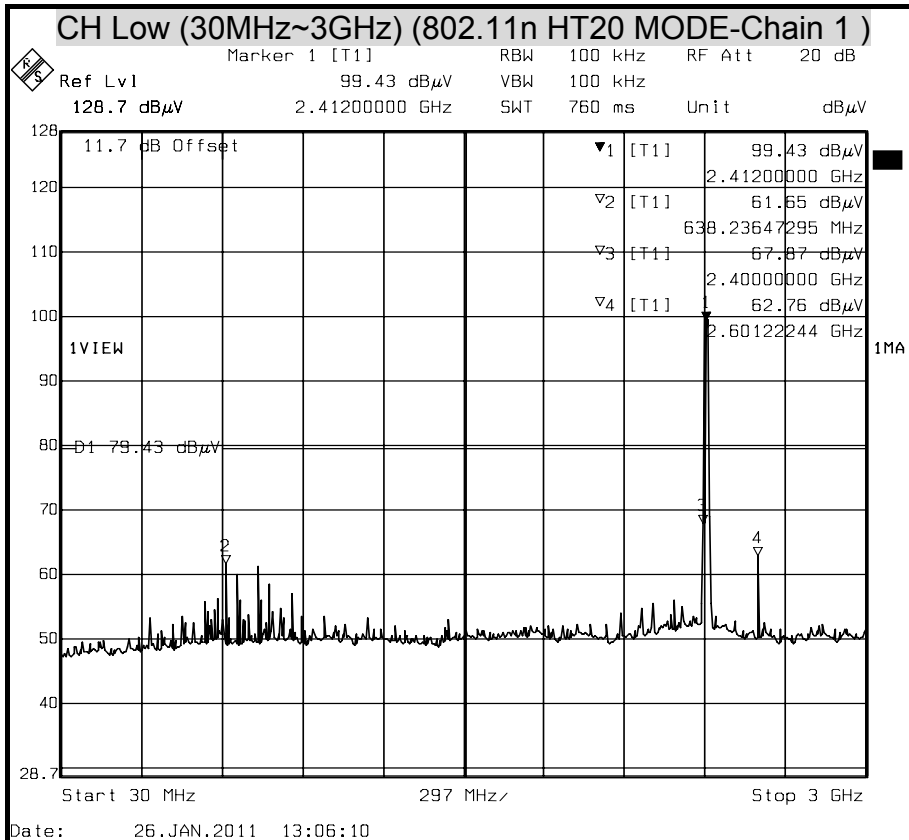

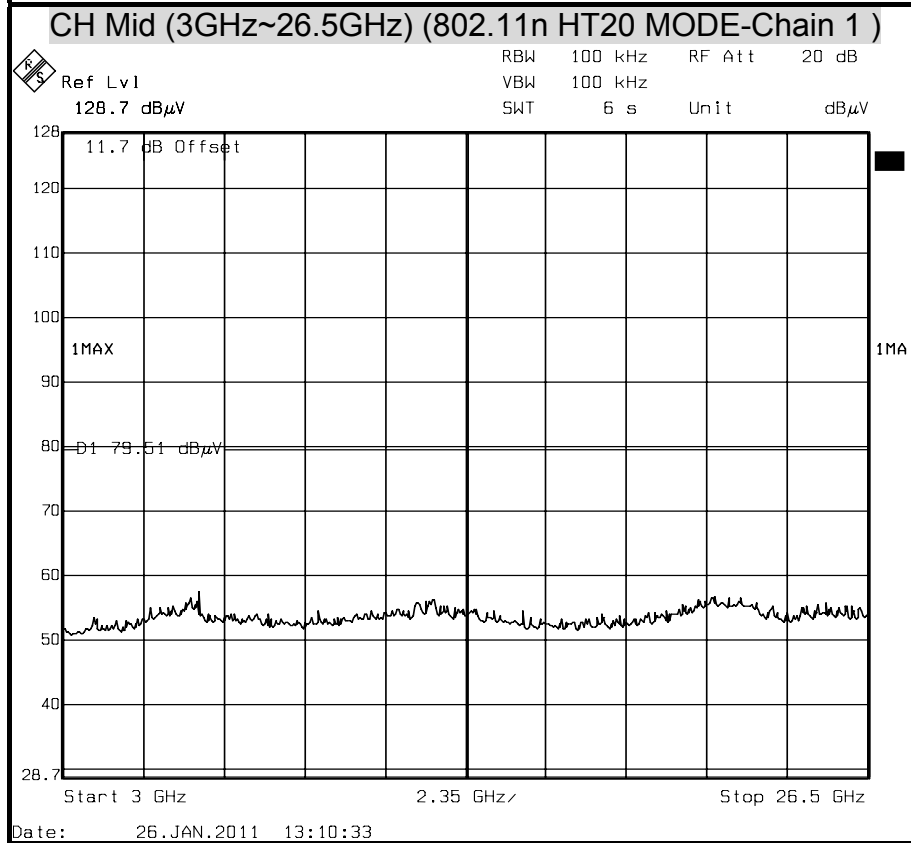
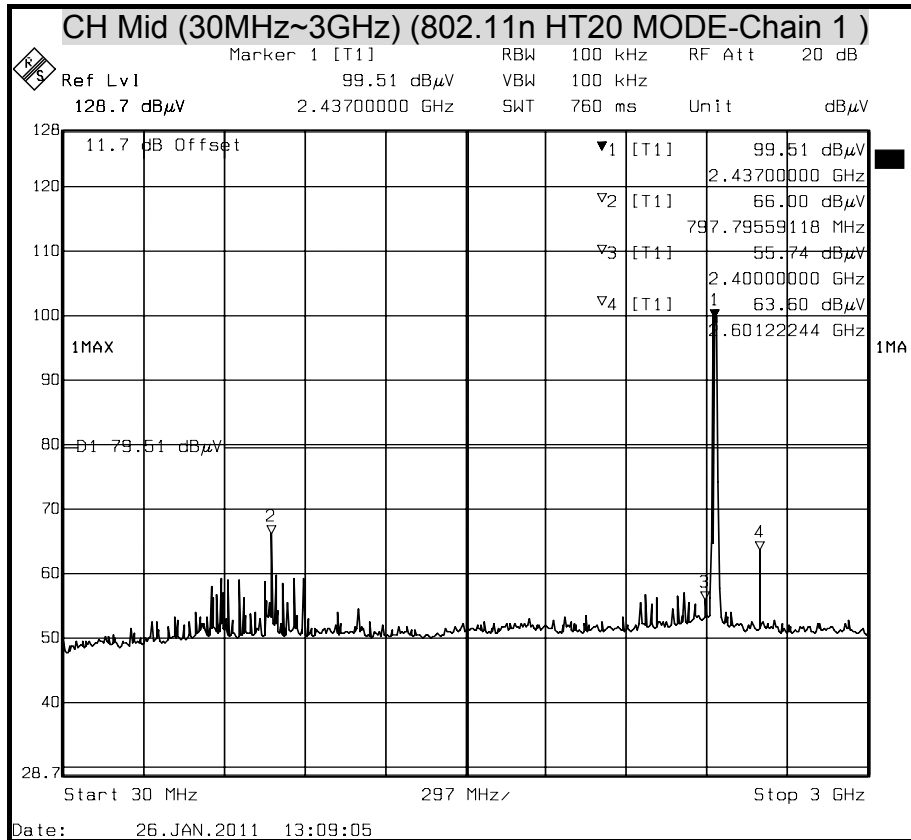

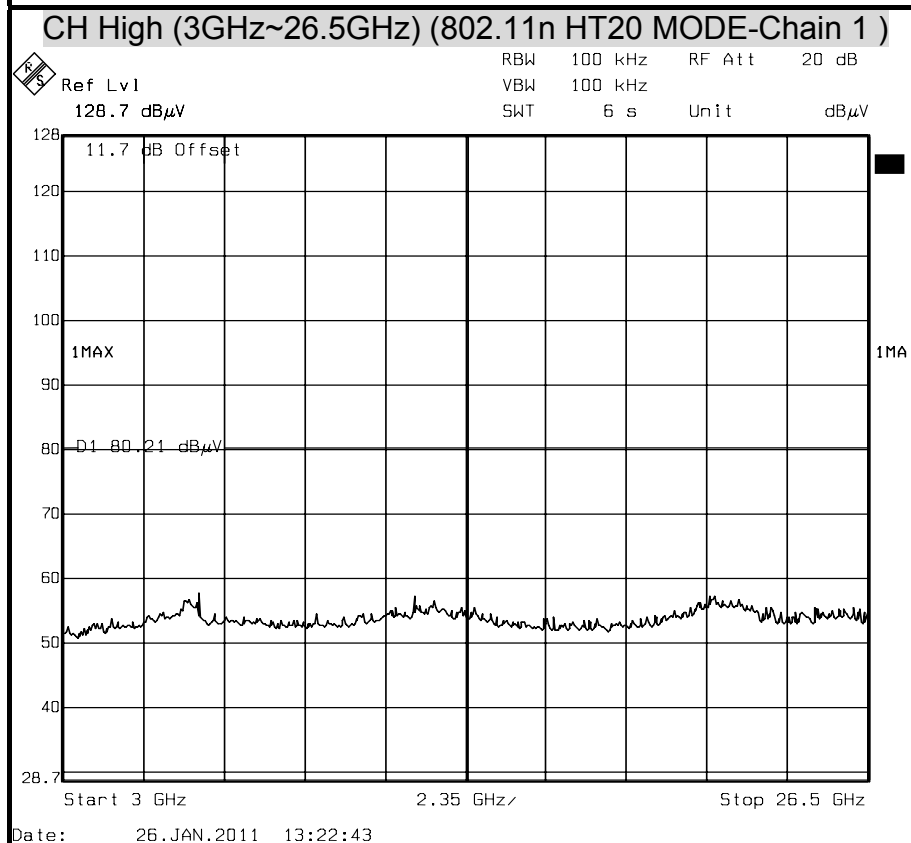
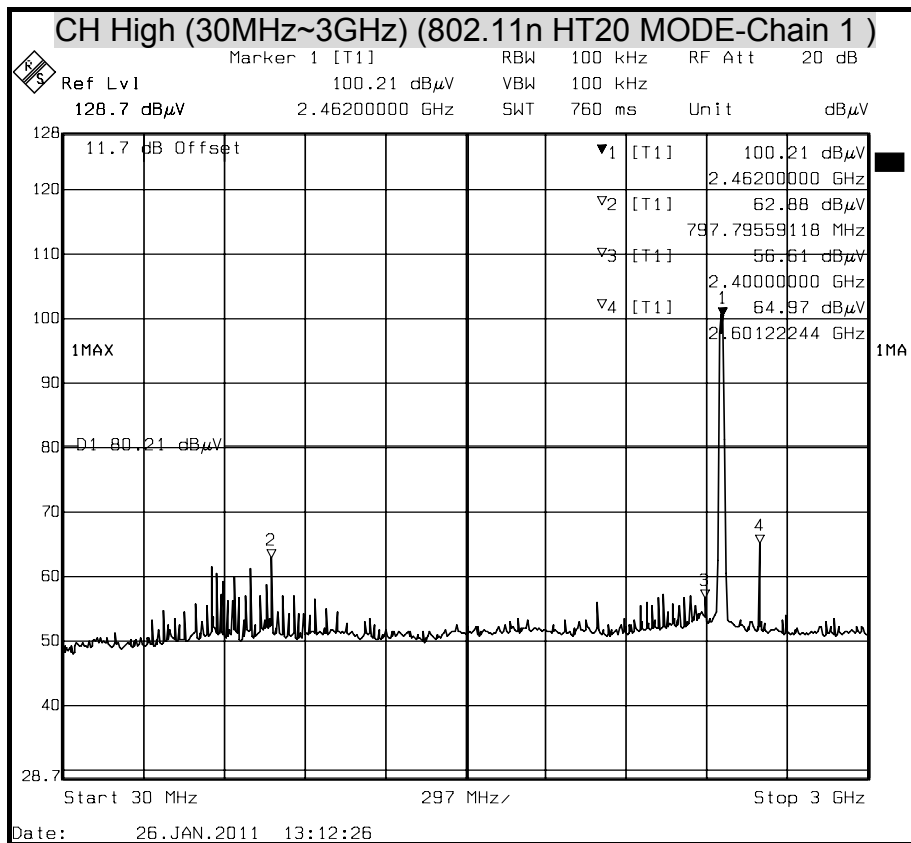



OUT-OF-BAND SPURIOUS EMISSIONS-CONDUCTED MEASUREMENT

(802.11n HT40 MODE)

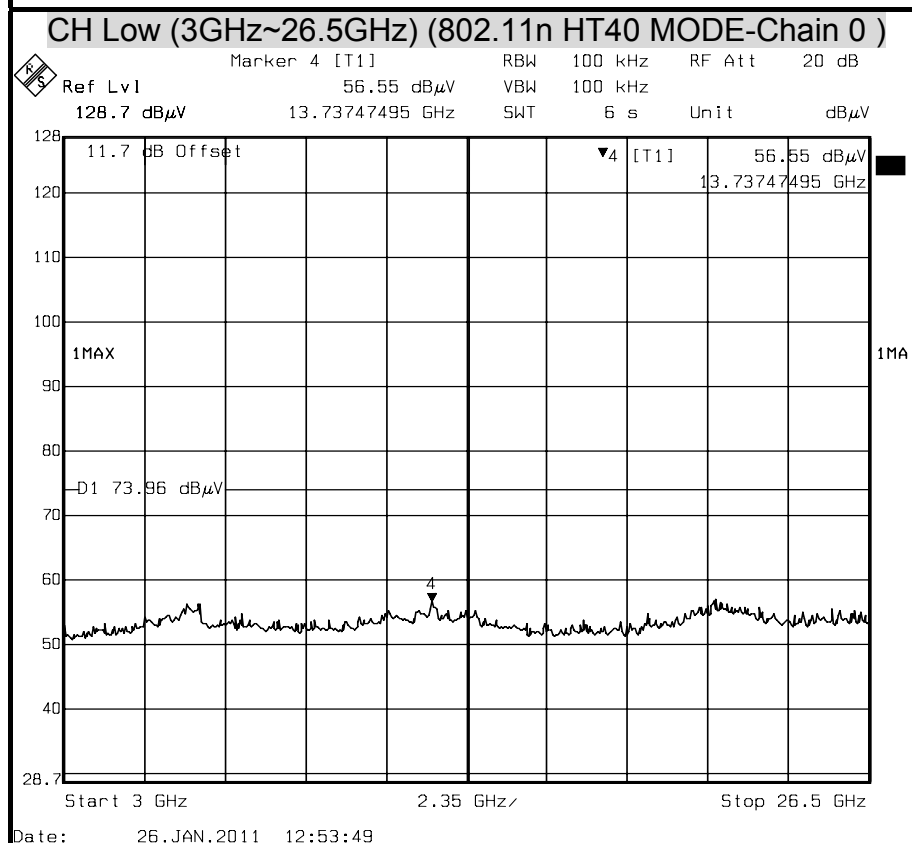
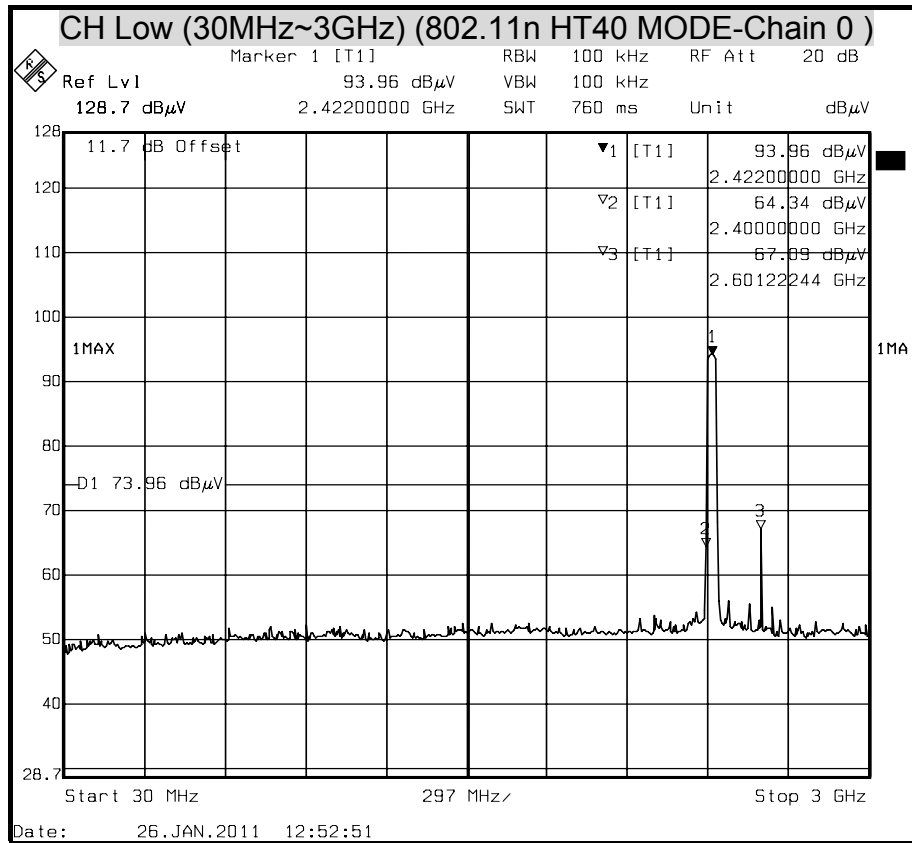

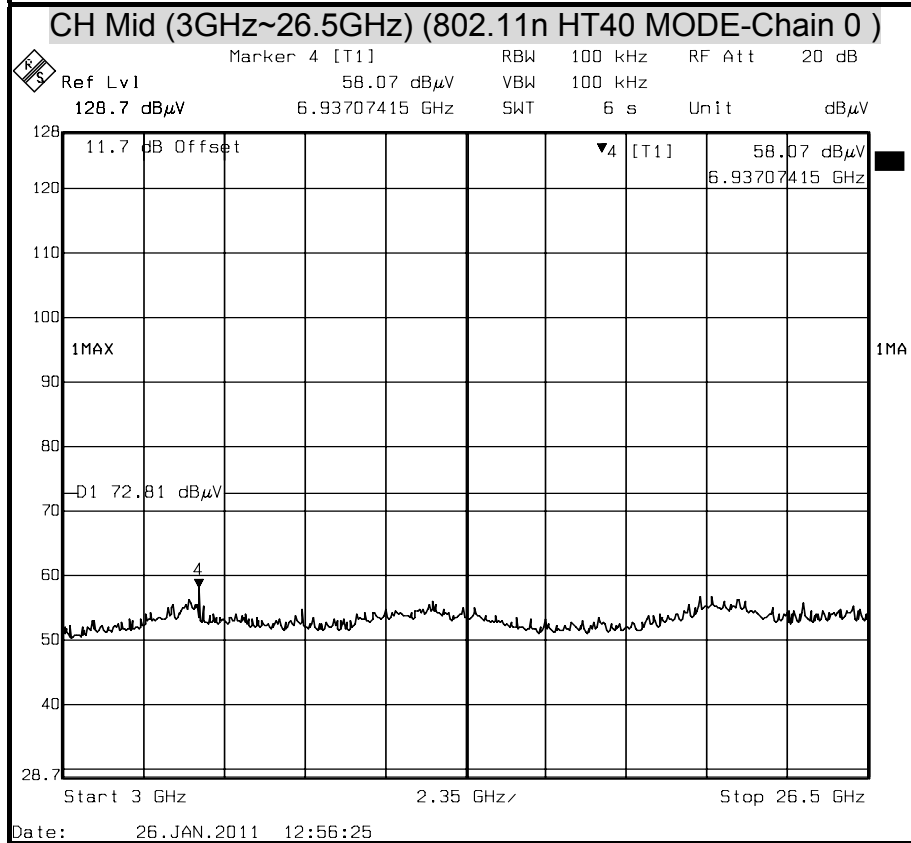
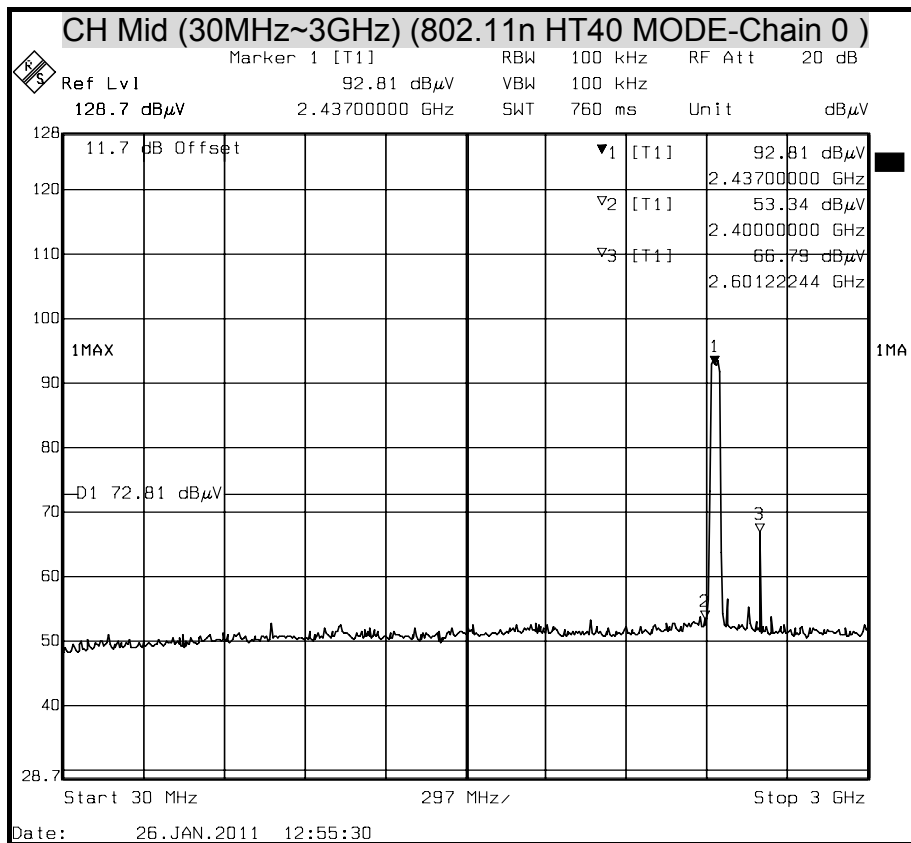

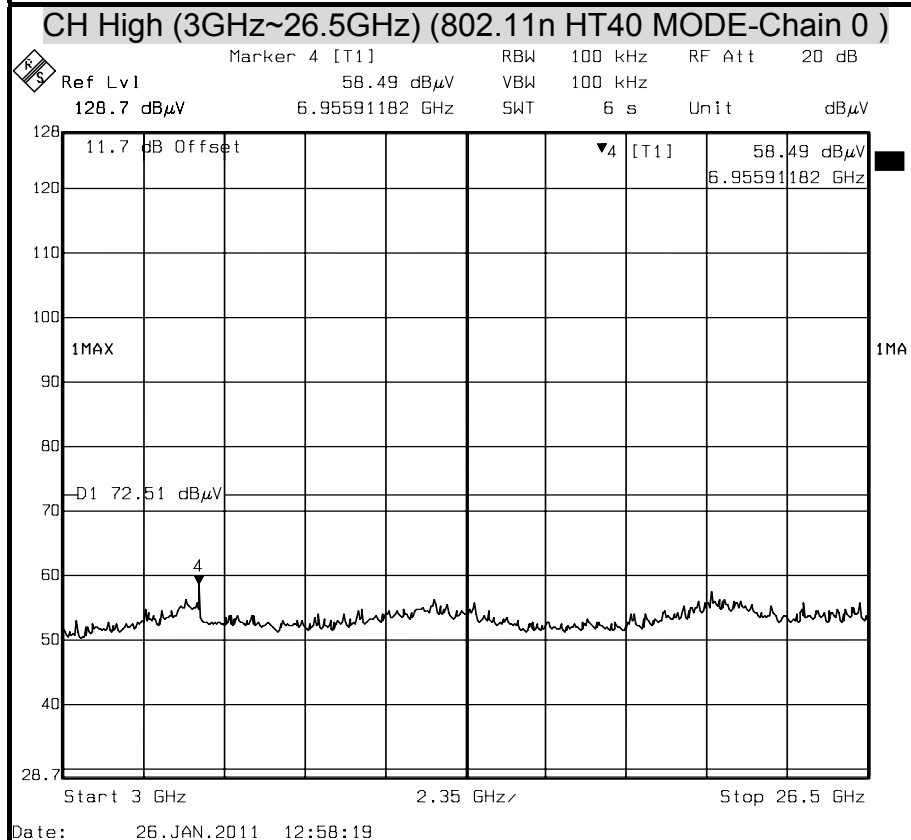
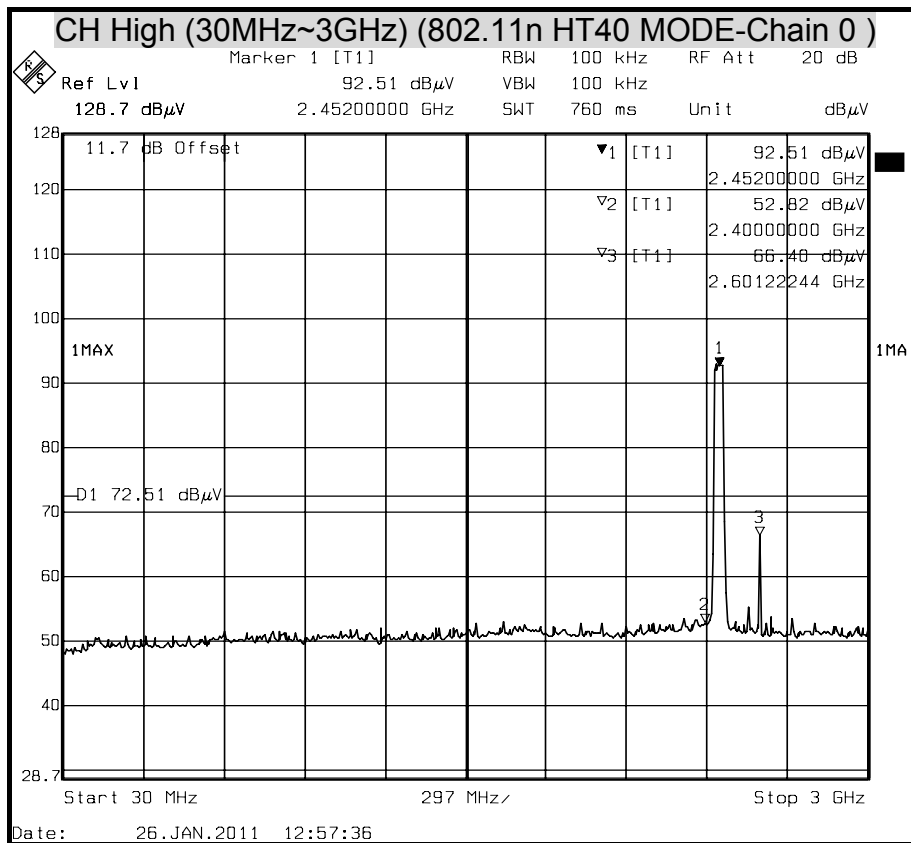



OUT-OF-BAND SPURIOUS EMISSIONS-CONDUCTED MEASUREMENT (802.11n HT40 MODE)

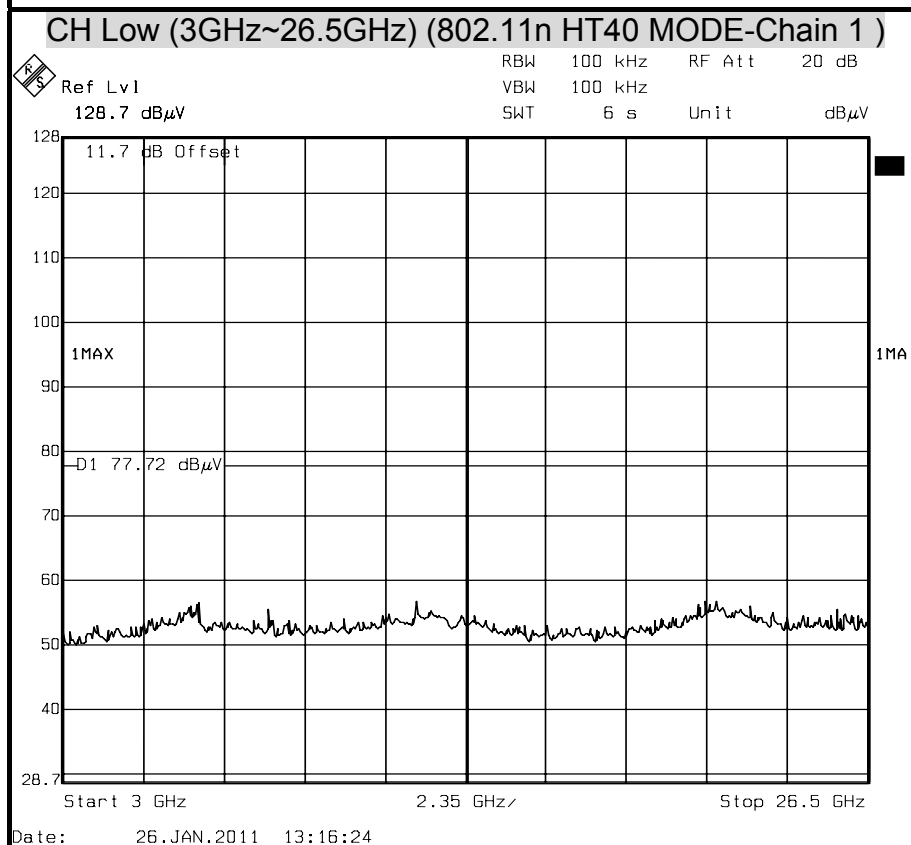
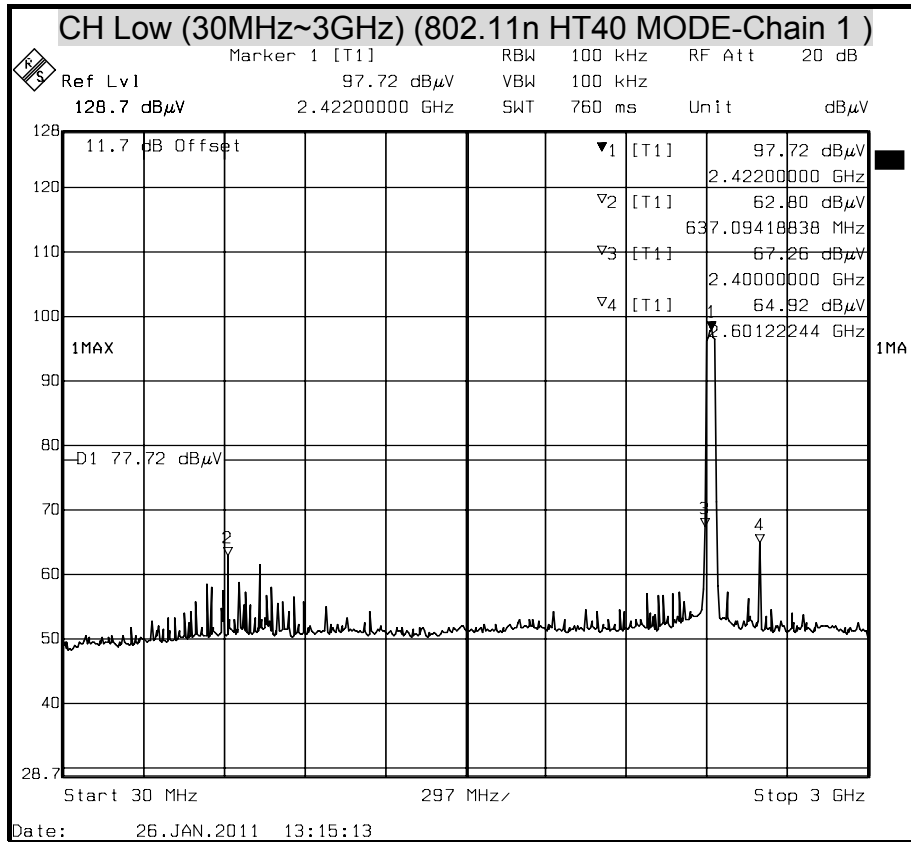

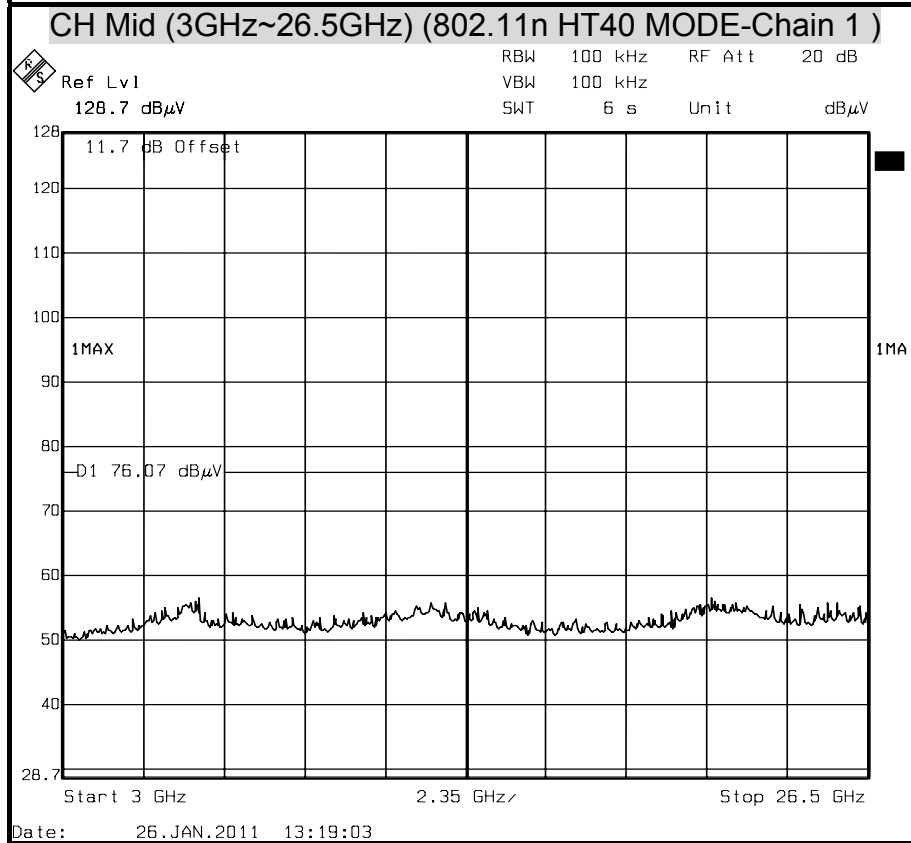
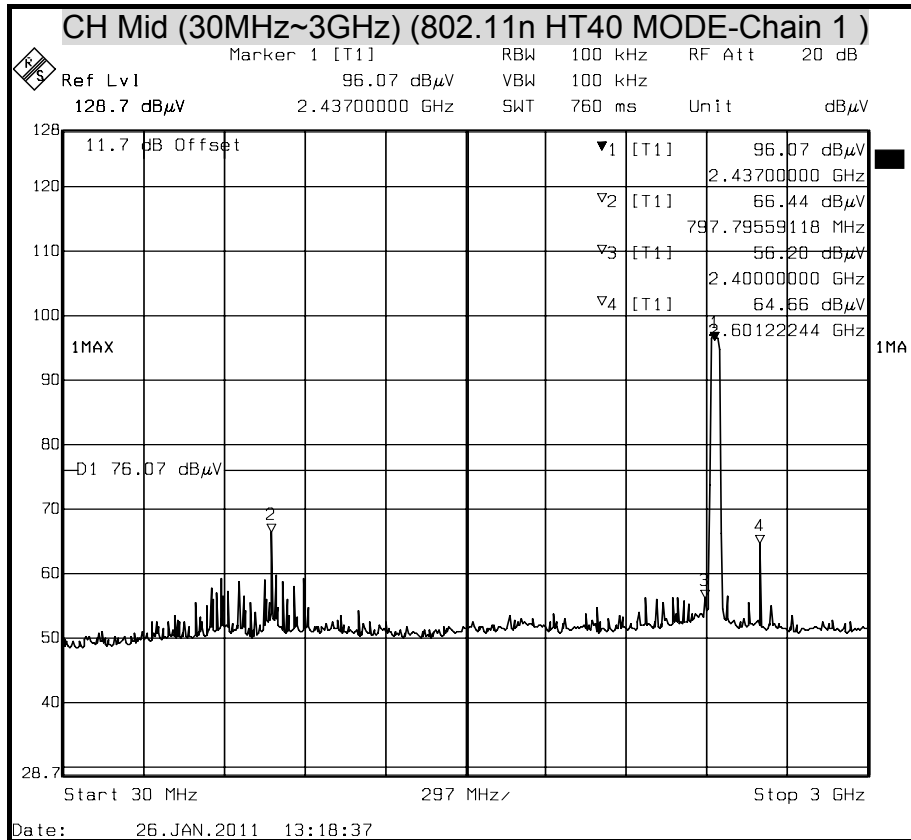

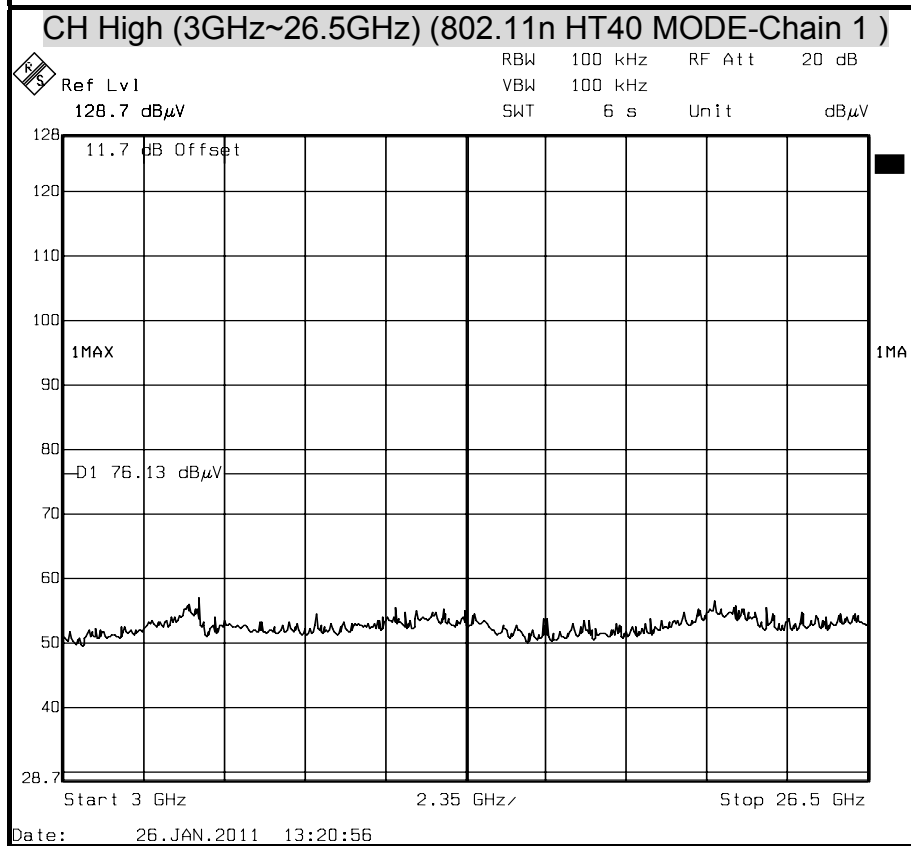
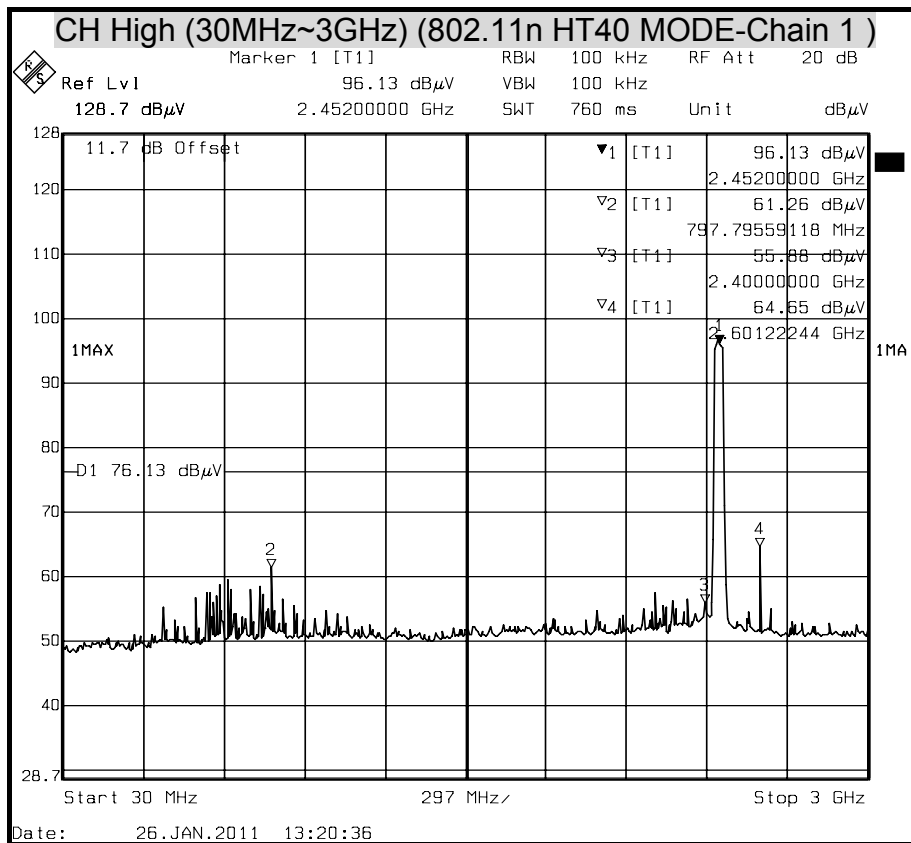



OUT-OF-BAND SPURIOUS EMISSIONS-CONDUCTED MEASUREMENT (802.11n HT20 Combined Mode)

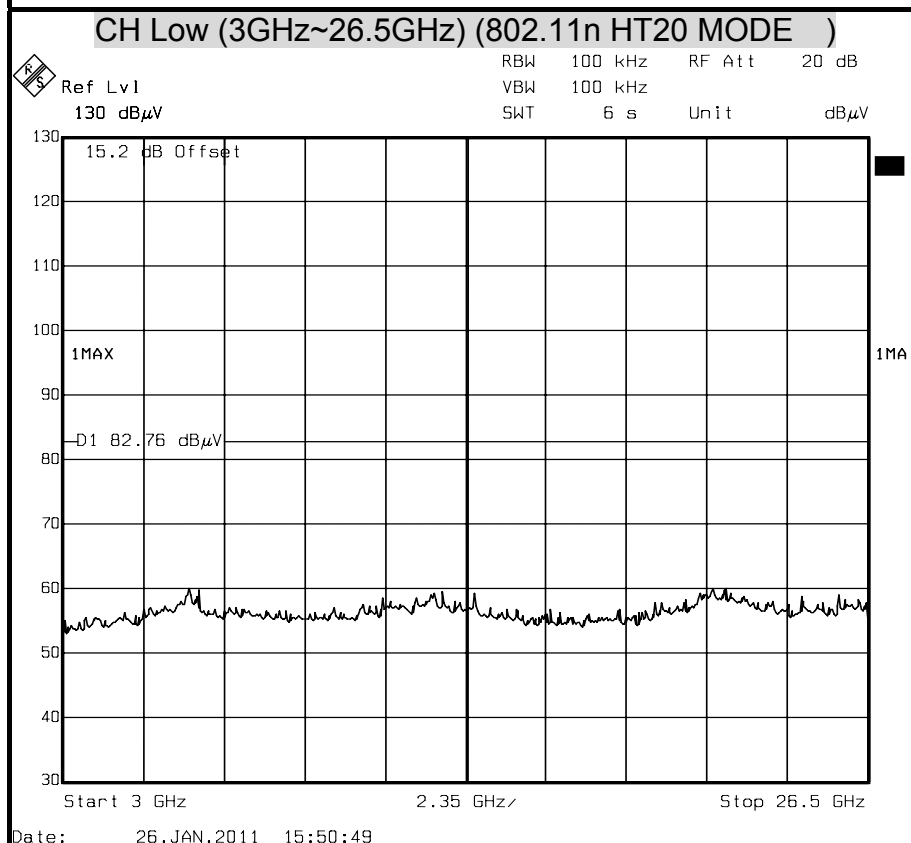
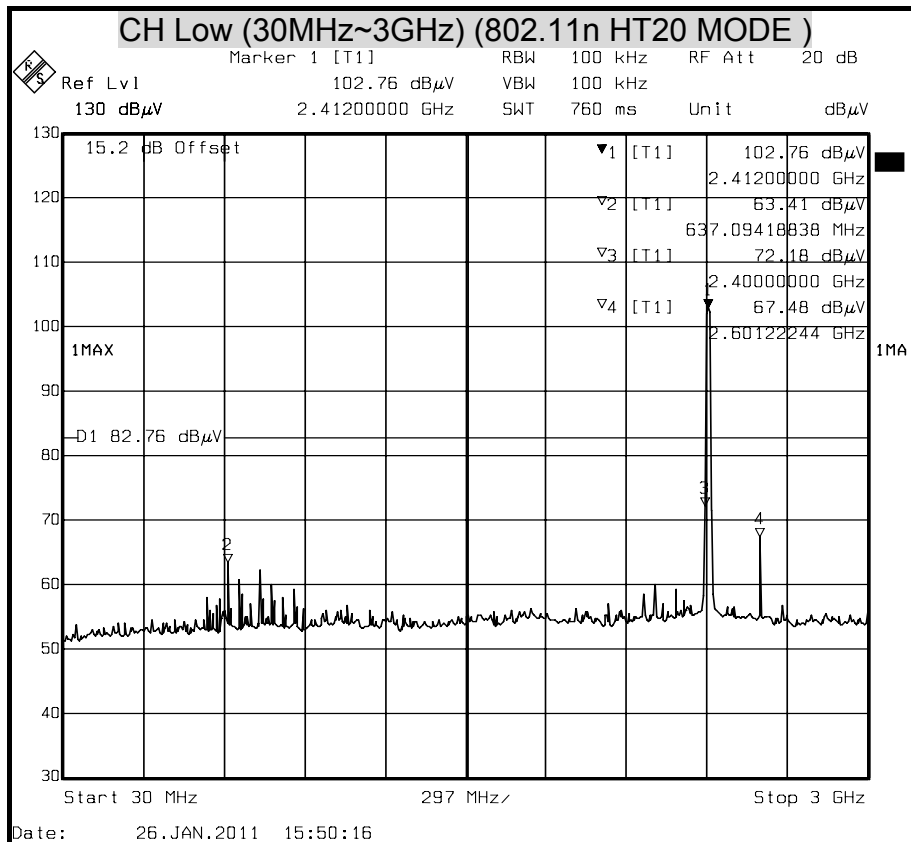

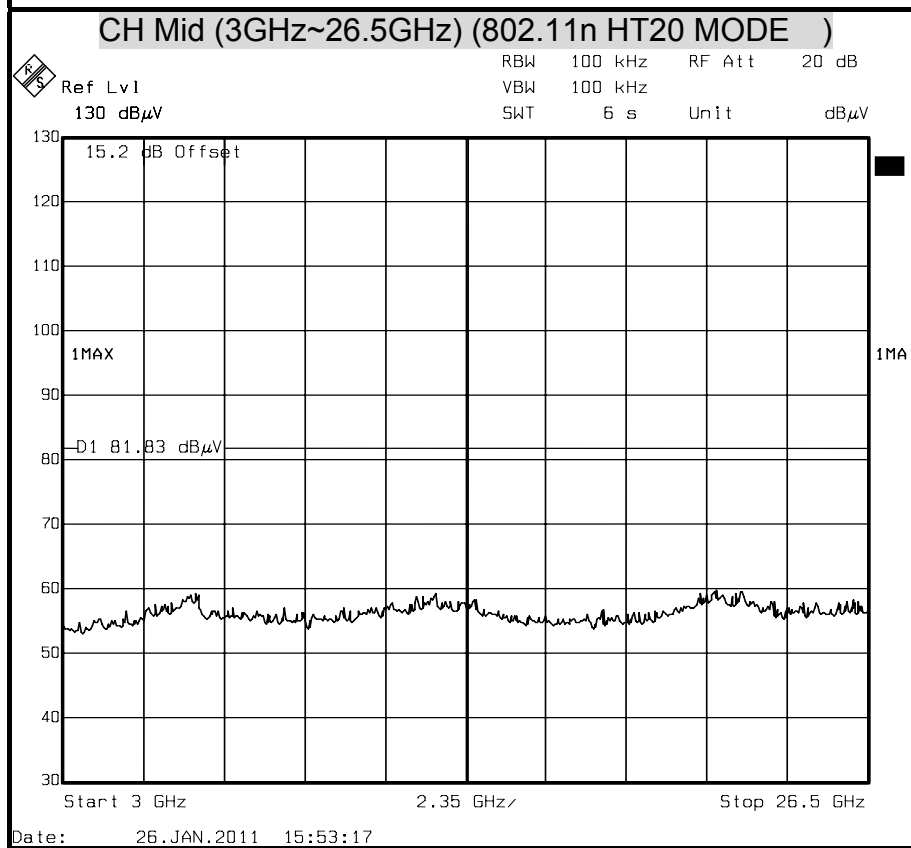
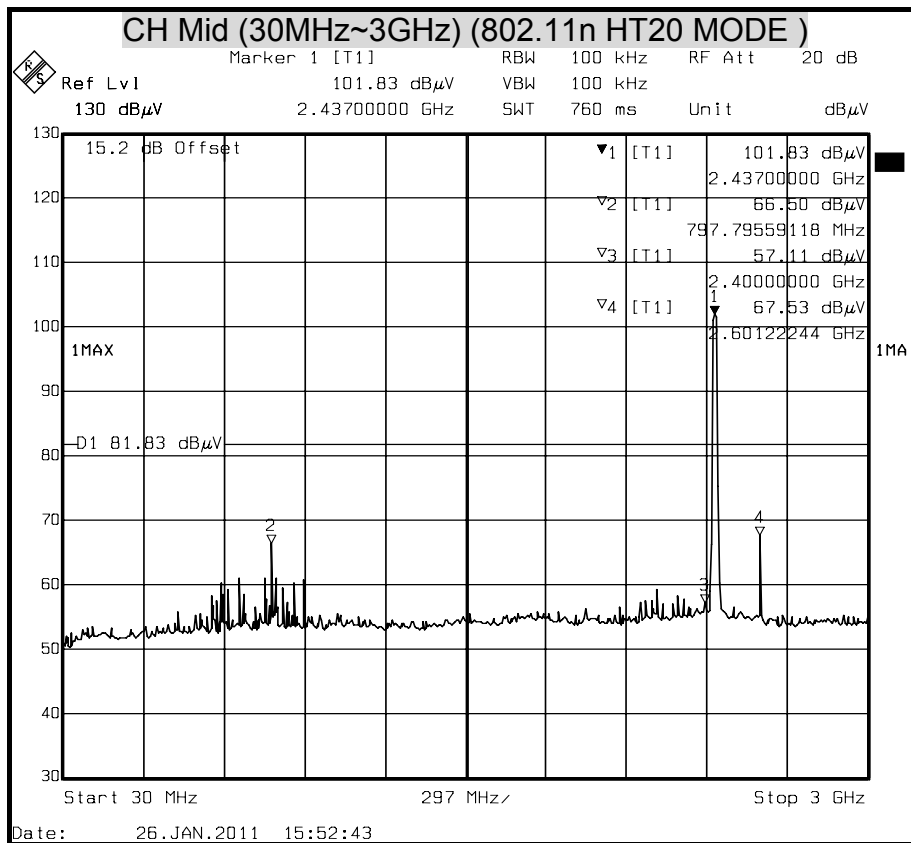

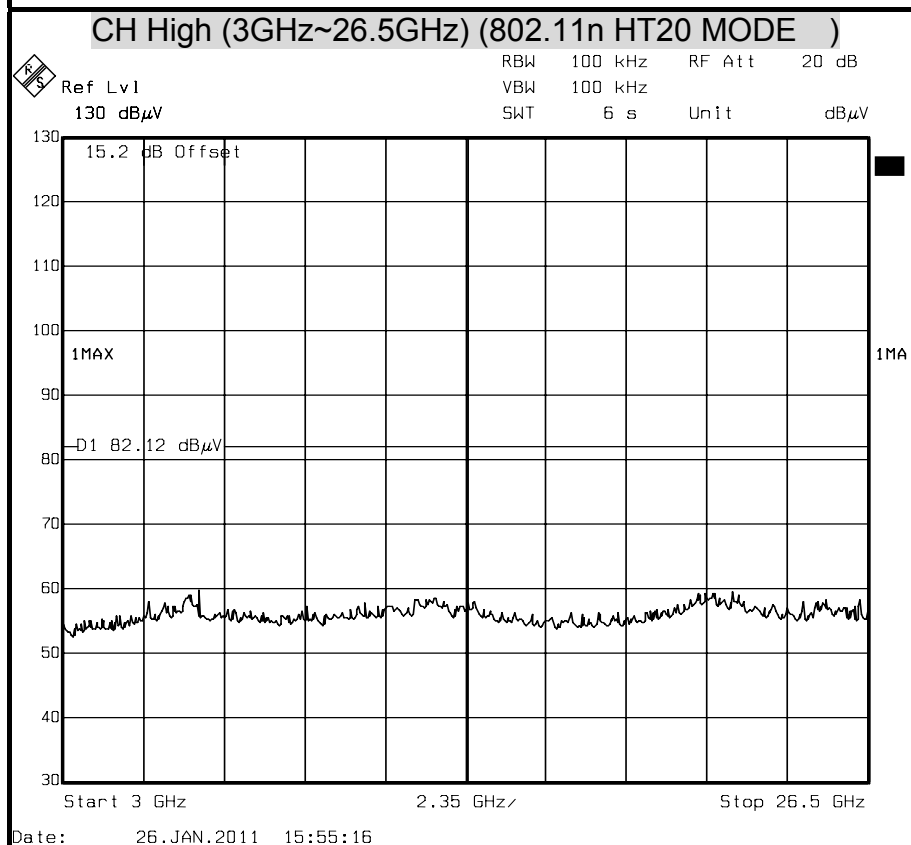
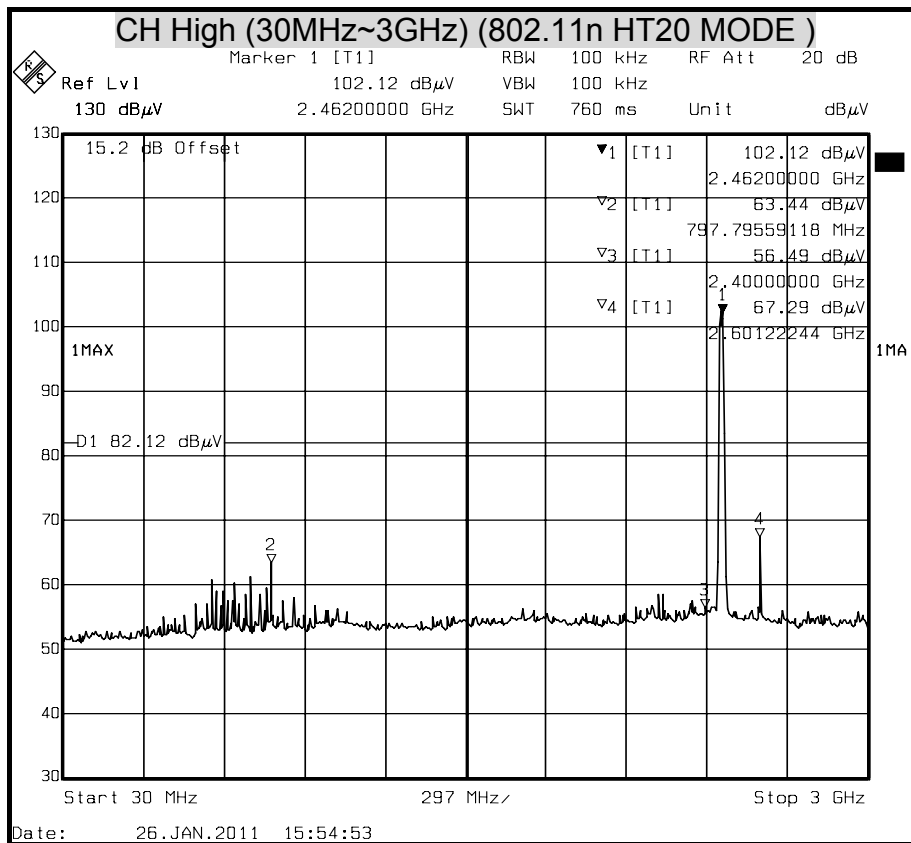



OUT-OF-BAND SPURIOUS EMISSIONS-CONDUCTED MEASUREMENT (802.11n HT40 Combined Mode)

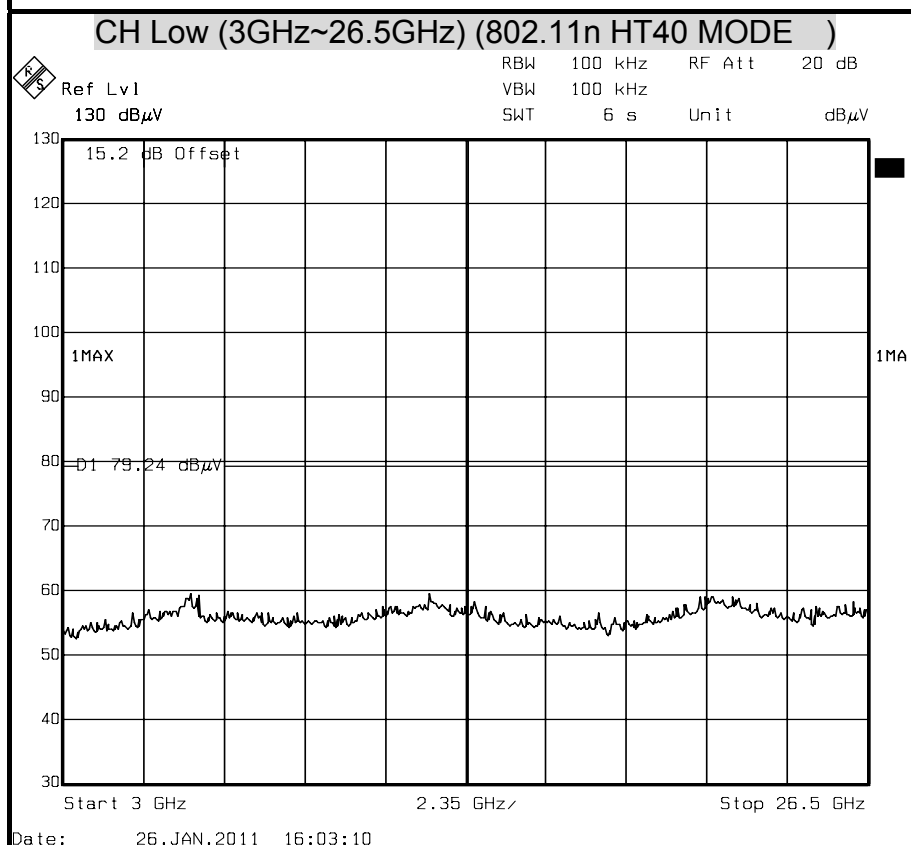
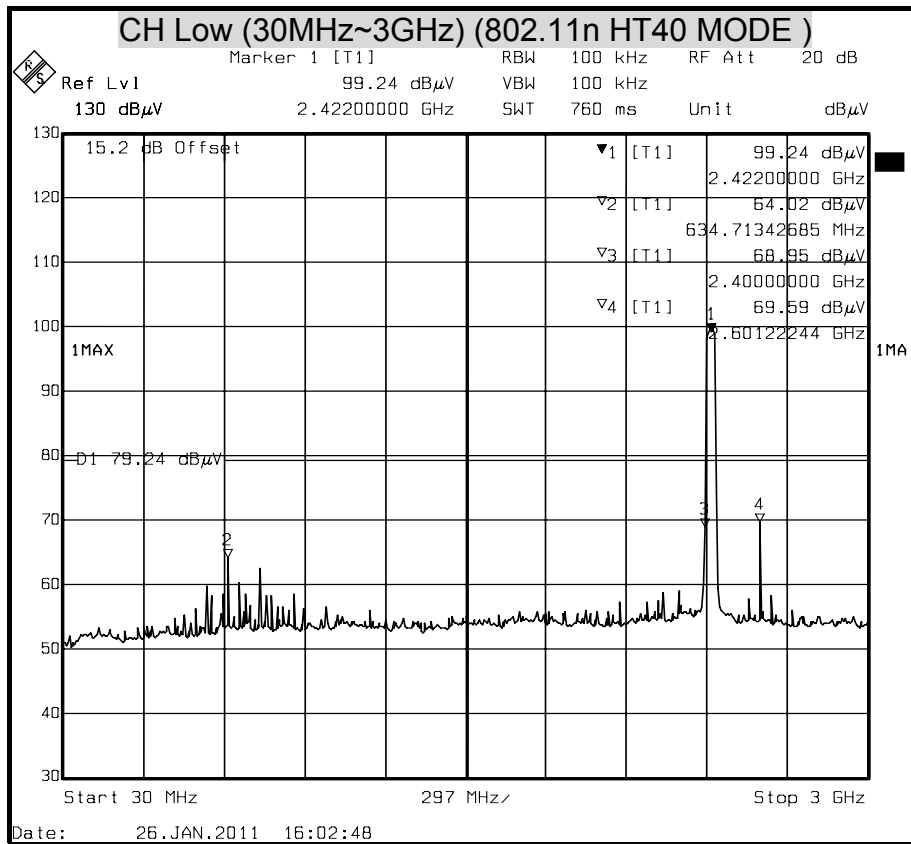

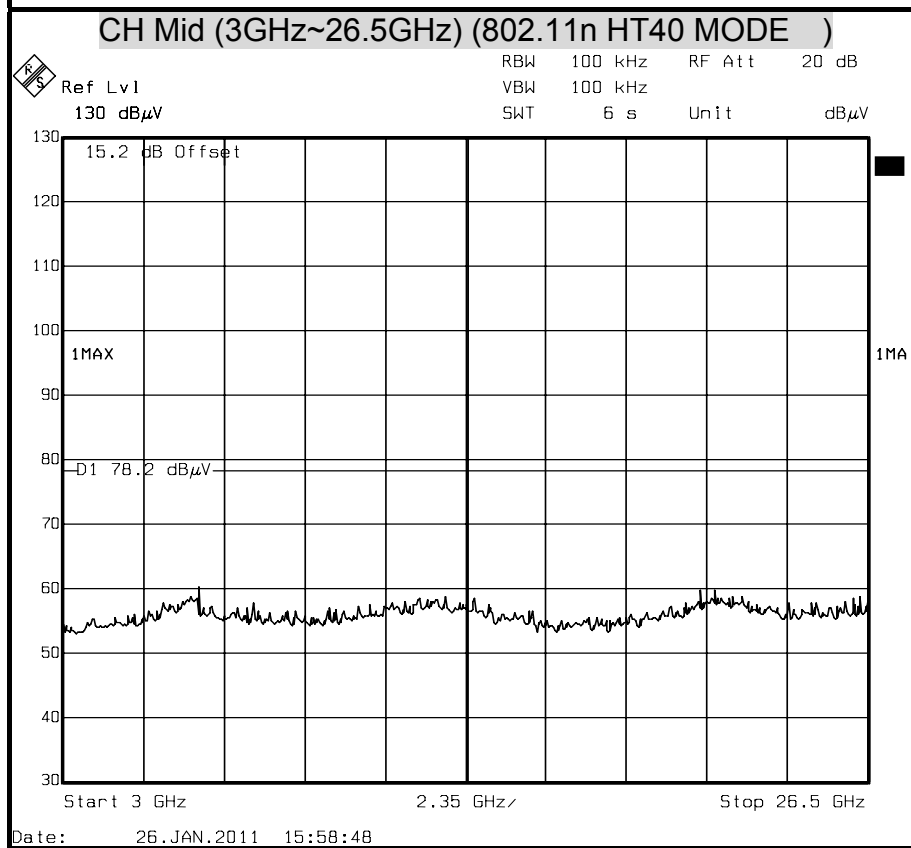
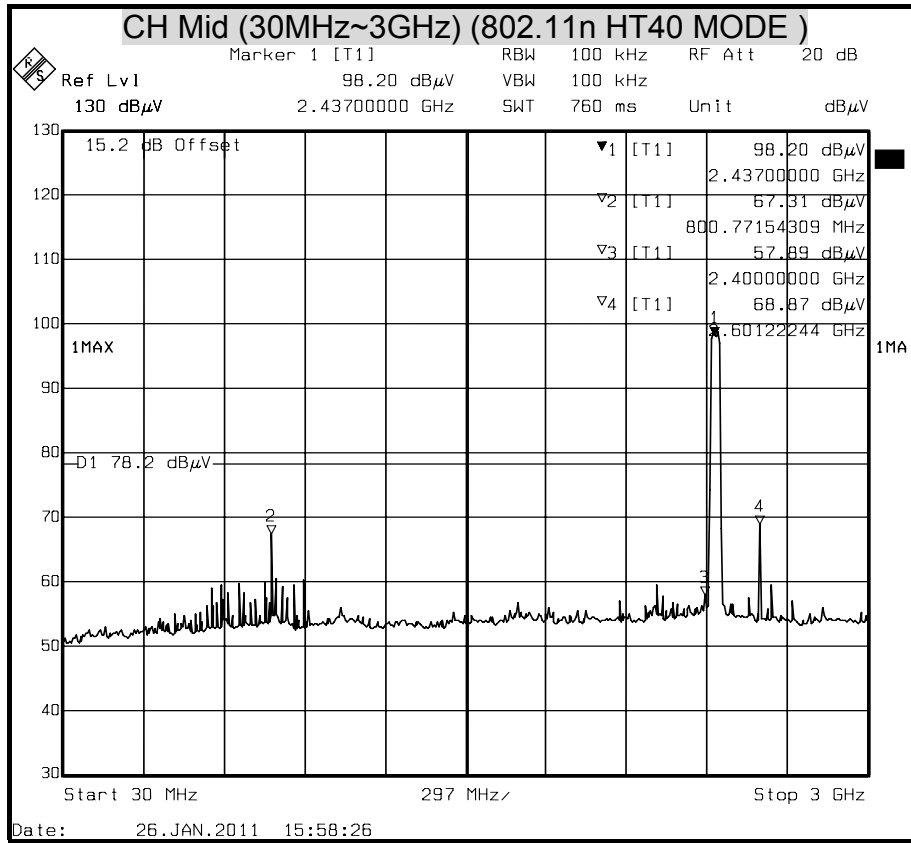

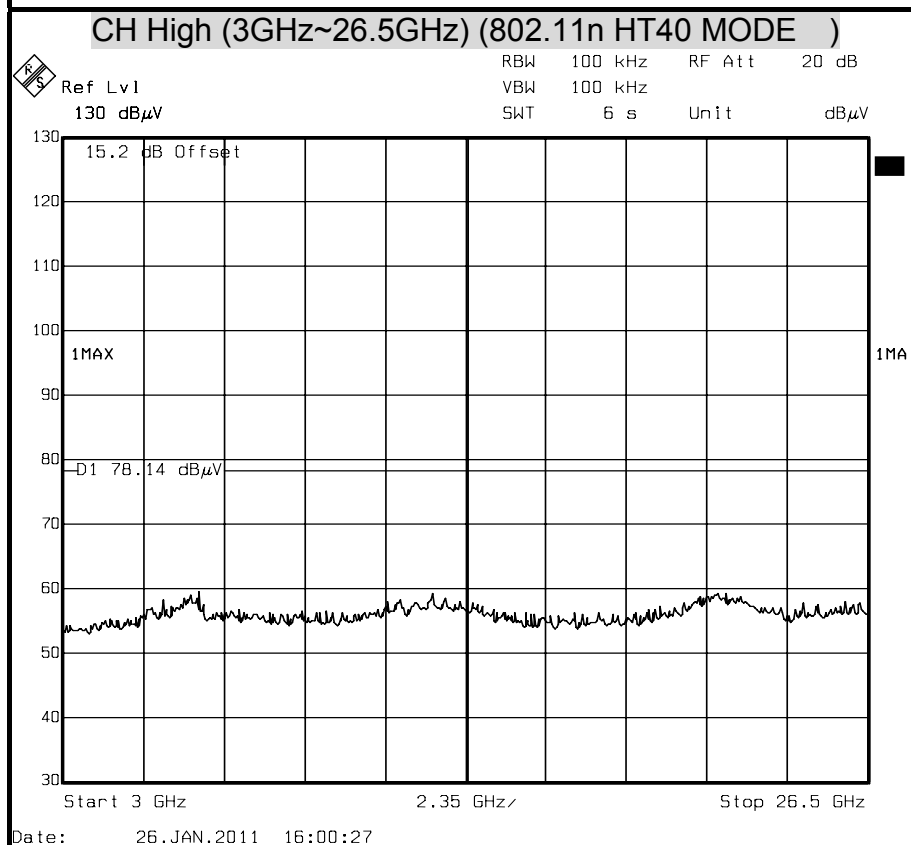
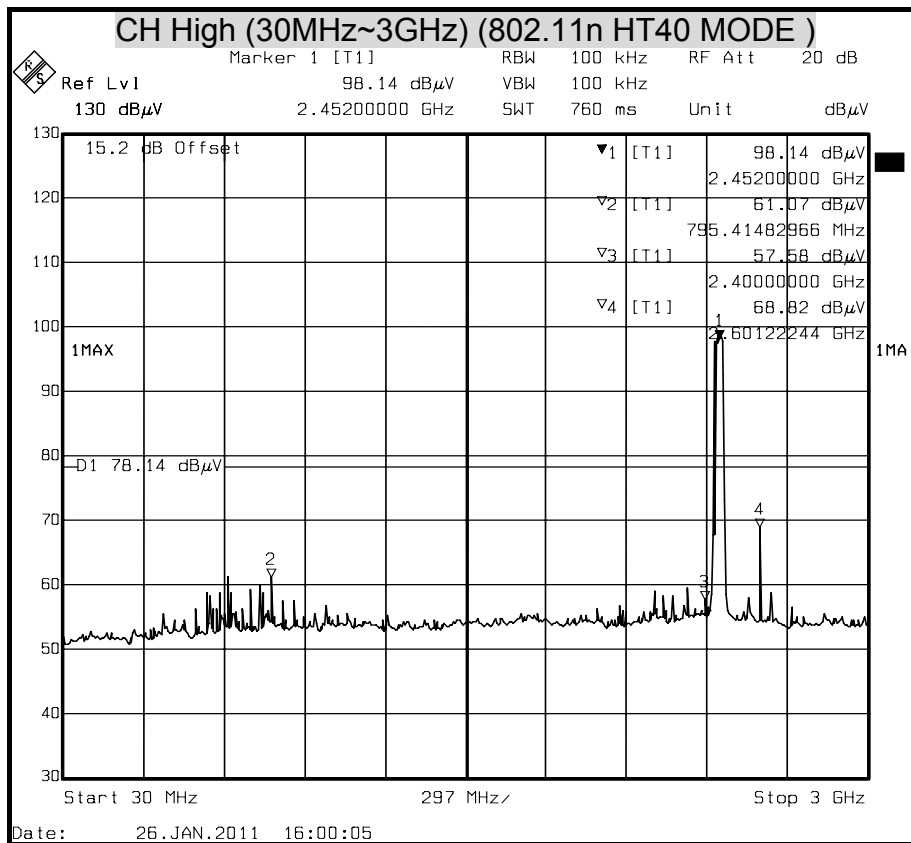



8.6 RADIATED EMISSIONS

8.6.1 TRANSMITTER RADIATED SUPURIOUS EMSSIONS

LIMITS

§ 15.205 (a) Except as shown in paragraph (d) of this section, only spurious emissions are permitted in any of the frequency bands listed below:

MHz	MHz	MHz	GHz
0.090 - 0.110	16.42 - 16.423	399.9 - 410	4.5 - 5.15
¹ 0.495 - 0.505	16.69475 - 16.69525	608 - 614	5.35 - 5.46
2.1735 - 2.1905	16.80425 - 16.80475	960 - 1240	7.25 - 7.75
4.125 - 4.128	25.5 - 25.67	1300 - 1427	8.025 - 8.5
4.17725 - 4.17775	37.5 - 38.25	1435 - 1626.5	9.0 - 9.2
4.20725 - 4.20775	73 - 74.6	1645.5 - 1646.5	9.3 - 9.5
6.215 - 6.218	74.8 - 75.2	1660 -1710	10.6 -12.7
6.26775 - 6.26825	108 -121.94	1718.8 - 1722.2	13.25 -13.4
6.31175 - 6.31225	123 - 138	2200 - 2300	14.47 – 14.5
8.291 - 8.294	149.9 - 150.05	2310 - 2390	15.35 -16.2
8.362 - 8.366	156.52475 - 156.52525	2483.5 - 2500	17.7 - 21.4
8.37625 - 8.38675	156.7 - 156.9	2655 - 2900	22.01 - 23.12
8.41425 - 8.41475	162.0125 - 167.17	3260 - 3267	23.6 - 24.0
12.29 - 12.293	167.72 - 173.2	3332 - 3339	31.2 - 31.8
12.51975 - 12.52025	240 - 285	3345.8 - 3338	36.43 - 36.5
12.57675 - 12.57725	322 -335.4	3600 - 4400	(²)
13.36 - 13.41			

¹ Until February 1, 1999, this restricted band shall be 0.490-0.510 MHz.

² Above 38.6



§ 15.205 (b) Except as provided in paragraphs (d) and (e), the field strength of emissions appearing within these frequency bands shall not exceed the limits shown in Section 15.209. At frequencies equal to or less than 1000 MHz, compliance with the limits in Section 15.209 shall be demonstrated using measurement instrumentation employing a CISPR quasi-peak detector. Above 1000 MHz, compliance with the emission limits in Section 15.209 shall be demonstrated based on the average value of the measured emissions. The provisions in Section 15.35 apply to these measurements.

§ 15.209 (a) Except as provided elsewhere in this Subpart, the emissions from an intentional radiator shall not exceed the field strength levels specified in the following table :

Frequency (MHz)	Field Strength (microvolts/meter)	Measurement Distance (meters)
30 - 88	100 **	3
88 - 216	150 **	3
216 - 960	200 **	3
Above 960	500	3

** Except as provided in paragraph (g), fundamental emissions from intentional radiators operating under this Section shall not be located in the frequency bands 54-72 MHz, 76-88 MHz, 174-216 MHz or 470-806 MHz, However, operation within these frequency bands is permitted under other sections of this Part, e-g, Sections 15.231 and 15.241.

§ 15.209 (b) In the emission table above, the tighter limit applies at the band edges.



TEST EQUIPMENTS

The following test equipments are utilized in making the measurements contained in this report.

Open Area Test Site # 6				
Name of Equipment	Manufacturer	Model	Serial Number	Calibration Due
TYPE N COAXIAL CABLE	SUHNER	CHA9513	6	NOV. 17, 2011
BI-LOG Antenna	Sunol	JB1	A070506-2	OCT. 4, 2011
LOOP ANTENNA	EMCO	6502	8905-2356	JUN. 10, 2011
Pre-Amplifier	HP	8447F	2944A03817	NOV. 23, 2011
EMI Receiver	R&S	ESVS10	833206/012	MAY 10, 2011
RF Cable	SUHNER	SUCOFLEX104PEA	20520/4PEA	NOV. 10, 2011
Horn Antenna	Com-Power	AH-118	071032	DEC. 27, 2011
Spectrum Analyzer	R&S	FSEK 30	835253/002	JUL. 14, 2011
Pre-Amplifier	MITEQ	AFS44-00108650 -42-10P-44	1205908	NOV. 23, 2011
Turn Table	Yo Chen	001	-----	N.C.R.
Antenna Tower	AR	TP1000A	309874	N.C.R.
Controller	CT	SC101	-----	N.C.R.
RF Swicth	E-INSTRUMENT TELH LTD	ERS-180A	EC1204141	N.C.R
Test S/W	e-3 (5.04303e)			



TEST SETUP

The diagram below shows the test setup that is utilized to make the measurements for emission from 30 to 1GHz.

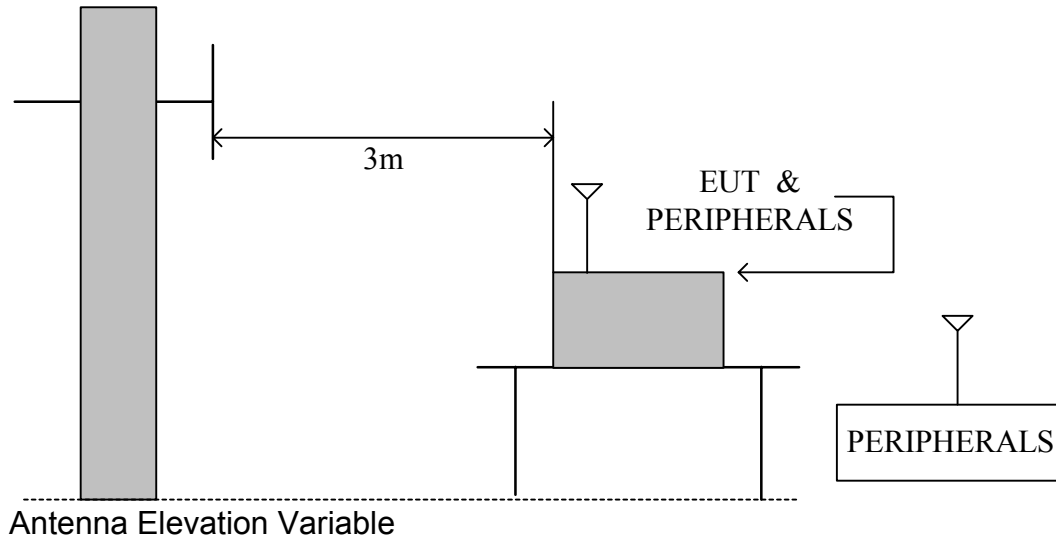

The diagram below shows the test setup that is utilized to make the measurements for emission above 1GHz.

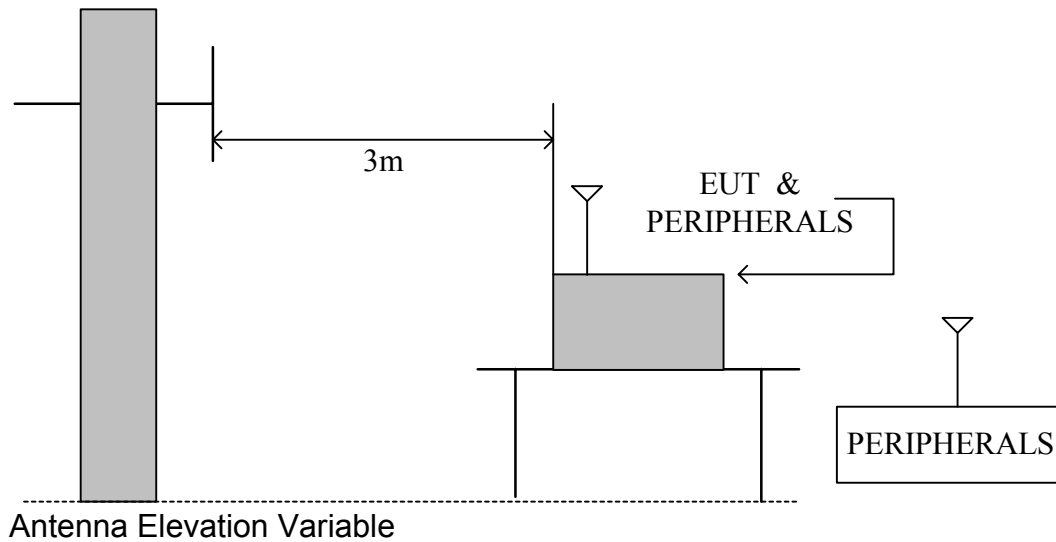



TEST PROCEDURE

- a. The EUT was placed on the top of a rotating table 0.8 meters above the ground at a 10 meter open area test site. The table was rotated 360 degrees to determine the position of the highest radiation.
- b. While measuring the radiated emission below 1GHz, the EUT was set 3 meters away from the interference-receiving antenna, which was mounted on the top of a variable-height antenna tower. While measuring the radiated emission above 1GHz, the EUT was set 3 meters away from the interference-receiving antenna
- c. The antenna is a broadband antenna, and its height is varied from one meter to four meters above the ground to determine the maximum value of the field strength. Both horizontal and vertical polarization of the antenna are set to make the measurement.
- d. For each suspected emission, the EUT was arranged to its worst case and then the antenna was tuned to heights from 1 meter to 4 meters and the table was turned from 0 degrees to 360 degrees to find the maximum reading.
- e. The test-receiver system was set to Peak Detect Function and Specified Bandwidth with Maximum Hold Mode.
- f. If the emission level of the EUT in peak mode was 10 dB lower than the limit specified, then testing could be stopped and the peak values of the EUT would be reported. Otherwise the emissions that did not have 10 dB margin would be re-tested one by one using peak, quasi-peak or average method as specified and then reported in a data sheet.

NOTE:

1. The resolution bandwidth and video bandwidth of test receiver/spectrum analyzer is 120 KHz for Peak detection (PK) and Quasi-peak detection (QP) at frequency below 1GHz.
2. The resolution bandwidth and video bandwidth of test receiver/spectrum analyzer is 1 MHz for Peak detection and frequency above 1GHz.
3. The resolution bandwidth of test receiver/spectrum analyzer is 1 MHz and the video bandwidth is 10 Hz for Average detection (AV) at frequency above 1GHz.
4. **No emission is found between lowest internal used/generated frequency to 30MHz (9kHz~30MHz)**

TEST RESULTS

No non-compliance noted.



8.6.2 WORST-CASE RADIATED EMISSION BELOW 1 GHz

Product Name	N+ High Power Broadband Router - All Broadbands	Test Date	2011/1/31
Model	BR280n	Test By	Vision Chang
Test Mode	Normal operating (worst case)	TEMP& Humidity	19.8°C, 49%

Horizontal

Frequency	Meter Reading	Antenna Factor	Cable Loss	Emission Level	Limits	Margin	Detector Mode
(MHz)	(dBµV)	(dB/M)	(dB)	(dBµV/M)	(dBµV/M)	(dB)	PK/QP
110.37	13.20	8.00	1.69	22.89	43.50	-20.61	QP
141.85	13.20	13.91	2.04	29.15	43.50	-14.35	QP
151.47	15.80	13.52	2.09	31.41	43.50	-12.09	QP
156.23	17.90	13.41	2.14	33.46	43.50	-10.04	QP
312.47	19.30	14.44	3.42	37.16	46.00	-8.84	QP
468.76	15.60	17.58	4.53	37.71	46.00	-8.29	QP
N/A	----	----	----	----	----	----	----

Vertical

Frequency	Meter Reading	Antenna Factor	Cable Loss	Emission Level	Limits	Margin	Detector Mode
(MHz)	(dBµV)	(dB/M)	(dB)	(dBµV/M)	(dBµV/M)	(dB)	PK/QP
38.95	14.10	18.70	1.05	33.85	40.00	-6.15	QP
141.85	14.20	13.91	2.04	30.15	43.50	-13.35	QP
151.47	17.10	13.52	2.09	32.71	43.50	-10.79	QP
156.28	23.50	13.41	2.15	39.05	43.50	-4.45	QP
312.46	15.30	14.44	3.42	33.16	46.00	-12.84	QP
468.76	18.50	17.58	4.53	40.61	46.00	-5.39	QP
N/A	----	----	----	----	----	----	----

REMARK: Emission level (dBµV/m) =Antenna Factor (dB/m) + Cable loss (dB) + Meter Reading (dBµV).



8.6.3 TRANSMITTER RADIATED EMISSION ABOVE 1 GHz

Product Name	N+ High Power Broadband Router - All Broadbands	Test Date	2011/1/17
Model	BR280n	Test By	John Chen
Test Mode	IEEE 802.11b TX (CH Low)	TEMP& Humidity	19.8°C, 49%

Horizontal

TX / IEEE 802.11b mode / CH Low				Measurement Distance at 3m				Horizontal polarity	
Freq.	Reading	AF	Cable Loss	Pre-amp	Filter	Level	Limit	Margin	Mark
(MHz)	(dBµV)	(dB/m)	(dB)	(dB)	(dB)	(dBµV/m)	(dBµV/m)	(dB)	(P/Q/A)
* 4824.06	51.31	33.17	3.73	42.38	0.69	46.52	74.00	-27.48	P
* 4824.06	44.48	33.17	3.73	42.38	0.69	39.69	54.00	-14.31	A
5199.77	50.99	33.78	3.81	42.77	0.81	46.62	74.00	-27.38	P
5199.77	44.77	33.78	3.81	42.77	0.81	40.40	54.00	-13.60	A
7234.84	50.16	38.60	4.67	41.84	1.43	53.03	74.00	-20.97	P
7234.84	42.25	38.60	4.67	41.84	1.43	45.12	54.00	-8.88	A
N/A	-----	-----	-----	-----	-----	-----	-----	-----	P
N/A	-----	-----	-----	-----	-----	-----	-----	-----	A

REMARK:

1. AF: Antenna Factor, Cable: Cable Loss, Pre-Amp: Preamplifier gain, Filter: High Pass Filter Insertion Loss (3.5GHz)
2. Spectrum analyzer setting P(Peak): RBW=1MHz, VBW=1MHz, A(Average): RBW=1MHz, VBW=10Hz
3. The result basic equation calculation is as follow:
Level = Reading + AF + Cable – Preamp + Filter – Dist, Margin = Level-Limit
4. The other emission levels were 20dB below the limit
5. The test limit distance is 3M limit.



Product Name	N+ High Power Broadband Router - All Broadbands	Test Date	2011/1/17
Model	BR280n	Test By	John Chen
Test Mode	IEEE 802.11b TX (CH Low)	TEMP& Humidity	19.8°C, 49%

Vertical

TX / IEEE 802.11b mode / CH Low				Measurement Distance at 3m				Vertical polarity	
Freq.	Reading	AF	Cable Loss	Pre-amp	Filter	Level	Limit	Margin	Mark
(MHz)	(dBµV)	(dB/m)	(dB)	(dB)	(dB)	(dBµV/m)	(dBµV/m)	(dB)	(P/Q/A)
1249.98	48.19	25.55	2.10	41.76	0.74	34.82	74.00	-39.18	P
1249.98	38.13	25.55	2.10	41.76	0.74	24.76	54.00	-29.24	A
* 4824.03	52.64	33.17	3.73	42.38	0.69	47.85	74.00	-26.15	P
* 4824.03	46.55	33.17	3.73	42.38	0.69	41.76	54.00	-12.24	A
N/A	-----	-----	-----	-----	-----	-----	-----	-----	P
N/A	-----	-----	-----	-----	-----	-----	-----	-----	A

REMARK:

1. AF: Antenna Factor, Cable: Cable Loss, Pre-Amp: Preamplifier gain, Filter: High Pass Filter Insertion Loss (3.5GHz)
2. Spectrum analyzer setting P(Peak): RBW=1MHz, VBW=1MHz, A(Average): RBW=1MHz, VBW=10Hz
3. The result basic equation calculation is as follow:
Level = Reading + AF + Cable – Preamp + Filter – Dist, Margin = Level-Limit
4. The other emission levels were 20dB below the limit
5. The test limit distance is 3M limit.



Product Name	N+ High Power Broadband Router - All Broadbands	Test Date	2011/1/17
Model	BR280n	Test By	John Chen
Test Mode	IEEE 802.11b TX (CH Middle)	TEMP& Humidity	19.8°C, 49%

Horizontal

TX / IEEE 802.11b mode / CH Middle				Measurement Distance at 3m				Horizontal polarity		
Freq.	Reading	AF	Cable Loss	Pre-amp	Filter	Level	Limit	Margin	Mark	
(MHz)	(dBµV)	(dB/m)	(dB)	(dB)	(dB)	(dBµV/m)	(dBµV/m)	(dB)	(P/Q/A)	
* 4873.98	52.47	33.32	3.74	42.43	0.71	47.81	74.00	-26.19	P	
* 4873.98	43.08	33.32	3.74	42.43	0.71	38.42	54.00	-15.58	A	
5199.95	52.27	33.78	3.81	42.77	0.81	47.90	74.00	-26.10	P	
5199.95	44.03	33.78	3.81	42.77	0.81	39.66	54.00	-14.34	A	
* 7311.81	51.77	38.84	4.71	41.72	1.60	55.19	74.00	-18.81	P	
* 7311.81	42.89	38.84	4.71	41.72	1.60	46.31	54.00	-7.69	A	
N/A	-----	-----	-----	-----	-----	-----	-----	-----	P	
N/A	-----	-----	-----	-----	-----	-----	-----	-----	A	

REMARK:

1. AF: Antenna Factor, Cable: Cable Loss, Pre-Amp: Preamplifier gain, Filter: High Pass Filter Insertion Loss (3.5GHz)
2. Spectrum analyzer setting P(Peak): RBW=1MHz, VBW=1MHz, A(Average): RBW=1MHz, VBW=10Hz
3. The result basic equation calculation is as follow:
Level = Reading + AF + Cable – Preamp + Filter – Dist, Margin = Level-Limit
4. The other emission levels were 20dB below the limit
5. The test limit distance is 3M limit.



Product Name	N+ High Power Broadband Router - All Broadbands	Test Date	2011/1/17
Model	BR280n	Test By	John Chen
Test Mode	IEEE 802.11b TX (CH Middle)	TEMP& Humidity	19.8°C, 49%

Vertical

TX / IEEE 802.11b mode / CH Middle				Measurement Distance at 3m				Vertical polarity	
Freq.	Reading	AF	Cable Loss	Pre-amp	Filter	Level	Limit	Margin	Mark
(MHz)	(dBμV)	(dB/m)	(dB)	(dB)	(dB)	(dBμV/m)	(dBμV/m)	(dB)	(P/Q/A)
1250.02	48.84	25.55	2.10	41.75	0.74	35.48	74.00	-38.52	P
1250.02	42.27	25.55	2.10	41.75	0.74	28.91	54.00	-25.09	A
* 4874.02	51.29	33.32	3.74	42.43	0.71	46.63	74.00	-27.37	P
* 4874.02	44.88	33.32	3.74	42.43	0.71	40.22	54.00	-13.78	A
N/A	-----	-----	-----	-----	-----	-----	-----	-----	P
N/A	-----	-----	-----	-----	-----	-----	-----	-----	A

REMARK:

1. AF: Antenna Factor, Cable: Cable Loss, Pre-Amp: Preamplifier gain, Filter: High Pass Filter Insertion Loss (3.5GHz)
2. Spectrum analyzer setting P(Peak): RBW=1MHz, VBW=1MHz, A(Average): RBW=1MHz, VBW=10Hz
3. The result basic equation calculation is as follow:
Level = Reading + AF + Cable – Preamp + Filter – Dist, Margin = Level-Limit
4. The other emission levels were 20dB below the limit
5. The test limit distance is 3M limit.



Product Name	N+ High Power Broadband Router - All Broadbands	Test Date	2011/1/17
Model	BR280n	Test By	John Chen
Test Mode	IEEE 802.11b TX (CH High)	TEMP& Humidity	19.8°C, 49%

Horizontal

TX / IEEE 802.11b mode / CH High				Measurement Distance at 3m				Horizontal polarity	
Freq.	Reading	AF	Cable Loss	Pre-amp	Filter	Level	Limit	Margin	Mark
(MHz)	(dBμV)	(dB/m)	(dB)	(dB)	(dB)	(dBμV/m)	(dBμV/m)	(dB)	(P/Q/A)
* 4924.14	51.82	33.47	3.76	42.48	0.73	47.30	74.00	-26.70	P
* 4924.14	43.88	33.47	3.76	42.48	0.73	39.36	54.00	-14.64	A
5199.82	51.88	33.78	3.81	42.77	0.81	47.51	74.00	-26.49	P
5199.82	44.12	33.78	3.81	42.77	0.81	39.75	54.00	-14.25	A
* 7386.41	51.88	39.06	4.75	41.61	1.76	55.83	74.00	-18.17	P
* 7386.41	42.01	39.06	4.75	41.61	1.76	45.96	54.00	-8.04	A
N/A	-----	-----	-----	-----	-----	-----	-----	-----	P
N/A	-----	-----	-----	-----	-----	-----	-----	-----	A

REMARK:

1. AF: Antenna Factor, Cable: Cable Loss, Pre-Amp: Preamplifier gain, Filter: High Pass Filter Insertion Loss (3.5GHz)
2. Spectrum analyzer setting P(Peak): RBW=1MHz, VBW=1MHz, A(Average): RBW=1MHz, VBW=10Hz
3. The result basic equation calculation is as follow:
Level = Reading + AF + Cable – Preamp + Filter – Dist, Margin = Level-Limit
4. The other emission levels were 20dB below the limit
5. The test limit distance is 3M limit.



Product Name	N+ High Power Broadband Router - All Broadbands	Test Date	2011/1/17
Model	BR280n	Test By	John Chen
Test Mode	IEEE 802.11b TX (CH High)	TEMP& Humidity	19.8°C, 49%

Vertical

TX / IEEE 802.11b mode / CH High				Measurement Distance at 3m				Vertical polarity	
Freq.	Reading	AF	Cable Loss	Pre-amp	Filter	Level	Limit	Margin	Mark
(MHz)	(dBµV)	(dB/m)	(dB)	(dB)	(dB)	(dBµV/m)	(dBµV/m)	(dB)	(P/Q/A)
1249.98	54.74	25.55	2.10	41.76	0.74	41.37	74.00	-32.63	P
1249.98	44.68	25.55	2.10	41.76	0.74	31.31	54.00	-22.69	A
* 4923.91	49.86	33.47	3.76	42.48	0.73	45.34	74.00	-28.66	P
* 4923.91	43.22	33.47	3.76	42.48	0.73	38.70	54.00	-15.30	A
N/A	-----	-----	-----	-----	-----	-----	-----	-----	P
N/A	-----	-----	-----	-----	-----	-----	-----	-----	A

REMARK:

1. AF: Antenna Factor, Cable: Cable Loss, Pre-Amp: Preamplifier gain, Filter: High Pass Filter Insertion Loss (3.5GHz)
2. Spectrum analyzer setting P(Peak): RBW=1MHz, VBW=1MHz, A(Average): RBW=1MHz, VBW=10Hz
3. The result basic equation calculation is as follow:
Level = Reading + AF + Cable – Preamp + Filter – Dist, Margin = Level-Limit
4. The other emission levels were 20dB below the limit
5. The test limit distance is 3M limit.



Product Name	N+ High Power Broadband Router - All Broadbands	Test Date	2011/1/17
Model	BR280n	Test By	John Chen
Test Mode	IEEE 802.11g TX (CH Low)	TEMP& Humidity	19.8°C, 49%

Horizontal

TX / IEEE 802.11g mode / CH Low				Measurement Distance at 3m				Horizontal polarity	
Freq.	Reading	AF	Cable Loss	Pre-amp	Filter	Level	Limit	Margin	Mark
(MHz)	(dBμV)	(dB/m)	(dB)	(dB)	(dB)	(dBμV/m)	(dBμV/m)	(dB)	(P/Q/A)
* 4824.07	50.14	33.17	3.73	42.38	0.69	45.35	74.00	-28.65	P
* 4824.07	43.38	33.17	3.73	42.38	0.69	38.59	54.00	-15.41	A
7234.90	49.27	38.60	4.67	41.84	1.43	52.14	74.00	-21.86	P
7234.90	41.84	38.60	4.67	41.84	1.43	44.71	54.00	-9.29	A
N/A	-----	-----	-----	-----	-----	-----	-----	-----	P
N/A	-----	-----	-----	-----	-----	-----	-----	-----	A

REMARK:

1. AF: Antenna Factor, Cable: Cable Loss, Pre-Amp: Preamplifier gain, Filter: High Pass Filter Insertion Loss (3.5GHz)
2. Spectrum analyzer setting P(Peak): RBW=1MHz, VBW=1MHz, A(Average): RBW=1MHz, VBW=10Hz
3. The result basic equation calculation is as follow:
Level = Reading + AF + Cable – Preamp + Filter – Dist, Margin = Level-Limit
4. The other emission levels were 20dB below the limit
5. The test limit distance is 3M limit.



Product Name	N+ High Power Broadband Router - All Broadbands	Test Date	2011/1/17
Model	BR280n	Test By	John Chen
Test Mode	IEEE 802.11g TX (CH Low)	TEMP& Humidity	19.8°C, 49%

Vertical

TX / IEEE 802.11g mode / CH Low				Measurement Distance at 3m				Vertical polarity	
Freq.	Reading	AF	Cable Loss	Pre-amp	Filter	Level	Limit	Margin	Mark
(MHz)	(dBµV)	(dB/m)	(dB)	(dB)	(dB)	(dBµV/m)	(dBµV/m)	(dB)	(P/Q/A)
1249.99	47.69	25.55	2.10	41.76	0.74	34.32	74.00	-39.68	P
1249.99	37.55	25.55	2.10	41.76	0.74	24.18	54.00	-29.82	A
* 4824.16	51.36	33.17	3.73	42.38	0.69	46.57	74.00	-27.43	P
* 4824.16	45.95	33.17	3.73	42.38	0.69	41.16	54.00	-12.84	A
N/A	-----	-----	-----	-----	-----	-----	-----	-----	P
N/A	-----	-----	-----	-----	-----	-----	-----	-----	A

REMARK:

1. AF: Antenna Factor, Cable: Cable Loss, Pre-Amp: Preamplifier gain, Filter: High Pass Filter Insertion Loss (3.5GHz)
2. Spectrum analyzer setting P(Peak): RBW=1MHz, VBW=1MHz, A(Average): RBW=1MHz, VBW=10Hz
3. The result basic equation calculation is as follow:
Level = Reading + AF + Cable – Preamp + Filter – Dist, Margin = Level-Limit
4. The other emission levels were 20dB below the limit
5. The test limit distance is 3M limit.



Product Name	N+ High Power Broadband Router - All Broadbands	Test Date	2011/1/17
Model	BR280n	Test By	John Chen
Test Mode	IEEE 802.11g TX (CH Middle)	TEMP& Humidity	19.8°C, 49%

Horizontal

TX / IEEE 802.11g		mode / CH Middle		Measurement Distance at 3m				Horizontal polarity	
Freq.	Reading	AF	Cable Loss	Pre-amp	Filter	Level	Limit	Margin	Mark
(MHz)	(dBμV)	(dB/m)	(dB)	(dB)	(dB)	(dBμV/m)	(dBμV/m)	(dB)	(P/Q/A)
* 4873.87	51.71	33.32	3.74	42.43	0.71	47.05	74.00	-26.95	P
* 4873.87	42.59	33.32	3.74	42.43	0.71	37.93	54.00	-16.07	A
* 7311.43	50.37	38.83	4.71	41.72	1.60	53.79	74.00	-20.21	P
* 7311.43	41.97	38.83	4.71	41.72	1.60	45.39	54.00	-8.61	A
N/A	-----	-----	-----	-----	-----	-----	-----	-----	P
N/A	-----	-----	-----	-----	-----	-----	-----	-----	A

REMARK:

1. AF: Antenna Factor, Cable: Cable Loss, Pre-Amp: Preamplifier gain, Filter: High Pass Filter Insertion Loss (3.5GHz)
2. Spectrum analyzer setting P(Peak): RBW=1MHz, VBW=1MHz, A(Average): RBW=1MHz, VBW=10Hz
3. The result basic equation calculation is as follow:
Level = Reading + AF + Cable – Preamp + Filter – Dist, Margin = Level-Limit
4. The other emission levels were 20dB below the limit
5. The test limit distance is 3M limit.



Product Name	N+ High Power Broadband Router - All Broadbands	Test Date	2011/1/17
Model	BR280n	Test By	John Chen
Test Mode	IEEE 802.11g TX (CH Middle)	TEMP& Humidity	19.8°C, 49%

Vertical

TX / IEEE 802.11g mode / CH Middle				Measurement Distance at 3m				Vertical polarity	
Freq.	Reading	AF	Cable Loss	Pre-amp	Filter	Level	Limit	Margin	Mark
(MHz)	(dBµV)	(dB/m)	(dB)	(dB)	(dB)	(dBµV/m)	(dBµV/m)	(dB)	(P/Q/A)
1250.12	47.62	25.55	2.10	41.75	0.74	34.26	74.00	-39.74	P
1250.12	41.85	25.55	2.10	41.75	0.74	28.49	54.00	-25.51	A
* 4874.09	50.33	33.32	3.74	42.43	0.71	45.68	74.00	-28.32	P
* 4874.09	43.08	33.32	3.74	42.43	0.71	38.43	54.00	-15.57	A
N/A	-----	-----	-----	-----	-----	-----	-----	-----	P
N/A	-----	-----	-----	-----	-----	-----	-----	-----	A

REMARK:

1. AF: Antenna Factor, Cable: Cable Loss, Pre-Amp: Preamplifier gain, Filter: High Pass Filter Insertion Loss (3.5GHz)
2. Spectrum analyzer setting P(Peak): RBW=1MHz, VBW=1MHz, A(Average): RBW=1MHz, VBW=10Hz
3. The result basic equation calculation is as follow:
Level = Reading + AF + Cable – Preamp + Filter – Dist, Margin = Level-Limit
4. The other emission levels were 20dB below the limit
5. The test limit distance is 3M limit.



Product Name	N+ High Power Broadband Router - All Broadbands	Test Date	2011/1/17
Model	BR280n	Test By	John Chen
Test Mode	IEEE 802.11g TX (CH High)	TEMP& Humidity	19.8°C, 49%

Horizontal

TX / IEEE 802.11g mode / CH High				Measurement Distance at 3m				Horizontal polarity	
Freq.	Reading	AF	Cable Loss	Pre-amp	Filter	Level	Limit	Margin	Mark
(MHz)	(dBµV)	(dB/m)	(dB)	(dB)	(dB)	(dBµV/m)	(dBµV/m)	(dB)	(P/Q/A)
* 4924.20	50.74	33.47	3.76	42.48	0.73	46.22	74.00	-27.78	P
* 4924.20	42.93	33.47	3.76	42.48	0.73	38.41	54.00	-15.59	A
* 7386.35	50.18	39.06	4.75	41.61	1.76	54.13	74.00	-19.87	P
* 7386.35	41.38	39.06	4.75	41.61	1.76	45.33	54.00	-8.67	A
N/A	-----	-----	-----	-----	-----	-----	-----	-----	P
N/A	-----	-----	-----	-----	-----	-----	-----	-----	A

REMARK:

1. AF: Antenna Factor, Cable: Cable Loss, Pre-Amp: Preamplifier gain, Filter: High Pass Filter Insertion Loss (3.5GHz)
2. Spectrum analyzer setting P(Peak): RBW=1MHz, VBW=1MHz, A(Average): RBW=1MHz, VBW=10Hz
3. The result basic equation calculation is as follow:
Level = Reading + AF + Cable – Preamp + Filter – Dist, Margin = Level-Limit
4. The other emission levels were 20dB below the limit
5. The test limit distance is 3M limit.