



SAR EVALUATION REPORT

Applicant Name:
 NEC CASIO Mobile Communications, Ltd.
 1753 Shimonumabe, Nakahara-Ku Kawasaki
 Kanagawa, 211-8666
 Japan

Date of Testing:
 07/26/12 - 08/01/12
Test Site/Location:
 PCTEST Lab, Columbia, MD, USA
Document Serial No.:
 0Y1207251026-R1.TYK

FCC ID: TYK-EYC4287

APPLICANT: NEC CASIO Mobile Communications, Ltd.

DUT Type: Portable Handset
Application Type: Certification
FCC Rule Part(s): CFR §2.1093
Model(s): KMP7T4A1-1A
Test Device Serial No.: Pre-Production [S/N: KGM-U-002, KGM-U-004]

Band & Mode	Tx Frequency	Conducted Power [dBm]	SAR		
			1 gm Head (W/kg)	1 gm Body-Worn (W/kg)	1 gm Hotspot (W/kg)
Cell. CDMA	824.70 - 848.31 MHz	24.14	0.73	0.75	0.77
GSM/GPRS 850	824.20 - 848.80 MHz	33.60	0.75	0.86	0.86
WCDMA/HSPA 850	826.40 - 846.60 MHz	23.60	0.55	0.72	0.72
GSM/GPRS 1900	1850.20 - 1909.80 MHz	30.75	1.19	0.68	0.62
2.4 GHz WLAN	2412 - 2462 MHz	15.33	0.36	0.08	0.08
Bluetooth	2402 - 2480 MHz	0.63	N/A		
Simultaneous SAR per KDB 690783 D01:			1.37	0.89	0.94

Note: Powers in the above table represent output powers for the SAR test configurations and may not represent the highest output powers for all configurations for each mode.

Note: This revised Test Report (S/N: 0Y1207251026-R1.TYK) supersedes and replaces the previously issued test report on the same subject EUT for the same type of testing as indicated. Please discard or destroy the previously issued test report(s) and dispose of it accordingly.



This wireless portable device has been shown to be capable of compliance for localized specific absorption rate (SAR) for uncontrolled environment/general population exposure limits specified in ANSI/IEEE C95.1-1992 and has been tested in accordance with the measurement procedures specified in FCC/OET Bulletin 65 Supplement C (2001), IEEE 1528-2003 and in applicable Industry Canada Radio Standards Specifications (RSS); for North American frequency bands only.

I attest to the accuracy of data. All measurements reported herein were performed by me or were made under my supervision and are correct to the best of my knowledge and belief. I assume full responsibility for the completeness of these measurements and vouch for the qualifications of all persons taking them. Test results reported herein relate only to the item(s) tested.

PCTEST certifies that no party to this application has been subject to a denial of Federal benefits that includes FCC benefits pursuant to Section 5301 of the Anti-Drug Abuse Act of 1988, 21 U.S.C. 862.



 Randy Ortanez
 President



FCC ID: TYK-EYC4287		SAR EVALUATION REPORT		Reviewed by: Quality Manager
Document S/N: 0Y1207251026-R1.TYK	Test Dates: 07/26/12 - 08/01/12	DUT Type: Portable Handset	Page 1 of 38	

T A B L E O F C O N T E N T S

1	DEVICE UNDER TEST	3
2	INTRODUCTION	6
3	SAR MEASUREMENT SETUP	7
4	DOSIMETRIC ASSESSMENT	8
5	DEFINITION OF REFERENCE POINTS	9
6	TEST CONFIGURATION POSITIONS FOR HANDSETS	10
7	FCC RF EXPOSURE LIMITS.....	13
8	FCC MEASUREMENT PROCEDURES.....	14
9	RF CONDUCTED POWERS.....	18
10	SYSTEM VERIFICATION.....	23
11	SAR DATA SUMMARY	25
12	FCC MULTI-TX AND ANTENNA SAR CONSIDERATIONS.....	31
13	EQUIPMENT LIST	34
14	MEASUREMENT UNCERTAINTIES	35
15	CONCLUSION.....	36
16	REFERENCES	37

FCC ID: TYK-EYC4287		SAR EVALUATION REPORT		Reviewed by: Quality Manager
Document S/N: 0Y1207251026-R1.TYK	Test Dates: 07/26/12 - 08/01/12	DUT Type: Portable Handset	Page 2 of 38	

1 DEVICE UNDER TEST

1.1 Device Overview



Band & Mode	Tx Frequency
Cell. CDMA	824.70 - 848.31 MHz
GSM/GPRS 850	824.20 - 848.80 MHz
WCDMA/HSPA 850	826.40 - 846.60 MHz
GSM/GPRS 1900	1850.20 - 1909.80 MHz
2.4 GHz WLAN	2412 - 2462 MHz
Bluetooth	2402 - 2480 MHz

1.2 Near Field Communications (NFC) Antenna

This DUT has NFC operations. The NFC antenna is integrated into the standard battery cover and will be the only battery cover available from the manufacturer for this model. Therefore all SAR tests were performed with the standard battery cover which already integrates the NFC antenna.

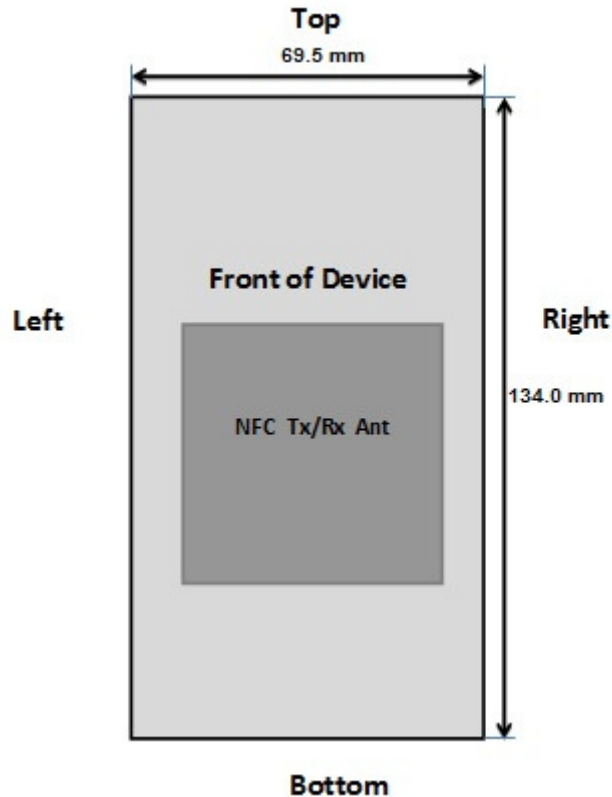
**Figure 1-1
NFC Antenna Locations**



FCC ID: TYK-EYC4287	 PCTEST ENGINEERING LABORATORY, INC.	SAR EVALUATION REPORT		Reviewed by: Quality Manager
Document S/N: 0Y1207251026-R1.TYK	Test Dates: 07/26/12 - 08/01/12	DUT Type: Portable Handset		Page 3 of 38

1.3 DUT Antenna Locations

**Figure 1-2
DUT Antenna Locations**

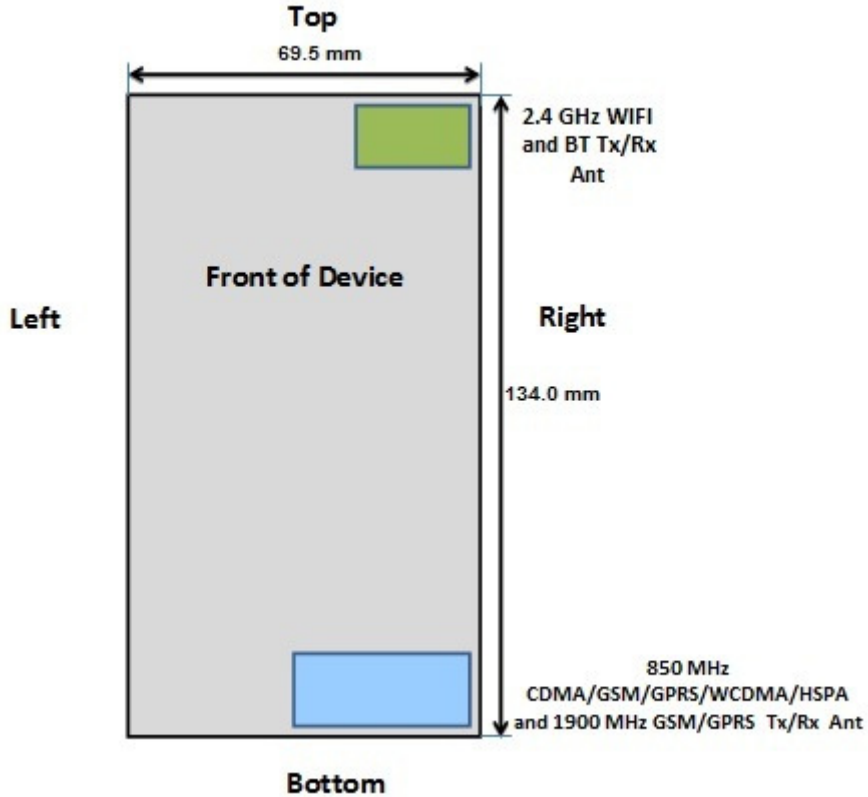

**Table 1-1
Mobile Hotspot Sides for SAR Testing**

Mobile Hotspot Sides for SAR Testing						
Mode	Back	Front	Top	Bottom	Right	Left
Cell. CDMA	Yes	Yes	No	Yes	Yes	No
GPRS 850	Yes	Yes	No	Yes	Yes	No
WCDMA 850	Yes	Yes	No	Yes	Yes	No
GPRS 1900	Yes	Yes	No	Yes	Yes	No
2.4 GHz WLAN	Yes	Yes	Yes	No	Yes	No

Note: Particular DUT edges were not required to be evaluated for Wireless Router SAR if the edges were greater than 2.5 cm from the transmitting antenna according to FCC KDB Publication 941225 D06 guidance, page 2. The antenna document shows the distances between the transmit antennas and the edges of the device.

FCC ID: TYK-EYC4287	PCTEST ENGINEERING LABORATORY, INC.	SAR EVALUATION REPORT		Reviewed by: Quality Manager
Document S/N: 0Y1207251026-R1.TYK	Test Dates: 07/26/12 - 08/01/12	DUT Type: Portable Handset		Page 4 of 38

1.4 SAR Test Exclusions Applied

(A) WIFI/BT

The separation between the main antenna and the Bluetooth and WLAN antennas is 97.7 mm. RF Conducted Power of Bluetooth Tx is 1.156 mW (Please refer to the EMC DSS Report for a full set of Bluetooth conducted powers).

2.4 GHz WIFI and Bluetooth share the same antenna path and cannot transmit simultaneously.

Per KDB Publication 648474, **Bluetooth SAR was not required** based on the maximum conducted power, the Bluetooth/WLAN to main antenna separation distance and Body-SAR of the main antenna.

(B) Licensed Transmitter(s)

This model does not support Simultaneous Voice and Data for the licensed transmitter in any modes except in WCDMA that allows Multi-RAB transmissions that share voice and data operations on a single physical channel. When the user utilizes multiple services in WCDMA 3G mode it uses multi-Radio Access Bearer or multi-RAB. The power control is based on a physical control channel (Dedicated Physical Control Channel [DPCCH]) and power control will be adjusted to meet the needs of both services. Therefore, the WCDMA+WLAN scenario also represents the WCDMA Voice/DATA + WLAN Hotspot scenario.



GSM/GPRS DTM is not supported. Therefore GSM Voice cannot transmit simultaneously with GPRS Data.

1.5 Power Reduction for SAR

There is no power reduction for any band/mode implemented in this device for SAR purposes.

1.6 Guidance Applied

- FCC OET Bulletin 65 Supplement C [June 2001]
- IEEE 1528-2003
- FCC KDB 941225 (2G/3G and Hotspot)
- FCC KDB 248227 (802.11)
- FCC KDB 648474 (Simultaneous)

FCC ID: TYK-EYC4287	 PCTEST ENGINEERING LABORATORY, INC.	SAR EVALUATION REPORT		Reviewed by: Quality Manager
Document S/N: 0Y1207251026-R1.TYK	Test Dates: 07/26/12 - 08/01/12	DUT Type: Portable Handset		Page 5 of 38

2 INTRODUCTION

The FCC has adopted the guidelines for evaluating the environmental effects of radio frequency (RF) radiation in ET Docket 93-62 on Aug. 6, 1996 to protect the public and workers from the potential hazards of RF emissions due to FCC-regulated portable devices. [1]

The safety limits used for the environmental evaluation measurements are based on the criteria published by the American National Standards Institute (ANSI) for localized specific absorption rate (SAR) in IEEE/ANSI C95.1-1992 Standard for Safety Levels with Respect to Human Exposure to Radio Frequency Electromagnetic Fields, 3 kHz to 300 GHz [3] and Health Canada RF Exposure Guidelines Safety Code 6 [24]. The measurement procedure described in IEEE/ANSI C95.3-2002 Recommended Practice for the Measurement of Potentially Hazardous Electromagnetic Fields - RF and Microwave [4] is used for guidance in measuring the Specific Absorption Rate (SAR) due to the RF radiation exposure from the Equipment Under Test (EUT). These criteria for SAR evaluation are similar to those recommended by the International Committee for Non-Ionizing Radiation Protection (ICNIRP) in Biological Effects and Exposure Criteria for Radiofrequency Electromagnetic Fields," Report No. Vol 74. SAR is a measure of the rate of energy absorption due to exposure to an RF transmitting source. SAR values have been related to threshold levels for potential biological hazards.

2.1 SAR Definition

Specific Absorption Rate is defined as the time derivative (rate) of the incremental energy (dU) absorbed by (dissipated in) an incremental mass (dm) contained in a volume element (dV) of a given density (ρ). It is also defined as the rate of RF energy absorption per unit mass at a point in an absorbing body (see Equation 2-1).

Equation 2-1
SAR Mathematical Equation

$$SAR = \frac{d}{dt} \left(\frac{dU}{dm} \right) = \frac{d}{dt} \left(\frac{dU}{\rho dV} \right)$$



SAR is expressed in units of Watts per Kilogram (W/kg).

$$SAR = \frac{\sigma \cdot E^2}{\rho}$$

where:

- σ = conductivity of the tissue-simulating material (S/m)
- ρ = mass density of the tissue-simulating material (kg/m^3)
- E = Total RMS electric field strength (V/m)

NOTE: The primary factors that control rate of energy absorption were found to be the wavelength of the incident field in relation to the dimensions and geometry of the irradiated organism, the orientation of the organism in relation to the polarity of field vectors, the presence of reflecting surfaces, and whether conductive contact is made by the organism with a ground plane.[6]

FCC ID: TYK-EYC4287	 PCTEST ENGINEERING LABORATORY, INC.	SAR EVALUATION REPORT	 NEC	Reviewed by: Quality Manager
Document S/N: 0Y1207251026-R1.TYK	Test Dates: 07/26/12 - 08/01/12	DUT Type: Portable Handset		Page 6 of 38

3 SAR MEASUREMENT SETUP

3.1 Automated SAR Measurement System

Measurements are performed using the DASY automated dosimetric SAR assessment system. The DASY is made by Schmid & Partner Engineering AG (SPEAG) in Zurich, Switzerland and consists of a high precision robotics system (Staubli), robot controller, desktop computer, near-field probe, probe alignment sensor, and the SAM phantom containing the head or body equivalent material. The robot is a six-axis industrial robot, performing precise movements to position the probe to the location (points) of maximum electromagnetic field (EMF). See www.speag.com for more information about the specification of the SAR assessment system.





Figure 3-1
SAR Measurement System



Figure 3-2
Near-Field Probe

Table 3-1
Composition of the Tissue Equivalent Matter

Frequency (MHz)	835	835	1900	1900	2450	2450
Tissue	Head	Body	Head	Body	Head	Body
Ingredients (% by weight)						
Bactericide	0.1	0.1				
DGBE			44.92	29.44	7.99	26.7
HEC	1	1				
NaCl	1.45	0.94	0.18	0.39	0.16	0.1
Sucrose	57	44.9				
Triton X-100					19.97	
Water	40.45	53.06	54.9	70.17	71.88	73.2

FCC ID: TYK-EYC4287		SAR EVALUATION REPORT		Reviewed by: Quality Manager
Document S/N: 0Y1207251026-R1.TYK	Test Dates: 07/26/12 - 08/01/12	DUT Type: Portable Handset		Page 7 of 38

4 DOSIMETRIC ASSESSMENT

4.1 Measurement Procedure

The evaluation was performed using the following procedure:

1. The SAR distribution at the exposed side of the head or body was measured at a distance no greater than 5.0 mm from the inner surface of the shell. The area covered the entire dimension of the device-head interface and the horizontal grid resolution was 15mm and 15mm for frequencies < 3 GHz in the x and y directions respectively. When applicable, for frequencies above 3 GHz, a 10 mm by 10 mm resolution was used.
2. The point SAR measurement was taken at the maximum SAR region determined from Step 1 to enable the monitoring of SAR fluctuations/drifts during the 1 gram cube evaluation. SAR at this fixed point was measured and used as a reference value.
3. Based on the area scan data, the peak area of the maximum absorption was determined by spline interpolation. Around this point, a volume of 32mm x 32mm x 30mm (fine resolution volume scan, zoom scan) was assessed by measuring at least 5 x 5 x 7 points. On this basis of this data set, the spatial peak SAR value was evaluated with the following procedure (see references or the DASY manual online for more details):
 - a. The data was extrapolated to the surface of the outer-shell of the phantom. The combined distance extrapolated was the combined distance from the center of the dipoles 2.7mm away from the tip of the probe housing plus the 1.2 mm distance between the surface and the lowest measuring point. The extrapolation was based on a least-squares algorithm. A polynomial of the fourth order was calculated through the points in the z-axis (normal to the phantom shell).
 - b. After the maximum interpolated values were calculated between the points in the cube, the SAR was averaged over the spatial volume (1g or 10g) using a 3D-Spline interpolation algorithm. The 3D-spline is composed of three one-dimensional splines with the “Not a knot” condition (in x, y, and z directions). The volume was then integrated with the trapezoidal algorithm. One thousand points (10 x 10 x 10) were obtained through interpolation, in order to calculate the averaged SAR.
 - c. All neighboring volumes were evaluated until no neighboring volume with a higher average value was found.
4. The SAR reference value, at the same location as step 2, was re-measured after the zoom scan was complete to calculate the SAR drift. If the drift deviated by more than 5%, the SAR test and drift measurements were repeated.

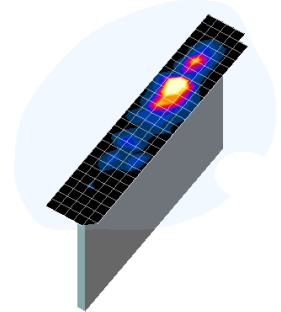



Figure 4-1
Sample SAR Area Scan

FCC ID: TYK-EYC4287	 PCTEST ENGINEERING LABORATORY, INC.	SAR EVALUATION REPORT		Reviewed by: Quality Manager
Document S/N: 0Y1207251026-R1.TYK	Test Dates: 07/26/12 - 08/01/12	DUT Type: Portable Handset		Page 8 of 38

5

DEFINITION OF REFERENCE POINTS

5.1 EAR REFERENCE POINT

Figure 5-2 shows the front, back and side views of the SAM Twin Phantom. The point “M” is the reference point for the center of the mouth, “LE” is the left ear reference point (ERP), and “RE” is the right ERP. The ERP is 15mm posterior to the entrance to the ear canal (EEC) along the B-M line (Back-Mouth), as shown in Figure 5-1. The plane passing through the two ear canals and M is defined as the Reference Plane. The line N-F (Neck-Front) is perpendicular to the reference plane and passing through the RE (or LE) is called the Reference Pivoting Line (see Figure 5-2). Line B-M is perpendicular to the N-F line. Both N-F and B-M lines are marked on the external phantom shell to facilitate handset positioning [5].

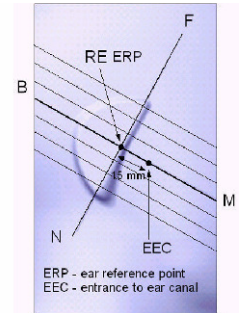

Figure 5-1
Close-Up Side view of ERP

5.2 HANDSET REFERENCE POINTS

Two imaginary lines on the handset were established: the vertical centerline and the horizontal line. The test device was placed in a normal operating position with the “test device reference point” located along the “vertical centerline” on the front of the device aligned to the “ear reference point” (See Figure 5-3). The “test device reference point” was then located at the same level as the center of the ear reference point. The test device was positioned so that the “vertical centerline” was bisecting the front surface of the handset at it’s top and bottom edges, positioning the “ear reference point” on the outer surface of the both the left and right head phantoms on the ear reference point.

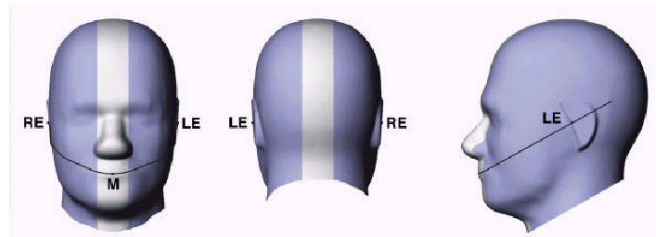

Figure 5-2
Front, back and side view of SAM Twin Phantom

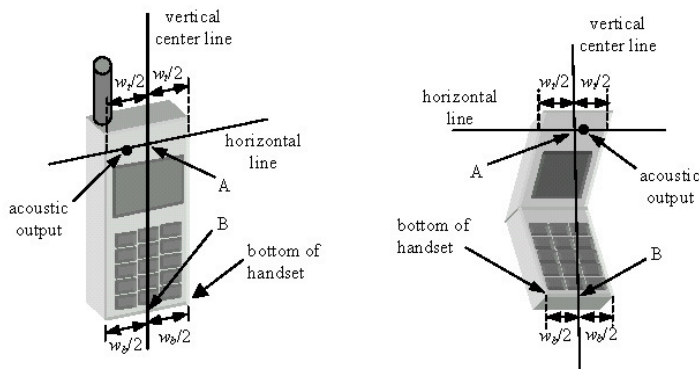

Figure 5-3
Handset Vertical Center & Horizontal Line Reference Points

FCC ID: TYK-EYC4287	PCTEST ENGINEERING LABORATORY, INC.	SAR EVALUATION REPORT	NEC	Reviewed by: Quality Manager
Document S/N: 0Y1207251026-R1.TYK	Test Dates: 07/26/12 - 08/01/12	DUT Type: Portable Handset		Page 9 of 38

6 TEST CONFIGURATION POSITIONS FOR HANDSETS

6.1 Device Holder

The DASY device holder has been made out of low-loss POM material having the following dielectric parameters: relative permittivity $\epsilon = 3$ and loss tangent $\delta = 0.02$.

6.2 Positioning for Cheek/Touch

1. The test device was positioned with the handset close to the surface of the phantom such that point A is on the (virtual) extension of the line passing through points RE and LE on the phantom (see Figure 6-1), such that the plane defined by the vertical center line and the horizontal line of the phone is approximately parallel to the sagittal plane of the phantom.

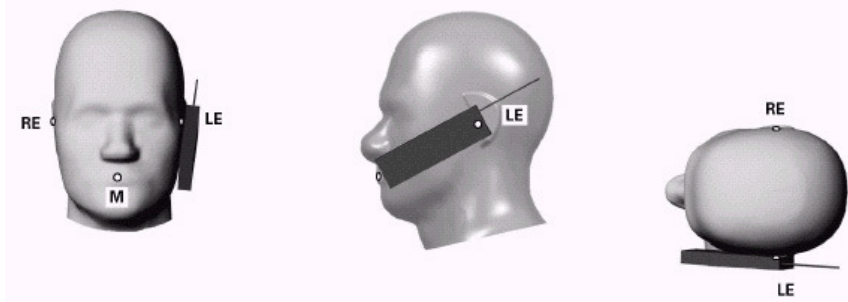



Figure 6-1 Front, Side and Top View of Cheek/Touch Position

2. The handset was translated towards the phantom along the line passing through RE & LE until the handset touches the ear.
3. While maintaining the handset in this plane, the handset was rotated around the LE-RE line until the vertical centerline was in the plane normal to MB-NF including the line MB (reference plane).
4. The phone was then rotated around the vertical centerline until the phone (horizontal line) was symmetrical with respect to the line NF.
5. While maintaining the vertical centerline in the reference plane, keeping point A on the line passing through RE and LE, and maintaining the phone contact with the ear, the handset was rotated about the line NF until any point on the handset made contact with a phantom point below the ear (cheek) (See Figure 6-2).

6.3 Positioning for Ear / 15° Tilt

With the test device aligned in the “Cheek/Touch Position”:

1. While maintaining the orientation of the phone, the phone was retracted parallel to the reference plane far enough to enable a rotation of the phone by 15degree.
2. The phone was then rotated around the horizontal line by 15 degree.
3. While maintaining the orientation of the phone, the phone was moved parallel to the reference plane until any part of the phone touches the head. (In this position, point A was located on the line RE-LE). The tilted position is obtained when the contact is on the pinna. If the contact was at any location other than the pinna, the angle of the phone would then be reduced. The tilted position was obtained when any part of the phone was in contact of the ear as well as a second part of the phone was in contact with the head (see Figure 6-2).

FCC ID: TYK-EYC4287		SAR EVALUATION REPORT		Reviewed by: Quality Manager
Document S/N: 0Y1207251026-R1.TYK	Test Dates: 07/26/12 - 08/01/12	DUT Type: Portable Handset		Page 10 of 38

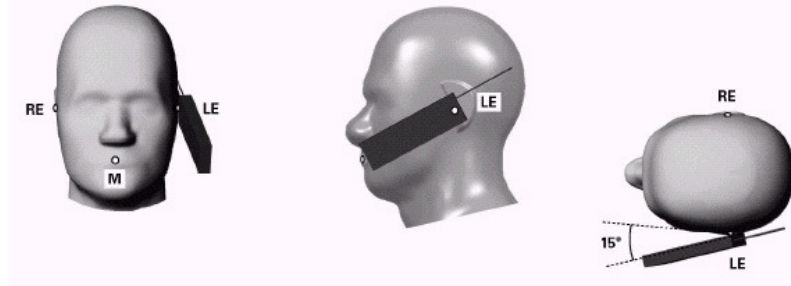

Figure 6-2 Front, Side and Top View of Ear/15° Tilt Position

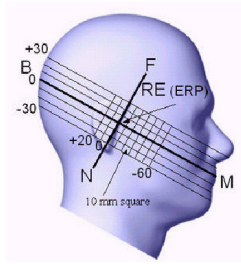

Figure 6-3 Side view w/ relevant markings



Figure 6-4 Body SAR Sample Photo (Not Actual EUT)

6.4 SAR Evaluations near the Mouth/Jaw Regions of the SAM Phantom

Antennas located near the bottom of a phone may require SAR measurements around the mouth and jaw regions of the SAM head phantom. This typically applies to clam-shell style phones that are generally longer in the unfolded normal use positions or to certain older style long rectangular phones.

Under these circumstances, the following procedures apply, adopted from the FCC guidance on SAR handsets document publication 648474. The SAR required in these regions of SAM should be measured using a flat phantom. **Rectangular shaped phones** should be positioned with its bottom edge positioned from the flat phantom with the same distance provided by the cheek touching position using SAM. The ear reference point (ERP, as defined for SAM) of the phone should be positioned ½ cm from the flat phantom shell. **Clam-shell phones** should be positioned with the hinge against a smooth edge of the flat phantom where the upper half of the phone is unfolded and extended beyond the phantom side wall. The lower half of the phone is secured in the test device holder at a fixed distance below the flat phantom determined by the minimum separation along the lower edge of the phone in the cheek touching position using SAM. Any case with substantial variation in separation distance along the lower edge of a clam shell is discussed with the FCC for best-to-use methodology.

The latest IEEE 1528 committee developments propose the usage of a tilted phantom when the antenna of the phone is mounted at the bottom or in all cases the peak absorption is in the chin region. Both SAM heads of the TwinSAM-Chin20 are rotated 20 degrees around the NF line. Each head can be removed individually from the table for emptying and cleaning.

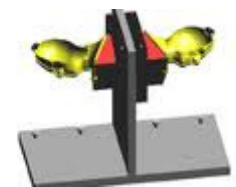



Figure 6-5 Twin SAM Chin20

6.5 Body-Worn Accessory Configurations

Body-worn operating configurations are tested with the belt-clips and holsters attached to the device and positioned against a flat phantom in a normal use configuration (see Figure 6-4). A device with a headset output is tested with a headset connected to the device.

FCC ID: TYK-EYC4287	 PCTEST ENGINEERING LABORATORY, INC.	SAR EVALUATION REPORT		Reviewed by: Quality Manager
Document S/N: 0Y1207251026-R1.TYK	Test Dates: 07/26/12 - 08/01/12	DUT Type: Portable Handset		Page 11 of 38



Accessories for Body-worn operation configurations are divided into two categories: those that do not contain metallic components and those that do contain metallic components. When multiple accessories that do not contain metallic components are supplied with the device, the device is tested with only the accessory that dictates the closest spacing to the body. Then multiple accessories that contain metallic components are tested with the device with each accessory. If multiple accessories share an identical metallic component (i.e. the same metallic belt-clip used with different holsters with no other metallic components) only the accessory that dictates the closest spacing to the body is tested.

Body-worn accessories may not always be supplied or available as options for some devices intended to be authorized for body-worn use. In this case, a test configuration with a separation distance between the back of the device and the flat phantom is used. Test position spacing was documented. Transmitters that are designed to operate in front of a person's face, as in push-to-talk configurations, are tested for SAR compliance with the front of the device positioned to face the flat phantom in head fluid. For devices that are carried next to the body such as a shoulder, waist or chest-worn transmitters, SAR compliance is tested with the accessories, including headsets and microphones, attached to the device and positioned against a flat phantom in a normal use configuration.

6.6 Wireless Router Configurations

Some battery-operated handsets have the capability to transmit and receive internet connectivity through simultaneous transmission of WIFI in conjunction with a separate licensed transmitter. The FCC has provided guidance in KDB Publication 941225 D06 where SAR test considerations for handsets ($L \times W \geq 9 \text{ cm} \times 5 \text{ cm}$) are based on a composite test separation distance of 10 mm from the front, back and edges of the device with antennas 2.5 cm or closer to the edge of the device, determined from general mixed use conditions for this type of devices. Since the hotspot SAR results may overlap with the body-worn accessory SAR requirements, the more conservative configurations can be considered, thus excluding some body-worn accessory SAR tests.

When the user enables the personal wireless router functions for the handset, actual operations include simultaneous transmission of both the WIFI transmitter and another licensed transmitter. Both transmitters often do not transmit at the same transmitting frequency and thus cannot be evaluated for SAR under actual use conditions. Therefore, SAR must be evaluated for each frequency transmission and mode separately and summed with the WIFI transmitter according to KDB 648474 publication procedures. The "Portable Hotspot" feature on the handset was NOT activated, to ensure the SAR measurements were evaluated for a single transmission frequency RF signal.

FCC ID: TYK-EYC4287	 PCTEST ENGINEERING LABORATORY, INC.	SAR EVALUATION REPORT		Reviewed by: Quality Manager
Document S/N: 0Y1207251026-R1.TYK	Test Dates: 07/26/12 - 08/01/12	DUT Type: Portable Handset		Page 12 of 38

7 FCC RF EXPOSURE LIMITS

7.1 Uncontrolled Environment

UNCONTROLLED ENVIRONMENTS are defined as locations where there is the exposure of individuals who have no knowledge or control of their exposure. The general population/uncontrolled exposure limits are applicable to situations in which the general public may be exposed or in which persons who are exposed as a consequence of their employment may not be made fully aware of the potential for exposure or cannot exercise control over their exposure. Members of the general public would come under this category when exposure is not employment-related; for example, in the case of a wireless transmitter that exposes persons in its vicinity.



7.2 Controlled Environment

CONTROLLED ENVIRONMENTS are defined as locations where there is exposure that may be incurred by persons who are aware of the potential for exposure, (i.e. as a result of employment or occupation). In general, occupational/controlled exposure limits are applicable to situations in which persons are exposed as a consequence of their employment, who have been made fully aware of the potential for exposure and can exercise control over their exposure. This exposure category is also applicable when the exposure is of a transient nature due to incidental passage through a location where the exposure levels may be higher than the general population/uncontrolled limits, but the exposed person is fully aware of the potential for exposure and can exercise control over his or her exposure by leaving the area or by some other appropriate means.

Table 7-1
SAR Human Exposure Specified in ANSI/IEEE C95.1-1992 and Health Canada Safety Code 6

HUMAN EXPOSURE LIMITS		
	UNCONTROLLED ENVIRONMENT <i>General Population</i> (W/kg) or (mW/g)	CONTROLLED ENVIRONMENT <i>Occupational</i> (W/kg) or (mW/g)
SPATIAL PEAK SAR Brain	1.6	8.0
SPATIAL AVERAGE SAR Whole Body	0.08	0.4
SPATIAL PEAK SAR Hands, Feet, Ankles, Wrists	4.0	20

1. The Spatial Peak value of the SAR averaged over any 1 gram of tissue (defined as a tissue volume in the shape of a cube) and over the appropriate averaging time.
2. The Spatial Average value of the SAR averaged over the whole body.
3. The Spatial Peak value of the SAR averaged over any 10 grams of tissue (defined as a tissue volume in the shape of a cube) and over the appropriate averaging time.

FCC ID: TYK-EYC4287	 PCTEST ENGINEERING LABORATORY, INC.	SAR EVALUATION REPORT		Reviewed by: Quality Manager
Document S/N: 0Y1207251026-R1.TYK	Test Dates: 07/26/12 - 08/01/12	DUT Type: Portable Handset		Page 13 of 38

8 FCC MEASUREMENT PROCEDURES

Power measurements were performed using a base station simulator under digital average power.

8.1 Procedures Used to Establish RF Signal for SAR

The following procedures are according to FCC KDB Publication 941225 D01 “SAR Measurement Procedures for 3G Devices” v02, October 2007.

The device was placed into a simulated call using a base station simulator in a RF shielded chamber. Establishing connections in this manner ensure a consistent means for testing SAR and are recommended for evaluating SAR [4]. Devices under test were evaluated prior to testing, with a fully charged battery and were configured to operate at maximum output power. In order to verify that the device was tested throughout the SAR test at maximum output power, the SAR measurement system measures a “point SAR” at an arbitrary reference point at the start and end of the 1 gram SAR evaluation, to assess for any power drifts during the evaluation. If the power drift deviated by more than 5%, the SAR test and drift measurements were repeated.

8.2 SAR Measurement Conditions for CDMA2000

The following procedures were performed according to FCC KDB Publication 941225 D01 “SAR Measurement Procedures for 3G Devices” v02, October 2007.

8.2.1 Output Power Verification

See 3GPP2 C.S0011/TIA-98-E as recommended by “SAR Measurement Procedures for 3G Devices” v02, October 2007. Maximum output power is verified on the High, Middle and Low channels according to procedures in section 4.4.5.2 of 3GPP2 C.S0011/TIA-98-E. SO55 tests were measured with power control bits in the “All Up” condition.



1. If the mobile station (MS) supports Reverse TCH RC 1 and Forward TCH RC 1, set up a call using Fundamental Channel Test Mode 1 (RC=1/1) with 9600 bps data rate only.
2. Under RC1, C.S0011 Table 4.4.5.2-1, Table 8-1 parameters were applied.
3. If the MS supports the RC 3 Reverse FCH, RC3 Reverse SCH₀ and demodulation of RC 3,4, or 5, set up a call using Supplemental Channel Test Mode 3 (RC 3/3) with 9600 bps Fundamental Channel and 9600 bps SCH0 data rate.
4. Under RC3, C.S0011 Table 4.4.5.2-2, Table 8-2 was applied.
5. FCHs were configured at full rate for maximum SAR with “All Up” power control bits.

**Table 8-1
Parameters for Max. Power for RC1**

Parameter	Units	Value
$\overline{I_{or}}$	dBm/1.23 MHz	-104
$\frac{Pilot E_c}{I_{or}}$	dB	-7
$\frac{Traffic E_c}{I_{or}}$	dB	-7.4

**Table 8-2
Parameters for Max. Power for RC3**

Parameter	Units	Value
$\overline{I_{or}}$	dBm/1.23 MHz	-86
$\frac{Pilot E_c}{I_{or}}$	dB	-7
$\frac{Traffic E_c}{I_{or}}$	dB	-7.4

FCC ID: TYK-EYC4287	 PCTEST ENGINEERING LABORATORY, INC.	SAR EVALUATION REPORT		Reviewed by: Quality Manager
Document S/N: 0Y1207251026-R1.TYK	Test Dates: 07/26/12 - 08/01/12	DUT Type: Portable Handset		Page 14 of 38

8.2.2 Head SAR Measurements

SAR for head exposure configurations is measured in RC3 with the DUT configured to transmit at full rate using Loopback Service Option SO55. SAR for RC1 is not required when the maximum average output of each channel is less than ¼ dB higher than that measured in RC3. Otherwise, SAR is measured on the maximum output channel in RC1 using the exposure configuration that results in the highest SAR for that channel in RC3.

8.2.3 Body-Worn and Hotspot SAR Measurements

SAR for body exposure configurations is measured in RC3 with the DUT configured to transmit at full rate on FCH with all other code channels disabled using TDSO / SO32. SAR for multiple code channels (FCH + SCH_n) is not required when the maximum average output of each RF channel is less than ¼ dB higher than that measured with FCH only. Otherwise, SAR is measured on the maximum output channel (FCH + SCH_n) with FCH at full rate and SCH₀ enabled at 9600 bps using the exposure configuration that results in the highest SAR for that channel with FCH only. When multiple code channels are enabled, the DUT output may shift by more than 0.5 dB and lead to higher SAR drifts and SCH dropouts. Body SAR was measured using TDSO / SO32 with power control bits in the “All Up”

Body SAR in RC1 is not required when the maximum average output of each channel is less than ¼ dB higher than that measured in RC3. Otherwise, SAR is measured on the maximum output channel in RC1; with Loopback Service Option SO55, at full rate, using the body exposure configuration that results in the highest SAR for that channel in RC3.

8.3 SAR Measurement Conditions for WCDMA

8.3.1 Output Power Verification



Maximum output power is measured on the High, Middle and Low channels for each applicable transmission band according to the general descriptions in section 5.2 of 3GPP TS 34.121, using the appropriate RMC or AMR with TPC (transmit power control) set to all “1s”.

8.3.2 Head SAR Measurements for Handsets

SAR for head exposure configurations is measured using the 12.2 kbps RMC with TPC bits configured to all “1s”. SAR in AMR configurations is not required when the maximum average output of each RF channel for 12.2 kbps AMR is less than 0.25 dB higher than that measured in 12.2 kbps RMC. Otherwise, SAR is measured on the maximum output channel in 12.2 AMR with a 3.4 kbps SRB (signaling radio bearer) using the exposure configuration that resulted in the highest SAR for that RF channel in the 12.2 kbps RMC mode.

8.3.3 Body SAR Measurements

SAR for body exposure configurations is measured using the 12.2 kbps RMC with the TPC bits all “1s”.

FCC ID: TYK-EYC4287		SAR EVALUATION REPORT		Reviewed by: Quality Manager
Document S/N: 0Y1207251026-R1.TYK	Test Dates: 07/26/12 - 08/01/12	DUT Type: Portable Handset		Page 15 of 38

8.3.4 SAR Measurements for Handsets with Rel 5 HSDPA

Body SAR for HSDPA is not required for handsets with HSDPA capabilities when the maximum average output power of each RF channel with HSDPA active is less than 0.25 dB higher than that measured without HSDPA using 12.2 kbps RMC and the maximum SAR for 12.2 kbps RMC is $\leq 75\%$ of the SAR limit. Otherwise, SAR is measured for HSDPA, using an FRC with H-Set 1 in Sub-test 1 and a 12.2 kbps RMC configured in Test Loop Mode 1, using the highest body SAR configuration measured in 12.2 kbps RMC without HSDPA, on the maximum output channel with the body exposure configuration that resulted in the highest SAR in 12.2 kbps RMC mode for that RF channel.

The H-set used in FRC for HSDPA should be configured according to the UE category of a test device. The number of HS-DSCH/HSPDSCHs, HARQ processes, minimum inter-TTI interval, transport block sizes and RV coding sequence are defined by the applicable H-set. To maintain a consistent test configuration and stable transmission conditions, QPSK is used in the FRC for SAR testing. HS-DPCCH should be configured with a CQI feedback cycle of 2 ms to maintain a constant rate of active CQI slots. DPCCH and DPDCH gain factors of $\beta_c=9$ and $\beta_d=15$, and power offset parameters of $\Delta_{ACK}=\Delta_{NACK}=5$ and $\Delta_{CQI}=2$ is used. The CQI value is determined by the UE category, transport block size, number of HS-PDSCHs and modulation used in the FRC.

8.3.5 SAR Measurements for Handsets with Rel 6 HSUPA

Body SAR for HSUPA is not required when the maximum average output of each RF channel with HSUPA/HSDPA active is less than 0.25 dB higher than as measured without HSUPA/HSDPA using 12.2 kbps RMC and maximum SAR for 12.2 kbps RMC is $\leq 75\%$ of the SAR limit. Otherwise SAR is measured on the maximum output channel for the body exposure configuration produced highest SAR in 12.2 kbps RMC for that RF channel, using the additional procedures under "Release 6 HSPA data devices"

Head SAR for VOIP operations under HSPA is not required when maximum average output of each RF channel with HSPA is less than 0.25 dB higher than as measured using 12.2 kbps RMC. Otherwise SAR is measured using same HSPA configuration as used for body SAR.

Sub-test	β_c	β_d	β_d (SF)	β_c/β_d	$\beta_{18}^{(1)}$	β_{ec}	β_{ed}	β_{ed} (SF)	β_{ed} (codes)	CM ⁽²⁾ (dB)	MPR (dB)	AG ⁽⁴⁾ Index	E-TFCI
1	11/15 ⁽³⁾	15/15 ⁽³⁾	64	11/15 ⁽³⁾	22/15	209/225	1039/225	4	1	1.0	0.0	20	75
2	6/15	15/15	64	6/15	12/15	12/15	94/75	4	1	3.0	2.0	12	67
3	15/15	9/15	64	15/9	30/15	30/15	$\beta_{ed1}: 47/15$ $\beta_{ed2}: 47/15$	4	2	2.0	1.0	15	92
4	2/15	15/15	64	2/15	4/15	2/15	56/75	4	1	3.0	2.0	17	71
5	15/15 ⁽⁴⁾	15/15 ⁽⁴⁾	64	15/15 ⁽⁴⁾	30/15	24/15	134/15	4	1	1.0	0.0	21	81

Note 1: $\Delta_{ACK}, \Delta_{NACK}$ and $\Delta_{CQI} = 8 \Leftrightarrow A_{18} = \beta_{18}/\beta_c = 30/15 \Leftrightarrow \beta_{18} = 30/15 * \beta_c$.



Note 2: CM = 1 for $\beta_c/\beta_d = 12/15, \beta_{18}/\beta_c = 24/15$. For all other combinations of DPDCH, DPCCH, HS-DPCCH, E-DPDCH and E-DPCCH the MPR is based on the relative CM difference.

Note 3: For subtest 1 the β_c/β_d ratio of 11/15 for the TFC during the measurement period (TF1, TF0) is achieved by setting the signaled gain factors for the reference TFC (TF1, TF1) to $\beta_c = 10/15$ and $\beta_d = 15/15$.

Note 4: For subtest 5 the β_c/β_d ratio of 15/15 for the TFC during the measurement period (TF1, TF0) is achieved by setting the signaled gain factors for the reference TFC (TF1, TF1) to $\beta_c = 14/15$ and $\beta_d = 15/15$.

Note 5: Testing UE using E-DPDCH Physical Layer category 1 Sub-test 3 is not required according to TS 25.306 Table 5.1g.

Note 6: β_{ed} can not be set directly; it is set by Absolute Grant Value.

FCC ID: TYK-EYC4287	 PCTEST ENGINEERING LABORATORY, INC.	SAR EVALUATION REPORT		Reviewed by: Quality Manager
Document S/N: 0Y1207251026-R1.TYK	Test Dates: 07/26/12 - 08/01/12	DUT Type: Portable Handset		Page 16 of 38

8.4 SAR Testing with 802.11 Transmitters

Normal network operating configurations are not suitable for measuring the SAR of 802.11 b/g/n transmitters. Unpredictable fluctuations in network traffic and antenna diversity conditions can introduce undesirable variations in SAR results. The SAR for these devices should be measured using chipset based test mode software to ensure the results are consistent and reliable. See KDB Publication 248227 for more details.



8.4.1 General Device Setup

Chipset based test mode software is hardware dependent and generally varies among manufacturers. The device operating parameters established in test mode for SAR measurements must be identical to those programmed in production units, including output power levels, amplifier gain settings and other RF performance tuning parameters. The test frequencies should correspond to actual channel frequencies defined for domestic use. SAR for devices with switched diversity should be measured with only one antenna transmitting at a time during each SAR measurement, according to a fixed modulation and data rate. The same data pattern should be used for all measurements.

8.4.2 Frequency Channel Configurations [27]

For 2.4 GHz, the highest average RF output power channel between the low, mid and high channel at the lowest data rate was selected for SAR evaluation in 802.11b mode. 802.11g/n modes and higher data rates for 802.11b were additionally evaluated for SAR if the output power of the respective mode was 0.25 dB or higher than the powers of the SAR configurations tested in the 802.11b mode.

If the maximum extrapolated peak SAR of the zoom scan for the highest output channel was less than 1.6 W/kg or if the 1g averaged SAR was less than 0.8 W/kg, SAR testing was not required for the other test channels in the band.

FCC ID: TYK-EYC4287		SAR EVALUATION REPORT		Reviewed by: Quality Manager
Document S/N: 0Y1207251026-R1.TYK	Test Dates: 07/26/12 - 08/01/12	DUT Type: Portable Handset	Page 17 of 38	

9

RF CONDUCTED POWERS

9.1 CDMA Conducted Powers

Band	Channel	Frequency	SO55 [dBm]	SO55 [dBm]	TDSO SO32 [dBm]	TDSO SO32 [dBm]
	F-RC	MHz	RC1	RC3	FCH+SCH	FCH
Cellular	1013	824.7	24.37	24.20	24.22	24.21
	384	836.52	24.30	24.14	24.13	24.14
	777	848.31	24.14	23.98	23.95	24.01



Note: RC1 is only applicable for IS-95 compatibility.

Per KDB Publication 941225 D01:

1. Head SAR was tested with SO55 RC3. SO55 RC1 was not required since the average output power was not more than 0.25 dB than the SO55 RC3 powers.
2. Body-Worn and Hotspot SAR was tested with 1x RTT with TDSO / SO32 FCH Only. TDSO / SO32 FCH+SCH SAR tests were not required since the average output power was not more than 0.25 dB higher than the TDSO / SO32 FCH only powers.



Figure 9-1
Power Measurement Setup

FCC ID: TYK-EYC4287	 PCTEST ENGINEERING LABORATORY, INC.	SAR EVALUATION REPORT		Reviewed by: Quality Manager
Document S/N: 0Y1207251026-R1.TYK	Test Dates: 07/26/12 - 08/01/12	DUT Type: Portable Handset		Page 18 of 38

9.2 GSM Conducted Powers

Maximum Burst-Averaged Output Power			
		Voice	GPRS Data (GMSK)
Band	Channel	GSM [dBm] CS (1 Slot)	GPRS [dBm] 1 Tx Slot
Cellular	128	33.58	33.55
	190	33.51	33.46
	251	33.60	33.53
PCS	512	30.72	30.75
	661	30.13	30.14
	810	29.30	29.31

Calculated Maximum Frame-Averaged Output Power			
		Voice	GPRS Data (GMSK)
Band	Channel	GSM [dBm] CS (1 Slot)	GPRS [dBm] 1 Tx Slot
Cellular	128	24.55	24.52
	190	24.48	24.43
	251	24.57	24.50
PCS	512	21.69	21.72
	661	21.10	21.11
	810	20.27	20.28

Note: Both burst-averaged and calculated frame-averaged powers are included. Frame-averaged power was calculated from the measured burst-averaged power by converting the slot powers into linear units and calculating the energy over 8 timeslots.

GPRS (GMSK) output powers were measured with CS1 on the base station simulator since CS1 is the coding scheme with the lowest bit rate and most stable.

GSM Class: B
GPRS Multislot class: 8 (max 1 Tx Uplink slots)
EDGE Multislot class: N/A
DTM Multislot Class: N/A

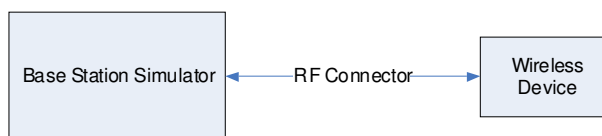



Figure 9-2
Power Measurement Setup

FCC ID: TYK-EYC4287	 PCTEST ENGINEERING LABORATORY, INC.	SAR EVALUATION REPORT		Reviewed by: Quality Manager
Document S/N: 0Y1207251026-R1.TYK	Test Dates: 07/26/12 - 08/01/12	DUT Type: Portable Handset		Page 19 of 38

9.3 HSPA Conducted Powers



3GPP Release Version	Mode	3GPP 34.121 Subtest	Cellular Band [dBm]			3GPP MPR [dB]
			4132	4183	4233	
99	WCDMA	12.2 kbps RMC	23.54	23.60	23.47	-
99		12.2 kbps AMR	23.57	23.59	23.44	-
6	HSDPA	Subtest 1	23.37	23.37	23.38	0
6		Subtest 2	23.28	23.35	23.41	0
6		Subtest 3	23.30	23.33	23.43	0.5
6		Subtest 4	23.36	23.35	23.35	0.5
6	HSUPA	Subtest 1	23.14	23.08	22.85	0
6		Subtest 2	22.05	21.75	22.05	2
6		Subtest 3	22.25	22.23	22.42	1
6		Subtest 4	22.32	21.31	21.88	2
6		Subtest 5	22.89	23.13	23.24	0

WCDMA SAR was tested under RMC 12.2 kbps with HSPA Inactive per KDB Publication 941225 D01. HSPA SAR was not required since the average output power of the HSPA subtests was not more than 0.25 dB higher than the RMC level and SAR was less than 1.2 W/kg.

It is expected by the manufacturer that MPR for some HSUPA subtests may be up to 1 dB more than specified by 3GPP, but also as low as 0 dB according to the chipset implementation in this model. Detailed information is included in the operational description explaining how the MPR is applied for this model.



Figure 9-3
Power Measurement Setup

FCC ID: TYK-EYC4287	 PCTEST ENGINEERING LABORATORY, INC.	SAR EVALUATION REPORT		Reviewed by: Quality Manager
Document S/N: 0Y1207251026-R1.TYK	Test Dates: 07/26/12 - 08/01/12	DUT Type: Portable Handset		Page 20 of 38



9.4 WLAN Conducted Powers

Table 9-1
IEEE 802.11b Average RF Power

Freq [MHz]	Channel	Data Rate [Mbps]	Average Power (dBm)
2412	1	1	15.33
		2	15.30
		5.5	15.38
		11	15.34
2437	6	1	15.14
		2	15.07
		5.5	15.12
		11	15.08
2462	11	1	15.30
		2	15.22
		5.5	15.35
		11	15.32

Table 9-2
IEEE 802.11g Average RF Power

Freq [MHz]	Channel	Data Rate [Mbps]	Average Power (dBm)
2412	1	6	12.14
		9	12.20
		12	12.23
		18	12.16
		24	12.20
		36	12.12
		48	11.11
		54	11.32
2437	6	6	12.19
		9	12.18
		12	12.28
		18	12.15
		24	12.28
		36	12.10
		48	11.08
		54	11.14
2462	11	6	12.21
		9	12.08
		12	12.12
		18	12.24
		24	12.16
		36	12.12
		48	11.12
		54	11.06

FCC ID: TYK-EYC4287	 PCTEST ENGINEERING LABORATORY, INC.	SAR EVALUATION REPORT	 NEC	Reviewed by: Quality Manager
Document S/N: 0Y1207251026-R1.TYK	Test Dates: 07/26/12 - 08/01/12	DUT Type: Portable Handset	Page 21 of 38	

**Table 9-3
IEEE 802.11n Average RF Power**



Freq [MHz]	Channel	Data Rate [Mbps]	Average Power (dBm)
2412	1	6.5	11.64
		13	11.41
		19.5	12.07
		26	11.27
		29	10.87
		52	10.33
		58.5	10.24
		65	10.18
2437	6	6.5	11.41
		13	11.26
		19.5	11.23
		26	11.16
		29	10.58
		52	10.06
		58.5	10.06
		65	10.11
2462	11	6.5	11.10
		13	11.24
		19.5	11.26
		26	10.36
		29	11.10
		52	10.50
		58.5	10.43
		65	10.56

Justification for reduced test configurations for WIFI channels per KDB Publication 248227 and April 2010 FCC/TCB Meeting Notes:

- For 2.4 GHz, highest average RF output power channel for the lowest data rate for IEEE 802.11b were selected for SAR evaluation. Other IEEE 802.11 modes (including 802.11g/n) were not investigated since the average output powers over all channels and data rates were not more than 0.25 dB higher than the tested channel in the lowest data rate of IEEE 802.11b mode.
- When the maximum extrapolated peak SAR of the zoom scan for the maximum output channel is <1.6 W/kg and the 1g averaged SAR is <0.8 W/kg, SAR testing on other channels is not required. Otherwise, the other default (or corresponding required) test channels were additionally tested using the lowest data rate.
- The bolded data rate and channel above were tested for SAR.



**Figure 9-4
Power Measurement Setup**

FCC ID: TYK-EYC4287	 PCTEST ENGINEERING LABORATORY, INC.	SAR EVALUATION REPORT		Reviewed by: Quality Manager
Document S/N: 0Y1207251026-R1.TYK	Test Dates: 07/26/12 - 08/01/12	DUT Type: Portable Handset	Page 22 of 38	

10 SYSTEM VERIFICATION

10.1 Tissue Verification

**Table 10-1
Measured Tissue Properties**

Calibrated for Tests Performed on:	Tissue Type	Tissue Temp During Calibration (C°)	Measured Frequency (MHz)	Measured Conductivity, σ (S/m)	Measured Dielectric Constant, ϵ	TARGET Conductivity, σ (S/m)	TARGET Dielectric Constant, ϵ	% dev σ	% dev ϵ
07/26/2012	835H	23.3	820	0.901	40.89	0.90	41.57	0.33%	-1.64%
			835	0.917	40.72	0.90	41.50	1.89%	-1.88%
			850	0.932	40.49	0.92	41.50	1.75%	-2.43%
07/30/2012	1900H	21.4	1850	1.357	38.60	1.40	40.00	-3.07%	-3.50%
			1880	1.393	38.69	1.40	40.00	-0.50%	-3.28%
			1910	1.431	38.41	1.40	40.00	2.21%	-3.98%
08/01/2012	2450H	23.0	2401	1.800	38.06	1.76	39.30	2.39%	-3.15%
			2450	1.864	37.72	1.80	39.20	3.56%	-3.78%
			2499	1.922	37.72	1.85	39.14	3.78%	-3.62%
07/27/2012	835B	24.9	820	0.961	55.42	0.97	55.28	-0.83%	0.25%
			835	0.978	55.34	0.97	55.20	0.82%	0.25%
			850	0.992	55.18	0.99	55.15	0.40%	0.05%
07/30/2012	835B	22.9	820	0.960	55.08	0.97	55.28	-0.93%	-0.37%
			835	0.971	54.86	0.97	55.20	0.10%	-0.62%
			850	0.983	54.84	0.99	55.15	-0.51%	-0.57%
07/31/2012	1900B	21.1	1850	1.491	51.81	1.52	53.30	-1.91%	-2.80%
			1880	1.558	51.88	1.52	53.30	2.50%	-2.66%
			1910	1.571	51.74	1.52	53.30	3.36%	-2.93%
08/01/2012	2450B	23.5	2401	1.987	53.63	1.90	52.77	4.41%	1.64%
			2450	2.046	53.46	1.95	52.70	4.92%	1.44%
			2499	2.114	53.26	2.02	52.64	4.71%	1.18%

Note: KDB Publication 450824 was ensured to be applied for probe calibration frequencies greater than or equal to 50 MHz of the DUT frequencies.



The above measured tissue parameters were used in the DASY software to perform interpolation via the DASY software to determine actual dielectric parameters at the test frequencies (per IEEE 1528 6.6.1.2).

10.2 Measurement Procedure for Tissue verification

- 1) The network analyzer and probe system was configured and calibrated.
- 2) The probe was immersed in the sample which was placed in a nonmetallic container. Trapped air bubbles beneath the flange were minimized by placing the probe at a slight angle.
- 3) The complex admittance with respect to the probe aperture was measured
- 4) The complex relative permittivity ϵ can be calculated from the below equation (Pournaropoulos and Misra):

$$Y = \frac{j2\omega\epsilon_r\epsilon_0}{[\ln(b/a)]^2} \int_a^b \int_a^b \int_0^\pi \frac{\cos\phi' \exp[-j\omega r(\mu_0\epsilon_r'\epsilon_0)^{1/2}]}{r} d\phi' d\rho' d\rho$$

where Y is the admittance of the probe in contact with the sample, the primed and unprimed coordinates refer to source = ρ and observation points, respectively, $r^2 = \rho^2 + \rho'^2 - 2\rho\rho' \cos\phi'$, ω is the angular frequency, and $j = \sqrt{-1}$.

FCC ID: TYK-EYC4287	 PCTEST ENGINEERING LABORATORY, INC.	SAR EVALUATION REPORT		Reviewed by: Quality Manager
Document S/N: 0Y1207251026-R1.TYK	Test Dates: 07/26/12 - 08/01/12	DUT Type: Portable Handset		Page 23 of 38

10.3 Test System Verification

Prior to assessment, the system is verified to $\pm 10\%$ of the manufacturer SAR measurement on the reference dipole at the time of calibration.

**Table 10-2
System Verification Results**

System Verification TARGET & MEASURED											
Tissue Frequency (MHz)	Tissue Type	Date:	Amb. Temp (°C)	Liquid Temp (°C)	Input Power (W)	Dipole SN	Probe SN	Measured SAR ₁₀ (W/kg)	1 W Target SAR ₁₀ (W/kg)	1 W Normalized SAR ₁₀ (W/kg)	Deviation (%)
835	Head	07/26/2012	24.2	23.3	0.100	4d119	3258	0.979	9.420	9.790	3.93%
1900	Head	07/30/2012	21.1	21.2	0.100	5d149	3287	4.11	39.300	41.100	4.58%
2450	Head	08/01/2012	22.3	23.1	0.010	797	3022	0.54	52.100	54.000	3.65%
835	Body	07/27/2012	24.4	23.8	0.100	4d119	3258	0.986	9.560	9.860	3.14%
835	Body	07/30/2012	24.1	23.4	0.100	4d119	3258	0.974	9.560	9.740	1.88%
1900	Body	07/31/2012	21.9	21.1	0.100	5d149	3287	4.13	39.300	41.300	5.09%
2450	Body	08/01/2012	23.4	23.0	0.010	797	3022	0.493	50.800	49.300	-2.95%

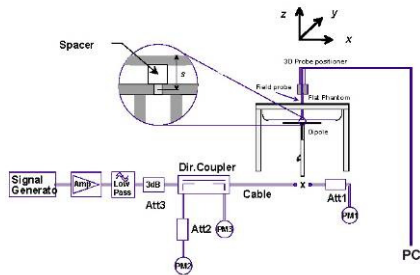

**Figure 10-1
System Verification Setup Diagram**



**Figure 10-2
System Verification Setup Photo**

FCC ID: TYK-EYC4287		SAR EVALUATION REPORT		Reviewed by: Quality Manager
Document S/N: 0Y1207251026-R1.TYK	Test Dates: 07/26/12 - 08/01/12	DUT Type: Portable Handset		Page 24 of 38

11 SAR DATA SUMMARY



11.1 Standalone Head SAR Data

Table 11-1
Cell. CDMA Head SAR Results

MEASUREMENT RESULTS								
FREQUENCY		Mode/Band	Conducted Power [dBm]	Power Drift [dB]	Side	Test Position	Device Serial Number	SAR (1g)
MHz	Ch.							(W/kg)
836.52	384	Cell. CDMA	24.14	-0.02	Right	Cheek	KGM-U-004	0.726
836.52	384	Cell. CDMA	24.14	-0.01	Right	Tilt	KGM-U-004	0.360
836.52	384	Cell. CDMA	24.14	-0.05	Left	Cheek	KGM-U-004	0.597
836.52	384	Cell. CDMA	24.14	-0.03	Left	Tilt	KGM-U-004	0.309
ANSI / IEEE C95.1 1992 - SAFETY LIMIT Spatial Peak Uncontrolled Exposure/General Population					Head 1.6 W/kg (mW/g) averaged over 1 gram			

Table 11-2
GSM 850 Head SAR Results

MEASUREMENT RESULTS								
FREQUENCY		Mode/Band	Conducted Power [dBm]	Power Drift [dB]	Side	Test Position	Device Serial Number	SAR (1g)
MHz	Ch.							(W/kg)
836.60	190	GSM 850	33.51	-0.05	Right	Cheek	KGM-U-004	0.753
836.60	190	GSM 850	33.51	-0.07	Right	Tilt	KGM-U-004	0.387
836.60	190	GSM 850	33.51	-0.03	Left	Cheek	KGM-U-004	0.651
836.60	190	GSM 850	33.51	-0.01	Left	Tilt	KGM-U-004	0.368
ANSI / IEEE C95.1 1992 - SAFETY LIMIT Spatial Peak Uncontrolled Exposure/General Population					Head 1.6 W/kg (mW/g) averaged over 1 gram			

FCC ID: TYK-EYC4287	 PCTEST ENGINEERING LABORATORY, INC.	SAR EVALUATION REPORT		Reviewed by: Quality Manager
Document S/N: 0Y1207251026-R1.TYK	Test Dates: 07/26/12 - 08/01/12	DUT Type: Portable Handset		Page 25 of 38

**Table 11-3
WCDMA 850 Head SAR Results**

MEASUREMENT RESULTS								
FREQUENCY		Mode/Band	Conducted Power [dBm]	Power Drift [dB]	Side	Test Position	Device Serial Number	SAR (1g)
MHz	Ch.							(W/kg)
836.60	4183	WCDMA 850	23.60	0.03	Right	Cheek	KGM-U-004	0.552
836.60	4183	WCDMA 850	23.60	-0.11	Right	Tilt	KGM-U-004	0.295
836.60	4183	WCDMA 850	23.60	-0.05	Left	Cheek	KGM-U-004	0.471
836.60	4183	WCDMA 850	23.60	-0.04	Left	Tilt	KGM-U-004	0.275
ANSI / IEEE C95.1 1992 - SAFETY LIMIT Spatial Peak Uncontrolled Exposure/General Population					Head 1.6 W/kg (mW/g) averaged over 1 gram			



**Table 11-4
GSM 1900 Head SAR Results**

MEASUREMENT RESULTS								
FREQUENCY		Mode	Conducted Power [dBm]	Power Drift [dB]	Side	Test Position	Device Serial Number	SAR (1g)
MHz	Ch.							(W/kg)
1850.20	512	GSM 1900	30.72	0.03	Right	Cheek	KGM-U-004	1.190
1880.00	661	GSM 1900	30.13	-0.02	Right	Cheek	KGM-U-004	1.070
1909.80	810	GSM 1900	29.30	0.03	Right	Cheek	KGM-U-004	1.010
1850.20	512	GSM 1900	30.72	0.05	Right	Tilt	KGM-U-004	0.258
1850.20	512	GSM 1900	30.72	-0.06	Left	Cheek	KGM-U-004	0.534
1850.20	512	GSM 1900	30.72	0.00	Left	Tilt	KGM-U-004	0.267
ANSI / IEEE C95.1 1992 - SAFETY LIMIT Spatial Peak Uncontrolled Exposure/General Population					Head 1.6 W/kg (mW/g) averaged over 1 gram			

Note: Per October 2010 TCB Workshop, the mid. channel may be used as a default test channel when the output power deviation across the channels is <0.5 dB, otherwise the maximum output power must be used; thus low channel was used for SAR testing for GSM1900. If the SAR measured at for each test configuration for the default channel is at least 3.0 dB lower than the SAR limit, testing at the other channels is optional for such test configuration(s).

**Table 11-5
2.4 GHz WLAN Head SAR Results**

MEASUREMENT RESULTS										
FREQUENCY		Mode	Service	Conducted Power [dBm]	Power Drift [dB]	Side	Test Position	Device Serial Number	Data Rate (Mbps)	SAR (1g)
MHz	Ch.									(W/kg)
2412	1	IEEE 802.11b	DSSS	15.33	-0.01	Right	Cheek	KGM-U-002	1	0.177
2412	1	IEEE 802.11b	DSSS	15.33	0.01	Right	Tilt	KGM-U-002	1	0.122
2412	1	IEEE 802.11b	DSSS	15.33	0.12	Left	Cheek	KGM-U-002	1	0.355
2412	1	IEEE 802.11b	DSSS	15.33	-0.04	Left	Tilt	KGM-U-002	1	0.152
ANSI / IEEE C95.1 1992 - SAFETY LIMIT Spatial Peak Uncontrolled Exposure/General Population					Head 1.6 W/kg (mW/g) averaged over 1 gram					

FCC ID: TYK-EYC4287	 PCTEST ENGINEERING LABORATORY, INC.	SAR EVALUATION REPORT		Reviewed by: Quality Manager
Document S/N: 0Y1207251026-R1.TYK	Test Dates: 07/26/12 - 08/01/12	DUT Type: Portable Handset		Page 26 of 38

11.2 Standalone Body-Worn SAR Data

**Table 11-6
Licensed Transmitter Body-Worn SAR Results**

MEASUREMENT RESULTS										
FREQUENCY		Mode	Service	Conducted Power [dBm]	Power Drift [dB]	Spacing	Device Serial Number	# of Time Slots	Side	SAR (1g)
MHz	Ch.									(W/kg)
836.52	384	Cell. CDMA	TDSO / SO32	24.14	-0.02	1.0 cm	KGM-U-004	N/A	back	0.747
824.20	128	GSM 850	GSM	33.58	-0.03	1.0 cm	KGM-U-004	1	back	0.730
836.60	190	GSM 850	GSM	33.51	-0.05	1.0 cm	KGM-U-004	1	back	0.807
848.80	251	GSM 850	GSM	33.60	0.03	1.0 cm	KGM-U-004	1	back	0.795
824.20	128	GSM 850	GPRS	33.55	-0.02	1.0 cm	KGM-U-004	1	back	0.754
836.60	190	GSM 850	GPRS	33.46	-0.06	1.0 cm	KGM-U-004	1	back	0.861
848.80	251	GSM 850	GPRS	33.53	-0.03	1.0 cm	KGM-U-004	1	back	0.842
836.60	4183	WCDMA 850	RMC	23.60	-0.02	1.0 cm	KGM-U-004	N/A	back	0.724
1850.20	512	GSM 1900	GSM	30.72	-0.12	1.0 cm	KGM-U-004	1	back	0.682
1850.20	512	GSM 1900	GPRS	30.75	-0.05	1.0 cm	KGM-U-004	1	back	0.624
ANSI / IEEE C95.1 1992 - SAFETY LIMIT Spatial Peak Uncontrolled Exposure/General Population						Body 1.6 W/kg (mW/g) averaged over 1 gram				



Note: For CDMA, GPRS, and WCDMA modes, Hotspot SAR Data was considered to determined body-worn SAR compliance per FCC KDB Publication 941225 D06.

Note: Per October 2010 TCB Workshop, the mid. channel may be used as a default test channel when the output power deviation across the channels is <0.5 dB, otherwise the maximum output power must be used; thus low channel was used for SAR testing for GSM1900. If the SAR measured at for each test configuration for the default channel is at least 3.0 dB lower than the SAR limit, testing at the other channels is optional for such test configuration(s).

**Table 11-7
WLAN Body-Worn SAR Results**

MEASUREMENT RESULTS										
FREQUENCY		Mode	Service	Conducted Power [dBm]	Power Drift [dB]	Spacing	Device Serial Number	Data Rate (Mbps)	Side	SAR (1g)
MHz	Ch.									(W/kg)
2412	1	IEEE 802.11b	DSSS	15.33	0.09	1.0 cm	KGM-U-002	1	back	0.080
ANSI / IEEE C95.1 1992 - SAFETY LIMIT Spatial Peak Uncontrolled Exposure/General Population						Body 1.6 W/kg (mW/g) averaged over 1 gram				

Note: For IEEE 802.11b mode, Hotspot SAR Data was considered to determined body-worn SAR compliance per FCC KDB Publication 941225 D06.



FCC ID: TYK-EYC4287	 PCTEST ENGINEERING LABORATORY, INC.	SAR EVALUATION REPORT		Reviewed by: Quality Manager
Document S/N: 0Y1207251026-R1.TYK	Test Dates: 07/26/12 - 08/01/12	DUT Type: Portable Handset		Page 27 of 38

11.3 Standalone Wireless Router SAR Data

Table 11-8
Licensed Transmitter Hotspot SAR Data

MEASUREMENT RESULTS										
FREQUENCY		Mode	Service	Conducted Power [dBm]	Power Drift [dB]	Spacing	Device Serial Number	# of GPRS Slots	Side	SAR (1g)
MHz	Ch.									(W/kg)
836.52	384	Cell. CDMA	TDSO / SO32	24.14	-0.02	1.0 cm	KGM-U-004	N/A	back	0.747
836.52	384	Cell. CDMA	TDSO / SO32	24.14	0.03	1.0 cm	KGM-U-004	N/A	front	0.770
836.52	384	Cell. CDMA	TDSO / SO32	24.14	0.06	1.0 cm	KGM-U-004	N/A	bottom	0.132
836.52	384	Cell. CDMA	TDSO / SO32	24.14	-0.07	1.0 cm	KGM-U-004	N/A	right	0.502
824.20	128	GSM 850	GPRS	33.55	-0.02	1.0 cm	KGM-U-004	1	back	0.754
836.60	190	GSM 850	GPRS	33.46	-0.06	1.0 cm	KGM-U-004	1	back	0.861
848.80	251	GSM 850	GPRS	33.53	-0.03	1.0 cm	KGM-U-004	1	back	0.842
824.20	128	GSM 850	GPRS	33.55	0.03	1.0 cm	KGM-U-004	1	front	0.725
836.60	190	GSM 850	GPRS	33.46	-0.02	1.0 cm	KGM-U-004	1	front	0.804
848.80	251	GSM 850	GPRS	33.53	-0.03	1.0 cm	KGM-U-004	1	front	0.854
836.60	190	GSM 850	GPRS	33.46	-0.04	1.0 cm	KGM-U-004	1	bottom	0.129
836.60	190	GSM 850	GPRS	33.46	0.03	1.0 cm	KGM-U-004	1	right	0.501
836.60	4183	WCDMA 850	RMC	23.60	-0.02	1.0 cm	KGM-U-004	N/A	back	0.724
836.60	4183	WCDMA 850	RMC	23.60	0.02	1.0 cm	KGM-U-004	N/A	front	0.675
836.60	4183	WCDMA 850	RMC	23.60	0.11	1.0 cm	KGM-U-004	N/A	bottom	0.092
836.60	4183	WCDMA 850	RMC	23.60	-0.12	1.0 cm	KGM-U-004	N/A	right	0.528
1850.20	512	GSM 1900	GPRS	30.75	-0.05	1.0 cm	KGM-U-004	1	back	0.624
1850.20	512	GSM 1900	GPRS	30.75	-0.06	1.0 cm	KGM-U-004	1	front	0.541
1850.20	512	GSM 1900	GPRS	30.75	-0.06	1.0 cm	KGM-U-004	1	bottom	0.083
1850.20	512	GSM 1900	GPRS	30.75	-0.05	1.0 cm	KGM-U-004	1	right	0.325
ANSI / IEEE C95.1 1992 - SAFETY LIMIT						Body				
Spatial Peak						1.6 W/kg (mW/g)				
Uncontrolled Exposure/General Population						averaged over 1 gram				

Note: Per October 2010 TCB Workshop, the mid. channel may be used as a default test channel when the output power deviation across the channels is <0.5 dB, otherwise the maximum output power must be used; thus low channel was used for SAR testing for GSM1900. If the SAR measured at for each test configuration for the default channel is at least 3.0 dB lower than the SAR limit, testing at the other channels is optional for such test configuration(s).

FCC ID: TYK-EYC4287	 PCTEST ENGINEERING LABORATORY, INC.	SAR EVALUATION REPORT		Reviewed by: Quality Manager
Document S/N: 0Y1207251026-R1.TYK	Test Dates: 07/26/12 - 08/01/12	DUT Type: Portable Handset		Page 28 of 38

**Table 11-9
WLAN Hotspot SAR Data**

MEASUREMENT RESULTS										
FREQUENCY		Mode	Service	Conducted Power [dBm]	Power Drift [dB]	Spacing	Device Serial Number	Data Rate (Mbps)	Side	SAR(1g)
MHz	Ch.									(W/kg)
2412	1	IEEE 802.11b	DSSS	15.33	0.09	1.0 cm	KGM-U-002	1	back	0.080
2412	1	IEEE 802.11b	DSSS	15.33	0.08	1.0 cm	KGM-U-002	1	front	0.063
2412	1	IEEE 802.11b	DSSS	15.33	0.05	1.0 cm	KGM-U-002	1	top	0.031
2412	1	IEEE 802.11b	DSSS	15.33	-0.14	1.0 cm	KGM-U-002	1	right	0.010
ANSI / IEEE C95.1 1992 - SAFETY LIMIT						Body				
Spatial Peak						1.6 W/kg (mW/g)				
Uncontrolled Exposure/General Population						averaged over 1 gram				



11.4 SAR Test Notes

General Notes:

1. The test data reported are the worst-case SAR value with the position set in a typical configuration. Test procedures used were according to FCC/OET Bulletin 65, Supplement C [June 2001].
2. Batteries are fully charged for all readings. The standard battery was used.
3. Tissue parameters and temperatures are listed on the SAR plots.
4. Liquid tissue depth was at least 15.0 cm. To confirm the proper SAR liquid depth, the z-axis plots from the system verifications were included since the system verifications were performed using the same liquid, probe and DAE as the SAR tests in the same time period.
5. Per October 2010 TCB Workshop, the mid. channel may be used as a default test channel when the output power deviation across the channels is <0.5 dB, otherwise the maximum output power must be used; thus low channel was used for SAR testing for GSM1900. If the SAR measured for each test configuration for the default channel is at least 3.0 dB lower than the SAR limit, testing at the other channels is optional for such test configuration(s).
6. Device was tested using a fixed spacing for body-worn accessory testing. A separation distance of 10 mm was considered because the manufacturer has determined that there will be body-worn accessories available in the marketplace for users to support this separation distance.
7. The manufacturer has confirmed that the device(s) tested have the same physical, mechanical and thermal characteristics and are within operational tolerances expected for production units.

GSM Test Notes:

1. Body-Worn accessory testing is typically associated with voice operations. Therefore, GSM voice was evaluated for body-worn SAR using headphones.
2. Per FCC guidance, GPRS Data Mode is additionally required for body-worn configuration. Per KDB 941225 D06, when the same wireless modes and device transmission configurations are required for body-worn accessories and hotspot mode, it is not necessary to additionally test body-worn accessory SAR for the same device orientation. Therefore, the hotspot data for the back side configurations additionally shows body-worn compliance at the same distance.

FCC ID: TYK-EYC4287		SAR EVALUATION REPORT		Reviewed by: Quality Manager
Document S/N: 0Y1207251026-R1.TYK	Test Dates: 07/26/12 - 08/01/12	DUT Type: Portable Handset	Page 29 of 38	

CDMA Notes:

1. Head SAR for CDMA2000 mode was tested under RC3/SO55 per KDB Publication 941225 D01.
2. Body-Worn and Hotspot SAR was tested with 1x RTT with TDSO / SO32 FCH Only. TDSO / SO32 FCH+SCH SAR tests were not required since the average output power was not more than 0.25 dB higher than the TDSO / SO32 FCH only powers.

WCDMA Notes:



1. WCDMA mode in Body SAR was tested under RMC 12.2 kbps with HSPA Inactive per KDB Publication 941225 D01. HSPA SAR was not required since the average output power of the HSPA subtests was not more than 0.25 dB higher than the RMC level and SAR was less than 1.2 W/kg.
2. Per FCC KDB Publication 941225 D06, when the same wireless modes and device transmission configurations are required for body-worn accessories and hotspot mode, it is not necessary to additionally test body-worn accessory SAR for the same device orientation. Therefore, the hotspot data for the back side configuration additionally shows body-worn compliance at the same distance.

WLAN Notes:

1. Justification for reduced test configurations for WIFI channels per KDB Publication 248227 and April 2010 FCC/TCB Meeting Notes for 2.4 GHz WIFI: Highest average RF output power channel for the lowest data rate was selected for SAR evaluation in 802.11b. Other IEEE 802.11 modes (including 802.11g/n) were not investigated since the average output powers over all channels and data rates were not more than 0.25 dB higher than the tested channel in the lowest data rate of IEEE 802.11b mode.
2. WLAN transmission was verified using an uncalibrated spectrum analyzer.
3. Since the maximum extrapolated peak SAR of the zoom scan for the maximum output channel is <1.6 W/kg and the 1g averaged SAR is <0.8 W/kg, SAR testing on other channels is not required. Otherwise, the other default (or corresponding required) test channels were additionally tested using the lowest data rate.
4. Per FCC KDB Publication 941225 D06, when the same wireless modes and device transmission configurations are required for body-worn accessories and hotspot mode, it is not necessary to additionally test body-worn accessory SAR for the same device orientation. Therefore, the hotspot data for the back side configuration additionally shows body-worn compliance at the same distance.

Hotspot Notes:

1. Top and Left Edge for the licensed transmitter were not tested since the antenna distance from the edge was greater than 2.5 cm per FCC KDB Publication 941225 D06 guidance (see Section 1.3).
2. Bottom and Left Edge for the WLAN transmitter were not tested since the antenna distance from the edge was greater than 2.5 cm per FCC KDB Publication 941225 D06 (see Section 1.3).
3. During SAR Testing for the Wireless Router conditions per KDB 941225 D06, the actual Portable Hotspot operation (with actual simultaneous transmission of a transmitter with WIFI) was not activated (See Section 6.6.)

FCC ID: TYK-EYC4287		SAR EVALUATION REPORT		Reviewed by: Quality Manager
Document S/N: 0Y1207251026-R1.TYK	Test Dates: 07/26/12 - 08/01/12	DUT Type: Portable Handset		Page 30 of 38

12 FCC MULTI-TX AND ANTENNA SAR CONSIDERATIONS

12.1 Introduction

The following procedures adopted from “FCC SAR Considerations for Cell Phones with Multiple Transmitters” FCC KDB Publication 648474 are applicable to handsets with built-in unlicensed transmitters such as 802.11b/g/n and Bluetooth devices which may simultaneously transmit with the licensed transmitter.

12.2 FCC Power Tables & Conditions

	2.45	5.15 - 5.35	5.47 - 5.85	GHz
P_{Ref}	12	6	5	mW

Device output power should be rounded to the nearest mW to compare with values specified in this table.



Figure 12-1
Output Power Thresholds for Unlicensed Transmitters

	Individual Transmitter	Simultaneous Transmission
Licensed Transmitters	<u>Routine evaluation required</u>	SAR not required: <u>Unlicensed only</u>
Unlicensed Transmitters	<p><u>When there is no simultaneous transmission –</u></p> <ul style="list-style-type: none"> output $\leq 60/f$: SAR not required output $> 60/f$: stand-alone SAR required <p><u>When there is simultaneous transmission –</u></p> <p><u>Stand-alone SAR not required when</u></p> <ul style="list-style-type: none"> output $\leq 2 \cdot P_{Ref}$ and antenna is ≥ 5.0 cm from other antennas output $\leq P_{Ref}$ and antenna is ≥ 2.5 cm from other antennas output $\leq P_{Ref}$ and antenna is < 2.5 cm from other antennas, each with either output power $\leq P_{Ref}$ or 1-g SAR < 1.2 W/kg <p><u>Otherwise stand-alone SAR is required</u></p> <p><u>When stand-alone SAR is required</u></p> <ul style="list-style-type: none"> test SAR on highest output channel for each wireless mode and exposure condition if SAR for highest output channel is $> 50\%$ of SAR limit, evaluate all channels according to normal procedures 	<ul style="list-style-type: none"> when stand-alone 1-g SAR is not required and antenna is ≥ 5 cm from other antennas <p><u>Licensed & Unlicensed</u></p> <ul style="list-style-type: none"> when the sum of the 1-g SAR is < 1.6 W/kg for all simultaneous transmitting antennas when SAR to peak location separation ratio of simultaneous transmitting antenna pair is < 0.3 <p>SAR required:</p> <p><u>Licensed & Unlicensed</u></p> <p>antenna pairs with SAR to peak location separation ratio ≥ 0.3; test is only required for the configuration that results in the highest SAR in stand-alone configuration for each wireless mode and exposure condition</p> <p>Note: simultaneous transmission exposure conditions for head and body can be different for different style phones; therefore, different test requirements may apply</p>

Figure 12-2
SAR Evaluation Requirements for Multiple Transmitter Handsets

According to Figure 12-1 and Figure 12-2, simultaneous transmission analysis of SAR may be required for this device for the licensed and unlicensed transmitters. Possible simultaneous transmissions for this device were numerically summed using stand-alone SAR data and are shown in the following tables.

Per KDB Publication 648474, standalone Bluetooth SAR tests were not required. Standalone SAR tests for WLAN were required. See Section 1.4(A) for more information.

FCC ID: TYK-EYC4287	 PCTEST ENGINEERING LABORATORY, INC.	SAR EVALUATION REPORT		Reviewed by: Quality Manager
Document S/N: 0Y1207251026-R1.TYK	Test Dates: 07/26/12 - 08/01/12	DUT Type: Portable Handset		Page 31 of 38

12.3 Head SAR Simultaneous Transmission Analysis

Table 12-1
Simultaneous Transmission Scenario (Held to Ear)

Simult Tx	Configuration	Cell. CDMA SAR (W/kg)	2.4 GHz WLAN SAR (W/kg)	Σ SAR (W/kg)	Simult Tx	Configuration	GSM 850 SAR (W/kg)	2.4 GHz WLAN SAR (W/kg)	Σ SAR (W/kg)
Head SAR	Right Cheek	0.726	0.177	0.903	Head SAR	Right Cheek	0.753	0.177	0.930
	Right Tilt	0.360	0.122	0.482		Right Tilt	0.387	0.122	0.509
	Left Cheek	0.597	0.355	0.952		Left Cheek	0.651	0.355	1.006
	Left Tilt	0.309	0.152	0.461		Left Tilt	0.368	0.152	0.520
Simult Tx	Configuration	WCDMA 850 SAR (W/kg)	2.4 GHz WLAN SAR (W/kg)	Σ SAR (W/kg)	Simult Tx	Configuration	GSM 1900 SAR (W/kg)	2.4 GHz WLAN SAR (W/kg)	Σ SAR (W/kg)
Head SAR	Right Cheek	0.552	0.177	0.729	Head SAR	Right Cheek	1.190	0.177	1.367
	Right Tilt	0.295	0.122	0.417		Right Tilt	0.258	0.122	0.380
	Left Cheek	0.471	0.355	0.826		Left Cheek	0.534	0.355	0.889
	Left Tilt	0.275	0.152	0.427		Left Tilt	0.267	0.152	0.419



The above tables represent a held to ear voice call potentially simultaneously operating with 2.4 GHz WLAN.

12.4 Body-Worn Simultaneous Transmission Analysis

Table 12-2
Simultaneous Transmission Scenario (Body-Worn at 1.0 cm)

Configuration	Mode	2G/3G SAR (W/kg)	2.4 GHz WLAN SAR (W/kg)	Σ SAR (W/kg)
Back Side	Cell. CDMA	0.747	0.080	0.827
Back Side	GSM 850	0.807	0.080	0.887
Back Side	WCDMA 850	0.724	0.080	0.804
Back Side	GSM 1900	0.682	0.080	0.762

The above tables represent a body-worn voice call potentially simultaneously operating with 2.4 GHz WLAN.

FCC ID: TYK-EYC4287	 PCTEST ENGINEERING LABORATORY, INC.	SAR EVALUATION REPORT		Reviewed by: Quality Manager
Document S/N: 0Y1207251026-R1.TYK	Test Dates: 07/26/12 - 08/01/12	DUT Type: Portable Handset		Page 32 of 38

12.5 Hotspot SAR Simultaneous Transmission Analysis



Table 12-3
Simultaneous Transmission Scenario (Hotspot at 1.0 cm)

Simult Tx	Configuration	Cell. CDMA SAR (W/kg)	2.4 GHz WLAN SAR (W/kg)	Σ SAR (W/kg)
Body SAR	Back	0.747	0.080	0.827
	Front	0.770	0.063	0.833
	Top	-	0.031	0.031
	Bottom	0.132	-	0.132
	Right	0.502	0.010	0.512
	Left	-	-	0.000
Simult Tx	Configuration	GPRS 850 SAR (W/kg)	2.4 GHz WLAN SAR (W/kg)	Σ SAR (W/kg)
Body SAR	Back	0.861	0.080	0.941
	Front	0.854	0.063	0.917
	Top	-	0.031	0.031
	Bottom	0.129	-	0.129
	Right	0.501	0.010	0.511
	Left	-	-	0.000
Simult Tx	Configuration	WCDMA 850 SAR (W/kg)	2.4 GHz WLAN SAR (W/kg)	Σ SAR (W/kg)
Body SAR	Back	0.724	0.080	0.804
	Front	0.675	0.063	0.738
	Top	-	0.031	0.031
	Bottom	0.092	-	0.092
	Right	0.528	0.010	0.538
	Left	-	-	0.000
Simult Tx	Configuration	GPRS 1900 SAR (W/kg)	2.4 GHz WLAN SAR (W/kg)	Σ SAR (W/kg)
Body SAR	Back	0.624	0.080	0.704
	Front	0.541	0.063	0.604
	Top	-	0.031	0.031
	Bottom	0.083	-	0.083
	Right	0.325	0.010	0.335
	Left	-	-	0.000

Note: Per FCC KDB Publication 941225 D06, the edges with antennas more than 2.5 cm are not required to be evaluated for SAR (“-”). The above tables represent a portable hotspot condition.

12.6 Simultaneous Transmission Conclusion



The above numerical summed SAR was below the SAR limit. Therefore, the above analysis is sufficient to determine that simultaneous transmission cases will not exceed the SAR limit. No volumetric SAR summation is required per FCC KDB Publication 648474.

FCC ID: TYK-EYC4287	 PCTEST ENGINEERING LABORATORY, INC.	SAR EVALUATION REPORT		Reviewed by: Quality Manager
Document S/N: 0Y1207251026-R1.TYK	Test Dates: 07/26/12 - 08/01/12	DUT Type: Portable Handset		Page 33 of 38

13 EQUIPMENT LIST

Manufacturer	Model	Description	Cal Date	Cal Interval	Cal Due	Serial Number
Agilent	85047A	S-Parameter Test Set	N/A	N/A	N/A	2904A00579
Agilent	85070E	Dielectric Probe Kit	3/8/2012	Annual	3/8/2013	MY44300633
Agilent	8594A	(9kHz-2.9GHz) Spectrum Analyzer	N/A	N/A	N/A	3051A00187
Agilent	8648D	(9kHz-4GHz) Signal Generator	10/10/2011	Annual	10/10/2012	3613A00315
Agilent	8648D	Signal Generator	4/3/2012	Annual	4/3/2013	3629U00687
Agilent	8753E	(30kHz-6GHz) Network Analyzer	4/4/2012	Annual	4/4/2013	JP38020182
Agilent	E5515C	Wireless Communications Test Set	10/10/2011	Annual	10/10/2012	GB46110872
Agilent	E8257D	(250kHz-20GHz) Signal Generator	4/5/2012	Annual	4/5/2013	MY45470194
Amplifier Research	5S1G4	5W, 800MHz-4.2GHz	N/A	CBT	N/A	21910
Anritsu	MA2481A	Power Sensor	2/14/2012	Annual	2/14/2013	5318
Anritsu	ML2438A	Power Meter	2/14/2012	Annual	2/14/2013	1190013
Anritsu	MT8820C	Radio Communication Tester	11/11/2011	Annual	11/11/2012	6200901190
COMTech	AR85729-5	Solid State Amplifier	N/A	CBT	N/A	M1S5A00-009
Control Company	36934-158	Wall-Mounted Thermometer	1/4/2012	Biennial	1/4/2014	122014497
Control Company	61220-416	Long-Stem Thermometer	2/15/2011	Biennial	2/15/2013	111331322
Gigatronics	80701A	(0.05-18GHz) Power Sensor	10/12/2011	Annual	10/12/2012	1833460
Gigatronics	8651A	Universal Power Meter	10/12/2011	Annual	10/12/2012	8650319
Intelligent Weigh	PD-3000	Electronic Balance	3/27/2012	Annual	3/27/2013	11081534
Intelligent Weighing	PD-3000	Electronic Balance	6/29/2012	Annual	6/29/2013	120405017
MCL	BW-N6W5+	6dB Attenuator	N/A	CBT	N/A	1139
MiniCircuits	SLP-2400+	Low Pass Filter	N/A	CBT	N/A	R8979500903
Mini-Circuits	BW-N20W5+	DC to 18 GHz Precision Fixed 20 dB Attenuator	N/A	CBT	N/A	N/A
Mini-Circuits	NLP-1200+	Low Pass Filter DC to 1000 MHz	N/A	CBT	N/A	N/A
Mini-Circuits	NLP-2950+	Low Pass Filter DC to 2700 MHz	N/A	CBT	N/A	N/A
Narda	4014C-6	4 - 8 GHz SMA 6 dB Directional Coupler	N/A	CBT	N/A	N/A
Narda	4772-3	Attenuator (3dB)	N/A	CBT	N/A	9406
Narda	BW-S3W2	Attenuator (3dB)	N/A	CBT	N/A	120
Rohde & Schwarz	CMU200	Base Station Simulator	5/22/2012	Annual	5/22/2013	109892
Rohde & Schwarz	NRVD	Dual Channel Power Meter	4/8/2011	Biennial	4/8/2013	101695
Rohde & Schwarz	SMIQ03B	Signal Generator	4/5/2012	Annual	4/5/2013	DE27259
Seekonk	NC-100	Torque Wrench (8" lb)	11/29/2011	Triennial	11/29/2014	21053
SPEAG	D1900V2	1900 MHz SAR Dipole	2/22/2012	Annual	2/22/2013	5d149
SPEAG	D2450V2	2450 MHz SAR Dipole	1/24/2012	Annual	1/24/2013	797
SPEAG	D835V2	835 MHz SAR Dipole	4/20/2012	Annual	4/20/2013	4d119
SPEAG	DAE4	Dasy Data Acquisition Electronics	4/19/2012	Annual	4/19/2013	665
SPEAG	DAE4	Dasy Data Acquisition Electronics	2/20/2012	Annual	2/20/2013	649
SPEAG	DAE4	Dasy Data Acquisition Electronics	1/18/2012	Annual	1/18/2013	1272
SPEAG	ES3DV2	SAR Probe	8/25/2011	Annual	8/25/2012	3022
SPEAG	ES3DV3	SAR Probe	2/21/2012	Annual	2/21/2013	3258
SPEAG	ES3DV3	SAR Probe	2/7/2012	Annual	2/7/2013	3287
Tektronix	RSA-6114A	Real Time Spectrum Analyzer	4/5/2012	Annual	4/5/2013	B010177
VWR	36934-158	Wall-Mounted Thermometer	1/21/2011	Biennial	1/21/2013	111286445
VWR	62344-925	Mini-Thermometer	10/24/2011	Biennial	10/24/2013	111886430



Note: CBT (Calibrated Before Testing). Prior to testing, the measurement paths containing a cable, amplifier, attenuator, coupler or filter were connected to a calibrated source (i.e. a signal generator) to determine the losses of the measurement path. The power meter offset was then adjusted to compensate for the measurement system losses. This level offset is stored within the power meter before measurements are made. This calibration verification procedure applies to the system verification and output power measurements. The calibrated reading is then taken directly from the power meter after compensation of the losses for all final power measurements.

FCC ID: TYK-EYC4287	 PCTEST Engineering Laboratory, Inc.	SAR EVALUATION REPORT		Reviewed by: Quality Manager
Document S/N: 0Y1207251026-R1.TYK	Test Dates: 07/26/12 - 08/01/12	DUT Type: Portable Handset		Page 34 of 38

14 MEASUREMENT UNCERTAINTIES

a	b	c	d	e= f(d,k)	f	g	h = c x f/e	i = c x g/e	k	
Uncertainty Component	IEEE 1528 Sec.	Tol. (± %)	Prob. Dist.	Div.	c _i 1gm	c _i 10 gms	1gm u _i (± %)	10gms u _i (± %)	v _i	
Measurement System										
Probe Calibration	E.2.1	6.0	N	1	1.0	1.0	6.0	6.0	∞	
Axial Isotropy	E.2.2	0.25	N	1	0.7	0.7	0.2	0.2	∞	
Hemishperical Isotropy	E.2.2	1.3	N	1	1.0	1.0	1.3	1.3	∞	
Boundary Effect	E.2.3	0.4	N	1	1.0	1.0	0.4	0.4	∞	
Linearity	E.2.4	0.3	N	1	1.0	1.0	0.3	0.3	∞	
System Detection Limits	E.2.5	5.1	N	1	1.0	1.0	5.1	5.1	∞	
Readout Electronics	E.2.6	1.0	N	1	1.0	1.0	1.0	1.0	∞	
Response Time	E.2.7	0.8	R	1.73	1.0	1.0	0.5	0.5	∞	
Integration Time	E.2.8	2.6	R	1.73	1.0	1.0	1.5	1.5	∞	
RF Ambient Conditions	E.6.1	3.0	R	1.73	1.0	1.0	1.7	1.7	∞	
Probe Positioner Mechanical Tolerance	E.6.2	0.4	R	1.73	1.0	1.0	0.2	0.2	∞	
Probe Positioning w/ respect to Phantom	E.6.3	2.9	R	1.73	1.0	1.0	1.7	1.7	∞	
Extrapolation, Interpolation & Integration algorithms for Max. SAR Evaluation	E.5	1.0	R	1.73	1.0	1.0	0.6	0.6	∞	
Test Sample Related										
Test Sample Positioning	E.4.2	6.0	N	1	1.0	1.0	6.0	6.0	287	
Device Holder Uncertainty	E.4.1	3.32	R	1.73	1.0	1.0	1.9	1.9	∞	
Output Power Variation - SAR drift measurement	6.6.2	5.0	R	1.73	1.0	1.0	2.9	2.9	∞	
Phantom & Tissue Parameters										
Phantom Uncertainty (Shape & Thickness tolerances)	E.3.1	4.0	R	1.73	1.0	1.0	2.3	2.3	∞	
Liquid Conductivity - deviation from target values	E.3.2	5.0	R	1.73	0.64	0.43	1.8	1.2	∞	
Liquid Conductivity - measurement uncertainty	E.3.3	3.8	N	1	0.64	0.43	2.4	1.6	6	
Liquid Permittivity - deviation from target values	E.3.2	5.0	R	1.73	0.60	0.49	1.7	1.4	∞	
Liquid Permittivity - measurement uncertainty	E.3.3	4.5	N	1	0.60	0.49	2.7	2.2	6	
Combined Standard Uncertainty (k=1)							RSS	12.1	11.7	299
Expanded Uncertainty (95% CONFIDENCE LEVEL)							k=2	24.2	23.5	

The above measurement uncertainties are according to IEEE Std. 1528-2003



FCC ID: TYK-EYC4287	 PCTEST ENGINEERING LABORATORY, INC.	SAR EVALUATION REPORT		Reviewed by: Quality Manager
Document S/N: 0Y1207251026-R1.TYK	Test Dates: 07/26/12 - 08/01/12	DUT Type: Portable Handset		Page 35 of 38

15 CONCLUSION

15.1 Measurement Conclusion



The SAR evaluation indicates that the EUT complies with the RF radiation exposure limits of the FCC and Industry Canada, with respect to all parameters subject to this test. These measurements were taken to simulate the RF effects of RF exposure under worst-case conditions. Precise laboratory measures were taken to assure repeatability of the tests. The results and statements relate only to the item(s) tested.

Please note that the absorption and distribution of electromagnetic energy in the body are very complex phenomena that depend on the mass, shape, and size of the body, the orientation of the body with respect to the field vectors, and the electrical properties of both the body and the environment. Other variables that may play a substantial role in possible biological effects are those that characterize the environment (e.g. ambient temperature, air velocity, relative humidity, and body insulation) and those that characterize the individual (e.g. age, gender, activity level, debilitation, or disease). Because various factors may interact with one another to vary the specific biological outcome of an exposure to electromagnetic fields, any protection guide should consider maximal amplification of biological effects as a result of field-body interactions, environmental conditions, and physiological variables. [3]



FCC ID: TYK-EYC4287		SAR EVALUATION REPORT		Reviewed by: Quality Manager
Document S/N: 0Y1207251026-R1.TYK	Test Dates: 07/26/12 - 08/01/12	DUT Type: Portable Handset		Page 36 of 38

16 REFERENCES

- [1] Federal Communications Commission, ET Docket 93-62, Guidelines for Evaluating the Environmental Effects of Radiofrequency Radiation, Aug. 1996.
- [2] ANSI/IEEE C95.1-2005, American National Standard safety levels with respect to human exposure to radio frequency electromagnetic fields, 3kHz to 300GHz, New York: IEEE, 2006.
- [3] ANSI/IEEE C95.1-1992, American National Standard safety levels with respect to human exposure to radio frequency electromagnetic fields, 3kHz to 300GHz, New York: IEEE, Sept. 1992.
- [4] ANSI/IEEE C95.3-2002, IEEE Recommended Practice for the Measurement of Potentially Hazardous Electromagnetic Fields - RF and Microwave, New York: IEEE, December 2002.
- [5] Federal Communications Commission, OET Bulletin 65 (Edition 97-01), Supplement C (Edition 01-01), Evaluating Compliance with FCC Guidelines for Human Exposure to Radiofrequency Electromagnetic Fields, June 2001.
- [6] IEEE Standards Coordinating Committee 34 – IEEE Std. 1528-2003, Recommended Practice for Determining the Peak Spatial-Average Specific Absorption Rate (SAR) in the Human Body Due to Wireless Communications Devices.
- [7] NCRP, National Council on Radiation Protection and Measurements, Biological Effects and Exposure Criteria for RadioFrequency Electromagnetic Fields, NCRP Report No. 86, 1986. Reprinted Feb. 1995.
- [8] T. Schmid, O. Egger, N. Kuster, Automated E-field scanning system for dosimetric assessments, IEEE Transaction on Microwave Theory and Techniques, vol. 44, Jan. 1996, pp. 105-113.
- [9] K. Pokovic, T. Schmid, N. Kuster, Robust setup for precise calibration of E-field probes in tissue simulating liquids at mobile communications frequencies, ICECOM97, Oct. 1997, pp. 120-124.
- [10] K. Pokovic, T. Schmid, and N. Kuster, E-field Probe with improved isotropy in brain simulating liquids, Proceedings of the ELMAR, Zadar, Croatia, June 23-25, 1996, pp. 172-175.
- [11] Schmid & Partner Engineering AG, Application Note: Data Storage and Evaluation, June 1998, p2.
- [12] V. Hombach, K. Meier, M. Burkhardt, E. Kuhn, N. Kuster, The Dependence of EM Energy Absorption upon Human Head Modeling at 900 MHz, IEEE Transaction on Microwave Theory and Techniques, vol. 44 no. 10, Oct. 1996, pp. 1865-1873.
- [13] N. Kuster and Q. Balzano, Energy absorption mechanism by biological bodies in the near field of dipole antennas above 300MHz, IEEE Transaction on Vehicular Technology, vol. 41, no. 1, Feb. 1992, pp. 17-23.
- [14] G. Hartsgrove, A. Kraszewski, A. Surowiec, Simulated Biological Materials for Electromagnetic Radiation Absorption Studies, University of Ottawa, Bioelectromagnetics, Canada: 1987, pp. 29-36.
- [15] Q. Balzano, O. Garay, T. Manning Jr., Electromagnetic Energy Exposure of Simulated Users of Portable Cellular Telephones, IEEE Transactions on Vehicular Technology, vol. 44, no.3, Aug. 1995.
- [16] W. Gander, Computermathematick, Birkhaeuser, Basel, 1992.
- [17] W.H. Press, S.A. Teukolsky, W.T. Vetterling, and B.P. Flannery, Numerical Recipes in C, The Art of Scientific Computing, Second edition, Cambridge University Press, 1992.

FCC ID: TYK-EYC4287	 PCTEST ENGINEERING LABORATORY, INC.	SAR EVALUATION REPORT	 NEC	Reviewed by: Quality Manager
Document S/N: 0Y1207251026-R1.TYK	Test Dates: 07/26/12 - 08/01/12	DUT Type: Portable Handset		Page 37 of 38

- [18] Federal Communications Commission, OET Bulletin 65, Evaluating Compliance with FCC Guidelines for Human Exposure to Radiofrequency Electromagnetic Fields. Supplement C, Dec. 1997.
- [19] N. Kuster, R. Kastle, T. Schmid, Dosimetric evaluation of mobile communications equipment with known precision, IEEE Transaction on Communications, vol. E80-B, no. 5, May 1997, pp. 645-652.
- [20] CENELEC CLC/SC111B, European Prestandard (prENV 50166-2), Human Exposure to Electromagnetic Fields High-frequency: 10kHz-300GHz, Jan. 1995.
- [21] Prof. Dr. Niels Kuster, ETH, Eidgenössische Technische Hochschule Zürich, Dosimetric Evaluation of the Cellular Phone.
- [22] IEC 62209-1, Human exposure to radio frequency fields from hand-held and body-mounted wireless communication devices - Human models, instrumentation, and procedures - Part 1: Procedure to determine the specific absorption rate (SAR) for hand-held devices used in close proximity to the ear (frequency range of 300 MHz to 3 GHz), Feb. 2005.
- [23] Industry Canada RSS-102 Radio Frequency Exposure Compliance of Radiocommunication Apparatus (All Frequency Bands) Issue 4, March 2010.
- [24] Health Canada Safety Code 6 Limits of Human Exposure to Radio Frequency Electromagnetic Fields in the Frequency Range from 3 kHz – 300 GHz, 2009
- [25] FCC Public Notice DA-02-1438. Office of Engineering and Technology Announces a Transition Period for the Phantom Requirements of Supplement C to OET Bulletin 65, June 19, 2002
- [26] FCC SAR Measurement Procedures for 3G Devices KDB Publication 941225
- [27] SAR Measurement procedures for IEEE 802.11a/b/g KDB Publication 248227
- [28] FCC SAR Considerations for Handsets with Multiple Transmitters and Antennas, KDB Publication 648474
- [29] FCC Application Note for SAR Probe Calibration and System Verification Consideration for Measurements at 150 MHz – 3 GHz, KDB Publication 450824
- [30] FCC SAR Evaluation Considerations for Laptop Computers with Antennas Built-in on Display Screens, KDB Publication 616217
- [31] FCC SAR Measurement Requirements for 3 – 6 GHz, KDB Publication 865664
- [32] FCC Mobile Portable RF Exposure Procedure, KDB Publication 447498
- [33] FCC SAR Procedures for Dongle Transmitters, KDB Publication 447498
- [34] Anexo à Resolução No. 533, de 10 de Setembro de 2009.
- [35] FCC SAR Test Considerations for LTE Handsets and Data Modems, KDB Publication 941225.
- [36] IEC 62209-2, Human exposure to radio frequency fields from hand-held and body-mounted wireless communication devices - Human models, instrumentation, and procedures - Part 2: Procedure to determine the specific absorption rate (SAR) for wireless communication devices used in close proximity to the human body (frequency range of 30 MHz to 6 GHz), Mar. 2010.
- [37] FCC Hot Spot SAR v01, KDB Publication 941225 D06.

FCC ID: TYK-EYC4287		SAR EVALUATION REPORT		Reviewed by: Quality Manager
Document S/N: 0Y1207251026-R1.TYK	Test Dates: 07/26/12 - 08/01/12	DUT Type: Portable Handset	Page 38 of 38	

APPENDIX A: SAR TEST DATA

PCTEST ENGINEERING LABORATORY, INC.

DUT: TYK-EYC4287; Type: Portable Handset; Serial: KGM-U-004

Communication System: Cellular CDMA; Frequency: 836.52 MHz; Duty Cycle: 1:1

Medium: 835 Head Medium parameters used (interpolated):

$f = 836.52 \text{ MHz}$; $\sigma = 0.919 \text{ mho/m}$; $\epsilon_r = 40.697$; $\rho = 1000 \text{ kg/m}^3$

Phantom section: Right Section

Test Date: 07-26-2012; Ambient Temp: 24.2°C; Tissue Temp: 23.3°C

Probe: ES3DV3 - SN3258; ConvF(6.01, 6.01, 6.01); Calibrated: 2/21/2012

Sensor-Surface: 4mm (Mechanical Surface Detection)

Electronics: DAE4 Sn1272; Calibrated: 1/18/2012

Phantom: SAM Sub; Type: SAM 4.0; Serial: TP-1403

Measurement SW: DASY4, Version 4.7 (80); SEMCAD X Version 14.6.4 (4989)

Mode: Cellular CDMA, Right Head, Cheek, Mid.ch

Area Scan (7x14x1): Measurement grid: dx=15mm, dy=15mm

Zoom Scan (5x5x7)/Cube 0: Measurement grid: dx=8mm, dy=8mm, dz=5mm

Reference Value = 30.171 V/m; Power Drift = -0.02 dB

Peak SAR (extrapolated) = 1.0870

SAR(1 g) = 0.726 mW/g; SAR(10 g) = 0.482 mW/g

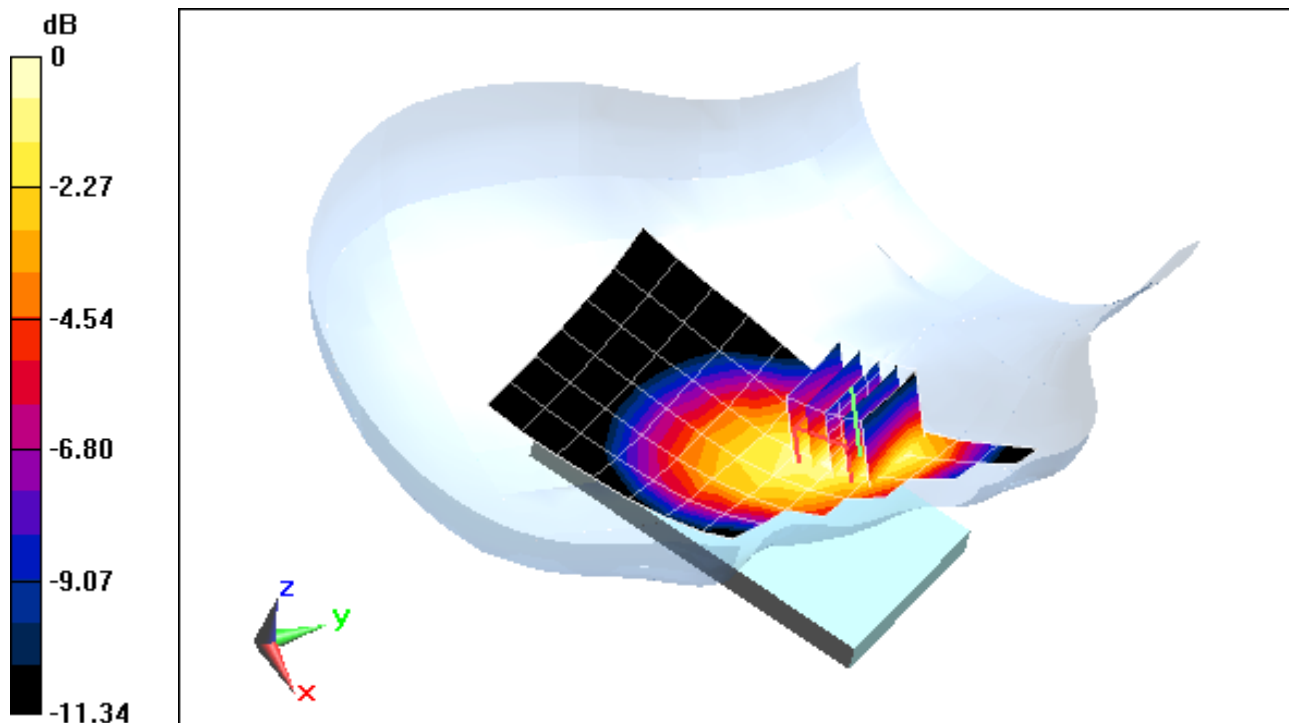

0 dB = 0.780mW/g = -2.16 dB mW/g

PCTEST ENGINEERING LABORATORY, INC.

DUT: TYK-EYC4287; Type: Portable Handset; Serial: KGM-U-004

Communication System: Cellular CDMA; Frequency: 836.52 MHz; Duty Cycle: 1:1

Medium: 835 Head Medium parameters used (interpolated):

$f = 836.52 \text{ MHz}$; $\sigma = 0.919 \text{ mho/m}$; $\epsilon_r = 40.697$; $\rho = 1000 \text{ kg/m}^3$

Phantom section: Right Section

Test Date: 07-26-2012; Ambient Temp: 24.2°C; Tissue Temp: 23.3°C

Probe: ES3DV3 - SN3258; ConvF(6.01, 6.01, 6.01); Calibrated: 2/21/2012

Sensor-Surface: 4mm (Mechanical Surface Detection)

Electronics: DAE4 Sn1272; Calibrated: 1/18/2012

Phantom: SAM Sub; Type: SAM 4.0; Serial: TP-1403

Measurement SW: DASY4, Version 4.7 (80); SEMCAD X Version 14.6.4 (4989)

Mode: Cellular CDMA, Right Head, Tilt, Mid.ch

Area Scan (7x14x1): Measurement grid: dx=15mm, dy=15mm

Zoom Scan (5x5x7)/Cube 0: Measurement grid: dx=8mm, dy=8mm, dz=5mm

Reference Value = 21.370 V/m; Power Drift = -0.0063 dB

Peak SAR (extrapolated) = 0.4330

SAR(1 g) = 0.360 mW/g; SAR(10 g) = 0.281 mW/g

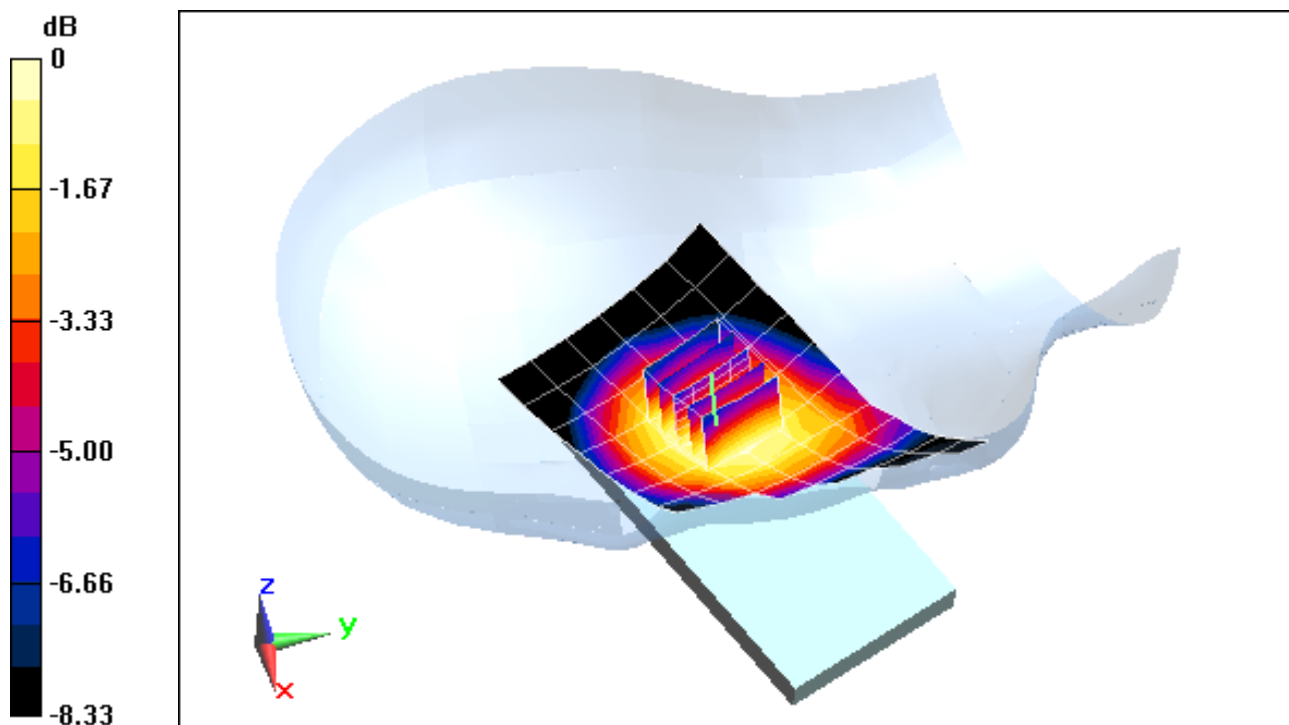

0 dB = 0.370mW/g = -8.64 dB mW/g

PCTEST ENGINEERING LABORATORY, INC.

DUT: TYK-EYC4287; Type: Portable Handset; Serial: KGM-U-004

Communication System: Cellular CDMA; Frequency: 836.52 MHz; Duty Cycle: 1:1

Medium: 835 Head Medium parameters used (interpolated):

$f = 836.52 \text{ MHz}$; $\sigma = 0.919 \text{ mho/m}$; $\epsilon_r = 40.697$; $\rho = 1000 \text{ kg/m}^3$

Phantom section: Left Section

Test Date: 07-26-2012; Ambient Temp: 24.2°C; Tissue Temp: 23.3°C

Probe: ES3DV3 - SN3258; ConvF(6.01, 6.01, 6.01); Calibrated: 2/21/2012

Sensor-Surface: 4mm (Mechanical Surface Detection)

Electronics: DAE4 Sn1272; Calibrated: 1/18/2012

Phantom: SAM Sub; Type: SAM 4.0; Serial: TP-1403

Measurement SW: DASY4, Version 4.7 (80); SEMCAD X Version 14.6.4 (4989)

Mode: Cellular CDMA, Left Head, Cheek, Mid.ch

Area Scan (7x14x1): Measurement grid: dx=15mm, dy=15mm

Zoom Scan (5x5x7)/Cube 0: Measurement grid: dx=8mm, dy=8mm, dz=5mm

Reference Value = 26.992 V/m; Power Drift = -0.05 dB

Peak SAR (extrapolated) = 0.7450

SAR(1 g) = 0.597 mW/g; SAR(10 g) = 0.452 mW/g

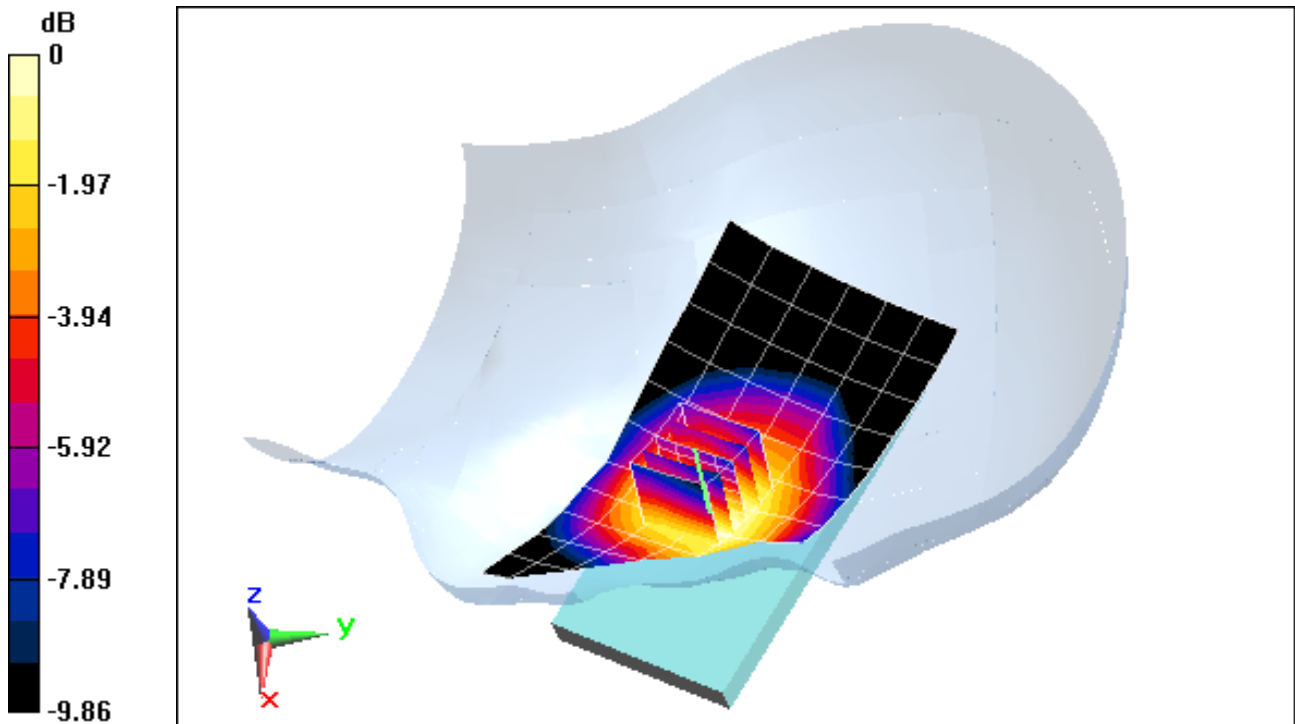

0 dB = 0.620mW/g = -4.15 dB mW/g

PCTEST ENGINEERING LABORATORY, INC.

DUT: TYK-EYC4287; Type: Portable Handset; Serial: KGM-U-004

Communication System: Cellular CDMA; Frequency: 836.52 MHz; Duty Cycle: 1:1

Medium: 835 Head Medium parameters used (interpolated):

$f = 836.52 \text{ MHz}$; $\sigma = 0.919 \text{ mho/m}$; $\epsilon_r = 40.697$; $\rho = 1000 \text{ kg/m}^3$

Phantom section: Left Section

Test Date: 07-26-2012; Ambient Temp: 24.2°C; Tissue Temp: 23.3°C

Probe: ES3DV3 - SN3258; ConvF(6.01, 6.01, 6.01); Calibrated: 2/21/2012

Sensor-Surface: 4mm (Mechanical Surface Detection)

Electronics: DAE4 Sn1272; Calibrated: 1/18/2012

Phantom: SAM Sub; Type: SAM 4.0; Serial: TP-1403

Measurement SW: DASY4, Version 4.7 (80); SEMCAD X Version 14.6.4 (4989)

Mode: Cellular CDMA, Left Head, Tilt, Mid.ch

Area Scan (7x14x1): Measurement grid: dx=15mm, dy=15mm

Zoom Scan (5x5x7)/Cube 0: Measurement grid: dx=8mm, dy=8mm, dz=5mm

Reference Value = 19.693 V/m; Power Drift = -0.03 dB

Peak SAR (extrapolated) = 0.3720

SAR(1 g) = 0.309 mW/g; SAR(10 g) = 0.244 mW/g

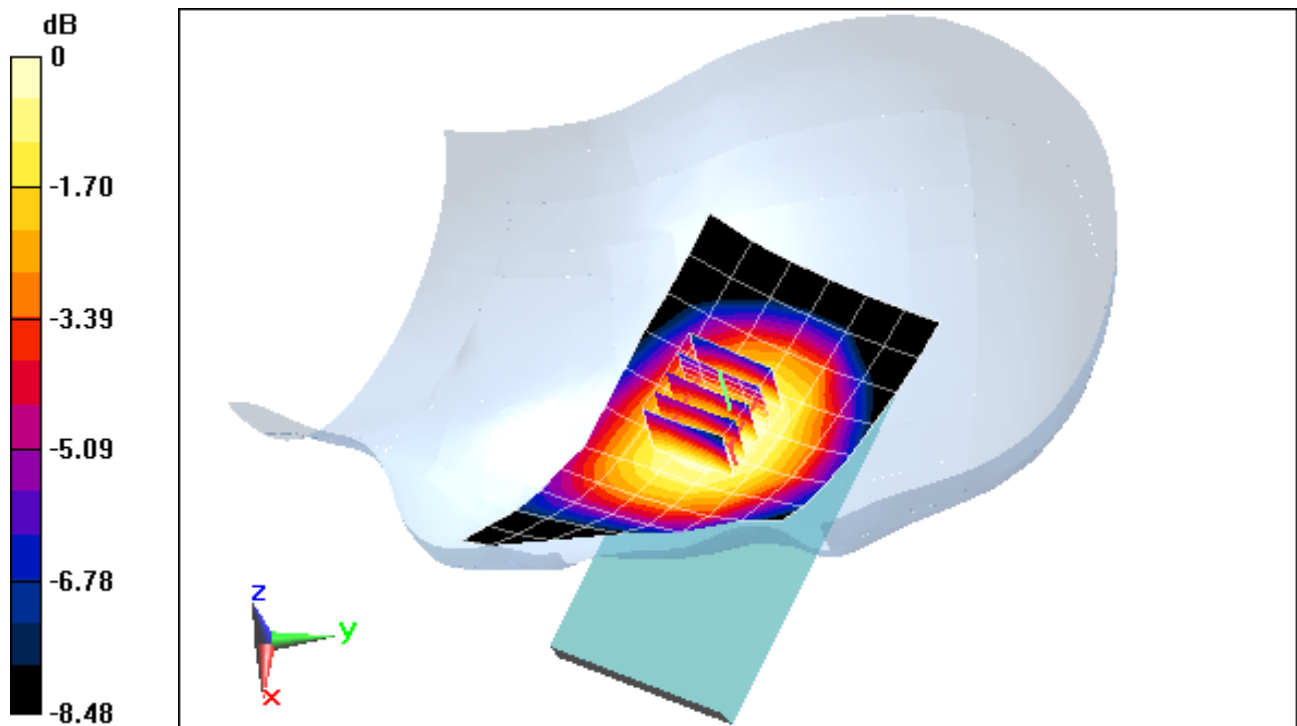

0 dB = 0.320mW/g = -9.90 dB mW/g

PCTEST ENGINEERING LABORATORY, INC.

DUT: TYK-EYC4287; Type: Portable Handset; Serial: KGM-U-004

Communication System: GSM850; Frequency: 836.6 MHz; Duty Cycle: 1:8.3

Medium: 835 Head Medium parameters used (interpolated):

$f = 836.6 \text{ MHz}$; $\sigma = 0.919 \text{ mho/m}$; $\epsilon_r = 40.695$; $\rho = 1000 \text{ kg/m}^3$

Phantom section: Right Section

Test Date: 07-26-2012; Ambient Temp: 24.2°C; Tissue Temp: 23.3°C

Probe: ES3DV3 - SN3258; ConvF(6.01, 6.01, 6.01); Calibrated: 2/21/2012

Sensor-Surface: 4mm (Mechanical Surface Detection)

Electronics: DAE4 Sn1272; Calibrated: 1/18/2012

Phantom: SAM Sub; Type: SAM 4.0; Serial: TP-1403

Measurement SW: DASY4, Version 4.7 (80); SEMCAD X Version 14.6.4 (4989)

Mode: GSM 850, Right Head, Cheek, Mid.ch

Area Scan (7x14x1): Measurement grid: dx=15mm, dy=15mm

Zoom Scan (5x5x7)/Cube 0: Measurement grid: dx=8mm, dy=8mm, dz=5mm

Reference Value = 29.322 V/m; Power Drift = -0.05 dB

Peak SAR (extrapolated) = 1.1210

SAR(1 g) = 0.753 mW/g; SAR(10 g) = 0.507 mW/g

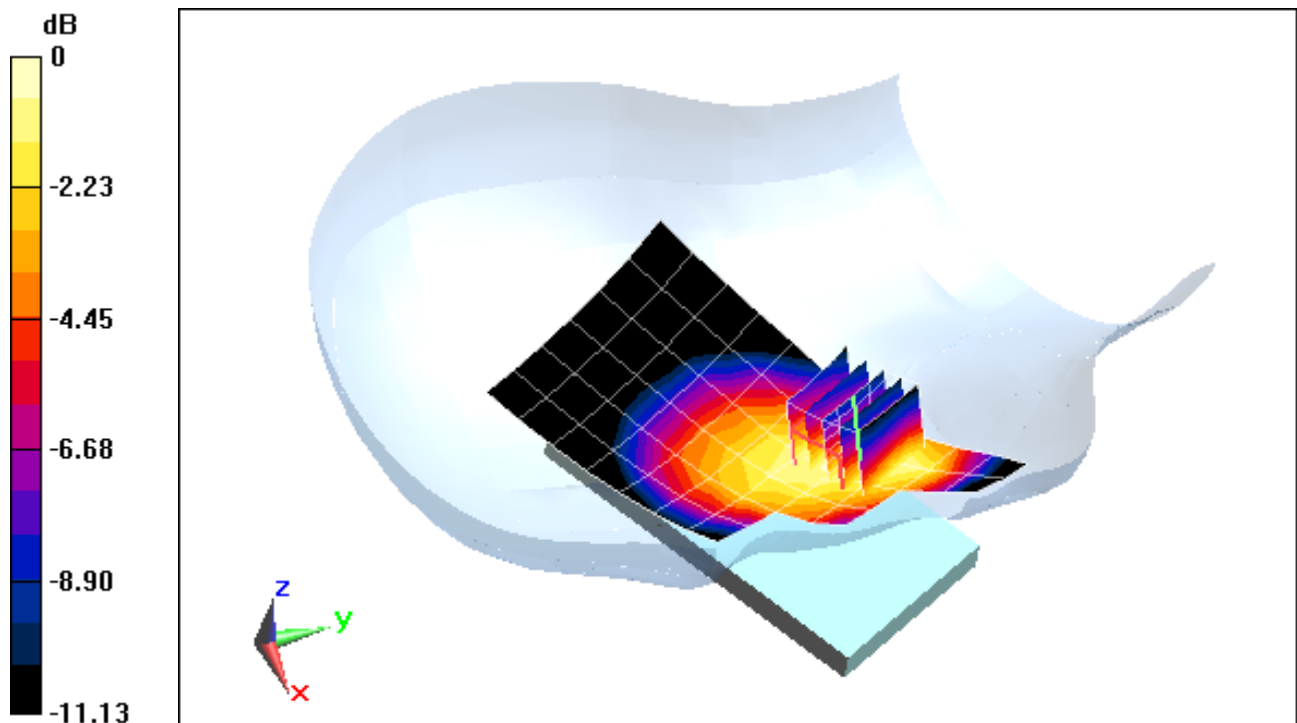

0 dB = 0.810mW/g = -1.83 dB mW/g

PCTEST ENGINEERING LABORATORY, INC.

DUT: TYK-EYC4287; Type: Portable Handset; Serial: KGM-U-004

Communication System: GSM850; Frequency: 836.6 MHz; Duty Cycle: 1:8.3

Medium: 835 Head Medium parameters used (interpolated):

$f = 836.6 \text{ MHz}$; $\sigma = 0.919 \text{ mho/m}$; $\epsilon_r = 40.695$; $\rho = 1000 \text{ kg/m}^3$

Phantom section: Right Section

Test Date: 07-26-2012; Ambient Temp: 24.2°C; Tissue Temp: 23.3°C

Probe: ES3DV3 - SN3258; ConvF(6.01, 6.01, 6.01); Calibrated: 2/21/2012

Sensor-Surface: 4mm (Mechanical Surface Detection)

Electronics: DAE4 Sn1272; Calibrated: 1/18/2012

Phantom: SAM Sub; Type: SAM 4.0; Serial: TP-1403

Measurement SW: DASY4, Version 4.7 (80); SEMCAD X Version 14.6.4 (4989)

Mode: GSM 850, Right Head, Tilt, Mid.ch

Area Scan (7x14x1): Measurement grid: $dx=15\text{mm}$, $dy=15\text{mm}$

Zoom Scan (5x5x7)/Cube 0: Measurement grid: $dx=8\text{mm}$, $dy=8\text{mm}$, $dz=5\text{mm}$

Reference Value = 21.293 V/m; Power Drift = -0.07 dB

Peak SAR (extrapolated) = 0.4680

SAR(1 g) = 0.387 mW/g; SAR(10 g) = 0.297 mW/g

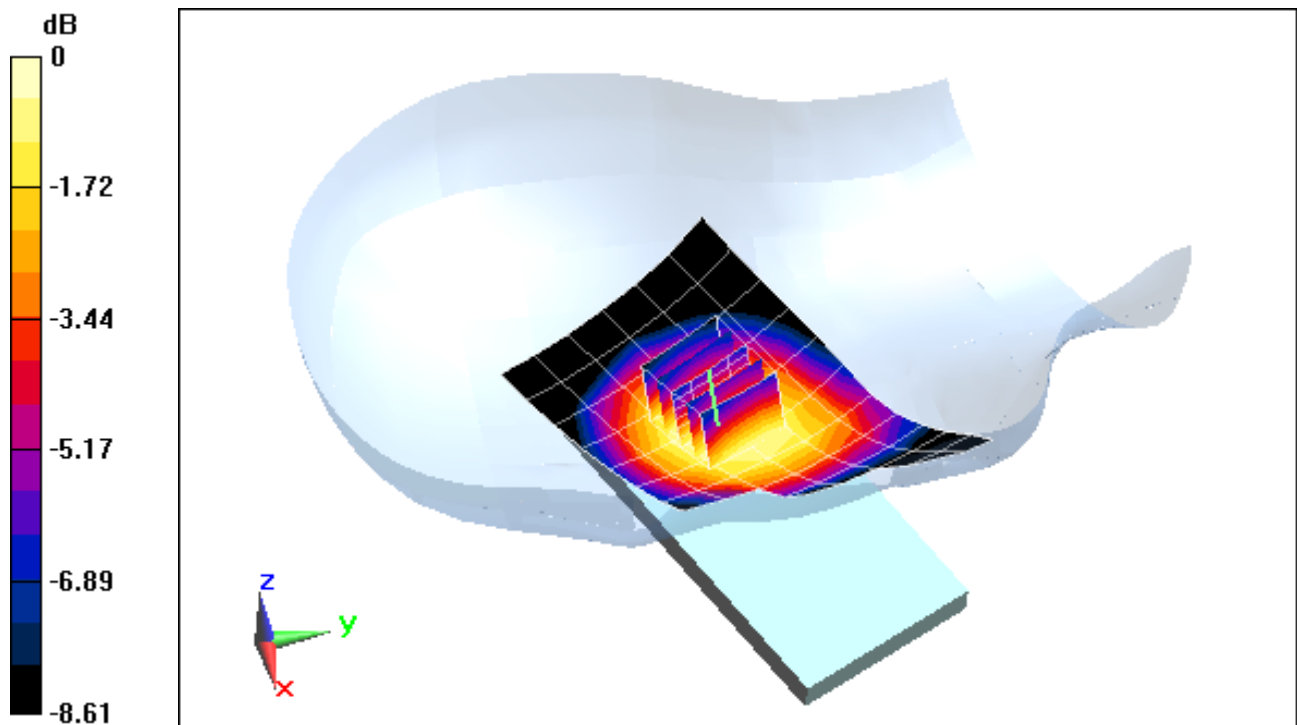

0 dB = 0.410mW/g = -7.74 dB mW/g

PCTEST ENGINEERING LABORATORY, INC.

DUT: TYK-EYC4287; Type: Portable Handset; Serial: KGM-U-004

Communication System: GSM850; Frequency: 836.6 MHz; Duty Cycle: 1:8.3

Medium: 835 Head Medium parameters used (interpolated):

$f = 836.6 \text{ MHz}$; $\sigma = 0.919 \text{ mho/m}$; $\epsilon_r = 40.695$; $\rho = 1000 \text{ kg/m}^3$

Phantom section: Left Section

Test Date: 07-26-2012; Ambient Temp: 24.2°C; Tissue Temp: 23.3°C

Probe: ES3DV3 - SN3258; ConvF(6.01, 6.01, 6.01); Calibrated: 2/21/2012

Sensor-Surface: 4mm (Mechanical Surface Detection)

Electronics: DAE4 Sn1272; Calibrated: 1/18/2012

Phantom: SAM Sub; Type: SAM 4.0; Serial: TP-1403

Measurement SW: DASY4, Version 4.7 (80); SEMCAD X Version 14.6.4 (4989)

Mode: GSM 850, Left Head, Cheek, Mid.ch

Area Scan (7x14x1): Measurement grid: dx=15mm, dy=15mm

Zoom Scan (5x5x7)/Cube 0: Measurement grid: dx=8mm, dy=8mm, dz=5mm

Reference Value = 26.968 V/m; Power Drift = -0.03 dB

Peak SAR (extrapolated) = 0.7940

SAR(1 g) = 0.651 mW/g; SAR(10 g) = 0.493 mW/g

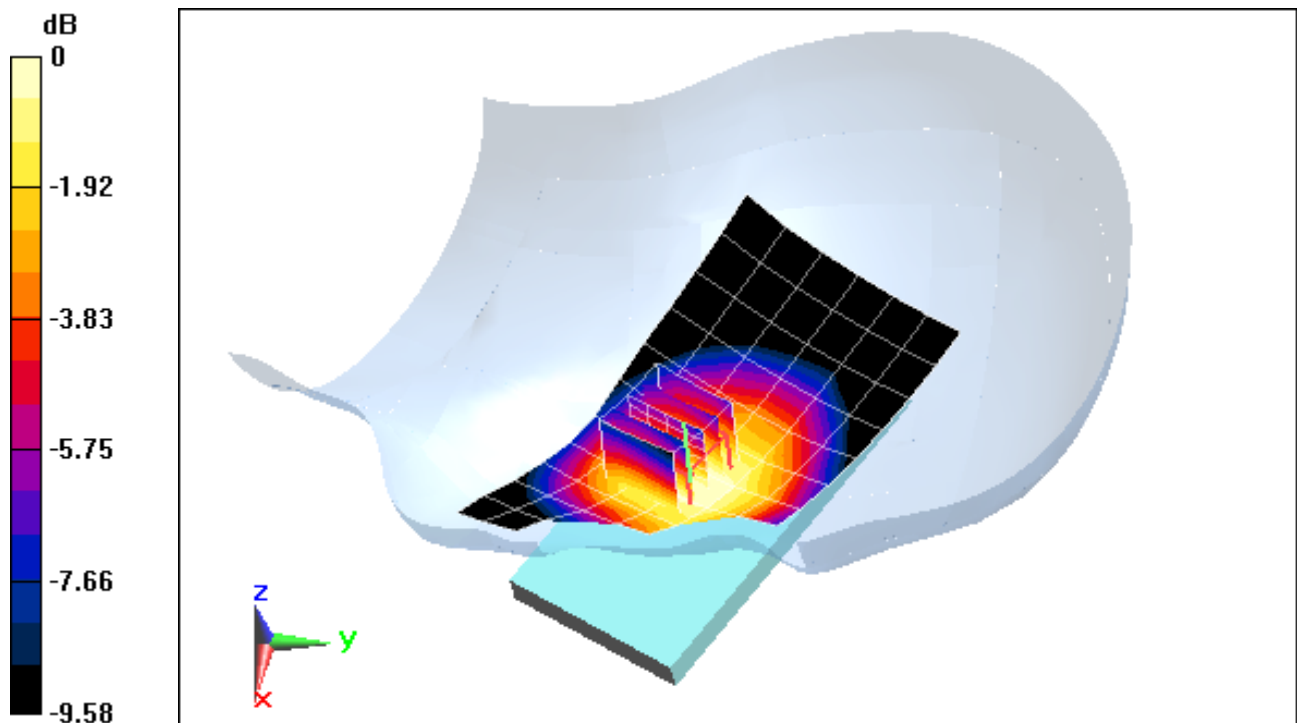

0 dB = 0.680mW/g = -3.35 dB mW/g

PCTEST ENGINEERING LABORATORY, INC.

DUT: TYK-EYC4287; Type: Portable Handset; Serial: KGM-U-004

Communication System: GSM850; Frequency: 836.6 MHz; Duty Cycle: 1:8.3

Medium: 835 Head Medium parameters used (interpolated):

$f = 836.6 \text{ MHz}$; $\sigma = 0.919 \text{ mho/m}$; $\epsilon_r = 40.695$; $\rho = 1000 \text{ kg/m}^3$

Phantom section: Left Section

Test Date: 07-26-2012; Ambient Temp: 24.2°C; Tissue Temp: 23.3°C

Probe: ES3DV3 - SN3258; ConvF(6.01, 6.01, 6.01); Calibrated: 2/21/2012

Sensor-Surface: 4mm (Mechanical Surface Detection)

Electronics: DAE4 Sn1272; Calibrated: 1/18/2012

Phantom: SAM Sub; Type: SAM 4.0; Serial: TP-1403

Measurement SW: DASY4, Version 4.7 (80); SEMCAD X Version 14.6.4 (4989)

Mode: GSM 850, Left Head, Tilt, Mid.ch

Area Scan (7x14x1): Measurement grid: $dx=15\text{mm}$, $dy=15\text{mm}$

Zoom Scan (5x5x7)/Cube 0: Measurement grid: $dx=8\text{mm}$, $dy=8\text{mm}$, $dz=5\text{mm}$

Reference Value = 20.827 V/m; Power Drift = -0.005 dB

Peak SAR (extrapolated) = 0.4470

SAR(1 g) = 0.368 mW/g; SAR(10 g) = 0.285 mW/g

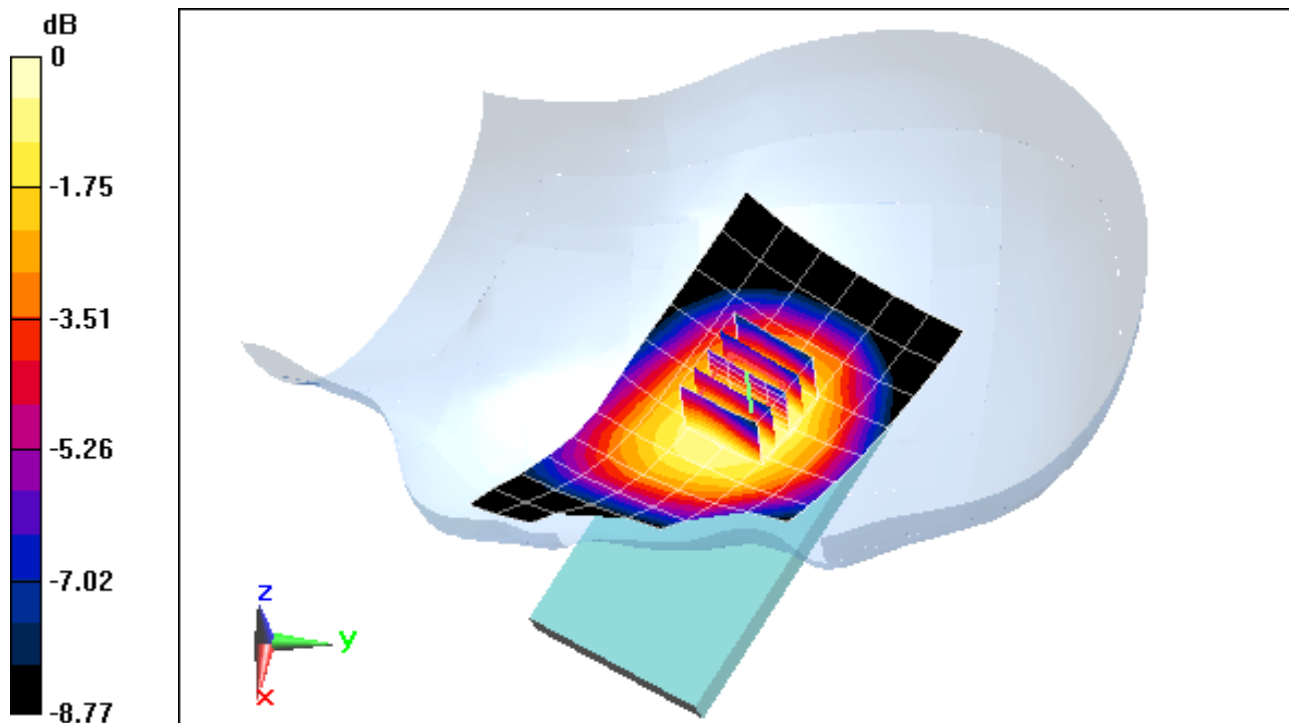

0 dB = 0.390mW/g = -8.18 dB mW/g

PCTEST ENGINEERING LABORATORY, INC.

DUT: TYK-EYC4287; Type: Portable Handset; Serial: KGM-U-004

Communication System: WCDMA850; Frequency: 836.6 MHz; Duty Cycle: 1:1

Medium: 835 Head Medium parameters used (interpolated):

$f = 836.6 \text{ MHz}$; $\sigma = 0.919 \text{ mho/m}$; $\epsilon_r = 40.695$; $\rho = 1000 \text{ kg/m}^3$

Phantom section: Right Section

Test Date: 07-26-2012; Ambient Temp: 24.2°C; Tissue Temp: 23.3°C

Probe: ES3DV3 - SN3258; ConvF(6.01, 6.01, 6.01); Calibrated: 2/21/2012

Sensor-Surface: 4mm (Mechanical Surface Detection)

Electronics: DAE4 Sn1272; Calibrated: 1/18/2012

Phantom: SAM Sub; Type: SAM 4.0; Serial: TP-1403

Measurement SW: DASY4, Version 4.7 (80); SEMCAD X Version 14.6.4 (4989)

Mode: WCDMA 850, Right Head, Cheek, Mid.ch

Area Scan (7x10x1): Measurement grid: dx=15mm, dy=15mm

Zoom Scan (5x5x7)/Cube 0: Measurement grid: dx=8mm, dy=8mm, dz=5mm

Reference Value = 25.321 V/m; Power Drift = 0.03 dB

Peak SAR (extrapolated) = 0.7950

SAR(1 g) = 0.552 mW/g; SAR(10 g) = 0.381 mW/g

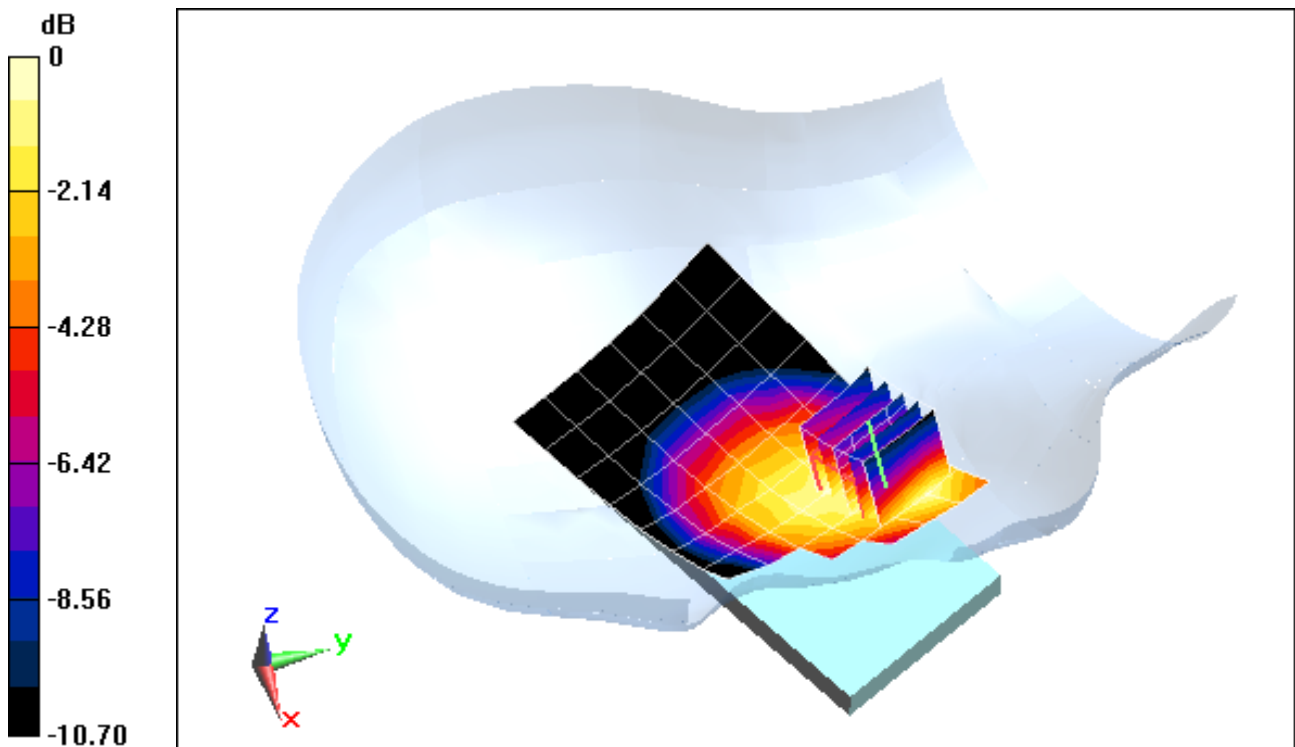

0 dB = 0.580mW/g = -4.73 dB mW/g

PCTEST ENGINEERING LABORATORY, INC.

DUT: TYK-EYC4287; Type: Portable Handset; Serial: KGM-U-004

Communication System: WCDMA850; Frequency: 836.6 MHz; Duty Cycle: 1:1

Medium: 835 Head Medium parameters used (interpolated):

$f = 836.6 \text{ MHz}$; $\sigma = 0.919 \text{ mho/m}$; $\epsilon_r = 40.695$; $\rho = 1000 \text{ kg/m}^3$

Phantom section: Right Section

Test Date: 07-26-2012; Ambient Temp: 24.2°C; Tissue Temp: 23.3°C

Probe: ES3DV3 - SN3258; ConvF(6.01, 6.01, 6.01); Calibrated: 2/21/2012

Sensor-Surface: 4mm (Mechanical Surface Detection)

Electronics: DAE4 Sn1272; Calibrated: 1/18/2012

Phantom: SAM Sub; Type: SAM 4.0; Serial: TP-1403

Measurement SW: DASY4, Version 4.7 (80); SEMCAD X Version 14.6.4 (4989)

Mode: WCDMA 850, Right Head, Tilt, Mid.ch

Area Scan (7x10x1): Measurement grid: dx=15mm, dy=15mm

Zoom Scan (5x5x7)/Cube 0: Measurement grid: dx=8mm, dy=8mm, dz=5mm

Reference Value = 18.870 V/m; Power Drift = -0.11 dB

Peak SAR (extrapolated) = 0.3510

SAR(1 g) = 0.295 mW/g; SAR(10 g) = 0.230 mW/g

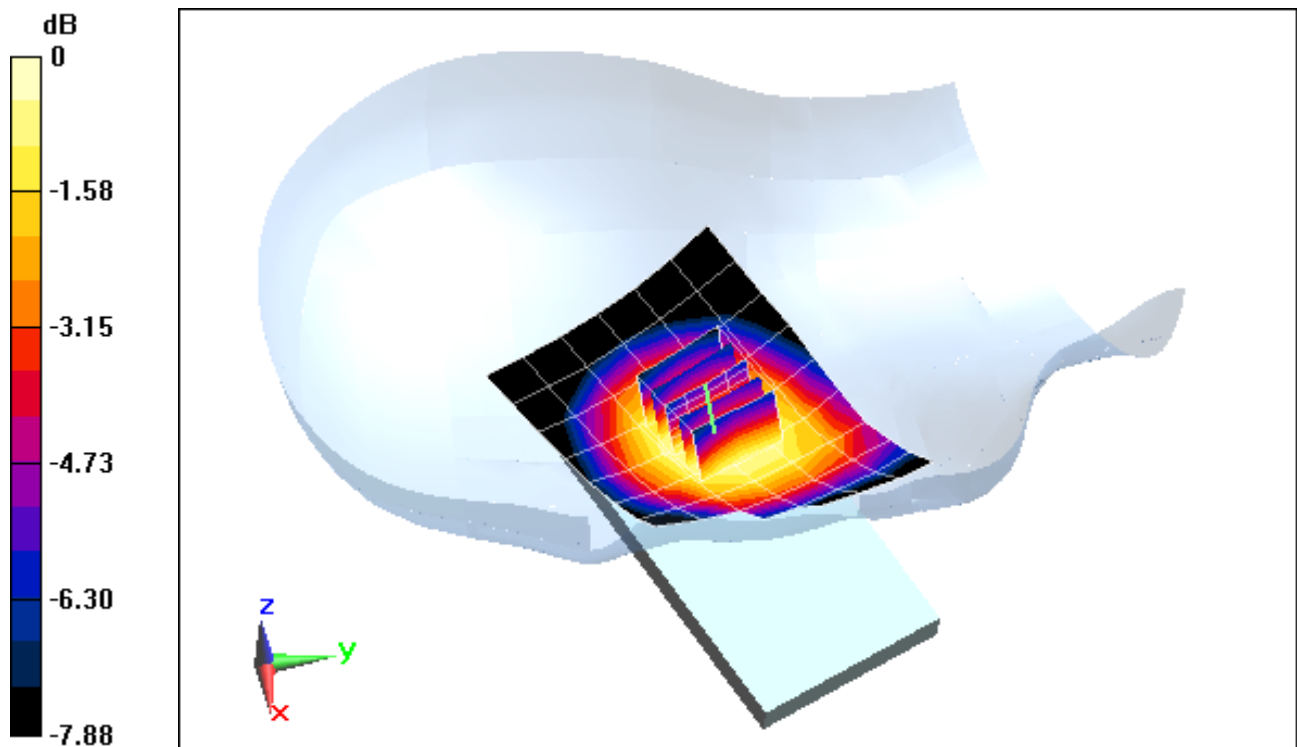

0 dB = 0.310mW/g = -10.17 dB mW/g

PCTEST ENGINEERING LABORATORY, INC.

DUT: TYK-EYC4287; Type: Portable Handset; Serial: KGM-U-004

Communication System: WCDMA850; Frequency: 836.6 MHz; Duty Cycle: 1:1

Medium: 835 Head Medium parameters used (interpolated):

$f = 836.6 \text{ MHz}$; $\sigma = 0.919 \text{ mho/m}$; $\epsilon_r = 40.695$; $\rho = 1000 \text{ kg/m}^3$

Phantom section: Left Section

Test Date: 07-26-2012; Ambient Temp: 24.2°C; Tissue Temp: 23.3°C

Probe: ES3DV3 - SN3258; ConvF(6.01, 6.01, 6.01); Calibrated: 2/21/2012

Sensor-Surface: 4mm (Mechanical Surface Detection)

Electronics: DAE4 Sn1272; Calibrated: 1/18/2012

Phantom: SAM Sub; Type: SAM 4.0; Serial: TP-1403

Measurement SW: DASY4, Version 4.7 (80); SEMCAD X Version 14.6.4 (4989)

Mode: WCDMA 850, Left Head, Cheek, Mid.ch

Area Scan (7x10x1): Measurement grid: dx=15mm, dy=15mm

Zoom Scan (5x5x7)/Cube 0: Measurement grid: dx=8mm, dy=8mm, dz=5mm

Reference Value = 23.665 V/m; Power Drift = -0.05 dB

Peak SAR (extrapolated) = 0.5740

SAR(1 g) = 0.471 mW/g; SAR(10 g) = 0.361 mW/g

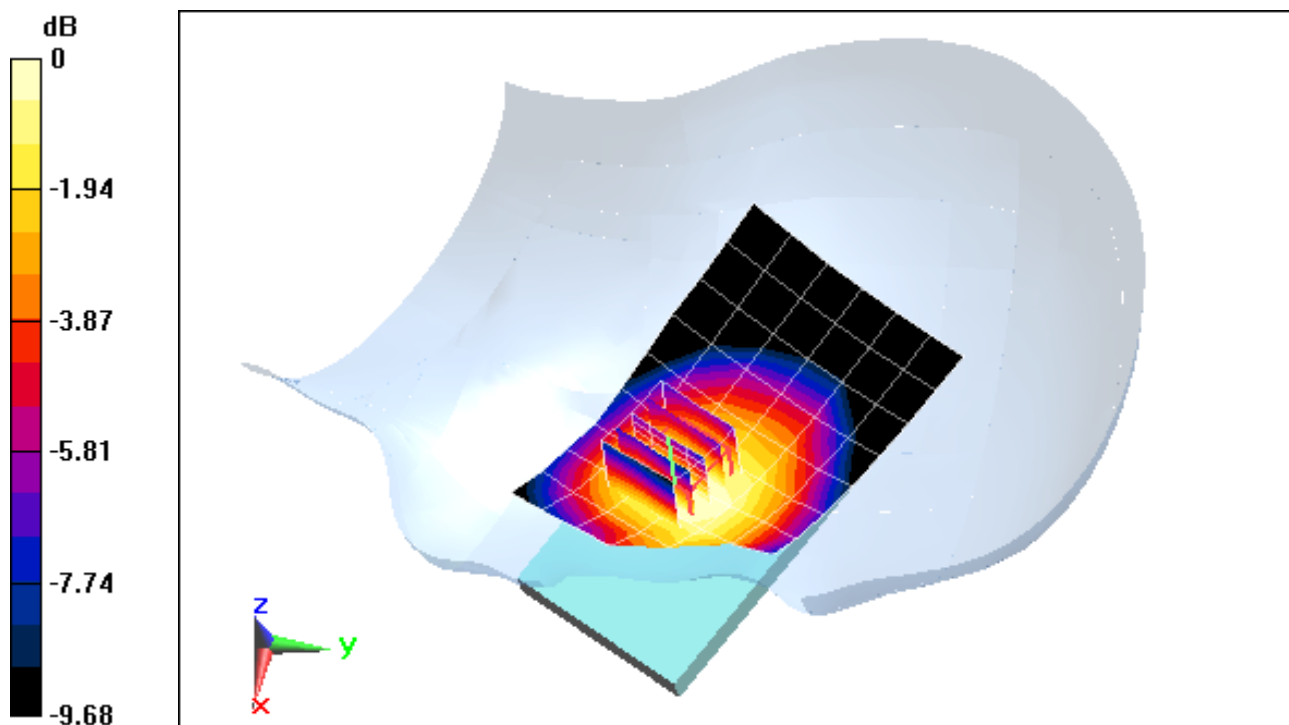

0 dB = 0.490mW/g = -6.20 dB mW/g

PCTEST ENGINEERING LABORATORY, INC.

DUT: TYK-EYC4287; Type: Portable Handset; Serial: KGM-U-004

Communication System: WCDMA850; Frequency: 836.6 MHz; Duty Cycle: 1:1

Medium: 835 Head Medium parameters used (interpolated):

$f = 836.6 \text{ MHz}$; $\sigma = 0.919 \text{ mho/m}$; $\epsilon_r = 40.695$; $\rho = 1000 \text{ kg/m}^3$

Phantom section: Left Section

Test Date: 07-26-2012; Ambient Temp: 24.2°C; Tissue Temp: 23.3°C

Probe: ES3DV3 - SN3258; ConvF(6.01, 6.01, 6.01); Calibrated: 2/21/2012

Sensor-Surface: 4mm (Mechanical Surface Detection)

Electronics: DAE4 Sn1272; Calibrated: 1/18/2012

Phantom: SAM Sub; Type: SAM 4.0; Serial: TP-1403

Measurement SW: DASY4, Version 4.7 (80); SEMCAD X Version 14.6.4 (4989)

Mode: WCDMA 850, Left Head, Tilt, Mid.ch

Area Scan (7x10x1): Measurement grid: dx=15mm, dy=15mm

Zoom Scan (5x5x7)/Cube 0: Measurement grid: dx=8mm, dy=8mm, dz=5mm

Reference Value = 17.761 V/m; Power Drift = -0.04 dB

Peak SAR (extrapolated) = 0.3310

SAR(1 g) = 0.275 mW/g; SAR(10 g) = 0.216 mW/g

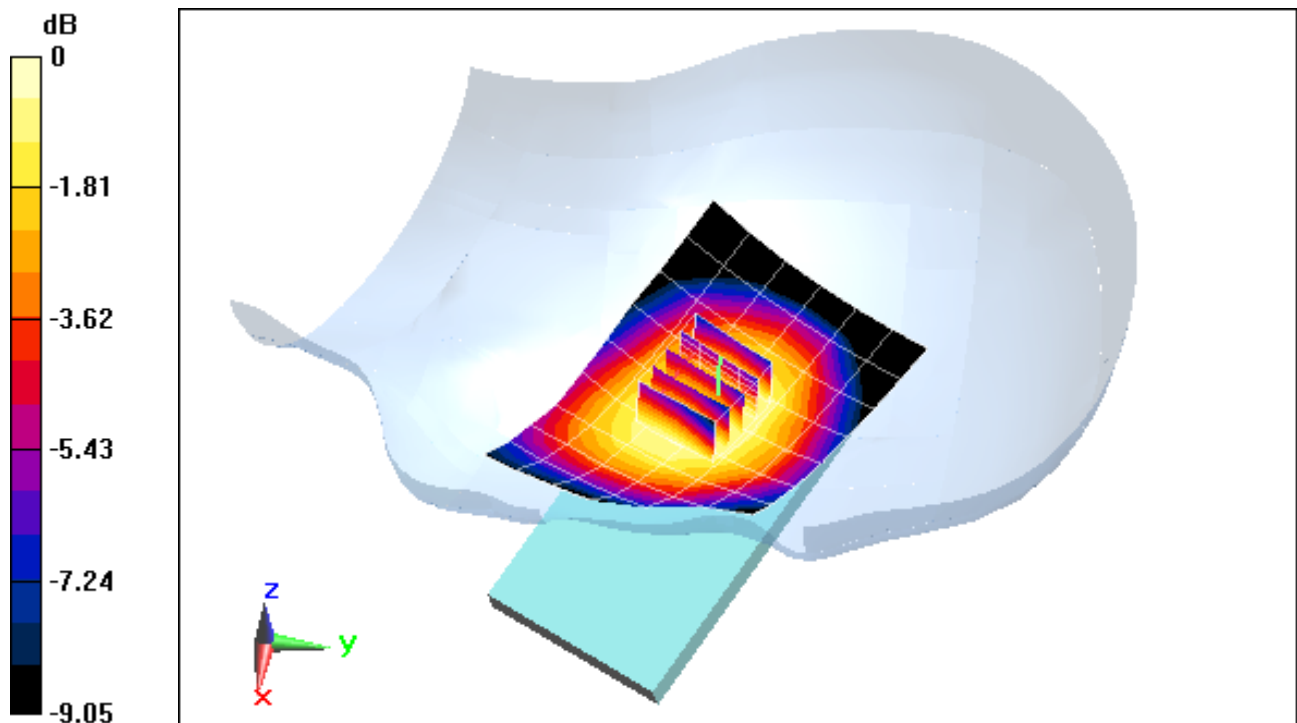

0 dB = 0.290mW/g = -10.75 dB mW/g

PCTEST ENGINEERING LABORATORY, INC.

DUT: TYK-EYC4287; Type: Portable Handset; Serial: KGM-U-004

Communication System: GSM; Frequency: 1850.2 MHz; Duty Cycle: 1.8.3

Medium: 1900 Head Medium parameters used (interpolated):

$f = 1850.2 \text{ MHz}$; $\sigma = 1.357 \text{ mho/m}$; $\epsilon_r = 38.601$; $\rho = 1000 \text{ kg/m}^3$

Phantom section: Right Section

Test Date: 07-30-2012; Ambient Temp: 21.1°C; Tissue Temp: 21.2°C

Probe: ES3DV3 - SN3287; ConvF(5.06, 5.06, 5.06); Calibrated: 2/7/2012

Sensor-Surface: 4mm (Mechanical Surface Detection)

Electronics: DAE4 Sn649; Calibrated: 2/20/2012

Phantom: SAM v5.0 Left; Type: QD000P40CD; Serial: TP: 1687

Measurement SW: DASY52, Version 52.8 (1); SEMCAD X Version 14.6.4 (4989)

Mode: GSM 1900, Right Head, Cheek, Low.ch

Area Scan (8x14x1): Measurement grid: dx=15mm, dy=15mm

Zoom Scan (5x5x7)/Cube 0: Measurement grid: dx=8mm, dy=8mm, dz=5mm

Reference Value = 30.366 V/m; Power Drift = 0.03 dB

Peak SAR (extrapolated) = 1.8980

SAR(1 g) = 1.19 mW/g; SAR(10 g) = 0.692 mW/g

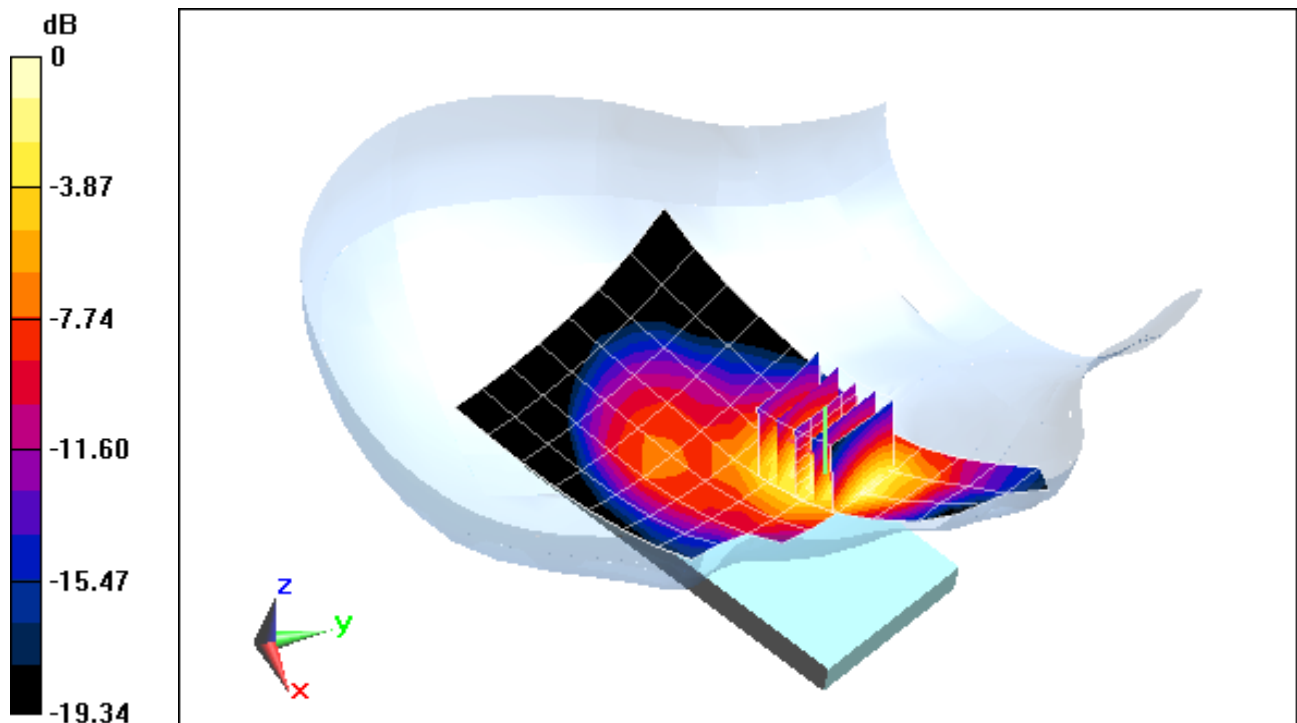

0 dB = 1.290mW/g = 2.21 dB mW/g

PCTEST ENGINEERING LABORATORY, INC.

DUT: TYK-EYC4287; Type: Portable Handset; Serial: KGM-U-004

Communication System: GSM; Frequency: 1850.2 MHz; Duty Cycle: 1.8.3

Medium: 1900 Head Medium parameters used (interpolated):

$f = 1850.2 \text{ MHz}$; $\sigma = 1.357 \text{ mho/m}$; $\epsilon_r = 38.601$; $\rho = 1000 \text{ kg/m}^3$

Phantom section: Right Section

Test Date: 07-30-2012; Ambient Temp: 21.1°C; Tissue Temp: 21.2°C

Probe: ES3DV3 - SN3287; ConvF(5.06, 5.06, 5.06); Calibrated: 2/7/2012

Sensor-Surface: 4mm (Mechanical Surface Detection)

Electronics: DAE4 Sn649; Calibrated: 2/20/2012

Phantom: SAM v5.0 Left; Type: QD000P40CD; Serial: TP: 1687

Measurement SW: DASY52, Version 52.8 (1); SEMCAD X Version 14.6.4 (4989)

Mode: GSM 1900, Right Head, Tilt, Low.ch

Area Scan (8x14x1): Measurement grid: dx=15mm, dy=15mm

Zoom Scan (5x5x7)/Cube 0: Measurement grid: dx=8mm, dy=8mm, dz=5mm

Reference Value = 13.772 V/m; Power Drift = 0.05 dB

Peak SAR (extrapolated) = 0.3970

SAR(1 g) = 0.258 mW/g; SAR(10 g) = 0.160 mW/g

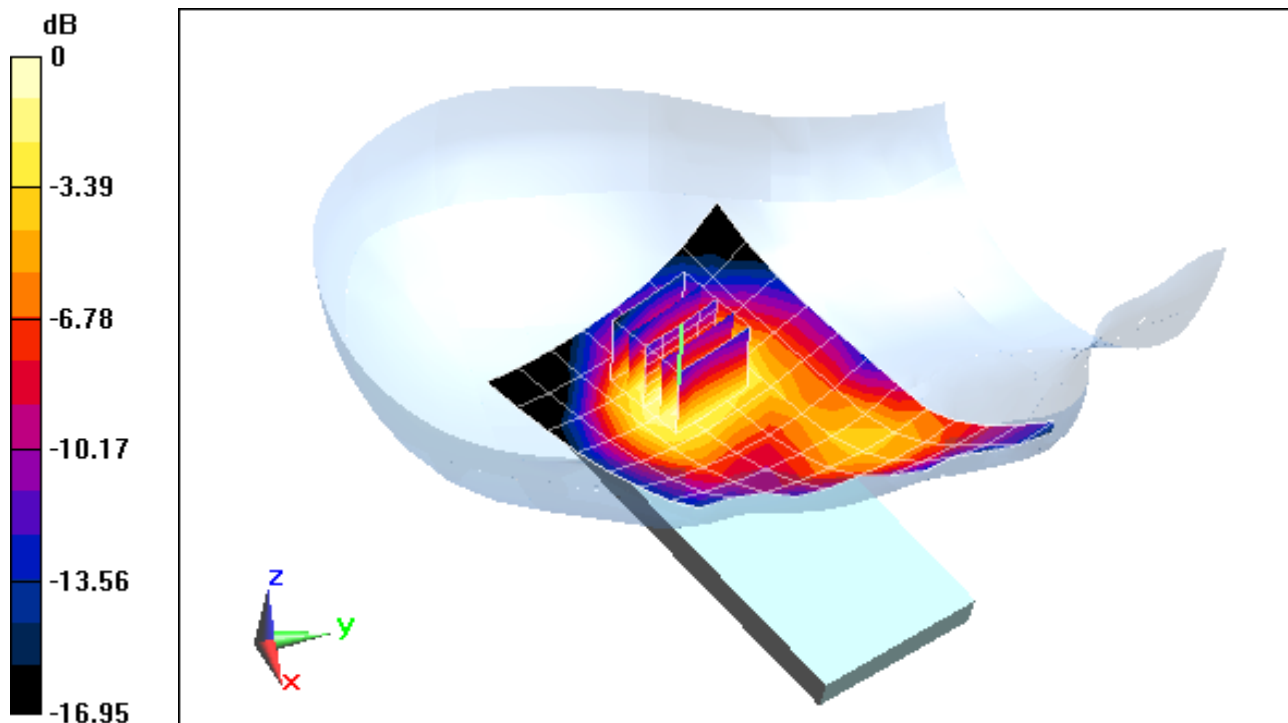

0 dB = 0.280mW/g = -11.06 dB mW/g

PCTEST ENGINEERING LABORATORY, INC.

DUT: TYK-EYC4287; Type: Portable Handset; Serial: KGM-U-004

Communication System: GSM; Frequency: 1850.2 MHz; Duty Cycle: 1.8.3

Medium: 1900 Head Medium parameters used (interpolated):

$f = 1850.2 \text{ MHz}$; $\sigma = 1.357 \text{ mho/m}$; $\epsilon_r = 38.601$; $\rho = 1000 \text{ kg/m}^3$

Phantom section: Left Section

Test Date: 07-30-2012; Ambient Temp: 21.1°C; Tissue Temp: 21.2°C

Probe: ES3DV3 - SN3287; ConvF(5.06, 5.06, 5.06); Calibrated: 2/7/2012

Sensor-Surface: 4mm (Mechanical Surface Detection)

Electronics: DAE4 Sn649; Calibrated: 2/20/2012

Phantom: SAM v5.0 Left; Type: QD000P40CD; Serial: TP: 1687

Measurement SW: DASY52, Version 52.8 (1); SEMCAD X Version 14.6.4 (4989)

Mode: GSM 1900, Left Head, Cheek, Low.ch

Area Scan (8x14x1): Measurement grid: dx=15mm, dy=15mm

Zoom Scan (5x5x7)/Cube 0: Measurement grid: dx=8mm, dy=8mm, dz=5mm

Reference Value = 20.660 V/m; Power Drift = -0.06 dB

Peak SAR (extrapolated) = 0.8030

SAR(1 g) = 0.534 mW/g; SAR(10 g) = 0.339 mW/g

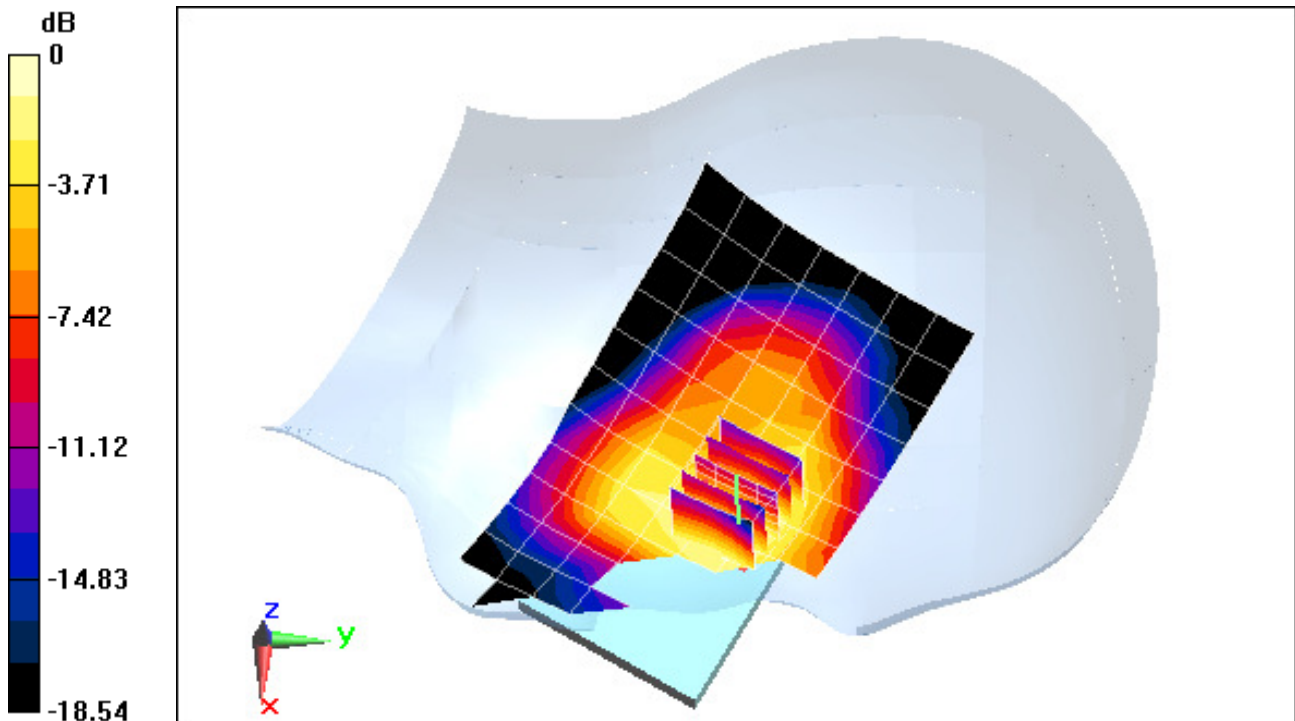

0 dB = 0.580mW/g = -4.73 dB mW/g

PCTEST ENGINEERING LABORATORY, INC.

DUT: TYK-EYC4287; Type: Portable Handset; Serial: KGM-U-004

Communication System: GSM; Frequency: 1850.2 MHz; Duty Cycle: 1.8.3

Medium: 1900 Head Medium parameters used (interpolated):

$f = 1850.2 \text{ MHz}$; $\sigma = 1.357 \text{ mho/m}$; $\epsilon_r = 38.601$; $\rho = 1000 \text{ kg/m}^3$

Phantom section: Left Section

Test Date: 07-30-2012; Ambient Temp: 21.1°C; Tissue Temp: 21.2°C

Probe: ES3DV3 - SN3287; ConvF(5.06, 5.06, 5.06); Calibrated: 2/7/2012

Sensor-Surface: 4mm (Mechanical Surface Detection)

Electronics: DAE4 Sn649; Calibrated: 2/20/2012

Phantom: SAM v5.0 Left; Type: QD000P40CD; Serial: TP: 1687

Measurement SW: DASY52, Version 52.8 (1); SEMCAD X Version 14.6.4 (4989)

"Mode: GSM 1900, Left Head, V_{kv}, Low.ch

Area Scan (8x14x1): Measurement grid: dx=15mm, dy=15mm

Zoom Scan (5x5x7)/Cube 0: Measurement grid: dx=8mm, dy=8mm, dz=5mm

Reference Value = 20.830 V/m; Power Drift = -0.01 dB

Peak SAR (extrapolated) = 0.8030

SAR(1 g) = 0.267 mW/g; SAR(10 g) = 0.164 mW/g

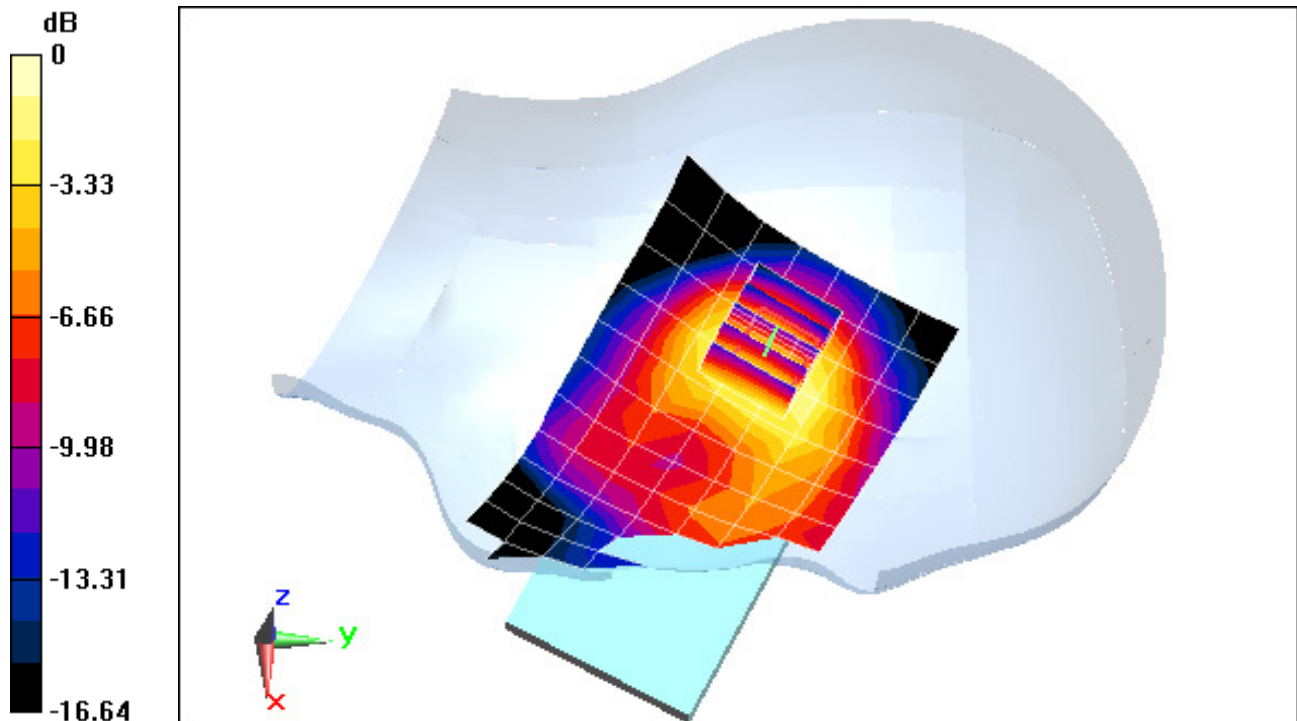

0 dB = 0.290mW/g = -10.75 dB mW/g

PCTEST ENGINEERING LABORATORY, INC.

DUT: TYK-EYC4287; Type: Portable Handset; Serial: KGM-U-002

Communication System: IEEE 802.11b; Frequency: 2412 MHz; Duty Cycle: 1:1

Medium: 2450 Head Medium parameters used (interpolated):

$f = 2412 \text{ MHz}$; $\sigma = 1.814 \text{ mho/m}$; $\epsilon_r = 37.984$; $\rho = 1000 \text{ kg/m}^3$

Phantom section: Right Section

Test Date: 08-01-2012; Ambient Temp: 22.3°C; Tissue Temp: 23.1°C

Probe: ES3DV2 - SN3022; ConvF(4.3, 4.3, 4.3); Calibrated: 8/25/2011

Sensor-Surface: 3mm (Mechanical Surface Detection)

Electronics: DAE4 Sn665; Calibrated: 4/19/2012

Phantom: SAM with CRP; Type: SAM; Serial: TP1375

Measurement SW: DASY4, Version 4.7 (80); SEMCAD X Version 14.6.4 (4989)

Mode: IEEE 802.11b, Right Head, Cheek, Ch 01, 1 Mbps

Area Scan (10x17x1): Measurement grid: dx=12mm, dy=12mm

Zoom Scan (7x7x7)/Cube 0: Measurement grid: dx=5mm, dy=5mm, dz=5mm

Reference Value = 10.361 V/m; Power Drift = -0.01 dB

Peak SAR (extrapolated) = 0.3060

SAR(1 g) = 0.177 mW/g; SAR(10 g) = 0.106 mW/g

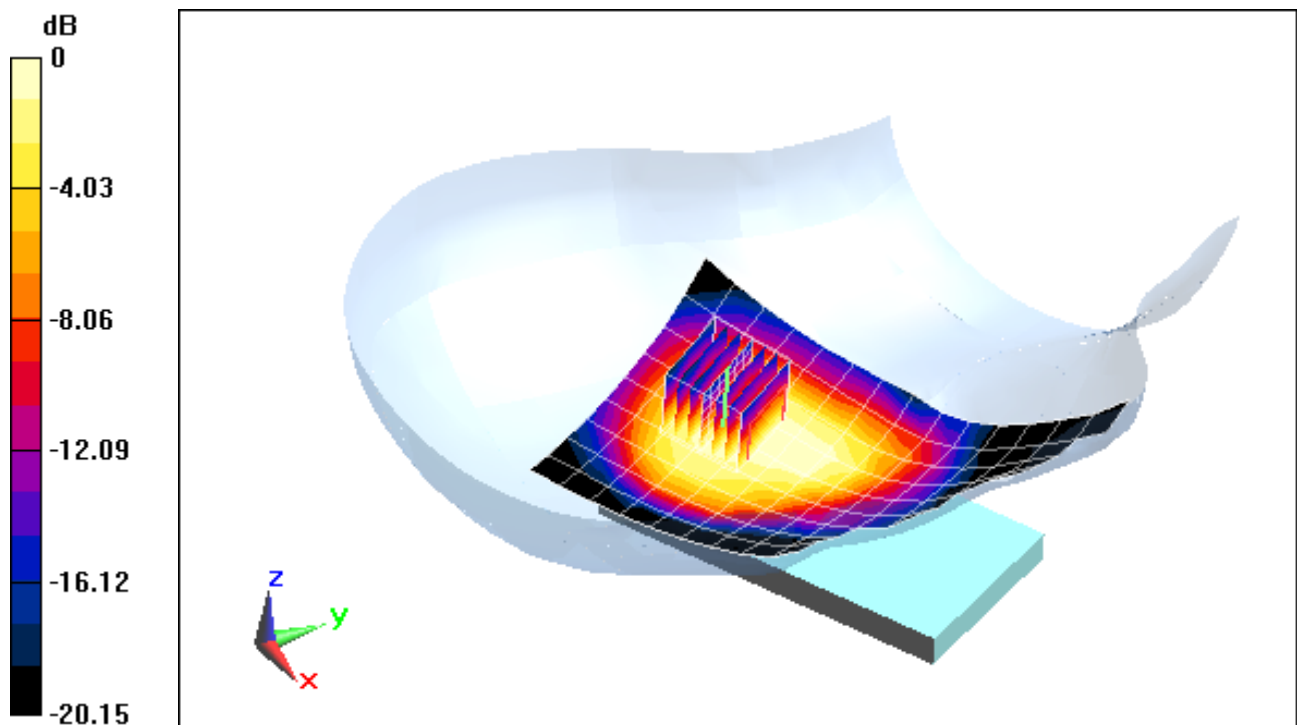

0 dB = 0.210mW/g = -13.56 dB mW/g

PCTEST ENGINEERING LABORATORY, INC.

DUT: TYK-EYC4287; Type: Portable Handset; Serial: KGM-U-002

Communication System: IEEE 802.11b; Frequency: 2412 MHz; Duty Cycle: 1:1

Medium: 2450 Head Medium parameters used (interpolated):

$f = 2412 \text{ MHz}$; $\sigma = 1.814 \text{ mho/m}$; $\epsilon_r = 37.984$; $\rho = 1000 \text{ kg/m}^3$

Phantom section: Right Section

Test Date: 08-01-2012; Ambient Temp: 22.3°C; Tissue Temp: 23.1°C

Probe: ES3DV2 - SN3022; ConvF(4.3, 4.3, 4.3); Calibrated: 8/25/2011

Sensor-Surface: 3mm (Mechanical Surface Detection)

Electronics: DAE4 Sn665; Calibrated: 4/19/2012

Phantom: SAM with CRP; Type: SAM; Serial: TP1375

Measurement SW: DASY4, Version 4.7 (80); SEMCAD X Version 14.6.4 (4989)

Mode: IEEE 802.11b, Right Head, Tilt, Ch 01, 1 Mbps

Area Scan (10x17x1): Measurement grid: dx=12mm, dy=12mm

Zoom Scan (7x7x7)/Cube 0: Measurement grid: dx=5mm, dy=5mm, dz=5mm

Reference Value = 8.499 V/m; Power Drift = 0.01 dB

Peak SAR (extrapolated) = 0.2210

SAR(1 g) = 0.122 mW/g; SAR(10 g) = 0.068 mW/g

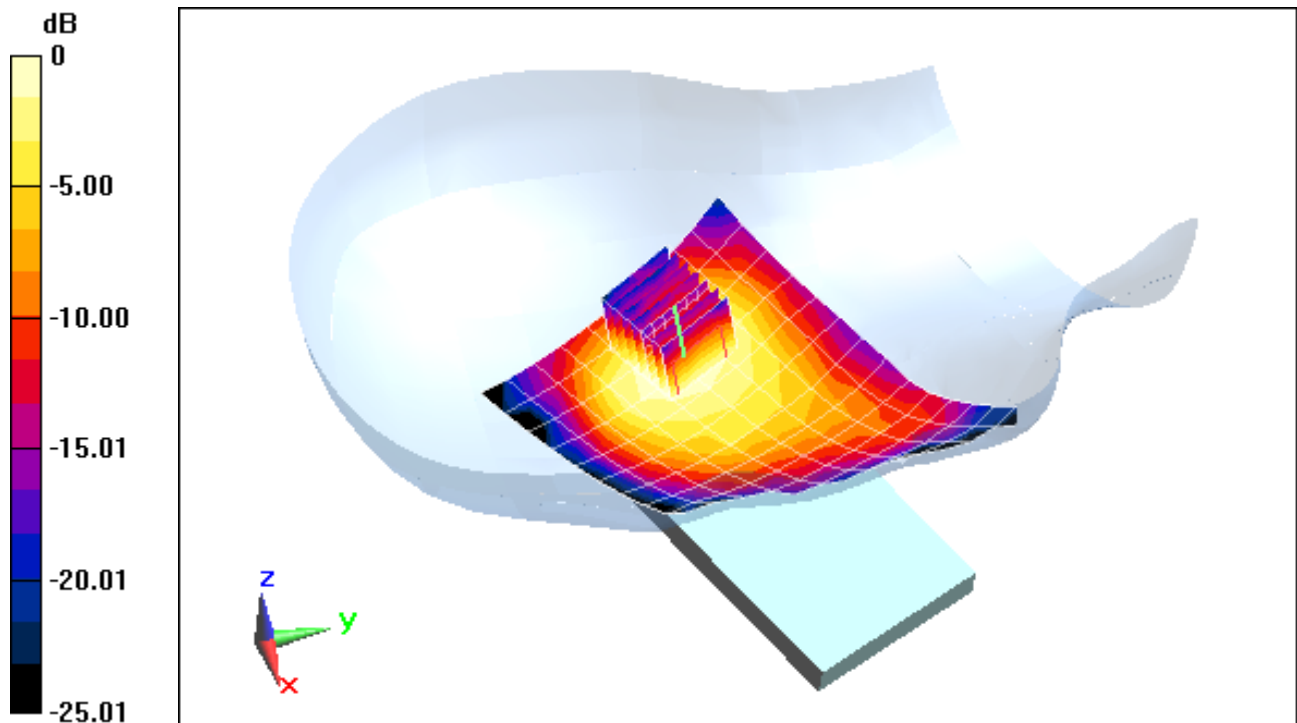

0 dB = 0.150mW/g = -16.48 dB mW/g

PCTEST ENGINEERING LABORATORY, INC.

DUT: TYK-EYC4287; Type: Portable Handset; Serial: KGM-U-002

Communication System: IEEE 802.11b; Frequency: 2412 MHz; Duty Cycle: 1:1

Medium: 2450 Head Medium parameters used (interpolated):

$f = 2412 \text{ MHz}$; $\sigma = 1.814 \text{ mho/m}$; $\epsilon_r = 37.984$; $\rho = 1000 \text{ kg/m}^3$

Phantom section: Left Section

Test Date: 08-01-2012; Ambient Temp: 22.3°C; Tissue Temp: 23.1°C

Probe: ES3DV2 - SN3022; ConvF(4.3, 4.3, 4.3); Calibrated: 8/25/2011

Sensor-Surface: 3mm (Mechanical Surface Detection)

Electronics: DAE4 Sn665; Calibrated: 4/19/2012

Phantom: SAM with CRP; Type: SAM; Serial: TP1375

Measurement SW: DASY4, Version 4.7 (80); SEMCAD X Version 14.6.4 (4989)

Mode: IEEE 802.11b, Left Head, Cheek, Ch 01, 1 Mbps

Area Scan (10x15x1): Measurement grid: $dx=12\text{mm}$, $dy=12\text{mm}$

Zoom Scan (7x7x7)/Cube 0: Measurement grid: $dx=5\text{mm}$, $dy=5\text{mm}$, $dz=5\text{mm}$

Reference Value = 14.928 V/m; Power Drift = 0.12 dB

Peak SAR (extrapolated) = 0.6330

SAR(1 g) = 0.355 mW/g; SAR(10 g) = 0.187 mW/g

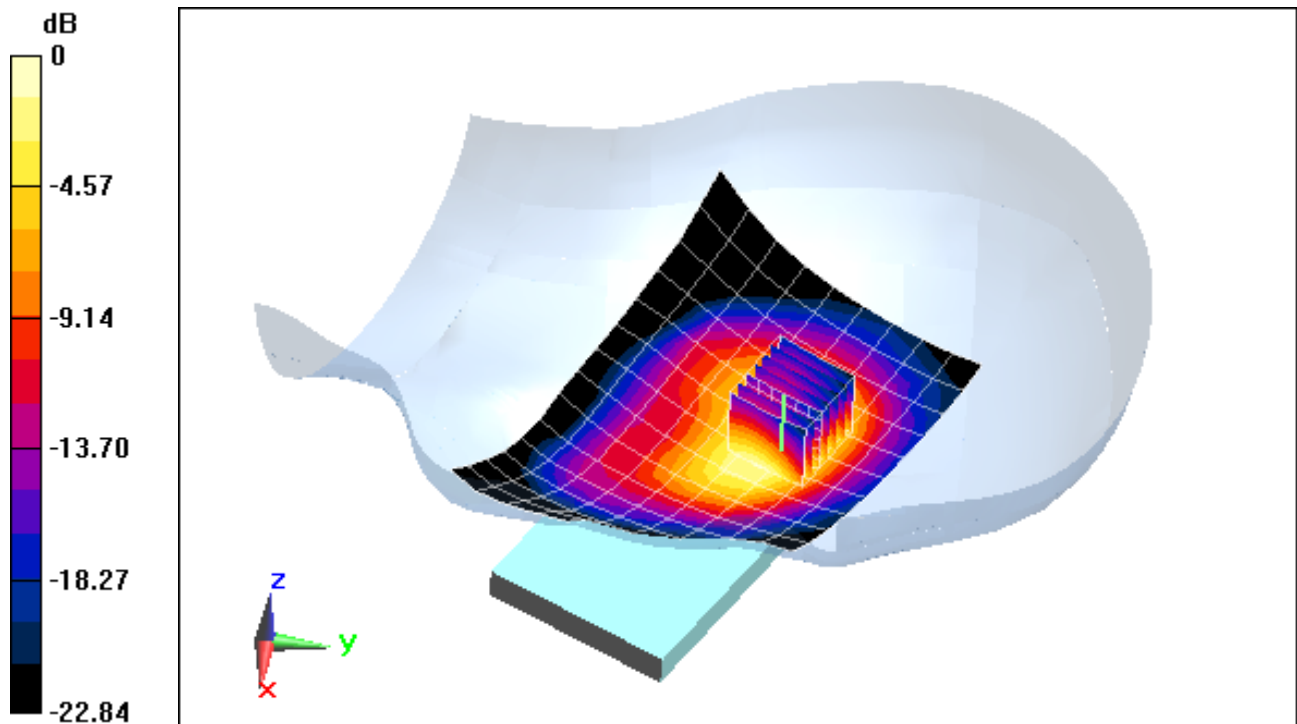

0 dB = 0.440mW/g = -7.13 dB mW/g

PCTEST ENGINEERING LABORATORY, INC.

DUT: TYK-EYC4287; Type: Portable Handset; Serial: KGM-U-002

Communication System: IEEE 802.11b; Frequency: 2412 MHz; Duty Cycle: 1:1

Medium: 2450 Head Medium parameters used (interpolated):

$f = 2412 \text{ MHz}$; $\sigma = 1.814 \text{ mho/m}$; $\epsilon_r = 37.984$; $\rho = 1000 \text{ kg/m}^3$

Phantom section: Left Section

Test Date: 08-01-2012; Ambient Temp: 22.3°C; Tissue Temp: 23.1°C

Probe: ES3DV2 - SN3022; ConvF(4.3, 4.3, 4.3); Calibrated: 8/25/2011

Sensor-Surface: 3mm (Mechanical Surface Detection)

Electronics: DAE4 Sn665; Calibrated: 4/19/2012

Phantom: SAM with CRP; Type: SAM; Serial: TP1375

Measurement SW: DASY4, Version 4.7 (80); SEMCAD X Version 14.6.4 (4989)

Mode: IEEE 802.11b, Left Head, Tilt, Ch 01, 1 Mbps

Area Scan (10x15x1): Measurement grid: dx=12mm, dy=12mm

Zoom Scan (7x7x7)/Cube 0: Measurement grid: dx=5mm, dy=5mm, dz=5mm

Reference Value = 9.765 V/m; Power Drift = -0.04 dB

Peak SAR (extrapolated) = 0.2920

SAR(1 g) = 0.152 mW/g; SAR(10 g) = 0.083 mW/g

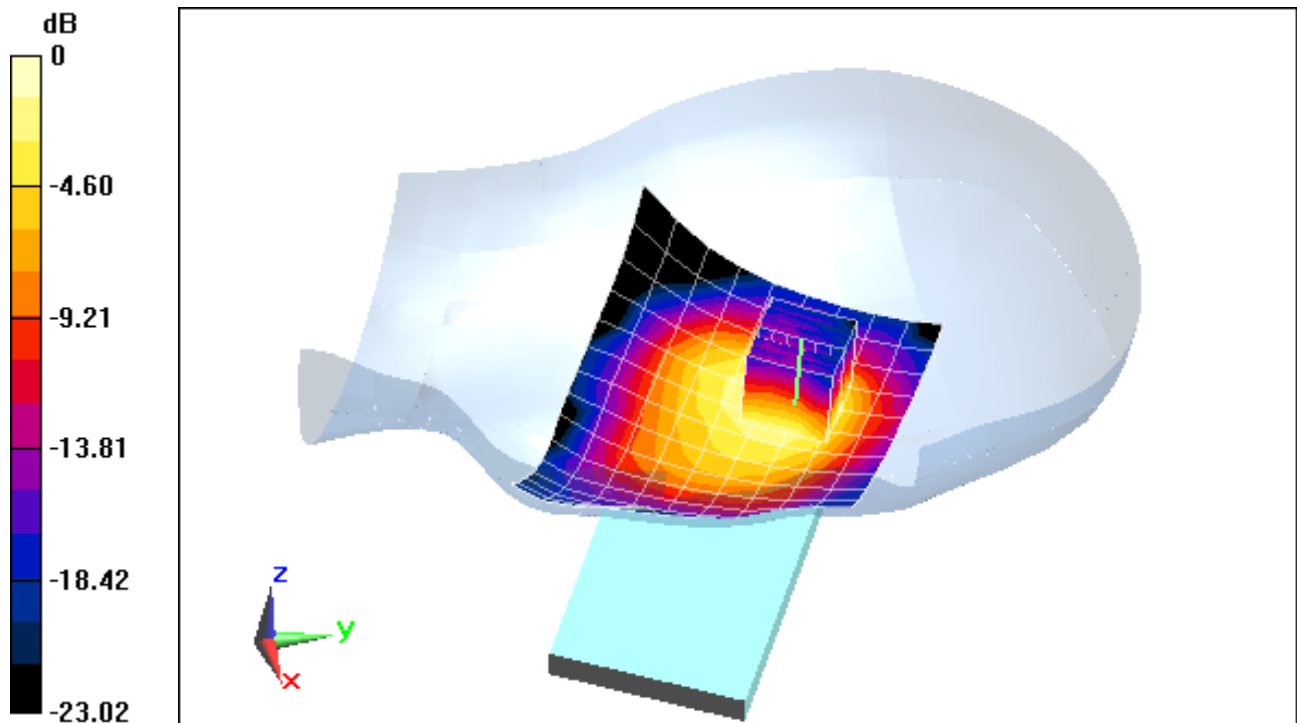

0 dB = 0.190mW/g = -14.42 dB mW/g

PCTEST ENGINEERING LABORATORY, INC.

DUT: TYK-EYC4287; Type: Portable Handset; Serial: KGM-U-004

Communication System: Cellular CDMA; Frequency: 836.52 MHz; Duty Cycle: 1:1

Medium: 835 Body Medium parameters used (interpolated):

$f = 836.52 \text{ MHz}$; $\sigma = 0.972 \text{ mho/m}$; $\epsilon_r = 54.858$; $\rho = 1000 \text{ kg/m}^3$

Phantom section: Flat Section; Space: 1.0 cm

Test Date: 07-30-2012; Ambient Temp: 24.1°C; Tissue Temp: 23.4°C

Probe: ES3DV3 - SN3258; ConvF(6.06, 6.06, 6.06); Calibrated: 2/21/2012

Sensor-Surface: 4mm (Mechanical Surface Detection)

Electronics: DAE4 Sn1272; Calibrated: 1/18/2012

Phantom: SAM Main; Type: SAM 4.0; Serial: TP-1406

Measurement SW: DASY4, Version 4.7 (80); SEMCAD X Version 14.6.4 (4989)

Mode: Cellular TDS032, Body SAR, Back side, Mid.ch

Area Scan (7x12x1): Measurement grid: dx=15mm, dy=15mm

Zoom Scan (5x5x7)/Cube 0: Measurement grid: dx=8mm, dy=8mm, dz=5mm

Reference Value = 30.887 V/m; Power Drift = -0.02 dB

Peak SAR (extrapolated) = 1.1730

SAR(1 g) = 0.747 mW/g; SAR(10 g) = 0.493 mW/g

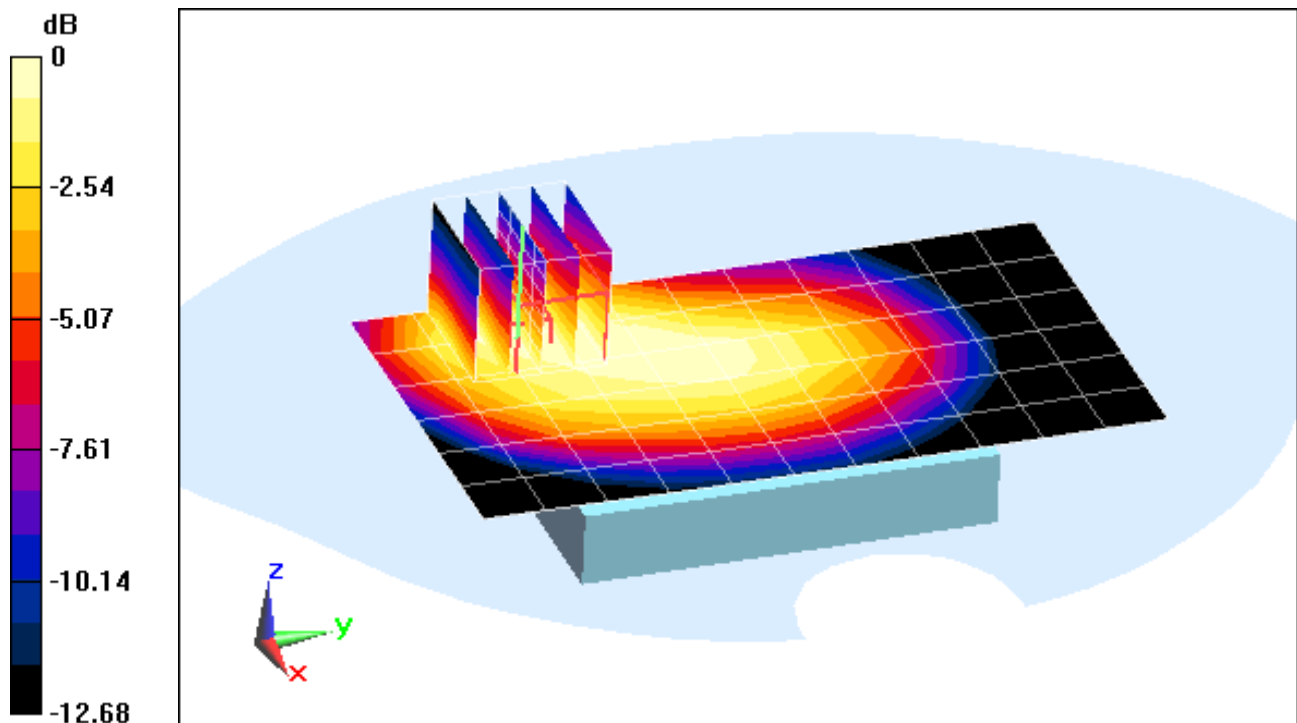

0 dB = 0.800mW/g = -1.94 dB mW/g

PCTEST ENGINEERING LABORATORY, INC.

DUT: TYK-EYC4287; Type: Portable Handset; Serial: KGM-U-004

Communication System: Cellular CDMA; Frequency: 836.52 MHz; Duty Cycle: 1:1

Medium: 835 Body Medium parameters used (interpolated):

$f = 836.52 \text{ MHz}$; $\sigma = 0.972 \text{ mho/m}$; $\epsilon_r = 54.858$; $\rho = 1000 \text{ kg/m}^3$

Phantom section: Flat Section; Space: 1.0 cm

Test Date: 07-30-2012; Ambient Temp: 24.1°C; Tissue Temp: 23.4°C

Probe: ES3DV3 - SN3258; ConvF(6.06, 6.06, 6.06); Calibrated: 2/21/2012

Sensor-Surface: 4mm (Mechanical Surface Detection)

Electronics: DAE4 Sn1272; Calibrated: 1/18/2012

Phantom: SAM Main; Type: SAM 4.0; Serial: TP-1406

Measurement SW: DASY4, Version 4.7 (80); SEMCAD X Version 14.6.4 (4989)

Mode: Cellular TDSO32, Body SAR, Front side, Mid.ch

Area Scan (7x12x1): Measurement grid: dx=15mm, dy=15mm

Zoom Scan (5x5x7)/Cube 0: Measurement grid: dx=8mm, dy=8mm, dz=5mm

Reference Value = 30.718 V/m; Power Drift = 0.03 dB

Peak SAR (extrapolated) = 1.0190

SAR(1 g) = 0.770 mW/g; SAR(10 g) = 0.574 mW/g

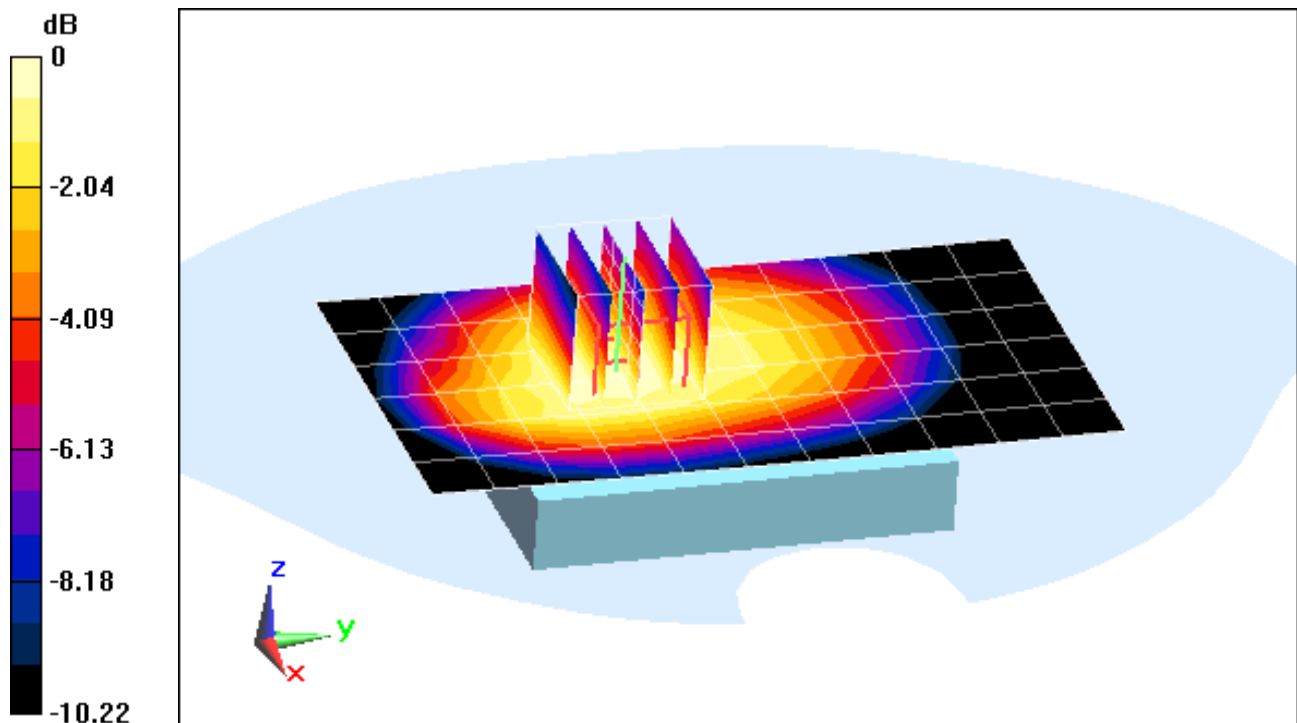

0 dB = 0.810mW/g = -1.83 dB mW/g

PCTEST ENGINEERING LABORATORY, INC.

DUT: TYK-EYC4287; Type: Portable Handset; Serial: KGM-U-004

Communication System: Cellular CDMA; Frequency: 836.52 MHz; Duty Cycle: 1:1

Medium: 835 Body Medium parameters used (interpolated):

$f = 836.52 \text{ MHz}$; $\sigma = 0.972 \text{ mho/m}$; $\epsilon_r = 54.858$; $\rho = 1000 \text{ kg/m}^3$

Phantom section: Flat Section; Space: 1.0 cm

Test Date: 07-30-2012; Ambient Temp: 24.1°C; Tissue Temp: 23.4°C

Probe: ES3DV3 - SN3258; ConvF(6.06, 6.06, 6.06); Calibrated: 2/21/2012

Sensor-Surface: 4mm (Mechanical Surface Detection)

Electronics: DAE4 Sn1272; Calibrated: 1/18/2012

Phantom: SAM Main; Type: SAM 4.0; Serial: TP-1406

Measurement SW: DASY4, Version 4.7 (80); SEMCAD X Version 14.6.4 (4989)

Mode: Cellular TDSO32, Body SAR, Bottom Edge, Mid.ch

Area Scan (9x7x1): Measurement grid: dx=5mm, dy=15mm

Zoom Scan (5x5x7)/Cube 0: Measurement grid: dx=8mm, dy=8mm, dz=5mm

Reference Value = 13.308 V/m; Power Drift = 0.06 dB

Peak SAR (extrapolated) = 0.2110

SAR(1 g) = 0.132 mW/g; SAR(10 g) = 0.084 mW/g

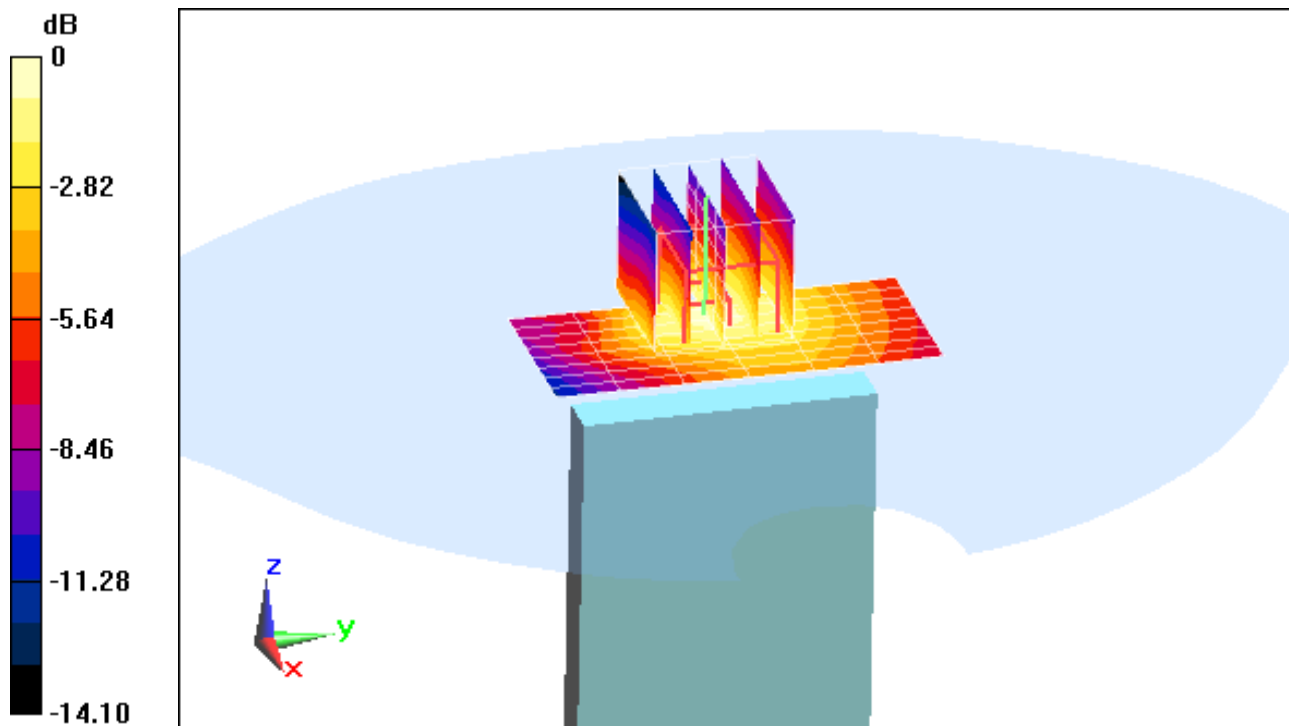

0 dB = 0.150mW/g = -16.48 dB mW/g

PCTEST ENGINEERING LABORATORY, INC.

DUT: TYK-EYC4287; Type: Portable Handset; Serial: KGM-U-004

Communication System: Cellular CDMA; Frequency: 836.52 MHz; Duty Cycle: 1:1

Medium: 835 Body Medium parameters used (interpolated):

$f = 836.52 \text{ MHz}$; $\sigma = 0.972 \text{ mho/m}$; $\epsilon_r = 54.858$; $\rho = 1000 \text{ kg/m}^3$

Phantom section: Flat Section; Space: 1.0 cm

Test Date: 07-30-2012; Ambient Temp: 24.1°C; Tissue Temp: 23.4°C

Probe: ES3DV3 - SN3258; ConvF(6.06, 6.06, 6.06); Calibrated: 2/21/2012

Sensor-Surface: 4mm (Mechanical Surface Detection)

Electronics: DAE4 Sn1272; Calibrated: 1/18/2012

Phantom: SAM Main; Type: SAM 4.0; Serial: TP-1406

Measurement SW: DASY4, Version 4.7 (80); SEMCAD X Version 14.6.4 (4989)

Mode: Cellular TDSO32, Body SAR, Right Edge, Mid.ch

Area Scan (9x14x1): Measurement grid: dx=5mm, dy=15mm

Zoom Scan (5x5x7)/Cube 0: Measurement grid: dx=8mm, dy=8mm, dz=5mm

Reference Value = 25.032 V/m; Power Drift = -0.07 dB

Peak SAR (extrapolated) = 0.6990

SAR(1 g) = 0.502 mW/g; SAR(10 g) = 0.344 mW/g

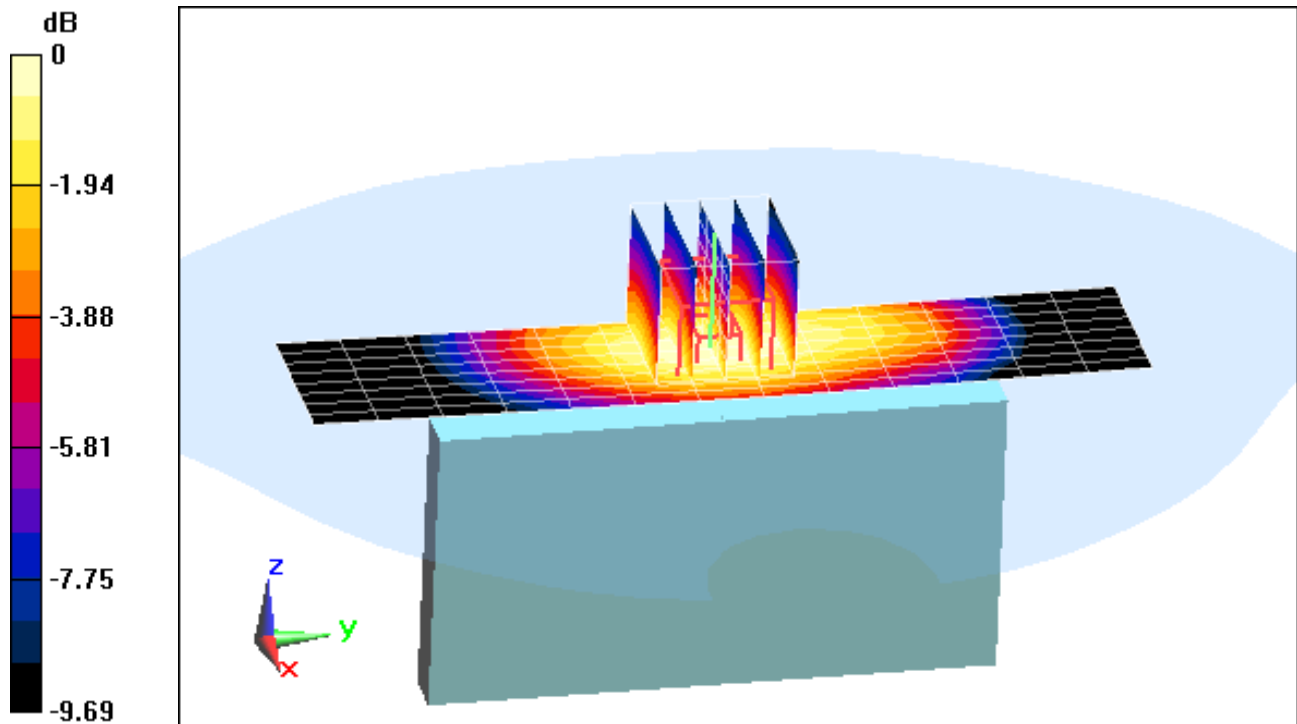

0 dB = 0.540mW/g = -5.35 dB mW/g

PCTEST ENGINEERING LABORATORY, INC.

DUT: TYK-EYC4287; Type: Portable Handset; Serial: KGM-U-004

Communication System: GSM850 GPRS; 1 Tx slots; Frequency: 836.6 MHz; Duty Cycle: 1:8.3

Medium: 835 Body Medium parameters used (interpolated):

$f = 836.6 \text{ MHz}$; $\sigma = 0.979 \text{ mho/m}$; $\epsilon_r = 55.323$; $\rho = 1000 \text{ kg/m}^3$

Phantom section: Flat Section; Space: 1.0 cm

Test Date: 07-27-2012; Ambient Temp: 24.4°C; Tissue Temp: 23.8°C

Probe: ES3DV3 - SN3258; ConvF(6.06, 6.06, 6.06); Calibrated: 2/21/2012

Sensor-Surface: 4mm (Mechanical Surface Detection)

Electronics: DAE4 Sn1272; Calibrated: 1/18/2012

Phantom: SAM Main; Type: SAM 4.0; Serial: TP-1406

Measurement SW: DASY4, Version 4.7 (80); SEMCAD X Version 14.6.4 (4989)

Mode: GPRS 850, Body SAR, Back side, Mid.ch, 1 Tx Slots

Area Scan (7x12x1): Measurement grid: dx=15mm, dy=15mm

Zoom Scan (5x5x7)/Cube 0: Measurement grid: dx=8mm, dy=8mm, dz=5mm

Reference Value = 30.895 V/m; Power Drift = -0.06 dB

Peak SAR (extrapolated) = 1.1130

SAR(1 g) = 0.861 mW/g; SAR(10 g) = 0.636 mW/g

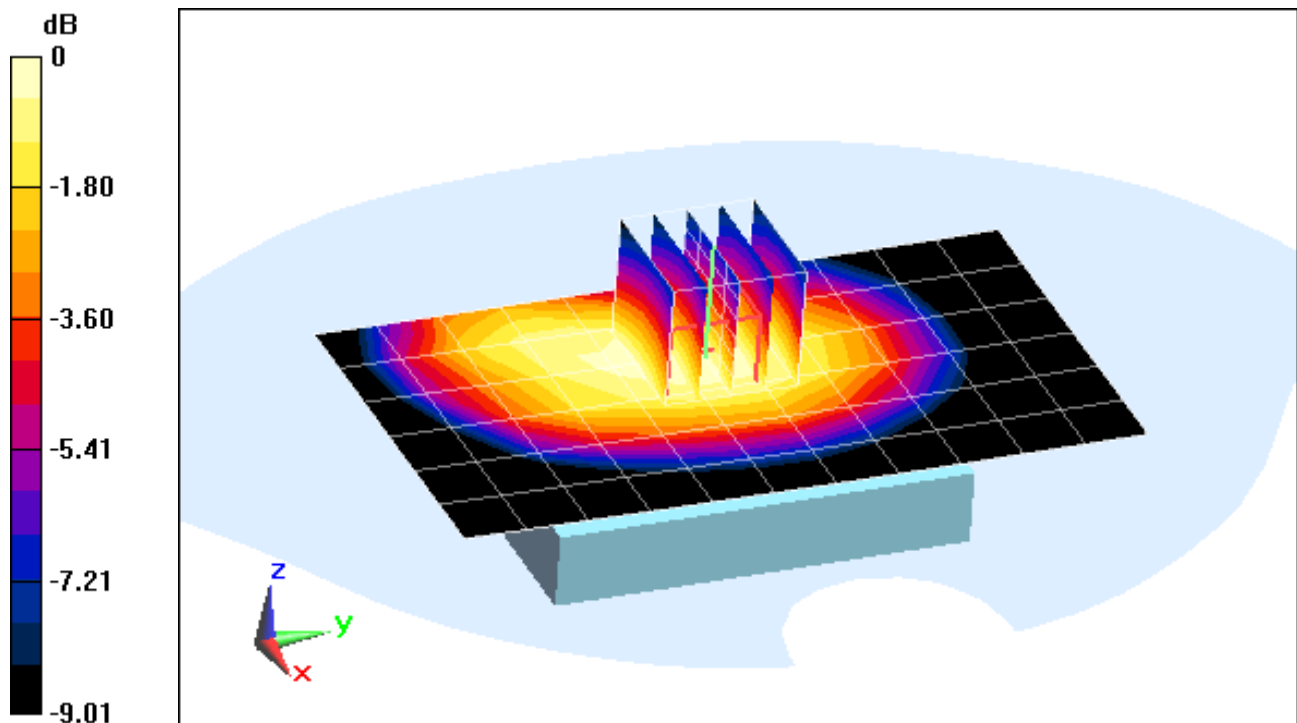

0 dB = 0.860mW/g = -1.31 dB mW/g

PCTEST ENGINEERING LABORATORY, INC.

DUT: TYK-EYC4287; Type: Portable Handset; Serial: KGM-U-004

Communication System: GSM850 GPRS; 1 Tx slots; Frequency: 848.8 MHz; Duty Cycle: 1:8.3

Medium: 835 Body Medium parameters used (interpolated):

$f = 848.8 \text{ MHz}$; $\sigma = 0.991 \text{ mho/m}$; $\epsilon_r = 55.193$; $\rho = 1000 \text{ kg/m}^3$

Phantom section: Flat Section; Space: 1.0 cm

Test Date: 07-27-2012; Ambient Temp: 24.4°C; Tissue Temp: 23.8°C

Probe: ES3DV3 - SN3258; ConvF(6.06, 6.06, 6.06); Calibrated: 2/21/2012

Sensor-Surface: 4mm (Mechanical Surface Detection)

Electronics: DAE4 Sn1272; Calibrated: 1/18/2012

Phantom: SAM Main; Type: SAM 4.0; Serial: TP-1406

Measurement SW: DASY4, Version 4.7 (80); SEMCAD X Version 14.6.4 (4989)

Mode: GPRS 850, Body SAR, Front side, J k j .ch, 1 Tx Slots

Area Scan (7x12x1): Measurement grid: dx=15mm, dy=15mm

Zoom Scan (5x5x7)/Cube 0: Measurement grid: dx=8mm, dy=8mm, dz=5mm

Reference Value = 30.425 V/m; Power Drift = -0.03 dB

Peak SAR (extrapolated) = 1.1200

SAR(1 g) = 0.854 mW/g; SAR(10 g) = 0.641 mW/g

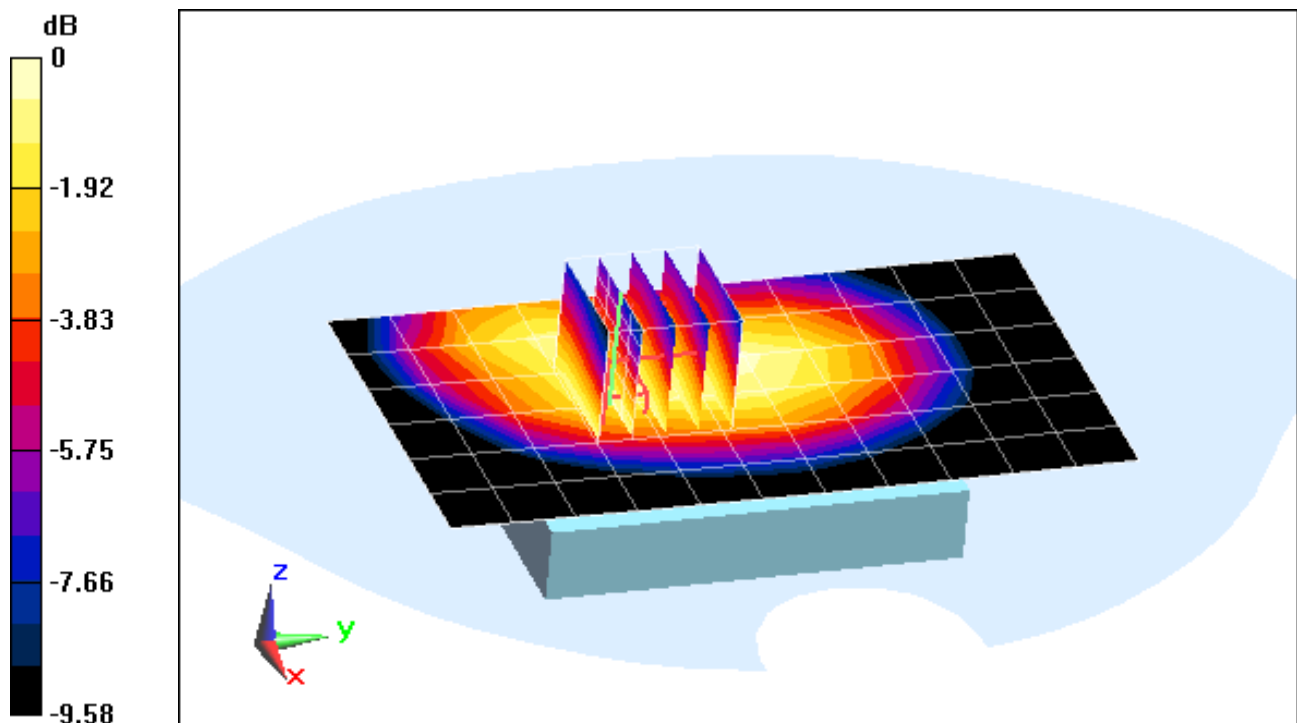

0 dB = 0.900mW/g = -0.92 dB mW/g

PCTEST ENGINEERING LABORATORY, INC.

DUT: TYK-EYC4287; Type: Portable Handset; Serial: KGM-U-004

Communication System: GSM850 GPRS; 1 Tx slots; Frequency: 836.6 MHz; Duty Cycle: 1:8.3

Medium: 835 Body Medium parameters used (interpolated):

$f = 836.6 \text{ MHz}$; $\sigma = 0.979 \text{ mho/m}$; $\epsilon_r = 55.323$; $\rho = 1000 \text{ kg/m}^3$

Phantom section: Flat Section; Space: 1.0 cm

Test Date: 07-27-2012; Ambient Temp: 24.4°C; Tissue Temp: 23.8°C

Probe: ES3DV3 - SN3258; ConvF(6.06, 6.06, 6.06); Calibrated: 2/21/2012

Sensor-Surface: 4mm (Mechanical Surface Detection)

Electronics: DAE4 Sn1272; Calibrated: 1/18/2012

Phantom: SAM Main; Type: SAM 4.0; Serial: TP-1406

Measurement SW: DASY4, Version 4.7 (80); SEMCAD X Version 14.6.4 (4989)

Mode: GPRS 850, Body SAR, Bottom Edge, Mid.ch, 1 Tx Slots

Area Scan (9x7x1): Measurement grid: dx=5mm, dy=15mm

Zoom Scan (5x5x7)/Cube 0: Measurement grid: dx=8mm, dy=8mm, dz=5mm

Reference Value = 12.171 V/m; Power Drift = -0.04 dB

Peak SAR (extrapolated) = 0.2060

SAR(1 g) = 0.129 mW/g; SAR(10 g) = 0.082 mW/g

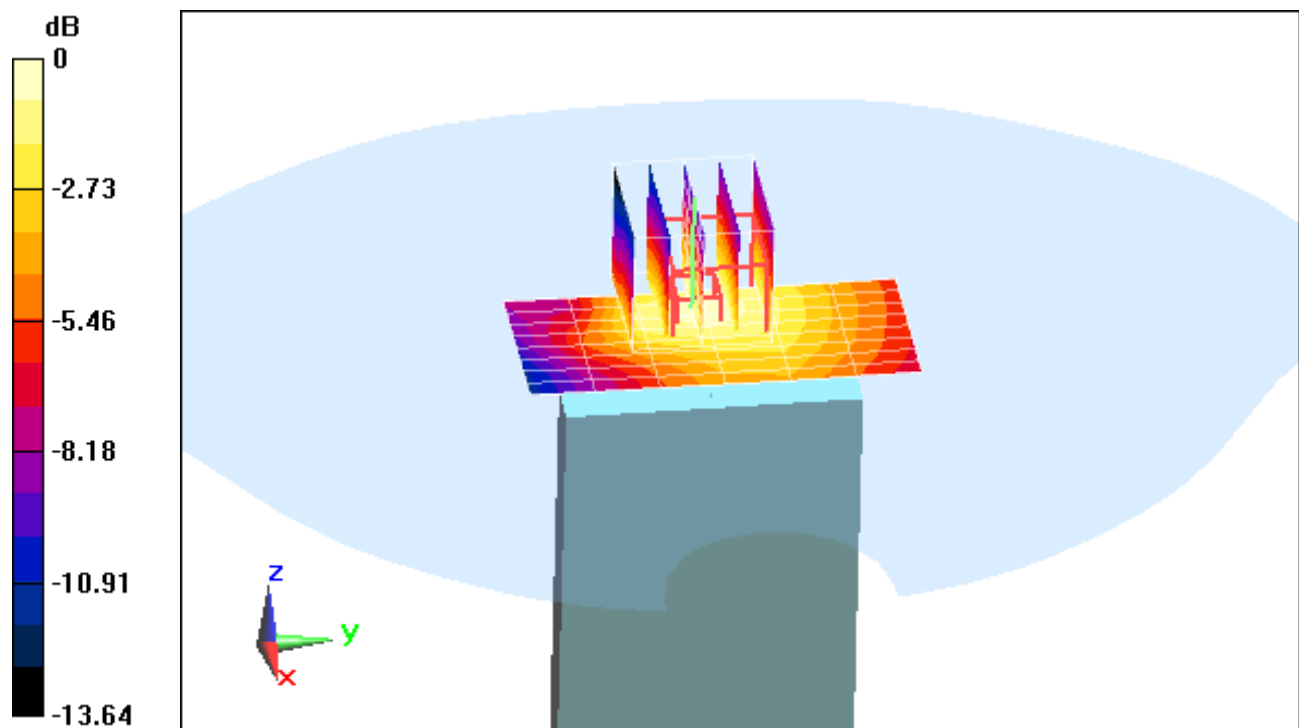

PCTEST ENGINEERING LABORATORY, INC.

DUT: TYK-EYC4287; Type: Portable Handset; Serial: KGM-U-004

Communication System: GSM850 GPRS; 1 Tx slots; Frequency: 836.6 MHz; Duty Cycle: 1:8.3

Medium: 835 Body Medium parameters used (interpolated):

$f = 836.6 \text{ MHz}$; $\sigma = 0.979 \text{ mho/m}$; $\epsilon_r = 55.323$; $\rho = 1000 \text{ kg/m}^3$

Phantom section: Flat Section; Space: 1.0 cm

Test Date: 07-27-2012; Ambient Temp: 24.4°C; Tissue Temp: 23.8°C

Probe: ES3DV3 - SN3258; ConvF(6.06, 6.06, 6.06); Calibrated: 2/21/2012

Sensor-Surface: 4mm (Mechanical Surface Detection)

Electronics: DAE4 Sn1272; Calibrated: 1/18/2012

Phantom: SAM Main; Type: SAM 4.0; Serial: TP-1406

Measurement SW: DASY4, Version 4.7 (80); SEMCAD X Version 14.6.4 (4989)

Mode: GPRS 850, Body SAR, Right Edge, Mid.ch, 1 Tx Slots

Area Scan (9x13x1): Measurement grid: dx=5mm, dy=15mm

Zoom Scan (5x5x7)/Cube 0: Measurement grid: dx=8mm, dy=8mm, dz=5mm

Reference Value = 23.515 V/m; Power Drift = 0.03 dB

Peak SAR (extrapolated) = 0.6850

SAR(1 g) = 0.501 mW/g; SAR(10 g) = 0.349 mW/g

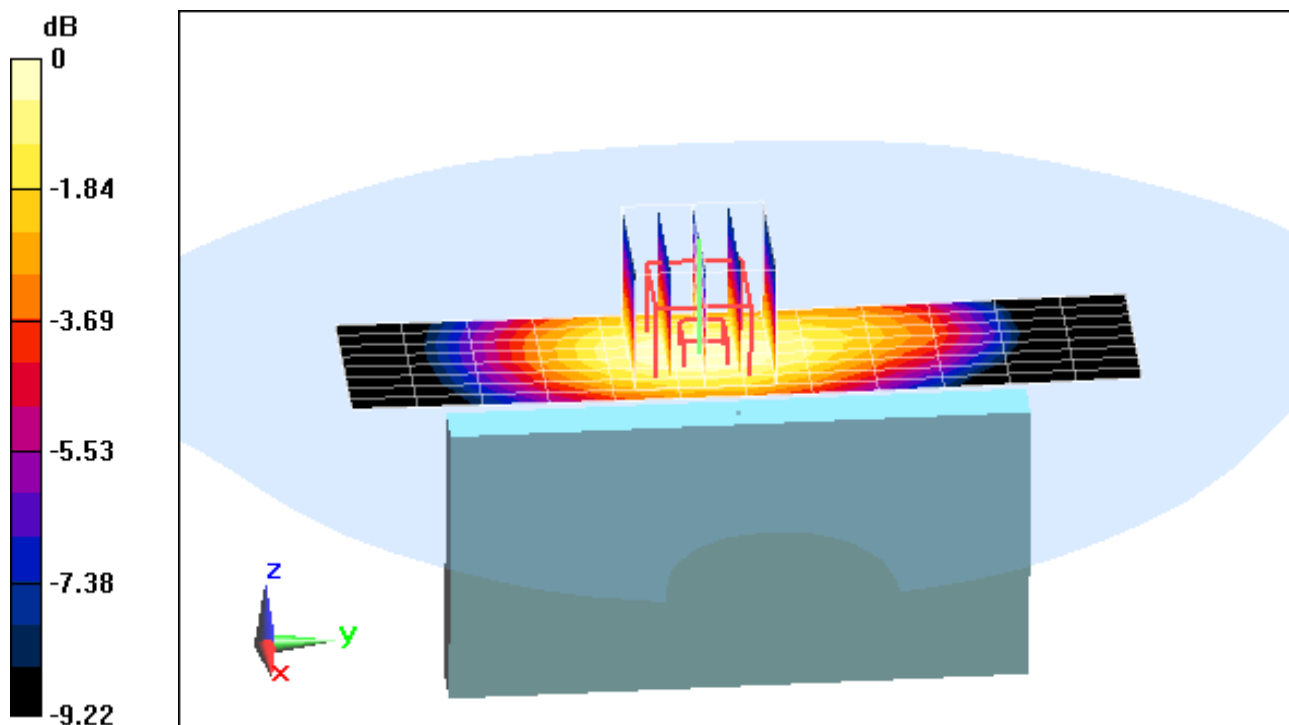

0 dB = 0.530mW/g = -5.51 dB mW/g

PCTEST ENGINEERING LABORATORY, INC.

DUT: TYK-EYC4287; Type: Portable Handset; Serial: KGM-U-004

Communication System: WCDMA850; Frequency: 836.6 MHz; Duty Cycle: 1:1

Medium: 835 Body Medium parameters used (interpolated):

$f = 836.6 \text{ MHz}$; $\sigma = 0.972 \text{ mho/m}$; $\epsilon_r = 54.858$; $\rho = 1000 \text{ kg/m}^3$

Phantom section: Flat Section; Space: 1.0 cm

Test Date: 07-30-2012; Ambient Temp: 24.1°C; Tissue Temp: 23.4°C

Probe: ES3DV3 - SN3258; ConvF(6.06, 6.06, 6.06); Calibrated: 2/21/2012

Sensor-Surface: 4mm (Mechanical Surface Detection)

Electronics: DAE4 Sn1272; Calibrated: 1/18/2012

Phantom: SAM Main; Type: SAM 4.0; Serial: TP-1406

Measurement SW: DASY4, Version 4.7 (80); SEMCAD X Version 14.6.4 (4989)

Mode: WCDMA 850, Body SAR, Back side, Mid.ch

Area Scan (7x12x1): Measurement grid: dx=15mm, dy=15mm

Zoom Scan (5x5x7)/Cube 0: Measurement grid: dx=8mm, dy=8mm, dz=5mm

Reference Value = 28.313 V/m; Power Drift = -0.02 dB

Peak SAR (extrapolated) = 0.9170

SAR(1 g) = 0.724 mW/g; SAR(10 g) = 0.536 mW/g

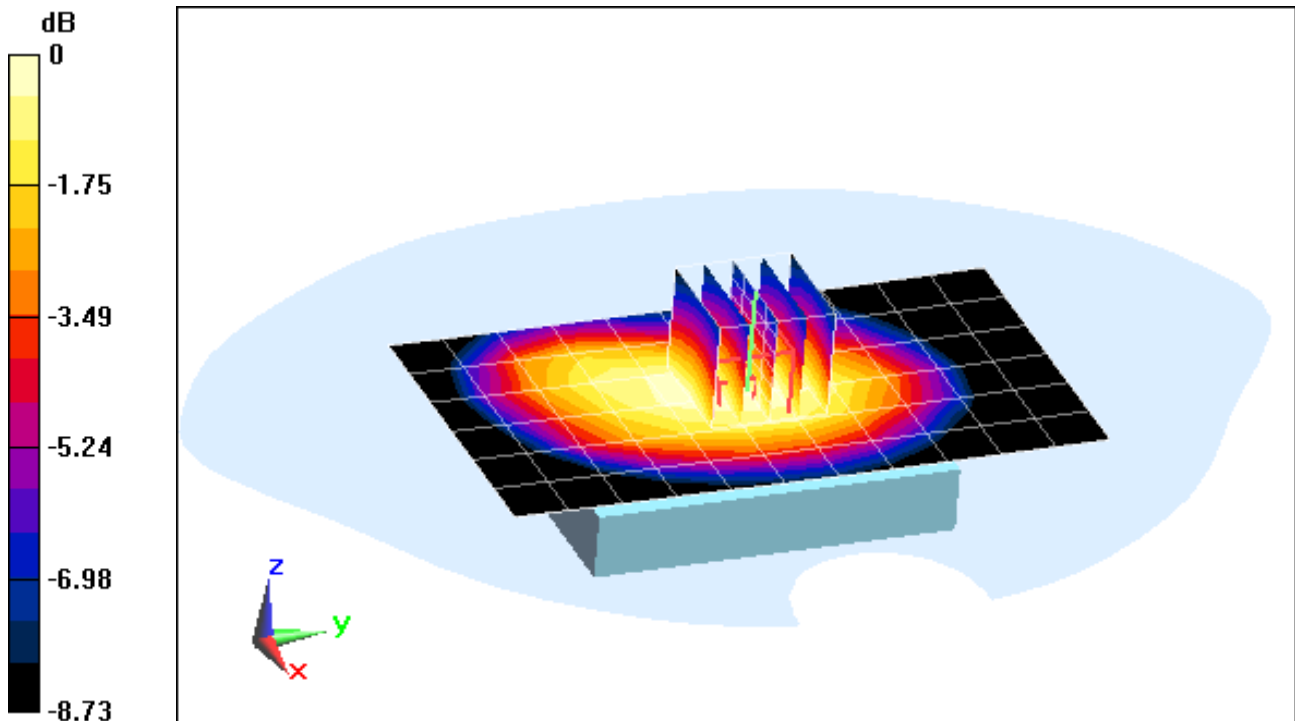

0 dB = 0.760mW/g = -2.38 dB mW/g

PCTEST ENGINEERING LABORATORY, INC.

DUT: TYK-EYC4287; Type: Portable Handset; Serial: KGM-U-004

Communication System: WCDMA850; Frequency: 836.6 MHz; Duty Cycle: 1:1

Medium: 835 Body Medium parameters used (interpolated):

$f = 836.6 \text{ MHz}$; $\sigma = 0.972 \text{ mho/m}$; $\epsilon_r = 54.858$; $\rho = 1000 \text{ kg/m}^3$

Phantom section: Flat Section; Space: 1.0 cm

Test Date: 07-30-2012; Ambient Temp: 24.1°C; Tissue Temp: 23.4°C

Probe: ES3DV3 - SN3258; ConvF(6.06, 6.06, 6.06); Calibrated: 2/21/2012

Sensor-Surface: 4mm (Mechanical Surface Detection)

Electronics: DAE4 Sn1272; Calibrated: 1/18/2012

Phantom: SAM Main; Type: SAM 4.0; Serial: TP-1406

Measurement SW: DASY4, Version 4.7 (80); SEMCAD X Version 14.6.4 (4989)

Mode: WCDMA 850, Body SAR, Front side, Mid.ch

Area Scan (7x12x1): Measurement grid: dx=15mm, dy=15mm

Zoom Scan (5x5x7)/Cube 0: Measurement grid: dx=8mm, dy=8mm, dz=5mm

Reference Value = 27.408 V/m; Power Drift = 0.02 dB

Peak SAR (extrapolated) = 0.8800

SAR(1 g) = 0.675 mW/g; SAR(10 g) = 0.509 mW/g

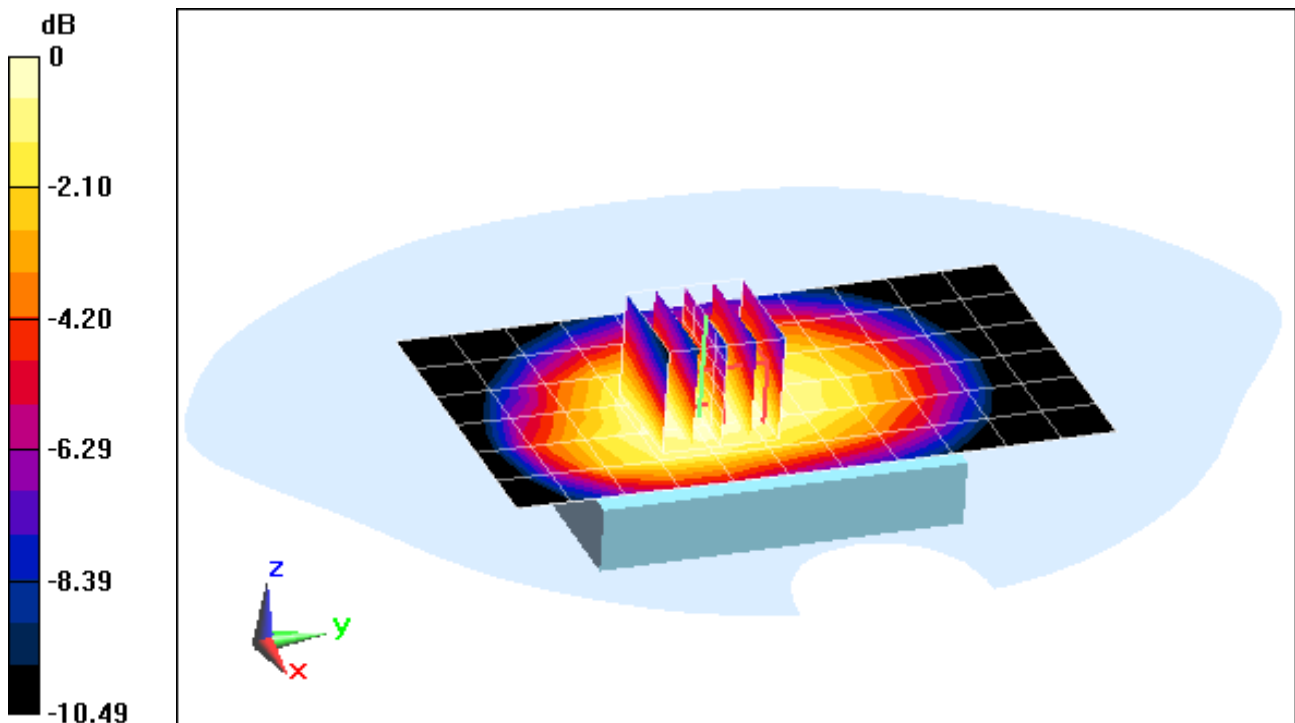

0 dB = 0.710mW/g = -2.97 dB mW/g

PCTEST ENGINEERING LABORATORY, INC.

DUT: TYK-EYC4287; Type: Portable Handset; Serial: KGM-U-004

Communication System: WCDMA850; Frequency: 836.6 MHz; Duty Cycle: 1:1

Medium: 835 Body Medium parameters used (interpolated):

$f = 836.6 \text{ MHz}$; $\sigma = 0.972 \text{ mho/m}$; $\epsilon_r = 54.858$; $\rho = 1000 \text{ kg/m}^3$

Phantom section: Flat Section; Space: 1.0 cm

Test Date: 07-30-2012; Ambient Temp: 24.1°C; Tissue Temp: 23.4°C

Probe: ES3DV3 - SN3258; ConvF(6.06, 6.06, 6.06); Calibrated: 2/21/2012

Sensor-Surface: 4mm (Mechanical Surface Detection)

Electronics: DAE4 Sn1272; Calibrated: 1/18/2012

Phantom: SAM Main; Type: SAM 4.0; Serial: TP-1406

Measurement SW: DASY4, Version 4.7 (80); SEMCAD X Version 14.6.4 (4989)

Mode: WCDMA 850, Body SAR, Bottom Edge, Mid.ch

Area Scan (9x7x1): Measurement grid: dx=5mm, dy=15mm

Zoom Scan (5x5x7)/Cube 0: Measurement grid: dx=8mm, dy=8mm, dz=5mm

Reference Value = 10.326 V/m; Power Drift = 0.11 dB

Peak SAR (extrapolated) = 0.1420

SAR(1 g) = 0.092 mW/g; SAR(10 g) = 0.060 mW/g

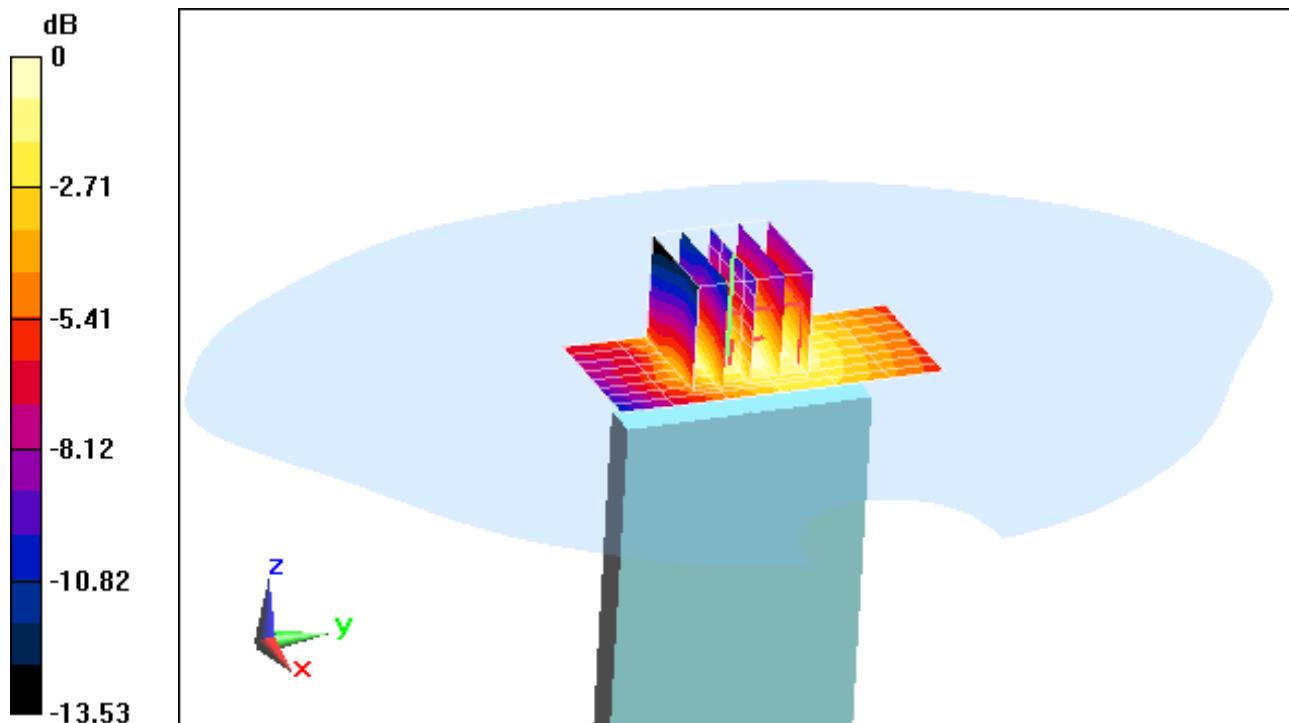

0 dB = 0.100mW/g = -20.00 dB mW/g

PCTEST ENGINEERING LABORATORY, INC.

DUT: TYK-EYC4287; Type: Portable Handset; Serial: KGM-U-004

Communication System: WCDMA850; Frequency: 836.6 MHz; Duty Cycle: 1:1

Medium: 835 Body Medium parameters used (interpolated):

$f = 836.6 \text{ MHz}$; $\sigma = 0.972 \text{ mho/m}$; $\epsilon_r = 54.858$; $\rho = 1000 \text{ kg/m}^3$

Phantom section: Flat Section; Space: 1.0 cm

Test Date: 07-30-2012; Ambient Temp: 24.1°C; Tissue Temp: 23.4°C

Probe: ES3DV3 - SN3258; ConvF(6.06, 6.06, 6.06); Calibrated: 2/21/2012

Sensor-Surface: 4mm (Mechanical Surface Detection)

Electronics: DAE4 Sn1272; Calibrated: 1/18/2012

Phantom: SAM Main; Type: SAM 4.0; Serial: TP-1406

Measurement SW: DASY4, Version 4.7 (80); SEMCAD X Version 14.6.4 (4989)

Mode: WCDMA 850, Body SAR, Right Edge, Mid.ch

Area Scan (9x13x1): Measurement grid: dx=5mm, dy=15mm

Zoom Scan (5x5x7)/Cube 0: Measurement grid: dx=8mm, dy=8mm, dz=5mm

Reference Value = 24.613 V/m; Power Drift = -0.12 dB

Peak SAR (extrapolated) = 0.7260

SAR(1 g) = 0.528 mW/g; SAR(10 g) = 0.368 mW/g

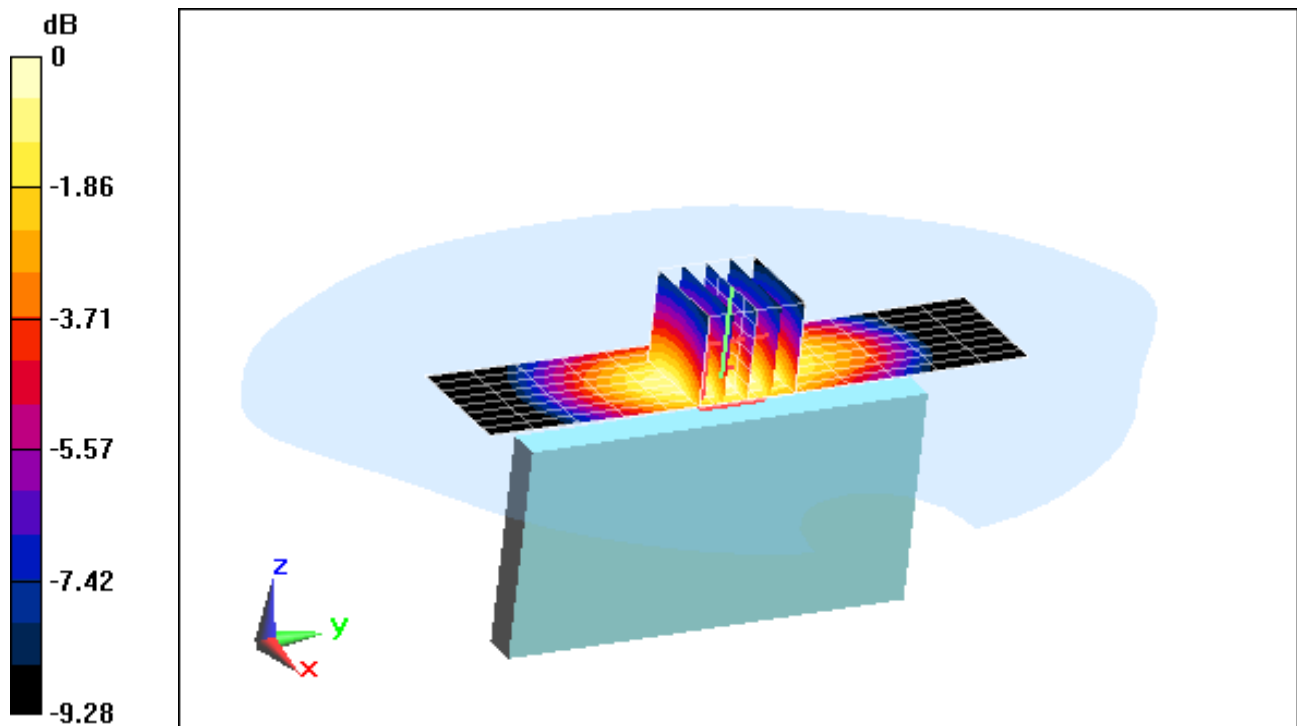

0 dB = 0.560mW/g = -5.04 dB mW/g

PCTEST ENGINEERING LABORATORY, INC.

DUT: TYK-EYC4287; Type: Portable Handset; Serial: KGM-U-004

Communication System: GSM GPRS; 1 Tx slot; Frequency: 1850.2 MHz; Duty Cycle: 1.8.3

Medium: 1900 Body Medium parameters used (interpolated):

$f = 1850.2 \text{ MHz}$; $\sigma = 1.491 \text{ mho/m}$; $\epsilon_r = 51.81$; $\rho = 1000 \text{ kg/m}^3$

Phantom section: Flat Section; Space: 1.0 cm

Test Date: 07-31-2012; Ambient Temp: 21.9°C; Tissue Temp: 21.1°C

Probe: ES3DV3 - SN3287; ConvF(4.76, 4.76, 4.76); Calibrated: 2/7/2012

Sensor-Surface: 4mm (Mechanical Surface Detection)

Electronics: DAE4 Sn649; Calibrated: 2/20/2012

Phantom: SAM v5.0 front; Type: QD000P40CD; Serial: TP-1646

Measurement SW: DASY52, Version 52.8 (1); SEMCAD X Version 14.6.4 (4989)

Mode: GPRS 1900, Body SAR, Back side, Low.ch, 1 Tx Slots

Area Scan (7x10x1): Measurement grid: dx=15mm, dy=15mm

Zoom Scan (5x5x7)/Cube 0: Measurement grid: dx=8mm, dy=8mm, dz=5mm

Reference Value = 20.469 V/m; Power Drift = -0.05 dB

Peak SAR (extrapolated) = 1.0690

SAR(1 g) = 0.624 mW/g; SAR(10 g) = 0.374 mW/g

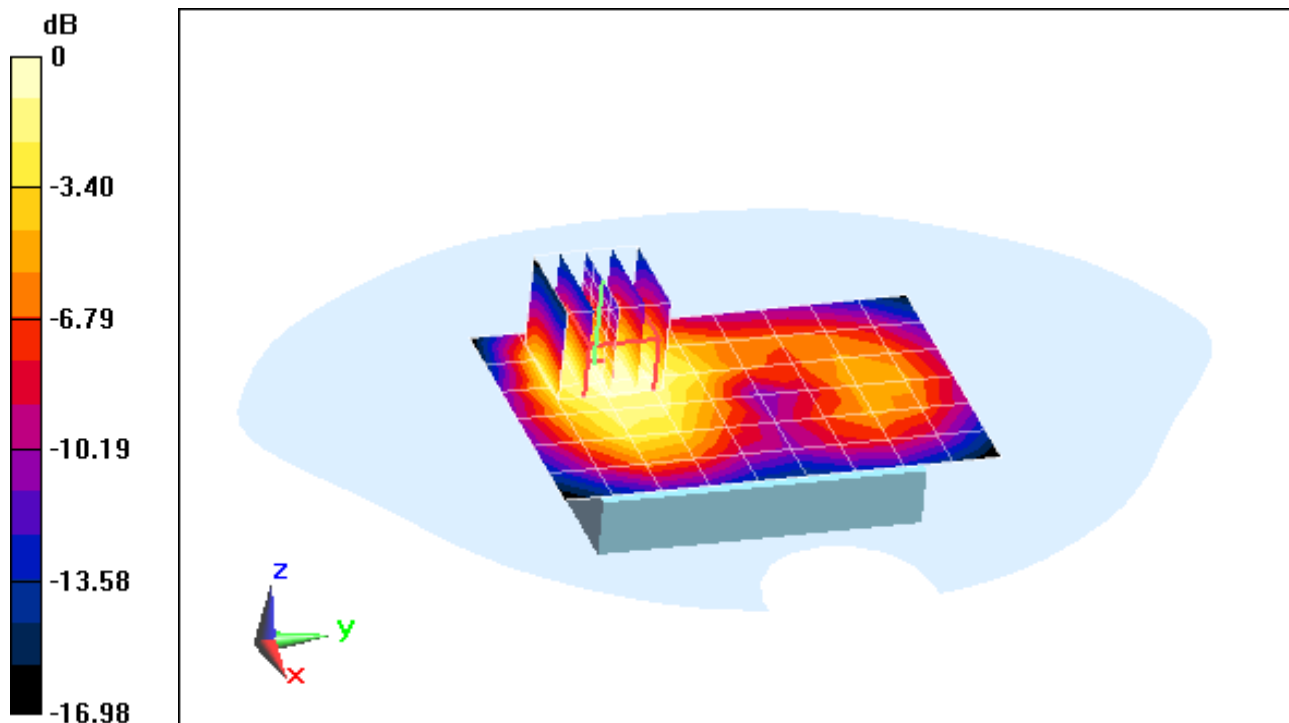

0 dB = 0.670mW/g = -3.48 dB mW/g

PCTEST ENGINEERING LABORATORY, INC.

DUT: TYK-EYC4287; Type: Portable Handset; Serial: KGM-U-004

Communication System: GSM GPRS; 1 Tx slot; Frequency: 1850.2 MHz; Duty Cycle: 1.8.3

Medium: 1900 Body Medium parameters used (interpolated):

$f = 1850.2 \text{ MHz}$; $\sigma = 1.491 \text{ mho/m}$; $\epsilon_r = 51.81$; $\rho = 1000 \text{ kg/m}^3$

Phantom section: Flat Section; Space: 1.0 cm

Test Date: 07-31-2012; Ambient Temp: 21.9°C; Tissue Temp: 21.1°C

Probe: ES3DV3 - SN3287; ConvF(4.76, 4.76, 4.76); Calibrated: 2/7/2012

Sensor-Surface: 4mm (Mechanical Surface Detection)

Electronics: DAE4 Sn649; Calibrated: 2/20/2012

Phantom: SAM v5.0 front; Type: QD000P40CD; Serial: TP-1646

Measurement SW: DASY52, Version 52.8 (1); SEMCAD X Version 14.6.4 (4989)

Mode: GPRS 1900, Body SAR, Front side, Low.ch, 1 Tx Slots

Area Scan (7x10x1): Measurement grid: dx=15mm, dy=15mm

Zoom Scan (5x5x7)/Cube 0: Measurement grid: dx=8mm, dy=8mm, dz=5mm

Reference Value = 20.226 V/m; Power Drift = -0.06 dB

Peak SAR (extrapolated) = 0.8210

SAR(1 g) = 0.541 mW/g; SAR(10 g) = 0.341 mW/g

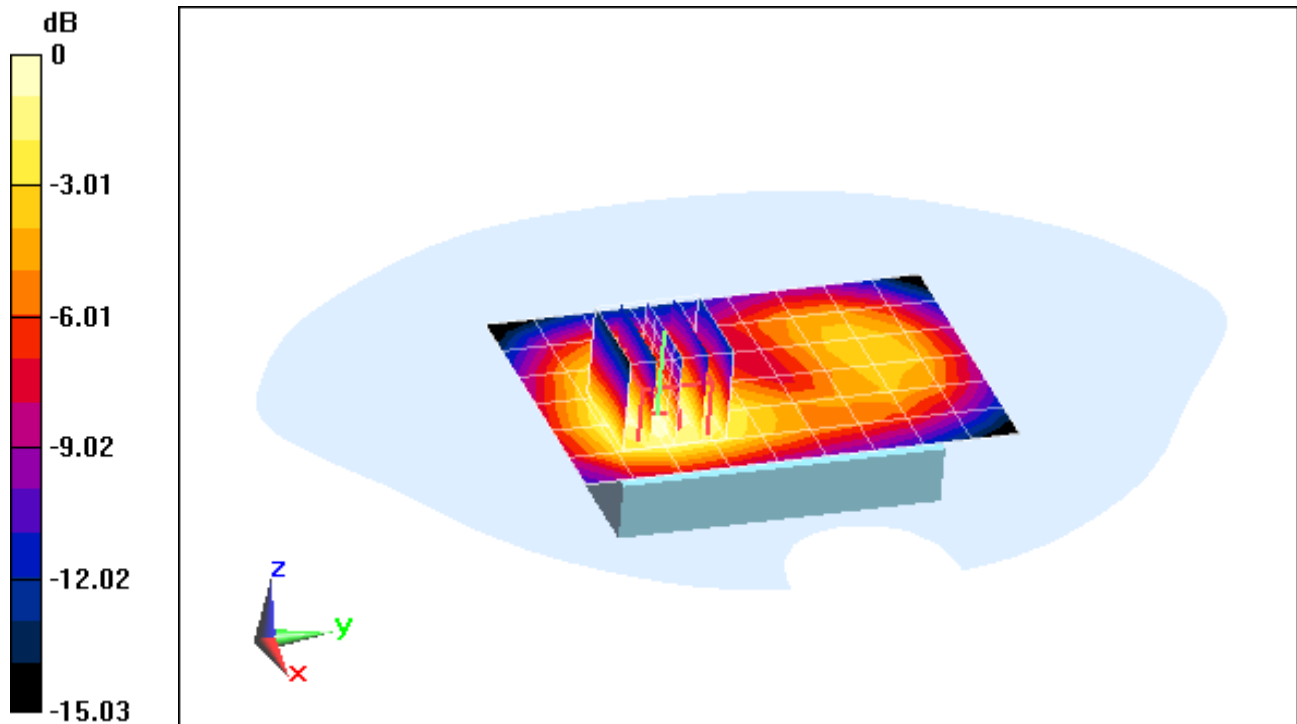

0 dB = 0.580mW/g = -4.73 dB mW/g

PCTEST ENGINEERING LABORATORY, INC.

DUT: TYK-EYC4287; Type: Portable Handset; Serial: KGM-U-004

Communication System: GSM GPRS; 1 Tx slot; Frequency: 1850.2 MHz; Duty Cycle: 1:8.3

Medium: 1900 Body Medium parameters used (interpolated):

$f = 1850.2 \text{ MHz}$; $\sigma = 1.491 \text{ mho/m}$; $\epsilon_r = 51.81$; $\rho = 1000 \text{ kg/m}^3$

Phantom section: Flat Section; Space: 1.0 cm

Test Date: 07-31-2012; Ambient Temp: 21.9°C; Tissue Temp: 21.1°C

Probe: ES3DV3 - SN3287; ConvF(4.76, 4.76, 4.76); Calibrated: 2/7/2012

Sensor-Surface: 4mm (Mechanical Surface Detection)

Electronics: DAE4 Sn649; Calibrated: 2/20/2012

Phantom: SAM v5.0 front; Type: QD000P40CD; Serial: TP-1646

Measurement SW: DASY52, Version 52.8 (1); SEMCAD X Version 14.6.4 (4989)

Mode: GPRS 1900, Body SAR, Bottom Edge, Low.ch, 1 Tx Slots

Area Scan (11x7x1): Measurement grid: dx=5mm, dy=15mm

Zoom Scan (5x5x7)/Cube 0: Measurement grid: dx=8mm, dy=8mm, dz=5mm

Reference Value = 7.954 V/m; Power Drift = -0.06 dB

Peak SAR (extrapolated) = 0.1240

SAR(1 g) = 0.083 mW/g; SAR(10 g) = 0.053 mW/g

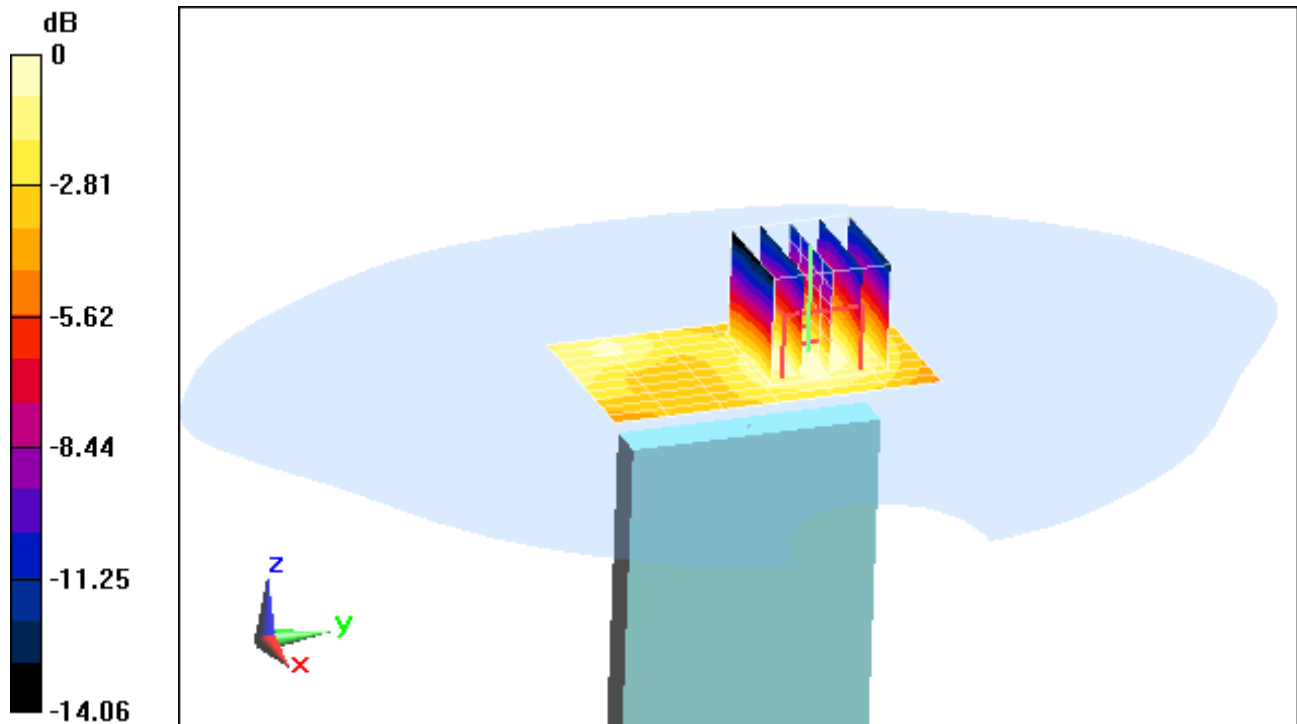

PCTEST ENGINEERING LABORATORY, INC.

DUT: TYK-EYC4287; Type: Portable Handset; Serial: KGM-U-004

Communication System: GSM GPRS; 1 Tx slot; Frequency: 1850.2 MHz; Duty Cycle: 1.8.3

Medium: 1900 Body Medium parameters used (interpolated):

$f = 1850.2 \text{ MHz}$; $\sigma = 1.491 \text{ mho/m}$; $\epsilon_r = 51.81$; $\rho = 1000 \text{ kg/m}^3$

Phantom section: Flat Section; Space: 1.0 cm

Test Date: 07-31-2012; Ambient Temp: 21.9°C; Tissue Temp: 21.1°C

Probe: ES3DV3 - SN3287; ConvF(4.76, 4.76, 4.76); Calibrated: 2/7/2012

Sensor-Surface: 4mm (Mechanical Surface Detection)

Electronics: DAE4 Sn649; Calibrated: 2/20/2012

Phantom: SAM v5.0 front; Type: QD000P40CD; Serial: TP-1646

Measurement SW: DASY52, Version 52.8 (1); SEMCAD X Version 14.6.4 (4989)

Mode: GPRS 1900, Body SAR, Right Edge, Low.ch, 1 Tx Slots

Area Scan (11x10x1): Measurement grid: dx=5mm, dy=15mm

Zoom Scan (5x5x7)/Cube 0: Measurement grid: dx=8mm, dy=8mm, dz=5mm

Reference Value = 15.456 V/m; Power Drift = -0.05 dB

Peak SAR (extrapolated) = 0.5370

SAR(1 g) = 0.325 mW/g; SAR(10 g) = 0.187 mW/g

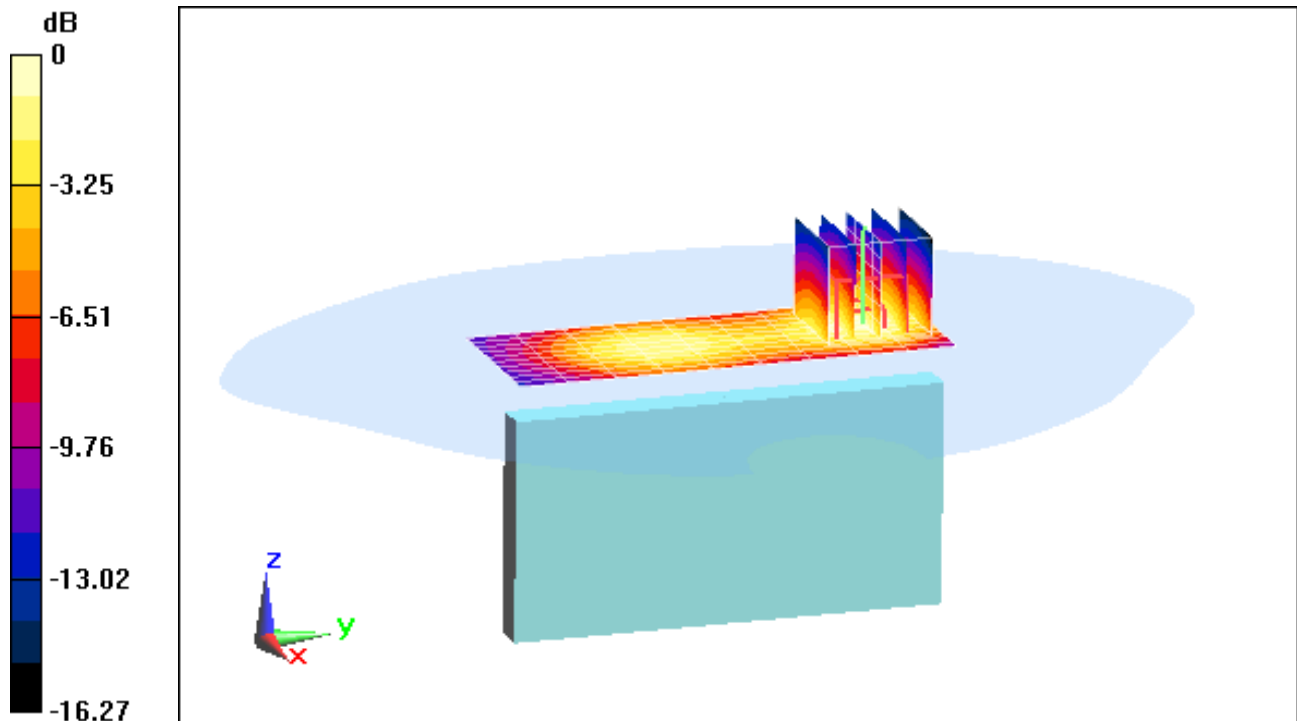

0 dB = 0.360mW/g = -8.87 dB mW/g

PCTEST ENGINEERING LABORATORY, INC.

DUT: TYK-EYC4287; Type: Portable Handset; Serial: KGM-U-002

Communication System: IEEE 802.11b; Frequency: 2412 MHz; Duty Cycle: 1:1

Medium: 2450 Body Medium parameters used (interpolated):

$f = 2412 \text{ MHz}$; $\sigma = 2 \text{ mho/m}$; $\epsilon_r = 53.592$; $\rho = 1000 \text{ kg/m}^3$

Phantom section: Flat Section; Space: 1.0 cm

Test Date: 08-01-2012; Ambient Temp: 23.4°C; Tissue Temp: 23.0°C

Probe: ES3DV2 - SN3022; ConvF(4.01, 4.01, 4.01); Calibrated: 8/25/2011

Sensor-Surface: 3mm (Mechanical Surface Detection)

Electronics: DAE4 Sn665; Calibrated: 4/19/2012

Phantom: SAM Sub Dasy B; Type: SAM 5.0; Serial: TP-1626

Measurement SW: DASY4, Version 4.7 (80); SEMCAD X Version 14.6.4 (4989)

Mode: IEEE 802.11b, Body SAR, Ch 01, 1 Mbps, Back Side

Area Scan (10x15x1): Measurement grid: dx=12mm, dy=12mm

Zoom Scan (7x7x7)/Cube 0: Measurement grid: dx=5mm, dy=5mm, dz=5mm

Reference Value = 6.616 V/m; Power Drift = 0.09 dB

Peak SAR (extrapolated) = 0.1550

SAR(1 g) = 0.080 mW/g; SAR(10 g) = 0.041 mW/g

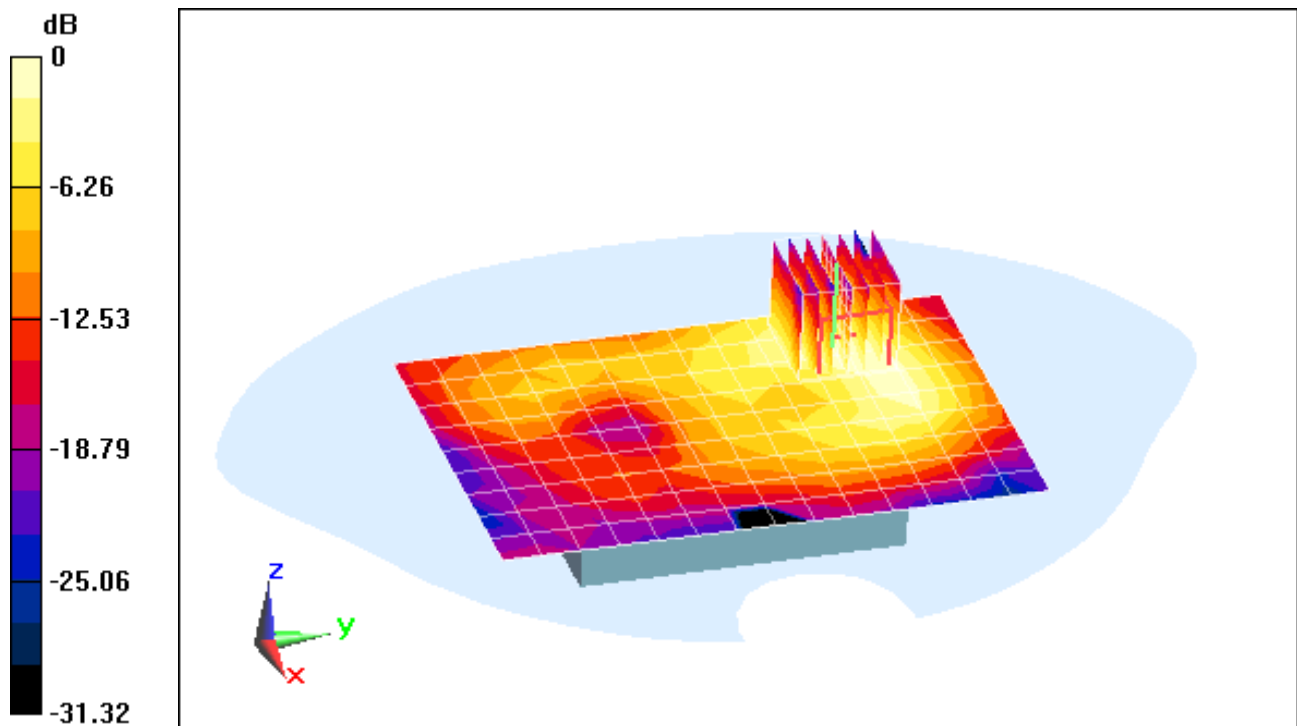

0 dB = 0.100mW/g = -20.00 dB mW/g

PCTEST ENGINEERING LABORATORY, INC.

DUT: TYK-EYC4287; Type: Portable Handset; Serial: KGM-U-002

Communication System: IEEE 802.11b; Frequency: 2412 MHz; Duty Cycle: 1:1

Medium: 2450 Body Medium parameters used (interpolated):

$f = 2412 \text{ MHz}$; $\sigma = 2 \text{ mho/m}$; $\epsilon_r = 53.592$; $\rho = 1000 \text{ kg/m}^3$

Phantom section: Flat Section; Space: 1.0 cm

Test Date: 08-01-2012; Ambient Temp: 23.4°C; Tissue Temp: 23.0°C

Probe: ES3DV2 - SN3022; ConvF(4.01, 4.01, 4.01); Calibrated: 8/25/2011

Sensor-Surface: 3mm (Mechanical Surface Detection)

Electronics: DAE4 Sn665; Calibrated: 4/19/2012

Phantom: SAM Sub Dasy B; Type: SAM 5.0; Serial: TP-1626

Measurement SW: DASY4, Version 4.7 (80); SEMCAD X Version 14.6.4 (4989)

Mode: IEEE 802.11b, Body SAR, Ch 1, 1 Mbps, Front Side

Area Scan (10x15x1): Measurement grid: dx=12mm, dy=12mm

Zoom Scan (7x7x7)/Cube 0: Measurement grid: dx=5mm, dy=5mm, dz=5mm

Reference Value = 5.664 V/m; Power Drift = 0.08 dB

Peak SAR (extrapolated) = 0.1170

SAR(1 g) = 0.063 mW/g; SAR(10 g) = 0.036 mW/g

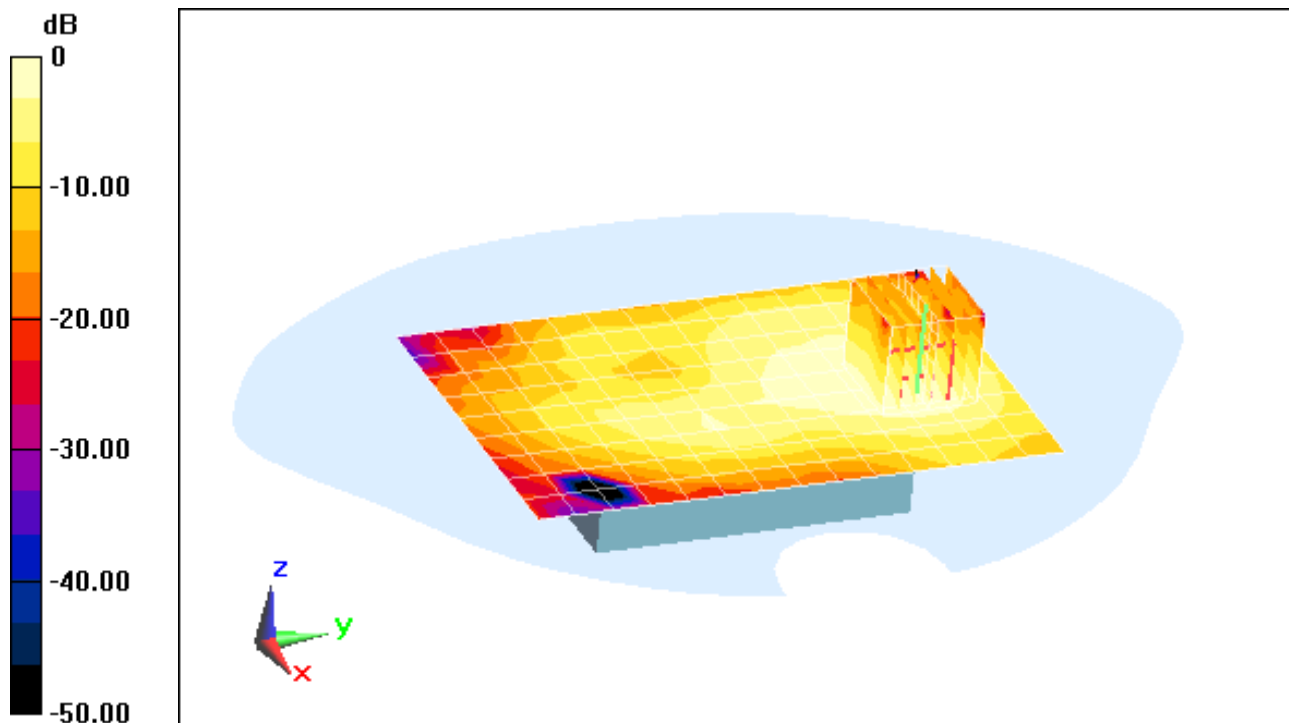

0 dB = 0.080mW/g = -21.94 dB mW/g

PCTEST ENGINEERING LABORATORY, INC.

DUT: TYK-EYC4287; Type: Portable Handset; Serial: KGM-U-002

Communication System: IEEE 802.11b; Frequency: 2412 MHz; Duty Cycle: 1:1

Medium: 2450 Body Medium parameters used (interpolated):

$f = 2412 \text{ MHz}; \sigma = 2 \text{ mho/m}; \epsilon_r = 53.592; \rho = 1000 \text{ kg/m}^3$

Phantom section: Flat Section; Space: 1.0 cm

Test Date: 08-01-2012; Ambient Temp: 23.4°C; Tissue Temp: 23.0°C

Probe: ES3DV2 - SN3022; ConvF(4.01, 4.01, 4.01); Calibrated: 8/25/2011

Sensor-Surface: 3mm (Mechanical Surface Detection)

Electronics: DAE4 Sn665; Calibrated: 4/19/2012

Phantom: SAM Sub Dasy B; Type: SAM 5.0; Serial: TP-1626

Measurement SW: DASY4, Version 4.7 (80); SEMCAD X Version 14.6.4 (4989)

Mode: IEEE 802.11b, Body SAR, Ch 1, 1 Mbps, Top Edge

Area Scan (9x8x1): Measurement grid: dx=5mm, dy=12mm

Zoom Scan (7x7x7)/Cube 0: Measurement grid: dx=5mm, dy=5mm, dz=5mm

Reference Value = 4.018 V/m; Power Drift = 0.05 dB

Peak SAR (extrapolated) = 0.0540

SAR(1 g) = 0.031 mW/g; SAR(10 g) = 0.017 mW/g

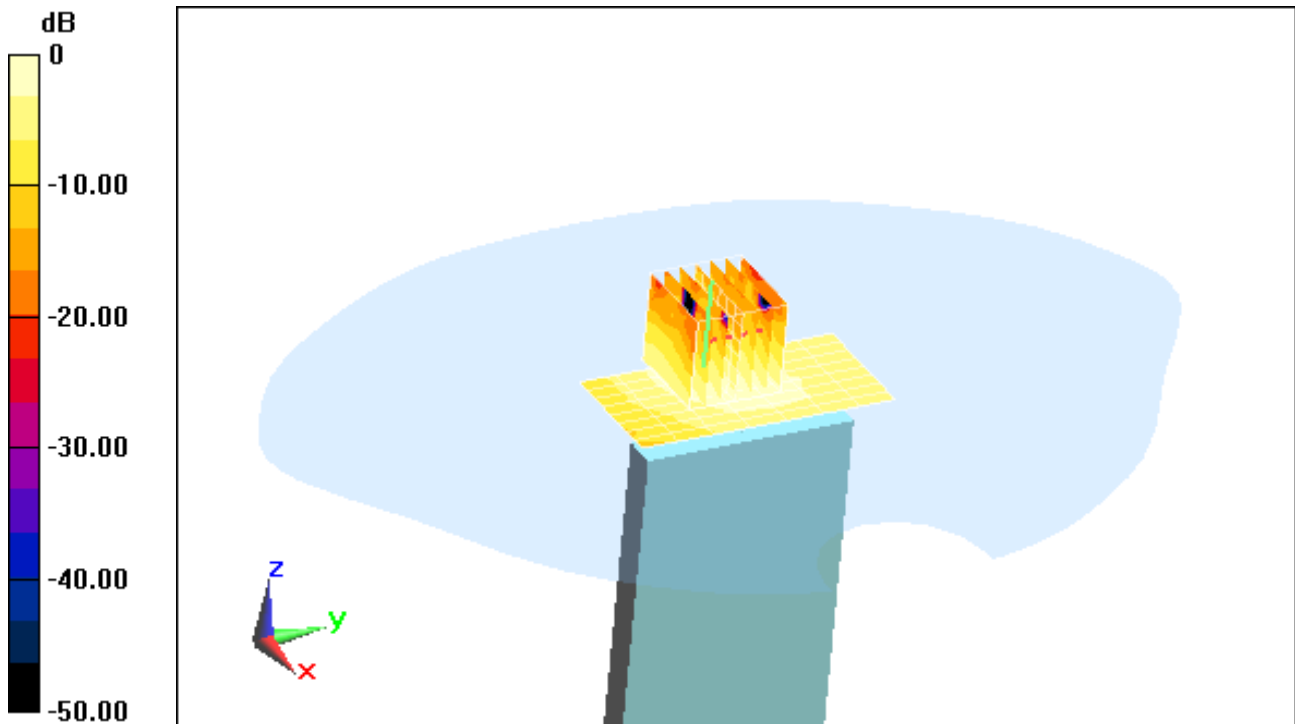

PCTEST ENGINEERING LABORATORY, INC.

DUT: TYK-EYC4287; Type: Portable Handset; Serial: KGM-U-002

Communication System: IEEE 802.11b; Frequency: 2412 MHz; Duty Cycle: 1:1

Medium: 2450 Body Medium parameters used (interpolated):

$f = 2412 \text{ MHz}$; $\sigma = 2 \text{ mho/m}$; $\epsilon_r = 53.592$; $\rho = 1000 \text{ kg/m}^3$

Phantom section: Flat Section; Space: 1.0 cm

Test Date: 08-01-2012; Ambient Temp: 23.4°C; Tissue Temp: 23.0°C

Probe: ES3DV2 - SN3022; ConvF(4.01, 4.01, 4.01); Calibrated: 8/25/2011

Sensor-Surface: 3mm (Mechanical Surface Detection)

Electronics: DAE4 Sn665; Calibrated: 4/19/2012

Phantom: SAM Sub Dasy B; Type: SAM 5.0; Serial: TP-1626

Measurement SW: DASY4, Version 4.7 (80); SEMCAD X Version 14.6.4 (4989)

Mode: IEEE 802.11b, Body SAR, Ch 1, 1 Mbps, Right Edge

Area Scan (9x14x1): Measurement grid: dx=5mm, dy=12mm

Zoom Scan (7x7x7)/Cube 0: Measurement grid: dx=5mm, dy=5mm, dz=5mm

Reference Value = 2.299 V/m; Power Drift = -0.14 dB

Peak SAR (extrapolated) = 0.0200

SAR(1 g) = 0.010 mW/g; SAR(10 g) = 0.00529 mW/g

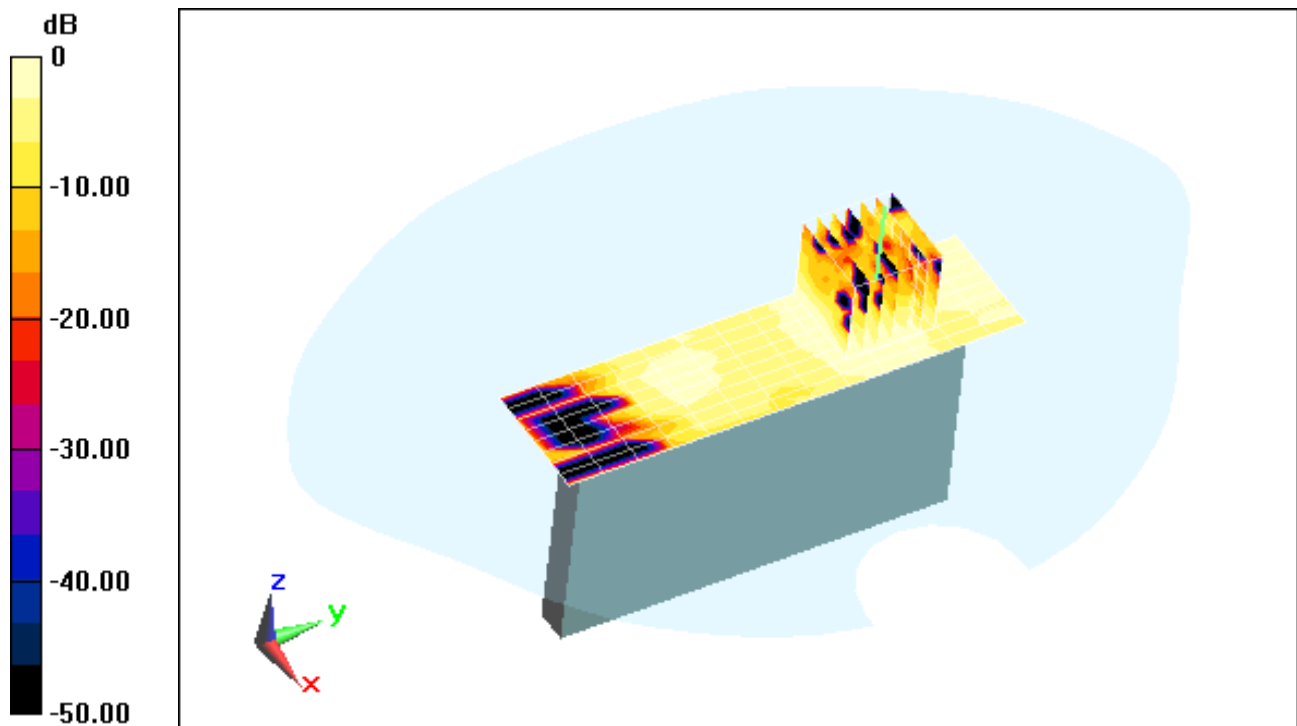

0 dB = 0.010mW/g = -40.00 dB mW/g

APPENDIX B: SYSTEM VERIFICATION

PCTEST ENGINEERING LABORATORY, INC.

DUT: Dipole 835 MHz; Type: D835V2; Serial: 4d119

Communication System: CW; Frequency: 835 MHz; Duty Cycle: 1:1

Medium: 835 Head Medium parameters used:

$f = 835 \text{ MHz}$; $\sigma = 0.917 \text{ mho/m}$; $\epsilon_r = 40.72$; $\rho = 1000 \text{ kg/m}^3$

Phantom section: Flat Section; Space: 1.5 cm

Test Date: 07-26-2012; Ambient Temp: 24.2°C; Tissue Temp: 23.3°C

Probe: ES3DV3 - SN3258; ConvF(6.01, 6.01, 6.01); Calibrated: 2/21/2012

Sensor-Surface: 4mm (Mechanical Surface Detection)

Electronics: DAE4 Sn1272; Calibrated: 1/18/2012

Phantom: SAM Sub; Type: SAM 4.0; Serial: TP-1403

Measurement SW: DASY4, Version 4.7 (80); SEMCAD X Version 14.6.4 (4989)

835MHz System Verification

Area Scan (7x13x1): Measurement grid: dx=15mm, dy=15mm

Zoom Scan (5x5x7)/Cube 0: Measurement grid: dx=8mm, dy=8mm, dz=5mm

Input Power = 20 dBm (100 mW)

SAR(1 g) = 0.979 mW/g; SAR(10 g) = 0.635 mW/g

Deviation = 3.93%

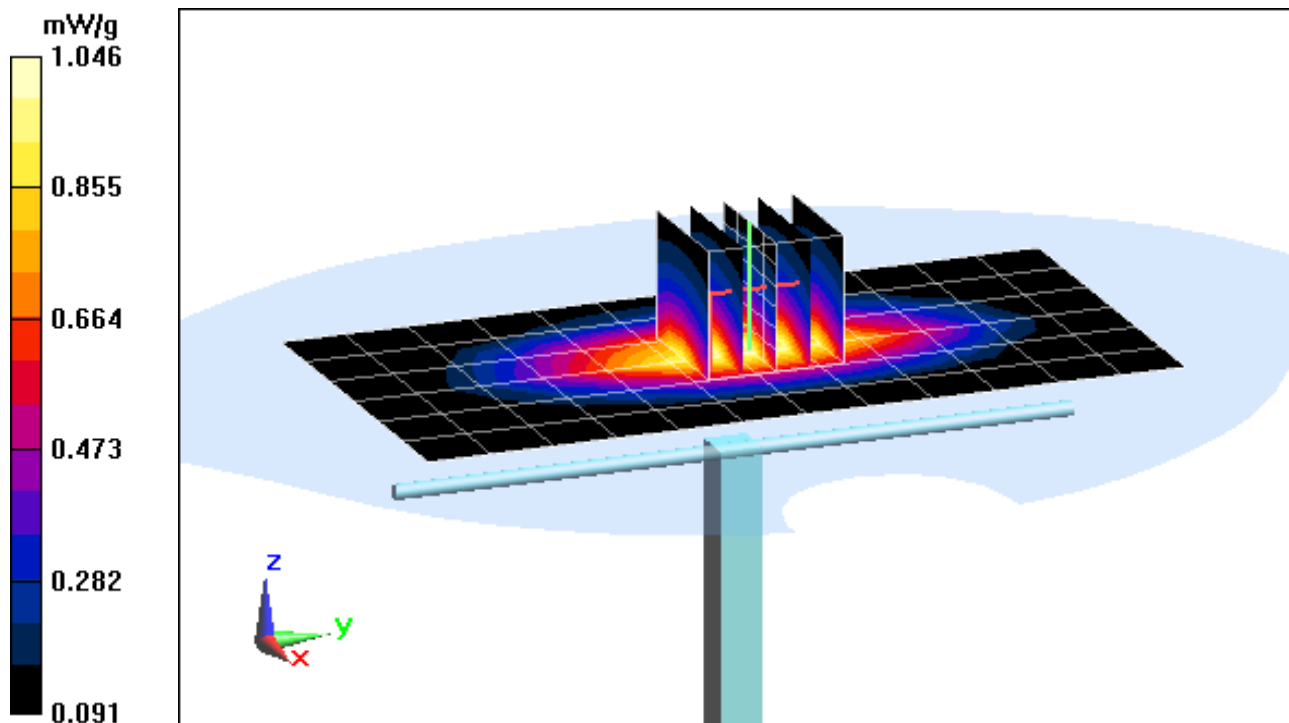

PCTEST ENGINEERING LABORATORY, INC.

DUT: Dipole 835 MHz; Type: D835V2; Serial: 4d119

Communication System: CW; Frequency: 835 MHz; Duty Cycle: 1:1

Medium: 835 Head Medium parameters used:

$f = 835 \text{ MHz}$; $\sigma = 0.917 \text{ mho/m}$; $\epsilon_r = 40.72$; $\rho = 1000 \text{ kg/m}^3$

Phantom section: Flat Section; Space: 1.5 cm

Test Date: 07-26-2012; Ambient Temp: 24.2°C; Tissue Temp: 23.3°C

Probe: ES3DV3 - SN3258; ConvF(6.01, 6.01, 6.01); Calibrated: 2/21/2012

Sensor-Surface: 4mm (Mechanical Surface Detection)

Electronics: DAE4 Sn1272; Calibrated: 1/18/2012

Phantom: SAM Sub; Type: SAM 4.0; Serial: TP-1403

Measurement SW: DASY4, Version 4.7 (80); SEMCAD X Version 14.6.4 (4989)

835MHz System Verification

Area Scan (7x13x1): Measurement grid: dx=15mm, dy=15mm

Zoom Scan (5x5x7)/Cube 0: Measurement grid: dx=8mm, dy=8mm, dz=5mm

Input Power = 20 dBm (100 mW)

SAR(1 g) = 0.979 mW/g; SAR(10 g) = 0.635 mW/g

Deviation = 3.93%

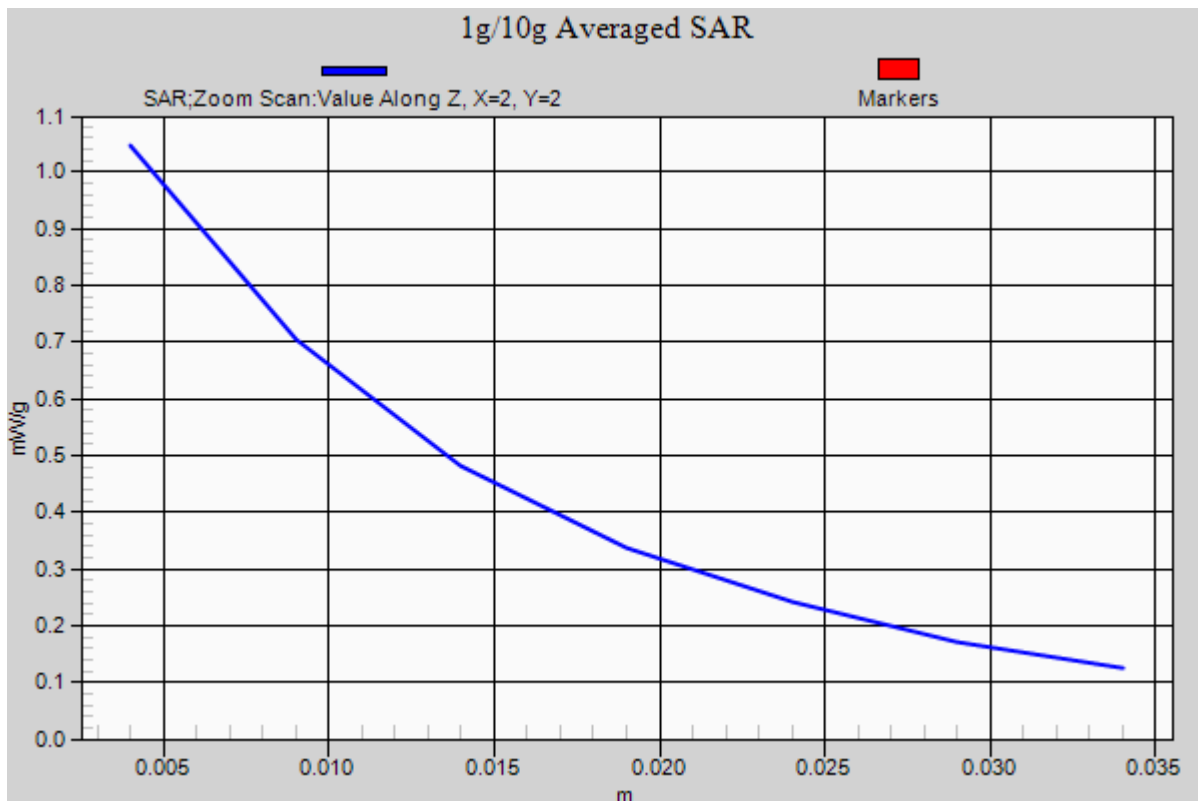

PCTEST ENGINEERING LABORATORY, INC.

DUT: SAR Dipole 1900 MHz; Type: D1900V2; Serial: 5d149

Communication System: CW; Frequency: 1900 MHz; Duty Cycle: 1:1

Medium: 1900 Head Medium parameters used (interpolated):

$f = 1900 \text{ MHz}$; $\sigma = 1.418 \text{ mho/m}$; $\epsilon_r = 38.503$; $\rho = 1000 \text{ kg/m}^3$

Phantom section: Flat Section; Space: 1.0 cm

Test Date: 07-30-2012; Ambient Temp: 21.1°C; Tissue Temp: 21.2°C

Probe: ES3DV3 - SN3287; ConvF(5.06, 5.06, 5.06); Calibrated: 2/7/2012

Sensor-Surface: 4mm (Mechanical Surface Detection)

Electronics: DAE4 Sn649; Calibrated: 2/20/2012

Phantom: SAM v5.0 Left; Type: QD000P40CD; Serial: TP: 1687

Measurement SW: DASY52, Version 52.8 (1); SEMCAD X Version 14.6.4 (4989)

1900 MHz System Verification

Area Scan (7x9x1): Measurement grid: dx=15mm, dy=15mm

Zoom Scan (7x7x7)/Cube 0: Measurement grid: dx=5mm, dy=5mm, dz=5mm

Input Power = 20 dBm (100mW)

SAR(1 g) = 4.11 mW/g; SAR(10 g) = 2.12 mW/g

Deviation: 4.58%

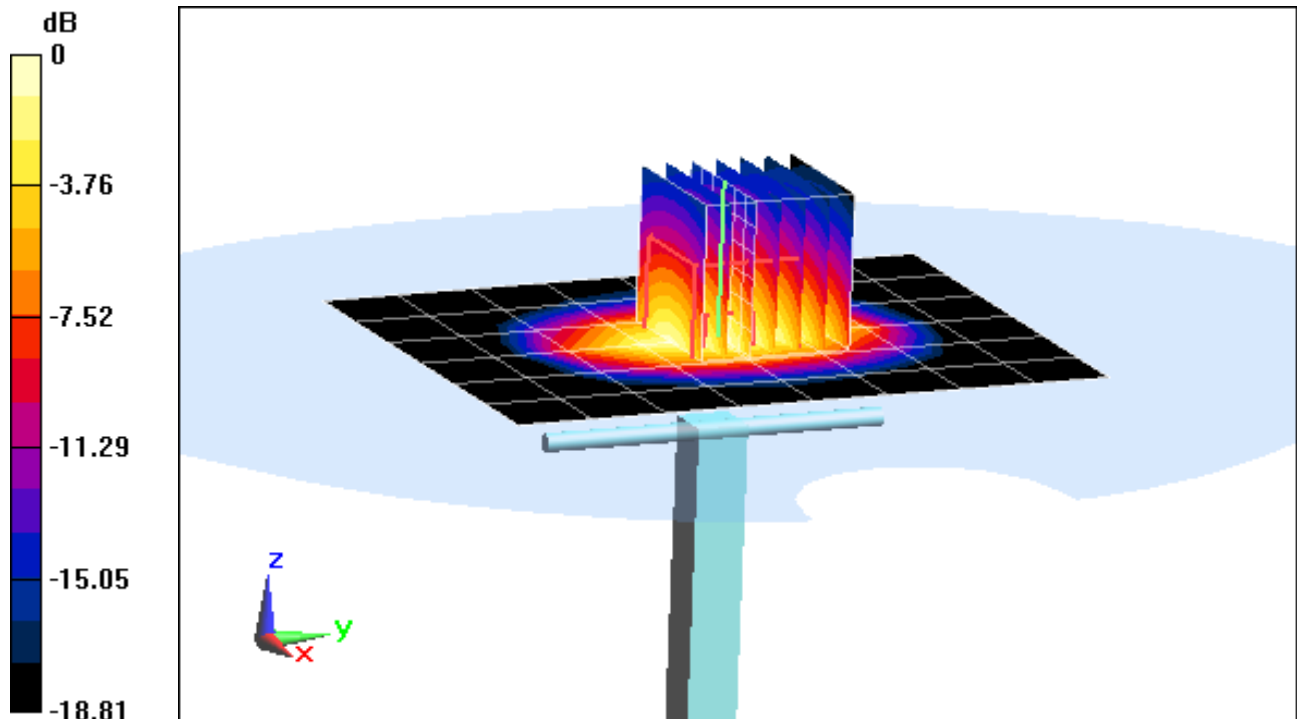

0 dB = 4.610mW/g = 13.27 dB mW/g

PCTEST ENGINEERING LABORATORY, INC.

DUT: SAR Dipole 1900 MHz; Type: D1900V2; Serial: 5d149

Communication System: CW; Frequency: 1900 MHz; Duty Cycle: 1:1

Medium: 1900 Head Medium parameters used (interpolated):

$f = 1900 \text{ MHz}$; $\sigma = 1.418 \text{ mho/m}$; $\epsilon_r = 38.503$; $\rho = 1000 \text{ kg/m}^3$

Phantom section: Flat Section; Space: 1.0 cm

Test Date: 07-30-2012; Ambient Temp: 21.1°C; Tissue Temp: 21.2°C

Probe: ES3DV3 - SN3287; ConvF(5.06, 5.06, 5.06); Calibrated: 2/7/2012

Sensor-Surface: 4mm (Mechanical Surface Detection)

Electronics: DAE4 Sn649; Calibrated: 2/20/2012

Phantom: SAM v5.0 Left; Type: QD000P40CD; Serial: TP: 1687

Measurement SW: DASY52, Version 52.8 (1); SEMCAD X Version 14.6.4 (4989)

1900 MHz System Verification

Area Scan (7x9x1): Measurement grid: dx=15mm, dy=15mm

Zoom Scan (7x7x7)/Cube 0: Measurement grid: dx=5mm, dy=5mm, dz=5mm

Input Power = 20 dBm (100mW)

SAR(1 g) = 4.11 mW/g; SAR(10 g) = 2.12 mW/g

Deviation: 4.58%

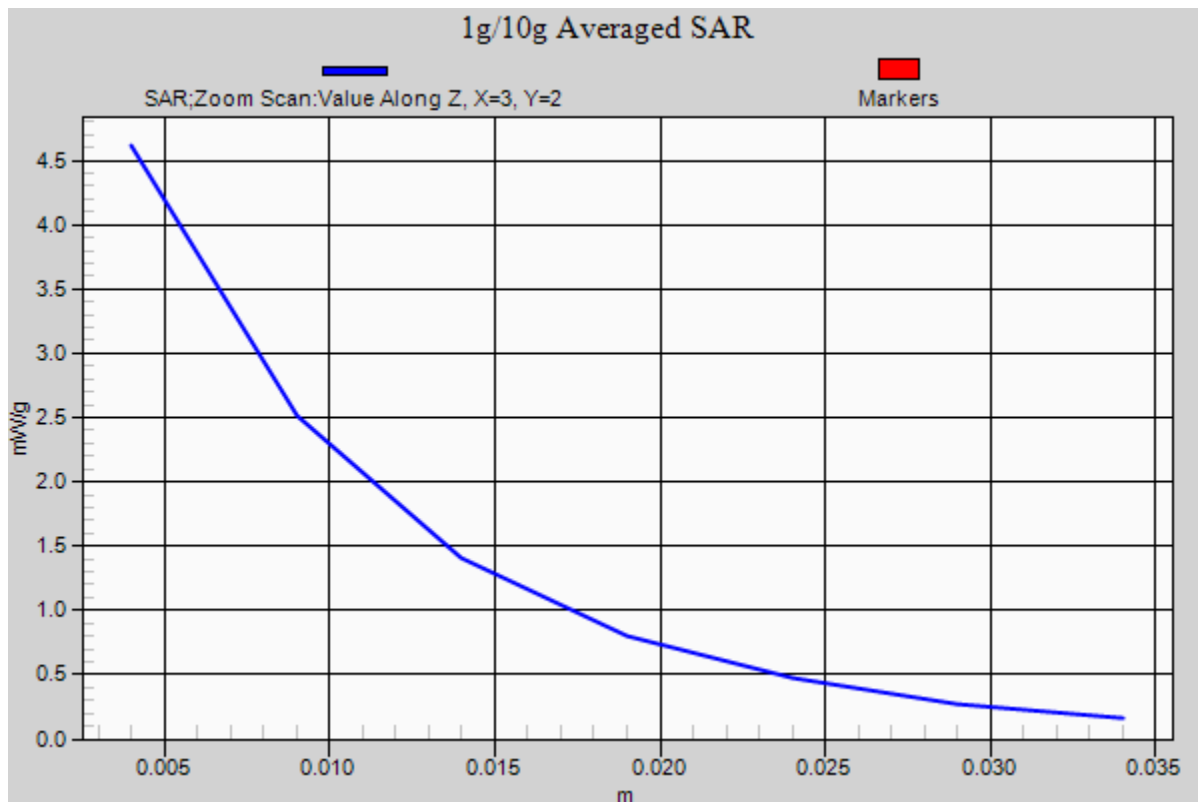

PCTEST ENGINEERING LABORATORY, INC.

DUT: SAR Dipole 2450 MHz; Type: D2450V2; Serial: 797

Communication System: CW; Frequency: 2450 MHz; Duty Cycle: 1:1

Medium: 2450 Head Medium parameters used:

$f = 2450 \text{ MHz}$; $\sigma = 1.864 \text{ mho/m}$; $\epsilon_r = 37.72$; $\rho = 1000 \text{ kg/m}^3$

Phantom section: Flat Section; Space: 1.0 cm

Test Date: 08-01-2012; Ambient Temp: 22.3°C; Tissue Temp: 23.1°C

Probe: ES3DV2 - SN3022; ConvF(4.3, 4.3, 4.3); Calibrated: 8/25/2011

Sensor-Surface: 3mm (Mechanical Surface Detection)

Electronics: DAE4 Sn665; Calibrated: 4/19/2012

Phantom: SAM with CRP; Type: SAM; Serial: TP1375

Measurement SW: DASY4, Version 4.7 (80); SEMCAD X Version 14.6.4 (4989)

2450MHz System Verification

Area Scan (6x8x1): Measurement grid: dx=12mm, dy=12mm

Zoom Scan (7x7x7)/Cube 0: Measurement grid: dx=5mm, dy=5mm, dz=5mm

Input Power = 10 dBm (10 mW)

SAR(1 g) = 0.540 mW/g; SAR(10 g) = 0.250 mW/g

Deviation = 3.65%

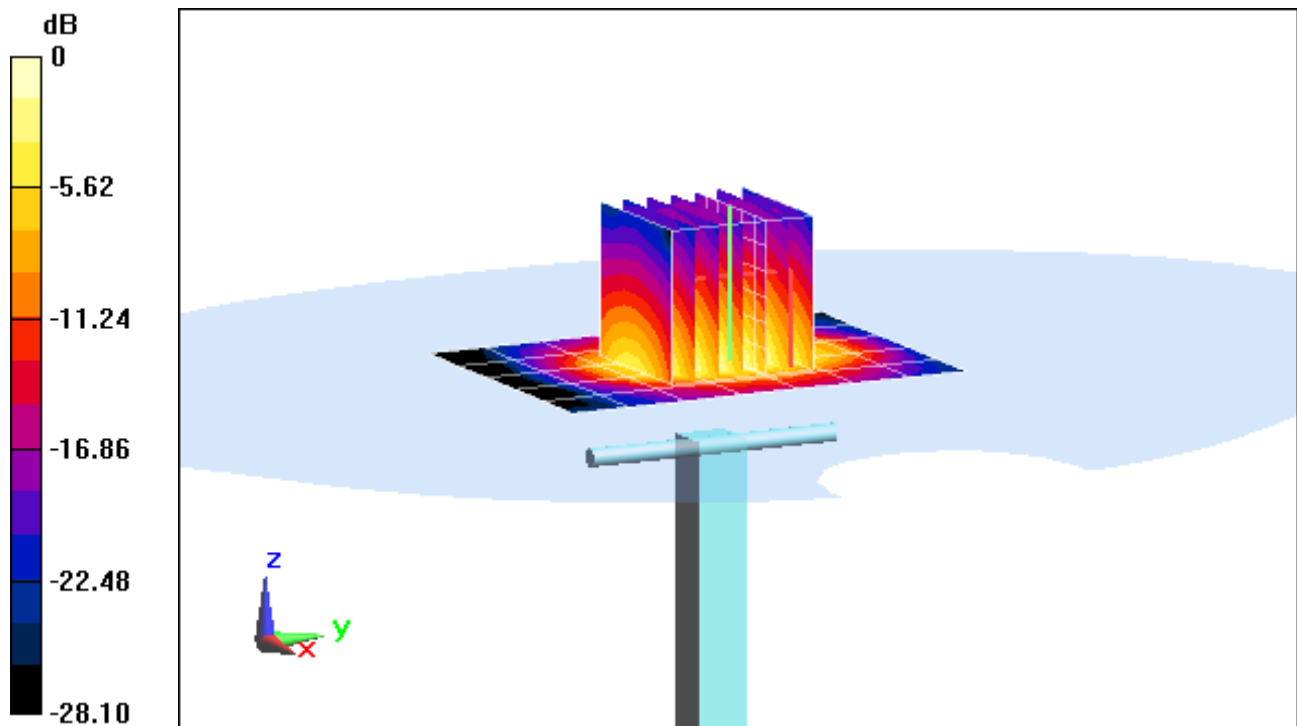

0 dB = 0.700mW/g = -3.10 dB mW/g

PCTEST ENGINEERING LABORATORY, INC.

DUT: SAR Dipole 2450 MHz; Type: D2450V2; Serial: 797

Communication System: CW; Frequency: 2450 MHz; Duty Cycle: 1:1

Medium: 2450 Head Medium parameters used:

$f = 2450 \text{ MHz}$; $\sigma = 1.864 \text{ mho/m}$; $\epsilon_r = 37.72$; $\rho = 1000 \text{ kg/m}^3$

Phantom section: Flat Section; Space: 1.0 cm

Test Date: 08-01-2012; Ambient Temp: 22.3°C; Tissue Temp: 23.1°C

Probe: ES3DV2 - SN3022; ConvF(4.3, 4.3, 4.3); Calibrated: 8/25/2011

Sensor-Surface: 3mm (Mechanical Surface Detection)

Electronics: DAE4 Sn665; Calibrated: 4/19/2012

Phantom: SAM with CRP; Type: SAM; Serial: TP1375

Measurement SW: DASY4, Version 4.7 (80); SEMCAD X Version 14.6.4 (4989)

2450MHz System Verification

Area Scan (6x8x1): Measurement grid: dx=12mm, dy=12mm

Zoom Scan (7x7x7)/Cube 0: Measurement grid: dx=5mm, dy=5mm, dz=5mm

Input Power = 10 dBm (10 mW)

SAR(1 g) = 0.540 mW/g; SAR(10 g) = 0.250 mW/g

Deviation = 3.65%

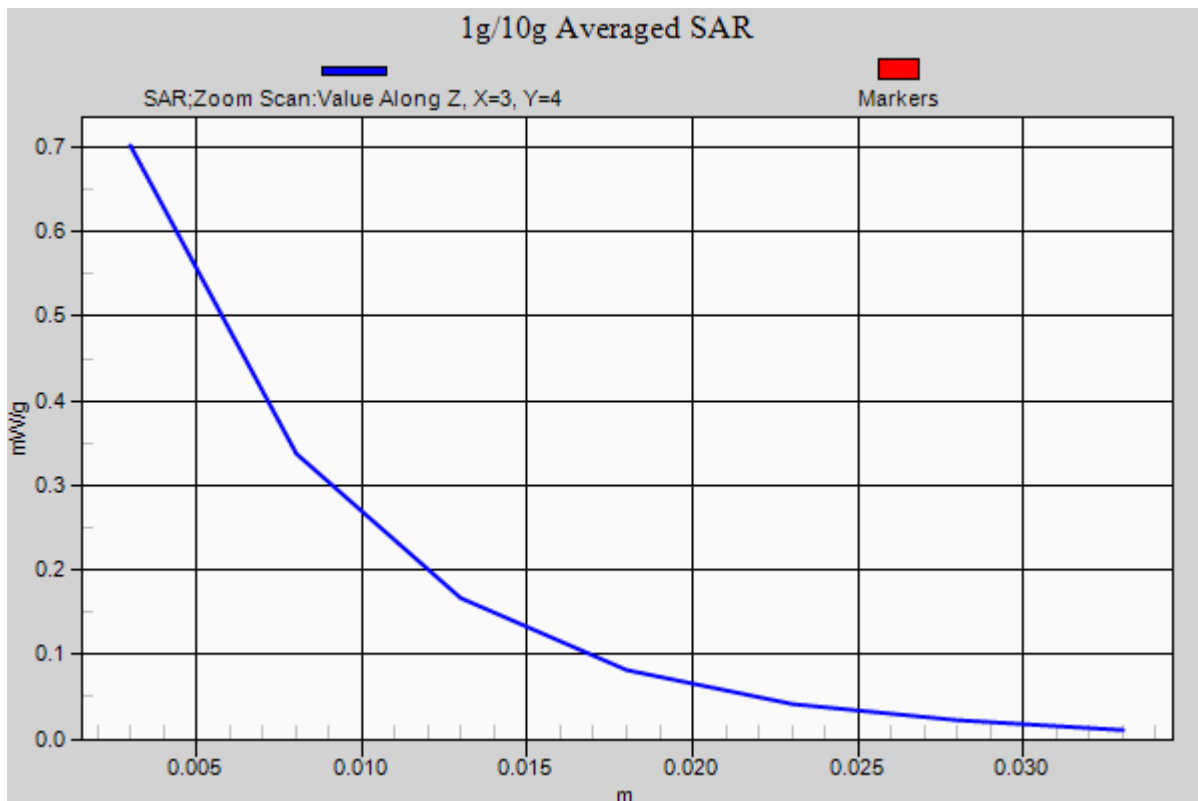

PCTEST ENGINEERING LABORATORY, INC.

DUT: Dipole 835 MHz; Type: D835V2; Serial: 4d119

Communication System: CW; Frequency: 835 MHz; Duty Cycle: 1:1

Medium: 835 Body Medium parameters used:

$f = 835 \text{ MHz}$; $\sigma = 0.978 \text{ mho/m}$; $\epsilon_r = 55.34$; $\rho = 1000 \text{ kg/m}^3$

Phantom section: Flat Section; Space: 1.5 cm

Test Date: 07-27-2012; Ambient Temp: 24.4°C; Tissue Temp: 23.8°C

Probe: ES3DV3 - SN3258; ConvF(6.06, 6.06, 6.06); Calibrated: 2/21/2012

Sensor-Surface: 4mm (Mechanical Surface Detection)

Electronics: DAE4 Sn1272; Calibrated: 1/18/2012

Phantom: SAM Main; Type: SAM 4.0; Serial: TP-1406

Measurement SW: DASY4, Version 4.7 (80); SEMCAD X Version 14.6.4 (4989)

835MHz System Verification

Area Scan (7x13x1): Measurement grid: dx=15mm, dy=15mm

Zoom Scan (5x5x7)/Cube 0: Measurement grid: dx=8mm, dy=8mm, dz=5mm

Input Power = 20 dBm (100 mw)

SAR(1 g) = 0.986 mW/g; SAR(10 g) = 0.652 mW/g

Deviation = 3.14%

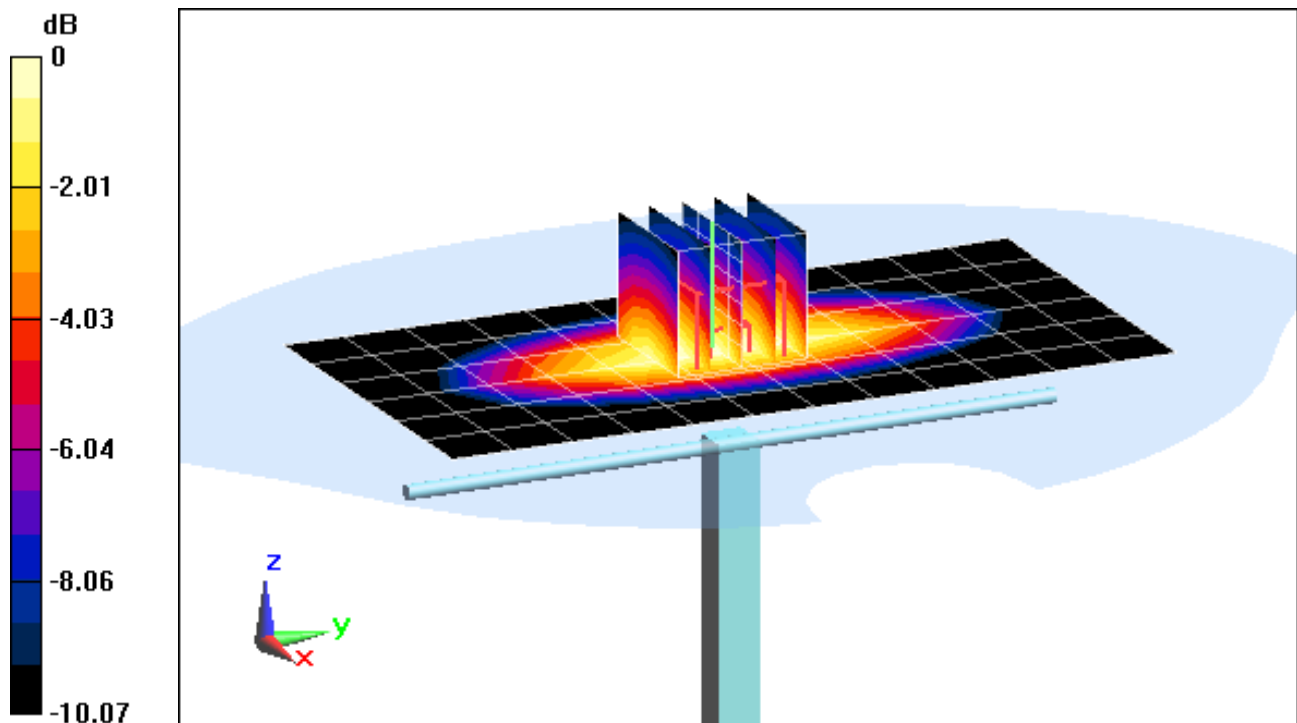

0 dB = 1.070mW/g = 0.59 dB mW/g

PCTEST ENGINEERING LABORATORY, INC.

DUT: Dipole 835 MHz; Type: D835V2; Serial: 4d119

Communication System: CW; Frequency: 835 MHz; Duty Cycle: 1:1

Medium: 835 Body Medium parameters used:

$f = 835 \text{ MHz}$; $\sigma = 0.978 \text{ mho/m}$; $\epsilon_r = 55.34$; $\rho = 1000 \text{ kg/m}^3$

Phantom section: Flat Section; Space: 1.5 cm

Test Date: 07-27-2012; Ambient Temp: 24.4°C; Tissue Temp: 23.8°C

Probe: ES3DV3 - SN3258; ConvF(6.06, 6.06, 6.06); Calibrated: 2/21/2012

Sensor-Surface: 4mm (Mechanical Surface Detection)

Electronics: DAE4 Sn1272; Calibrated: 1/18/2012

Phantom: SAM Main; Type: SAM 4.0; Serial: TP-1406

Measurement SW: DASY4, Version 4.7 (80); SEMCAD X Version 14.6.4 (4989)

835MHz System Verification

Area Scan (7x13x1): Measurement grid: dx=15mm, dy=15mm

Zoom Scan (5x5x7)/Cube 0: Measurement grid: dx=8mm, dy=8mm, dz=5mm

Input Power = 20 dBm (100 mw)

SAR(1 g) = 0.986 mW/g; SAR(10 g) = 0.652 mW/g

Deviation = 3.14%

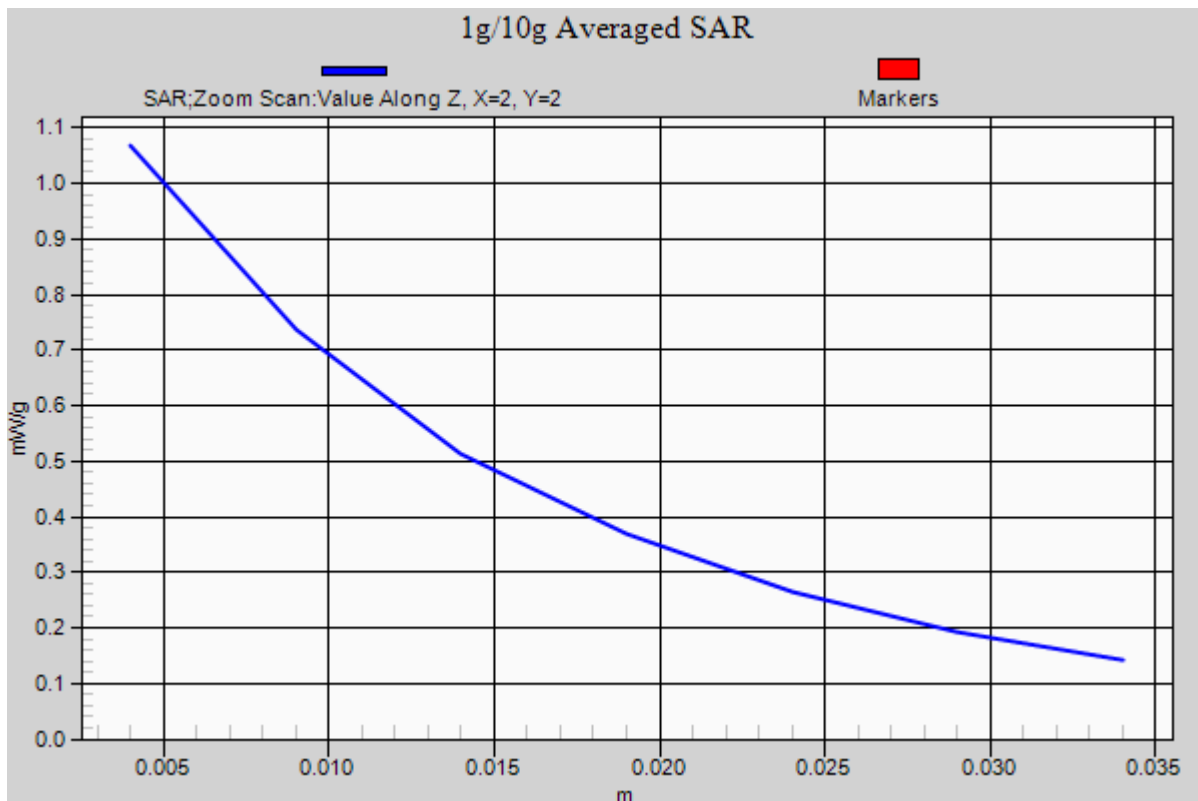

PCTEST ENGINEERING LABORATORY, INC.

DUT: Dipole 835 MHz; Type: D835V2; Serial: 4d119

Communication System: CW; Frequency: 835 MHz; Duty Cycle: 1:1

Medium: 835 Body Medium parameters used:

$f = 835 \text{ MHz}$; $\sigma = 0.971 \text{ mho/m}$; $\epsilon_r = 54.86$; $\rho = 1000 \text{ kg/m}^3$

Phantom section: Flat Section; Space: 1.5 cm

Test Date: 07-30-2012; Ambient Temp: 24.1°C; Tissue Temp: 23.4°C

Probe: ES3DV3 - SN3258; ConvF(6.06, 6.06, 6.06); Calibrated: 2/21/2012

Sensor-Surface: 4mm (Mechanical Surface Detection)

Electronics: DAE4 Sn1272; Calibrated: 1/18/2012

Phantom: SAM Main; Type: SAM 4.0; Serial: TP-1406

Measurement SW: DASY4, Version 4.7 (80); SEMCAD X Version 14.6.4 (4989)

835MHz System Verification

Area Scan (7x13x1): Measurement grid: dx=15mm, dy=15mm

Zoom Scan (5x5x7)/Cube 0: Measurement grid: dx=8mm, dy=8mm, dz=5mm

Input Power = 20 dBm (100 mW)

SAR(1 g) = 0.974 mW/g; SAR(10 g) = 0.642 mW/g

Deviation = 1.88%

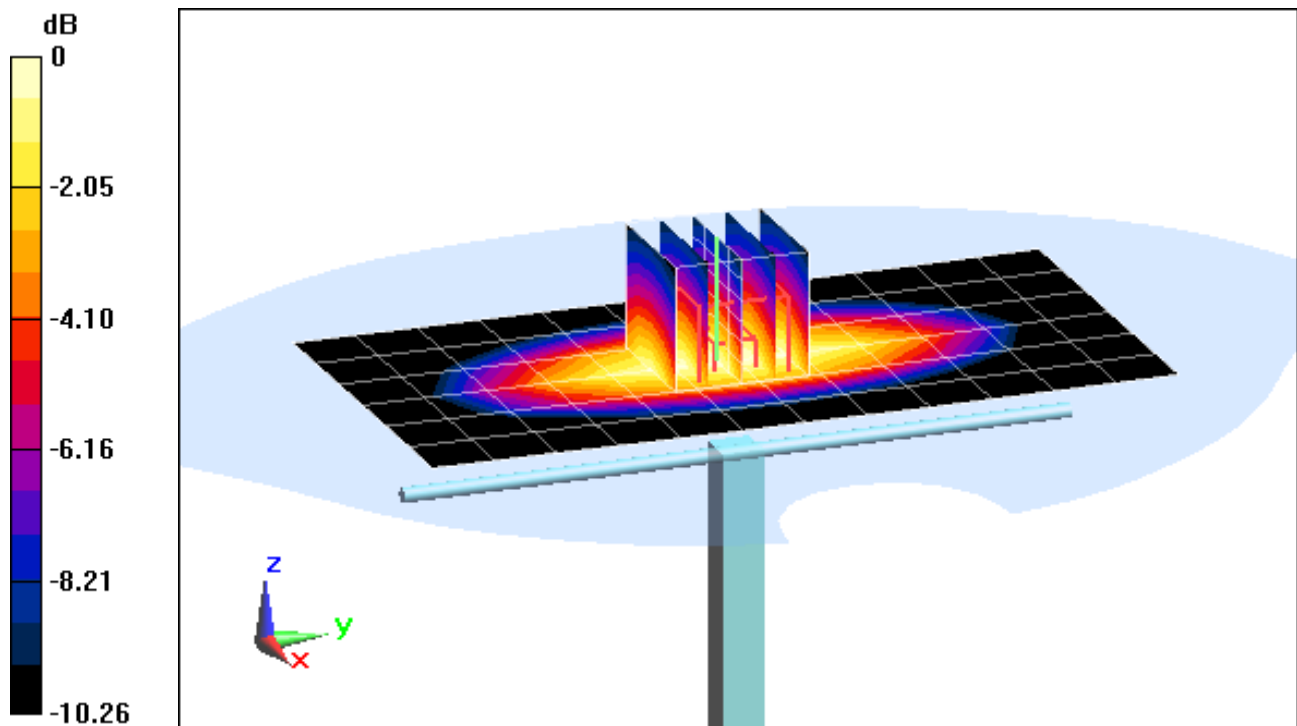

0 dB = 1.050mW/g = 0.42 dB mW/g

PCTEST ENGINEERING LABORATORY, INC.

DUT: Dipole 835 MHz; Type: D835V2; Serial: 4d119

Communication System: CW; Frequency: 835 MHz; Duty Cycle: 1:1

Medium: 835 Body Medium parameters used:

$f = 835 \text{ MHz}$; $\sigma = 0.971 \text{ mho/m}$; $\epsilon_r = 54.86$; $\rho = 1000 \text{ kg/m}^3$

Phantom section: Flat Section; Space: 1.5 cm

Test Date: 07-30-2012; Ambient Temp: 24.1°C; Tissue Temp: 23.4°C

Probe: ES3DV3 - SN3258; ConvF(6.06, 6.06, 6.06); Calibrated: 2/21/2012

Sensor-Surface: 4mm (Mechanical Surface Detection)

Electronics: DAE4 Sn1272; Calibrated: 1/18/2012

Phantom: SAM Main; Type: SAM 4.0; Serial: TP-1406

Measurement SW: DASY4, Version 4.7 (80); SEMCAD X Version 14.6.4 (4989)

835MHz System Verification

Area Scan (7x13x1): Measurement grid: dx=15mm, dy=15mm

Zoom Scan (5x5x7)/Cube 0: Measurement grid: dx=8mm, dy=8mm, dz=5mm

Input Power = 20 dBm (100 mW)

SAR(1 g) = 0.974 mW/g; SAR(10 g) = 0.642 mW/g

Deviation = 1.88%

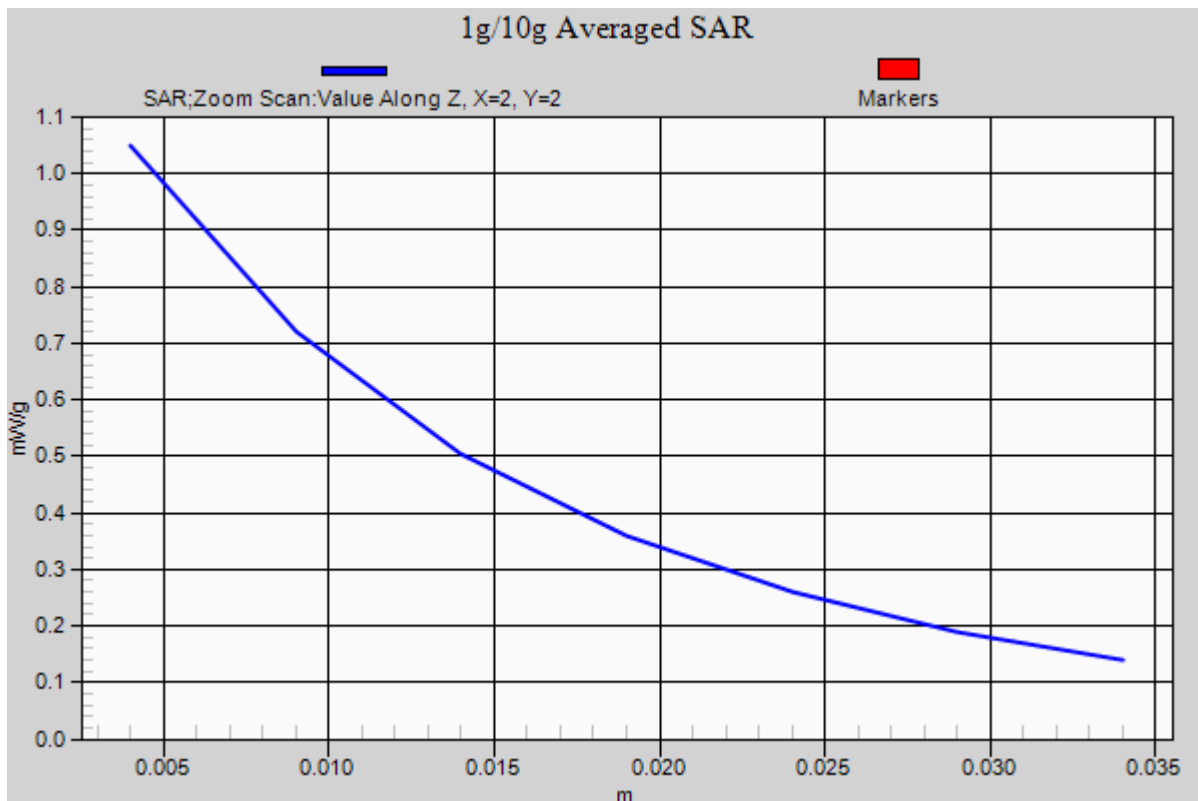

PCTEST ENGINEERING LABORATORY, INC.

DUT: SAR Dipole 1900 MHz; Type: D1900V2; Serial: 5d149

Communication System: CW; Frequency: 1900 MHz; Duty Cycle: 1:1

Medium: 1900 Body Medium parameters used (interpolated):

$f = 1900 \text{ MHz}$; $\sigma = 1.567 \text{ mho/m}$; $\epsilon_r = 51.787$; $\rho = 1000 \text{ kg/m}^3$

Phantom section: Flat Section; Space: 1.0 cm

Test Date: 07-31-2012; Ambient Temp: 21.9°C; Tissue Temp: 21.1°C

Probe: ES3DV3 - SN3287; ConvF(4.76, 4.76, 4.76); Calibrated: 2/7/2012

Sensor-Surface: 4mm (Mechanical Surface Detection)

Electronics: DAE4 Sn649; Calibrated: 2/20/2012

Phantom: SAM v5.0 front; Type: QD000P40CD; Serial: TP-1646

Measurement SW: DASY52, Version 52.8 (1); SEMCAD X Version 14.6.4 (4989)

1900 MHz System Verification

Area Scan (7x9x1): Measurement grid: dx=15mm, dy=15mm

Zoom Scan (5x5x7)/Cube 0: Measurement grid: dx=8mm, dy=8mm, dz=5mm

Input Power = 20 dBm (100 mW)

SAR(1 g) = 4.13 mW/g; SAR(10 g) = 2.14 mW/g

Deviation = 5.09%

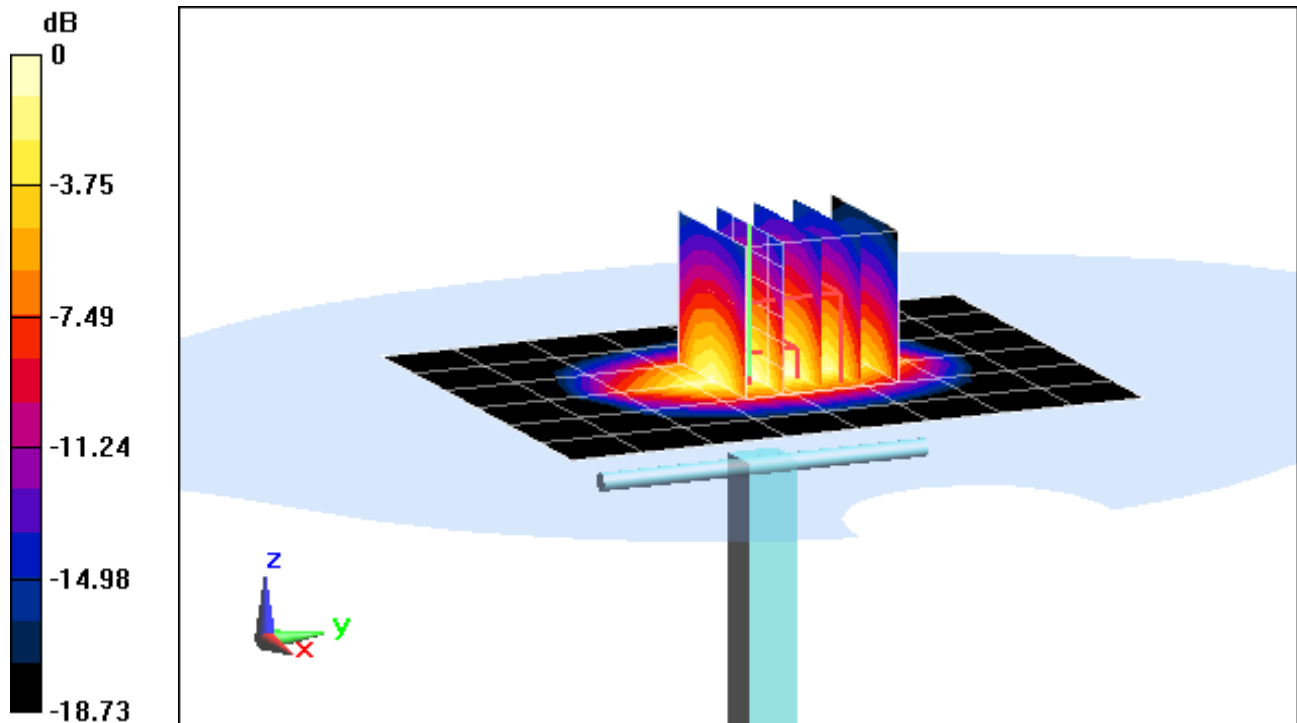

0 dB = 4.620mW/g = 13.29 dB mW/g

PCTEST ENGINEERING LABORATORY, INC.

DUT: SAR Dipole 1900 MHz; Type: D1900V2; Serial: 5d149

Communication System: CW; Frequency: 1900 MHz; Duty Cycle: 1:1

Medium: 1900 Body Medium parameters used (interpolated):

$f = 1900 \text{ MHz}$; $\sigma = 1.567 \text{ mho/m}$; $\epsilon_r = 51.787$; $\rho = 1000 \text{ kg/m}^3$

Phantom section: Flat Section; $U_{\text{r ceg}} < 1.0 \text{ cm}$

Test Date: 07-31-2012; Ambient Temp: 21.9°C; Tissue Temp: 21.1°C

Probe: ES3DV3 - SN3287; ConvF(4.76, 4.76, 4.76); Calibrated: 2/7/2012

Sensor-Surface: 4mm (Mechanical Surface Detection)

Electronics: DAE4 Sn649; Calibrated: 2/20/2012

Phantom: SAM v5.0 front; Type: QD000P40CD; Serial: TP-1646

Measurement SW: DASY52, Version 52.8 (1); SEMCAD X Version 14.6.4 (4989)

1900 MHz System Verification

Area Scan (7x9x1): Measurement grid: dx=15mm, dy=15mm

Zoom Scan (5x5x7)/Cube 0: Measurement grid: dx=8mm, dy=8mm, dz=5mm

Input Power = 20 dBm (100 mW)

SAR(1 g) = 4.13 mW/g; SAR(10 g) = 2.14 mW/g

Deviation = 5.09%

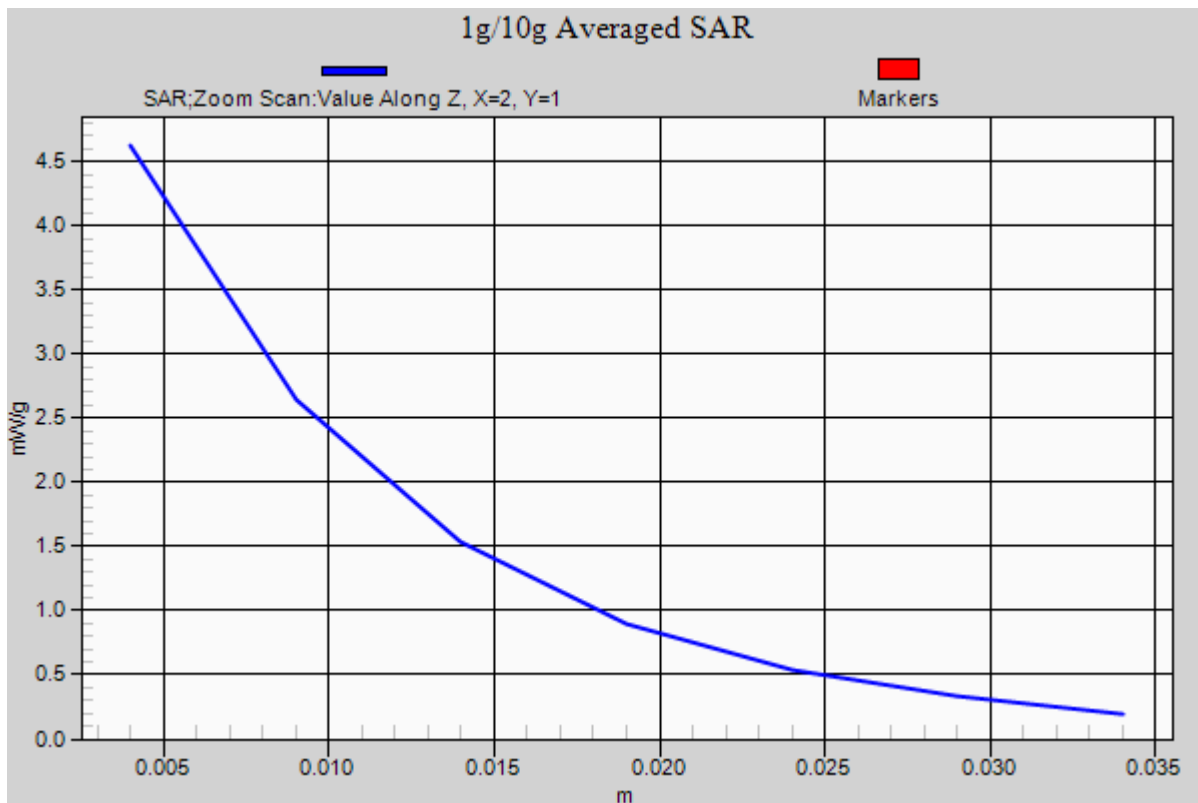

PCTEST ENGINEERING LABORATORY, INC.

DUT: SAR Dipole 2450 MHz; Type: D2450V2; Serial: 797

Communication System: CW; Frequency: 2450 MHz; Duty Cycle: 1:1

Medium: 2450 Body Medium parameters used:

$f = 2450$ MHz; $\sigma = 2.046$ mho/m; $\epsilon_r = 53.46$; $\rho = 1000$ kg/m³

Phantom section: Flat Section; Space: 1.0 cm

Test Date: 08-01-2012; Ambient Temp: 23.4°C; Tissue Temp: 23.0°C

Probe: ES3DV2 - SN3022; ConvF(4.01, 4.01, 4.01); Calibrated: 8/25/2011

Sensor-Surface: 3mm (Mechanical Surface Detection)

Electronics: DAE4 Sn665; Calibrated: 4/19/2012

Phantom: SAM Sub Dasy B; Type: SAM 5.0; Serial: TP-1626

Measurement SW: DASY4, Version 4.7 (80); SEMCAD X Version 14.6.4 (4989)

4672 MHz System Verification

Area Scan (6x8x1): Measurement grid: dx=12mm, dy=12mm

Zoom Scan (7x7x7)/Cube 0: Measurement grid: dx=5mm, dy=5mm, dz=5mm

Input Power = 10 dBm (10 mW)

SAR(1 g) = 0.493 mW/g; SAR(10 g) = 0.232 mW/g

Deviation = -2.95%

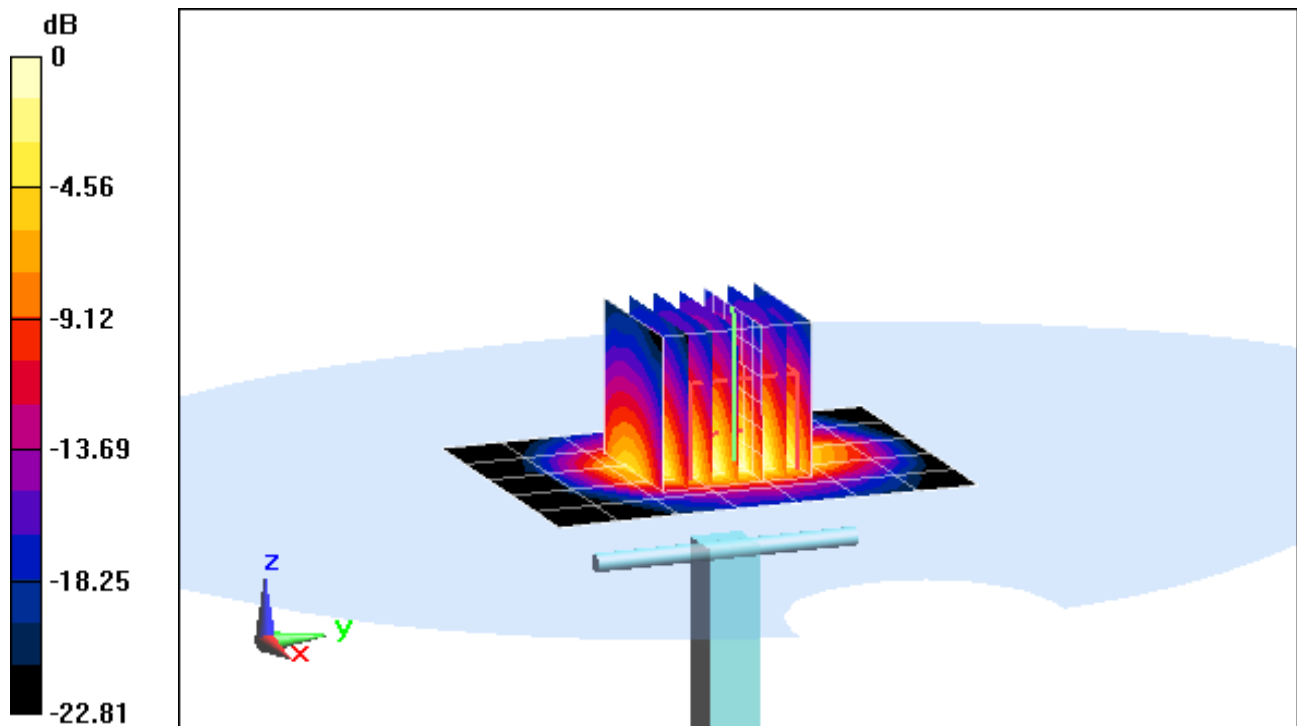

0 dB = 0.630mW/g = -4.01 dB mW/g

PCTEST ENGINEERING LABORATORY, INC.

DUT: SAR Dipole 2450 MHz; Type: D2450V2; Serial: 797

Communication System: CW; Frequency: 2450 MHz; Duty Cycle: 1:1

Medium: 2450 Body Medium parameters used:

$f = 2450 \text{ MHz}$; $\sigma = 2.046 \text{ mho/m}$; $\epsilon_r = 53.46$; $\rho = 1000 \text{ kg/m}^3$

Phantom section: Flat Section; Space: 1.0 cm

Test Date: 08-01-2012; Ambient Temp: 23.4°C; Tissue Temp: 23.0°C

Probe: ES3DV2 - SN3022; ConvF(4.01, 4.01, 4.01); Calibrated: 8/25/2011

Sensor-Surface: 3mm (Mechanical Surface Detection)

Electronics: DAE4 Sn665; Calibrated: 4/19/2012

Phantom: SAM Sub Dasy B; Type: SAM 5.0; Serial: TP-1626

Measurement SW: DASY4, Version 4.7 (80); SEMCAD X Version 14.6.4 (4989)

4672 MHz System Verification

Area Scan (6x8x1): Measurement grid: dx=12mm, dy=12mm

Zoom Scan (7x7x7)/Cube 0: Measurement grid: dx=5mm, dy=5mm, dz=5mm

Input Power = 10 dBm (10 mW)

SAR(1 g) = 0.493 mW/g; SAR(10 g) = 0.232 mW/g

Deviation = -2.95%

