

# ANTENNA INFORMATION

OEM	Dell Inc.
ODM	Wistron
Platform model name	P186G
Intel platform (ex: Yes, No or NA)	Yes
Platform type (ex: regular NB, convertible PC, AIO...etc)	Convertible PC
SAR minimum separation (mm)	NB:3.393 TB:1.8

Antenna manufacturer	Hong Bo Co., Ltd.	
Address	4F., No.143, Sinhu 1st Rd., Neihu Dist., Taipei City, 11494 Taiwan	
Antenna Part number	Main Antenna P/N: 260-29169	Aux Antenna P/N: 260-29168
Antenna type (ex: PIFA, Dipole...etc)	PIFA	

Antenna Peak gain w/ cable loss (dBi)* - NB Mode										
	2.4GHz 2400-2483.5 MHz	5.2GHz 5150-5250MHz	5.3GHz 5250-5350MHz	5.6GHz 5470-5725MHz	5.8GHz 5725-5850MHz	5.9GHz 5850-5895MHz	6.2GHz 5925-6425MHz	6.5GHz 6425-6525MHz	6.7GHz 6525-6875MHz	7.0 GHz 6875-7125MHz
Main	0.25	3.23	3.23	4.16	2.71	2.9	3.99	4.13	4.93	1.86
Aux	0.72	2.58	2.58	1.96	1.56	1.39	3.74	3.21	4.63	3.56
Antenna Peak gain w/ cable loss (dBi)* - Tablet Mode										
	2.4GHz 2400-2483.5 MHz	5.2GHz 5150-5250MHz	5.3GHz 5250-5350MHz	5.6GHz 5470-5725MHz	5.8GHz 5725-5850MHz	5.9GHz 5850-5895MHz	6.2GHz 5925-6425MHz	6.5GHz 6425-6525MHz	6.7GHz 6525-6875MHz	7.0 GHz 6875-7125MHz
Main	-1.18	-1.11	1.21	1.03	1.65	1.62	-0.1	-0.87	-0.84	-1.72
Aux	-0.59	-0.14	0.72	2.38	2.75	2.29	1.68	1.14	2.35	2.07

Cable Assembly Part Number and Information					
	Cable PN	Cable length(mm)	Cable diameter(mm)	Impedance(ohm)	Connector type
Main	SY113L/50-143	231	1.13 SLLS	50	IPEX(20565-001R-13) 康碩(MHF-B13L-N-01)
Aux	SY113L/50-118	193.5	1.13 SLLS	50	IPEX(20565-001R-13) 康碩(MHF-B13L-N-01)

\* 3D Antenna Peak Gain required being test in system basis.

# Table of Contents

<b>Cover page</b> .....	<b>1</b>
<b>1. Intel Reference Gain and Type</b> .....	<b>3</b>
<b>2. Document Revision History</b> .....	<b>3</b>
<b>3. Test &amp; System Description</b>	
3.1 Measurement Method and System.....	4
3.2 Test setup.....	4
3.3 Equipment list.....	4
<b>4. Radiation characteristics of antenna loaded in Host Platform</b> .....	<b>5</b>
<b>Annex A. Photographs</b>	
A.1 Setup Photo.....	11
A.2 Test sample.....	12
<b>Annex B. Antenna Location</b>	
B.1 Antenna Host Platform Location Information.....	15
B.2 Antenna dimensional information for SAR evaluation.....	17

## 1. Intel Reference Gain and Type

Antenna Peak gain w/ cable loss (dBi)											
Band/Frequency		2.4GHz 2400-2483.5 MHz	5.2GHz 5150-5250MHz	5.3GHz 5250-5350MHz	5.6GHz 5470-5725MHz	5.8GHz 5725-5850MHz	5.9GHz 5850-5895MHz	6.2GHz 5925-6425MHz	6.5GHz 6425-6525MHz	6.7GHz 6525-6875MHz	7.0 GHz 6875-7125MHz
Design	EU/UK	3.00	5.00	5.00	5.00	5.00	5.00	5.00	5.00	5.00	5.00
PIFA	For WiFi 6E and earlier	3.24	3.64	3.73	4.77	4.97	4.72	4.83	4.30	5.37	5.59
	For WiFi 7	2.95	5.11	4.55	5.15	5.13	4.45	5.02	5.02	4.96	4.96
Dipole	For WiFi 6E and earlier	2.89	2.92	3.19	4.41	4.22	4.22	4.83	4.30	4.49	5.34
	For WiFi 7	2.95	4.03	4.11	5.15	5.13	4.45	5.02	4.71	4.49	4.96

### 3D Peak Antenna gain should be equal or greater than -2 dBi

If a host integrator plans to use a lower gain antenna of the same type, additional CBP(FCC)/EDT(EU) testing need to be performed while the module is installed in the host.

## 2. Document Revision History

Revision #	Revision Details	Issued Date
Rev. 00	First Issue	2023.06.20

### 3. Test & System Description

#### 3.1 Measurement Method and System

<insert test description here for test method>

[example] This test report is prepared for host antenna testing under a Full Anechoic Chamber.

#### 3.2 Test setup

<insert test diagram here for test site utilized>

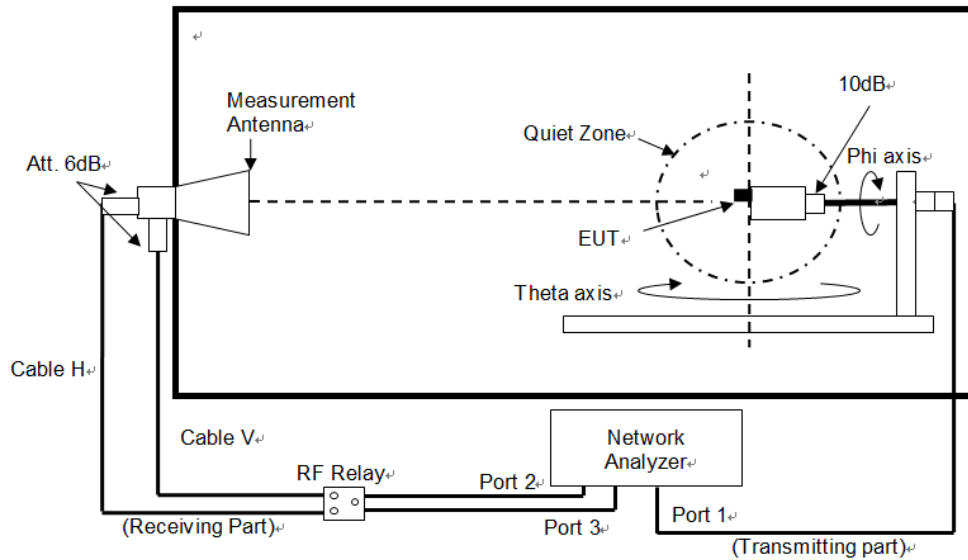

#### 3.3 Equipment list

<insert test diagram here for test site utilized>

Huaya-Sporton OTA03					
Name	Manufacturer	Type/Model	Serial Number	Calibration	
				Last Cal.	Due Date
ENA Series Network Analyzer	Keysight	E5080B	MY59101211	2022/5/23	2024/5/23
RF Switch	Keysight	3499A	MY42000955	NCR	NCR
Multi-Axis Positioner Controller	ETS-Lindgren	2090	N/A	NCR	NCR
Medium-Duty Positioner	ETS-Lindgren	2015	N/A	NCR	NCR
Measurement Horn Antenna	EMCO	3164-08	00086722	NCR	NCR
Anechoic chamber	ETS-Lindgren	AMS-8500	N/A	2022/1/6	2024/1/6
12GHz SMA(M)-SMA(M)+20core for 60cm RG316DS Cable Assembly	Woken Technology Inc.	RG316DS	N/A	N/A	N/A
12GHz SMA(M)-SMA(M)+30core for 300cm RG316DS Cable Assembly	Woken Technology Inc.	RG316DS	N/A	N/A	N/A

Note: Chamber calibration included full set of implement.

#### 4. Radiation characteristics of antenna loaded in Host Platform

##### Main Antenna- NB Mode

Max Antenna 3D Radiation Pattern 2400 – 2483.5 MHz

Frequency (MHz)	Peak Gain w/ Cable Loss (dBi)
2400-2483.5	0.25

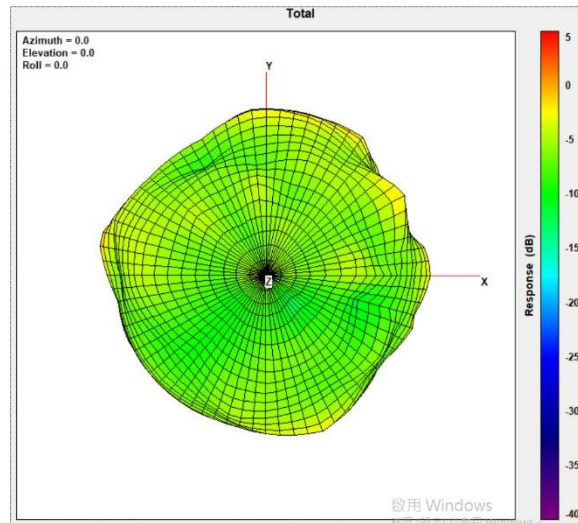

Max Antenna 3D Radiation Pattern 5150-5250 MHz

Frequency (MHz)	Peak Gain w/ Cable Loss (dBi)
5150-5250	3.23

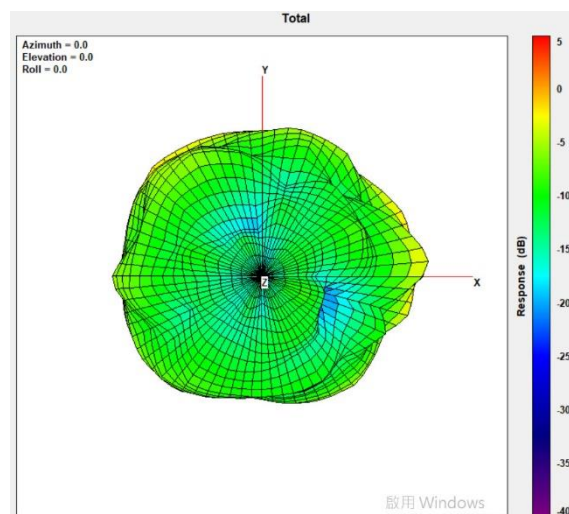

### Max Antenna 3D Radiation Pattern 5250-5350 MHz

Frequency (MHz)	Peak Gain w/ Cable Loss (dBi)
5250-5350	3.23

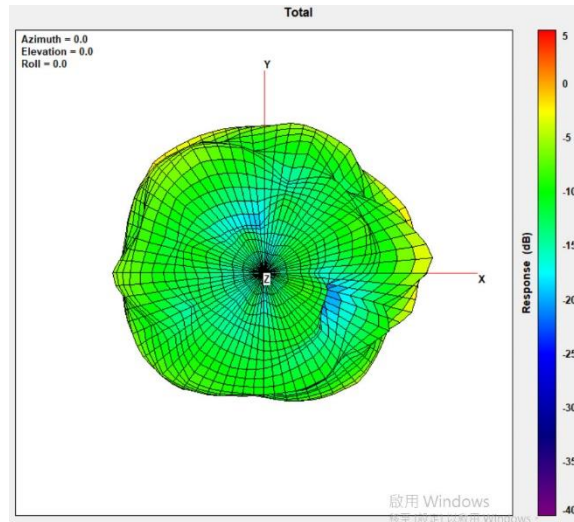

### Max Antenna 3D Radiation Pattern 5470-5725 MHz

Frequency (MHz)	Peak Gain w/ Cable Loss (dBi)
5470-5725	4.16

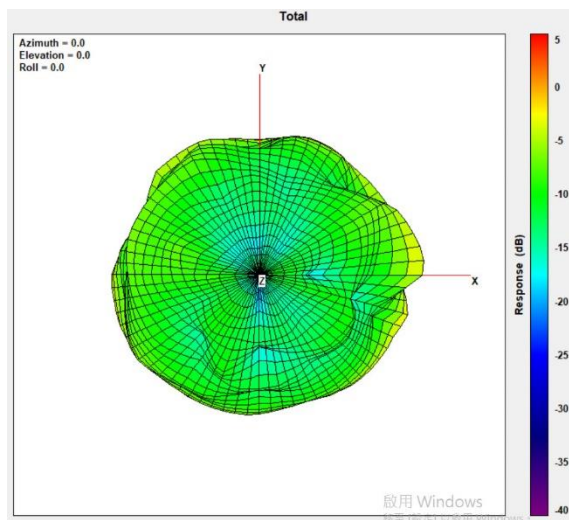

## Max Antenna 3D Radiation Pattern 5725-5850 MHz

Frequency (MHz)	Peak Gain w/ Cable Loss (dBi)
5725-5850	2.71

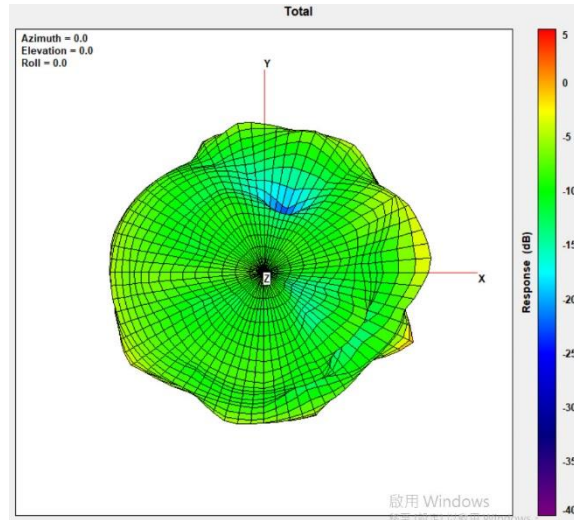

## Max Antenna 3D Radiation Pattern 5850-5895 MHz

Frequency (MHz)	Peak Gain w/ Cable Loss (dBi)
5850-5895	2.9

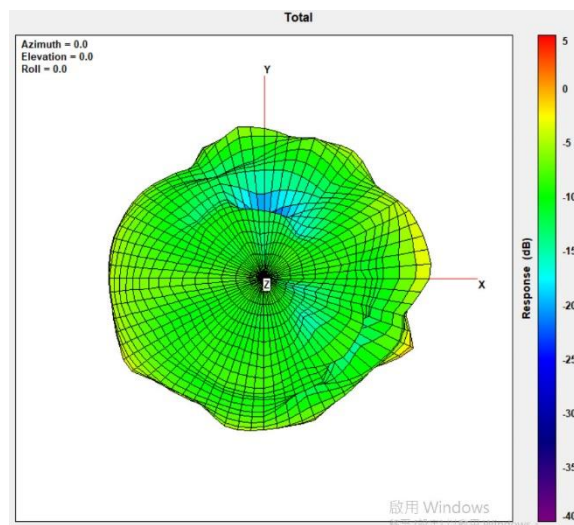

### Max Antenna 3D Radiation Pattern 5925-6425 MHz

Frequency (MHz)	Peak Gain w/ Cable Loss (dBi)
5850-5895	3.99

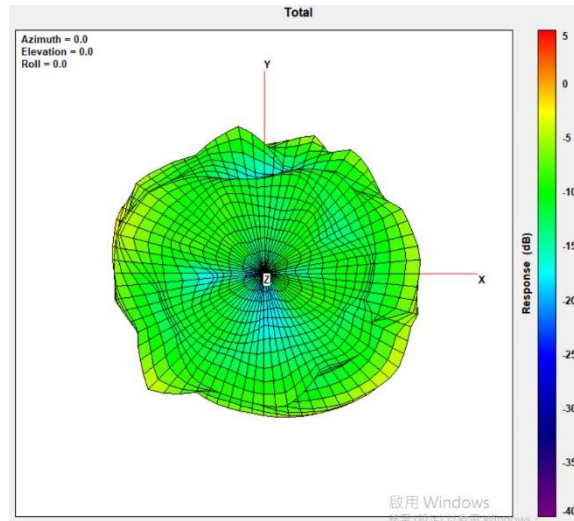

### Max Antenna 3D Radiation Pattern 6425-6525 MHz

Frequency (MHz)	Peak Gain w/ Cable Loss (dBi)
5850-5895	4.13

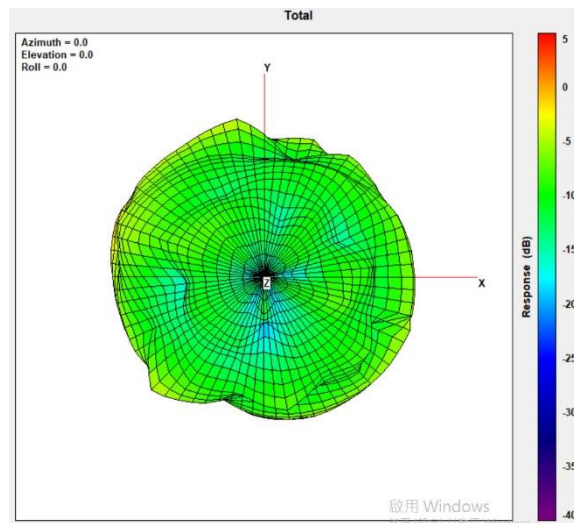



### Max Antenna 3D Radiation Pattern 6525-6875 MHz

Frequency (MHz)	Peak Gain w/ Cable Loss (dBi)
5850-5895	4.93

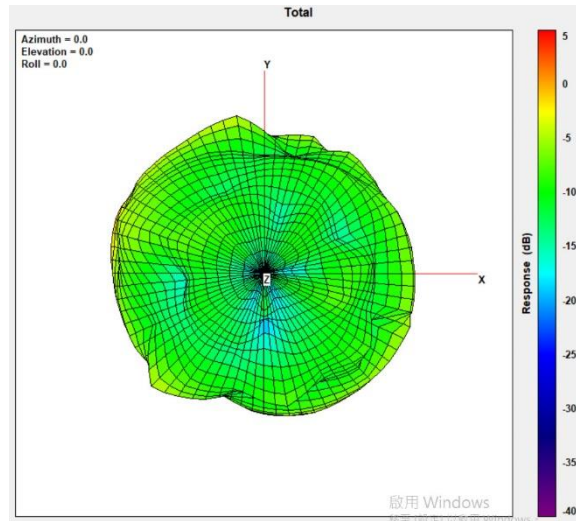

### Max Antenna 3D Radiation Pattern 6875-7125 MHz

Frequency (MHz)	Peak Gain w/ Cable Loss (dBi)
5850-5895	1.86

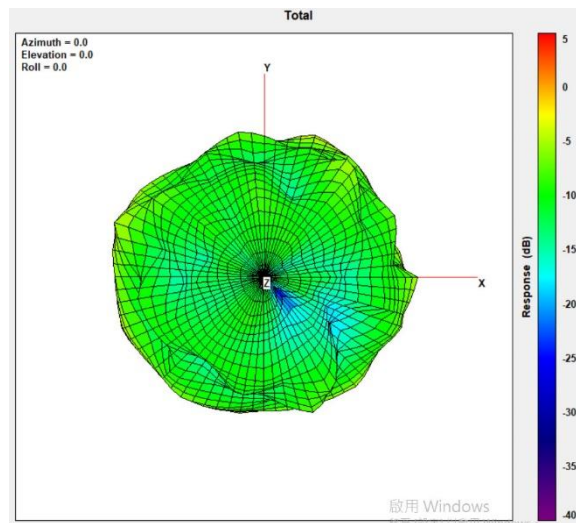

### Auxiliary Antenna- NB Mode

#### Max Antenna 3D Radiation Pattern 2400 – 2483.5 MHz

Frequency (MHz)	Peak Gain w/ Cable Loss (dBi)
2400-2483.5	0.72

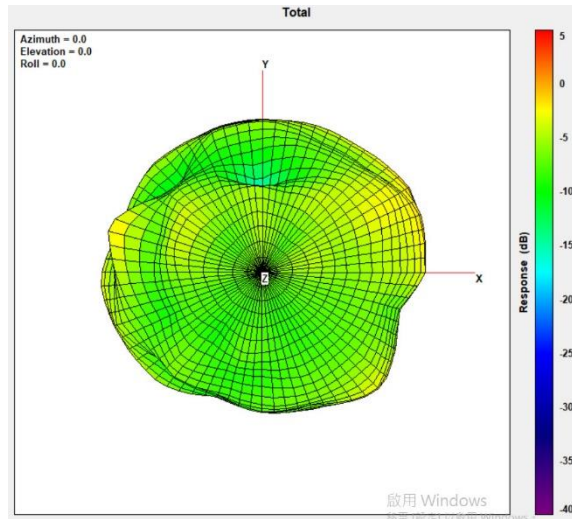

#### Max Antenna 3D Radiation Pattern 5150-5250 MHz

Frequency (MHz)	Peak Gain w/ Cable Loss (dBi)
5150-5250	2.58

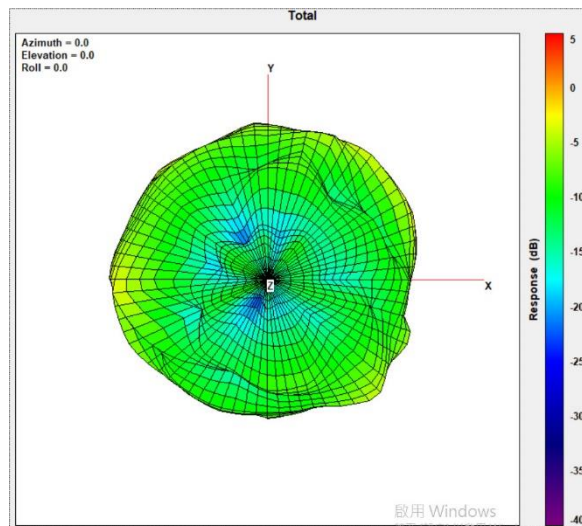

### Max Antenna 3D Radiation Pattern 5250-5350 MHz

Frequency (MHz)	Peak Gain w/ Cable Loss (dBi)
5150-5250	2.58

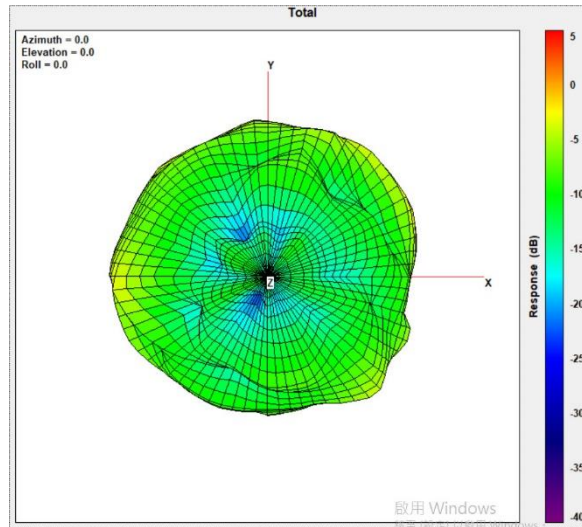

### Max Antenna 3D Radiation Pattern 5470-5725 MHz

Frequency (MHz)	Peak Gain w/ Cable Loss (dBi)
5470-5725	1.96

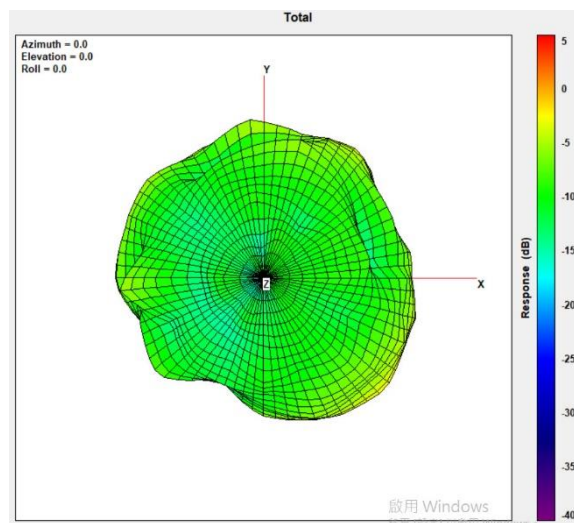

## Max Antenna 3D Radiation Pattern 5725-5850 MHz

Frequency (MHz)	Peak Gain w/ Cable Loss (dBi)
5725-5850	1.56

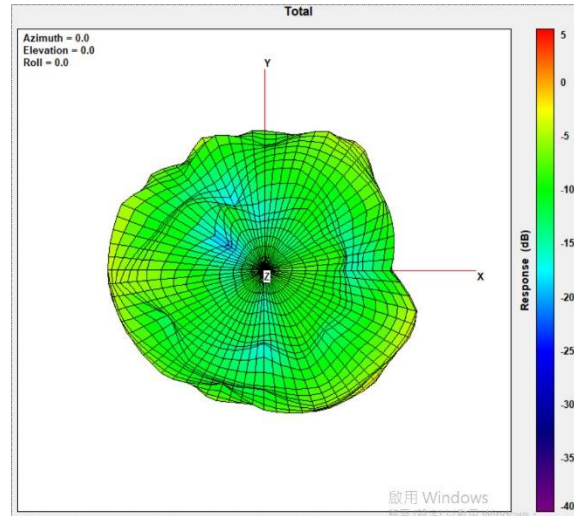

## Max Antenna 3D Radiation Pattern 5850-5895 MHz

Frequency (MHz)	Peak Gain w/ Cable Loss (dBi)
5850-5895	1.39

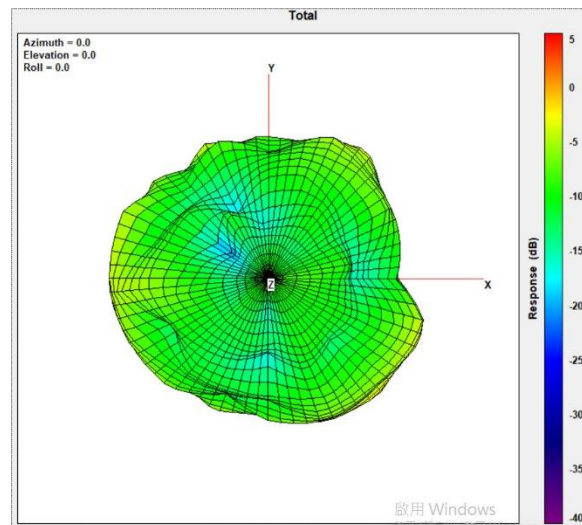

## Max Antenna 3D Radiation Pattern 5925-6425 MHz

Frequency (MHz)	Peak Gain w/ Cable Loss (dBi)
5850-5895	3.74

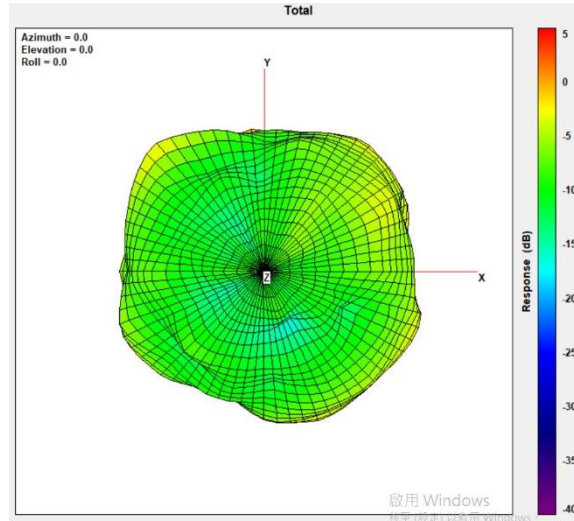

## Max Antenna 3D Radiation Pattern 6425-6525 MHz

Frequency (MHz)	Peak Gain w/ Cable Loss (dBi)
5850-5895	3.21

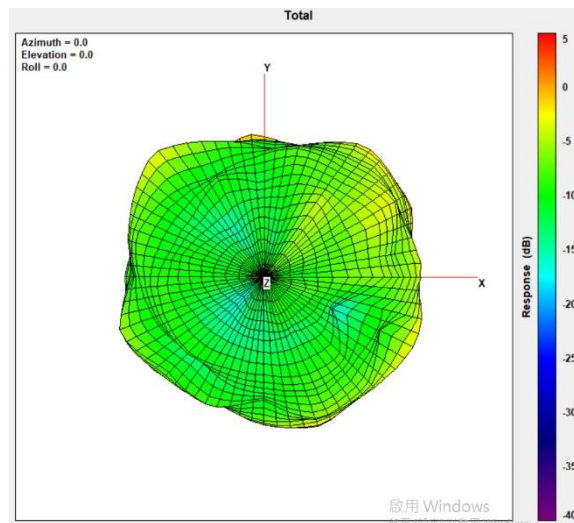

### Max Antenna 3D Radiation Pattern 6525-6875 MHz

Frequency (MHz)	Peak Gain w/ Cable Loss (dBi)
5850-5895	4.63

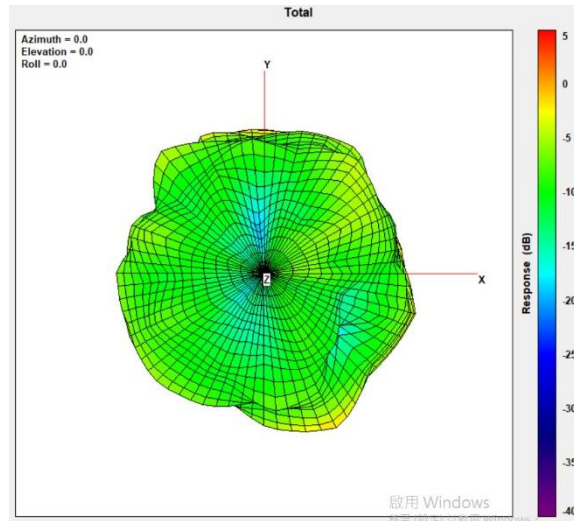

### Max Antenna 3D Radiation Pattern 6875-7125 MHz

Frequency (MHz)	Peak Gain w/ Cable Loss (dBi)
5850-5895	3.56

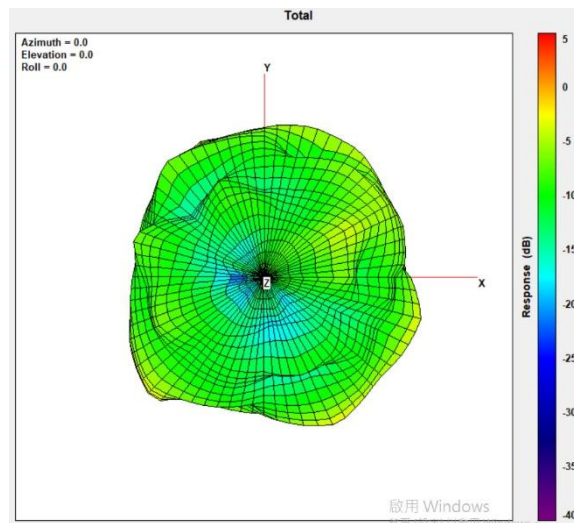

### Main Antenna – Tablet Mode

#### Max Antenna 3D Radiation Pattern 2400 – 2483.5 MHz

Frequency (MHz)	Peak Gain w/ Cable Loss (dBi)
2400-2483.5	-1.18

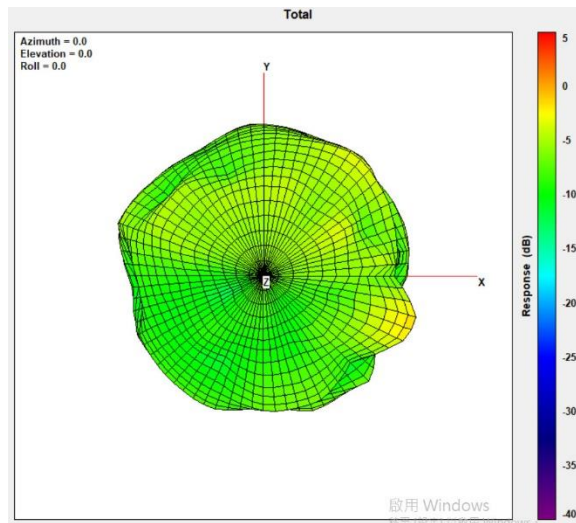

#### Max Antenna 3D Radiation Pattern 5150-5250 MHz

Frequency (MHz)	Peak Gain w/ Cable Loss (dBi)
5150-5250	-1.11

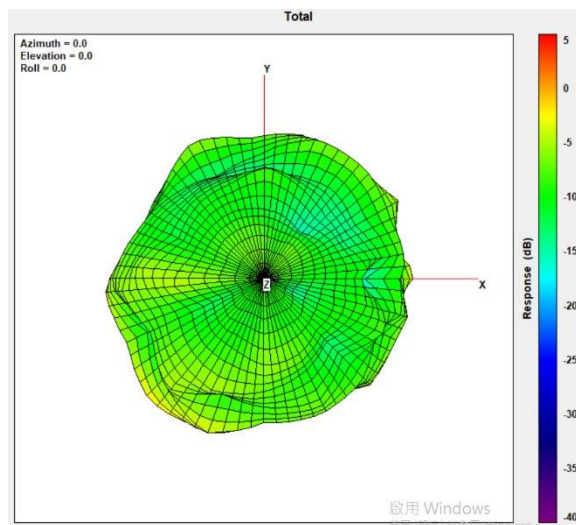



### Max Antenna 3D Radiation Pattern 5250-5350 MHz

Frequency (MHz)	Peak Gain w/ Cable Loss (dBi)
5250-5350	1.21

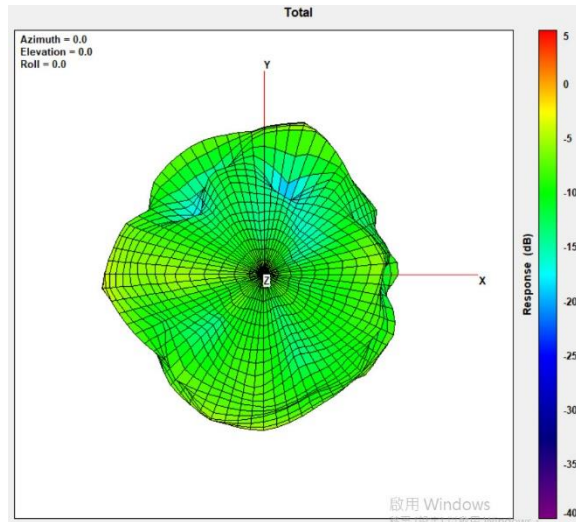

### Max Antenna 3D Radiation Pattern 5470-5725 MHz

Frequency (MHz)	Peak Gain w/ Cable Loss (dBi)
5470-5725	1.03

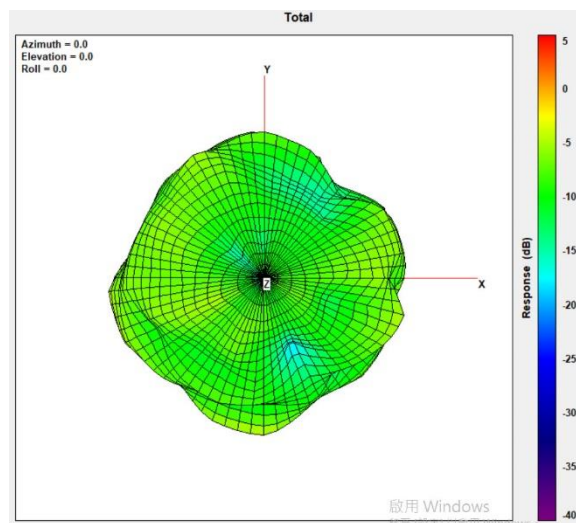



## Max Antenna 3D Radiation Pattern 5725-5850 MHz

Frequency (MHz)	Peak Gain w/ Cable Loss (dBi)
5725-5850	1.65

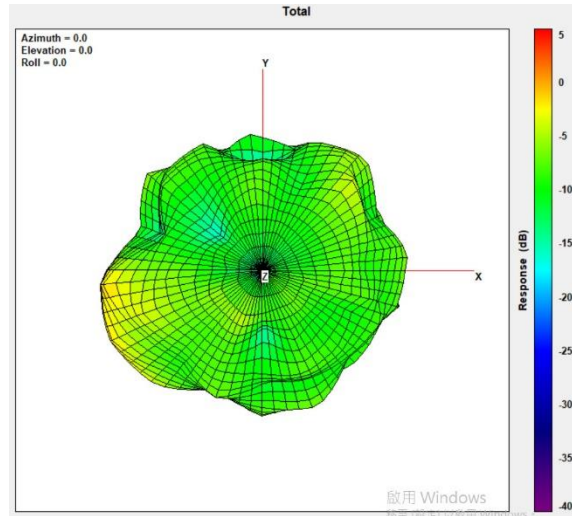

## Max Antenna 3D Radiation Pattern 5850-5895 MHz

Frequency (MHz)	Peak Gain w/ Cable Loss (dBi)
5850-5895	1.62

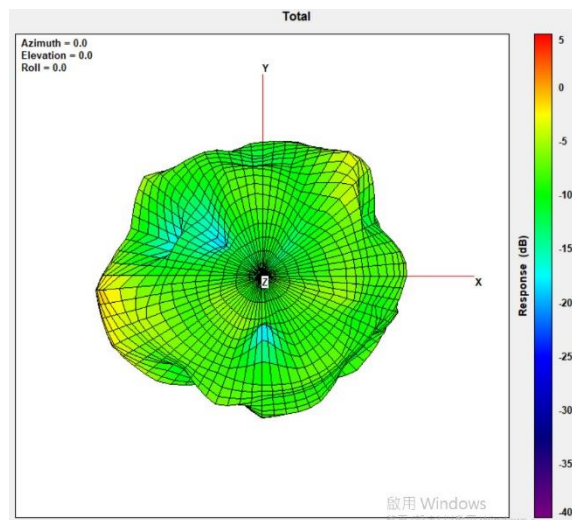

### Max Antenna 3D Radiation Pattern 5925-6425 MHz

Frequency (MHz)	Peak Gain w/ Cable Loss (dBi)
5850-5895	-0.1

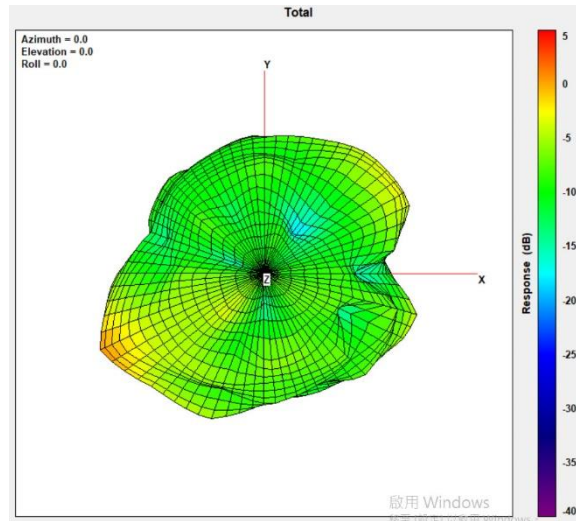

### Max Antenna 3D Radiation Pattern 6425-6525 MHz

Frequency (MHz)	Peak Gain w/ Cable Loss (dBi)
5850-5895	-0.87

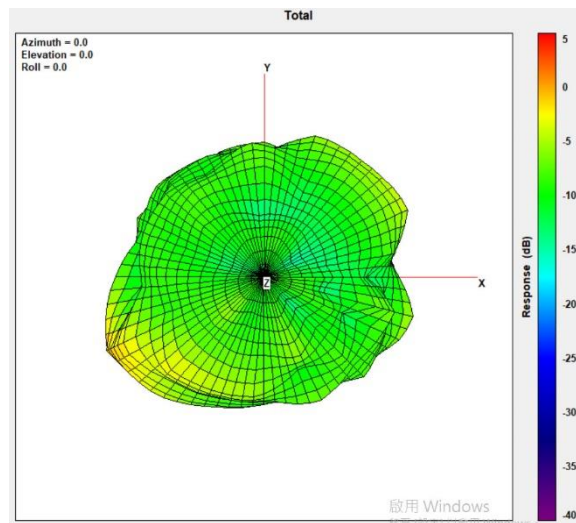

### Max Antenna 3D Radiation Pattern 6525-6875 MHz

Frequency (MHz)	Peak Gain w/ Cable Loss (dBi)
5850-5895	-0.84

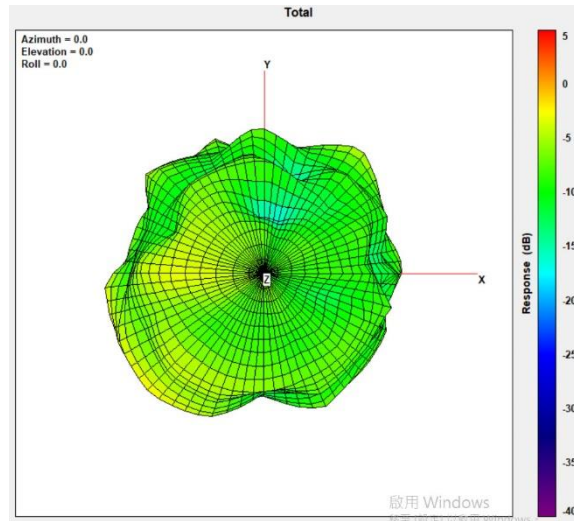

### Max Antenna 3D Radiation Pattern 6875-7125 MHz

Frequency (MHz)	Peak Gain w/ Cable Loss (dBi)
5850-5895	-1.72

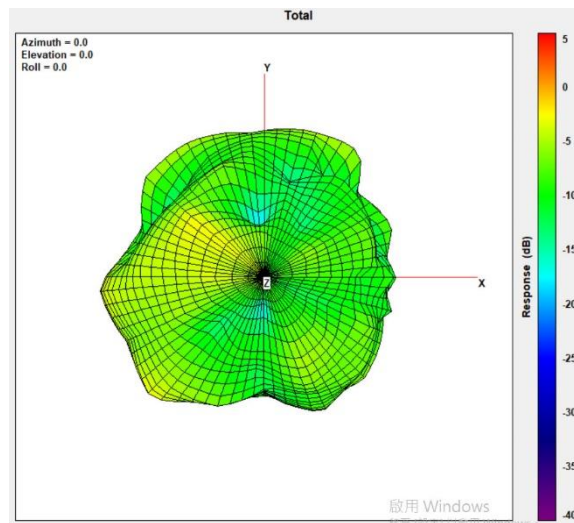

## Auxiliary Antenna– Tablet Mode

### Max Antenna 3D Radiation Pattern 2400 – 2483.5 MHz

Frequency (MHz)	Peak Gain w/ Cable Loss (dBi)
2400-2483.5	-0.59

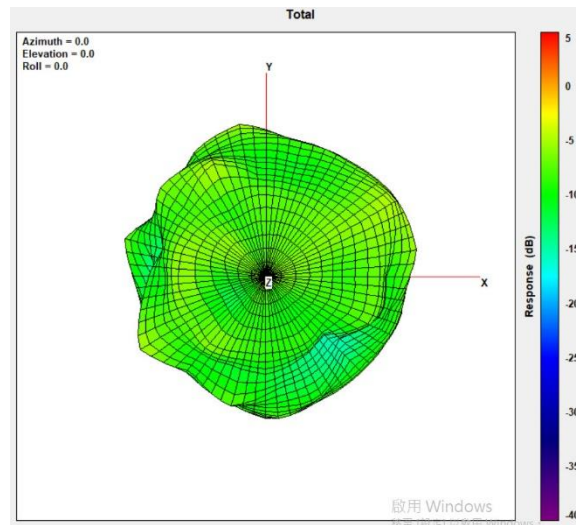

### Max Antenna 3D Radiation Pattern 5150-5250 MHz

Frequency (MHz)	Peak Gain w/ Cable Loss (dBi)
5150-5250	-0.14

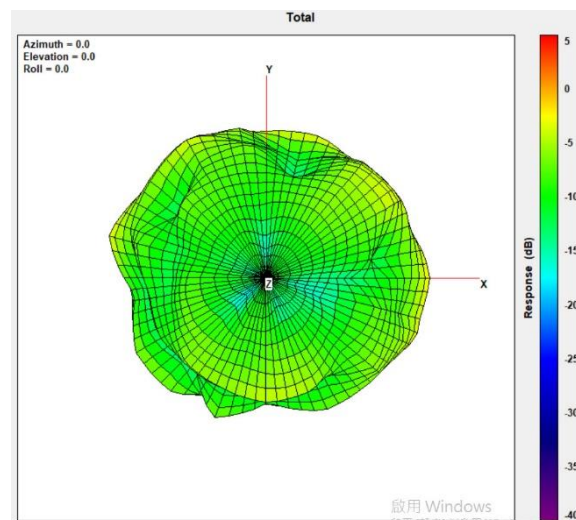

### Max Antenna 3D Radiation Pattern 5250-5350 MHz

Frequency (MHz)	Peak Gain w/ Cable Loss (dBi)
5250-5350	0.72

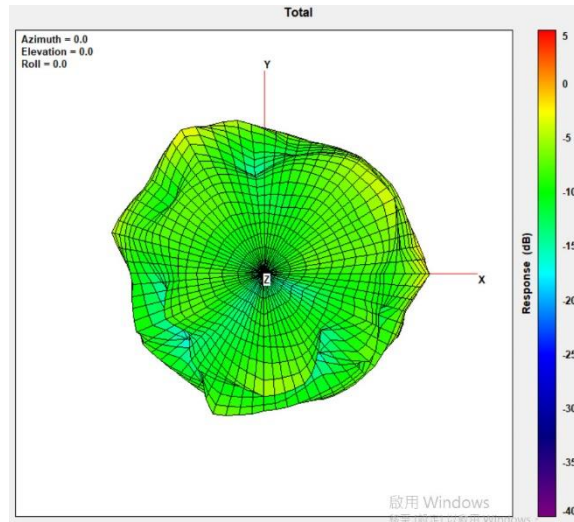

### Max Antenna 3D Radiation Pattern 5470-5725 MHz

Frequency (MHz)	Peak Gain w/ Cable Loss (dBi)
5470-5725	2.38

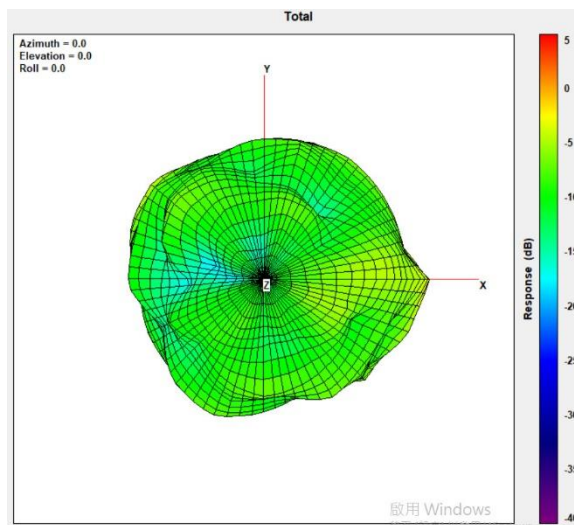

## Max Antenna 3D Radiation Pattern 5725-5850 MHz

Frequency (MHz)	Peak Gain w/ Cable Loss (dBi)
5725-5850	2.75

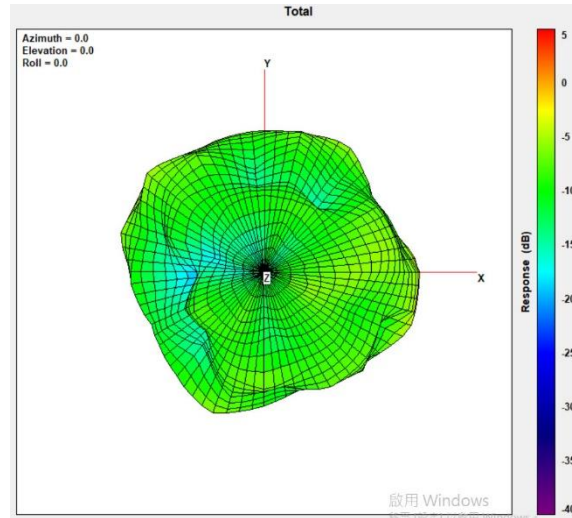

## Max Antenna 3D Radiation Pattern 5850-5895 MHz

Frequency (MHz)	Peak Gain w/ Cable Loss (dBi)
5850-5895	2.29

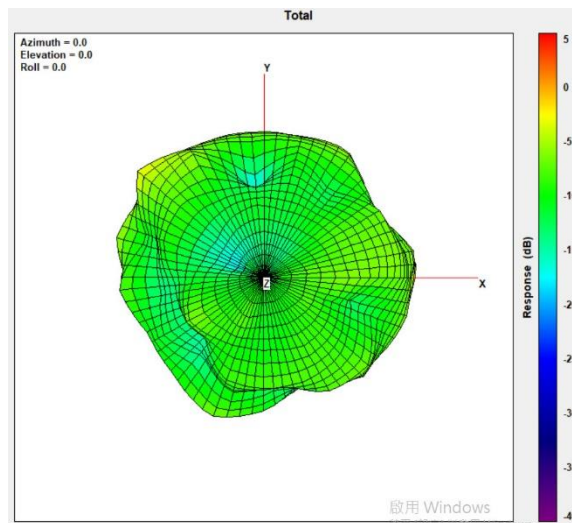

### Max Antenna 3D Radiation Pattern 5925-6425 MHz

Frequency (MHz)	Peak Gain w/ Cable Loss (dBi)
5850-5895	1.68

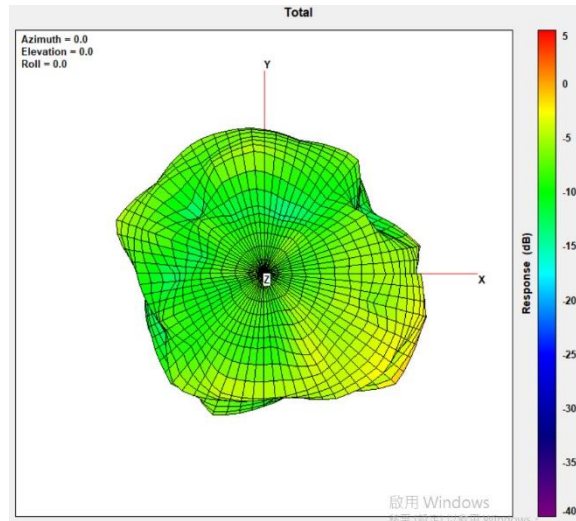

### Max Antenna 3D Radiation Pattern 6425-6525 MHz

Frequency (MHz)	Peak Gain w/ Cable Loss (dBi)
5850-5895	1.14

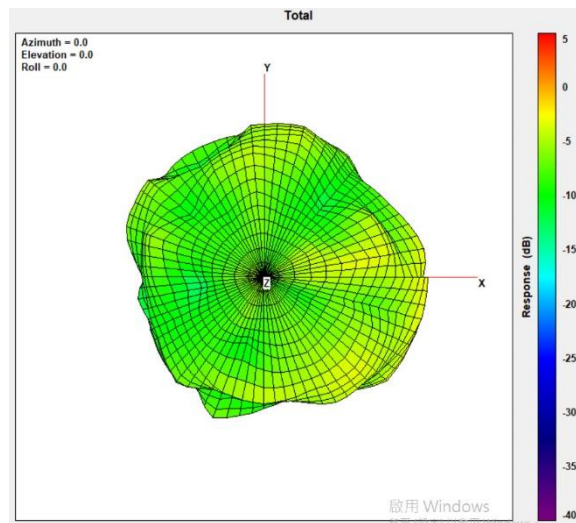



### Max Antenna 3D Radiation Pattern 6525-6875 MHz

Frequency (MHz)	Peak Gain w/ Cable Loss (dBi)
5850-5895	2.35

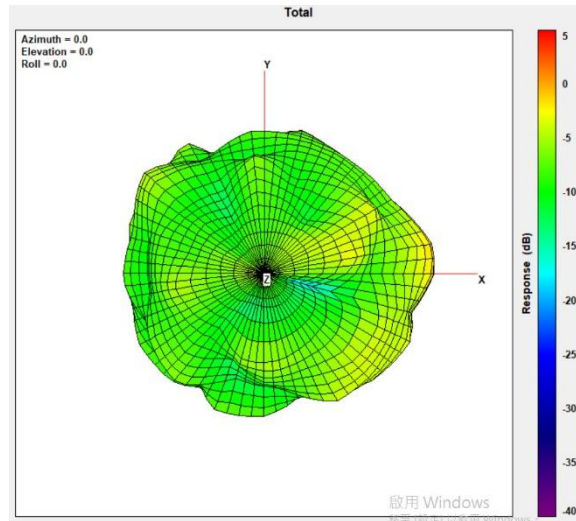

### Max Antenna 3D Radiation Pattern 6875-7125 MHz

Frequency (MHz)	Peak Gain w/ Cable Loss (dBi)
5850-5895	2.07

