

TEST REPORT

1. Applicant

Name : LG-Ericsson Co.,Ltd.
Address : 533, Hogue-1dong, Dongan-gu, Anyang-si, Gyeonggi-do,
431-749, Korea

2. Products

Name : Smart Business Gateway
Model : SBG-1000
Manufacturer : LN Srithai Comm Co.,Ltd.

3. Test Standard/Method : FCC Part 15 Subpart D & RSS-213 / ANSI C63.17

4. Test Results : Positive

5. Use of Report : -

6. Date of Application : January 31, 2011

7. Date of Issue : April 04, 2011

Tested by

Sung-kyu Cho

Sung-kyu Cho

Telecommunication Center
Engineer

Approved by

Jeong-min Kim

Jeong-min Kim

Telecommunication Center
Manager

The test results contained apply only to the test sample(s) supplied by the applicant, and this test report shall not be reproduced in full or in part without approval of the KTL in advance.

Korea Testing Laboratory

TABLE OF CONTENTS

| | |
|---|-----------|
| 1. GENERAL INFORMATIONS..... | 3 |
| 2. SUMMARY OF TEST RESULTS..... | 5 |
| 3. TEST RESULTS | 7 |
| 3.1 ANTENNA REQUIREMENTS | 7 |
| 3.2 DIGITAL MODULATION TECHNICS | 8 |
| 3.3 EMISSION BANDWIDTH..... | 9 |
| 3.4 POWER ADJUSTMENT FOR ANTENNA GAIN..... | 11 |
| 3.5 RADIATED OUT OF BAND EMISSION..... | 12 |
| 3.6 PEAK TRANSMIT POWER | 13 |
| 3.7 POWER SPECTRAL DENSITY | 16 |
| 3.8 AUTOMATICALLY DISCONTINUED TRANSMISSION..... | 18 |
| 3.9 IN-BAND EMISSIONS | 19 |
| 3.10 OUT-OF-BAND EMISSIONS | 21 |
| 3.11 CARRIER FREQUENCY STABILITY | 28 |
| 3.12 FRAME REPETITION STABILITY | 29 |
| 3.13 FRAME PERIOD AND JITTER | 30 |
| 3.14 MONITORING TIME | 31 |
| 3.15 MONITORING THRESHOLD..... | 32 |
| 3.16 MAXIMUM TRANSMIT TIME..... | 33 |
| 3.17 SYSTEM ACKNOWLEDGEMENT..... | 34 |
| 3.18 LEAST INTERFERED CHANNEL & CHANNEL CONFIRMATION..... | 35 |
| 3.19 RANDOM WAITING..... | 36 |
| 3.20 MONITORING BANDWIDTH..... | 37 |
| 3.21 MAXIMUM REACTION TIME | 40 |
| 3.22 MONITORING ANTENNA..... | 42 |
| 3.23 DUPLEX CONNECTIONS | 43 |
| 3.24 ALTERNATIVE MONITORING INTERVAL FOR CO-LOCATED DEVICE..... | 44 |
| 4. SELF DECLARATION..... | 45 |
| 5. TEST SET UP..... | 46 |
| 6. TEST EQUIPMENT | 47 |

1. GENERAL INFORMATIONS

1.1 Applicant (Client)

| | |
|----------------------|---|
| Name | LG-Ericsson Co., Ltd. |
| Address | 533, Hogye-1dong, Dongan-gu, Anyang-si, Gyeonggi-do, 431-749, Korea |
| Contact Person | James Kang |
| Telephone No. | +82 31 450 4803 |
| Facsimile No. | +82 31 450 4745 |
| E-mail address | korjunma@lgericsson.com |
| Manufacturer | LN Srithai Comm Co.,Ltd. |
| Manufacturer Address | 71/12 Moo 5 Bangna Trad Rd. KM 52 ThakarmBanpakong Chachoengsao 24130, Thailand |

1.2 Equipment (EUT)

| | |
|---------------------|-------------------------|
| Name | Smart Business Gateway |
| Model Name | SBG-1000 |
| FCC ID | TUISBG-1000 |
| IC Number | 6241A-SBG1000 |
| Operating Frequency | 1921.536 ~ 1928.448 MHz |
| Number of channels | 5 |
| Type of Modulation | GFSK |
| Hardware Version | V1.0 |
| Software Version | V1.0 |
| Serial No. | Prototype |

1.3 Technical specifications

| | |
|--------------------|---|
| Frequency Band | 1920 ~ 1930 MHz |
| Frame Period | 10 ms |
| Time Slot Length | 416.67 us |
| Slots | 12 RX, 12 TX slots |
| Slot Structure | 6 active duplex pairs per frame |
| Bit Rate | 1.152 Mbit |
| Number of channels | 5 RF Channels, 5x12=60 TDMA duplex Channels |

| Frequency Band | Frequency |
|----------------|--------------|
| Channel 1 | 1921.536 MHz |
| Channel 2 | 1923.264 MHz |
| Channel 3 | 1924.992 MHz |
| Channel 4 | 1926.720 MHz |
| Channel 5 | 1928.448 MHz |

1.4 Testing Laboratory

| | |
|-------------------------------|--|
| Testing Place | Korea Testing Laboratory (KTL) 1271-12, Sa-Dong Sangnok-Gu, Ansan-si Gyunggi-Do , Korea |
| FCC registration number | 408324 |
| Industry Canada filing number | 6298A-1 |
| Test Engineer | Sung-kyu Cho |
| Telephone number | +82 31 5000 132 |
| Facsimile number | +82 31 5000 149 |
| E-mail address | skcho@ktl.re.kr |

2. SUMMARY OF TEST RESULTS

| Name of Test | FCC Part | RSS-212 | Test Procedure ANSIC63.17 | Verdict |
|---|----------------|--------------|---------------------------|--------------------------|
| Antenna Requirements | 15.317, 15.203 | 7.1.4 | Declaration | Attestation |
| Digital Modulation Techniques | 15.319(b) | 6.1 | 6.1.4 | Attestation |
| Emission Bandwidth | 15.323(a) | 6.4 | 6.1.3 | Complies |
| Power adjustment for antenna gain | 15.319(e) | 4.1(e) | 4 | Complies |
| Conducted Emission | 15.207(a) | 6.3 | ANSI C63.4 | Refer to EMI Test Report |
| Radiated Out of Band Emission | 15.209(a) | 6.8 | ANSI C63.4 | N/A |
| Peak transmit power | 15.319(c)(e) | 6.5 | 6.1.2 | Complies |
| Power spectral density | 15.319(d) | 6.6 | 6.1.5 | Complies |
| Automatically discontinue transmission | 15.319(f) | 4.3.4(a) | -- | Complies |
| In-band emissions | 15.323(d) | 6.7.2 | 6.1.6.1 | Complies |
| Out-of-band emission | 15.323(d) | 6.7.1 | 6.1.6.2 | Complies |
| Carrier frequency stability | 15.323(f) | 6.2 | 6.2.1 | Complies |
| Frame repetition stability | 15.323(e) | 4.3.4(c) | 6.2.2 | Complies |
| Frame period and jitter | 15.323(e) | 4.3.4(c) | 6.2.3 | Complies |
| Monitoring time | 15.323(c)(1) | 4.3.4(b1) | 7.3.4 | Complies |
| Monitoring threshold | 15.323(c)(2) | 4.3.4(c5&c9) | 7.3.1 | Complies |
| Maximum transmit time | 15.323(c)(3) | 4.3.4(b3) | 8.2.2 | Complies |
| System acknowledgement | 15.323(c)(4) | 4.3.4(b4) | 8.1.1 & 8.2.1 | Complies |
| Least Interfered Channel | 15.323(c)(5) | 4.3.4(b5) | 7.3.2, 7.3.3 | Complies |
| Random waiting | 15.323(c)(6) | 4.3.4(b6) | 8.1.3 | Attestation |
| Monitoring Bandwidth | 15.323(c)(7) | 4.3.4(b7) | 7.4 | Complies |
| Maximum reaction time | 15.323(c)(7) | 4.3.4(b7) | 7.5 | Complies |
| Monitoring antenna | 15.323(c)(8) | 4.3.4(b8) | 4 | Attestation |
| Duplex Connections | 15.323(c)(10) | 4.3.4(b10) | 8.3 | Attestation |
| Alternative Monitoring Interval for Co-located Device | 15.323(c)(11) | 4.3.4(b11) | 8.4 | Attestation |
| Receiver Spurious Emission | 15.109 | 6.8 | ANSI C63.4 | Refer to EMI Test Report |

Note 1 : Test results reported in this document relate only to the items tested

Note 2 : The required tests demonstrated compliance as per client declaration of test configuration, monitoring methodology and associated pass/fail criteria

Note 3 : Test results apply only to the item(s) tested

*** Modifications required for compliance**

No modifications were implemented by KTL.

All results in this report pertain to the un-modified sample provided to KTL.

3. TEST RESULTS

3.1 Antenna Requirements

3.1.1 Requirement

EUT must meet the antenna requirement of FCC Rule 15.203

- EUT uses a permanently attached antenna which is considered sufficient to comply with the provisions of this rule.
- EUT uses a unique antenna jack or electrical connector which is considered sufficient to comply with the provisions of this rule.

3.1.2 Attestation

The EUT use permanetly attached antennas.

3.2 Digital Modulation Technics

3.2.1 Requirement

All transmissions must use only digital modulation techniques.

3.2.2 Attestation

The tested equipment is based on DECT technology described in the ETSI EN 300 175, the only difference is that the channel allocation is modified to operate in the 1920-1930 MHz band.

3.3 Emission Bandwidth

3.3.1 FCC rule - FCC 15.323(a)

(a) Operation shall be contained within the 1920-1930 MHz band. The emission bandwidth shall be less than 2.5 MHz. The power level shall be as specified in § 15.319(c), but in no event shall the emission bandwidth be less than 50 kHz.

3.3.2 Test Procedure - ANSI C63.17 sub-clause 6.1.3.

3.3.3 Test Results

| Channel | Result (MHz) | Limit (MHz) | Verdict |
|---------|--------------|-------------|----------|
| 1 | 1.484 | 2.5 | Complies |
| 3 | 1.482 | 2.5 | Complies |
| 5 | 1.477 | 2.5 | Complies |

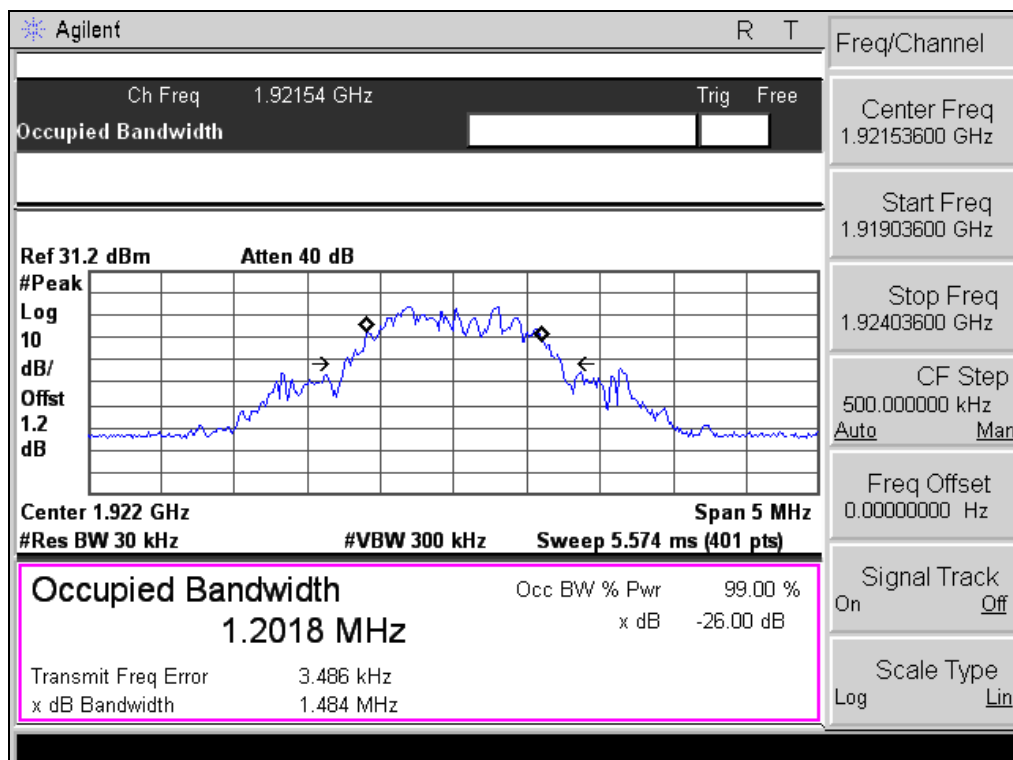

- Emission Bandwidth of Ch 1 -

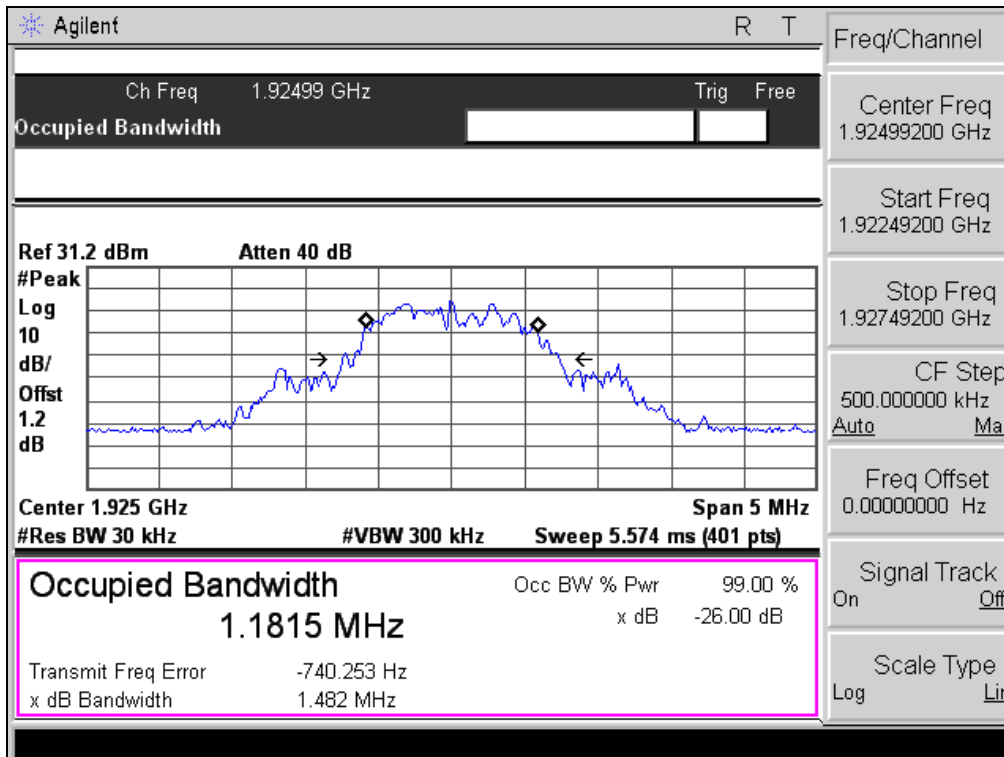

- Emission Bandwidth of Ch 3 -

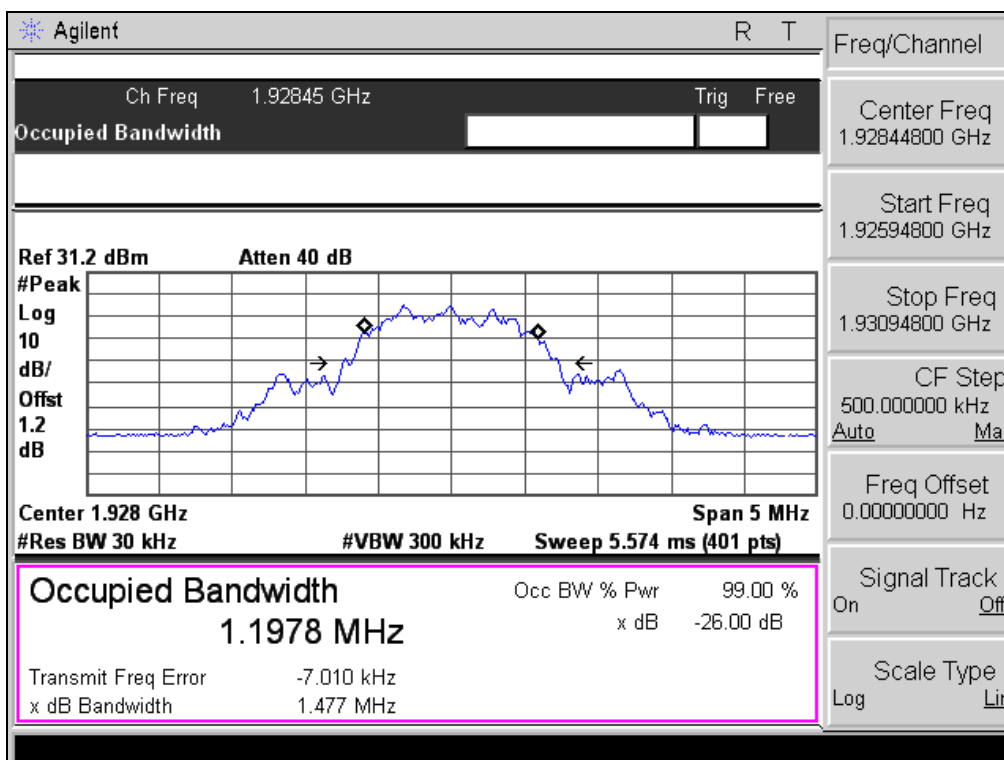

- Emission Bandwidth of Ch 5 -

3.4 Power adjustment for antenna gain

3.4.1 Test limit - FCC 15.319(e)

(e) The peak transmit power shall be reduced by the amount in decibels that the maximum directional gain of the antenna exceeds 3 dBi.

3.4.2 Test results

The maximum antenna gain is 3.0 dBi.

| Band | Frequency (MHz) | Default-ANT | |
|------|-----------------|----------------|-----------------|
| | | Total Eff. (%) | Peak Gain (dBi) |
| DECT | 1880 MHz | 56.4 | 3.0 |
| | 1890 MHz | 55.6 | 3.0 |
| | 1900 MHz | 54.3 | 2.8 |

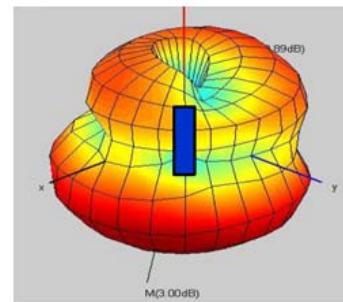

3.5 Radiated Out of Band Emission

3.5.1 Test procedure – FCC Part 15.209

3.5.2 Test result

Not tested.

This test is not required if the Out-of-Band Emissions is tested conducted and is Pass.

3.6 Peak transmit power

3.6.1 Test limit - FCC 15.319(c)

(c) Peak transmit power shall not exceed 100 microwatts multiplied by the square root of the emission bandwidth in hertz. Peak transmit power must be measured over any interval of continuous transmission using instrumentation calibrated in terms of an rms-equivalent voltage. The measurement results shall be properly adjusted for any instrument limitations, such as detector response times, limited resolution bandwidth capability when compared to the emission bandwidth, sensitivity, etc., so as to obtain a true peak measurement for the emission in question over the full bandwidth of the channel.

Calculation of Peak transmit power Limit:

The antenna gain < 3 dBi

The measured emission bandwidth = 1.484 MHz

Limit : $5 \log B(\text{bandwidth in Hz}) - 10 \text{ dBm} = 20.86 \text{ dBm}$

The Maximum allowed peak transmit power is 20.86 dBm

3.6.2 Test procedure - ANSI C63.17 sub-clause 6.1.2.

3.6.3 Test results

| Channel | Result (dBm) | Limit (dBm) | Verdict |
|---------|--------------|-------------|----------|
| 1 | 20.56 | 20.86 | Complies |
| 3 | 20.56 | 20.86 | Complies |
| 5 | 20.06 | 20.86 | Complies |

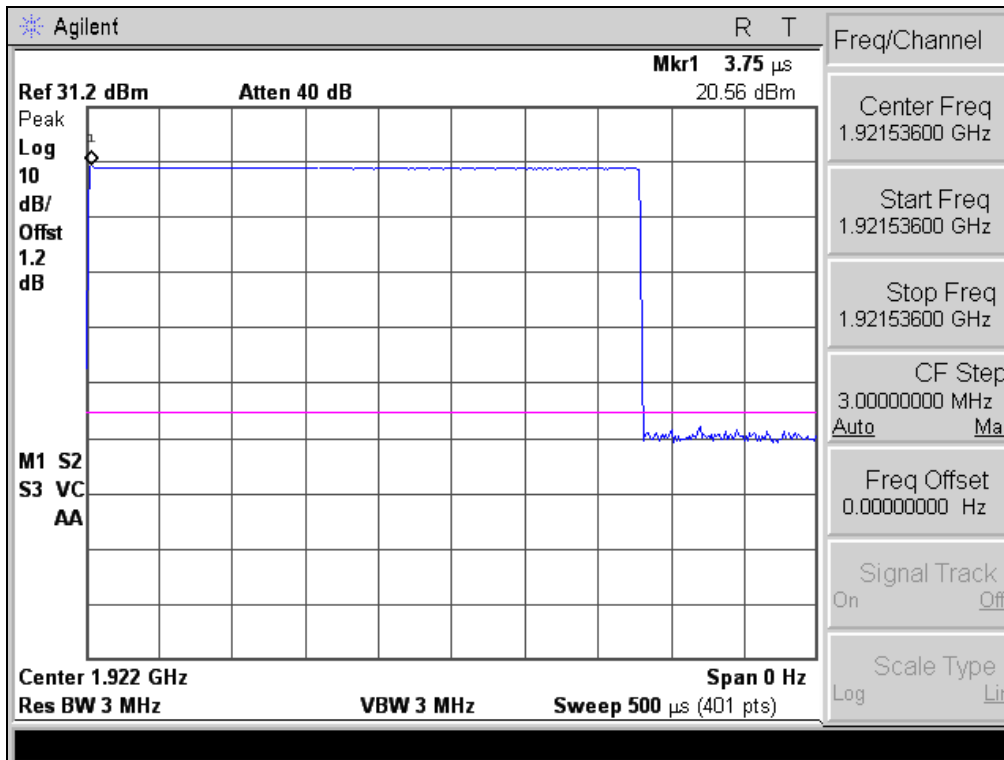

- Peak transmit power of Ch 1 -

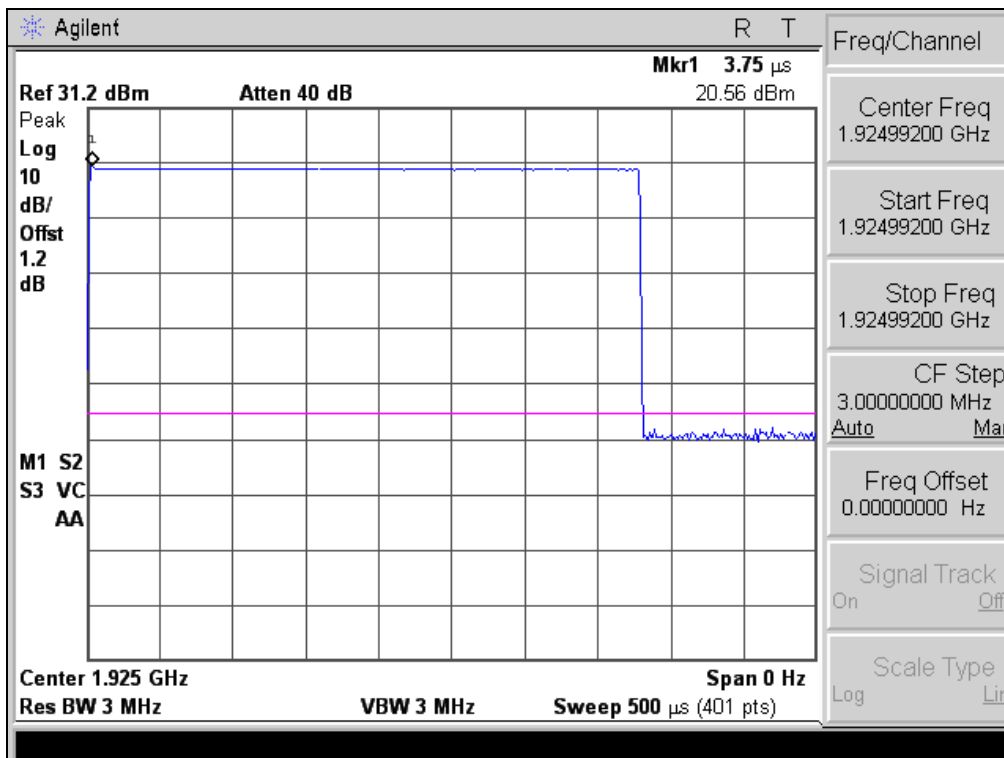

- Peak transmit power of Ch 3 -

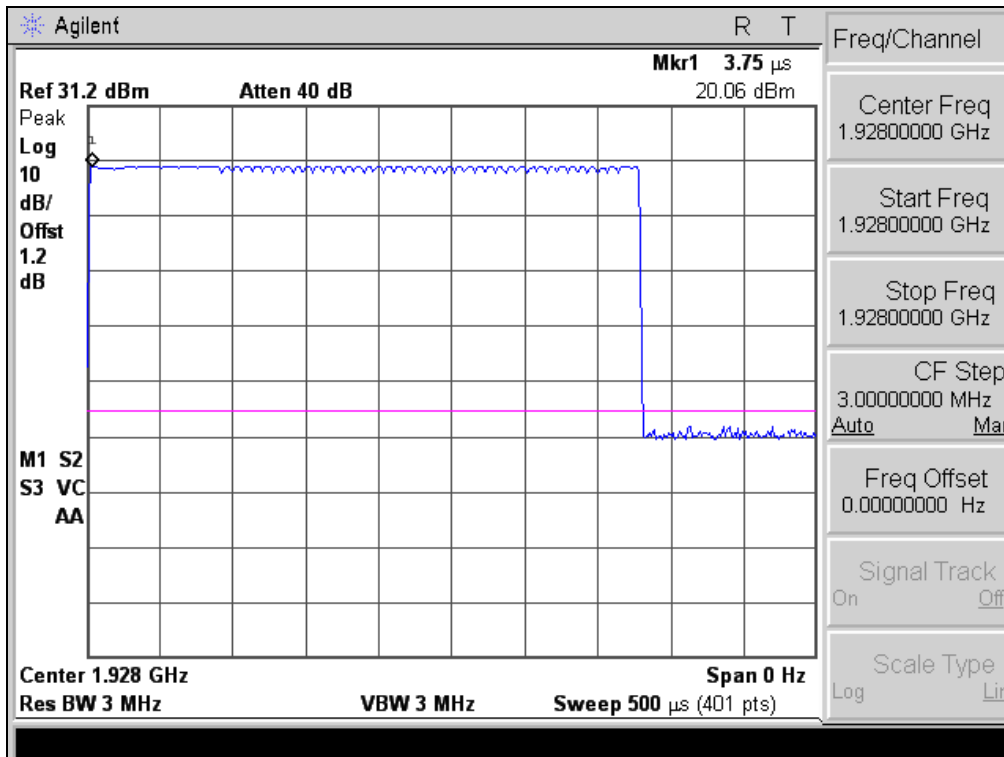

- Peak transmit power of Ch 5 -

3.7 Power spectral density

3.7.1 Test limit - FCC 15.319(c)

(d) Power spectral density shall not exceed 3 milliwatts in any 3 kHz bandwidth as measured with a spectrum analyzer having a resolution bandwidth of 3 kHz.

3.7.2 Test procedure - ANSI C63.17 sub-clause 6.1.5.

3.7.3 Test results

| Channel | Result (mW) | Limit (mW) | Verdict |
|---------|-------------|------------|----------|
| 1 | 1.14 | 3 | Complies |
| 3 | 0.87 | 3 | Complies |
| 5 | 0.93 | 3 | Complies |

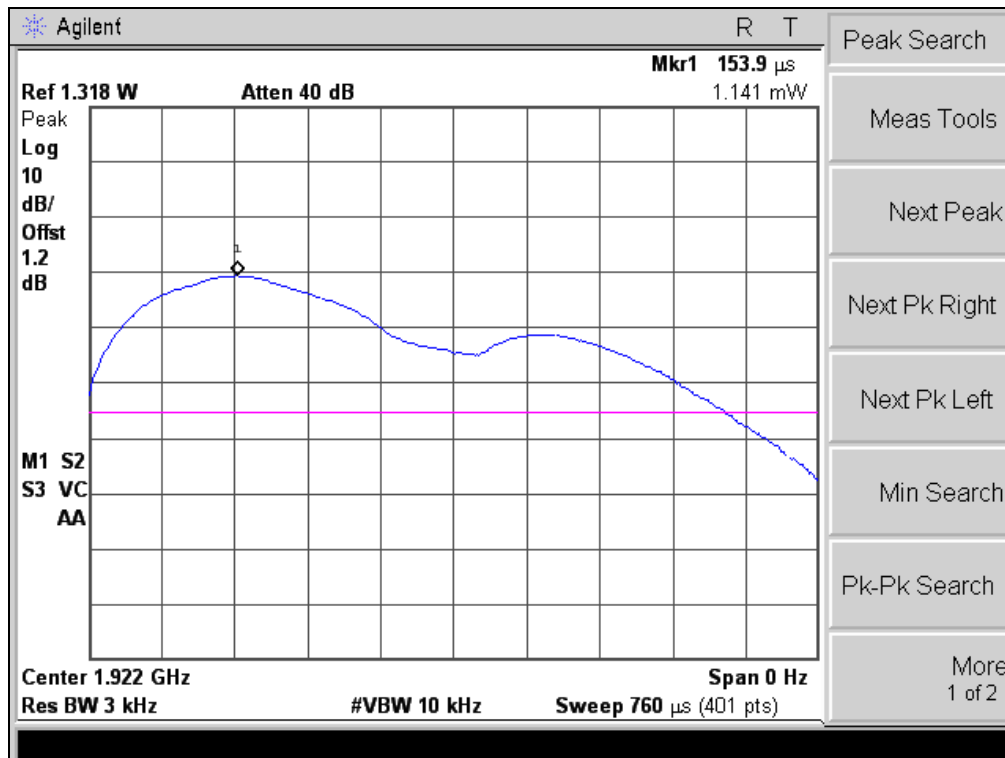

– Power spectral density of Ch 1 –

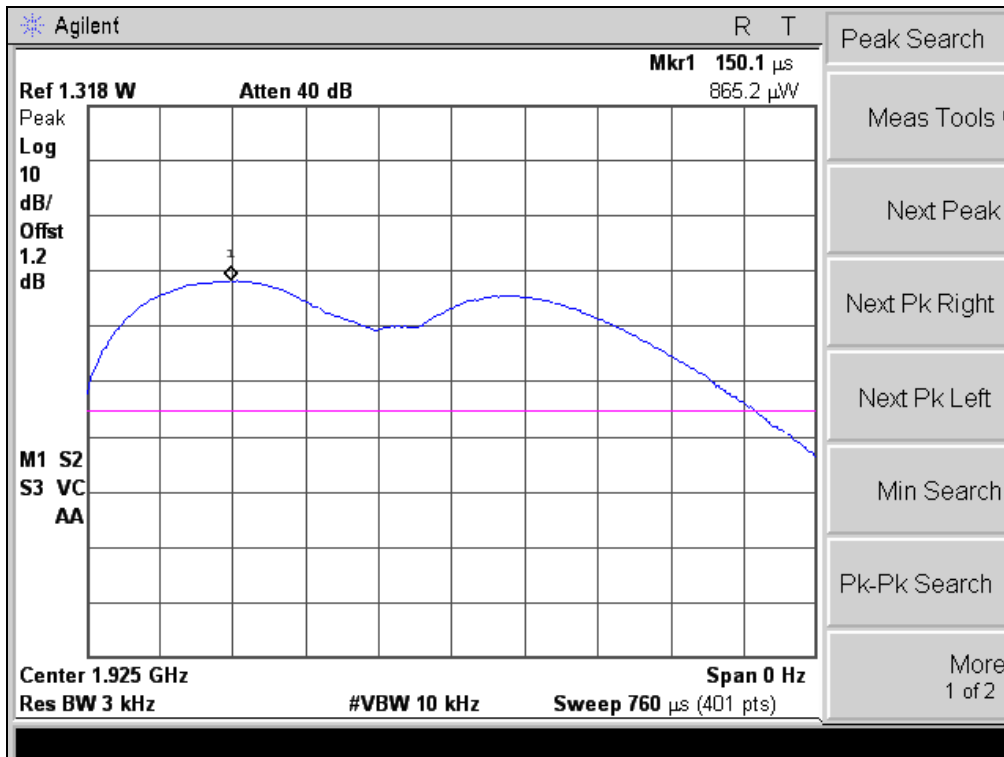

– Power spectral density of Ch 3 –



– Power spectral density of Ch 5 –

3.8 Automatically Discontinued Transmission

3.8.1 Test limit - FCC 15.319(f)

(f) The device shall automatically discontinue transmission in case of either absence of information to transmit or operational failure. These provisions are not intended to preclude transmission of control and signaling information or use of repetitive codes used by certain digital technologies to complete frame or burst intervals.

3.8.2 Test procedure

The following tests simulate the reaction of the EUT in case of either absence of information to transmit or operational failure after a connection with the companion devices is established.

| | Test | EUT Reaction | Verdict |
|---|-------------------------------------|--------------|-----------|
| 1 | Power removed from the EUT | A/B/C | Pass/Fail |
| 2 | EUT Switch Off | A/B/C | Pass/Fail |
| 3 | Hook-On by companion device | A/B/C | Pass/Fail |
| 4 | Hook-On by EUT | A/B/C | Pass/Fail |
| 5 | Power Removed from Companion Device | A/B/C | Pass/Fail |
| 6 | Companion Device Switch Off | A/B/C | Pass/Fail |

A – Connection breakdown, Cease of all transmissions

B – Connection breakdown, EUT transmits control and signaling information

C – Connection breakdown, Companion Device transmits control and signaling information

NA – Not applicable

3.8.3 Test results

| | Test | EUT Reaction | Verdict |
|---|-------------------------------------|--------------|---------|
| 1 | Power removed from the EUT | C | Pass |
| 2 | EUT Switch Off | C | Pass |
| 3 | Hook-On by companion device | NA | Pass |
| 4 | Hook-On by EUT | C | Pass |
| 5 | Power Removed from Companion Device | A | Pass |
| 6 | Companion Device Switch Off | NA | Pass |

3.9 In-band emissions

3.9.1 Test limit - FCC 15.319(d)(2)

(d) Emissions outside the sub-band shall be attenuated below a reference power of 112 milliwatts as follows: 30 dB between the sub-band and 1.25 MHz above or below the sub-band; 50 dB between 1.25 and 2.5 MHz above or below the sub-band; and 60 dB at 2.5 MHz or greater above or below the subband. Emissions inside the sub-band must comply with the following emission mask: In the bands between 1B and 2B measured from the center of the emission bandwidth the total power emitted by the device shall be at least 30 dB below the transmit power permitted for that device; in the bands between 2B and 3B measured from the center of the emission bandwidth the total power emitted by an intentional radiator shall be at least 50 dB below the transmit power permitted for that radiator; in the bands between 3B and the sub-band edge the total power emitted by an intentional radiator in the measurement bandwidth shall be at least 60 dB below the transmit power permitted for that radiator. "B" is defined as the emission bandwidth of the device in hertz. Compliance with the emission limits is based on the use of measurement instrumentation employing peak detector function with an instrument resolution bandwidth approximately equal to 1.0 percent of the emission bandwidth of the device under measurement.

3.9.2 Test procedure - ANSI C63.17 sub-clause 6.1.6.1.

3.9.3 Test results

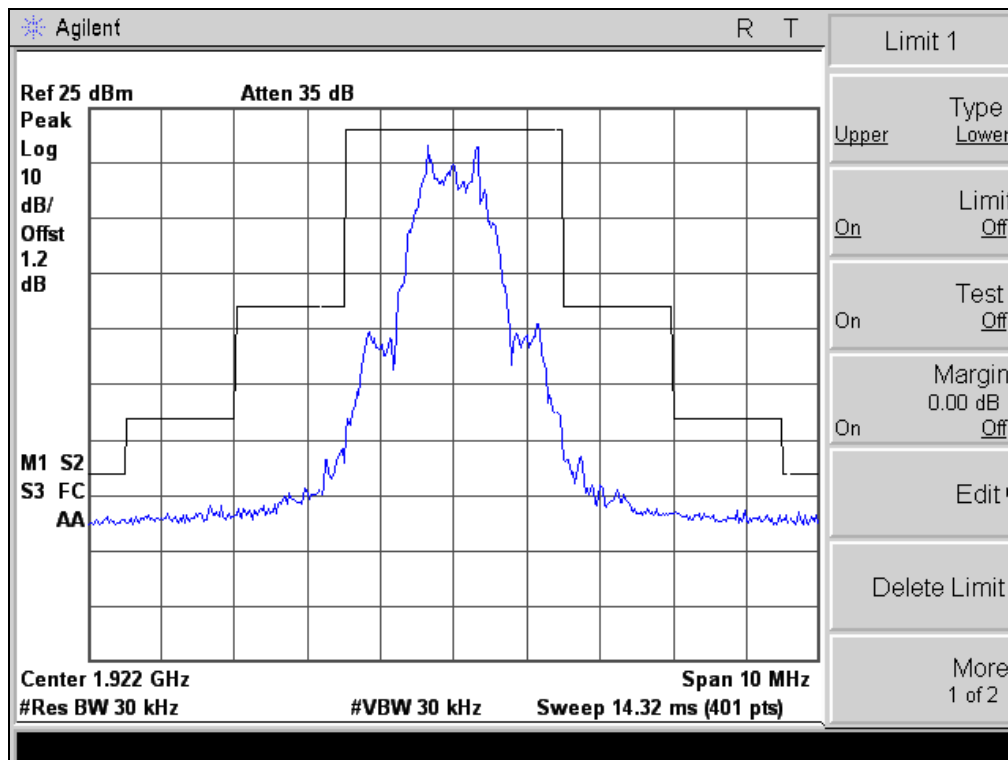

– In-band emission of Ch 1 –

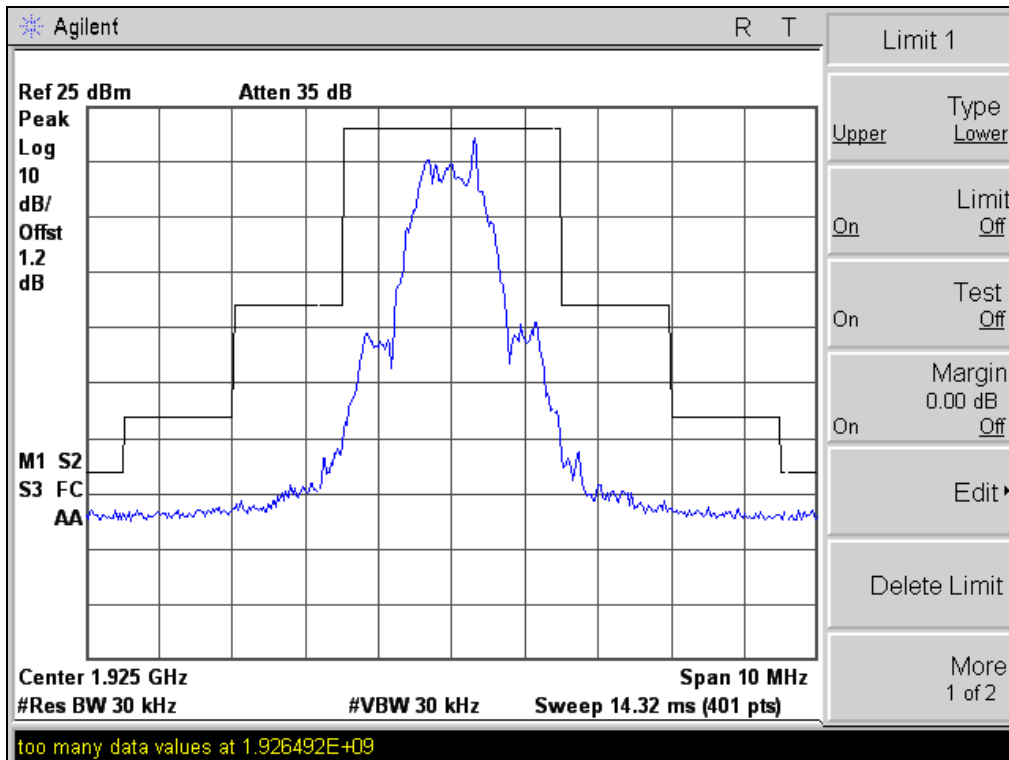

– In-band emission of Ch 3 –

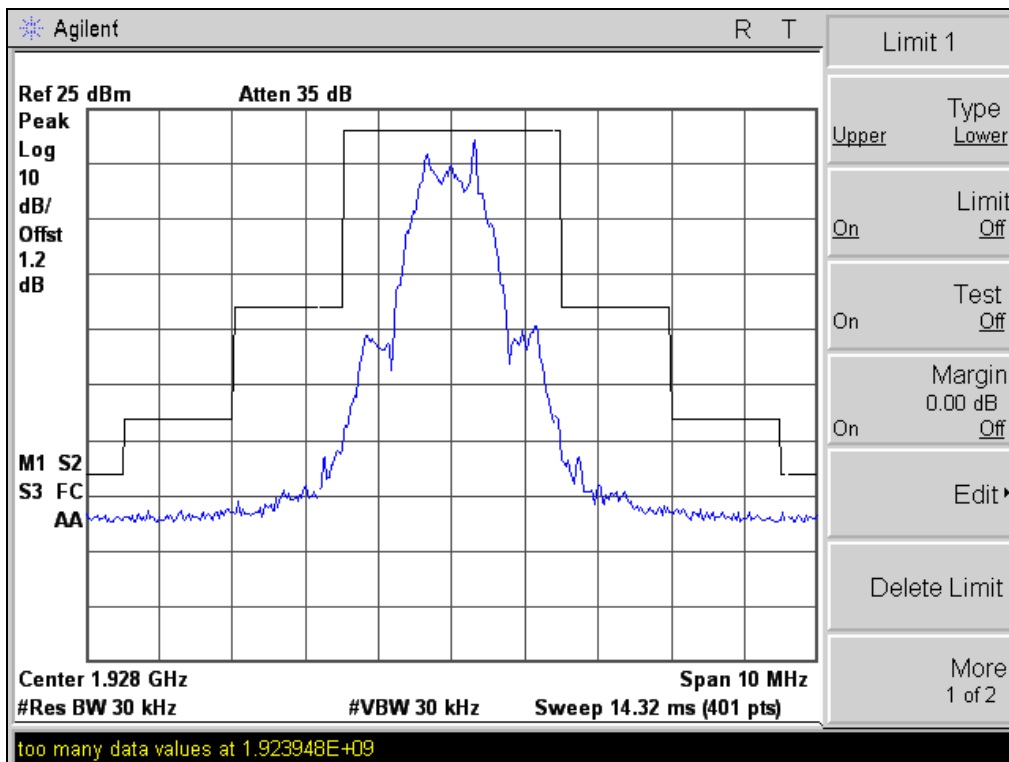

– In-band emission of Ch 5 –

3.10 Out-of-band emissions

3.10.1 Test limit - FCC 15.319(d)(2)

(d) Emissions outside the sub-band shall be attenuated below a reference power of 112 milliwatts as follows: 30 dB between the sub-band and 1.25 MHz above or below the sub-band; 50 dB between 1.25 and 2.5 MHz above or below the sub-band; and 60 dB at 2.5 MHz or greater above or below the subband. Emissions inside the sub-band must comply with the following emission mask: In the bands between 1B and 2B measured from the center of the emission bandwidth the total power emitted by the device shall be at least 30 dB below the transmit power permitted for that device; in the bands between 2B and 3B measured from the center of the emission bandwidth the total power emitted by an intentional radiator shall be at least 50 dB below the transmit power permitted for that radiator; in the bands between 3B and the sub-band edge the total power emitted by an intentional radiator in the measurement bandwidth shall be at least 60 dB below the transmit power permitted for that radiator. "B" is defined as the emission bandwidth of the device in hertz. Compliance with the emission limits is based on the use of measurement instrumentation employing peak detector function with an instrument resolution bandwidth approximately equal to 1.0 percent of the emission bandwidth of the device under measurement.

3.10.2 Test procedure - ANSI C63.17 sub-clause 6.1.6.2.

3.10.3 Test results

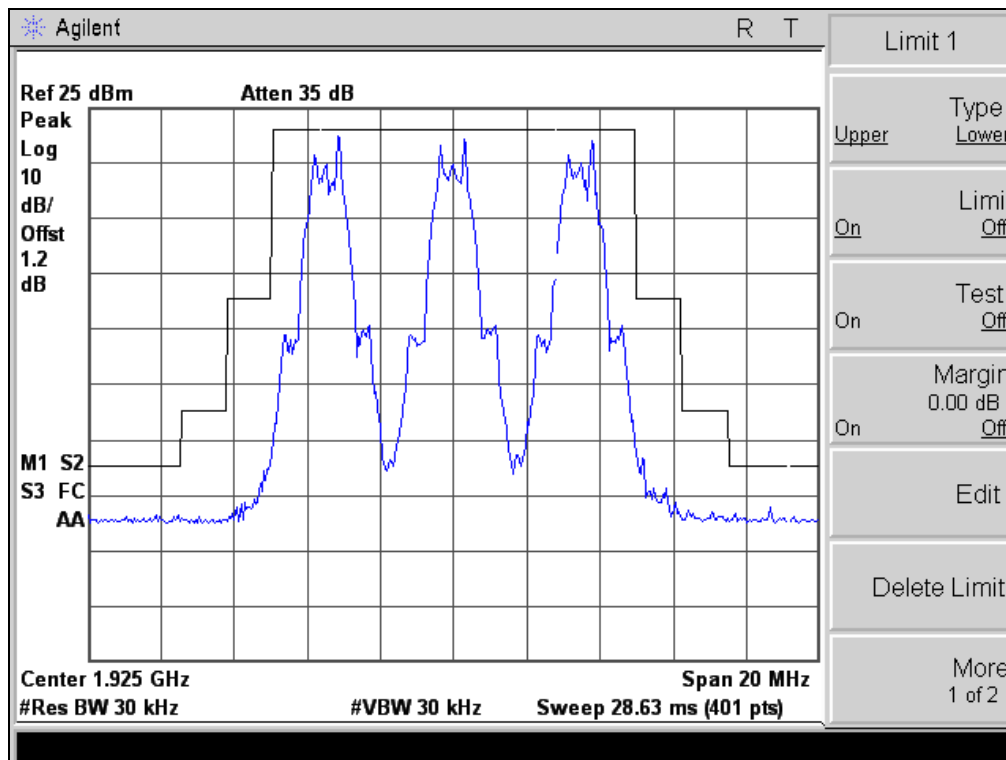

– Out-of-band emission –

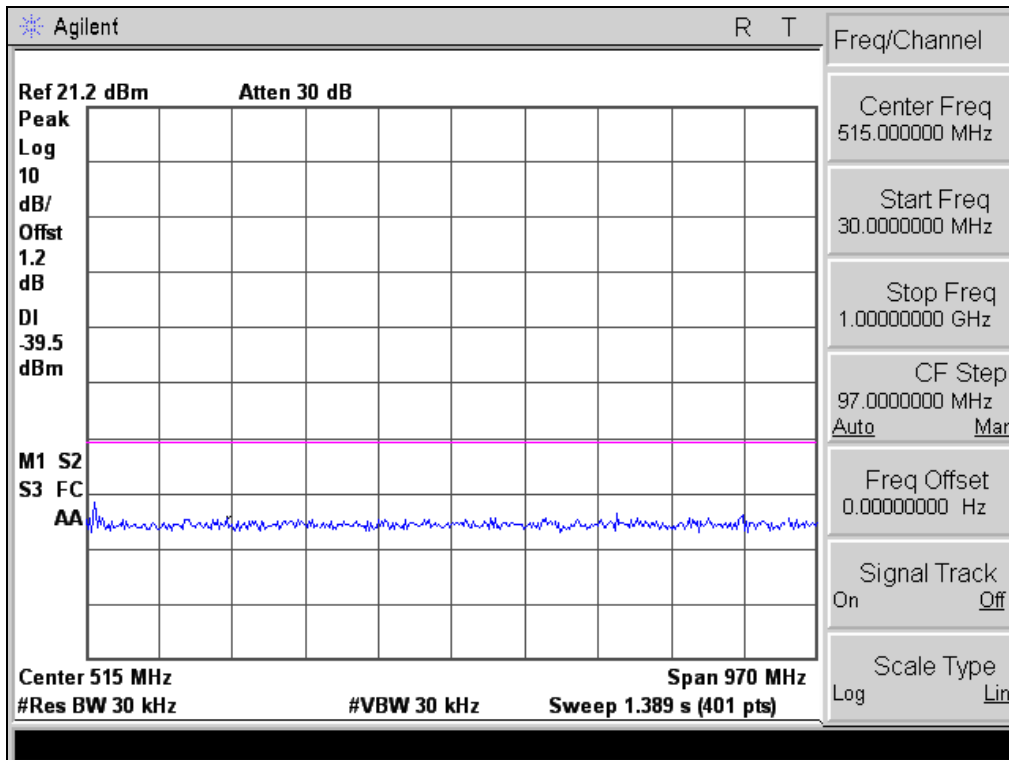

- Out-of-band emission of Ch1 -

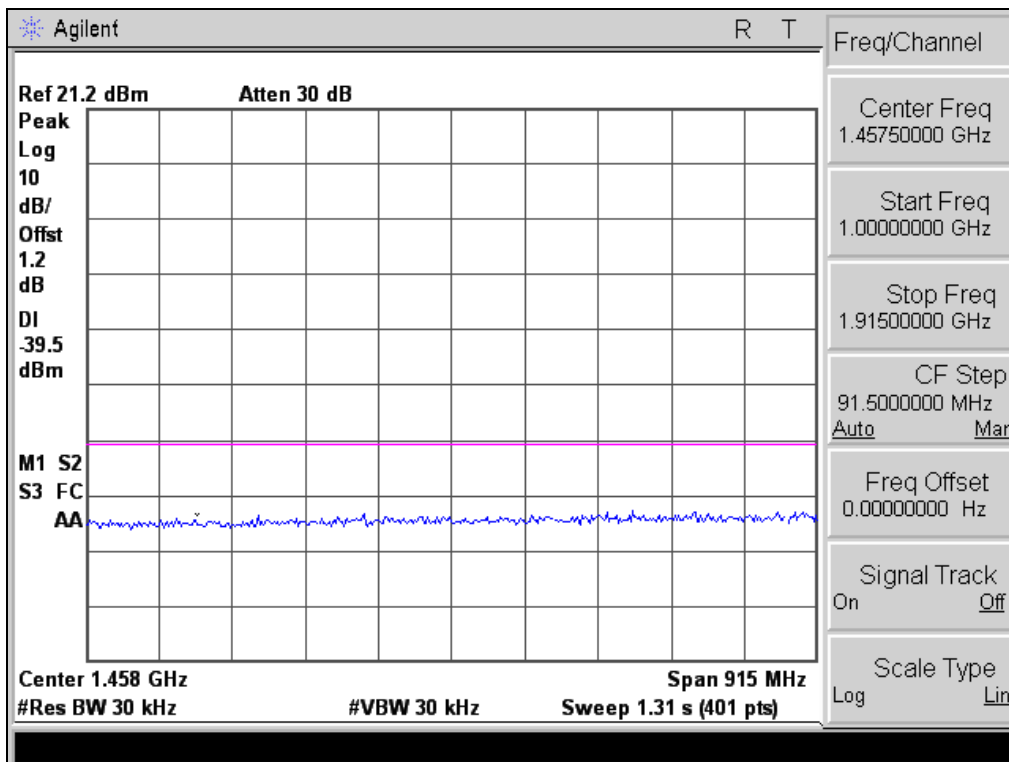

- Out-of-band emission of Ch1 -

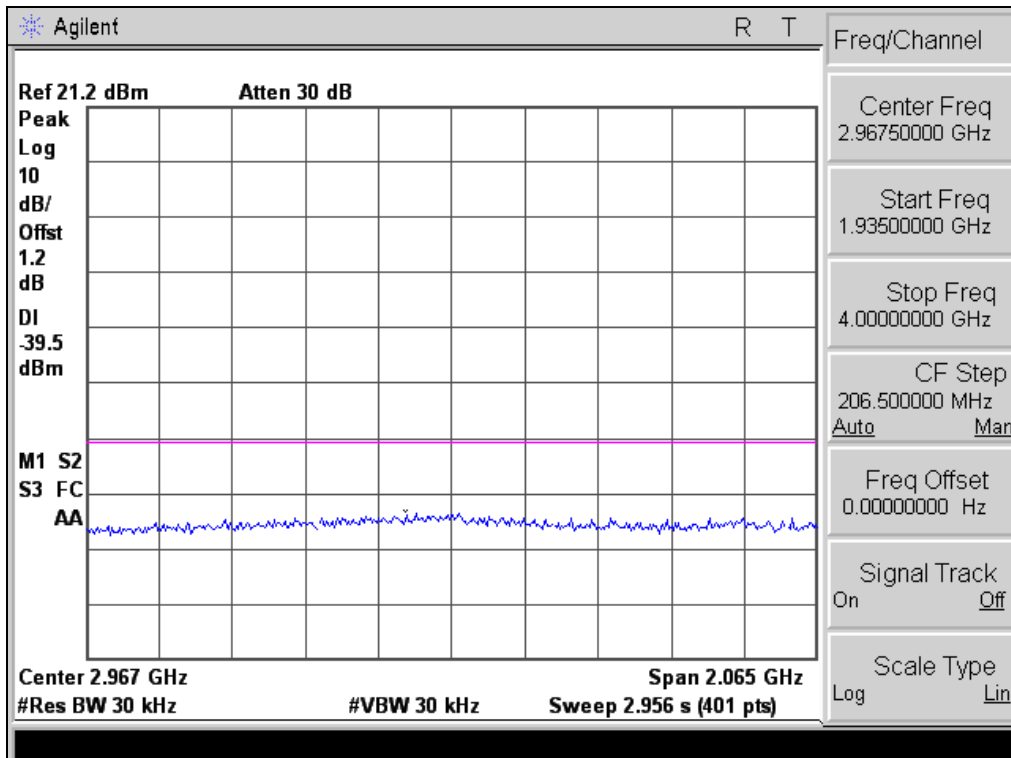

- Out-of-band emission of Ch1 -

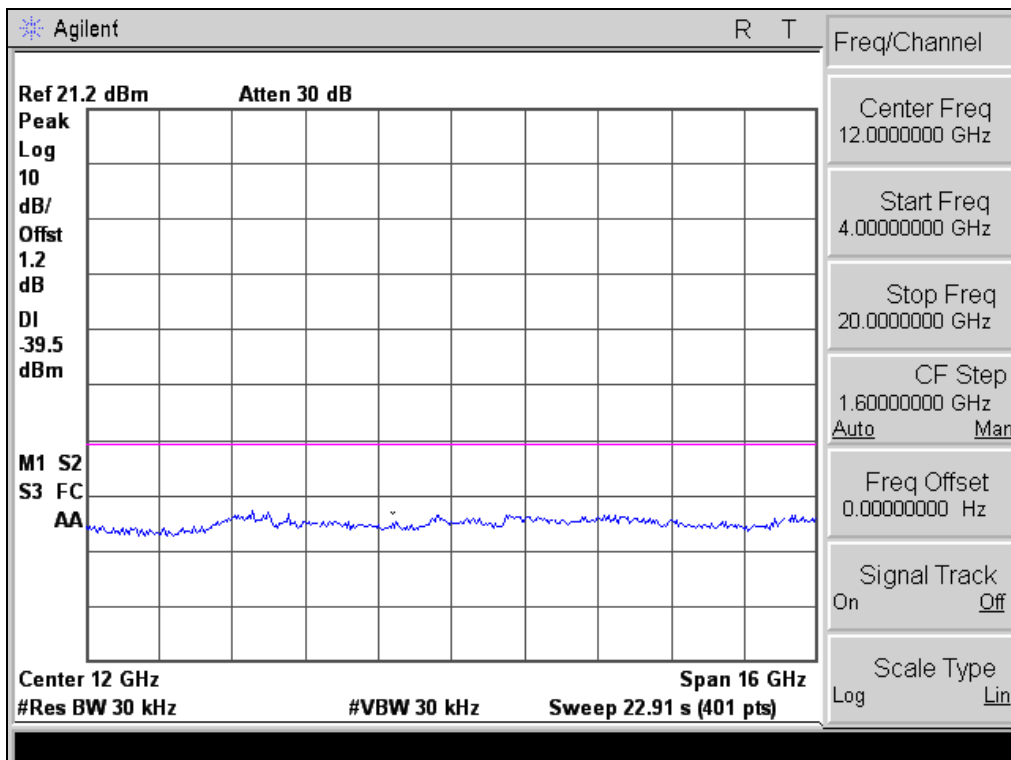

- Out-of-band emission of Ch1 -

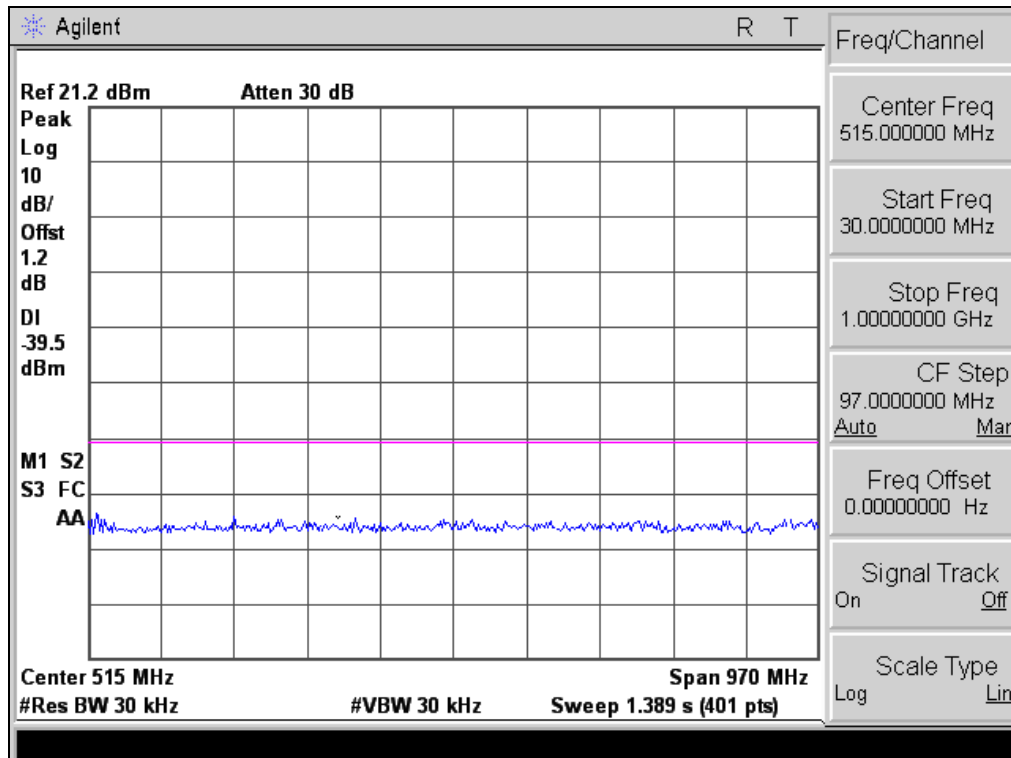

- Out-of-band emission of Ch3 -

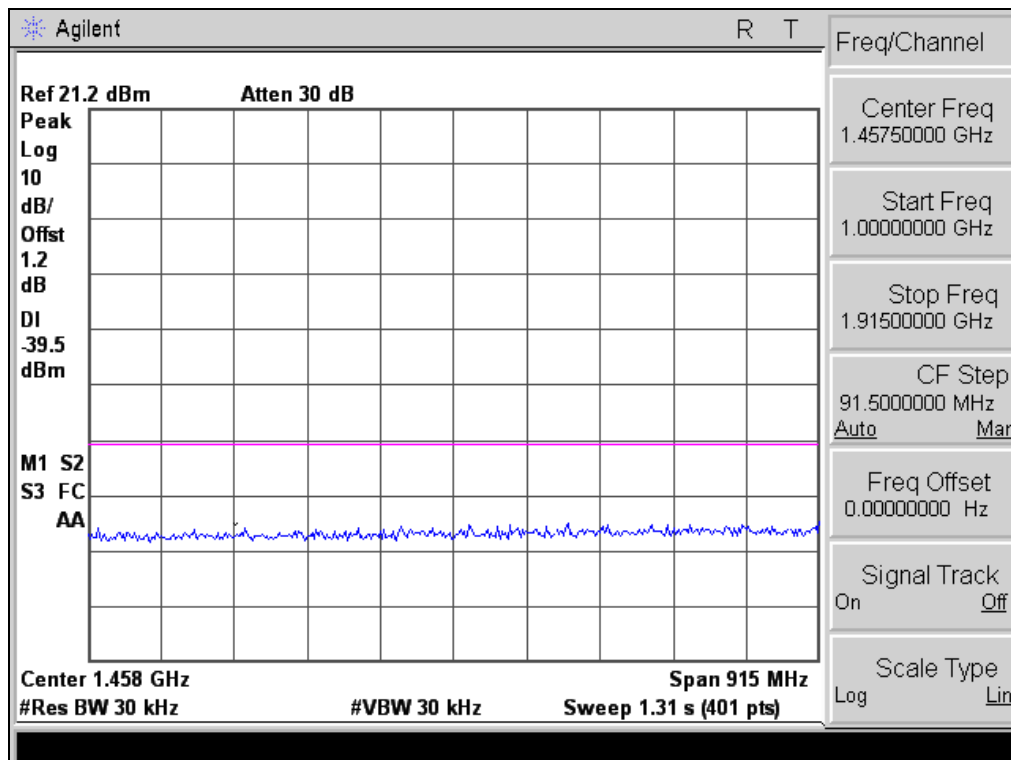

- Out-of-band emission of Ch3 -

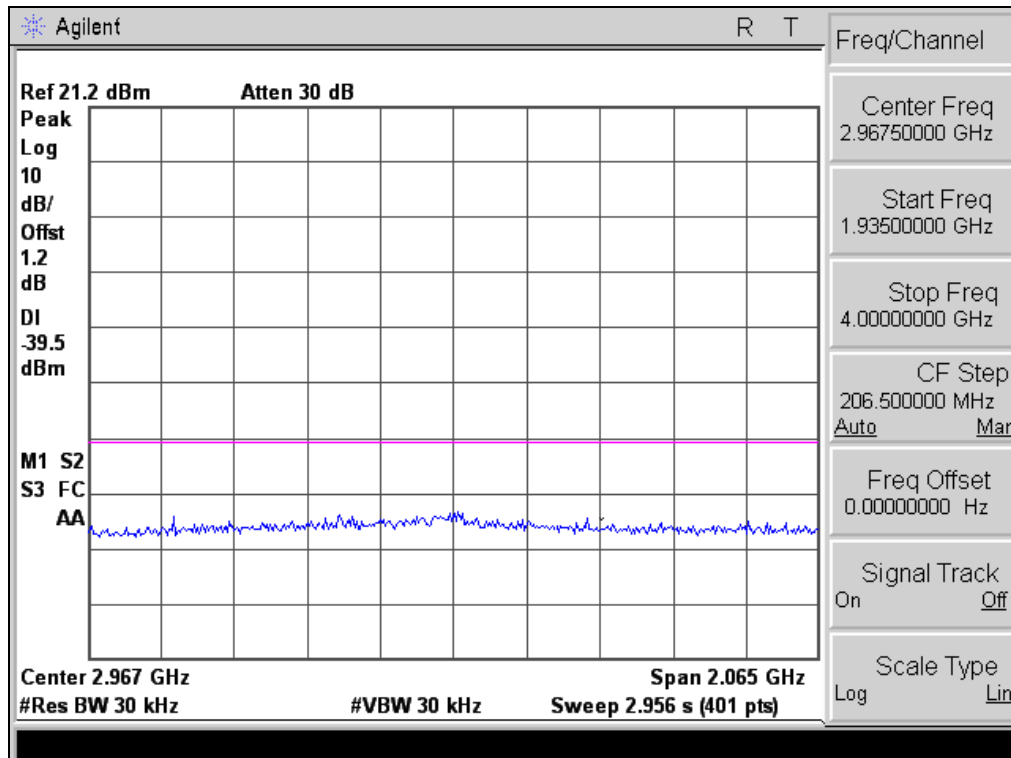

- Out-of-band emission of Ch3 -

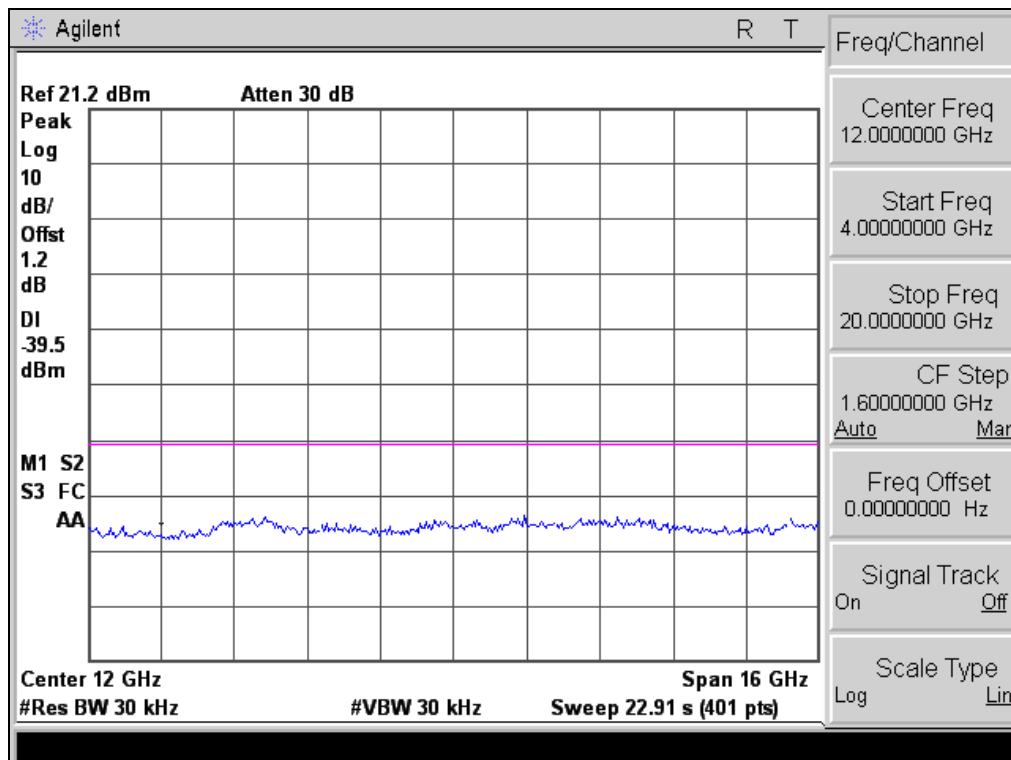

- Out-of-band emission of Ch3 -

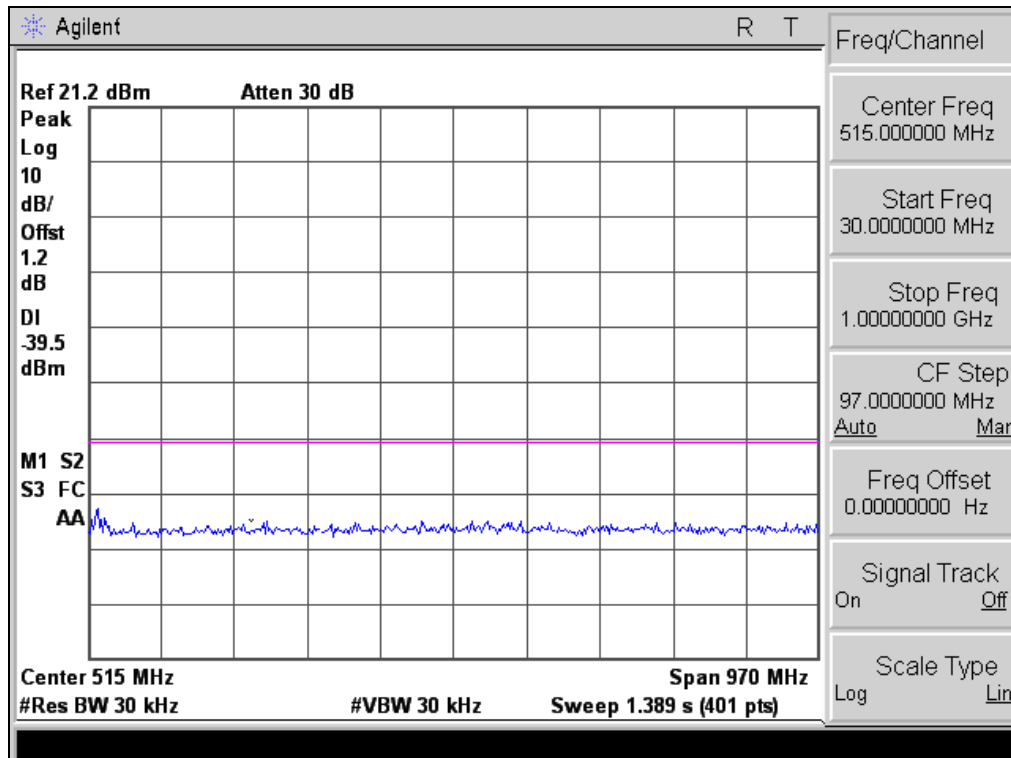

- Out-of-band emission of Ch5 -

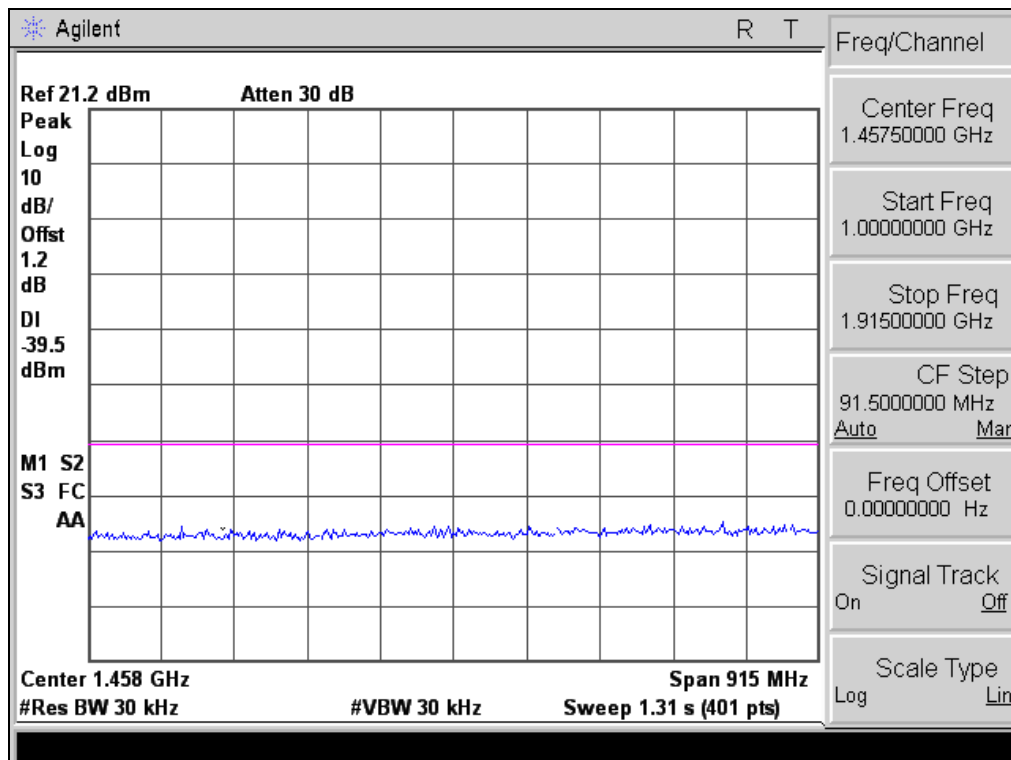

- Out-of-band emission of Ch5 -

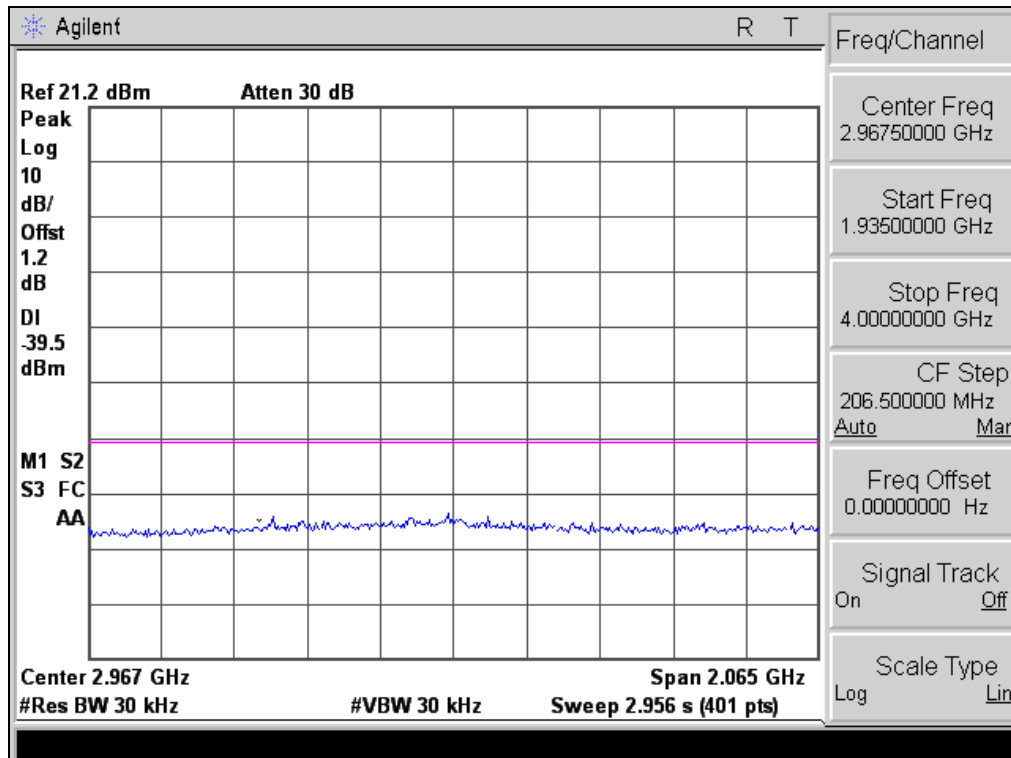

- Out-of-band emission of Ch5 -

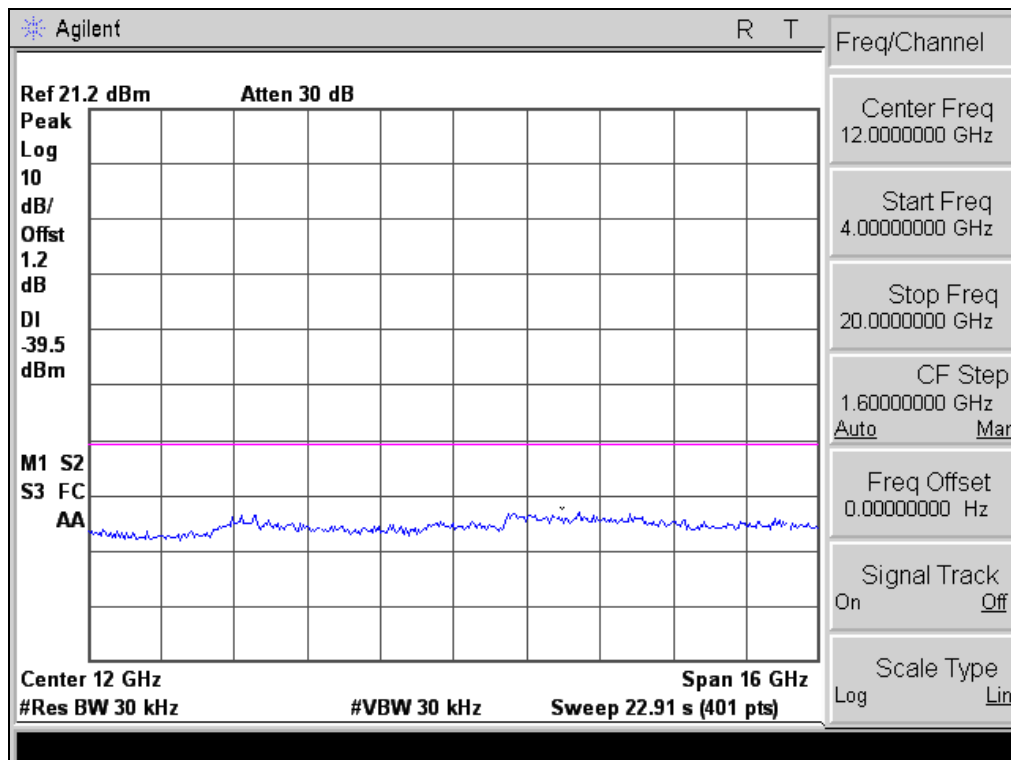

- Out-of-band emission of Ch5 -

3.11 Carrier frequency stability

3.11.1 Test limit - FCC 15.319(f)

(f) The frequency stability of the carrier frequency of the intentional radiator shall be maintained within ± 10 ppm over 1 hour or the interval between channel access monitoring, whichever is shorter. The frequency stability shall be maintained over a temperature variation of -20° to $+50^{\circ}$ degrees C at normal supply voltage, and over a variation in the primary supply voltage of 85 percent to 115 percent of the rated supply voltage at a temperature of 20° C. For equipment that is capable only of operating from a battery, the frequency stability tests shall be performed using a new battery without any further requirement to vary supply voltage.

3.11.2 Test procedure - ANSI C63.17 sub-clause 6.1.2.

3.11.3 Test results

I . Carrier Frequency Stability over time

| Supply Voltage | Temperature (°C) | Peak to Peak Diff (kHz) | Max Dev.(ppm) | Limit (ppm) | Verdict |
|------------------|------------------|-------------------------|---------------|-------------|----------|
| V _{nom} | +23 | +2.10 | +1.09 | ± 10 | Complies |

II . Carrier Frequency Stability over Power Supply Voltage

| Supply Voltage | Temperature (°C) | Measured Maximum Frequency Offset Over an hour (ppm) | Limit (ppm) | Verdict |
|----------------|------------------|--|-------------|----------|
| 85 % | +23 | +2.35 | ± 10 | Complies |
| 115% | +23 | +2.33 | ± 10 | Complies |

v

III. Carrier Frequency Stability over Temperature

| Supply Voltage | Temperature (°C) | Measured Maximum Frequency Offset Over an hour (ppm) | Limit (ppm) | Verdict |
|----------------|------------------|--|-------------|----------|
| Nominal | -20 | +8.80 | ± 10 | Complies |
| Nominal | +50 | -6.20 | ± 10 | Complies |

3.12 Frame repetition stability

3.12.1 Test limit - FCC 15.319(e)

(e) The frame period (a set of consecutive time slots in which the position of each time slot can be identified by reference to a synchronizing source) of an intentional radiator operating in these subbands shall be 20 milliseconds/X where X is a positive whole number. Each device that implements time division for the purposes of maintaining a duplex connection on a given frequency carrier shall maintain a frame repetition rate with a frequency stability of at least 50 parts per millions (ppm). Each device which further divides access in time in order to support multiple communication links on a given frequency carrier shall maintain a frame repetition rate with a frequency stability of at least 10 ppm. The jitter (time-related, abrupt, spurious variations in the duration of the frame interval) introduced at the two ends of such a communication link shall not exceed 25 microseconds for any two consecutive transmissions. Transmissions shall be continuous in every time and spectrum window during the frame period defined for the device.

Limit :

| | |
|----------------------------------|----------------|
| Frame Repetition Stability (ppm) | ±10 ppm (TDMA) |
|----------------------------------|----------------|

3.12.2 Test procedure - ANSI C63.17 sub-clause 6.2.2.

3.12.3 Test results

| Maximum Frame Repetition Stability (ppm) | Limit (ppm) | Verdict |
|--|-------------|----------|
| -0.48 | 10 | Complies |

3.13 Frame Period and Jitter

3.13.1 Test limit - FCC 15.319(e)

(e) The frame period (a set of consecutive time slots in which the position of each time slot can be identified by reference to a synchronizing source) of an intentional radiator operating in these subbands shall be 20 milliseconds/X where X is a positive whole number. Each device that implements time division for the purposes of maintaining a duplex connection on a given frequency carrier shall maintain a frame repetition rate with a frequency stability of at least 50 parts per millions (ppm). Each device which further divides access in time in order to support multiple communication links on a given frequency carrier shall maintain a frame repetition rate with a frequency stability of at least 10 ppm. The jitter (time-related, abrupt, spurious variations in the duration of the frame interval) introduced at the two ends of such a communication link shall not exceed 25 microseconds for any two consecutive transmissions. Transmissions shall be continuous in every time and spectrum window during the frame period defined for the device.

3.13.2 Test procedure - ANSI C63.17 sub-clause 6.2.3.

3.13.3 Test results

| Measured Maximum Jitter (μ s) | Lmiit (μ s) | Verdict |
|------------------------------------|------------------|----------|
| +0.05 | 25 | Complies |

3.14 Monitoring time

3.14.1 Test limit - FCC 15.319(e)

- (c) Devices must incorporate a mechanism for monitoring the time and spectrum windows that its transmission is intended to occupy. The following criteria must be met:
- (1) Immediately prior to initiating transmission, devices must monitor the combined time and spectrum windows in which they intend to transmit for a period of at least 10 milliseconds for systems designed to use a 10 millisecond or shorter frame period or at least 20 milliseconds for systems designed to use a 20 millisecond frame period.

3.14.2 Test procedure - ANSI C63.17 sub-clause 7.3.4.

3.14.3 Test results

| Measured monitoring time (ms) | Lmiit (ms) | Verdict |
|-------------------------------|--------------------|----------|
| 216 | greater than 10 ms | Complies |

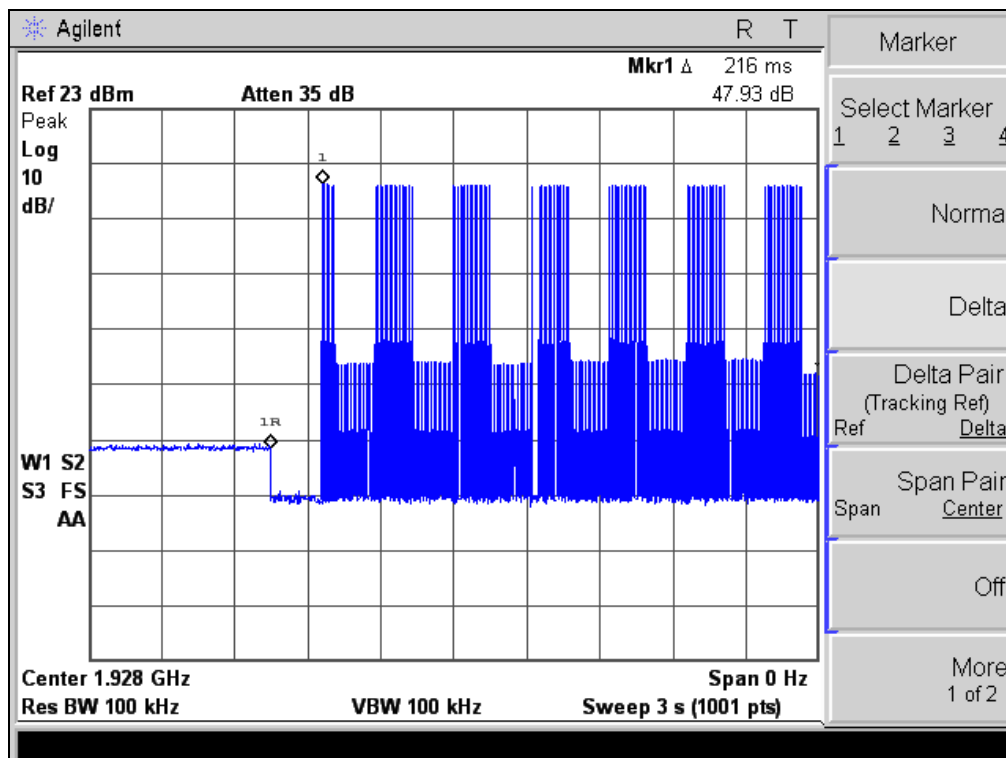

– Monitoring time –

3.15 Monitoring threshold

3.15.1 Test limit - FCC 15.323(c)(2)(9)

- (c) Devices must incorporate a mechanism for monitoring the time and spectrum windows that its transmission is intended to occupy. The following criteria must be met:
 - (2) The monitoring threshold must not be more than 30 dB above the thermal noise power for a bandwidth equivalent to the emission bandwidth of the device.
 - (9) Devices that have a power output lower than the maximum permitted under the rules may increase their monitoring detection threshold by one decibel for each one decibel that the transmitter power is below the maximum permitted.

3.15.2 Test procedure - ANSI C63.17 sub-clause 7.3.1.

Calculation of Monitoring Threshold Limit:

Lower monitoring threshold : $T_L \leq (-174 + 10\log B + M_L + P_{MAX} - P_{EUT})$ dBm

Upper monitoring threshold : $T_U \leq (-174 + 10\log B + M_U + P_{MAX} - P_{EUT})$ dBm

Where, B = Measured Emission Bandwidth : 1.484×10^6 Hz

M = 30 dB for Lower Monitoring Threshold / 50 dB for Upper Monitoring Threshold

$P_{MAX} = 5\log_{10} B - 10$ dBm = 20.86 dBm

P_{EUT} = Measured Peak Transmit Power : 20.56 dBm

| | |
|---|--------|
| Calculated lower Monitoring Threshold (dBm) | -81.99 |
| Calculated upper Monitoring Threshold (dBm) | -61.99 |

3.15.3 Test results

The Upper Threshold is applicable for systems with more than 40 duplex system access channels and that implements the Least Interfered Channel Procedure (LIC).

| | | |
|----------------------------------|-------|------|
| Lower Monitoring Threshold (dBm) | -- | N/A |
| Upper Monitoring Threshold (dBm) | 63.05 | Pass |

3.16 Maximum transmit time

3.16.1 Test limit - FCC 15.323(c)(3)

- (c) Devices must incorporate a mechanism for monitoring the time and spectrum windows that its transmission is intended to occupy. The following criteria must be met:
- (3) If no signal above the threshold level is detected, transmission may commence and continue with the same emission bandwidth in the monitored time and spectrum windows without further monitoring. However, occupation of the same combined time and spectrum windows by a device or group of cooperating devices continuously over a period of time longer than 8 hours is not permitted without repeating the access criteria.

3.16.2 Test procedure - ANSI C63.17 sub-clause 8.2.2.

3.16.3 Test results

| Measured Maximum Transmission duration (sec) | Limit (sec) | Verdict |
|--|-------------|----------|
| 2,520 | 28,800 | Complies |

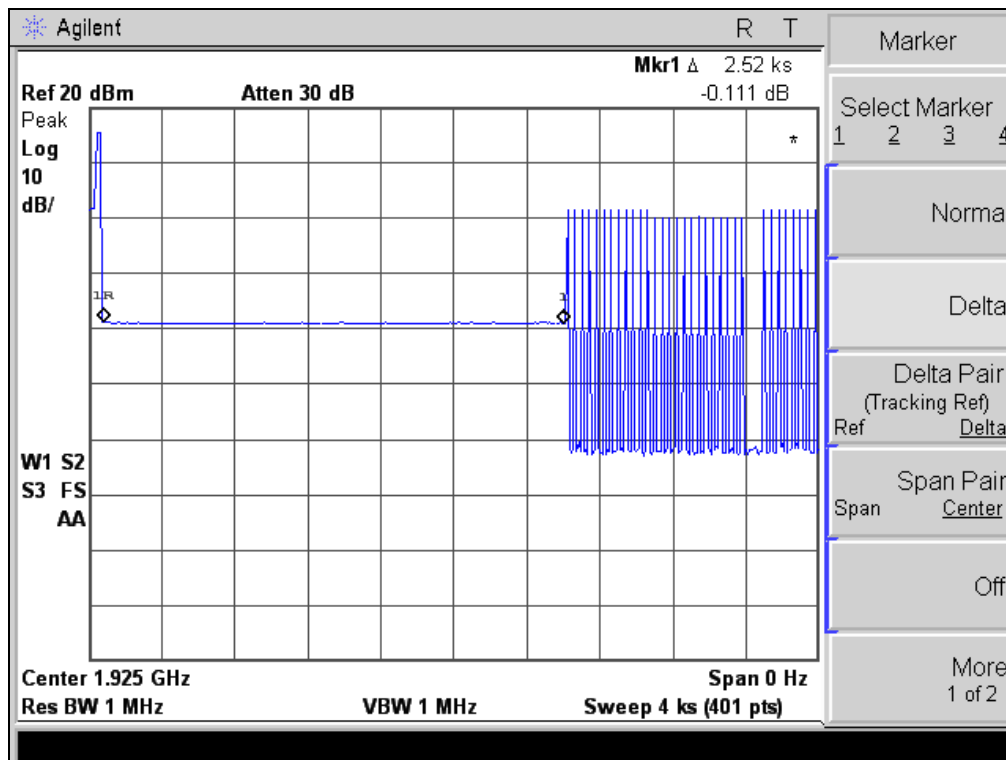

– Maximum transmit time –

3.17 System acknowledgement

3.17.1 Test limit - FCC 15.323(c)(4)

- (c) Devices must incorporate a mechanism for monitoring the time and spectrum windows that its transmission is intended to occupy. The following criteria must be met:
- (4) Once access to specific combined time and spectrum windows is obtained an acknowledgement from a system participant must be received by the initiating transmitter within one second or transmission must cease. Periodic acknowledgements must be received at least every 30 seconds or transmission must cease. Channels used exclusively for control and signalling information may transmit continuously for 30 seconds without receiving an acknowledgement, at which time the access criteria must be repeated.

3.17.2 Test procedure - ANSI C63.17 sub-clause 8.1.1 & 8.2.1

3.17.3 Test results

| Test | Result (s) | Limit (s) | Verdict |
|--|------------|-----------|----------------------------|
| Initial transmission without acknowledgements | N/A | N/A | Only for initiating device |
| Transmission time after loss of acknowledgements | 1.83 | 30 | Complies |

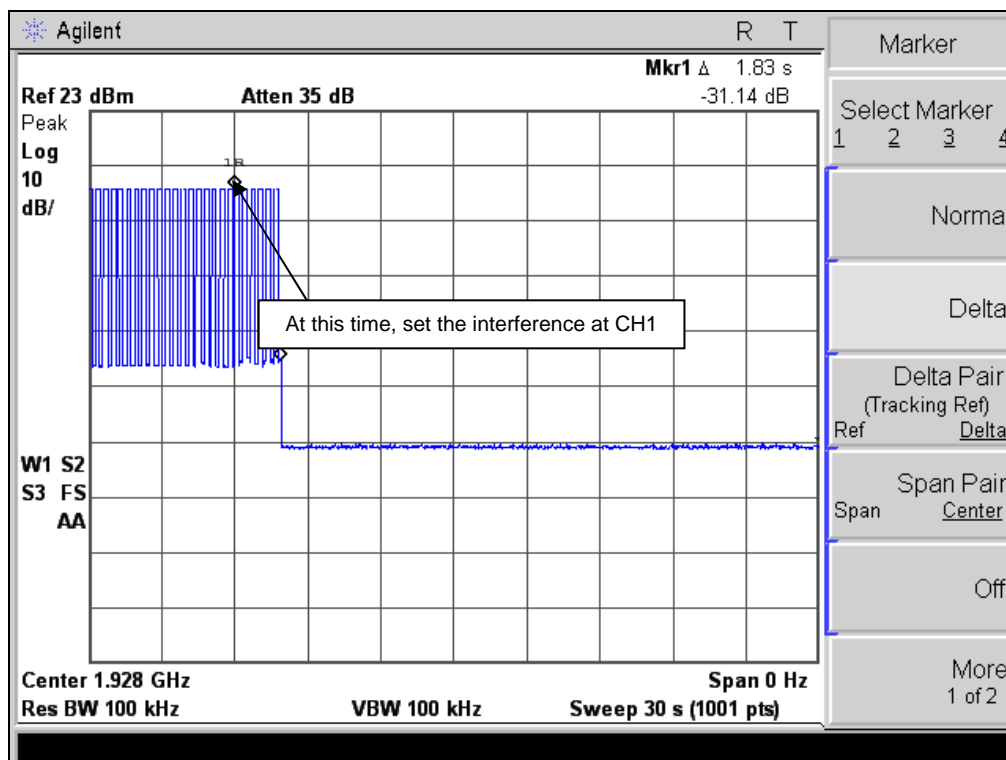

– Transmission time after loss of acknowledgements –

3.18 Least Interfered Channel & Channel confirmation

3.18.1 Test limit - FCC 15.323(c)(5)

- (c) Devices must incorporate a mechanism for monitoring the time and spectrum windows that its transmission is intended to occupy. The following criteria must be met:
- (5) If access to spectrum is not available as determined by the above, and a minimum of 40 duplex system access channels are defined for the system, the time and spectrum windows with the lowest power level below a monitoring threshold of 50 dB above the thermal noise power determined for the emission bandwidth may be accessed.

3.18.2 Test procedure - ANSI C63.17 sub-clause 7.3.3

Calculated Lower monitoring threshold : -81.99 dBm
 Calculated Upper monitoring threshold : -61.99 dBm

The upper threshold is applicable for systems with more than 40 duplex system access channels and that implements the Least Interfered Channel Procedure (LIC).

3.18.3 Test results

| Test | Results | Verdict |
|--|----------------------------|----------|
| Apply interference on CH1 at level T_L+U_m+7 dB Apply interference on CH5 at level T_L+U_m dB | Transmission always on CH5 | Complies |
| Apply interference on CH1 at level T_L+U_m dB Apply interference on CH5 at level T_L+U_m+7 dB | Transmission always on CH1 | Complies |
| Apply interference on CH1 at level T_L+U_m+1 dB Apply interference on CH5 at level T_L+U_m-6 dB | Transmission always on CH5 | Complies |
| Apply interference on CH1 at level T_L+U_m-6 dB Apply interference on CH5 at level T_L+U_m+1 dB | Transmission always on CH1 | Complies |

3.19 Random waiting

3.19.1 Test limit - FCC 15.323(c)(6)

- (c) Devices must incorporate a mechanism for monitoring the time and spectrum windows that its transmission is intended to occupy. The following criteria must be met:
- (6) If the selected combined time and spectrum windows are unavailable, the device may either monitor and select different windows or seek to use the same windows after waiting an amount of time, randomly chosen from a uniform random distribution between 10 and 150 milliseconds, commencing when the channel becomes available.

3.19.2 Test procedure - ANSI C63.17 sub-clause 8.1.3

3.19.3 Attestation

The option 15.323(c)(6) is not implemented by this product.

3.20 Monitoring Bandwidth

3.20.1 Test limit - FCC 15.323(c)(7)

- (c) Devices must incorporate a mechanism for monitoring the time and spectrum windows that its transmission is intended to occupy. The following criteria must be met:
- (7) The monitoring system bandwidth must be equal to or greater than the emission bandwidth of the intended transmission and have a maximum reaction time less than $50 \times \text{SQRT}(1.25/\text{emission bandwidth in MHz})$ microseconds for signals at the applicable threshold level but shall not be required to be less than 50 microseconds.

3.20.2 Test procedure - ANSI C63.17 sub-clause 7.4.2 – more detailed test

3.20.3 Test results

| Test frequency | Test level (above T_U+U_M) | Result | Verdict |
|----------------|-------------------------------|-----------------|----------|
| -6 dB points | -55.99 dBm | No transmission | Complies |
| -12 dB points | -49.99 dBm | No transmission | Complies |

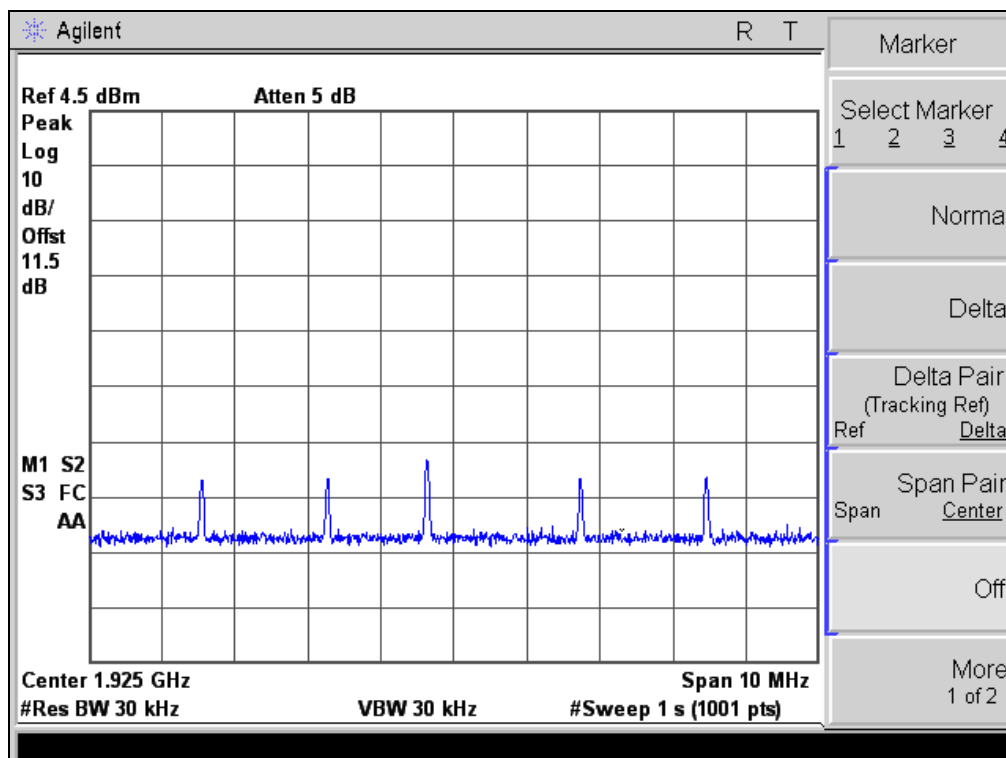

– Interference level on -6 dB lower point –

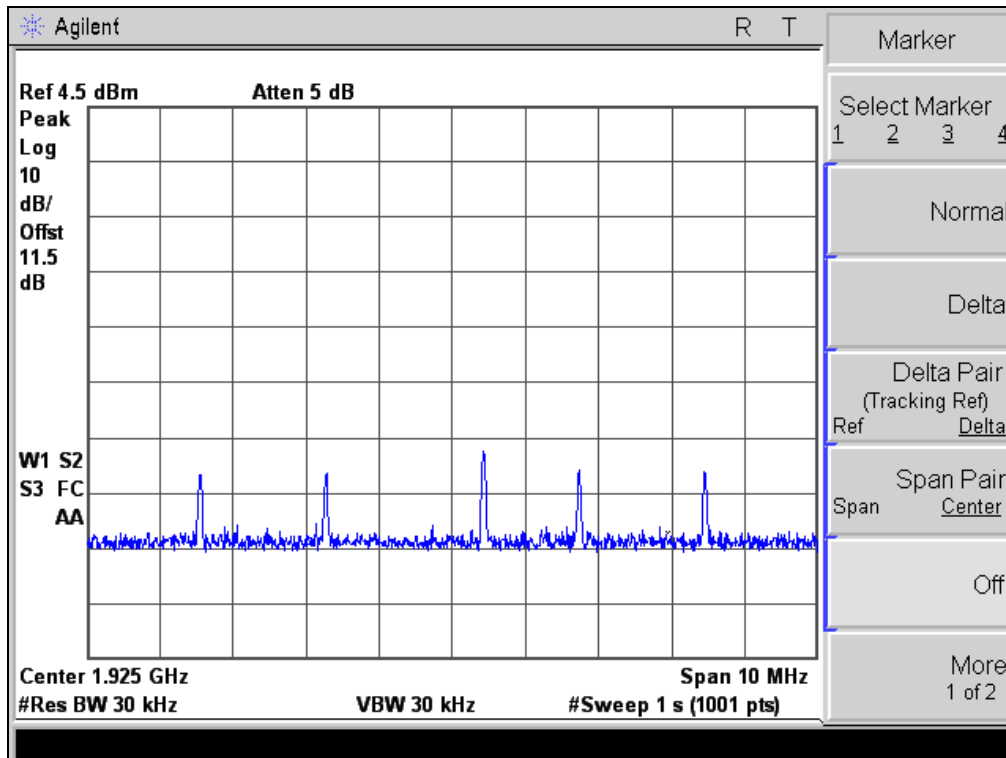

– Interference level on +6 dB higher point –

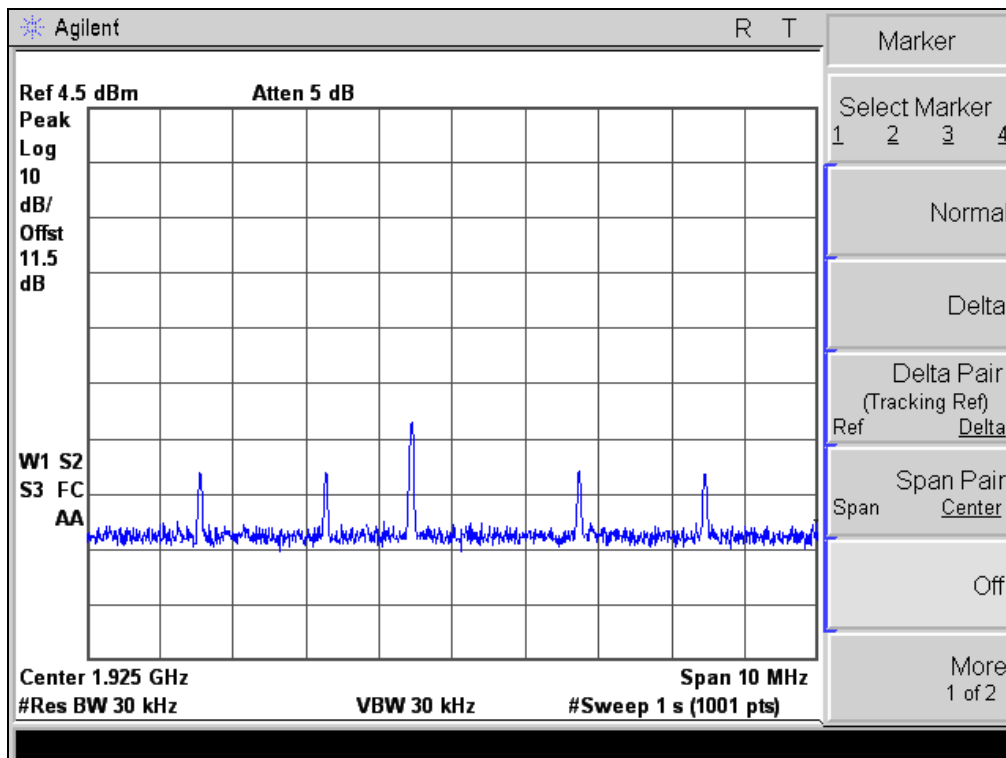

– Interference level on -12 dB lower point –

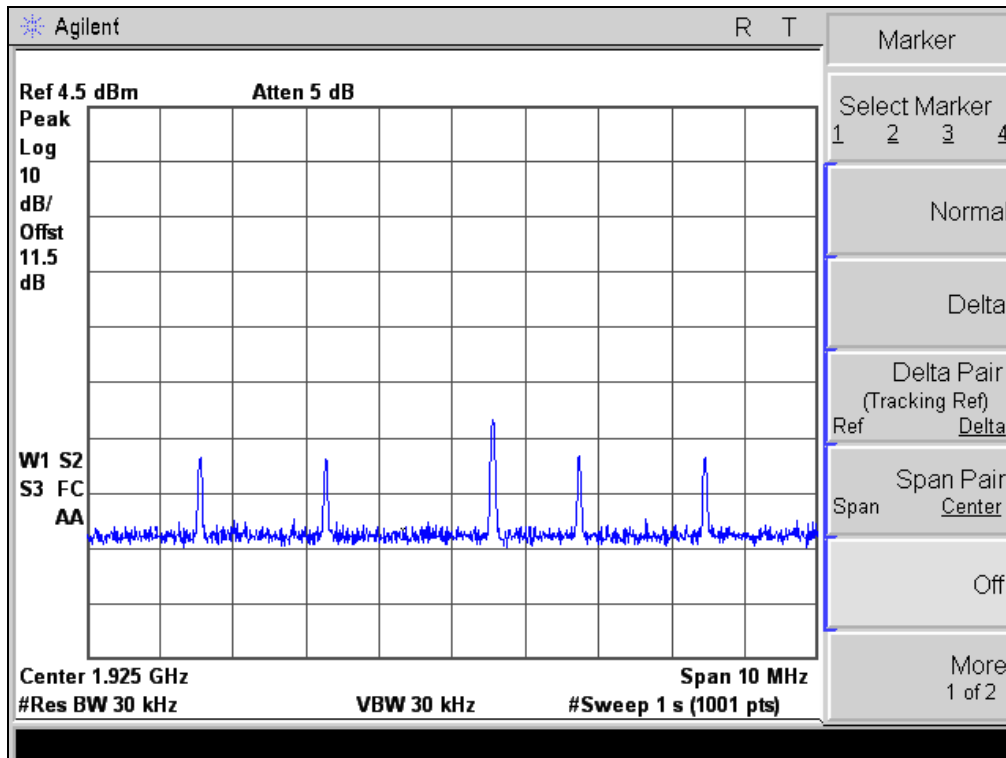

– Interference level on +12 dB higher point –

3.21 Maximum reaction time

3.21.1 Test limit - FCC 15.323(c)(7)

- (c) Devices must incorporate a mechanism for monitoring the time and spectrum windows that its transmission is intended to occupy. The following criteria must be met:
- (7) If a signal is detected that is 6 dB or more above the applicable threshold level, the maximum reaction time shall be $35 \times \text{SQRT}(1.25/\text{emission bandwidth in MHz})$ microseconds but shall not be required to be less than 35 microseconds.

3.21.2 Test procedure - ANSI C63.17 sub-clause 7.5.

3.21.3 Test results

| Pulse Width | Results | Verdict |
|-------------|-----------------|----------|
| 35 us | No transmission | Complies |
| 50 us | No transmission | Complies |

* Since Emission bandwidth is greater than 1.25 MHz the test was performed with pulse lengths 35 & 50 us.

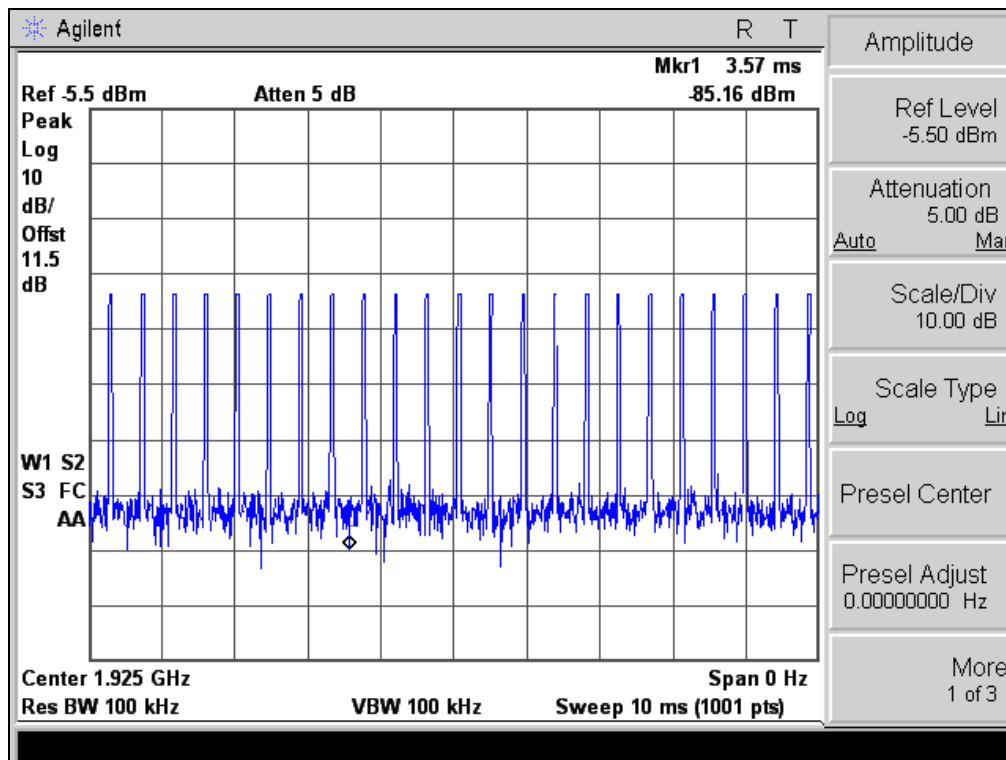

- 35 μ s Pulses -

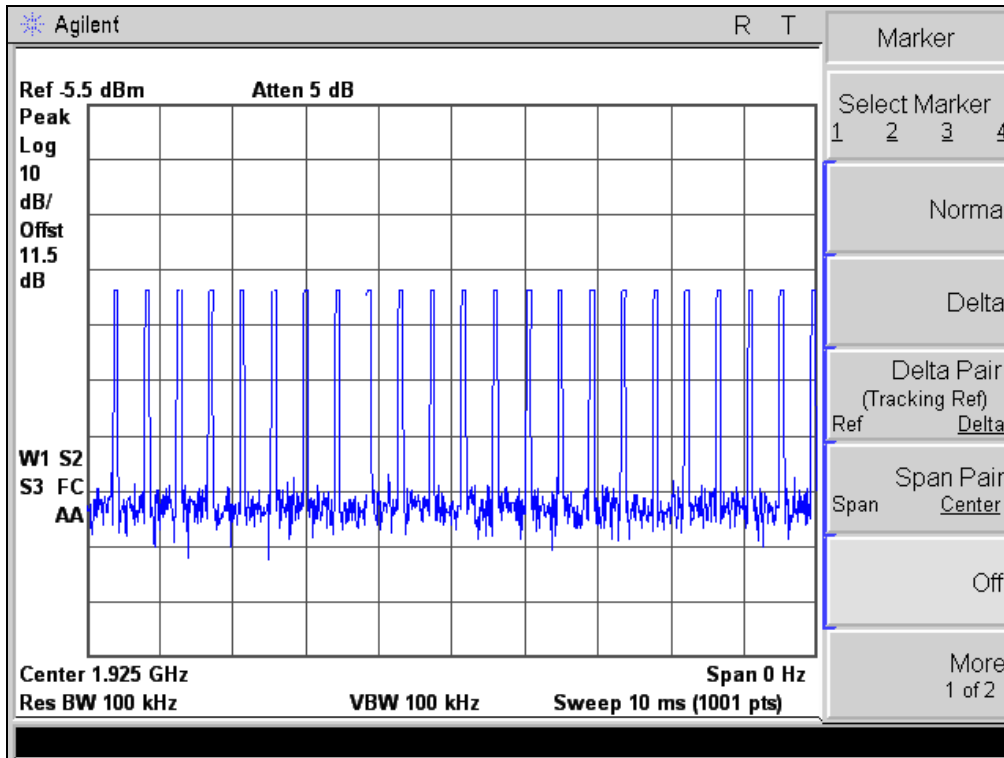

- 50 μ s pulses -

3.22 Monitoring antenna

3.22.1 Test limit - FCC 15.323(c)(8)

- (c) Devices must incorporate a mechanism for monitoring the time and spectrum windows that its transmission is intended to occupy. The following criteria must be met:
- (8) The monitoring system shall use the same antenna used for transmission, or an antenna that yields equivalent reception at that location.

3.22.2 Test procedure - ANSI C63.17 sub-clause 4

3.22.3 Attestation

EUT uses the same antenna used for transmission and monitoring that is in compliance meet above provision.

3.23 Duplex Connections

3.23.1 Test limit - FCC 15.323(c)(10)

- (c) Devices must incorporate a mechanism for monitoring the time and spectrum windows that its transmission is intended to occupy. The following criteria must be met:
- (10) An initiating device may attempt to establish a duplex connection by monitoring both its intended transmit and receive time and spectrum windows. If both the intended transmit and receive time and spectrum windows meet the access criteria, then the initiating device can initiate a transmission in the intended transmit time and spectrum window. If the power detected by the responding device can be decoded as a duplex connection signal from the initiating device, then the responding device may immediately begin transmitting on the receive time and spectrum window monitored by the initiating device.

3.23.2 Test procedure - ANSI C63.17 sub-clause 8.3.2

3.23.3 Attestation

The EUT never initiates a communication link.

3.24 Alternative Monitoring Interval for Co-located Device

3.24.1 Test limit - FCC 15.323(c)(11)

- (c) Devices must incorporate a mechanism for monitoring the time and spectrum windows that its transmission is intended to occupy. The following criteria must be met:
- (11) An initiating device that is prevented from monitoring during its intended transmit window due to monitoring system blocking from the transmissions of a co-located (within one meter) transmitter of the same system, may monitor the portions of the time and spectrum windows in which they intend to receive over a period of at least 10 milliseconds. The monitored time and spectrum window must total at least 50 percent of the 10 millisecond frame interval and the monitored spectrum must be within 1.25 MHz of the center frequency of channel(s) already occupied by that device or collocated co-operating devices. If the access criteria is met for the intended receive time and spectrum window under the above conditions, then transmission in the intended transmit window by the initiating device may commence.

3.24.2 Test procedure - ANSI C63.17 sub-clause 8.4.

3.24.3 Attestation

The EUT never initiates a communication link.

4. Self Declaration

| | | | |
|-------------------------|---|------------------|-----------------|
| Applicant Name | LG-Ericsson Co.,Ltd. | | |
| Address | 533, Hogye-1dong, Dongan-gu, Anyang-si, Gyeonggi-do, 431-749, Korea | | |
| Contact person | James Kang | | |
| E-mail address | korjunma@lgericsson.com | | |
| Phone No. | +82 31 450 4803 | Fax No. : | +82 31 450 4745 |
| Manufacture Name | LN Srithai Comm Co.,Ltd. | | |
| Address | 71/12 Moo 5 Bangna Trad Rd. KM 52 ThakarmBanpakong Chachoengsao 24130, Thailand | | |

| | | |
|--|--|----------------|
| Model name | SBG-1000 | |
| FCC ID | TUISBG-1000 | |
| IC Number | 6241A-SBG1000 | |
| | | Remarks |
| Does a system built with the EUT that implement the provisions Of 47CFR 15.323(C)(5) enabling the use of the upper threshold For deferral? | <input checked="" type="checkbox"/> Yes <input type="checkbox"/> No | |
| According to 47CFR 15.323(C)(5).4, does your model not use Bandwidth in further cooperation with other devices at any Range? | <input checked="" type="checkbox"/> Yes <input type="checkbox"/> No | |
| Does a system built using the EUT that operate under the Provisions of 47CFR 15.323(c)(6) incorporating provisions for Waiting for a channel to go clear? | <input type="checkbox"/> Yes <input checked="" type="checkbox"/> No | |
| According to 47CFR15.323(C)(8), does EUT use the same Antennas for transmission and reception as for monitoring? | <input checked="" type="checkbox"/> Yes <input type="checkbox"/> No | |
| Does a system built with the EUT that operate under the Provisions of 47CFR 15.323(C)(10) to test for deferral only in Conjunction with a companion device? | <input type="checkbox"/> Yes <input checked="" type="checkbox"/> No | |
| Does a system built with the EUT that operate under the Provisions of 47CFR 15.323(C)(11) enabling the access criteria Check on the receive channel while in the presence of Collocated interferers? | <input type="checkbox"/> Yes <input checked="" type="checkbox"/> No | |
| According to 47CFR15.323(C)(12), does EUT not work in a Mode with denies fair access to spectrum for other devices. | <input checked="" type="checkbox"/> Yes <input type="checkbox"/> No | |

Signed by : Kang Sang Jin (James Kang)
Date: January 31, 2011

signature:

James KANG

5. TEST SET UP

5.1 Frequency & Timing Measurement

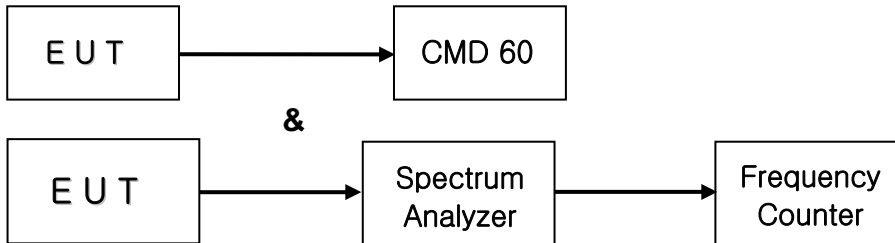

5.2 Monitoring Tests

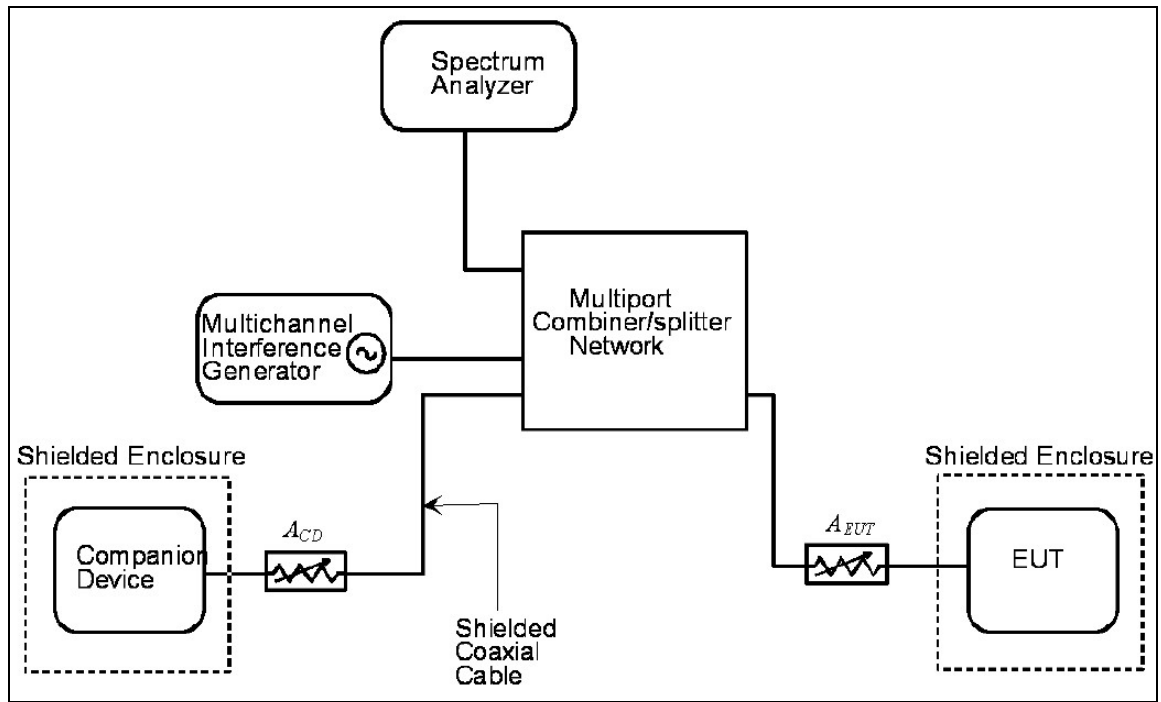

6. TEST EQUIPMENT

| No. | Equipment | Manufacturer | Model | S/N |
|-----|------------------------------|---------------------|----------|------------|
| 1 | Spectrum Analyzer | Agilent | E4407B | US41443316 |
| 2 | Synthesized Sweeper | HP | 83620A | 3250A01653 |
| 3 | Digital RF Signal Generator | Agilent | E4438C | US41460859 |
| 4 | Signal Generator | R&S | SMIQ O3 | DE22348 |
| 5 | Spectrum Analyzer | Agilent | E4407B | US41443316 |
| 6 | PSA Series Spectrum Analyzer | Agilent | E4448A | US44300484 |
| 7 | DC Power Supply | Agilent | E4356A | MY41000296 |
| 8 | DC Power Supply | Agilent | E3645A | MY40000851 |
| 9 | Oscilloscope | Tektronix | TDS3052B | B010173 |
| 10 | Directional Coupler | Agilent | 87300C | MY44300126 |
| 11 | Directional Coupler | Agilent | 773D | MY28390213 |
| 12 | VHF Attenuator | HP | 355D | 2522A45959 |
| 13 | Coaxial Attenuator | TenuLine | 8340-200 | 1087 |
| 14 | Coaxial Attenuator | TenuLine | 8080 | 7676 |
| 15 | Power Divider | HP | 11636A | 6047 |
| 16 | Power Splitter | HP | 11667A | 21063 |
| 17 | Frequency Counter | Anritsu | MF2412B | 2108A07645 |
| 18 | Synthesizer/Level Generator | HP | 3336C | 2903A02111 |
| 19 | Temp/Humidity Chamber | Korea Power Machine | HI-5050 | HI200420 |

| No. | Equipment | Manufacturer | Model | S/N |
|-----|---------------------------------------|--------------|----------|------------|
| 20 | Function/Arbitrary Waveform Generator | Agilent | 33250A | MY40015646 |
| 21 | EMI Receiver | R&S | ESCS30 | 100206 |
| 22 | EMI Receiver | R&S | ESPI | 100043 |
| 23 | Pre-Amplifier | HP | 8347A | 2834A00543 |
| 24 | Pre-Amplifier | HP | 8449B | 3008A00302 |
| 25 | Log-Periodic Antenna | ETS-Lindgren | 3148 | 5051 |
| 26 | Tuned Dipole Antenna | Schwarzbeck | VHA 9103 | -- |
| 27 | Biconi-Log Antenna | ETS-Lindgren | 3142B | 00023784 |
| 28 | Double Ridge Wave Guide | ETS-Lindgren | 3115 | 6913 |