

# TEST REPORT

of

FCC Part 15 Subpart C §15.247

FCC ID : TQ8-AC214HGGG

Equipment Under Test : DIGITAL CAR AUDIO SYSTEM  
Model Name : AC214HGGG (Alt. AC214HGGN)  
Applicant : Hyundai MOBIS Co., Ltd.  
Manufacturer : Hyundai MOBIS Co., Ltd.  
Date of Test(s) : 2014. 02. 05 ~ 2014. 02. 12  
Date of Issue : 2014. 02. 12

In the configuration tested, the EUT complied with the standards specified above.

Tested By:



Date:

2014. 02. 12

Youngmin Park

Approved By:



Date:

2014. 02. 12

Logan Lee

*The results shown in this test report refer only to the sample(s) tested unless otherwise stated. This test report cannot be reproduced, except in full, without prior written permission of the Company.*

---

# INDEX

<u>Table of Contents</u>	Page
1. General Information -----	3
2. Transmitter Radiated Spurious Emissions and Conducted Spurious Emission -----	7
3. 20 dB Bandwidth-----	35
4. Maximum Peak Output Power -----	42
5. Hopping Channel Separation -----	44
6. Number of Hopping Frequency -----	47
7. Time of Occupancy(Dwell Time) -----	51
8. Antenna Requirement -----	65

---

*The results shown in this test report refer only to the sample(s) tested unless otherwise stated. This test report cannot be reproduced, except in full, without prior written permission of the Company.*

## 1. General Information

### 1.1. Testing Laboratory

SGS Korea Co., Ltd. (Gunpo Laboratory)

- Wireless Div. 3FL, 4, LS-ro 182beon-gil, Gunpo-si, Gyeonggi-do, Korea, 435-040

All SGS services are rendered in accordance with the applicable SGS conditions of service available on request and accessible at <http://www.sgs.com/en/Terms-and-Conditions.aspx>.

Telephone : +82 31 428 5700

FAX : +82 31 427 2370

### 1.2. Details of Applicant

Applicant : Hyundai MOBIS Co., Ltd.

Address : 203, Teheran-ro, Gangnam-gu, Seoul, 135-977, Korea

Contact Person : Choi, Seung-Hoon

Phone No. : +82 31 260 0098

### 1.3. Description of EUT

<b>Kind of Product</b>	DIGITAL CAR AUDIO SYSTEM
<b>Model Name</b>	AC214HGGG (Alt. AC214HGGN)
<b>Power Supply</b>	DC 14.4 V
<b>Frequency Range</b>	2 402 MHz ~ 2 480 MHz
<b>Modulation Technique</b>	GFSK, $\pi/4$ DQPSK, 8DPSK
<b>Number of Channels</b>	79
<b>Antenna Type</b>	Chip antenna
<b>Antenna Gain</b>	-5.83 dB i

### 1.4. Declaration by the manufacturer

- Adaptive Frequency Hopping is supported and use at least 20 channels

*The results shown in this test report refer only to the sample(s) tested unless otherwise stated. This test report cannot be reproduced, except in full, without prior written permission of the Company.*

**SGS Korea Co., Ltd. (Gunpo Laboratory)** 4, LS-ro 182beon-gil, Gunpo-si, Gyeonggi-do, Korea, 435-040 <http://www.sgsgroup.kr>

RTT5041-20(2014.01.20)(2)

Tel. +82 31 428 5700 / Fax. +82 31 427 2370

A4(210 mm x 297 mm)

**1.5. Information about the FHSS characteristics:**

**1.5.1. Pseudorandom Frequency Hopping Sequence**

The channel is represented by a pseudo-random hopping sequence hopping through the 79 RF channels. The hopping sequence is unique for the piconet and is determined by the Bluetooth device address of the master; the phase in the hopping sequence is determined by the Bluetooth clock of the master. The channel is divided into time slots where each slot corresponds to an RF hop frequency. Consecutive hops correspond to different RF hop frequencies. The nominal hop rate is 1 600 hops/s.

**1.5.2. Equal Hopping Frequency Use**

The selection of frequencies is equal from the inventory of available frequencies.

**1.5.3. Example of a 79 hopping sequence in data mode:**

40, 21, 44, 23, 42, 53, 46, 55, 48, 33, 52, 35, 50, 65, 54, 67, 56, 37, 60, 39, 58, 69, 62, 71, 64, 25, 68, 27, 66, 57, 70, 59, 72, 29, 76, 31, 74, 61, 78, 63, 01, 41, 05, 43, 03, 73, 07, 75, 09, 45, 13, 47, 11, 77, 15, 00, 64, 49, 66, 53, 68, 02, 70, 06, 01, 51, 03, 55, 05, 04

**1.5.4. System Receiver Input Bandwidth**

Each channel bandwidth is 1 MHz

**1.5.5. Equipment Description**

15.247(a)(1) that the rx input bandwidths shift frequencies in synchronization with the transmitted

15.247(g): In accordance with the Bluetooth Industry Standard, the system is designed to comply with all of the regulations in Section 15.247 when the transmitter is presented with a continuous data (or information) system.

15.247(h): In accordance with the Bluetooth Industry Standard, the system does not coordinate it channels selection/ hopping sequence with other frequency hopping systems for the express purpose of avoiding the simultaneous occupancy of individual hopping frequencies by multiple transmitters.

**1.6. Alternative models**

Model name	Information
AC214HGGG	- Basic model - Bluetooth, General Radio BAND, External Amplifier
AC214HGGN	- Same to basic model, but it is different below function - North America Radio BAND

*The results shown in this test report refer only to the sample(s) tested unless otherwise stated. This test report cannot be reproduced, except in full, without prior written permission of the Company.*

### 1.7. Test Equipment List

Equipment	Manufacturer	Model	S/N	Cal Date	Cal Interval	Cal Due.
Signal Generator	R&S	SMR40	100540	Jan. 08, 2014	Annual	Jan. 08, 2015
Signal Generator	Agilent	E4438C	MY42082477	Mar. 28, 2013	Annual	Mar. 28, 2014
Spectrum Analyzer	R&S	FSV30	101004	Jul. 20, 2013	Annual	Jul. 20, 2014
Bluetooth Tester	TESCOM	TC-3000C	3000C000296	Jul. 02, 2013	Annual	Jul. 02, 2014
Directional Coupler	KRYTAR	152613	127445	Jul. 02, 2013	Annual	Jul. 02, 2014
High Pass Filter	Wainwright	WHK3.0/18G-6SS	4	Jul. 02, 2013	Annual	Jul. 02, 2014
High Pass Filter	Wainwright	WHK7.5/26.5G-6SS	15	Jul. 03, 2013	Annual	Jul. 03, 2014
Low Pass Filter	Mini circuits	NLP-1200+	V9500401023-1	Jul. 02, 2013	Annual	Jul. 02, 2014
Power Sensor	R&S	NRP-Z81	101341	Jul. 04, 2013	Annual	Jul. 04, 2014
DC Power Supply	Agilent	U8002A	MY48490027	Jan. 03, 2014	Annual	Jan. 03, 2015
Preamplifier	R&S	SCU-18	10070	Jun. 21, 2013	Annual	Jun. 21, 2014
Preamplifier	H.P.	8447D	2727A05143	Aug. 08, 2013	Annual	Aug. 08, 2014
Preamplifier	MITEQ Inc.	JS44-18004000-35-8P	1546891	Jun. 13, 2013	Annual	Jun. 13, 2014
Test Receiver	R&S	ESI7	100778	Aug. 07, 2013	Annual	Aug. 07, 2014
Loop Antenna	Schwarzbeck Mess-Elektronik	FMZB 1519	1519-039	Jul. 09, 2014	Biennial	Jul. 09, 2015
Bilog Antenna	SCHWARZBECK	VULB9163	9163-437	Oct. 04, 2012	Biennial	Oct. 04, 2014
Horn Antenna	R&S	HF906	100608	Aug. 13, 2012	Biennial	Aug. 13, 2014
Horn Antenna	SCHWARZBECK	BBHA9170	BBHA9170431	May 15, 2012	Biennial	May 15, 2014
Turn Table	DT-3000S-3T	INN-CO	N/A	N.C.R.	N.C.R.	N.C.R.
Antenna Master	MA4000-EP	INN-CO	N/A	N.C.R.	N.C.R.	N.C.R.
Anechoic Chamber	SY Corporation	L x W x H (21.5 m x 13.0 m x 9.0 m)	N/A	N.C.R.	N.C.R.	N.C.R.

The results shown in this test report refer only to the sample(s) tested unless otherwise stated. This test report cannot be reproduced, except in full, without prior written permission of the Company.

## 1.8. Summary of Test Results

The EUT has been tested according to the following specifications:

APPLIED STANDARD:FCC Part15 subpart C		
Section	Test Item	Result
15.205(a) 15.209 15.247(d)	Transmitter Radiated Spurious Emissions Conducted Spurious Emission	Complied
15.247(a)(1)	20 dB Bandwidth	Complied
15.247(b)(1)	Maximum Peak Output Power	Complied
15.247(a)(1)	Frequency Separation	Complied
15.247(a)(1)(iii)	Number of Hopping Frequency	Complied
15.247(a)(1)(iii)	Time of Occupancy (Dwell Time)	Complied

## 1.9. Sample calculation

Where relevant, the following sample calculation is provided:

### 1.9.1. Conducted test

Offset value (dB) = Directional Coupler(dB) + Cable loss (dB)

### 1.9.2. Radiation test

Field strength level (dB $\mu$ V/m) = Measured level (dB $\mu$ V) + Antenna factor (dB) + Cable loss (dB) – amplifier gain (dB)

## 1.10. Test report revision

Revision	Report number	Description
0	F690501/RF-RTL007391	Initial
1	F690501/RF-RTL007391-1	Added test Equipment (Loop Antenna), Modified 1. Measurement below 30MHz, 2. Frequency Hopping Spread Spectrum Characteristics, 3. Bandedge Compliance

*The results shown in this test report refer only to the sample(s) tested unless otherwise stated. This test report cannot be reproduced, except in full, without prior written permission of the Company.*

## 2. Transmitter Radiated Spurious Emissions and Conducted Spurious Emission

### 2.1. Test Setup

#### 2.1.1. Transmitter Radiated Spurious Emissions

The diagram below shows the test setup that is utilized to make the measurements for emission from below 30 MHz Emissions.

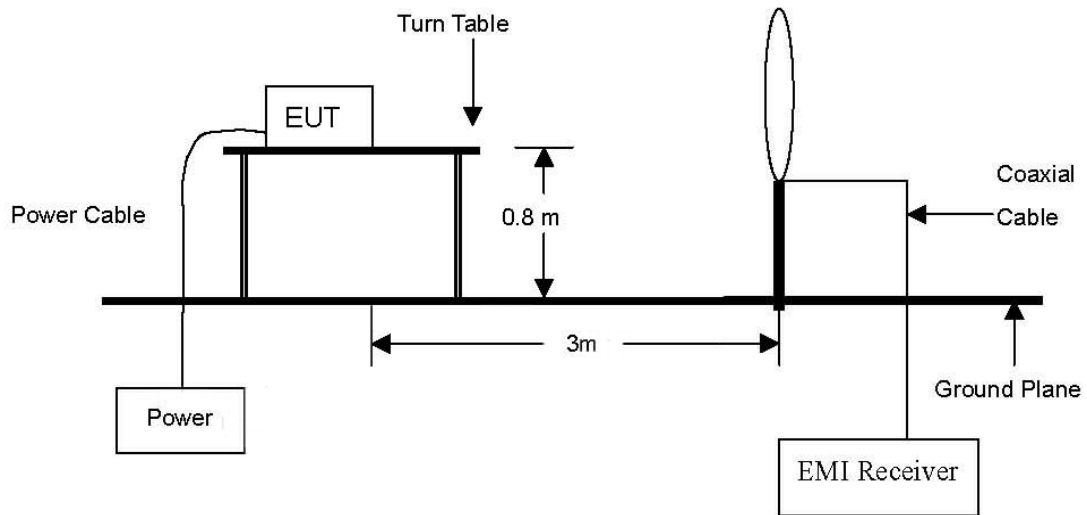

The diagram below shows the test setup that is utilized to make the measurements for emission from 30 MHz to 1 GHz Emissions.

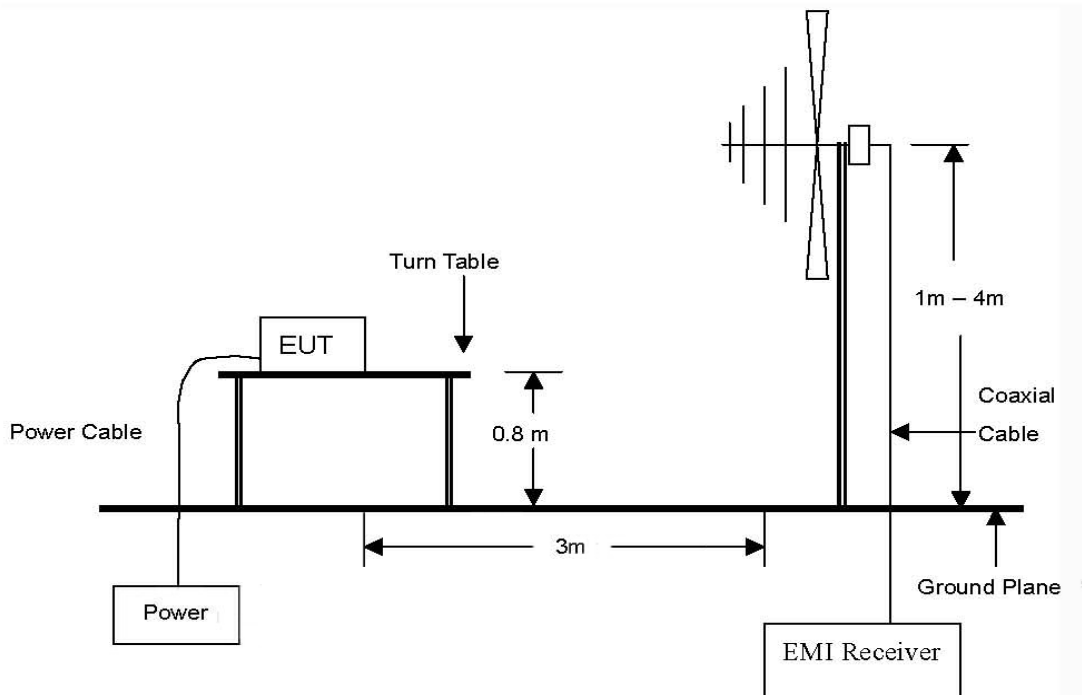

*The results shown in this test report refer only to the sample(s) tested unless otherwise stated. This test report cannot be reproduced, except in full, without prior written permission of the Company.*

The diagram below shows the test setup that is utilized to make the measurements for emission. The spurious emissions were investigated from 1 GHz to the 10th harmonic of the highest fundamental frequency or 40 GHz, whichever is lower.

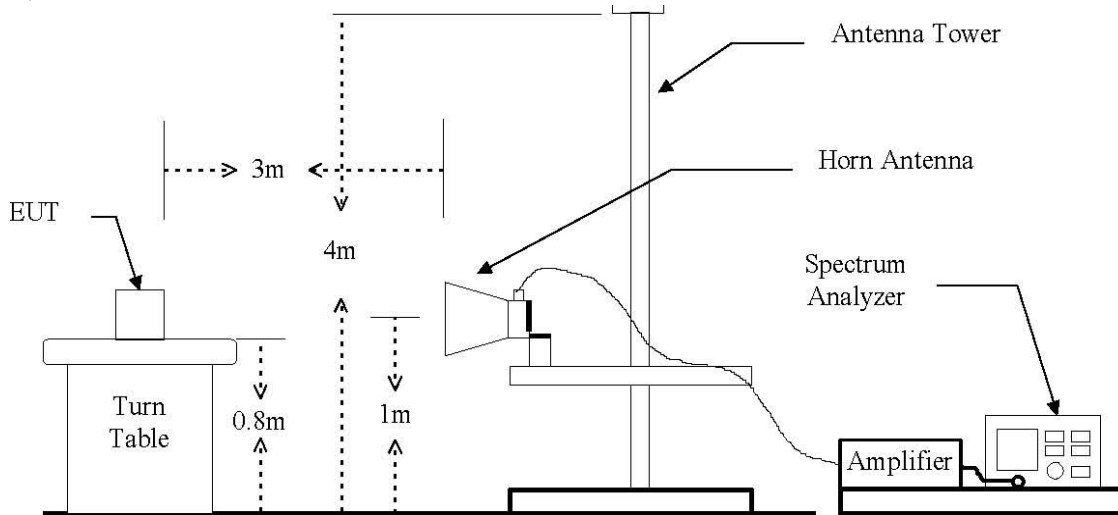

*The results shown in this test report refer only to the sample(s) tested unless otherwise stated. This test report cannot be reproduced, except in full, without prior written permission of the Company.*



### 2.1.2. Conducted Spurious Emissions

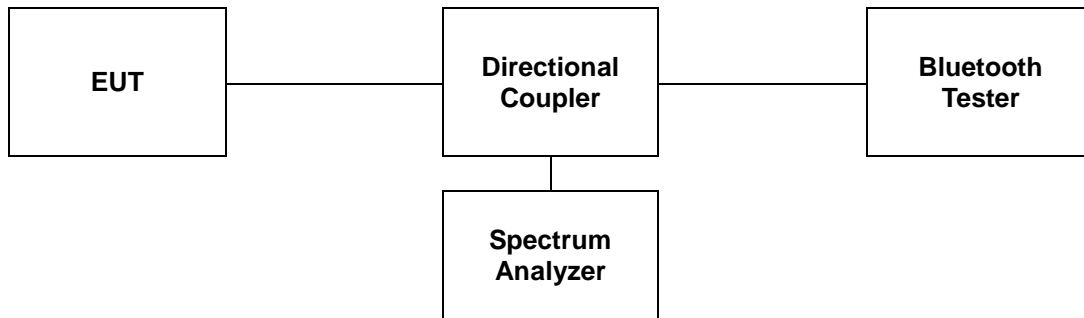

### 2.2. Limit

According to §15.247(d), in any 100 kHz bandwidth outside the frequency band in which the spread spectrum or digitally modulated intentional radiator is operating, the radio frequency power that is produced by the intentional radiator shall be at least 20 dB below that in the 100 kHz bandwidth within the band that contains the highest level of the desired power, based on either an RF conducted or a radiated measurement, provided the transmitter demonstrates compliance with the peak conducted power limits. If the transmitter complies with the conducted power limits based on the use of RMS averaging over a time interval, as permitted under paragraph(b)(3) of this section, the attenuation required under this paragraph shall be 30 dB instead of 20 dB. Attenuation below the general limits specified in section §15.209(a) is not required. In addition, radiated emission which in the restricted band, as define in section §15.205(a), must also comply the radiated emission limits specified in section §15.209(a) (see section §15.205(c))

According to § 15.209(a), Except as provided elsewhere in this Subpart, the emissions from an intentional radiator shall not exceed the field strength levels specified in the following table :

Frequency (MHz)	Field Strength (microvolts/meter)	Measurement Distance (meter)
0.009 - 0.490	2400/F(kHz)	300
0.490 - 1.705	24000/F(kHz)	30
1.705 - 30.0	30	30
30 - 88	100**	3
88 - 216	150**	3
216 - 960	200**	3
Above 960	500	3

\*\* Except as provided in paragraph (g), fundamental emissions from intentional radiators operating under this Section shall not be located in the frequency bands 54-72 MHz, 76-88 MHz, 174-216 MHz or 470-806 MHz. However, operation within these frequency bands is permitted under other sections of this Part, e.g., Sections 15.231 and 15.241

*The results shown in this test report refer only to the sample(s) tested unless otherwise stated. This test report cannot be reproduced, except in full, without prior written permission of the Company.*

## 2.3. Test Procedures

Radiated emissions from the EUT were measured according to the dictates of DA000705, ANSI C63.4-2003

### 2.3.1. Test Procedures for Radiated Spurious Emissions

1. The EUT was placed on the top of a rotating table 0.8 meters above the ground at a 3 meter anechoic chamber test site. The table was rotated 360 degrees to determine the position of the highest radiation.
2. During performing radiated emission below 1 GHz, the EUT was set 3 meters away from the interference receiving antenna, which was mounted on the top of a variable-height antenna tower. During performing radiated emission above 1 GHz, the EUT was set 3 meter away from the interference-receiving antenna.
3. The antenna is a broadband antenna, and its height is varied from one meter to four meters above the ground to determine the maximum value of the field strength. Both horizontal and vertical polarizations of the antenna are set to make the measurement.
4. For each suspected emission, the EUT was arranged to its worst case and then the antenna was tuned to heights from 1 meter to 4 meters and the table was turned from 0 degrees to 360 degrees to find the maximum reading.
5. The test-receiver system was set to Peak Detect Function and Specified Bandwidth with Maximum Hold Mode.
6. If the emission level of the EUT in peak mode was 10 dB lower than the limit specified, then testing could be stopped and the peak values of the EUT would be reported. Otherwise the emissions that did not have 10 dB margin would be re-tested one by one using peak, quasi-peak or average method as specified and then reported in a data sheet.

#### NOTE ;

All data rates and modes were investigated for radiated spurious emissions. Only the radiated emissions of the configuration that produced the worst case emissions are reported in this section.

1. The resolution bandwidth and video bandwidth of test receiver/spectrum analyzer is 120 kHz for Peak detection (PK) and Quasi-peak detection (QP) at frequency below 1 GHz.
2. The resolution bandwidth and video bandwidth of test receiver/spectrum analyzer is 1 MHz for Peak detection and frequency above 1 GHz.
3. The resolution bandwidth of test receiver/spectrum analyzer is 1 MHz and the video bandwidth is 1/T Hz for Average detection (AV) at frequency above 1 GHz.  $VBW = 360 \text{ Hz} \geq 1/T \text{ Hz}$ , where T is the Bluetooth pulse width in seconds ( $T = 0.0029 \text{ s}$ ). Refer to the DH5, 3DH5 of Time of Occupancy (Dwell Time) test item.
4. When Average result is different from peak result over 20 dB (over-averaging), According to 15.35 (c), as a "duty cycle correction factor", pulse averaging with 20 log (duty cycle) has to be used.
5. To get a maximum emission level from the EUT, the EUT is manipulated through three orthogonal planes.

*The results shown in this test report refer only to the sample(s) tested unless otherwise stated. This test report cannot be reproduced, except in full, without prior written permission of the Company.*

### 2.3.2. Test Procedures for Conducted Spurious Emissions

NOTE ;

All data rates and modes were investigated for conducted spurious emissions. Only the conducted emissions of the configuration that produced the worst case emissions are reported in this section.

#### 2.3.2.1. Band-edge Compliance of RF Conducted Emissions

The transmitter output was connected to the spectrum analyzer.

Span = wide enough to capture the peak level of the emission operating on the channel closest to the bandedge, as well as any modulation products which fall outside of the authorized band of operation.

RBW  $\geq$  100 kHz

VBW  $\geq$  RBW

Sweep = auto

Detector function = peak

Trace = max hold

#### 2.3.2.2. Spurious RF Conducted Emissions

The transmitter output was connected to the spectrum analyzer.

RBW = 100 kHz

VBW  $\geq$  RBW

Sweep = auto

Detector function = peak

Trace = max hold

*The results shown in this test report refer only to the sample(s) tested unless otherwise stated. This test report cannot be reproduced, except in full, without prior written permission of the Company.*

## 2.4. Test Results

Ambient temperature : (23 ± 1) °C  
 Relative humidity : 47 % R.H.

### 2.4.1. Spurious Radiated Emission (Worst case configuration\_8DPSK mode, 3 Mbps, Middle channel)

The frequency spectrum from 12 MHz to 1 000 MHz was investigated. All reading values are peak values.

Radiated Emissions			Ant	Correction Factors		Total	FCC Limit	
Frequency (MHz)	Reading (dB $\mu$ V)	Detect Mode	Pol.	AF (dB/m)	AMP + CL (dB)	Actual (dB $\mu$ V/m)	Limit (dB $\mu$ V/m)	Margin (dB)
Below 40.00	Not detected	-	-	-	-	-	-	-
50.27	44.06	Peak	V	13.23	-24.40	32.89	40.0	7.11
101.59	44.50	Peak	V	12.95	-23.78	33.67	43.5	9.83
101.68	37.95	Peak	H	12.93	-23.77	27.11	43.5	16.39
266.78	43.70	Peak	H	12.22	-22.37	33.55	46.0	12.45
Above 300.00	Not detected	-	-	-	-	-	-	-

Remark:

1. All spurious emissions at channels are almost the same below 1 GHz, so that middle channel was chosen at representative in final test.
2. Actual = Reading + AF + AMP + CL
3. The device has a reference clock operating 12 MHz.
4. According to § 15.31(o), Emission levels are not reported much lower than the limits by over 20 dB

*The results shown in this test report refer only to the sample(s) tested unless otherwise stated. This test report cannot be reproduced, except in full, without prior written permission of the Company.*

### 2.4.2. Spurious Radiated Emission

The frequency spectrum above 1 000 MHz was investigated.

#### Operating Mode : GFSK (1 Mbps)

##### A. Low Channel (2 402 MHz)

Radiated Emissions			Ant	Correction Factors		Total	FCC Limit	
Frequency (MHz)	Reading (dB $\mu$ V)	Detect Mode	Pol.	AF (dB/m)	CL (dB)	Actual (dB $\mu$ V/m)	Limit (dB $\mu$ V/m)	Margin (dB)
2 402.00	55.82	Peak	V	28.32	8.91	93.05	Fundamental	
*2 390.00	22.95	Peak	V	28.30	8.87	60.12	74.00	
*2 390.00	12.63	Average	V	28.30	8.87	49.80	54.00	

Radiated Emissions			Ant	Correction Factors		Total	FCC Limit	
Frequency (MHz)	Reading (dB $\mu$ V)	Detect Mode	Pol.	AF (dB/m)	AMP+CL (dB)	Actual (dB $\mu$ V/m)	Limit (dB $\mu$ V/m)	Margin (dB)
3 145.65	55.94	Peak	V	30.13	-33.97	52.10	73.05	20.95
3 145.65	54.72	Average	V	30.13	-33.97	50.88	53.05	2.17
*4 803.95	50.94	Peak	V	33.20	-31.74	52.40	74.00	21.60
*4 803.95	48.27	Average	V	33.20	-31.74	49.73	54.00	4.27
Above 4 900.00	Not detected	-	-	-	-	-	-	-

The results shown in this test report refer only to the sample(s) tested unless otherwise stated. This test report cannot be reproduced, except in full, without prior written permission of the Company.

## B. Middle Channel (2 441 MHz)

Radiated Emissions			Ant	Correction Factors		Total	FCC Limit	
Frequency (MHz)	Reading (dB $\mu$ V)	Detect Mode	Pol.	AF (dB/m)	CL (dB)	Actual (dB $\mu$ V/m)	Limit (dB $\mu$ V/m)	Margin (dB)
2 441.00	57.36	Peak	V	28.42	9.02	94.80	Fundamental	

Radiated Emissions			Ant	Correction Factors		Total	FCC Limit	
Frequency (MHz)	Reading (dB $\mu$ V)	Detect Mode	Pol.	AF (dB/m)	AMP+CL (dB)	Actual (dB $\mu$ V/m)	Limit (dB $\mu$ V/m)	Margin (dB)
3 145.60	55.89	Peak	V	30.13	-33.97	52.05	74.80	22.75
3 145.60	54.67	Average	V	30.13	-33.97	50.83	54.80	3.97
*4 882.07	46.03	Peak	V	33.29	-31.72	47.60	74.00	26.40
*4 882.07	41.91	Average	V	33.29	-31.72	43.48	54.00	10.52
Above 4 900.00	Not detected	-	-	-	-	-	-	-

The results shown in this test report refer only to the sample(s) tested unless otherwise stated. This test report cannot be reproduced, except in full, without prior written permission of the Company.

## C. High Channel (2 480 MHz)

Radiated Emissions			Ant	Correction Factors		Total	FCC Limit	
Frequency (MHz)	Reading (dB $\mu$ V)	Detect Mode	Pol.	AF (dB/m)	CL (dB)	Actual (dB $\mu$ V/m)	Limit (dB $\mu$ V/m)	Margin (dB)
2 480.00	56.60	Peak	V	28.51	9.14	94.25	Fundamental	
*2 483.50	23.93	Peak	V	28.52	9.15	61.60	74.00	
*2 483.50	13.19	Average	V	28.52	9.15	50.86	54.00	

Radiated Emissions			Ant	Correction Factors		Total	FCC Limit	
Frequency (MHz)	Reading (dB $\mu$ V)	Detect Mode	Pol.	AF (dB/m)	AMP+CL (dB)	Actual (dB $\mu$ V/m)	Limit (dB $\mu$ V/m)	Margin (dB)
3 145.54	56.00	Peak	V	30.13	-33.97	52.16	74.25	22.09
3 145.54	54.69	Average	V	30.13	-33.97	50.85	54.25	3.40
*4 960.28	46.73	Peak	V	33.38	-31.71	48.40	74.00	25.60
*4 960.28	43.40	Average	V	33.38	-31.71	45.07	54.00	8.93
Above 5 000.00	Not detected	-	-	-	-	-	-	-

The results shown in this test report refer only to the sample(s) tested unless otherwise stated. This test report cannot be reproduced, except in full, without prior written permission of the Company.

**Operating Mode : 8DPSK (3 Mbps)**

## A. Low Channel (2 402 MHz)

Radiated Emissions			Ant	Correction Factors		Total	FCC Limit	
Frequency (MHz)	Reading (dB $\mu$ V)	Detect Mode	Pol.	AF (dB/m)	CL (dB)	Actual (dB $\mu$ V/m)	Limit (dB $\mu$ V/m)	Margin (dB)
2 402.00	56.26	Peak	V	28.32	8.91	93.49	Fundamental	
*2 390.00	23.17	Peak	V	28.30	8.87	60.34	74.00	
*2 390.00	12.71	Average	V	28.30	8.87	49.88	54.00	

Radiated Emissions			Ant	Correction Factors		Total	FCC Limit	
Frequency (MHz)	Reading (dB $\mu$ V)	Detect Mode	Pol.	AF (dB/m)	AMP+CL (dB)	Actual (dB $\mu$ V/m)	Limit (dB $\mu$ V/m)	Margin (dB)
3 145.59	55.98	Peak	V	30.13	-33.97	52.14	73.49	21.35
3 145.59	54.69	Average	V	30.13	-33.97	50.85	53.49	2.64
*4 803.95	44.79	Peak	V	33.20	-31.74	46.25	74.00	27.75
*4 803.95	37.70	Average	V	33.20	-31.74	39.16	54.00	14.84
Above 4 900.00	Not detected	-	-	-	-	-	-	-

The results shown in this test report refer only to the sample(s) tested unless otherwise stated. This test report cannot be reproduced, except in full, without prior written permission of the Company.



## B. Middle Channel (2 441 MHz)

Radiated Emissions			Ant	Correction Factors		Total	FCC Limit	
Frequency (MHz)	Reading (dB $\mu$ V)	Detect Mode	Pol.	AF (dB/m)	CL (dB)	Actual (dB $\mu$ V/m)	Limit (dB $\mu$ V/m)	Margin (dB)
2 441.00	58.04	Peak	V	28.42	9.02	95.48	Fundamental	

Radiated Emissions			Ant	Correction Factors		Total	FCC Limit	
Frequency (MHz)	Reading (dB $\mu$ V)	Detect Mode	Pol.	AF (dB/m)	AMP+CL (dB)	Actual (dB $\mu$ V/m)	Limit (dB $\mu$ V/m)	Margin (dB)
3 145.64	55.93	Peak	V	30.13	-33.97	52.09	75.48	23.39
3 145.64	54.73	Average	V	30.13	-33.97	50.89	55.48	4.59
*4 882.04	46.73	Peak	V	33.29	-31.72	48.30	74.00	25.70
*4 882.04	38.69	Average	V	33.29	-31.72	40.26	54.00	13.74
Above 4 900.00	Not detected	-	-	-	-	-	-	-

The results shown in this test report refer only to the sample(s) tested unless otherwise stated. This test report cannot be reproduced, except in full, without prior written permission of the Company.

## C. High Channel (2 480 MHz)

Radiated Emissions			Ant	Correction Factors		Total	FCC Limit	
Frequency (MHz)	Reading (dB $\mu$ V)	Detect Mode	Pol.	AF (dB/m)	CL (dB)	Actual (dB $\mu$ V/m)	Limit (dB $\mu$ V/m)	Margin (dB)
2 480.00	57.14	Peak	V	28.51	9.14	94.79	Fundamental	
*2 483.50	23.52	Peak	V	28.52	9.15	61.19	74.00	
*2 483.50	13.07	Average	V	28.52	9.15	50.74	54.00	

Radiated Emissions			Ant	Correction Factors		Total	FCC Limit	
Frequency (MHz)	Reading (dB $\mu$ V)	Detect Mode	Pol.	AF (dB/m)	AMP+CL (dB)	Actual (dB $\mu$ V/m)	Limit (dB $\mu$ V/m)	Margin (dB)
3 145.54	55.83	Peak	V	30.13	-33.97	51.99	74.79	22.80
3 145.64	54.69	Average	V	30.13	-33.97	50.85	54.79	3.94
*4 960.04	41.46	Peak	V	33.38	-31.71	43.13	74.00	30.87
*4 960.04	33.48	Average	V	33.38	-31.71	35.15	54.00	18.85
Above 5 000.00	Not detected	-	-	-	-	-	-	-

## Remarks:

1. "\*" means the restricted band.
2. Measuring frequencies from 1 GHz to the 10<sup>th</sup> harmonic of highest fundamental frequency.
3. Radiated emissions measured in frequency above 1 000 MHz were made with an instrument using peak/average detector mode.
4. Actual = Reading + AF + AMP + CL

The results shown in this test report refer only to the sample(s) tested unless otherwise stated. This test report cannot be reproduced, except in full, without prior written permission of the Company.

### 2.4.3. Spurious RF Conducted Emissions : Plot of Spurious RF Conducted Emission

Operating Mode : GFSK (1 Mbps)

Low Channel

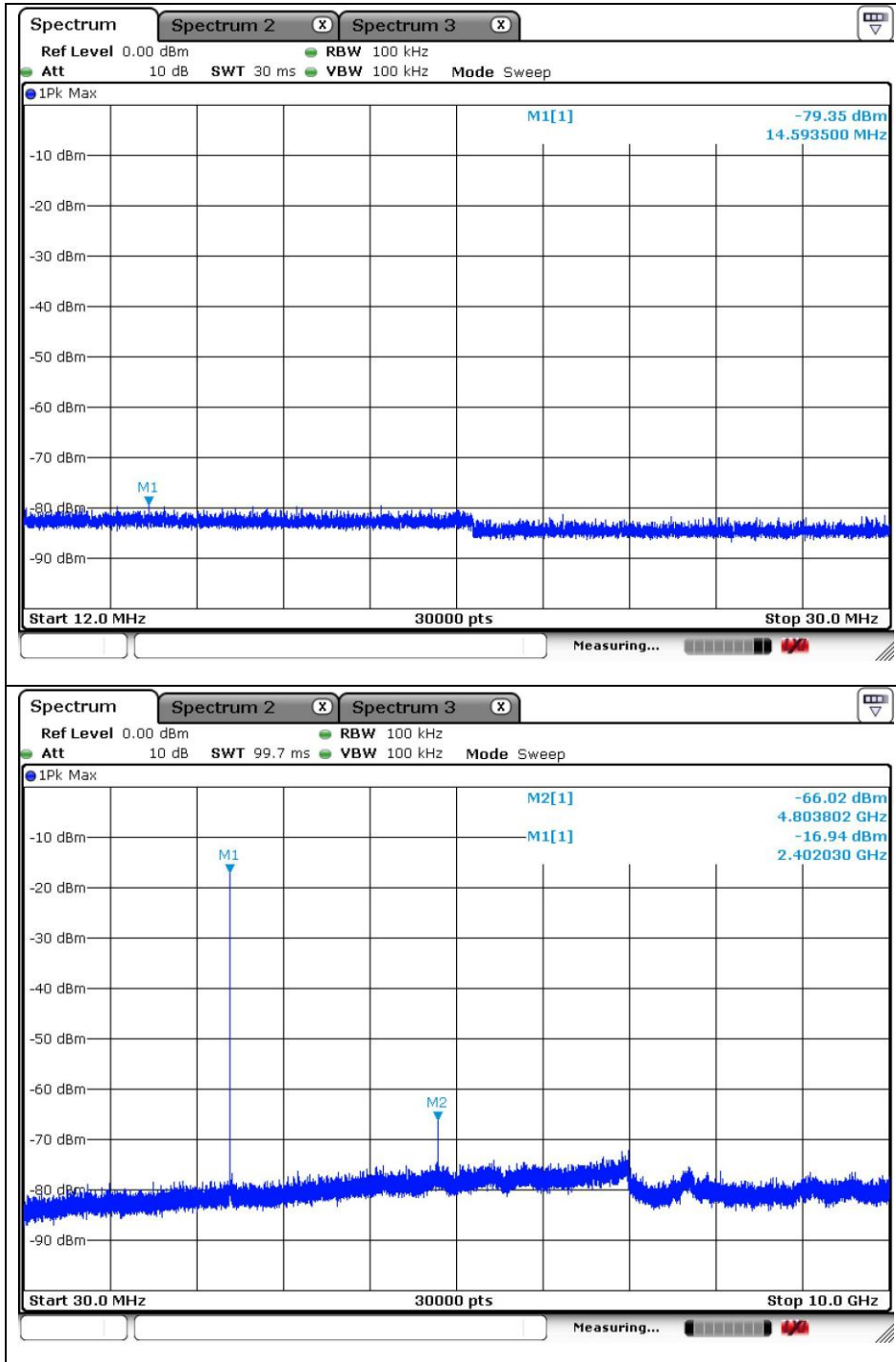

The results shown in this test report refer only to the sample(s) tested unless otherwise stated. This test report cannot be reproduced, except in full, without prior written permission of the Company.

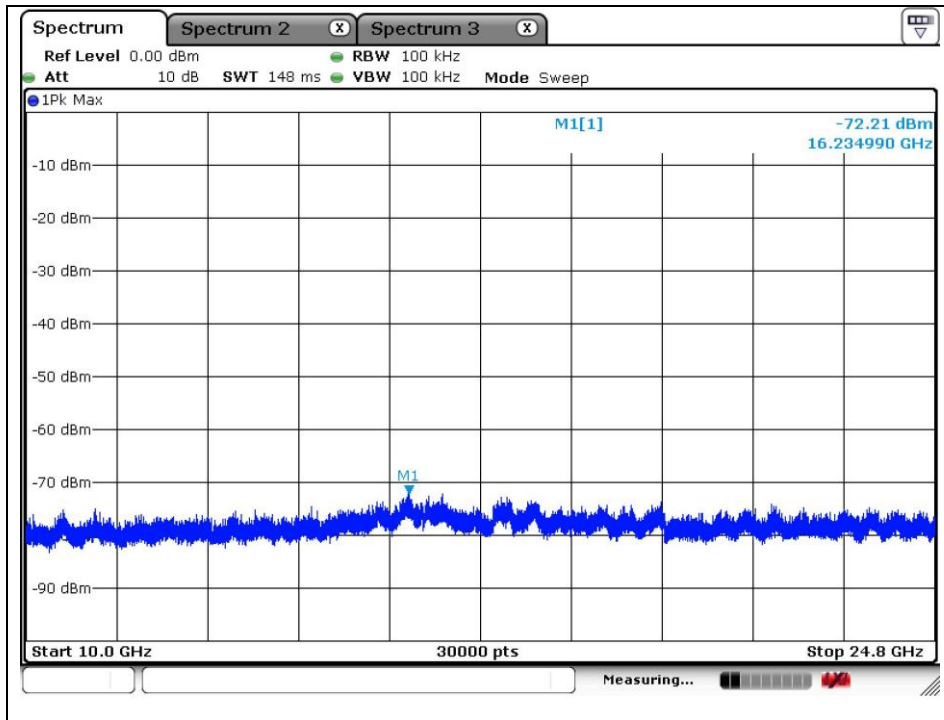

Note:

Offset (dB) = Directional Coupler(dB) + Cable loss (dB)

Final Result (dB m) = Reading values (dB m) + Spurious offset (dB)

Frequency (MHz)	Reading values (dB m)	Spurious offset (dB)	Final Result (dB m)
14.59	Noise floor	-	-
4 803.80	-66.02	20.47	-45.55
16 234.99	Noise floor	-	-

The results shown in this test report refer only to the sample(s) tested unless otherwise stated. This test report cannot be reproduced, except in full, without prior written permission of the Company.

Middle Channel

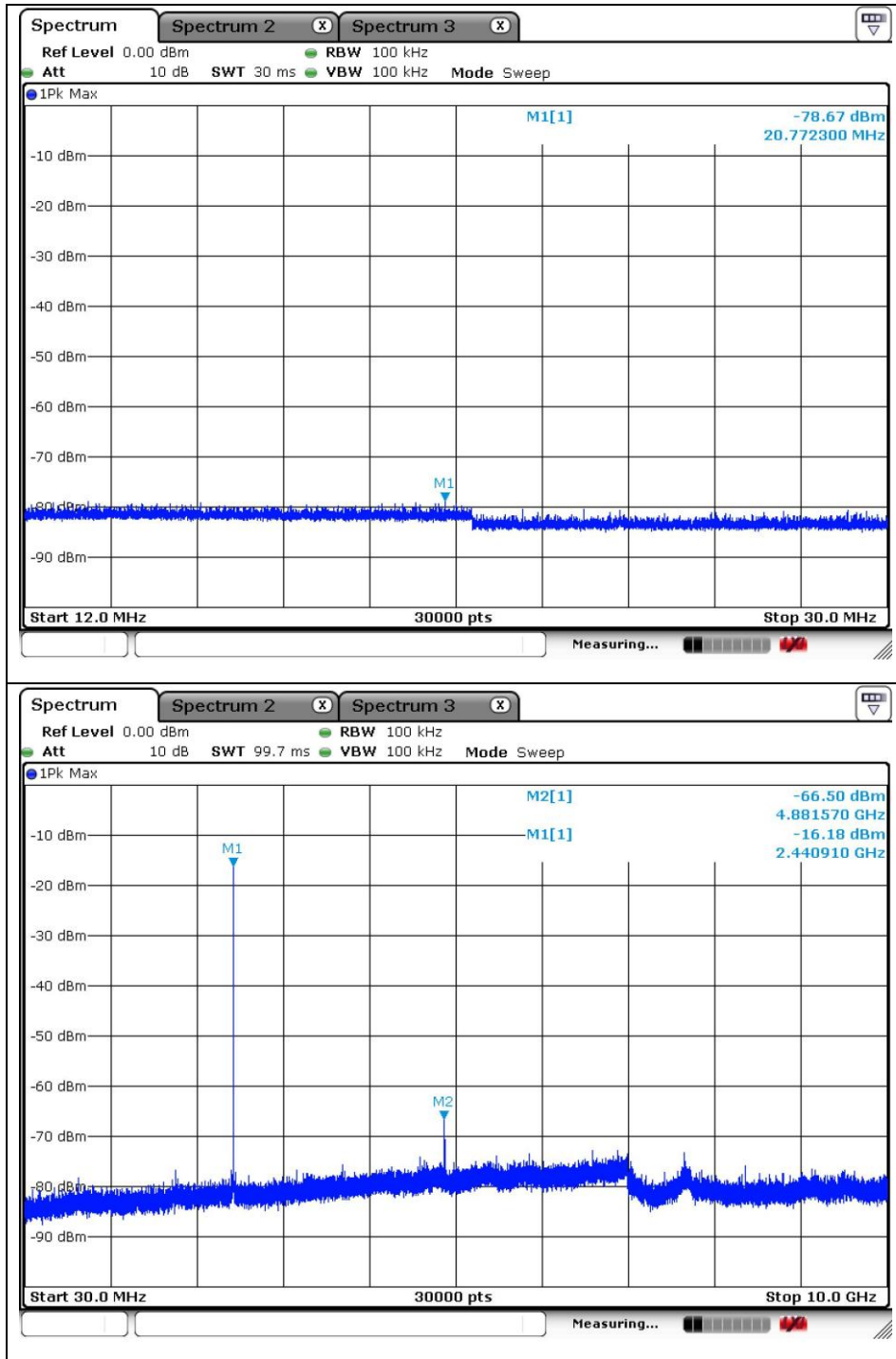

The results shown in this test report refer only to the sample(s) tested unless otherwise stated. This test report cannot be reproduced, except in full, without prior written permission of the Company.

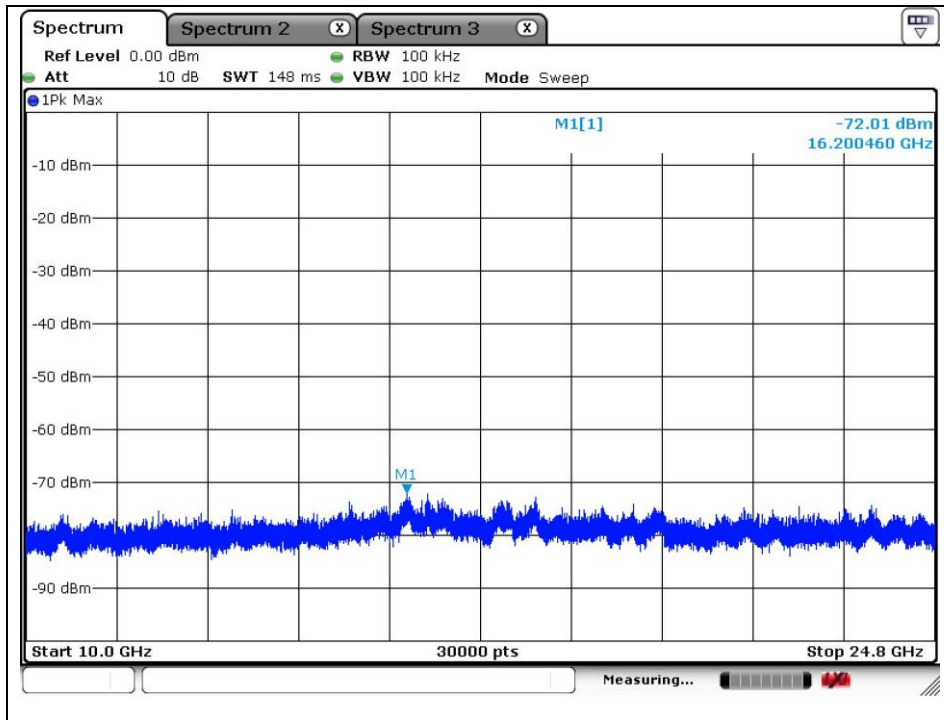

Note:

Offset (dB) = Directional Coupler(dB) + Cable loss (dB)

Final Result (dB m) = Reading values (dB m) + Spurious offset (dB)

Frequency (MHz)	Reading values (dB m)	Spurious offset (dB)	Final Result (dB m)
20.77	Noise floor	-	-
4 881.57	-66.50	20.53	-45.97
16 200.46	Noise floor	-	-

The results shown in this test report refer only to the sample(s) tested unless otherwise stated. This test report cannot be reproduced, except in full, without prior written permission of the Company.

High Channel

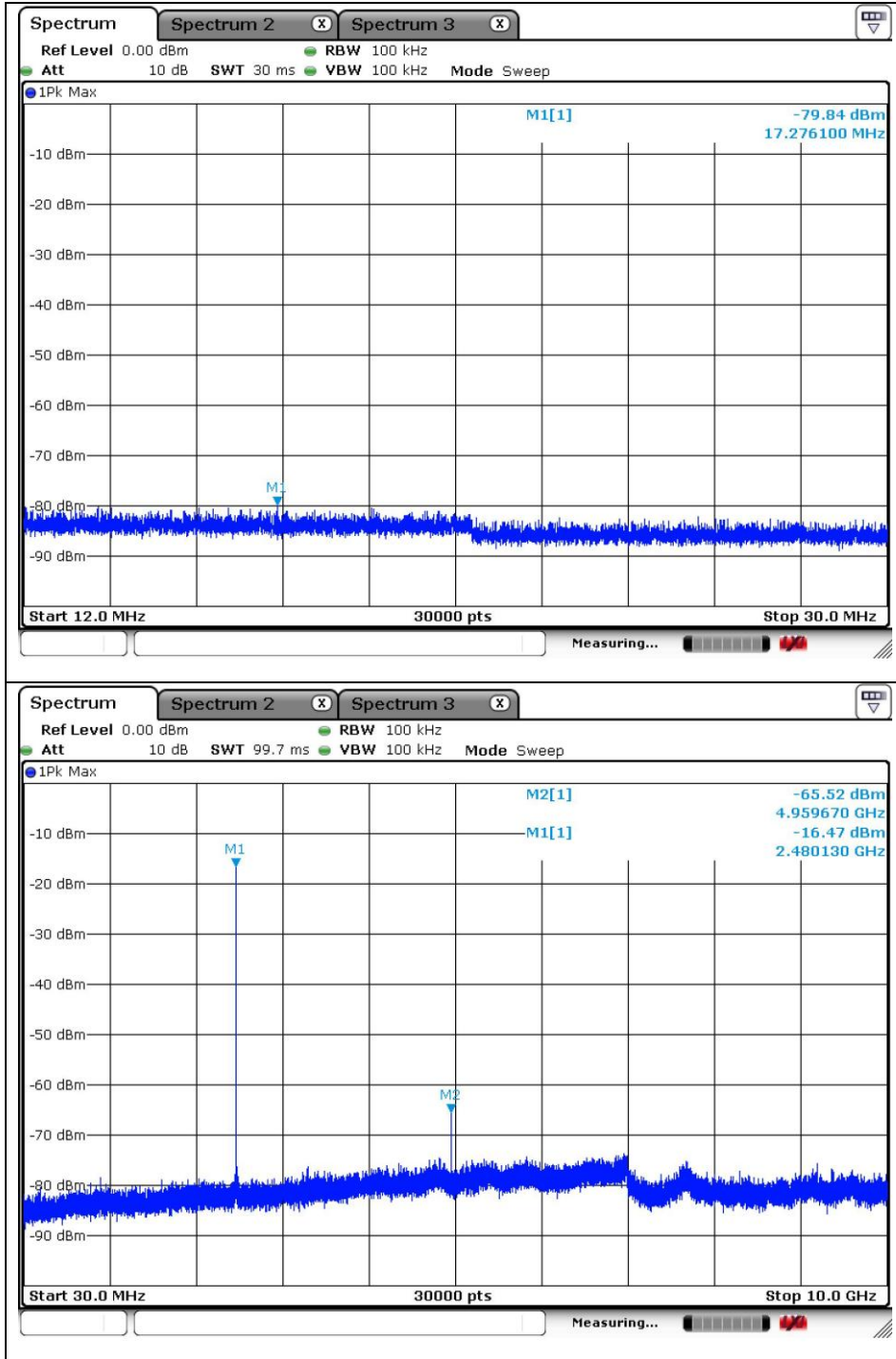

The results shown in this test report refer only to the sample(s) tested unless otherwise stated. This test report cannot be reproduced, except in full, without prior written permission of the Company.

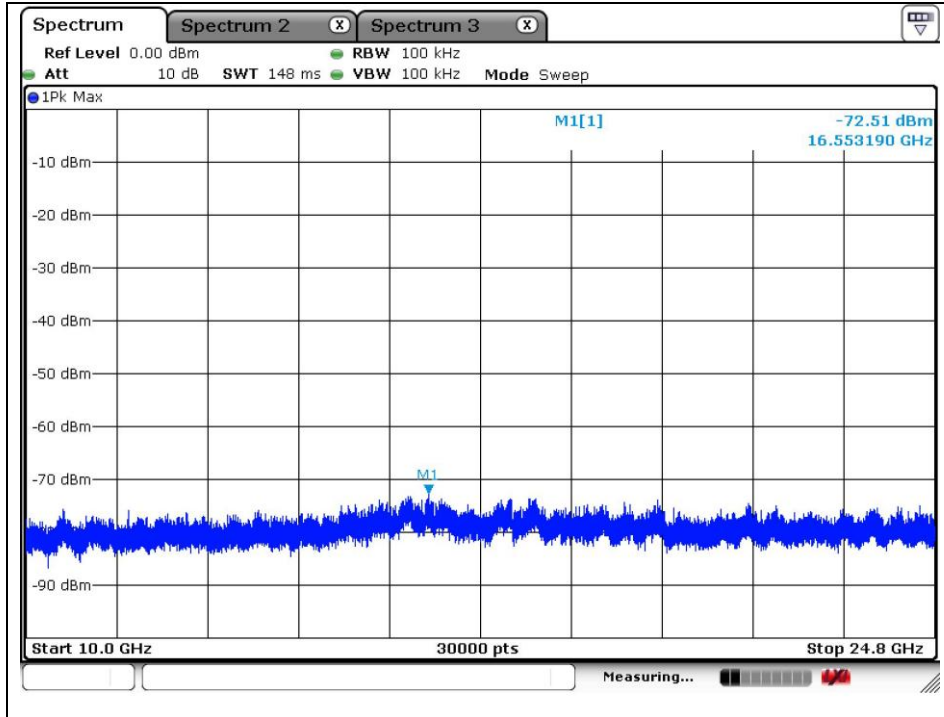

Note:

Offset (dB) = Directional Coupler(dB) + Cable loss (dB)

Final Result (dB m) = Reading values (dB m) + Spurious offset (dB)

Frequency (MHz)	Reading values (dB m)	Spurious offset (dB)	Final Result (dB m)
17.28	Noise floor	-	-
4 959.67	-65.52	20.55	-44.97
16 553.19	Noise floor	-	-

The results shown in this test report refer only to the sample(s) tested unless otherwise stated. This test report cannot be reproduced, except in full, without prior written permission of the Company.



**Operating Mode : 8DPSK (3 Mbps)**

Low Channel

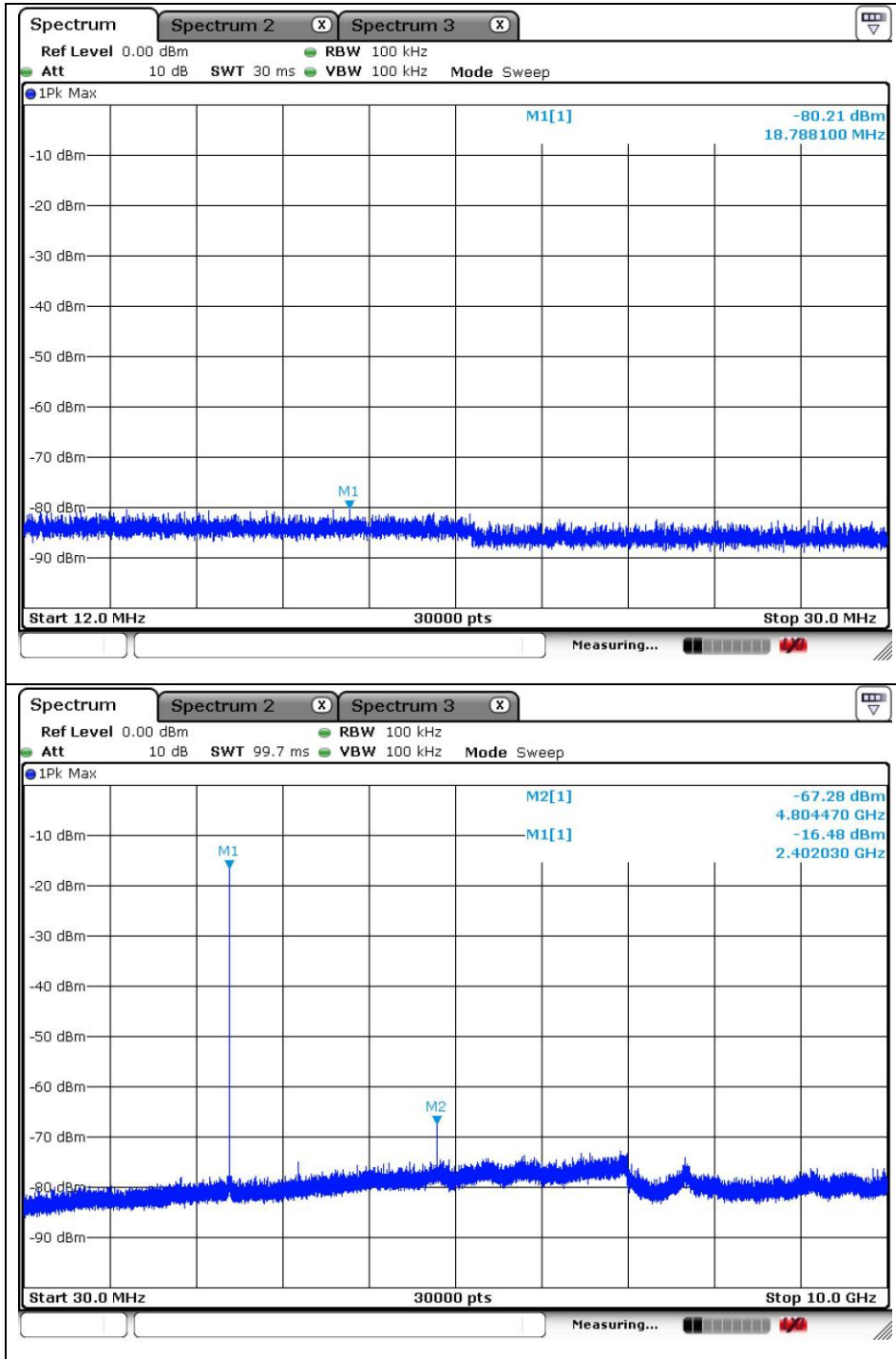

The results shown in this test report refer only to the sample(s) tested unless otherwise stated. This test report cannot be reproduced, except in full, without prior written permission of the Company.

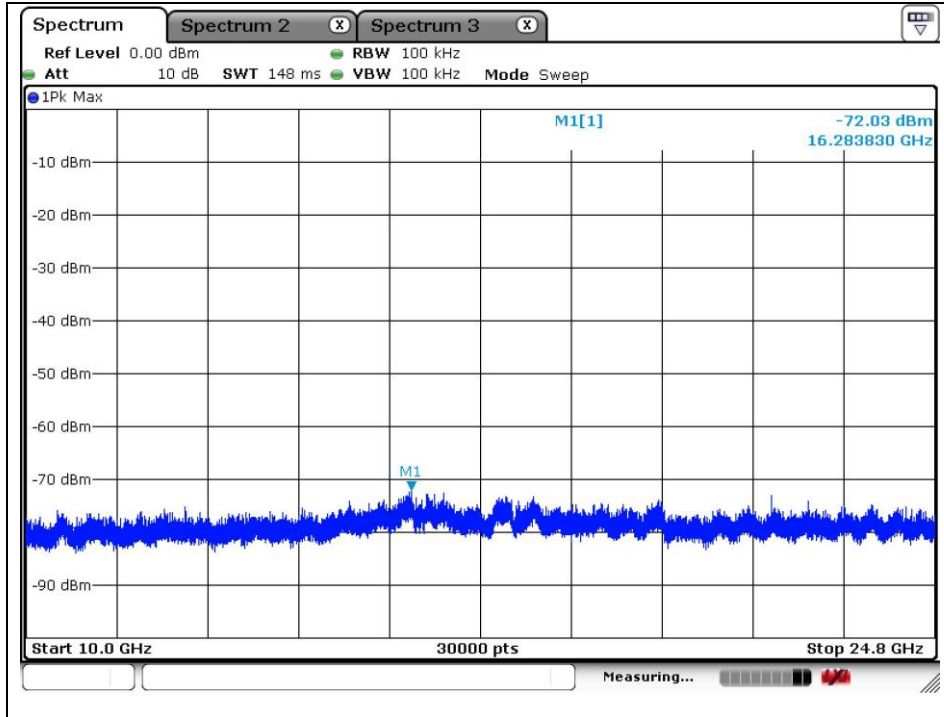

Note:

Offset (dB) = Directional Coupler(dB) + Cable loss (dB)

Final Result (dB m) = Reading values (dB m) + Spurious offset (dB)

Frequency (MHz)	Reading values (dB m)	Spurious offset (dB)	Final Result (dB m)
18.79	Noise floor	-	-
4 804.47	-67.28	20.48	-46.80
16 283.83	Noise floor	-	-

The results shown in this test report refer only to the sample(s) tested unless otherwise stated. This test report cannot be reproduced, except in full, without prior written permission of the Company.

Middle Channel

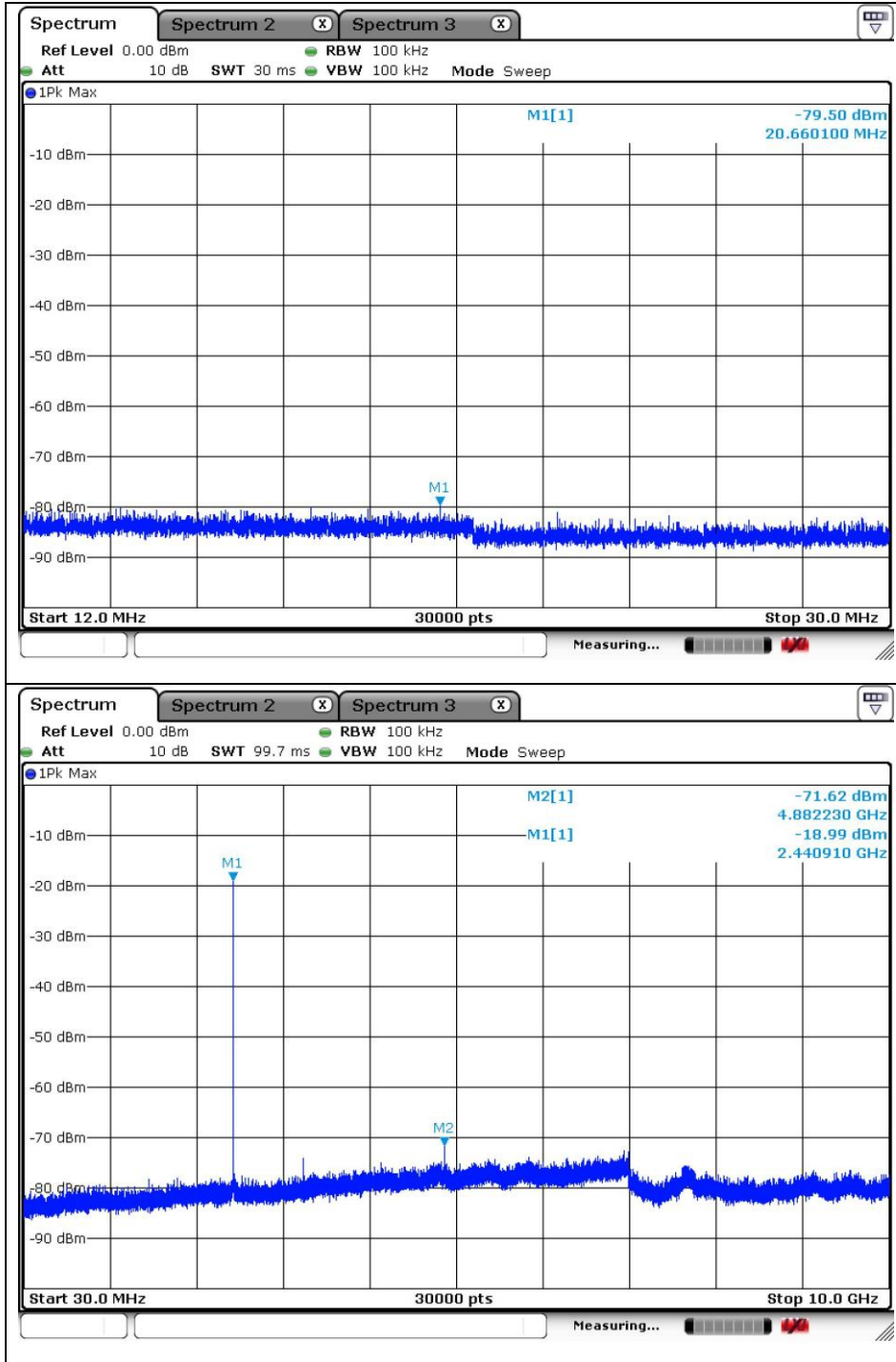

The results shown in this test report refer only to the sample(s) tested unless otherwise stated. This test report cannot be reproduced, except in full, without prior written permission of the Company.

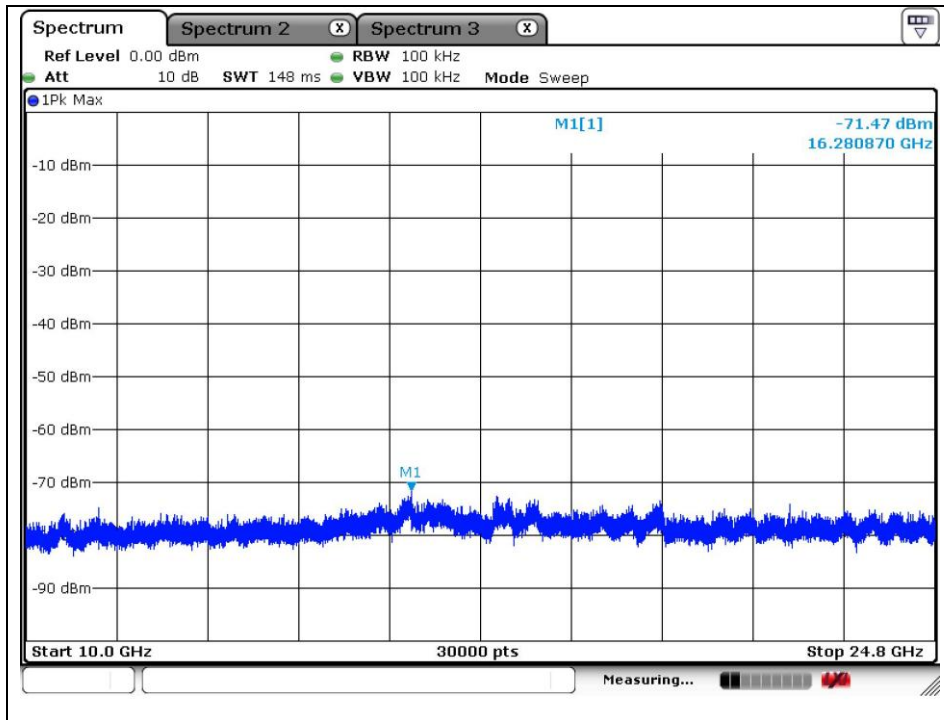

Note:

Offset (dB) = Directional Coupler(dB) + Cable loss (dB)

Final Result (dB m) = Reading values (dB m) + Spurious offset (dB)

Frequency (MHz)	Reading values (dB m)	Spurious offset (dB)	Final Result (dB m)
20.66	Noise floor	-	-
4 882.23	-71.62	20.49	-51.13
16 280.87	Noise floor	-	-

The results shown in this test report refer only to the sample(s) tested unless otherwise stated. This test report cannot be reproduced, except in full, without prior written permission of the Company.

High Channel

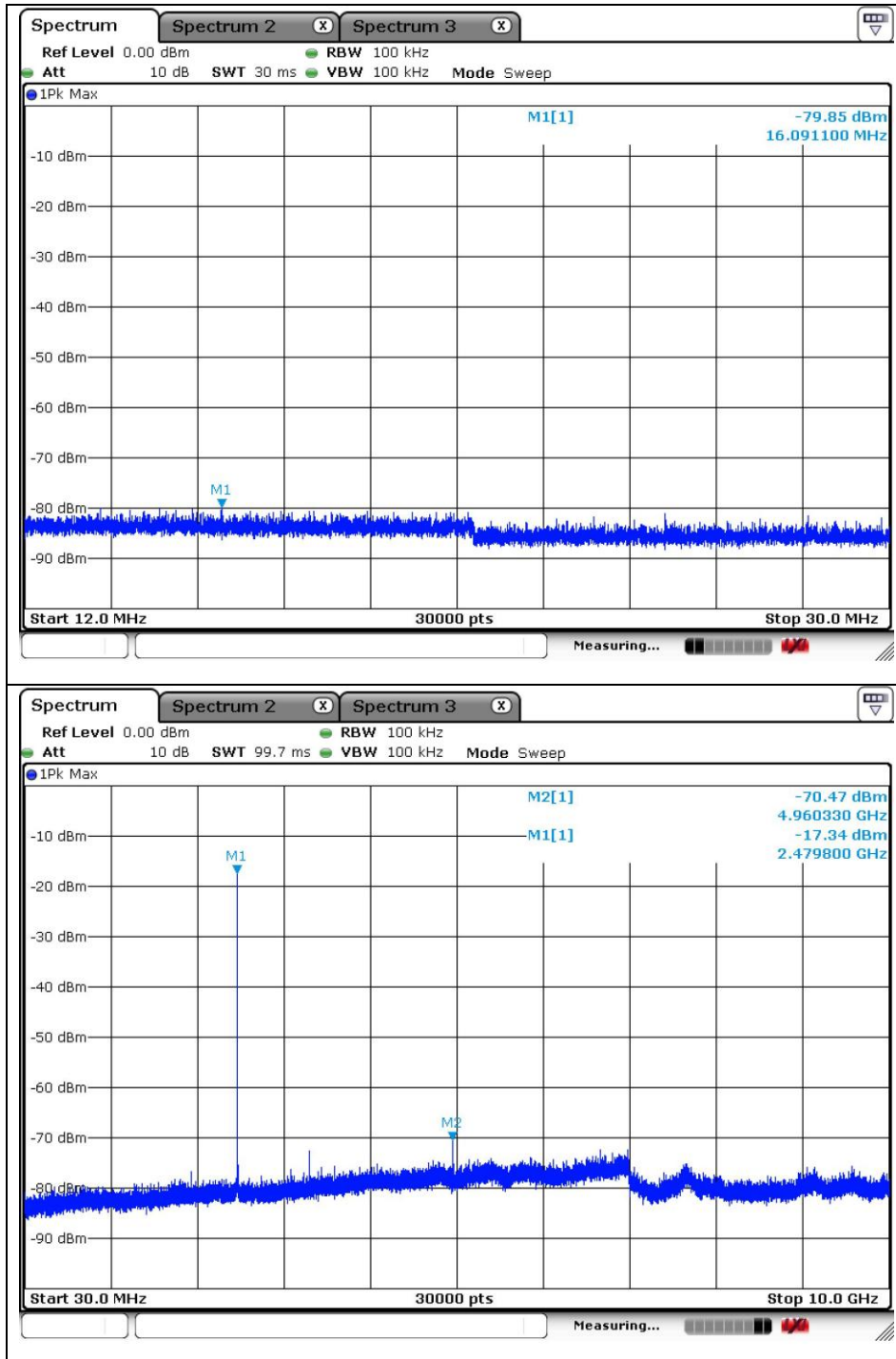

The results shown in this test report refer only to the sample(s) tested unless otherwise stated. This test report cannot be reproduced, except in full, without prior written permission of the Company.

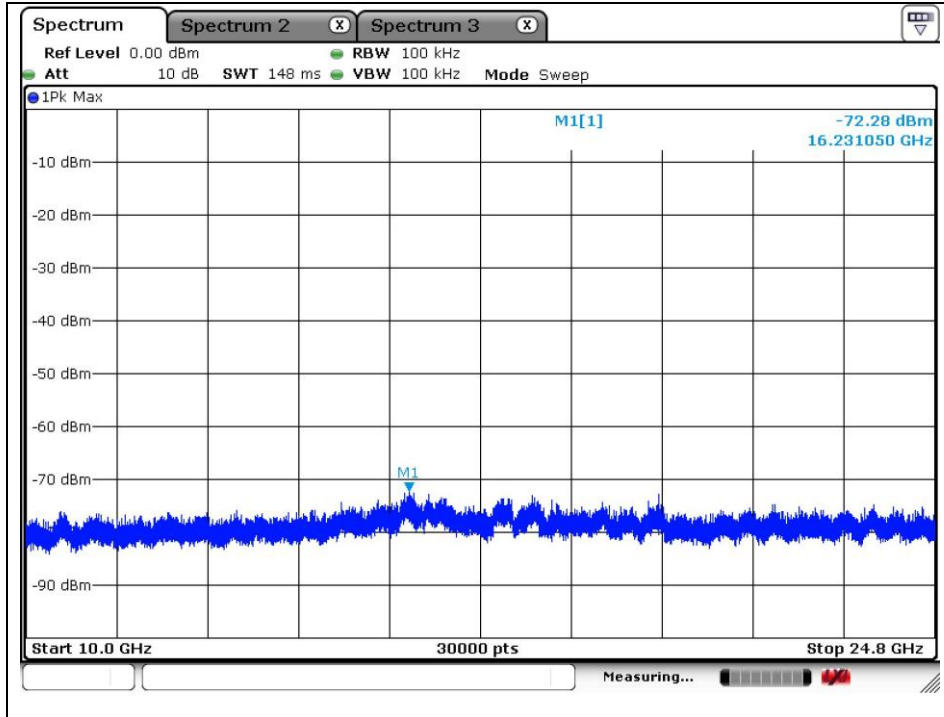

Note:

Offset (dB) = Directional Coupler(dB) + Cable loss (dB)

Final Result (dB m) = Reading values (dB m) + Spurious offset (dB)

Frequency (MHz)	Reading values (dB m)	Spurious offset (dB)	Final Result (dB m)
16.09	Noise floor	-	-
4 960.33	-70.47	20.56	-49.91
16 231.05	Noise floor	-	-

The results shown in this test report refer only to the sample(s) tested unless otherwise stated. This test report cannot be reproduced, except in full, without prior written permission of the Company.

## 2.4.4. Band-edge Compliance of RF Conducted Emissions

Operating Mode : GFSK (1 Mbps)

Low Channel  
-with the hopping disabled

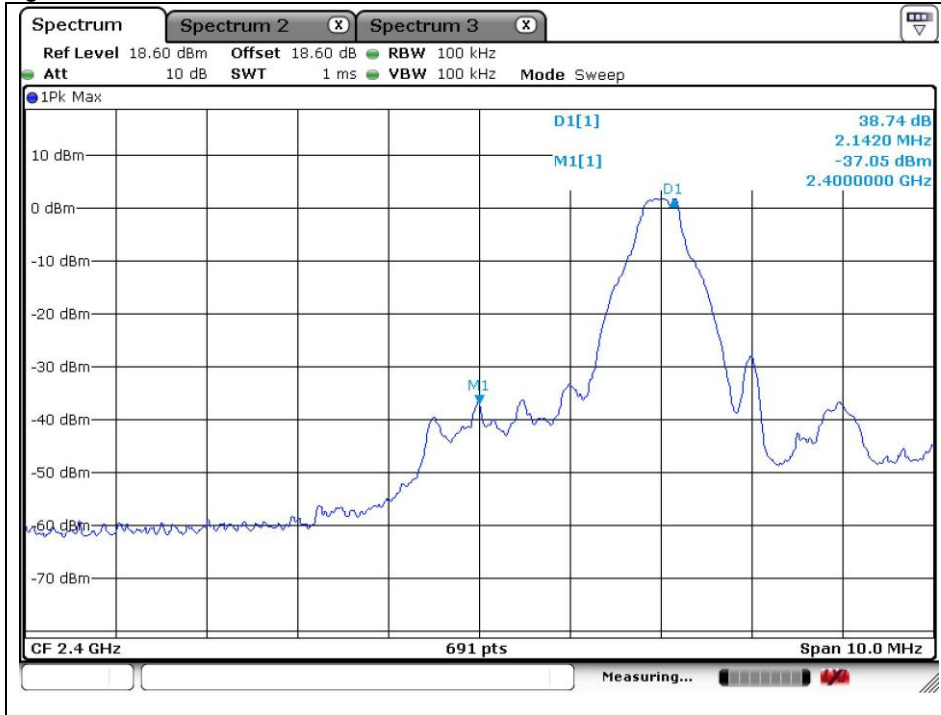

-with the hopping enabled

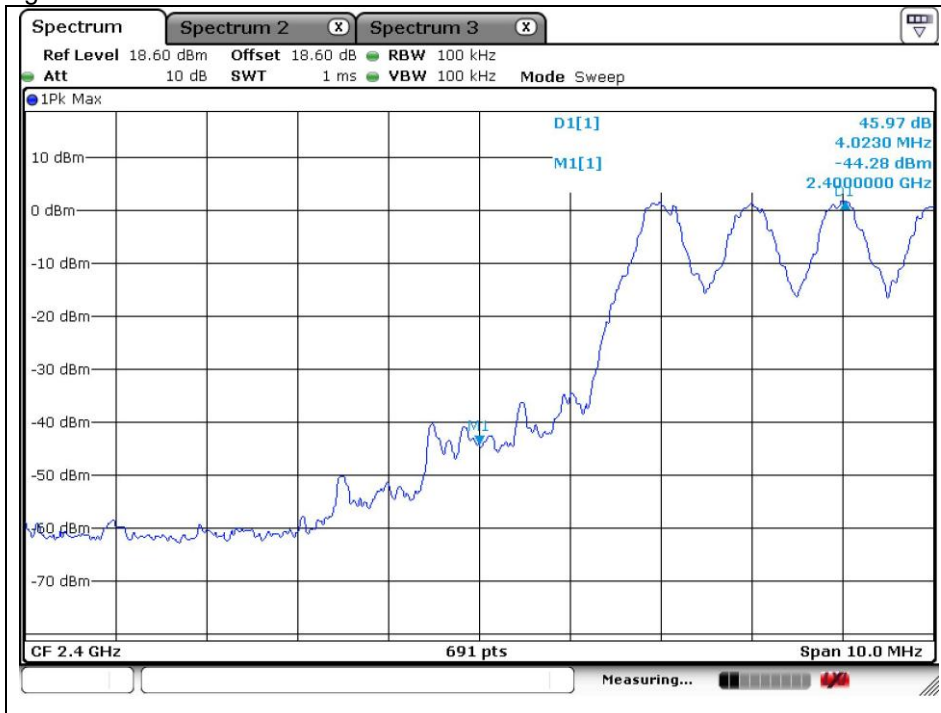

The results shown in this test report refer only to the sample(s) tested unless otherwise stated. This test report cannot be reproduced, except in full, without prior written permission of the Company.

High Channel  
-with the hopping disabled

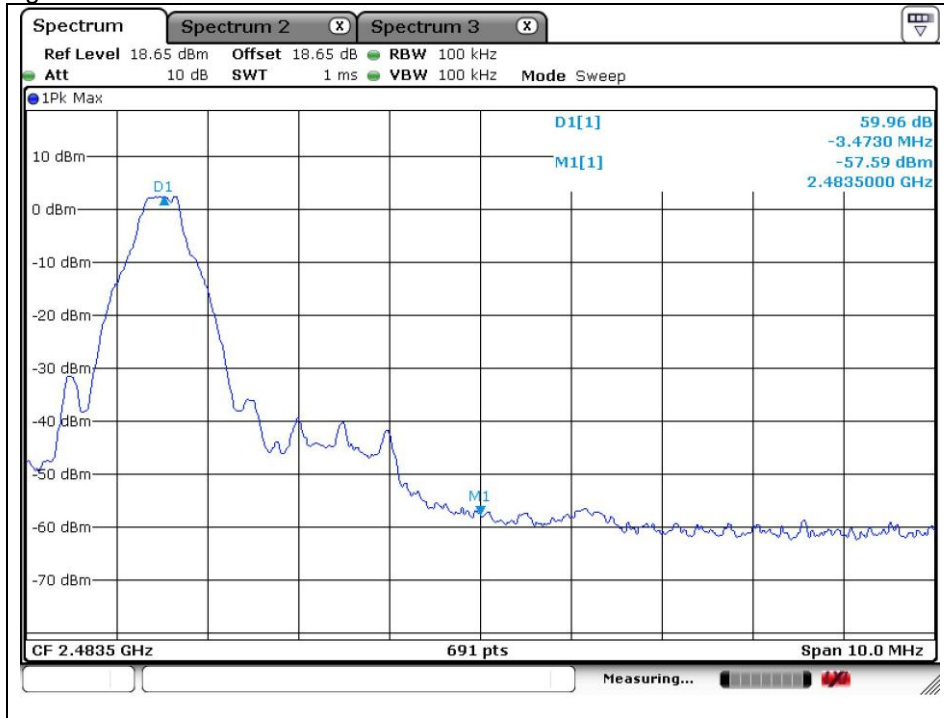

-with the hopping enabled

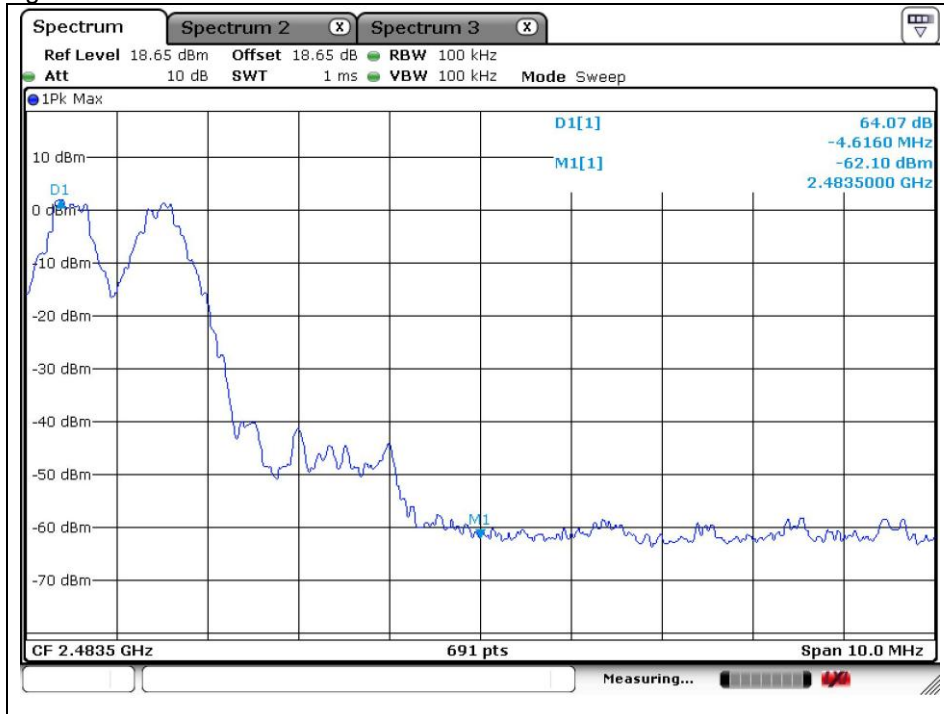

The results shown in this test report refer only to the sample(s) tested unless otherwise stated. This test report cannot be reproduced, except in full, without prior written permission of the Company.



**Operating Mode : 8DPSK (3 Mbps)**

Low Channel  
-with the hopping disabled

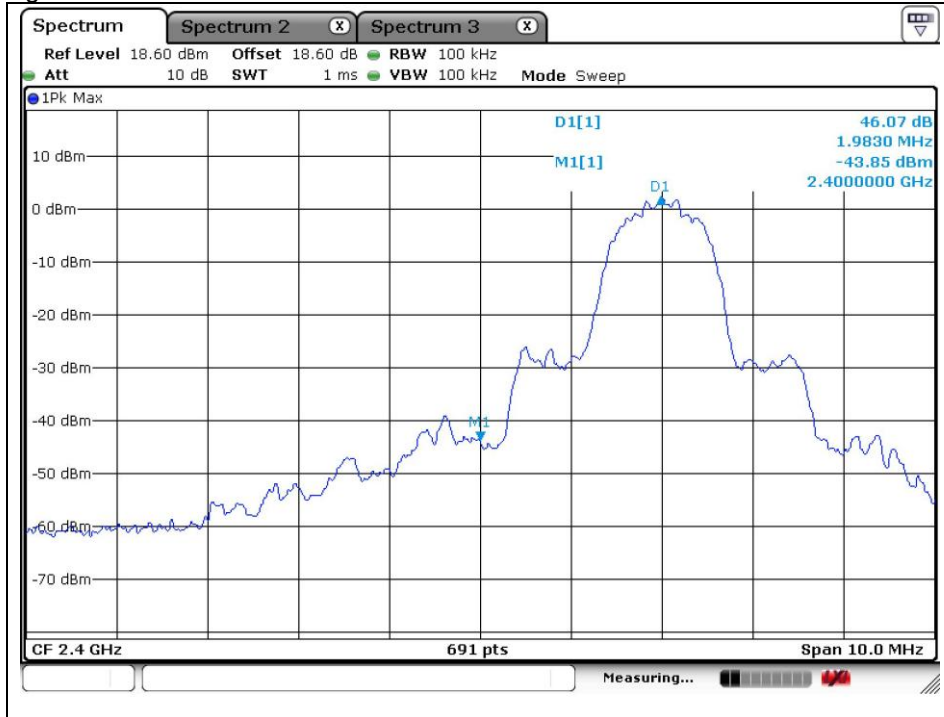

-with the hopping enabled

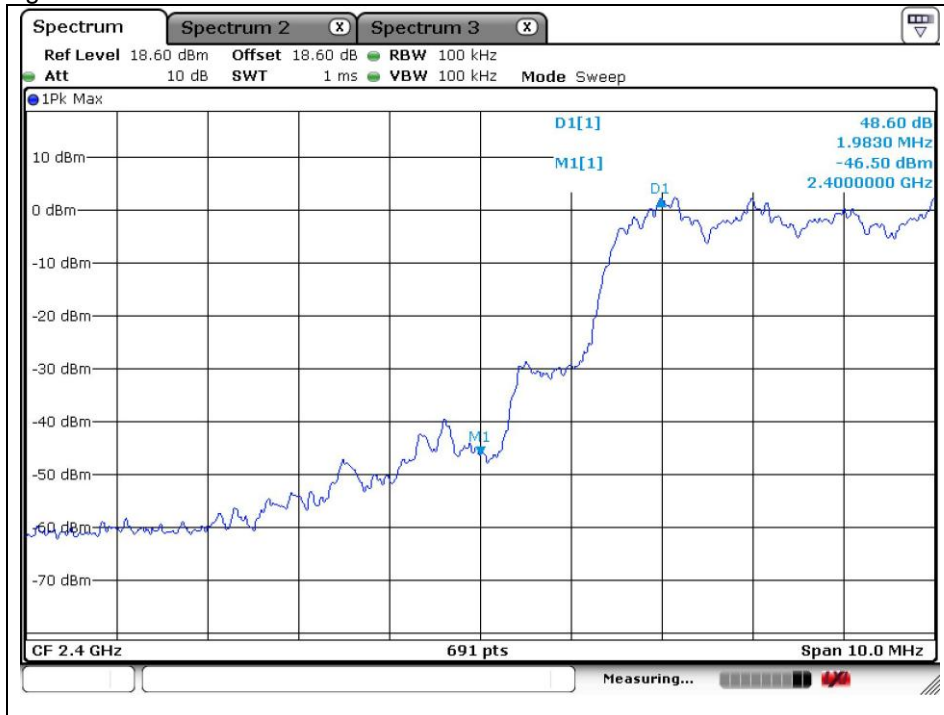

The results shown in this test report refer only to the sample(s) tested unless otherwise stated. This test report cannot be reproduced, except in full, without prior written permission of the Company.

High Channel  
-with the hopping disabled

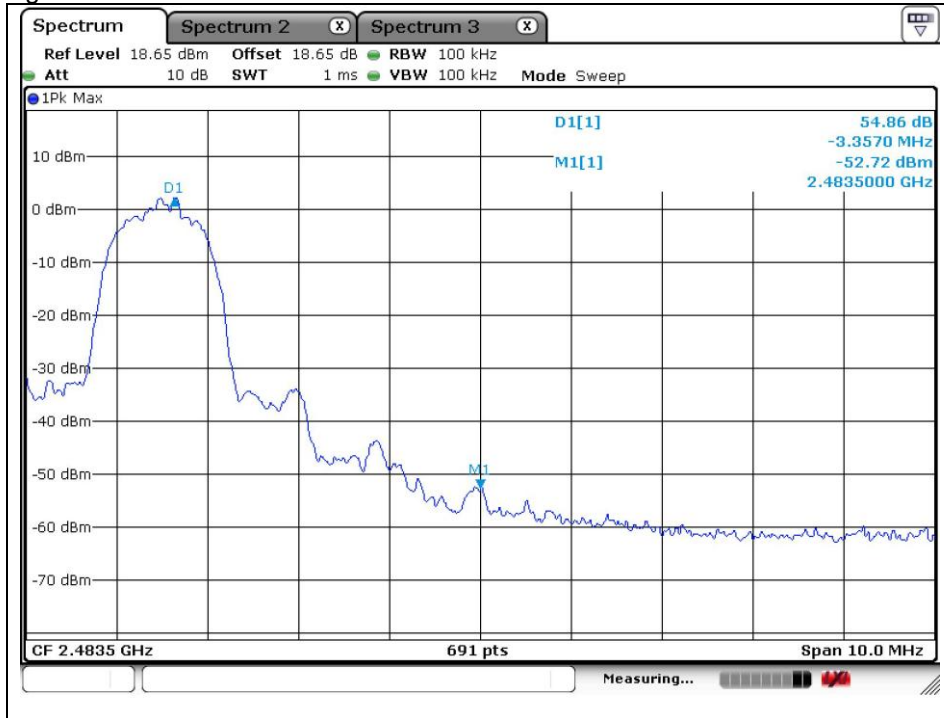

-with the hopping enabled

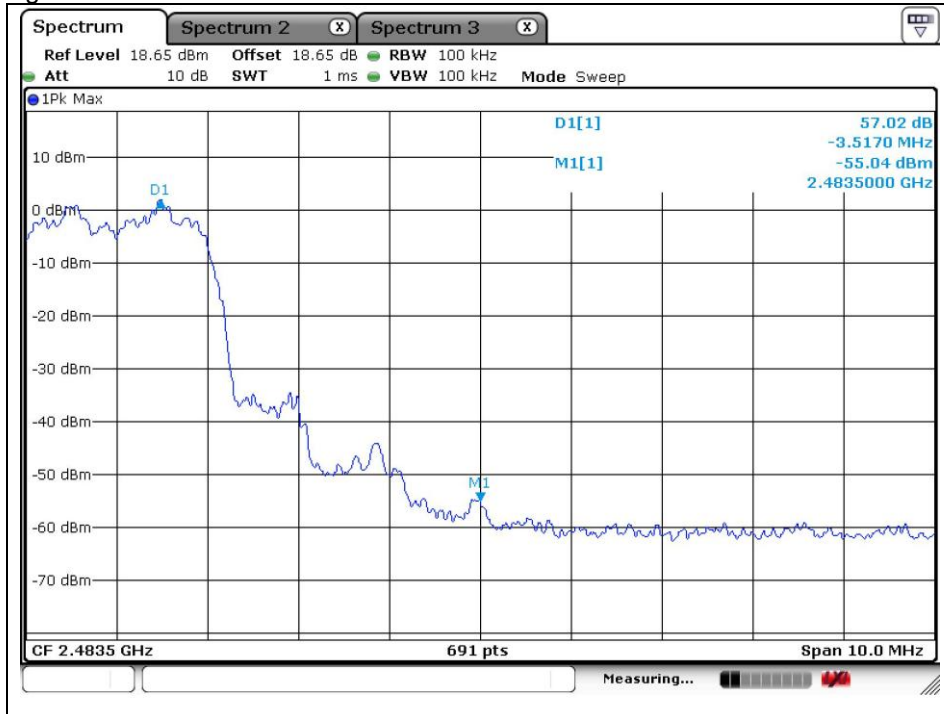

The results shown in this test report refer only to the sample(s) tested unless otherwise stated. This test report cannot be reproduced, except in full, without prior written permission of the Company.

### 3. 20 dB Bandwidth Measurement

#### 3.1. Test Setup

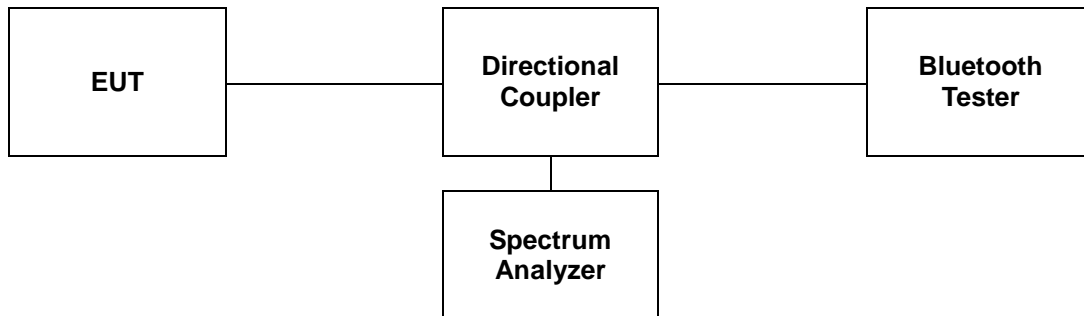

#### 3.2. Limit

Limit: Not Applicable

#### 3.3. Test Procedure

All data rates and modes were investigated for this test. The full data for the worst case data rate are reported in this section.

The test follows DA-000705.

The 20 dB band width was measured with a spectrum analyzer connected to RF antenna connector (conducted measurement) while EUT was operating in transmit mode at the appropriate center frequency.

Use the following spectrum analyzer setting :

Span = approximately 2 to 3 times the 20 dB bandwidth, centered on a hopping channel.

RBW = greater than 1 % of the 20 dB bandwidth

VBW  $\geq$  RBW

Sweep = auto

Detector = peak

Trace = max hold

The marker-to-peak function to set the mark to the peak of the emission. Use the marker-delta function to measure 20 dB down one side of the emission. Reset the function, and move the marker to the other side of the emission, until it is (as close as possible to) even with the reference marker level. The marker-delta reading at this point is 20 dB bandwidth of the emission.

*The results shown in this test report refer only to the sample(s) tested unless otherwise stated. This test report cannot be reproduced, except in full, without prior written permission of the Company.*

### 3.4. Test Results

Ambient temperature : (23 ± 1) °C  
 Relative humidity : 47 % R.H.

Operation Mode	Data Rate	Channel	Channel Frequency (MHz)	20 dB Bandwidth (MHz)
GFSK	1 Mbps	Low	2 402	<u>0.970</u>
		Middle	2 441	0.970
		High	2 480	0.955
π/4DQPSK	2 Mbps	Low	2 402	<u>1.281</u>
		Middle	2 441	1.281
		High	2 480	1.281
8DPSK	3 Mbps	Low	2 402	<u>1.303</u>
		Middle	2 441	1.295
		High	2 480	1.295

*The results shown in this test report refer only to the sample(s) tested unless otherwise stated. This test report cannot be reproduced, except in full, without prior written permission of the Company.*

## 20 dB Bandwidth

### Operating Mode : GFSK

Low Channel

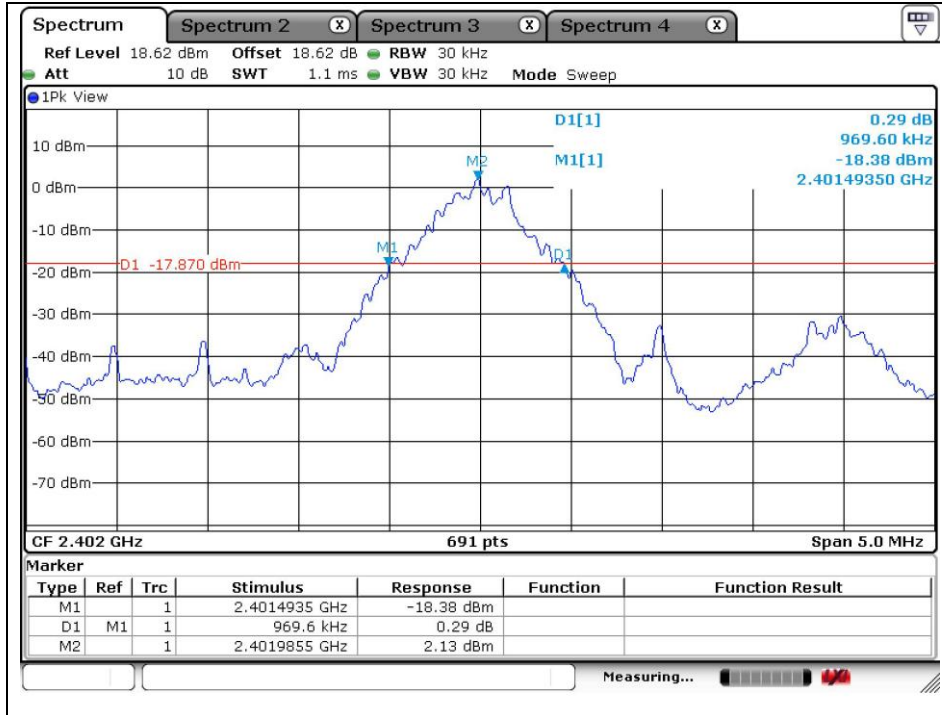

Middle Channel

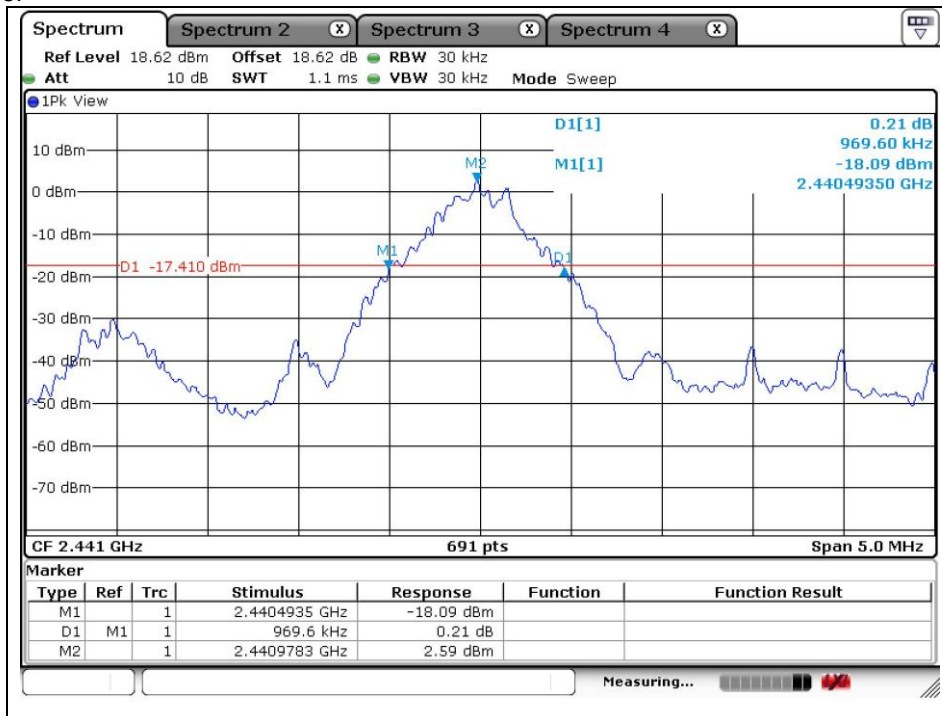

The results shown in this test report refer only to the sample(s) tested unless otherwise stated. This test report cannot be reproduced, except in full, without prior written permission of the Company.

High Channel

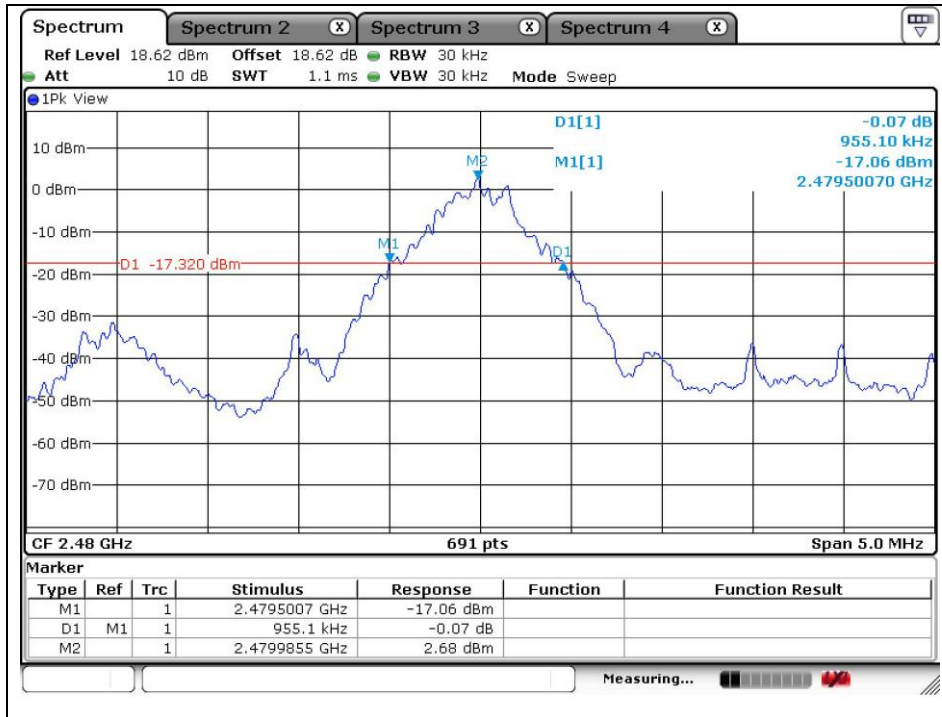

Operating Mode :  $\pi/4$ DQPSK

Low Channel

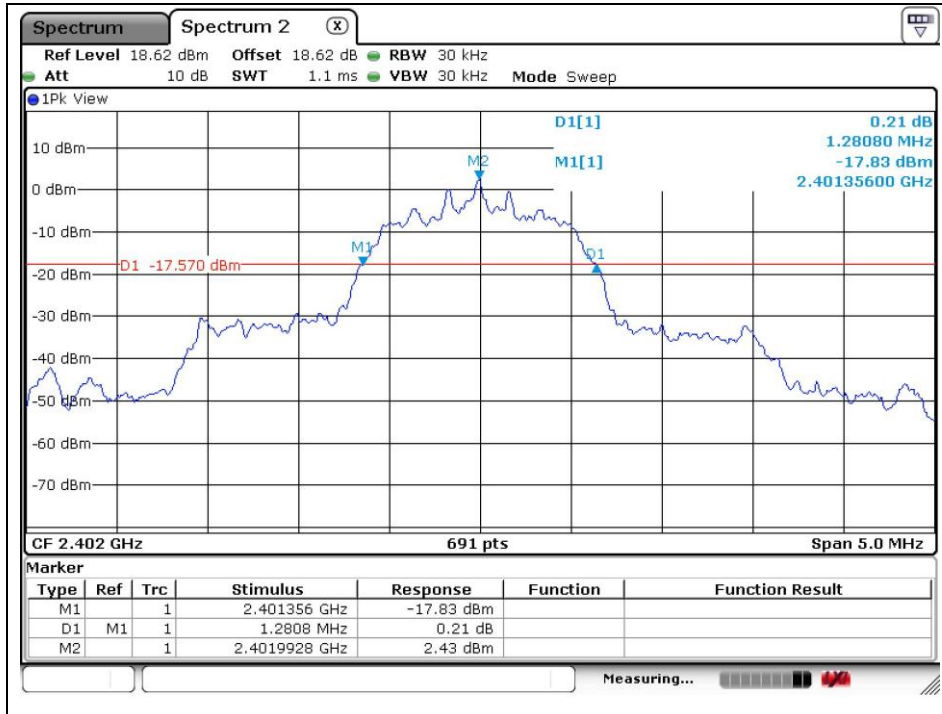

The results shown in this test report refer only to the sample(s) tested unless otherwise stated. This test report cannot be reproduced, except in full, without prior written permission of the Company.

Middle Channel

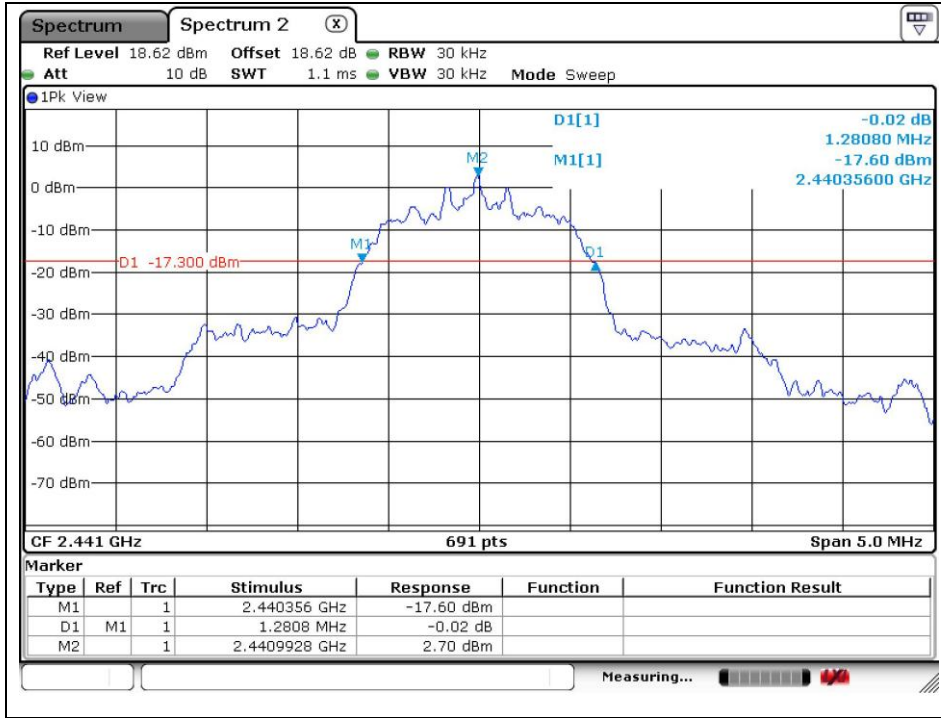

High Channel

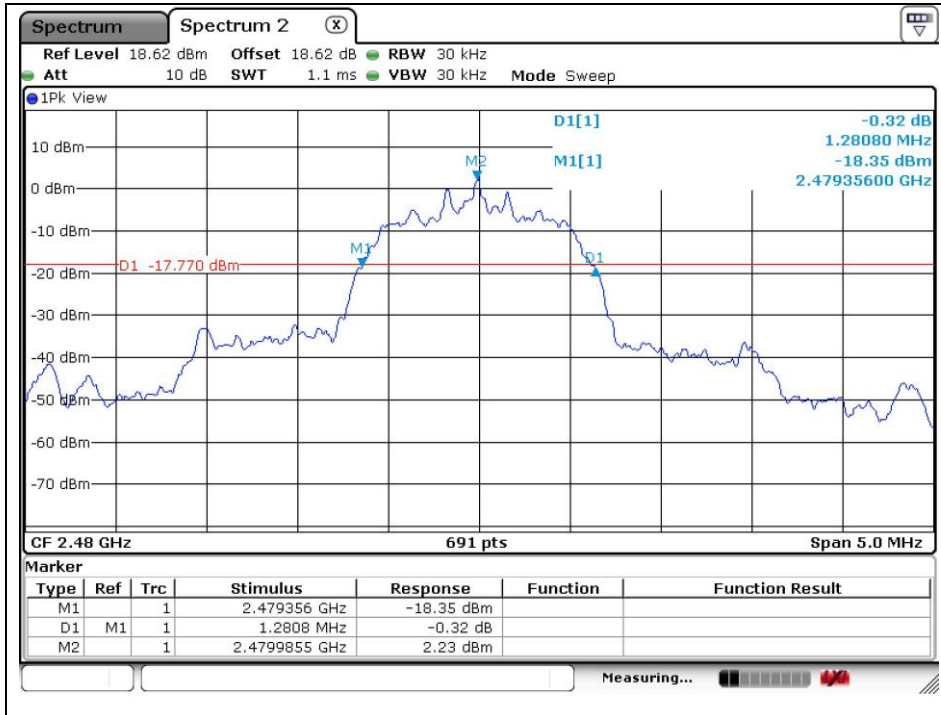

The results shown in this test report refer only to the sample(s) tested unless otherwise stated. This test report cannot be reproduced, except in full, without prior written permission of the Company.



**Operating Mode : 8DPSK**

Low Channel

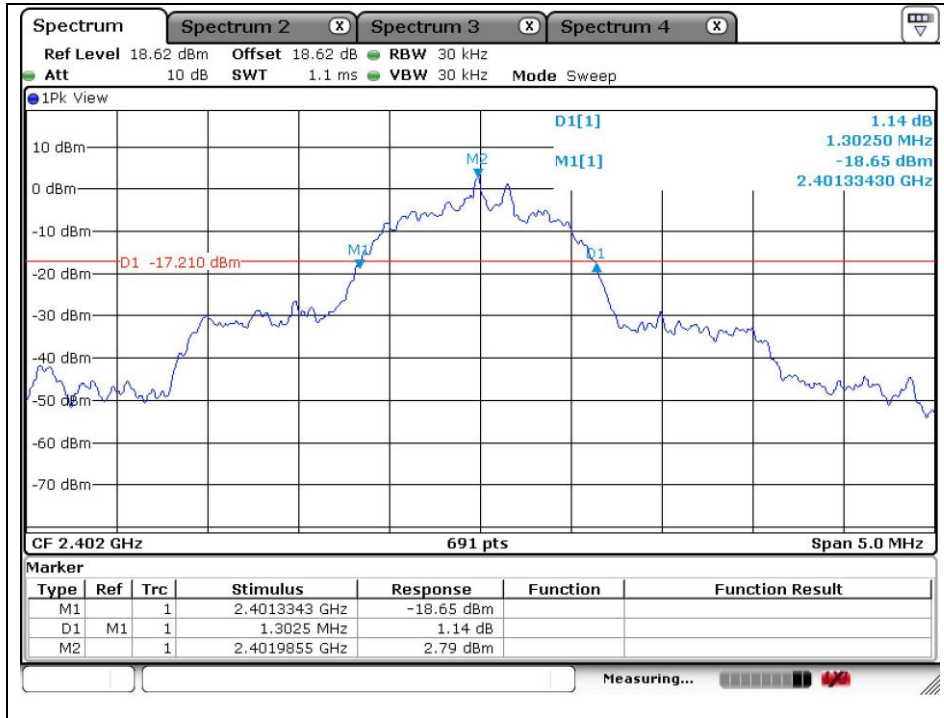

Middle Channel

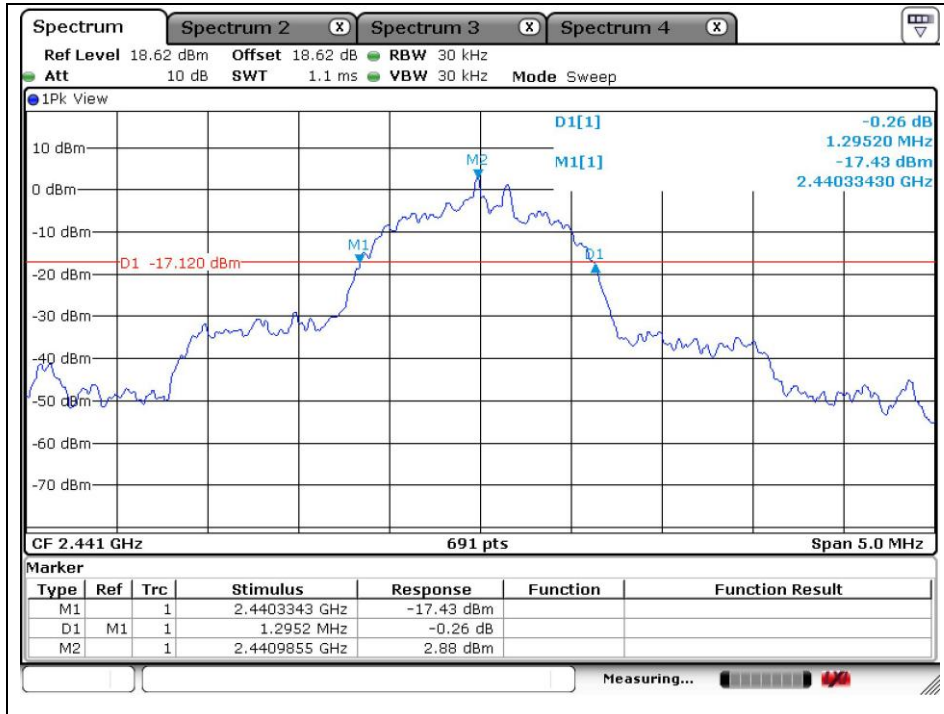

The results shown in this test report refer only to the sample(s) tested unless otherwise stated. This test report cannot be reproduced, except in full, without prior written permission of the Company.



High Channel

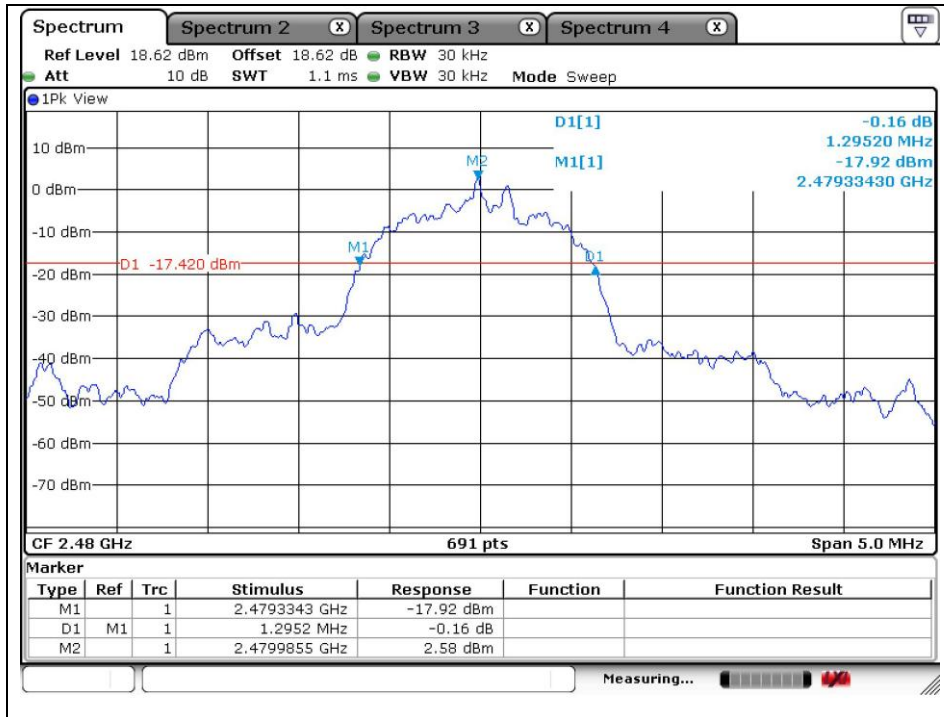

The results shown in this test report refer only to the sample(s) tested unless otherwise stated. This test report cannot be reproduced, except in full, without prior written permission of the Company.

## 4. Maximum Peak Output Power Measurement

### 4.1. Test Setup

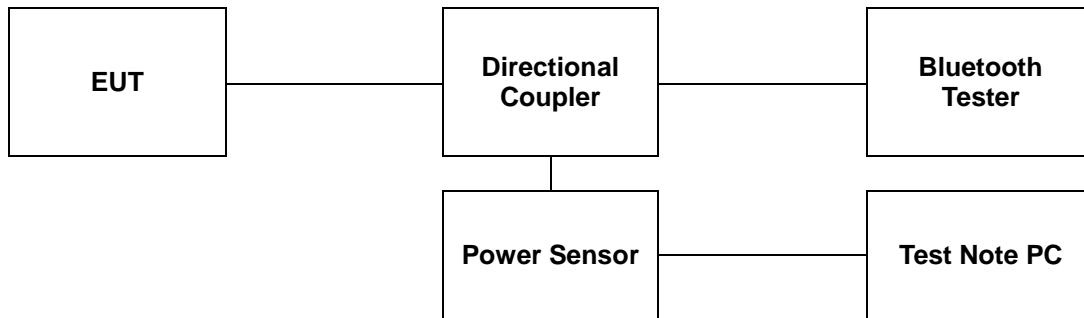

### 4.2. Limit

The maximum peak output power of the intentional radiator shall not exceed the following :

1. §15.247(a)(1), Frequency hopping systems shall have hopping channel carrier frequencies separated by a minimum of 25 kHz or the 20 dB bandwidth of the hopping channel, whichever is greater, provided the systems operate with an output power no greater than 125 mW.
2. §15.247(b)(1), For frequency hopping systems operating in the 2 400 – 2 483.5 MHz employing at least 75 non-overlapping hopping channels, and all frequency hopping systems in the 5 725 – 5 805 MHz band: 1 Watt.

### 4.3. Test Procedure

All data rates and modes were investigated for this test. The test follows DA000705. Using the power sensor instead of a spectrum analyzer.

1. Place the EUT on the table and set it in the transmitting mode.
2. Remove the antenna from the EUT and then connect a low loss RF cable from the antenna port to the Power sensor.
3. Test program : (S/W name : R&S Power Viewer, Version : 3.2.0)
4. Measure peak & average power each channel.

*The results shown in this test report refer only to the sample(s) tested unless otherwise stated. This test report cannot be reproduced, except in full, without prior written permission of the Company.*

#### 4.4. Test Results

Ambient temperature : (23 ± 1) °C

Relative humidity : 47 % R.H.

Operation Mode	Data Rate	Channel	Channel Frequency (MHz)	Attenuator + Cable offset (dB)	Average Power Result (dB m)	Peak Power Result (dB m)	Peak Power Limit (dB m)
GFSK	1 Mbps	Low	2 402	18.60	0.27	2.85	30.00
		Middle	2 441	18.62	0.90	<u>3.53</u>	30.00
		High	2 480	18.59	0.76	3.25	30.00
π/4DQPSK	2 Mbps	Low	2 402	18.60	0.05	4.24	20.97
		Middle	2 441	18.62	0.27	<u>4.45</u>	20.97
		High	2 480	18.59	-1.50	3.97	20.97
8DPSK	3 Mbps	Low	2 402	18.60	0.08	4.29	20.97
		Middle	2 441	18.62	0.31	<u>4.47</u>	20.97
		High	2 480	18.59	-1.58	3.98	20.97

Remark:

In the case of AFH, the limit for peak power is 0.125 W

The results shown in this test report refer only to the sample(s) tested unless otherwise stated. This test report cannot be reproduced, except in full, without prior written permission of the Company.

 SGS Korea Co., Ltd. (Gunpo Laboratory) 4, LS-ro 182beon-gil, Gunpo-si, Gyeonggi-do, Korea, 435-040 <http://www.sgsgroup.kr>

## 5. Hopping Channel Separation

### 5.1. Test Setup

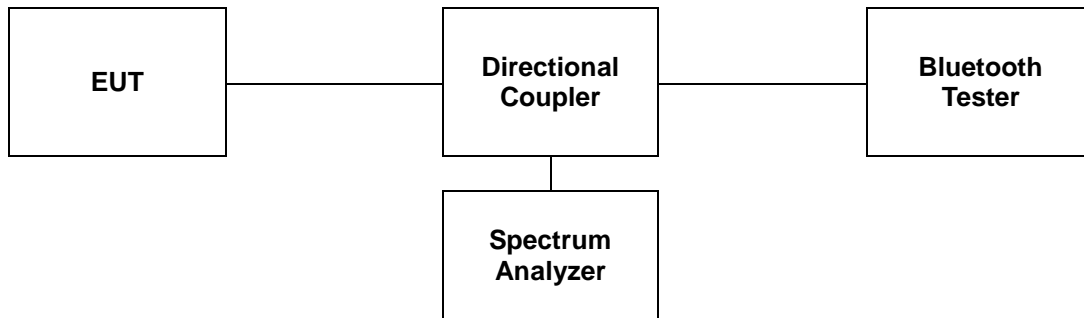

### 5.2. Limit

§15.247(a)(1) Frequency hopping system operating in 2 400 – 2 483.5 MHz. Band may have hopping channel carrier frequencies that are separated by 25 kHz or two-third of 20 dB bandwidth of the hopping channel, whichever is greater, provided the systems operate with an output power no greater than 125 mW.

### 5.3. Test Procedure

All data rates and modes were investigated for this test. The full data for the worst case data rate are reported in this section. The test follows DA000705.

The device is operating in hopping mode between 79 channels and also supporting Adaptive Frequency Hopping with hopping between 20 channels. As compared with each operating mode, 79 channels are chosen as a representative for test.

Use the following spectrum analyzer settings:

Span = wide enough to capture the peaks of two adjacent channels.

RBW = 1 % of the span.

VBW = RBW

Sweep = auto

Detector = peak

Trace = max hold.

Allow the trace to stabilize. Use the marker-delta function to determine the between the peaks of the adjacent channels.

*The results shown in this test report refer only to the sample(s) tested unless otherwise stated. This test report cannot be reproduced, except in full, without prior written permission of the Company.*

## 5.4. Test Results

Ambient temperature : (23 ± 1) °C  
 Relative humidity : 47 % R.H.

Operation Mode	Channel (Middle)	Adjacent Hopping Channel Separation (kHz)	Two-third of 20 dB Bandwidth (kHz)	Minimum Bandwidth (kHz)
GFSK	2 441 MHz	1 000	647	25
8DPSK	2 441 MHz	1 000	869	25

Note;

Measurement is made with EUT operating in hopping mode between 79 channels providing a worse case scenario as compared to AFH mode hopping between 20 channels.

*The results shown in this test report refer only to the sample(s) tested unless otherwise stated. This test report cannot be reproduced, except in full, without prior written permission of the Company.*

**Operating Mode: GFSK**

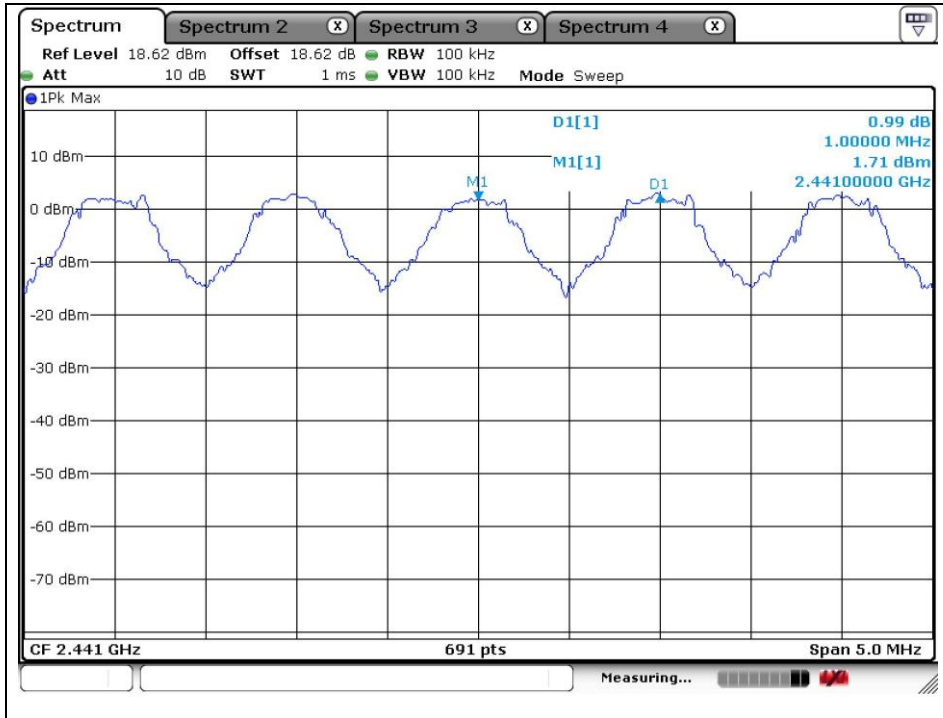

**Operating Mode: 8DPSK**

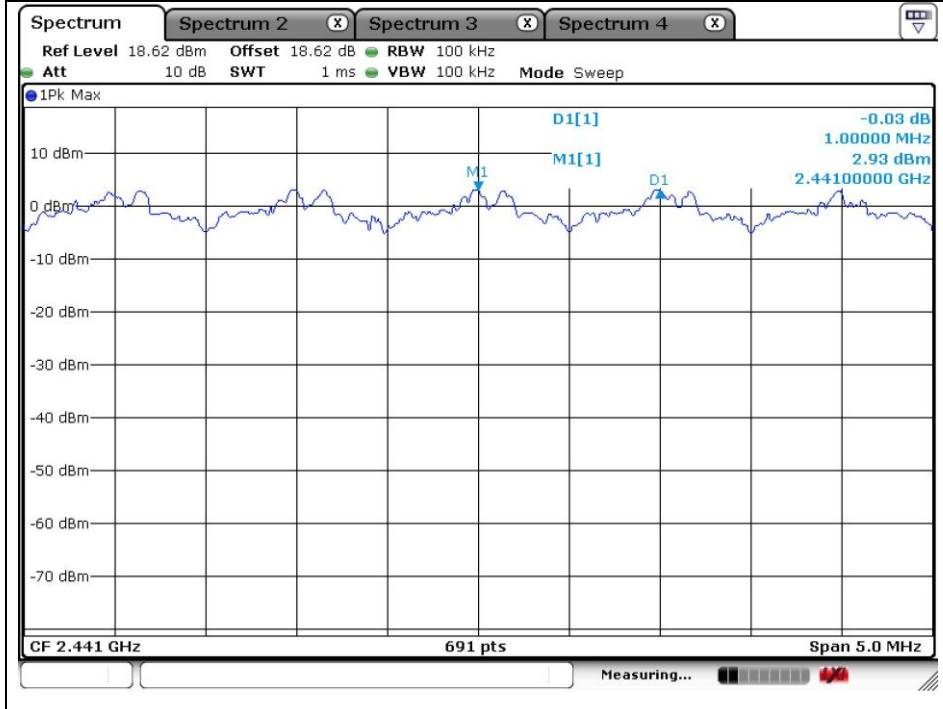

The results shown in this test report refer only to the sample(s) tested unless otherwise stated. This test report cannot be reproduced, except in full, without prior written permission of the Company.

## 6. Number of Hopping Frequency

### 6.1. Test Setup

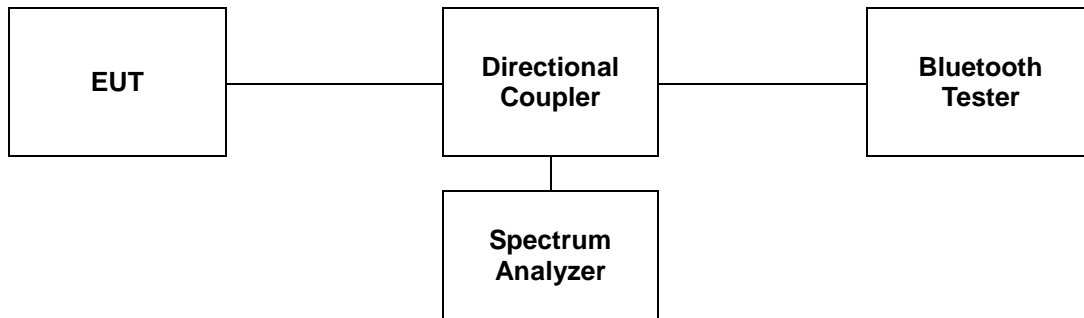

### 6.2. Limit

§15.247(a)(1)(iii), Frequency hopping systems in the 2 400–2 483.5 MHz band shall use at least 15 channels. The average time of occupancy on any channel shall not be greater than 0.4 seconds within a period of 0.4 seconds multiplied by the number of hopping channels employed. Frequency hopping systems may avoid or suppress transmissions on a particular hopping frequency provided that a minimum of 15 channels are used.

### 6.3. Test Procedure

All data rates and modes were investigated for this test. The full data for the worst case data rate are reported in this section. The test follows DA000705.

The device supports Adaptive Frequency Hopping and will use a minimum of 20 channels of the 79 available channels.

The EUT must have its hopping function enabled. Use the following spectrum analyzer settings:

1. Remove the antenna from the EUT and then connect a low loss RF cable from the antenna the port to the Spectrum analyzer
3. Set spectrum analyzer Start = 2 400 MHz, Stop = 2 441.5 MHz, Sweep=sweep and Start = 2 441.5 MHz, Stop = 2 483.5 MHz, Sweep = sweep. Detector = peak.
4. Set the spectrum analyzer as RBW, VBW = 500 kHz.
5. Max hold, allow the trace to stabilize and count how many channel in the band.

*The results shown in this test report refer only to the sample(s) tested unless otherwise stated. This test report cannot be reproduced, except in full, without prior written permission of the Company.*

## 6.4. Test Results

Ambient temperature : (23 ± 1) °C  
 Relative humidity : 47 % R.H.

Operation Mode	Number of Hopping Frequency	Limit
GFSK	79	≥ 15
8DPSK	79	≥ 15

**Remark:**

Measurement is made with EUT operating in hopping mode between 79 channels providing a worse case scenario as compared to AFH mode hopping between 20 channels.

*The results shown in this test report refer only to the sample(s) tested unless otherwise stated. This test report cannot be reproduced, except in full, without prior written permission of the Company.*



**Operating Mode: GFSK**

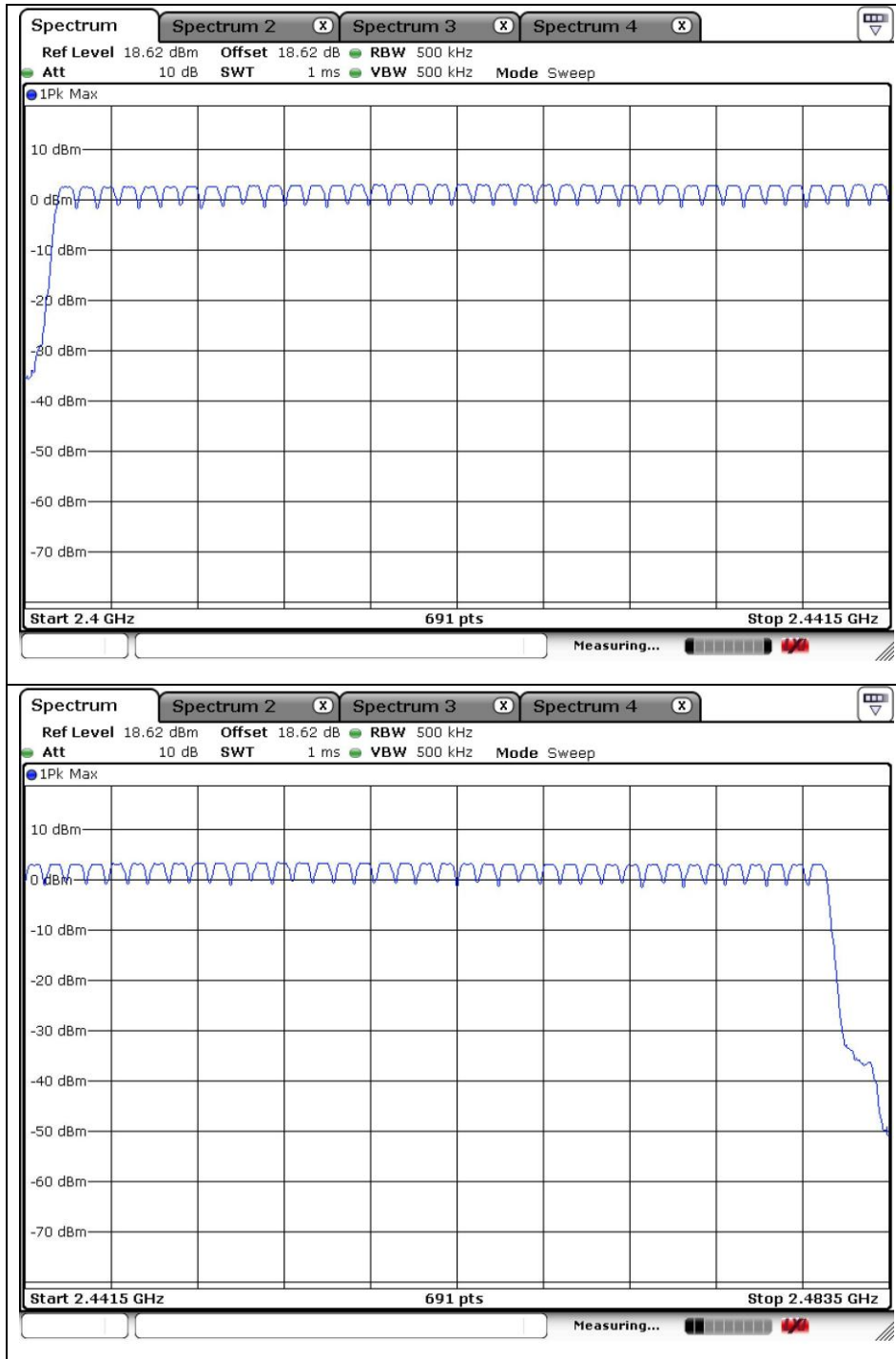

The results shown in this test report refer only to the sample(s) tested unless otherwise stated. This test report cannot be reproduced, except in full, without prior written permission of the Company.

**Operating Mode : 8DPSK**

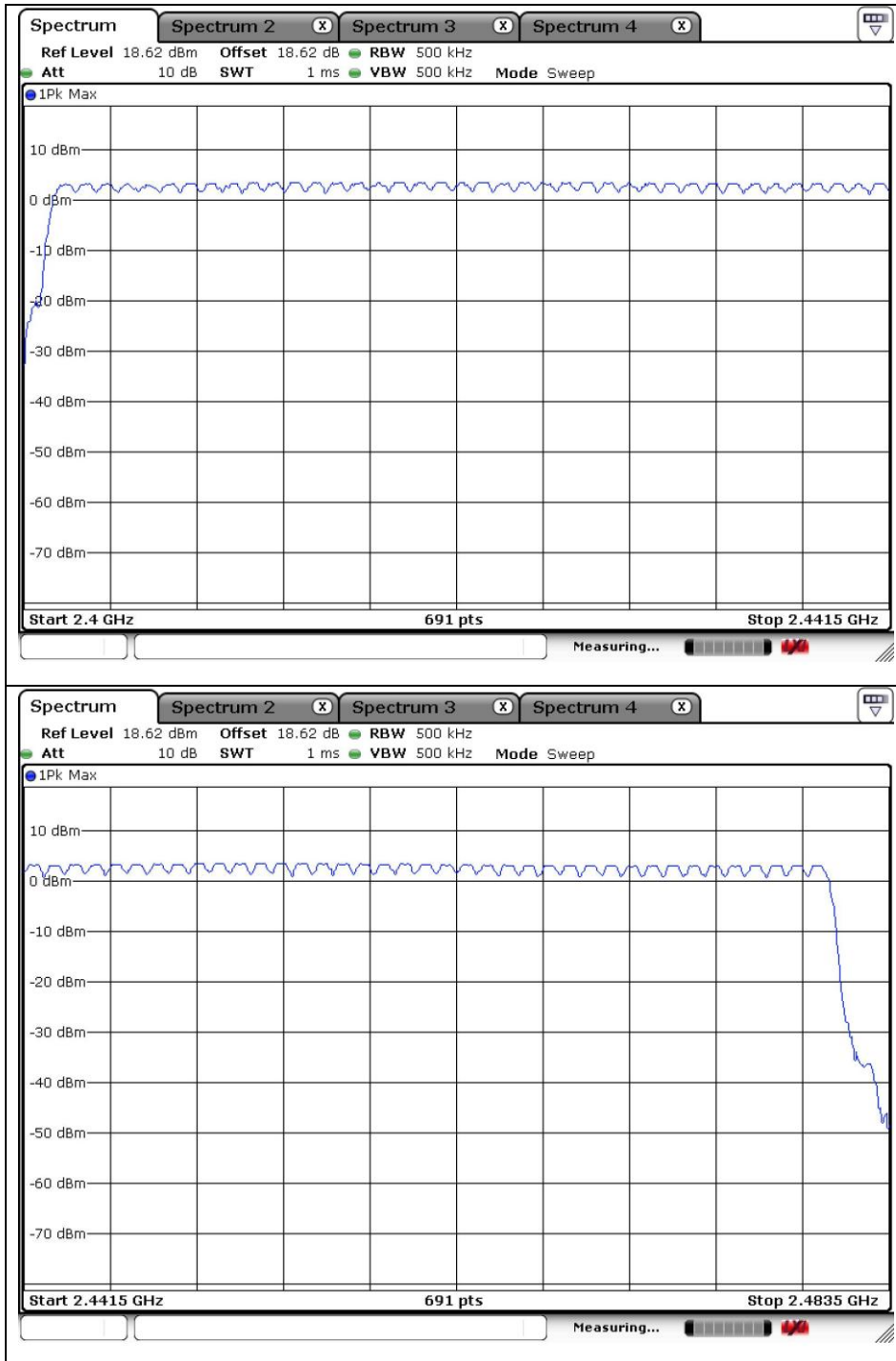

The results shown in this test report refer only to the sample(s) tested unless otherwise stated. This test report cannot be reproduced, except in full, without prior written permission of the Company.

## 7. Time of Occupancy (Dwell Time)

### 7.1. Test Set up

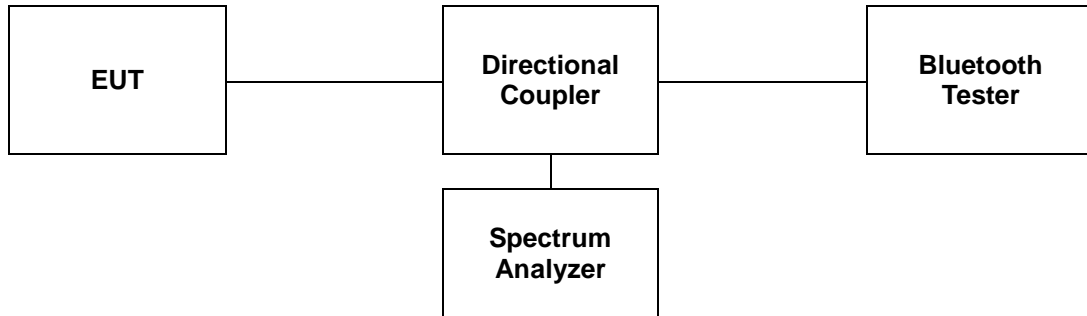

### 7.2. Limit

§15.247(a)(1)(iii) For frequency hopping system operating in the 2 400 – 2 483.5 MHz band, the average time of occupancy on any frequency shall not be greater than 0.4 second within a 31.6 second period.

A period time = 0.4(s) \* 79 = 31.6(s)

#### \*Adaptive Frequency Hopping

A period time = 0.4(s) \* 20 = 8 (s)

*The results shown in this test report refer only to the sample(s) tested unless otherwise stated. This test report cannot be reproduced, except in full, without prior written permission of the Company.*

---

### 7.3. Test Procedure

All data rates and modes were investigated for this test. The full data for the worst case data rate are reported in this section. The test follows DA000705.

1. Check the calibration of the measuring instrument using either an internal calibrator or a known signal from an external generator.
2. Position the EUT as shown in test setup without connection to measurement instrument. Turn on the EUT and connect its antenna terminal to measurement instrument via a low loss cable.
3. Measure the time duration of one transmission on the measured frequency. And then plot the result with time difference of this time duration.
4. The Bluetooth has 3 type of payload, DH1, DH3, DH5 and 3-DH1, 3-DH3, 3-DH5. The hopping rate is insisted of 1 600 per second.

The EUT must have its hopping function enabled. Use the following spectrum analyzer setting:

Span = zero span, centered on a hopping channel

RBW = 1 MHz

VBW = RBW

Sweep = as necessary to capture the entire dwell time per hopping channel

Detector = peak

Trace = max hold

Use the marker-delta function to determine the dwell time. If this value varies with different modes of operation repeat this test for each variation.

---

*The results shown in this test report refer only to the sample(s) tested unless otherwise stated. This test report cannot be reproduced, except in full, without prior written permission of the Company.*

## 7.4. Test Results

Ambient temperature : (23 ± 1) °C  
 Relative humidity : 47 % R.H.

### 7.4.1. Packet Type : DH1, 3DH1

Operation Mode	Frequency	Dwell Time (ms)	Time of occupancy on the Tx Channel in 31.6 sec (ms)	Limit for time of occupancy on the Tx Channel in 31.6 sec (ms)
GFSK	2 441 MHz	0.39	124.80	400
8DPSK	2 441 MHz	0.41	131.20	400

Note:

Time of occupancy on the TX channel in 31.6 sec

In case of GFSK,  $0.39 \times \{(1\ 600 \div 2) / 79\} \times 31.6 = 124.80$  ms

In case of 8DPSK,  $0.41 \times \{(1\ 600 \div 2) / 79\} \times 31.6 = 131.20$  ms

*The results shown in this test report refer only to the sample(s) tested unless otherwise stated. This test report cannot be reproduced, except in full, without prior written permission of the Company.*

**Operating Mode : GFSK**

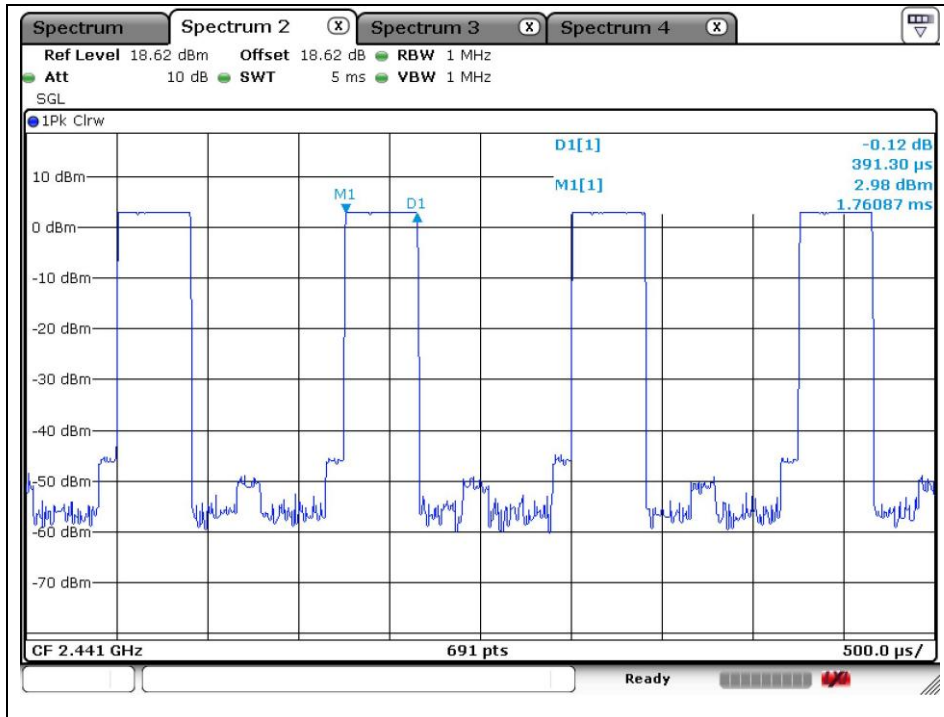

**Operating Mode : 8DPSK**

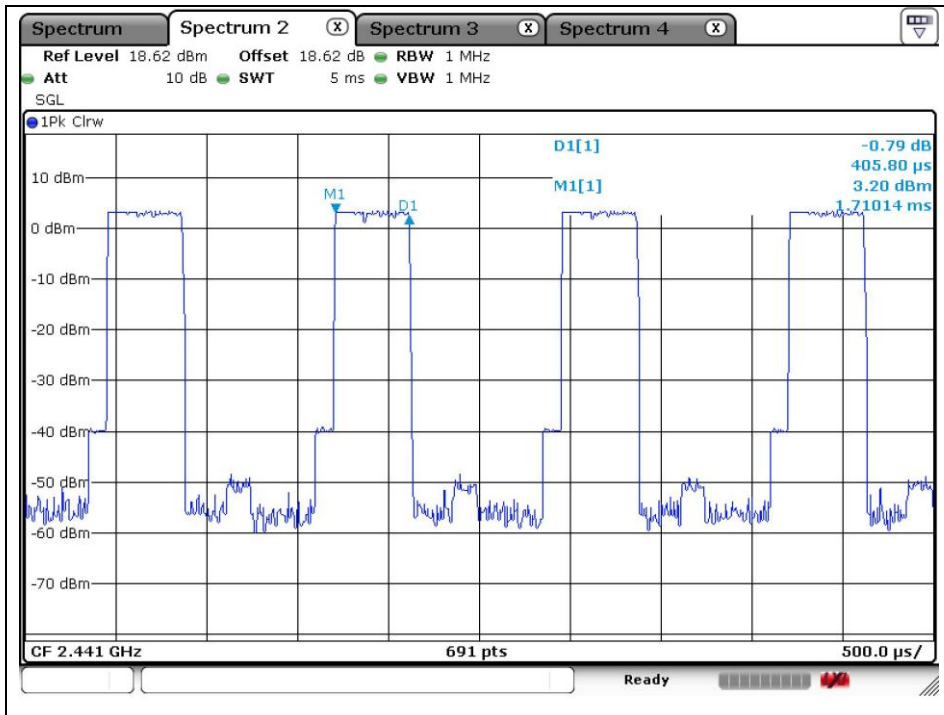

The results shown in this test report refer only to the sample(s) tested unless otherwise stated. This test report cannot be reproduced, except in full, without prior written permission of the Company.

**7.4.2. Packet Type: DH3, 3DH3**

Operation Mode	Frequency	Dwell Time (ms)	Time of occupancy on the Tx Channel in 31.6 sec (ms)	Limit for time of occupancy on the Tx Channel in 31.6 sec (ms)
GFSK	2 441 MHz	1.65	264.00	400
8DPSK	2 441 MHz	1.65	264.00	400

**Note:**

Time of occupancy on the TX channel in 31.6 sec

 In case of GFSK and 8DPSK,  $1.65 \times \{(1\ 600 \div 4) / 79\} \times 31.6 = 264.00$  ms

*The results shown in this test report refer only to the sample(s) tested unless otherwise stated. This test report cannot be reproduced, except in full, without prior written permission of the Company.*

**SGS Korea Co., Ltd. (Gunpo Laboratory)** 4, LS-ro 182beon-gil, Gunpo-si, Gyeonggi-do, Korea, 435-040 <http://www.sgsgroup.kr>

**Operating Mode : GFSK**

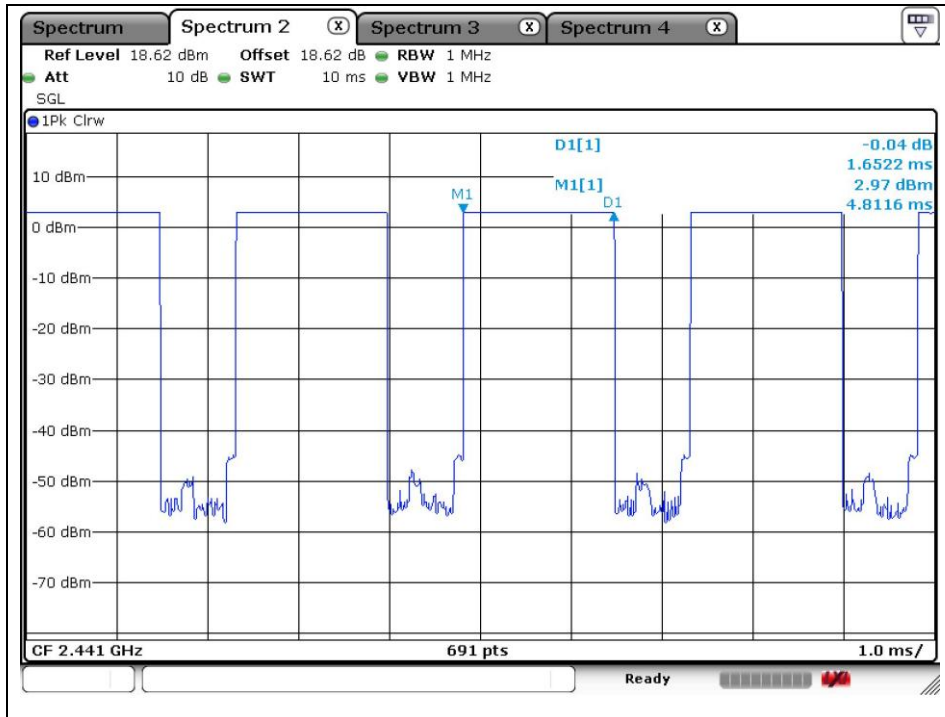

**Operating Mode : 8DPSK**

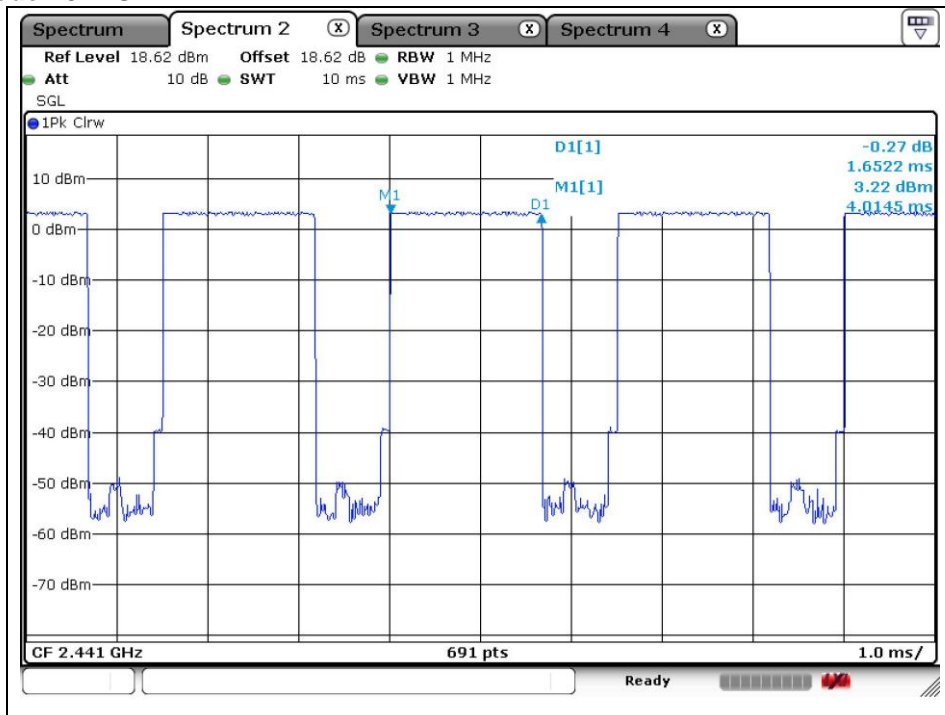

The results shown in this test report refer only to the sample(s) tested unless otherwise stated. This test report cannot be reproduced, except in full, without prior written permission of the Company.



**7.4.3. Packet Type: DH5, 3DH5**

Operation Mode	Frequency	Dwell Time (ms)	Time of occupancy on the Tx Channel in 31.6 sec (ms)	Limit for time of occupancy on the Tx Channel in 31.6 sec (ms)
GFSK	2 441 MHz	2.93	312.53	400
8DPSK	2 441 MHz	2.93	312.53	400

## Note:

Time of occupancy on the TX channel in 31.6 sec

 In case of GFSK and 8DPSK,  $2.93 \times \{(1\ 600 \div 6) / 79\} \times 31.6 = 312.53$  ms

*The results shown in this test report refer only to the sample(s) tested unless otherwise stated. This test report cannot be reproduced, except in full, without prior written permission of the Company.*

**SGS Korea Co., Ltd. (Gunpo Laboratory)** 4, LS-ro 182beon-gil, Gunpo-si, Gyeonggi-do, Korea, 435-040 <http://www.sgsgroup.kr>

RTT5041-20(2014.01.20)(2)

Tel. +82 31 428 5700 / Fax. +82 31 427 2370

A4(210 mm x 297 mm)

**Operating Mode : GFSK**

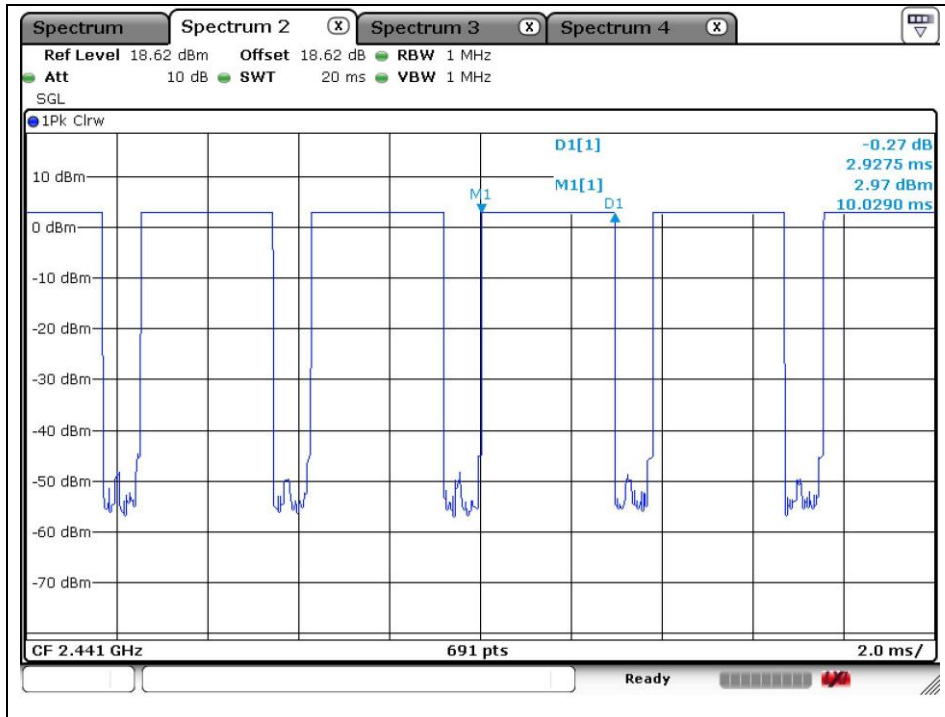

**Operating Mode : 8DPSK**

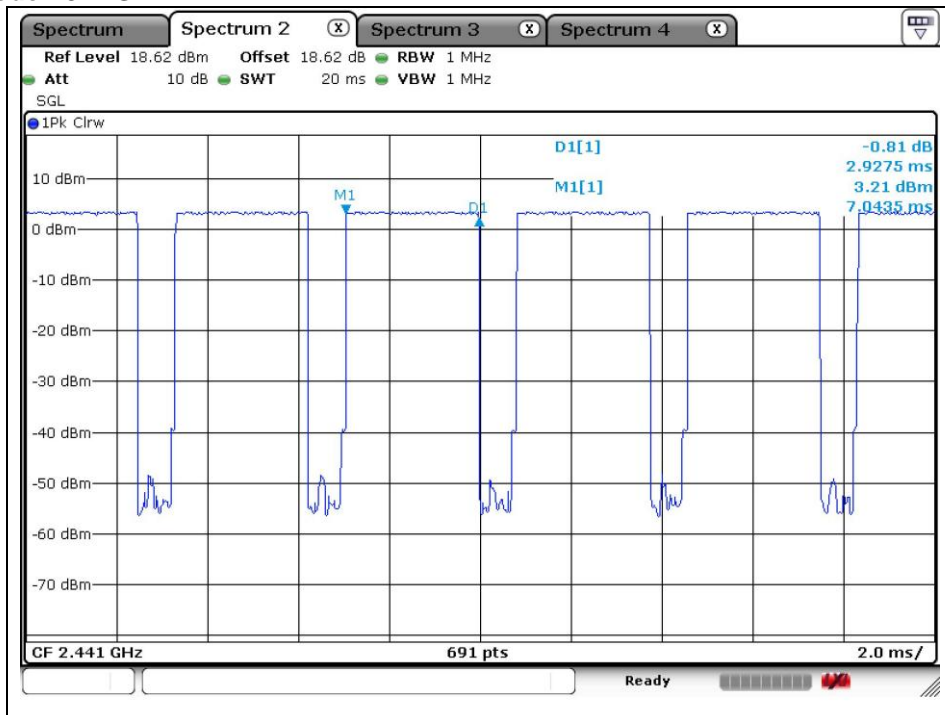

The results shown in this test report refer only to the sample(s) tested unless otherwise stated. This test report cannot be reproduced, except in full, without prior written permission of the Company.

**7.4.4. Packet Type : DH1, 3DH1 (Adaptive Frequency Hopping)**

Operation Mode	Frequency	Dwell Time (ms)	Time of occupancy on the Tx Channel in 8 sec (ms)	Limit for time of occupancy on the Tx Channel in 8 sec (ms)
GFSK	2 441 MHz	0.40	128.00	400
8DPSK	2 441 MHz	0.41	131.20	400

**Note:**

Time of occupancy on the TX channel in 8 sec

 In case of GFSK,  $0.40 \times \{(1\ 600 \div 2) / 20\} \times 8 = 128.00$  ms

 In case of 8DPSK,  $0.41 \times \{(1\ 600 \div 2) / 20\} \times 8 = 131.20$  ms

*The results shown in this test report refer only to the sample(s) tested unless otherwise stated. This test report cannot be reproduced, except in full, without prior written permission of the Company.*

**SGS Korea Co., Ltd. (Gunpo Laboratory)** 4, LS-ro 182beon-gil, Gunpo-si, Gyeonggi-do, Korea, 435-040 <http://www.sgsgroup.kr>

RTT5041-20(2014.01.20)(2)

Tel. +82 31 428 5700 / Fax. +82 31 427 2370

A4(210 mm x 297 mm)

**Operating Mode : GFSK**

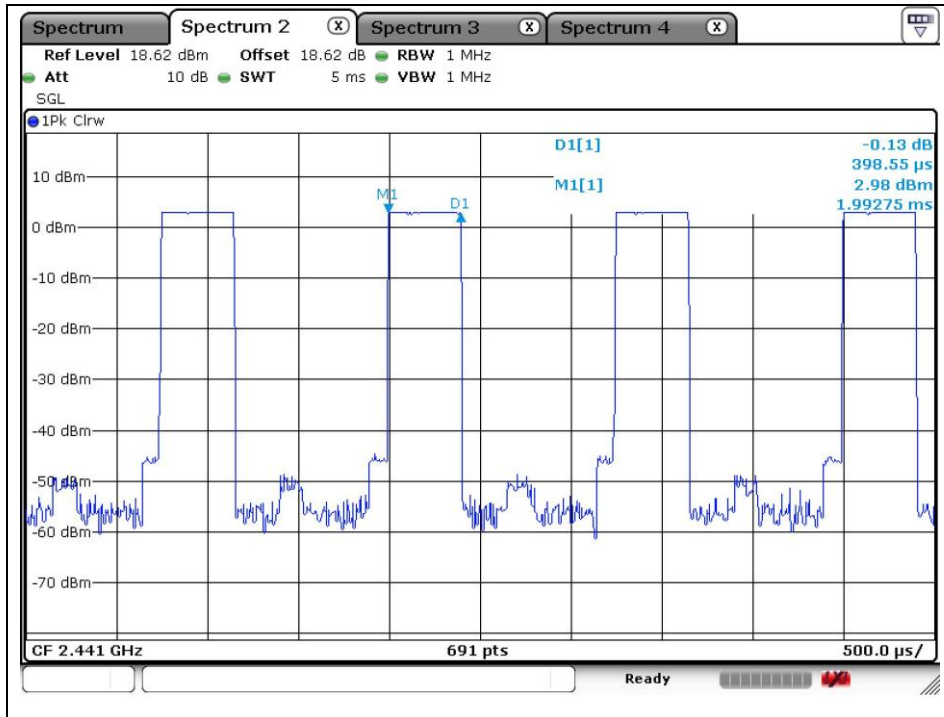

**Operating Mode : 8DPSK**

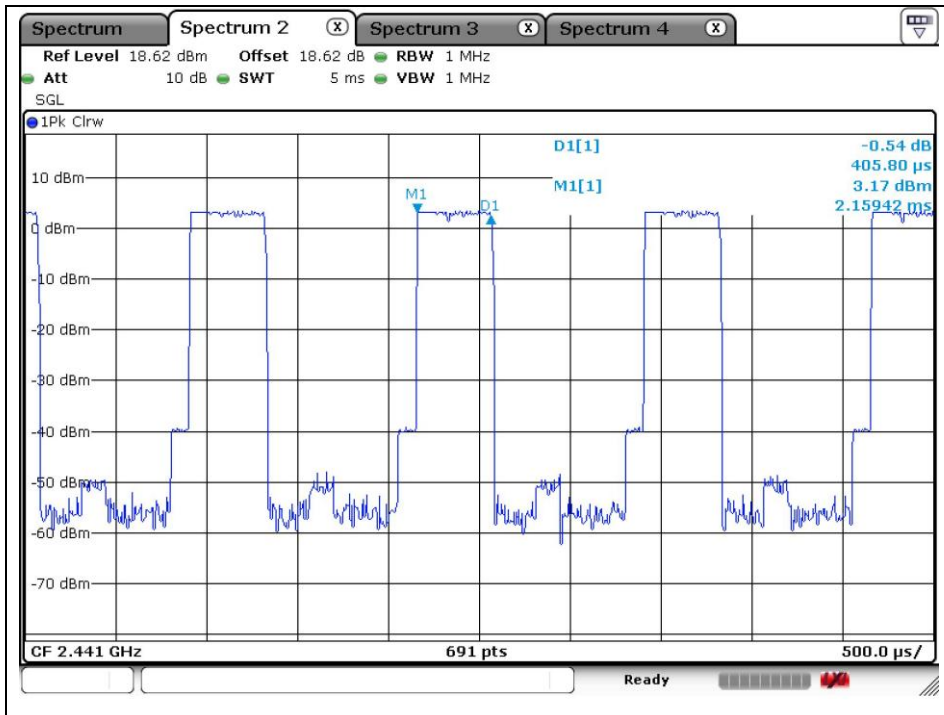

The results shown in this test report refer only to the sample(s) tested unless otherwise stated. This test report cannot be reproduced, except in full, without prior written permission of the Company.

**7.4.5. Packet Type : DH3, 3DH3 (Adaptive Frequency Hopping)**

Operation Mode	Frequency	Dwell Time (ms)	Time of occupancy on the Tx Channel in 8 sec (ms)	Limit for time of occupancy on the Tx Channel in 8 sec (ms)
GFSK	2 441 MHz	1.65	264.00	400
8DPSK	2 441 MHz	1.65	264.00	400

Note:

Time of occupancy on the TX channel in 8 sec

In case of GFSK and 8DPSK,  $1.65 \times \{(1\ 600 \div 4) / 20\} \times 8 = 264.00$  ms

*The results shown in this test report refer only to the sample(s) tested unless otherwise stated. This test report cannot be reproduced, except in full, without prior written permission of the Company.*

**SGS Korea Co., Ltd. (Gunpo Laboratory)** 4, LS-ro 182beon-gil, Gunpo-si, Gyeonggi-do, Korea, 435-040 <http://www.sgsgroup.kr>

RTT5041-20(2014.01.20)(2)

Tel. +82 31 428 5700 / Fax. +82 31 427 2370

A4(210 mm x 297 mm)

**Operating Mode : GFSK**

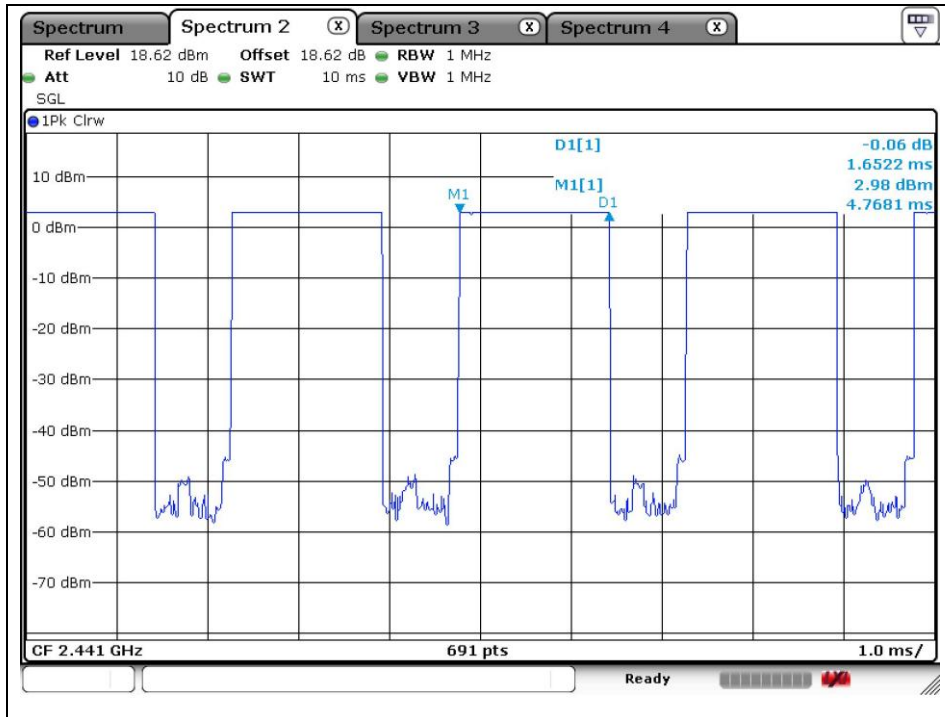

**Operating Mode : 8DPSK**

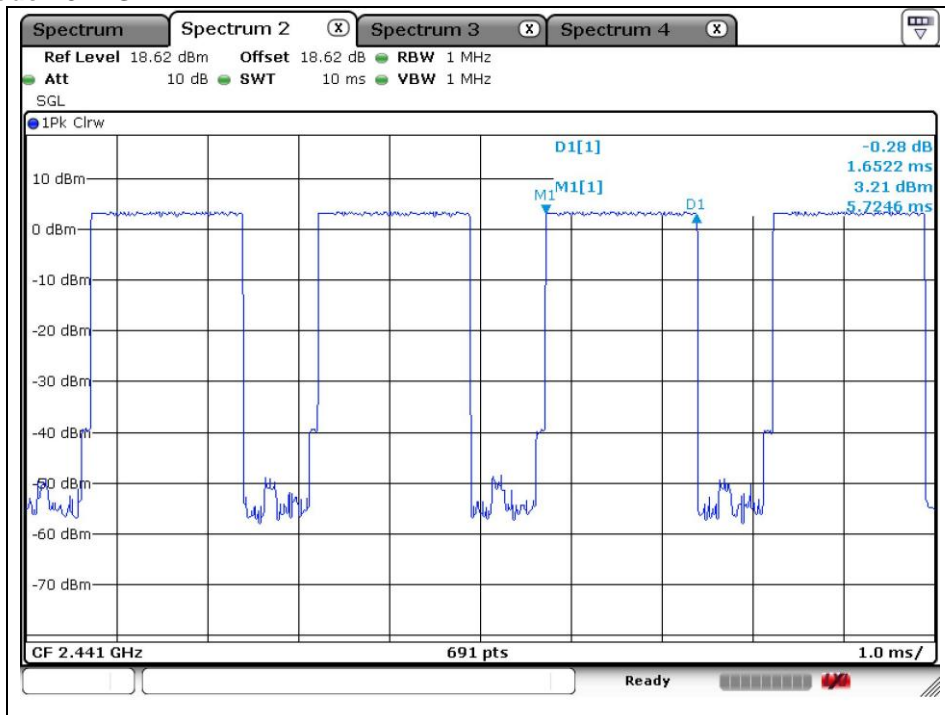

The results shown in this test report refer only to the sample(s) tested unless otherwise stated. This test report cannot be reproduced, except in full, without prior written permission of the Company.

**7.4.6. Packet Type : DH5, 3DH5 (Adaptive Frequency Hopping)**

Operation Mode	Frequency	Dwell Time (ms)	Time of occupancy on the Tx Channel in 8 sec (ms)	Limit for time of occupancy on the Tx Channel in 8 sec (ms)
GFSK	2 441 MHz	2.90	309.33	400
8DPSK	2 441 MHz	2.93	312.53	400

**Note:**

Time of occupancy on the TX channel in 8 sec

 In case of GFSK,  $2.90 \times \{(1\ 600 \div 6) / 20\} \times 8 = 309.33$  ms

 In case of 8DPSK,  $2.93 \times \{(1\ 600 \div 6) / 20\} \times 8 = 312.53$  ms

*The results shown in this test report refer only to the sample(s) tested unless otherwise stated. This test report cannot be reproduced, except in full, without prior written permission of the Company.*

**SGS Korea Co., Ltd. (Gunpo Laboratory)** 4, LS-ro 182beon-gil, Gunpo-si, Gyeonggi-do, Korea, 435-040 <http://www.sgsgroup.kr>

**Operating Mode : GFSK**

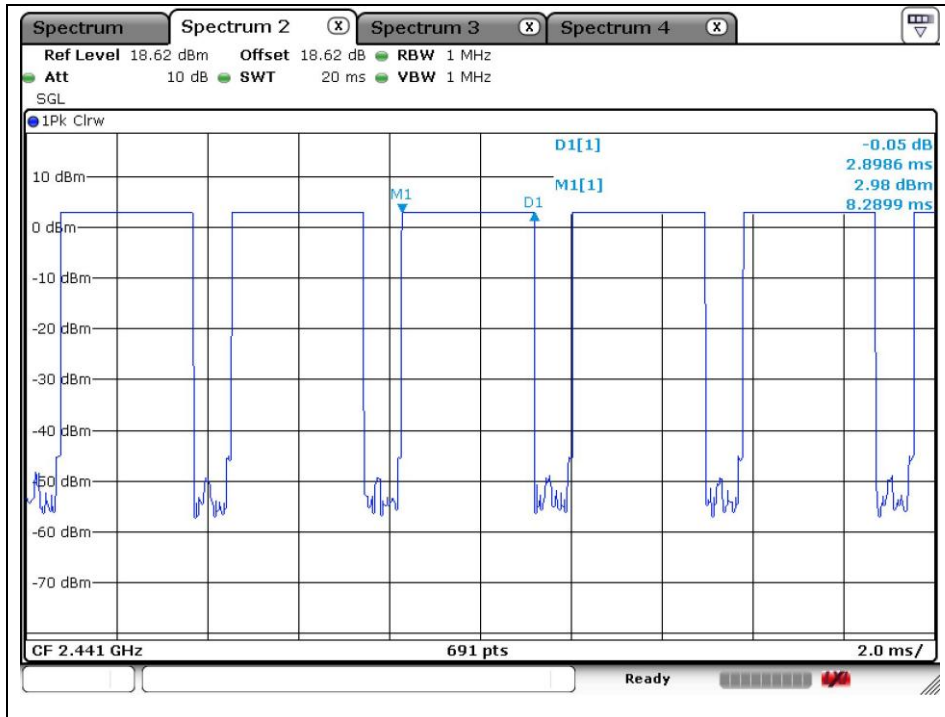

**Operating Mode : 8DPSK**

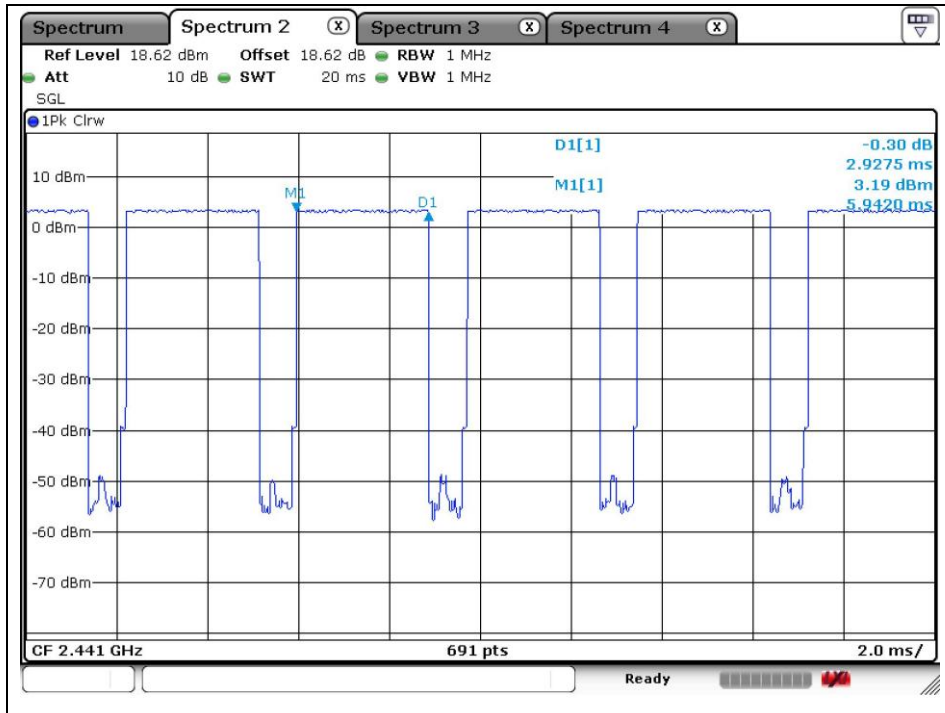

The results shown in this test report refer only to the sample(s) tested unless otherwise stated. This test report cannot be reproduced, except in full, without prior written permission of the Company.



---

## 8. Antenna Requirement

### 8.1. Standard Applicable

For intentional device, according to FCC 47 CFR Section §15.203, an intentional radiator shall be designed to ensure that no antenna other than that furnished by the responsible party shall be used with the device. And according to FCC 47 CFR Section §15.247 (b) if transmitting antennas of directional gain greater than 6 dB i are used, the power shall be reduced by the amount in dB that the gain of the antenna exceeds 6 dB i.

### 8.2. Antenna Connected Construction

Antenna used in this product is Chip Antenna type with gain of -5.83 dB i.

---

*The results shown in this test report refer only to the sample(s) tested unless otherwise stated. This test report cannot be reproduced, except in full, without prior written permission of the Company.*