



A D T

FCC TEST REPORT (15.247)

REPORT NO.: RF110303C19D-1
MODEL NO.: SC900 (Refer to item 3.1 for more details)
FCC ID: TQ2-SC900PDT-BWG
RECEIVED: Jan. 31, 2012
TESTED: Jul. 23 ~ Jul. 26, 2012
ISSUED: Aug. 21, 2012

APPLICANT: Shin Chuan Computer Co., Ltd.

ADDRESS: 6F-2, No. 268, LianCheng Rd., Zhonghe District,
New Taipei City 23553, Taiwan

ISSUED BY: Bureau Veritas Consumer Products Services
(H.K.) Ltd., Taoyuan Branch

LAB ADDRESS: No. 47, 14th Ling, Chia Pau Vil., Lin Kou Dist.,
New Taipei City, Taiwan, R.O.C.

TEST LOCATION: No. 19, Hwa Ya 2nd Rd, Wen Hwa Tsuen, Kwei
Shan Hsiang, Taoyuan Hsien 333, Taiwan, R.O.C.

This report should not be used by the client to claim product certification, approval, or endorsement by TAF or any government agencies.



This report is for your exclusive use. Any copying or replication of this report to or for any other person or entity, or use of our name or trademark, is permitted only with our prior written permission. This report sets forth our findings solely with respect to the test samples identified herein. The results set forth in this report are not indicative or representative of the quality or characteristics of the lot from which a test sample was taken or any similar or identical product unless specifically and expressly noted. Our report includes all of the tests requested by you and the results thereof based upon the information that you provided to us. You have 60 days from date of issuance of this report to notify us of any material error or omission caused by our negligence, provided, however, that such notice shall be in writing and shall specifically address the issue you wish to raise. A failure to raise such issue within the prescribed time shall constitute your unqualified acceptance of the completeness of this report, the tests conducted and the correctness of the report contents. Unless specific mention, the uncertainty of measurement has been explicitly taken into account to declare the compliance or non-compliance to the specification.



TABLE OF CONTENTS

RELEASE CONTROL RECORD.....	4
1. CERTIFICATION	5
2. SUMMARY OF TEST RESULTS	6
2.1 MEASUREMENT UNCERTAINTY	6
3. GENERAL INFORMATION.....	7
3.1 GENERAL DESCRIPTION OF EUT.....	7
3.2 DESCRIPTION OF TEST MODES.....	9
3.2.1 TEST MODE APPLICABILITY AND TESTED CHANNEL DETAIL	10
3.3 DESCRIPTION OF SUPPORT UNITS	12
3.3.1 CONFIGURATION OF SYSTEM UNDER TEST	12
3.4 GENERAL DESCRIPTION OF APPLIED STANDARDS	13
4. TEST TYPES AND RESULTS (FOR 2.4GHz BAND).....	14
4.1 RADIATED EMISSION AND BANDEDGE MEASUREMENT.....	14
4.1.1 LIMITS OF RADIATED EMISSION AND BANDEDGE MEASUREMENT	14
4.1.2 TEST INSTRUMENTS.....	15
4.1.3 TEST PROCEDURES	16
4.1.4 DEVIATION FROM TEST STANDARD	16
4.1.5 TEST SETUP.....	17
4.1.6 EUT OPERATING CONDITIONS	17
4.1.7 TEST RESULTS	18
4.2 CONDUCTED EMISSION MEASUREMENT	20
4.2.1 LIMITS OF CONDUCTED EMISSION MEASUREMENT.....	20
4.2.2 TEST INSTRUMENTS.....	20
4.2.3 TEST PROCEDURES	21
4.2.4 DEVIATION FROM TEST STANDARD	21
4.2.5 TEST SETUP.....	21
4.2.6 EUT OPERATING CONDITIONS	21
4.2.7 TEST RESULTS	22
5. TEST TYPES AND RESULTS (FOR 5.0GHz BAND).....	24
5.1 RADIATED EMISSION MEASUREMENT	24
5.1.1 LIMITS OF RADIATED EMISSION MEASUREMENT	24
5.1.2 TEST INSTRUMENTS.....	25
5.1.3 TEST PROCEDURES	26
5.1.4 DEVIATION FROM TEST STANDARD	26
5.1.5 TEST SETUP.....	26
5.1.6 EUT OPERATING CONDITIONS	26
5.1.7 TEST RESULTS	27
5.2 CONDUCTED EMISSION MEASUREMENT	29
5.2.1 LIMITS OF CONDUCTED EMISSION MEASUREMENT.....	29
5.2.2 TEST INSTRUMENTS.....	29
5.2.3 TEST PROCEDURES	29



A D T

5.2.4	DEVIATION FROM TEST STANDARD	29
5.2.5	TEST SETUP.....	29
5.2.6	EUT OPERATING CONDITIONS	29
5.2.7	TEST RESULTS	30
6.	PHOTOGRAPHS OF THE TEST CONFIGURATION.....	32
7.	INFORMATION ON THE TESTING LABORATORIES	33
8.	APPENDIX A - MODIFICATIONS RECORDERS FOR ENGINEERING CHANGES TO THE EUT BY THE LAB.....	34



A D T

RELEASE CONTROL RECORD

ISSUE NO.	REASON FOR CHANGE	DATE ISSUED
RF110303C19D-1	Original release	Aug. 21, 2012



A D T

1. CERTIFICATION

PRODUCT: Portable Data Terminal
MODEL NO.: SC900 (Refer to item 3.1 for more details)
BRAND: SCC
APPLICANT: Shin Chuan Computer Co., Ltd.
TESTED: Jul. 23 ~ Jul. 26, 2012
TEST SAMPLE: ENGINEERING SAMPLE
STANDARDS: **FCC Part 15, Subpart C (Section 15.247)**
ANSI C63.10-2009

This report is issued as a supplementary report of BV ADT report no.: **RF110303C19A-1** for adding model, barcode readers and data pin changing from 6pin to 10 pin. This report shall be used combining with its original report.

PREPARED BY : Ivy Lin , **DATE :** Aug. 21, 2012
Ivy Lin / Specialist

APPROVED BY : Gary Chang , **DATE :** Aug. 21, 2012
Gary Chang / Technical Manager

NOTE: The emission tests were performed for the addendum. Refer to original report for the other test data.



2. SUMMARY OF TEST RESULTS

The EUT has been tested according to the following specifications:

APPLIED STANDARD: FCC PART 15, SUBPART C (SECTION 15.247)			
STANDARD SECTION	TEST TYPE	RESULT	REMARK
15.207	AC Power Conducted Emission	PASS	Meet the requirement of limit. Minimum passing margin is -18.60dB at 0.15643MHz.
15.247(d) 15.209	Radiated Emissions	PASS	Meet the requirement of limit. Minimum passing margin is -1.8dB at 2390.00MHz.
15.247(d)	Band Edge Measurement	NA	Refer to Note
15.247(a)(2)	6dB bandwidth	NA	Refer to Note
15.247(b)	Conducted power	NA	Refer to Note
15.247(e)	Power Spectral Density	NA	Refer to Note
15.203	Antenna Requirement	PASS	Antenna connector is I-PEX not a standard connector.

NOTE: The emission tests were performed for the addendum. Refer to original report for the other test data.

2.1 MEASUREMENT UNCERTAINTY

Where relevant, the following measurement uncertainty levels have been estimated for tests performed on the EUT as specified in CISPR 16-4-2:

MEASUREMENT	FREQUENCY	UNCERTAINTY
Conducted emissions	9kHz~30MHz	2.44 dB
Radiated emissions	30MHz ~ 200MHz	3.19 dB
	200MHz ~1000MHz	3.21 dB
	1GHz ~ 18GHz	2.26 dB
	18GHz ~ 40GHz	1.94 dB

This uncertainty represents an expanded uncertainty expressed at approximately the 95% confidence level using a coverage factor of $k = 2$.



A D T

3. GENERAL INFORMATION

3.1 GENERAL DESCRIPTION OF EUT

EUT	Portable Data Terminal
MODEL NO.	SC900 (Refer to Note for more details)
POWER SUPPLY	3.7Vdc (Li-ion battery) 5.0Vdc (Adapter) 5.0Vdc (Host equipment)
MODULATION TYPE	CCK, DQPSK, DBPSK for DSSS 64QAM, 16QAM, QPSK, BPSK for OFDM
MODULATION TECHNOLOGY	DSSS, OFDM
TRANSFER RATE	802.11b: 11.0/ 5.5/ 2.0/ 1.0Mbps 802.11g: 54.0/ 48.0/ 36.0/ 24.0/ 18.0/ 12.0/ 9.0/ 6.0Mbps 802.11a: 54.0/ 48.0/ 36.0/ 24.0/ 18.0/ 12.0/ 9.0/ 6.0Mbps
OPERATING FREQUENCY	2.4GHz: 2412 ~ 2462MHz 5.0GHz: 5745 ~ 5825MHz
NUMBER OF CHANNEL	2.4GHz: 11 for 802.11b, 802.11g 5.0GHz: 5 for 802.11a
OUTPUT POWER	218.8mW for 2412 ~ 2462MHz 125.9mW for 5745 ~ 5825MHz
ANTENNA TYPE	2.4GHz: PIFA antenna with -2.6dBi gain 5.0GHz: PIFA antenna with -3.81dBi gain
ANTENNA CONNECTOR	I-PEX
DATA CABLE	1.3m non-shielded USB cable with 2 cores
I/O PORTS	Refer to user's manual
ACCESSORY DEVICES	Battery, Adapter, Earphone (1.2m non-shielded cable)



NOTE:

1. This report is issued as a supplementary report of RF110303C19A-1. This report shall be combined together with its original report.
2. This report is prepared for FCC class II permissive change. Differences compared with the original report are adding model, barcode readers and data pin changing from 6pin to 10 pin.
3. The following models are provided to the EUT. (New models are marked in boldface.)

BRAND NAME	MODEL NO.	DIFFERENCE	
		USB PORT	EARPHONE PORT
SCC	SC900	With	Without
	M1000	Without	With
SCC	H25	Based on model: SC900 Marketing purpose	
SCC	CX3		

4. The following barcode readers are provided to EUT.

For model: SC900			For model: M1000		
Brand	Model	Barcode Reader	Brand	Model	Barcode Reader
MDI	MDI2350	2D image	Motorola	SE4500	2D image

*After pre-testing, model: SC900 is the worst case for final test.

5. The EUT provides one completed transmitter and one receiver.

MODULATION MODE	TX FUNCTION
802.11b	1TX
802.11g	1TX
802.11a	1TX

6. The EUT uses following adapter and battery.

ADAPTER	
Brand	Powertron Electronics Corp.
Model	PA1008-050SI100
Input Power	100-240Vac, 50-60Hz, 0.3A
Output Power	5Vdc, 1.0A, 5W Max.

Li-ion Battery	
Brand	ETI CA
Power Rating	3.7Vdc, 1840mAh/ 6.8Wh

7. The above EUT information is declared by manufacturer and for more detailed features description, please refer to the manufacturer's specifications or user's manual.



3.2 DESCRIPTION OF TEST MODES

FOR 2.4GHz:

11 channels are provided for 802.11b and 802.11g:

CHANNEL	FREQUENCY	CHANNEL	FREQUENCY
1	2412MHz	7	2442MHz
2	2417MHz	8	2447MHz
3	2422MHz	9	2452MHz
4	2427MHz	10	2457MHz
5	2432MHz	11	2462MHz
6	2437MHz		

FOR 5.0GHz (5745 ~ 5825MHz):

5 channels are provided for 802.11a:

CHANNEL	FREQUENCY	CHANNEL	FREQUENCY
149	5745MHz	161	5805MHz
153	5765MHz	165	5825MHz
157	5785MHz		



3.2.1 TEST MODE APPLICABILITY AND TESTED CHANNEL DETAIL

FOR 2.4GHz:

EUT CONFIGURE MODE	APPLICABLE TO			DESCRIPTION
	RE≥1G	RE<1G	PLC	
-	√	√	√	-

Where **RE≥1G:** Radiated Emission above 1GHz **RE<1G:** Radiated Emission below 1GHz
PLC: Power Line Conducted Emission

NOTE:
The EUT was positioned on Z-plane, based on the original worst axis.

RADIATED EMISSION TEST (ABOVE 1GHz):

- Pre-Scan has been conducted to determine the worst-case mode from all possible combinations between available modulations, data rates and antenna ports (if EUT with antenna diversity architecture).
- Following channel(s) was (were) selected for the final test as listed below.

EUT CONFIGURE MODE	MODE	AVAILABLE CHANNEL	TESTED CHANNEL	MODULATION TECHNOLOGY	MODULATION TYPE	DATA RATE (Mbps)
-	802.11g	1 to 11	1	OFDM	BPSK	6.0

RADIATED EMISSION TEST (BELOW 1GHz):

- Pre-Scan has been conducted to determine the worst-case mode from all possible combinations between available modulations, data rates and antenna ports (if EUT with antenna diversity architecture).
- Following channel(s) was (were) selected for the final test as listed below.

EUT CONFIGURE MODE	MODE	AVAILABLE CHANNEL	TESTED CHANNEL	MODULATION TECHNOLOGY	MODULATION TYPE	DATA RATE (Mbps)
-	802.11g	1 to 11	1	OFDM	BPSK	6.0

POWER LINE CONDUCTED EMISSION TEST:

- Pre-Scan has been conducted to determine the worst-case mode from all possible combinations between available modulations, data rates and antenna ports (if EUT with antenna diversity architecture).
- Following channel(s) was (were) selected for the final test as listed below.

EUT CONFIGURE MODE	MODE	AVAILABLE CHANNEL	TESTED CHANNEL	MODULATION TECHNOLOGY	MODULATION TYPE	DATA RATE (Mbps)
-	802.11g	1 to 11	1	OFDM	BPSK	6.0

TEST CONDITION:

APPLICABLE TO	ENVIRONMENTAL CONDITIONS	INPUT POWER	TESTED BY
RE≥1G	26deg. C, 69%RH	120Vac, 60Hz	Alan Wu
RE<1G	26deg. C, 69%RH	120Vac, 60Hz	Alan Wu
PLC	25deg. C, 60%RH	120Vac, 60Hz	Hero Su



A D T

FOR 5.0GHz (5745 ~ 5825MHz):

EUT CONFIGURE MODE	APPLICABLE TO			DESCRIPTION
	RE≥1G	RE<1G	PLC	
-	√	√	√	-

Where **RE≥1G**: Radiated Emission above 1GHz **RE<1G**: Radiated Emission below 1GHz
PLC: Power Line Conducted Emission

NOTE:
The EUT was positioned on Z-plane, based on the original worst axis.

RADIATED EMISSION TEST (ABOVE 1GHz):

- Pre-Scan has been conducted to determine the worst-case mode from all possible combinations between available modulations, data rates and antenna ports (if EUT with antenna diversity architecture).
- Following channel(s) was (were) selected for the final test as listed below.

EUT CONFIGURE MODE	MODE	AVAILABLE CHANNEL	TESTED CHANNEL	MODULATION TECHNOLOGY	MODULATION TYPE	DATA RATE (Mbps)
-	802.11a	149 to 165	165	OFDM	BPSK	6.0

RADIATED EMISSION TEST (BELOW 1GHz):

- Pre-Scan has been conducted to determine the worst-case mode from all possible combinations between available modulations, data rates and antenna ports (if EUT with antenna diversity architecture).
- Following channel(s) was (were) selected for the final test as listed below.

EUT CONFIGURE MODE	MODE	AVAILABLE CHANNEL	TESTED CHANNEL	MODULATION TECHNOLOGY	MODULATION TYPE	DATA RATE (Mbps)
-	802.11a	149 to 165	157	OFDM	BPSK	6.0

POWER LINE CONDUCTED EMISSION TEST:

- Pre-Scan has been conducted to determine the worst-case mode from all possible combinations between available modulations, data rates and antenna ports (if EUT with antenna diversity architecture).
- Following channel(s) was (were) selected for the final test as listed below.

EUT CONFIGURE MODE	MODE	AVAILABLE CHANNEL	TESTED CHANNEL	MODULATION TECHNOLOGY	MODULATION TYPE	DATA RATE (Mbps)
-	802.11a	149 to 165	157	OFDM	BPSK	6.0

TEST CONDITION:

APPLICABLE TO	ENVIRONMENTAL CONDITIONS	INPUT POWER	TESTED BY
RE≥1G	26deg. C, 69%RH	120Vac, 60Hz	Alan Wu
RE<1G	26deg. C, 69%RH	120Vac, 60Hz	Alan Wu
PLC	25deg. C, 60%RH	120Vac, 60Hz	Hero Su

3.3 DESCRIPTION OF SUPPORT UNITS

The EUT has been tested as an independent unit.

3.3.1 CONFIGURATION OF SYSTEM UNDER TEST

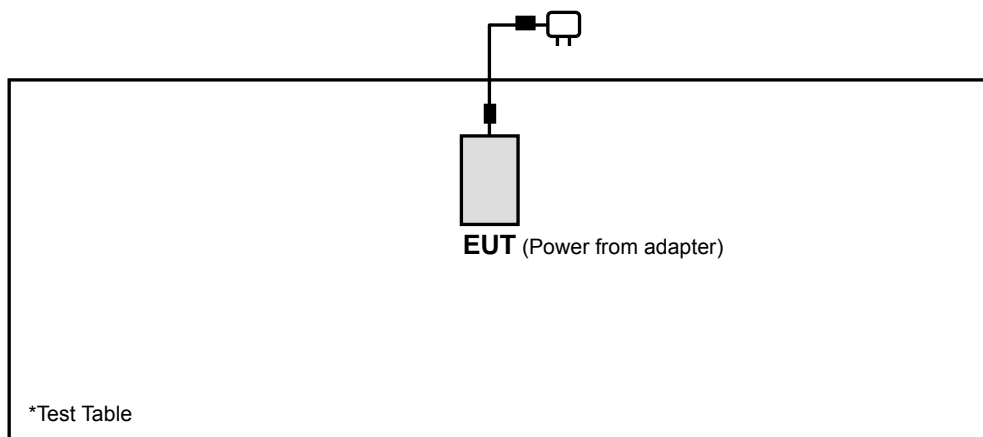



A D T

3.4 GENERAL DESCRIPTION OF APPLIED STANDARDS

The EUT is a RF Product. According to the specifications of the manufacturer, it must comply with the requirements of the following standards:

FCC Part 15, Subpart C (15.247)

ANSI C63.10-2009

All test items have been performed and recorded as per the above standards.

NOTE: The EUT is also considered as a kind of computer peripheral, because the connection to computer is necessary for typical use. It has been verified to comply with the requirements of FCC Part 15, Subpart B, Class B (DoC). The test report has been issued separately.



4. TEST TYPES AND RESULTS (FOR 2.4GHz BAND)

4.1 RADIATED EMISSION AND BANDEDGE MEASUREMENT

4.1.1 LIMITS OF RADIATED EMISSION AND BANDEDGE MEASUREMENT

Radiated emissions which fall in the restricted bands must comply with the radiated emission limits specified as below table. Other emissions shall be at least 20dB below the highest level of the desired power:

FREQUENCIES (MHz)	FIELD STRENGTH (microvolts/meter)	MEASUREMENT DISTANCE (meters)
0.009 ~ 0.490	2400/F(kHz)	300
0.490 ~ 1.705	24000/F(kHz)	30
1.705 ~ 30.0	30	30
30 ~ 88	100	3
88 ~ 216	150	3
216 ~ 960	200	3
Above 960	500	3

NOTE:

1. The lower limit shall apply at the transition frequencies.
2. Emission level (dBuV/m) = 20 log Emission level (uV/m).
3. For frequencies above 1000MHz, the field strength limits are based on average detector, however, the peak field strength of any emission shall not exceed the maximum permitted average limits, specified above by more than 20dB under any condition of modulation.



A D T

4.1.2 TEST INSTRUMENTS

DESCRIPTION & MANUFACTURER	MODEL NO.	SERIAL NO.	DATE OF CALIBRATION	DUE DATE OF CALIBRATION
Test Receiver ROHDE & SCHWARZ	ESI7	838496/016	Jan. 03, 2012	Jan. 02, 2013
Spectrum Analyzer ROHDE & SCHWARZ	FSU43	100115	Sep. 05, 2011	Sep. 04, 2012
BILOG Antenna SCHWARZBECK	VULB9168	9168-155	Apr. 06, 2012	Apr. 05, 2013
HORN Antenna SCHWARZBECK	BBHA 9120D	9120D-408	Jan. 05, 2012	Jan. 04, 2013
HORN Antenna SCHWARZBECK	BBHA 9170	148	Jul. 11, 2012	Jul. 10, 2013
Preamplifier Agilent	8449B	3008A01961	Oct. 29, 2011	Oct. 28, 2012
Preamplifier Agilent	8447D	2944A10738	Oct. 29, 2011	Oct. 28, 2012
RF signal cable HUBER+SUHNNER	SUCOFLEX 104	309220/4	Nov. 03, 2011	Nov. 02, 2012
RF signal cable HUBER+SUHNNER	SUCOFLEX 104	250724/4	Nov. 03, 2011	Nov. 02, 2012
RF signal cable HUBER+SUHNNER	SUCOFLEX 104	295012/4	Nov. 03, 2011	Nov. 02, 2012
Software ADT	ADT_Radiated_ V7.6.15.9.2	NA	NA	NA
Antenna Tower inn-co GmbH	MA 4000	010303	NA	NA
Antenna Tower Controller inn-co GmbH	CO2000	019303	NA	NA
Turn Table ADT	TT100.	TT93021704	NA	NA
Turn Table Controller ADT	SC100.	SC93021704	NA	NA

- NOTE:**
1. The calibration interval of the above test instruments is 12 months and the calibrations are traceable to NML/ROC and NIST/USA.
 2. The test was performed in HwaYa Chamber 4.
 3. The horn antenna and HP preamplifier (model: 8449B) are used only for the measurement of emission frequency above 1GHz if tested.
 4. The FCC Site Registration No. is 460141.
 5. The IC Site Registration No. is IC7450F-4.



A D T

4.1.3 TEST PROCEDURES

- a. The EUT was placed on the top of a rotating table 0.8 meters above the ground at a 3 meters semi-anechoic chamber. The table was rotated 360 degrees to determine the position of the highest radiation.
- b. The EUT was set 3 meters away from the interference-receiving antenna, which was mounted on the top of a variable-height antenna tower.
- c. The antenna is a broadband antenna, and its height is varied from one meter to four meters above the ground to determine the maximum value of the field strength. Both horizontal and vertical polarizations of the antenna are set to make the measurement.
- d. For each suspected emission, the EUT was arranged to its worst case and then the antenna was tuned to heights from 1 meter to 4 meters and the rotatable table was turned from 0 degrees to 360 degrees to find the maximum reading.
- e. The test-receiver system was set to Peak Detect Function and Specified Bandwidth with Maximum Hold Mode.
- f. If the emission level of the EUT in peak mode was lower than the limit specified, then testing could be stopped and the peak values of the EUT would be reported. Otherwise the emissions would be re-tested one by one using peak, quasi-peak or average method as specified and then reported in a data sheet.

NOTE:

1. The resolution bandwidth and video bandwidth of test receiver/spectrum analyzer is 120kHz for Quasi-peak detection at frequency below 1GHz.
2. The resolution bandwidth of test receiver/spectrum analyzer is 100kHz and video bandwidth is 300kHz for Peak detection at frequency above 1GHz.
3. The resolution bandwidth of test receiver/spectrum analyzer is 1MHz and the video bandwidth is 1kHz for Average detection (AV) at frequency above 1GHz.
4. All modes of operation were investigated and the worst-case emissions are reported.

4.1.4 DEVIATION FROM TEST STANDARD

No deviation.

4.1.5 TEST SETUP

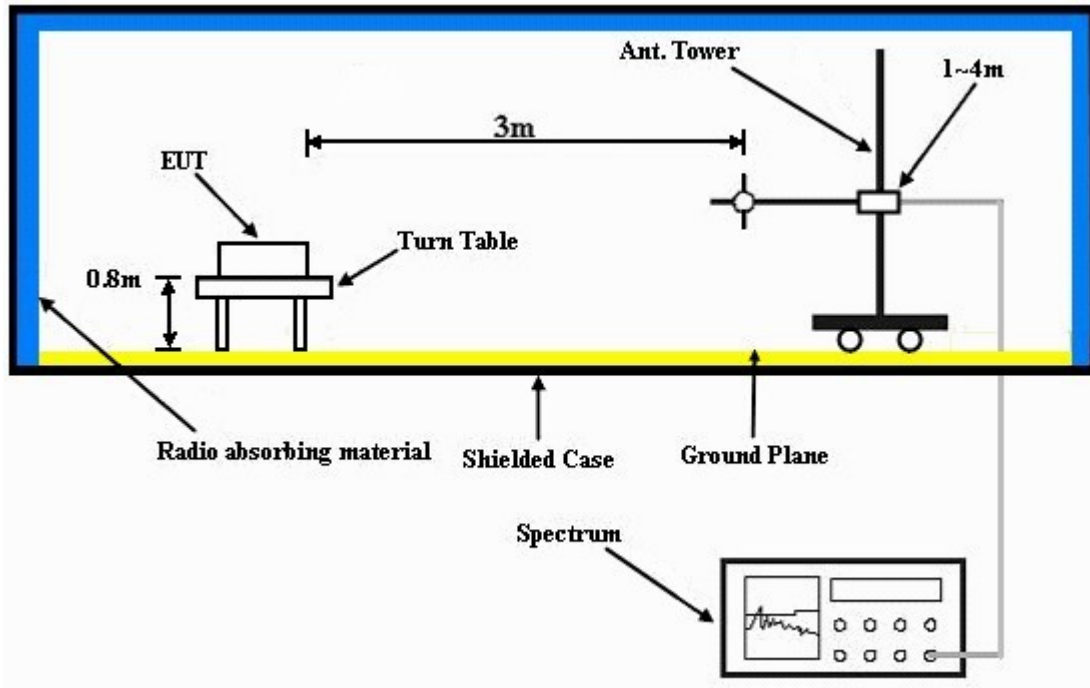

For the actual test configuration, please refer to the attached file (Test Setup Photo).

4.1.6 EUT OPERATING CONDITIONS

- Placed the EUT on a testing table.
- Use the software to control the EUT under transmission condition continuously at specific channel frequency.



A D T

4.1.7 TEST RESULTS

ABOVE 1GHz WORST-CASE DATA : 802.11g

EUT TEST CONDITION		MEASUREMENT DETAIL	
CHANNEL	Channel 1	FREQUENCY RANGE	1 ~ 25GHz
INPUT POWER (SYSTEM)	120Vac, 60Hz	DETECTOR FUNCTION	Peak (PK) Average (AV)
ENVIRONMENTAL CONDITIONS	26deg. C, 69%RH	TESTED BY	Alan Wu

ANTENNA POLARITY & TEST DISTANCE: HORIZONTAL AT 3 M								
NO.	FREQ. (MHz)	EMISSION LEVEL (dBuV/m)	LIMIT (dBuV/m)	MARGIN (dB)	ANTENNA HEIGHT (m)	TABLE ANGLE (Degree)	RAW VALUE (dBuV)	CORRECTION FACTOR (dB/m)
1	2390.00	69.7 PK	74.0	-4.3	1.00 H	345	37.70	32.00
2	2390.00	52.2 AV	54.0	-1.8	1.00 H	345	20.20	32.00
3	*2412.00	101.7 PK			1.48 H	342	69.70	32.00
4	*2412.00	91.1 AV			1.48 H	342	59.10	32.00
5	4824.00	53.7 PK	74.0	-20.3	1.02 H	40	15.30	38.40
6	4824.00	39.3 AV	54.0	-14.7	1.02 H	40	0.90	38.40
ANTENNA POLARITY & TEST DISTANCE: VERTICAL AT 3 M								
NO.	FREQ. (MHz)	EMISSION LEVEL (dBuV/m)	LIMIT (dBuV/m)	MARGIN (dB)	ANTENNA HEIGHT (m)	TABLE ANGLE (Degree)	RAW VALUE (dBuV)	CORRECTION FACTOR (dB/m)
1	2390.00	62.6 PK	74.0	-11.4	1.54 V	31	30.60	32.00
2	2390.00	47.4 AV	54.0	-6.6	1.54 V	31	15.40	32.00
3	*2412.00	99.5 PK			1.51 V	30	67.50	32.00
4	*2412.00	89.2 AV			1.51 V	30	57.20	32.00
5	4824.00	54.1 PK	74.0	-19.9	1.04 V	20	15.70	38.40
6	4824.00	40.2 AV	54.0	-13.8	1.04 V	20	1.80	38.40

REMARKS:

1. Emission level (dBuV/m) = Raw Value (dBuV) + Correction Factor (dB/m).
2. Correction Factor (dB/m) = Antenna Factor (dB/m) + Cable Factor (dB).
3. The other emission levels were very low against the limit.
4. Margin value = Emission level – Limit value.
5. “ * “: Fundamental frequency.



A D T

BELOW 1GHz WORST-CASE DATA : 802.11g

EUT TEST CONDITION		MEASUREMENT DETAIL	
CHANNEL	Channel 1	FREQUENCY RANGE	Below 1000MHz
INPUT POWER (SYSTEM)	120Vac, 60Hz	DETECTOR FUNCTION	Quasi-Peak
ENVIRONMENTAL CONDITIONS	26deg. C, 69%RH	TESTED BY	Alan Wu

ANTENNA POLARITY & TEST DISTANCE: HORIZONTAL AT 3 M								
NO.	FREQ. (MHz)	EMISSION LEVEL (dBuV/m)	LIMIT (dBuV/m)	MARGIN (dB)	ANTENNA HEIGHT (m)	TABLE ANGLE (Degree)	RAW VALUE (dBuV)	CORRECTION FACTOR (dB/m)
1	292.38	33.2 QP	46.0	-12.8	1.24 H	66	17.80	15.40
2	370.15	38.2 QP	46.0	-7.8	1.00 H	90	20.60	17.60
3	409.04	39.0 QP	46.0	-7.0	1.99 H	95	20.30	18.70
4	447.92	41.4 QP	46.0	-4.6	1.74 H	91	21.70	19.70
5	486.81	37.0 QP	46.0	-9.0	1.49 H	101	16.30	20.70
6	702.62	32.9 QP	46.0	-13.1	1.00 H	63	8.50	24.40
ANTENNA POLARITY & TEST DISTANCE: VERTICAL AT 3 M								
NO.	FREQ. (MHz)	EMISSION LEVEL (dBuV/m)	LIMIT (dBuV/m)	MARGIN (dB)	ANTENNA HEIGHT (m)	TABLE ANGLE (Degree)	RAW VALUE (dBuV)	CORRECTION FACTOR (dB/m)
1	45.45	35.8 QP	40.0	-4.2	1.00 V	51	21.80	14.00
2	370.15	39.1 QP	46.0	-6.9	1.24 V	102	21.50	17.60
3	409.04	41.9 QP	46.0	-4.1	1.24 V	117	23.20	18.70
4	447.92	42.5 QP	46.0	-3.5	1.24 V	126	22.80	19.70
5	486.81	40.7 QP	46.0	-5.3	1.00 V	134	20.00	20.70
6	506.25	41.5 QP	46.0	-4.5	1.00 V	160	20.30	21.20

REMARKS:

1. Emission level (dBuV/m) = Raw Value (dBuV) + Correction Factor (dB/m).
2. Correction Factor (dB/m) = Antenna Factor (dB/m) + Cable Factor (dB).
3. The other emission levels were very low against the limit.
4. Margin value = Emission level – Limit value.



A D T

4.2 CONDUCTED EMISSION MEASUREMENT

4.2.1 LIMITS OF CONDUCTED EMISSION MEASUREMENT

FREQUENCY OF EMISSION (MHz)	CONDUCTED LIMIT (dB μ V)	
	Quasi-peak	Average
0.15 ~ 0.5	66 to 56	56 to 46
0.5 ~ 5	56	46
5 ~ 30	60	50

- NOTE:** 1. The lower limit shall apply at the transition frequencies.
2. The limit decreases in line with the logarithm of the frequency in the range of 0.15 to 0.50MHz.
3. All emanations from a class A/B digital device or system, including any network of conductors and apparatus connected thereto, shall not exceed the level of field strengths specified above.

4.2.2 TEST INSTRUMENTS

DESCRIPTION & MANUFACTURER	MODEL NO.	SERIAL NO.	DATE OF CALIBRATION	DUE DATE OF CALIBRATION
Test Receiver ROHDE & SCHWARZ	ESCS30	100291	Nov. 23, 2011	Nov. 22, 2012
RF signal cable Woken	5D-FB	Cable-HYC01-01	Dec. 29, 2011	Dec. 28, 2012
LISN ROHDE & SCHWARZ (Peripheral)	ESH3-Z5	100312	Jul. 02, 2012	Jul. 01, 2013
LISN ROHDE & SCHWARZ (EUT)	ESH3-Z5	835239/001	Feb. 07, 2012	Feb. 06, 2013
Software ADT	BV ADT_Cond_ V7.3.7.3	NA	NA	NA

- NOTE:** 1. The calibration interval of the above test instruments is 12 months and the calibrations are traceable to NML/ROC and NIST/USA.
2. The test was performed in HwaYa Shielded Room 1.
3. The VCCI Site Registration No. is C-2040.

4.2.3 TEST PROCEDURES

- a. The EUT was placed 0.4 meters from the conducting wall of the shielded room with EUT being connected to the power mains through a line impedance stabilization network (LISN). Other support units were connected to the power mains through another LISN. The two LISNs provide 50 ohm/ 50uH of coupling impedance for the measuring instrument.
- b. Both lines of the power mains connected to the EUT were checked for maximum conducted interference.
- c. The frequency range from 150kHz to 30MHz was searched. Emission levels under (Limit - 20dB) was not recorded.

NOTE: All modes of operation were investigated and the worst-case emissions are reported.

4.2.4 DEVIATION FROM TEST STANDARD

No deviation.

4.2.5 TEST SETUP

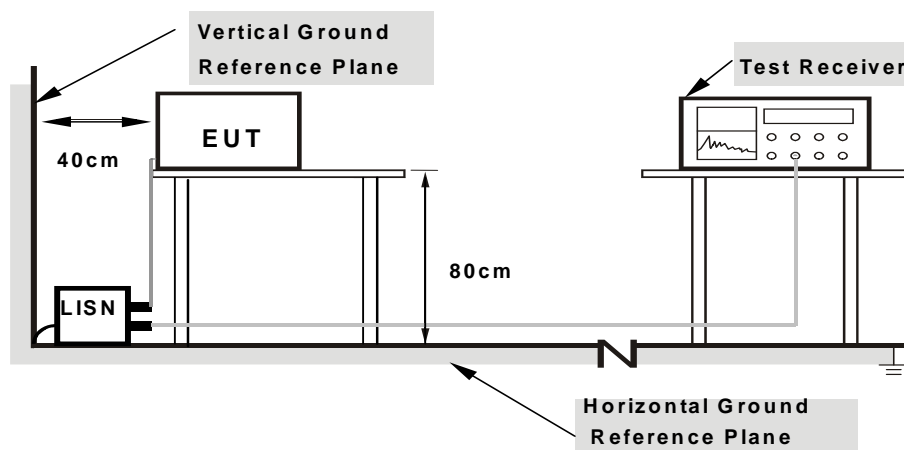

- Note:**
1. Support units were connected to second LISN.
 2. Both of LISNs (AMN) are 80 cm from EUT and at least 80 cm from other units and other metal planes

For the actual test configuration, please refer to the attached file (Test Setup Photo).

4.2.6 EUT OPERATING CONDITIONS

Same as 4.1.6.

4.2.7 TEST RESULTS

CONDUCTED WORST-CASE DATA : 802.11g

PHASE	Line 1	6dB BANDWIDTH	9kHz
--------------	--------	----------------------	------

No	Freq. [MHz]	Corr. Factor (dB)	Reading Value [dB (uV)]		Emission Level [dB (uV)]		Limit [dB (uV)]		Margin (dB)	
			Q.P.	AV.	Q.P.	AV.	Q.P.	AV.	Q.P.	AV.
			1	0.15643	0.15	46.90	31.33	47.05	31.48	65.65
2	0.18906	0.21	43.88	26.90	44.09	27.11	64.08	54.08	-19.99	-26.97
3	0.22031	0.22	40.52	25.45	40.74	25.67	62.81	52.81	-22.06	-27.13
4	0.31797	0.19	37.84	27.36	38.03	27.55	59.76	49.76	-21.73	-22.21
5	0.60897	0.18	29.57	20.73	29.75	20.91	56.00	46.00	-26.25	-25.09
6	5.00000	0.38	28.89	20.50	29.27	20.88	56.00	46.00	-26.73	-25.12

REMARKS:

1. Q.P. and AV. are abbreviations of quasi-peak and average individually.
2. The emission levels of other frequencies were very low against the limit.
3. Margin value = Emission level - Limit value
4. Correction factor = Insertion loss + Cable loss
5. Emission Level = Correction Factor + Reading Value.

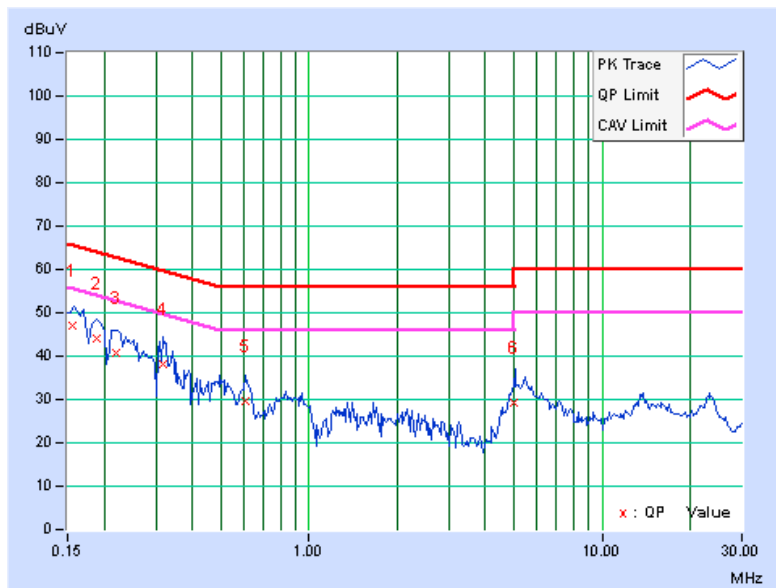

PHASE	Line 2	6dB BANDWIDTH	9kHz
-------	--------	---------------	------

No	Freq. [MHz]	Corr. Factor (dB)	Reading Value		Emission Level		Limit		Margin	
			[dB (uV)]		[dB (uV)]		[dB (uV)]		(dB)	
			Q.P.	AV.	Q.P.	AV.	Q.P.	AV.	Q.P.	AV.
1	0.15781	0.25	46.08	30.06	46.33	30.31	65.58	55.58	-19.25	-25.27
2	0.18516	0.29	42.84	25.14	43.13	25.43	64.25	54.25	-21.12	-28.82
3	0.22277	0.30	40.90	24.21	41.20	24.51	62.72	52.72	-21.51	-28.20
4	0.32200	0.27	37.12	24.45	37.39	24.72	59.66	49.66	-22.26	-24.93
5	0.51719	0.26	30.07	19.01	30.33	19.27	56.00	46.00	-25.67	-26.73
6	5.23438	0.49	29.96	21.95	30.45	22.44	60.00	50.00	-29.55	-27.56

REMARKS:

1. Q.P. and AV. are abbreviations of quasi-peak and average individually.
2. The emission levels of other frequencies were very low against the limit.
3. Margin value = Emission level - Limit value
4. Correction factor = Insertion loss + Cable loss
5. Emission Level = Correction Factor + Reading Value.

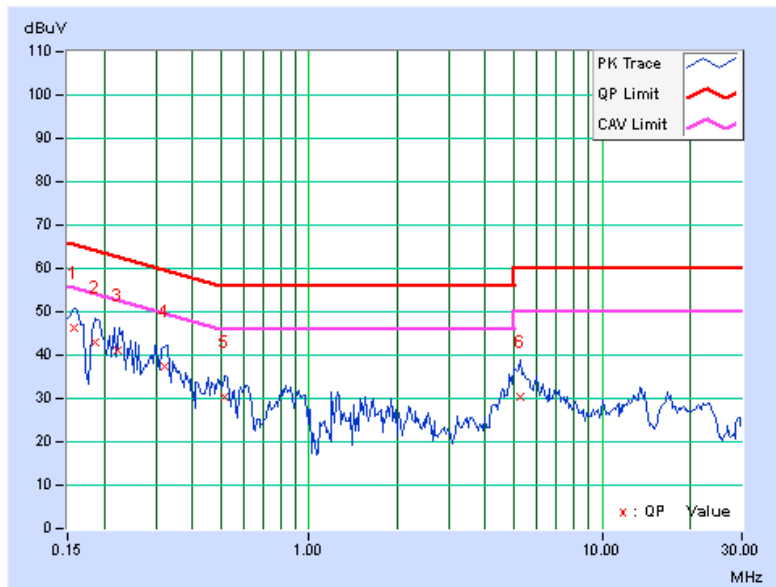



5. TEST TYPES AND RESULTS (FOR 5.0GHz BAND)

5.1 RADIATED EMISSION MEASUREMENT

5.1.1 LIMITS OF RADIATED EMISSION MEASUREMENT

Radiated emissions which fall in the restricted bands must comply with the radiated emission limits specified as below table. Other emissions shall be at least 20dB below the highest level of the desired power:

FREQUENCIES (MHz)	FIELD STRENGTH (microvolts/meter)	MEASUREMENT DISTANCE (meters)
0.009 ~ 0.490	2400/F(kHz)	300
0.490 ~ 1.705	24000/F(kHz)	30
1.705 ~ 30.0	30	30
30 ~ 88	100	3
88 ~ 216	150	3
216 ~ 960	200	3
Above 960	500	3

NOTE:

1. The lower limit shall apply at the transition frequencies.
2. Emission level (dBuV/m) = 20 log Emission level (uV/m).
3. For frequencies above 1000MHz, the field strength limits are based on average detector, however, the peak field strength of any emission shall not exceed the maximum permitted average limits, specified above by more than 20dB under any condition of modulation.



A D T

5.1.2 TEST INSTRUMENTS

DESCRIPTION & MANUFACTURER	MODEL NO.	SERIAL NO.	DATE OF CALIBRATION	DUE DATE OF CALIBRATION
Test Receiver ROHDE & SCHWARZ	ESI7	838496/016	Jan. 03, 2012	Jan. 02, 2013
Spectrum Analyzer ROHDE & SCHWARZ	FSU43	100115	Sep. 05, 2011	Sep. 04, 2012
BILOG Antenna SCHWARZBECK	VULB9168	9168-155	Apr. 06, 2012	Apr. 05, 2013
HORN Antenna SCHWARZBECK	BBHA 9120D	9120D-408	Jan. 05, 2012	Jan. 04, 2013
HORN Antenna SCHWARZBECK	BBHA 9170	148	Jul. 11, 2012	Jul. 10, 2013
Preamplifier Agilent	8449B	3008A01961	Oct. 29, 2011	Oct. 28, 2012
Preamplifier Agilent	8447D	2944A10738	Oct. 29, 2011	Oct. 28, 2012
RF signal cable HUBER+SUHNNER	SUCOFLEX 104	309220/4	Nov. 03, 2011	Nov. 02, 2012
RF signal cable HUBER+SUHNNER	SUCOFLEX 104	250724/4	Nov. 03, 2011	Nov. 02, 2012
RF signal cable HUBER+SUHNNER	SUCOFLEX 104	295012/4	Nov. 03, 2011	Nov. 02, 2012
Software ADT	ADT_Radiated_ V7.6.15.9.2	NA	NA	NA
Antenna Tower inn-co GmbH	MA 4000	010303	NA	NA
Antenna Tower Controller inn-co GmbH	CO2000	019303	NA	NA
Turn Table ADT	TT100.	TT93021704	NA	NA
Turn Table Controller ADT	SC100.	SC93021704	NA	NA
26GHz ~ 40GHz Amplifier	EM26400	815221	Oct. 29, 2011	Oct. 28, 2012

- NOTE:**
1. The calibration interval of the above test instruments is 12 months and the calibrations are traceable to NML/ROC and NIST/USA.
 2. The test was performed in HwaYa Chamber 4.
 3. The horn antenna and HP preamplifier (model: 8449B) are used only for the measurement of emission frequency above 1GHz if tested.
 4. The FCC Site Registration No. is 460141.
 5. The IC Site Registration No. is IC7450F-4.



A D T

5.1.3 TEST PROCEDURES

Same as item 4.1.3.

5.1.4 DEVIATION FROM TEST STANDARD

No deviation.

5.1.5 TEST SETUP

Same as item 4.1.5.

5.1.6 EUT OPERATING CONDITIONS

Same as 4.1.6.



A D T

5.1.7 TEST RESULTS

ABOVE 1GHz WORST-CASE DATA : 802.11a

EUT TEST CONDITION		MEASUREMENT DETAIL	
CHANNEL	Channel 165	FREQUENCY RANGE	1 ~ 40GHz
INPUT POWER (SYSTEM)	120Vac, 60Hz	DETECTOR FUNCTION	Peak (PK) Average (AV)
ENVIRONMENTAL CONDITIONS	26deg. C, 69%RH	TESTED BY	Alan Wu

ANTENNA POLARITY & TEST DISTANCE: HORIZONTAL AT 3 M								
NO.	FREQ. (MHz)	EMISSION LEVEL (dBuV/m)	LIMIT (dBuV/m)	MARGIN (dB)	ANTENNA HEIGHT (m)	TABLE ANGLE (Degree)	RAW VALUE (dBuV)	CORRECTION FACTOR (dB/m)
1	*5825.00	102.0 PK			1.00 H	91	62.30	39.70
2	*5825.00	91.6 AV			1.00 H	91	51.90	39.70
3	#5850.00	53.8 PK	82.0	-28.2	1.00 H	87	14.00	39.80
4	#5850.00	43.4 AV	71.6	-28.2	1.00 H	87	3.60	39.80
5	11650.00	60.1 PK	74.0	-13.9	1.00 H	17	8.50	51.60
6	11650.00	44.6 AV	54.0	-9.4	1.00 H	17	-7.00	51.60
ANTENNA POLARITY & TEST DISTANCE: VERTICAL AT 3 M								
NO.	FREQ. (MHz)	EMISSION LEVEL (dBuV/m)	LIMIT (dBuV/m)	MARGIN (dB)	ANTENNA HEIGHT (m)	TABLE ANGLE (Degree)	RAW VALUE (dBuV)	CORRECTION FACTOR (dB/m)
1	*5825.00	98.0 PK			1.00 V	326	58.30	39.70
2	*5825.00	87.3 AV			1.00 V	326	47.60	39.70
3	#5850.00	53.3 PK	78.0	-24.7	1.00 V	327	13.50	39.80
4	#5850.00	42.6 AV	67.3	-24.7	1.00 V	327	2.80	39.80
5	11650.00	58.7 PK	74.0	-15.3	1.00 V	14	7.10	51.60
6	11650.00	46.2 AV	54.0	-7.8	1.00 V	14	-5.40	51.60

REMARKS:

1. Emission level (dBuV/m) = Raw Value (dBuV) + Correction Factor (dB/m).
2. Correction Factor (dB/m) = Antenna Factor (dB/m) + Cable Factor (dB).
3. The other emission levels were very low against the limit.
4. Margin value = Emission level – Limit value.
5. “ * “: Fundamental frequency.
6. The limit value is defined as per 15.247.
7. “#”:The radiated frequency is out the restricted band.



A D T

BELOW 1GHz WORST-CASE DATA : 802.11a

EUT TEST CONDITION		MEASUREMENT DETAIL	
CHANNEL	Channel 157	FREQUENCY RANGE	Below 1000MHz
INPUT POWER (SYSTEM)	120Vac, 60Hz	DETECTOR FUNCTION	Quasi-Peak
ENVIRONMENTAL CONDITIONS	26deg. C, 69%RH	TESTED BY	Alan Wu

ANTENNA POLARITY & TEST DISTANCE: HORIZONTAL AT 3 M								
NO.	FREQ. (MHz)	EMISSION LEVEL (dBuV/m)	LIMIT (dBuV/m)	MARGIN (dB)	ANTENNA HEIGHT (m)	TABLE ANGLE (Degree)	RAW VALUE (dBuV)	CORRECTION FACTOR (dB/m)
1	331.26	36.1 QP	46.0	-9.9	1.00 H	72	19.50	16.60
2	370.15	40.3 QP	46.0	-5.7	1.00 H	93	22.70	17.60
3	409.04	40.3 QP	46.0	-5.7	1.99 H	93	21.60	18.70
4	447.92	42.4 QP	46.0	-3.6	1.74 H	101	22.70	19.70
5	506.25	37.0 QP	46.0	-9.0	1.49 H	219	15.80	21.20
6	702.62	34.7 QP	46.0	-11.3	1.00 H	124	10.30	24.40

ANTENNA POLARITY & TEST DISTANCE: VERTICAL AT 3 M								
NO.	FREQ. (MHz)	EMISSION LEVEL (dBuV/m)	LIMIT (dBuV/m)	MARGIN (dB)	ANTENNA HEIGHT (m)	TABLE ANGLE (Degree)	RAW VALUE (dBuV)	CORRECTION FACTOR (dB/m)
1	45.45	34.0 QP	40.0	-6.0	1.00 V	57	20.00	14.00
2	370.15	37.7 QP	46.0	-8.3	1.24 V	110	20.10	17.60
3	409.04	41.2 QP	46.0	-4.8	1.24 V	113	22.50	18.70
4	447.92	41.8 QP	46.0	-4.2	1.00 V	127	22.10	19.70
5	486.81	40.4 QP	46.0	-5.6	1.00 V	152	19.70	20.70
6	506.25	41.8 QP	46.0	-4.2	1.00 V	171	20.60	21.20

REMARKS:

1. Emission level (dBuV/m) = Raw Value (dBuV) + Correction Factor (dB/m).
2. Correction Factor (dB/m) = Antenna Factor (dB/m) + Cable Factor (dB).
3. The other emission levels were very low against the limit.
4. Margin value = Emission level – Limit value.



5.2 CONDUCTED EMISSION MEASUREMENT

5.2.1 LIMITS OF CONDUCTED EMISSION MEASUREMENT

FREQUENCY OF EMISSION (MHz)	CONDUCTED LIMIT (dB μ V)	
	Quasi-peak	Average
0.15 ~ 0.5	66 to 56	56 to 46
0.5 ~ 5	56	46
5 ~ 30	60	50

- NOTE:** 1. The lower limit shall apply at the transition frequencies.
2. The limit decreases in line with the logarithm of the frequency in the range of 0.15 to 0.50MHz.
3. All emanations from a class A/B digital device or system, including any network of conductors and apparatus connected thereto, shall not exceed the level of field strengths specified above.

5.2.2 TEST INSTRUMENTS

Same as item 4.2.2.

5.2.3 TEST PROCEDURES

Same as item 4.2.3.

5.2.4 DEVIATION FROM TEST STANDARD

No deviation.

5.2.5 TEST SETUP

Same as item 4.2.5.

5.2.6 EUT OPERATING CONDITIONS

Same as 4.1.6

5.2.7 TEST RESULTS

CONDUCTED WORST-CASE DATA : 802.11a

PHASE	Line 1	6dB BANDWIDTH	9kHz
--------------	--------	----------------------	------

No	Freq. [MHz]	Corr. Factor (dB)	Reading Value		Emission Level		Limit		Margin	
			[dB (uV)]		[dB (uV)]		[dB (uV)]		(dB)	
			Q.P.	AV.	Q.P.	AV.	Q.P.	AV.	Q.P.	AV.
1	0.15763	0.15	44.57	30.14	44.72	30.29	65.59	55.59	-20.87	-25.30
2	0.19299	0.22	41.08	24.41	41.30	24.63	63.91	53.91	-22.61	-29.28
3	0.31797	0.19	37.62	28.98	37.81	29.17	59.76	49.76	-21.95	-20.59
4	0.51328	0.17	30.68	21.61	30.85	21.78	56.00	46.00	-25.15	-24.22
5	0.60703	0.18	29.47	21.81	29.65	21.99	56.00	46.00	-26.35	-24.01
6	5.22266	0.39	29.14	21.26	29.53	21.65	60.00	50.00	-30.47	-28.35

REMARKS:

1. Q.P. and AV. are abbreviations of quasi-peak and average individually.
2. The emission levels of other frequencies were very low against the limit.
3. Margin value = Emission level - Limit value
4. Correction factor = Insertion loss + Cable loss
5. Emission Level = Correction Factor + Reading Value.

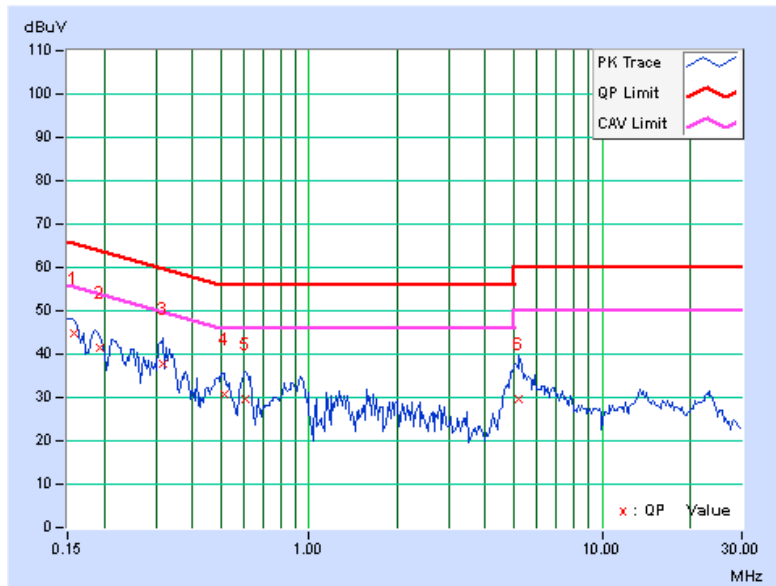

PHASE	Line 2	6dB BANDWIDTH	9kHz
-------	--------	---------------	------

No	Freq. [MHz]	Corr. Factor (dB)	Reading Value		Emission Level		Limit		Margin	
			[dB (uV)]		[dB (uV)]		[dB (uV)]		(dB)	
			Q.P.	AV.	Q.P.	AV.	Q.P.	AV.	Q.P.	AV.
1	0.15781	0.25	45.51	29.84	45.76	30.09	65.58	55.58	-19.82	-25.49
2	0.18888	0.29	42.42	25.90	42.71	26.19	64.09	54.09	-21.37	-27.89
3	0.21749	0.30	40.13	23.96	40.43	24.26	62.91	52.91	-22.48	-28.65
4	0.25156	0.29	37.77	22.05	38.06	22.34	61.71	51.71	-23.64	-29.36
5	0.31406	0.28	36.88	24.84	37.16	25.12	59.86	49.86	-22.71	-24.75
6	5.00000	0.48	30.94	23.89	31.42	24.37	56.00	46.00	-24.58	-21.63

REMARKS:

1. Q.P. and AV. are abbreviations of quasi-peak and average individually.
2. The emission levels of other frequencies were very low against the limit.
3. Margin value = Emission level - Limit value
4. Correction factor = Insertion loss + Cable loss
5. Emission Level = Correction Factor + Reading Value.

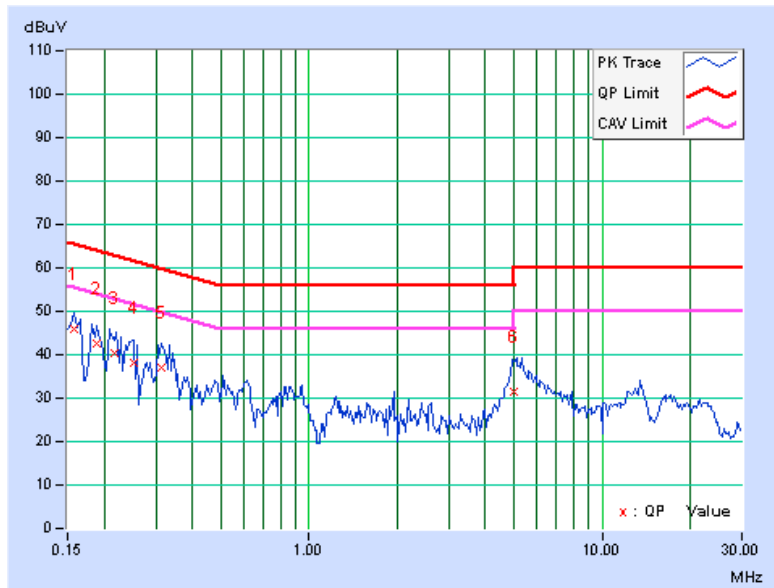



A D T

6. PHOTOGRAPHS OF THE TEST CONFIGURATION

Please refer to the attached file (Test Setup Photo).



A D T

7. INFORMATION ON THE TESTING LABORATORIES

We, Bureau Veritas Consumer Products Services (H.K.) Ltd., Taoyuan Branch, were founded in 1988 to provide our best service in EMC, Radio, Telecom and Safety consultation. Our laboratories are accredited and approved according to ISO/IEC 17025.

If you have any comments, please feel free to contact us at the following:

Linko EMC/RF Lab

Tel: 886-2-26052180

Fax: 886-2-26051924

Hsin Chu EMC/RF Lab

Tel: 886-3-5935343

Fax: 886-3-5935342

Hwa Ya EMC/RF/Safety/Telecom Lab

Tel: 886-3-3183232

Fax: 886-3-3270892

Email: service.adt@tw.bureauveritas.com

Web Site: www.adt.com.tw

The address and road map of all our labs can be found in our web site also.



A D T

8. APPENDIX A - MODIFICATIONS RECORDERS FOR ENGINEERING CHANGES TO THE EUT BY THE LAB

No modifications were made to the EUT by the lab during the test.

---END---