



RADIO TEST REPORT

FCC ID : TLZ-XM646
Equipment : IEEE 802.11 a/b/g/n/ac/ax Wireless LAN 1T1R and BLE/802.15.4 Solution Family 12 x 12 LGA Module
Brand Name : AzureWave
Model Name : AW-XM646G-SUR,AW-XM646G-USB,AW-XM646F-SUR,AW-XM646F-USB,AW-XM646C-SUR,AW-XM646C-USB,AW-XM646B-SUR,AW-XM646B-USB
Applicant : AzureWave Technologies, Inc.
8F., No.94, Baozhong Rd. , Xindian Dist., New Taipei City , Taiwan 231
Manufacturer : AzureWave Technologies, Inc.
8F., No.94, Baozhong Rd. , Xindian Dist., New Taipei City , Taiwan 231
Standard : 47 CFR FCC Part 15.247

The product was received on Feb. 21, 2025, and testing was started from Mar. 21, 2025 and completed on Apr. 07, 2025. We, Sporton International Inc. Hsinchu Laboratory, would like to declare that the tested sample has been evaluated in accordance with the procedures given in ANSI C63.10-2013 and shown compliance with the applicable technical standards.

The test results in this report apply exclusively to the tested model / sample. Without written approval of Sporton International Inc. Hsinchu Laboratory, the test report shall not be reproduced except in full.

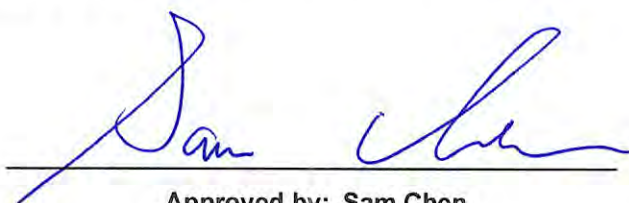

Approved by: Sam Chen

Sporton International Inc. Hsinchu Laboratory
No.8, Ln. 724, Bo'ai St., Zhubei City, Hsinchu County 302010, Taiwan (R.O.C.)



Table of Contents

History of this test report.....3

Summary of Test Result.....4

1 General Description5

1.1 Information.....5

1.2 Applicable Standards8

1.3 Testing Location Information8

1.4 Measurement Uncertainty9

2 Test Configuration of EUT10

2.1 Test Channel Mode10

2.2 The Worst Case Measurement Configuration10

2.3 EUT Operation during Test12

2.4 Accessories12

2.5 Support Equipment.....12

2.6 Test Setup Diagram14

3 Transmitter Test Result17

3.1 AC Power-line Conducted Emissions17

3.2 DTS Bandwidth.....19

3.3 Maximum Conducted Output Power20

3.4 Power Spectral Density23

3.5 Emissions in Non-restricted Frequency Bands25

3.6 Emissions in Restricted Frequency Bands.....26

4 Test Equipment and Calibration Data30

Appendix A. Test Results of AC Power-line Conducted Emissions

Appendix B. Test Results of DTS Bandwidth

Appendix C. Test Results of Maximum Conducted Output Power

Appendix D. Test Results of Power Spectral Density

Appendix E. Test Results of Emissions in Non-restricted Frequency Bands

Appendix F. Test Results of Emissions in Restricted Frequency Bands

Appendix G. Test Photos

Photographs of EUT v01



History of this test report

| Report No. | Version | Description | Issued Date |
|------------|---------|-------------------------|---------------|
| FR521124AB | 01 | Initial issue of report | Apr. 16, 2025 |
| | | | |
| | | | |
| | | | |
| | | | |
| | | | |
| | | | |
| | | | |
| | | | |
| | | | |
| | | | |
| | | | |
| | | | |
| | | | |
| | | | |
| | | | |
| | | | |
| | | | |
| | | | |
| | | | |
| | | | |
| | | | |
| | | | |
| | | | |
| | | | |
| | | | |
| | | | |
| | | | |
| | | | |
| | | | |
| | | | |
| | | | |
| | | | |
| | | | |
| | | | |
| | | | |
| | | | |
| | | | |
| | | | |
| | | | |
| | | | |



Summary of Test Result

| Report Clause | Ref Std. Clause | Test Items | Result (PASS/FAIL) | Remark |
|---------------|-----------------|---|--------------------|--------|
| 1.1.2 | 15.203 | Antenna Requirement | PASS | - |
| 3.1 | 15.207 | AC Power-line Conducted Emissions | PASS | - |
| 3.2 | 15.247(a) | DTS Bandwidth | PASS | - |
| 3.3 | 15.247(b) | Maximum Conducted Output Power | PASS | - |
| 3.4 | 15.247(e) | Power Spectral Density | PASS | - |
| 3.5 | 15.247(d) | Emissions in Non-restricted Frequency Bands | PASS | - |
| 3.6 | 15.247(d) | Emissions in Restricted Frequency Bands | PASS | - |

Conformity Assessment Condition:

1. The test results (PASS/FAIL) with all measurement uncertainty excluded are presented against the regulation limits or in accordance with the requirements stipulated by the applicant/manufacture who shall bear all the risks of non-compliance that may potentially occur if measurement uncertainty is taken into account.
2. The measurement uncertainty please refer to each test result in the chapter "Measurement Uncertainty".

Disclaimer:

The product specifications of the EUT presented in the test report that may affect the test assessments are declared by the manufacturer who shall take full responsibility for the authenticity.

Reviewed by: **Sam Chen**

Report Producer: **Wendy Pan**



1 General Description

1.1 Information

1.1.1 RF General Information

| Frequency Range (MHz) | IEEE Std. | Ch. Frequency (MHz) | Channel Number |
|-----------------------|-----------|---------------------|----------------|
| 2400-2483.5 | 802.15.4 | 2405-2480 | 11-26 [16] |

| Band | Mode | BWch (MHz) | Nant |
|------|--------|------------|------|
| 2.4G | Thread | 3 | 1 |

Note:

- ♦ Thread uses a O-QPSK (250kbps) modulation.
- ♦ BWch is the nominal channel bandwidth.



1.1.2 Antenna Information

| Ant. | Port | Brand | Model Name | Antenna Type | Connector | Gain (dBi) | |
|------|------|-----------|--------------------------|--------------|-----------|-----------------------------------|-----------|
| | | | | | | WLAN 2.4GHz, Bluetooth and Thread | WLAN 5GHz |
| 1 | 1 | ARISTOTLE | RFA-27- JP326MHF4C198 | PIFA Antenna | I-PEX | 3.5 | 5 |

Note 2: The above information was declared by manufacturer.

Note 3: **For 2.4GHz function:**

For IEEE 802.11 b/g/n/VHT/ax (1TX/1RX):

Only Port 1 can be used as transmitting/receiving antenna.

For 5GHz function:

For IEEE 802.11a/n/ac/ax (1TX/1RX):

Only Port 1 can be used as transmitting/receiving antenna.

For Bluetooth/Thread function (1TX/1RX):

Only Port 1 can be used as transmitting/receiving antenna.

1.1.3 Mode Test Duty Cycle

| Mode | DC | DCF (dB) | T (s) | VBW (Hz)_1/T |
|--------------|----|----------|----------|-----------------|
| Thread_Nss 1 | 1 | 0 | 100.003m | 10Hz (DC>=0.98) |

Note:

- ◆ DC is Duty Cycle.
- ◆ DCF is Duty Cycle Factor.



1.1.4 EUT Operational Condition

| | | | |
|------------------------------|---|---|--|
| EUT Power Type | From host system | | |
| Function | <input checked="" type="checkbox"/> Point-to-multipoint | <input type="checkbox"/> Point-to-point | |
| Test Software Version | labtool 2.0.0.22 | | |

Note: The above information was declared by manufacturer.

1.1.5 Table for Multiple Listing

The difference for each model is shown as below:

| EUT | Model Name | WLAN 2.4G | WLAN 5G | Bluetooth | 802.15.4 | Interface |
|--|-------------------|------------------|----------------|------------------|-----------------|------------------|
| 1 | AW-XM646G-SUR | V | V | V | V | SUR |
| 2 | AW-XM646G-USB | V | V | V | V | USB |
| - | AW-XM646F-SUR | V | V | V | X | SUR |
| - | AW-XM646F-USB | V | V | V | X | USB |
| - | AW-XM646C-SUR | V | X | V | V | SUR |
| - | AW-XM646C-USB | V | X | V | V | USB |
| - | AW-XM646B-SUR | V | X | V | X | SUR |
| - | AW-XM646B-USB | V | X | V | X | USB |
| Description | | | | | | |
| In addition to the differences mentioned above, there are differences in marketing strategy. | | | | | | |

Note 1: From the above EUT, EUT 1 and 2 were selected as representative model for the test and its data was recorded in this report.

Note 2: The above information was declared by manufacturer.



1.2 Applicable Standards

According to the specifications of the manufacturer, the EUT must comply with the requirements of the following standards:

- ◆ 47 CFR FCC Part 15.247
- ◆ ANSI C63.10-2013

The following reference test guidance is not within the scope of accreditation of TAF.

- ◆ FCC KDB 558074 D01 v05r02
- ◆ FCC KDB 414788 D01 v01r01

1.3 Testing Location Information

| Testing Location Information | |
|---|--|
| Test Lab. : Sporton International Inc. Hsinchu Laboratory | |
| Hsinchu | ADD: No.8, Ln. 724, Bo'ai St., Zhubei City, Hsinchu County 302010, Taiwan (R.O.C.) |
| (TAF: 3787) | TEL: 886-3-656-9065 FAX: 886-3-656-9085 |
| Test site Designation No. TW3787 with FCC. | |
| Conformity Assessment Body Identifier (CABID) TW3787 with ISED. | |

| Test Condition | Test Site No. | Test Engineer | Test Environment (°C / %) | Test Date |
|---------------------|---------------|---------------|---------------------------|---------------------------------|
| RF Conducted | TH01-CB | Mason Chen | 21.2~22.6 / 58~61 | Mar. 24, 2025~ Mar. 29, 2025 |
| Radiated below 1GHz | 03CH06-CB | Eason Chen | 21.9~23.1 / 60~62 | Mar. 21, 2025~ Mar. 29, 2025 |
| Radiated above 1GHz | 03CH03-CB | Eason Chen | 21.6~23.1 / 58~62 | Mar. 21, 2025~ Mar. 29, 2025 |
| | 03CH01-CB | Eason Chen | 21.3~22.3 / 58~61 | Mar. 21, 2025~ Mar. 29, 2025 |
| AC Conduction | CO02-CB | Joe Chu | 23~24 / 50~51 | Apr. 07, 2025 |



1.4 Measurement Uncertainty

ISO/IEC 17025 requires that an estimate of the measurement uncertainties associated with the emissions test results be included in the report. The measurement uncertainties given below are based on a 95% confidence level (based on a coverage factor (k=2))

ISO/IEC 17025 requires that an estimate of the measurement uncertainties associated with the emissions test results be included in the report. The measurement uncertainties given below are based on a 95% confidence level (based on a coverage factor (k=2))

| Test Items | Uncertainty | Remark |
|--------------------------------------|-------------|--------------------------|
| Conducted Emission (150kHz ~ 30MHz) | 3.8 dB | Confidence levels of 95% |
| Radiated Emission (9kHz ~ 30MHz) | 4.1 dB | Confidence levels of 95% |
| Radiated Emission (30MHz ~ 1,000MHz) | 4.2 dB | Confidence levels of 95% |
| Radiated Emission (1GHz ~ 18GHz) | 4.2 dB | Confidence levels of 95% |
| Radiated Emission (18GHz ~ 40GHz) | 4.0 dB | Confidence levels of 95% |
| Conducted Emission | 3.1 dB | Confidence levels of 95% |
| Output Power Measurement | 0.8 dB | Confidence levels of 95% |
| Power Density Measurement | 3.1 dB | Confidence levels of 95% |
| Bandwidth Measurement | 2.1 % | Confidence levels of 95% |



2 Test Configuration of EUT

2.1 Test Channel Mode

| Mode | Power Setting |
|----------------------|---------------|
| Thread_3MHz_Nss1_1TX | - |
| 2405MHz | 6 |
| 2440MHz | 6 |
| 2475MHz | 6 |
| 2480MHz | 0 |

2.2 The Worst Case Measurement Configuration

| The Worst Case Mode for Following Conformance Tests | |
|---|---|
| Tests Item | AC power-line conducted emissions |
| Condition | AC power-line conducted measurement for line and neutral Test Voltage: 120Vac / 60Hz |
| Operating Mode | CTX |
| 1 | EUT 1 + Bluetooth |
| 2 | EUT 2 + Bluetooth |
| Mode 1 has been evaluated to be the worst case among Mode 1~2, thus measurement for Mode 3 ~ 5 will follow this same test mode. | |
| 3 | EUT 1 + WLAN 2.4GHz |
| 4 | EUT 1 + Thread |
| 5 | EUT 1 + WLAN 5GHz |
| For operating mode 4 is the worst case and it was record in this test report. | |

| The Worst Case Mode for Following Conformance Tests | |
|--|--|
| Tests Item | DTS Bandwidth Maximum Conducted Output Power Power Spectral Density Emissions in Non-restricted Frequency Bands |
| Test Condition | Conducted measurement at transmit chains |
| The EUT was performed at EUT 1 and EUT 2 for Radiated emission above 1GHz test, and the worst case was found as EUT 1. Thus, the measurement will follow this same test configuration. | |
| 1 | EUT 1 |



| The Worst Case Mode for Following Conformance Tests | |
|---|---|
| Tests Item | Emissions in Restricted Frequency Bands |
| Test Condition | Radiated measurement If EUT consist of multiple antenna assembly (multiple antenna are used in EUT regardless of spatial multiplexing MIMO configuration), the radiated test should be performed with highest antenna gain of each antenna type. |
| Operating Mode < 1GHz | CTX |
| | The EUT was performed at X axis, Y axis and Z axis position for Radiated emission above 1GHz test, and the worst case was found as below. Thus, the measurement will follow this same test configuration. |
| 1 | EUT 1 in X axis + WLAN 2.4GHz |
| 2 | EUT 2 in X axis + WLAN 2.4GHz |
| Mode 1 has been evaluated to be the worst case among Mode 1~2, thus measurement for Mode 3 ~ 5 will follow this same test mode. | |
| 3 | EUT 1 in X axis + Bluetooth |
| 4 | EUT 1 in Z axis + WLAN 5GHz |
| 5 | EUT 1 in Z axis + Thread |
| For operating mode 1 is the worst case and it was record in this test report. | |
| Operating Mode > 1GHz | CTX |
| | <ol style="list-style-type: none"> The EUT was performed at X axis, Y axis and Z axis position the worst case was found as below. Thus, the measurement will follow this same test configuration. The EUT 1 and EUT 2 performed the testing, and the worst case was found in EUT 1. Thus, the measurement will follow this same test configuration. |
| 1 | EUT 1 in Z axis |

| The Worst Case Mode for Following Conformance Tests | |
|--|---|
| Tests Item | Simultaneous Transmission Analysis - Co-location RF Exposure Evaluation |
| Operating Mode | |
| 1 | Bluetooth + WLAN 2.4GHz |
| 2 | Bluetooth + WLAN 5GHz |
| Refer to Sporton Test Report No.: FA521124 for Co-location RF Exposure Evaluation. | |



2.3 EUT Operation during Test

For Normal Link:

During the test, the EUT operation to normal function.

For CTX Mode:

The EUT was programmed to be in continuously transmitting mode.

2.4 Accessories

N/A

2.5 Support Equipment

For AC Conduction:

| Support Equipment | | | | |
|-------------------|----------------|------------|------------|--------|
| No. | Equipment | Brand Name | Model Name | FCC ID |
| A | EUT Fixture | Azurewave | 2460-i4 | N/A |
| B | Thread Fixture | Azurewave | 3510 | N/A |
| C | NB | DELL | E6430 | N/A |
| D | Earphone | e-Power | GT02 | N/A |
| E | Mouse | acer | MOBVUO | N/A |
| F | NB | DELL | E6430 | N/A |
| G | USB HUB | INTOPIC | HB-16 | N/A |

For RF Conducted:

| Support Equipment | | | | |
|-------------------|----------------|------------|------------|--------|
| No. | Equipment | Brand Name | Model Name | FCC ID |
| A | Notebook | DELL | E4300 | N/A |
| B | Thread Fixture | AzureWave | 3510 | N/A |
| C | EUT Fixture | Azurewave | 2460-i4 | N/A |



For Radiated below 1GHz:

| Support Equipment | | | | |
|--------------------------|------------------------|-------------------|-------------------|---------------|
| No. | Equipment | Brand Name | Model Name | FCC ID |
| A | Notebook | DELL | E4300 | N/A |
| B | WLAN/Bluetooth Fixture | AzureWave | 2460-i6 | N/A |
| C | EUT Fixture | Azurewave | 2460-i4 | N/A |

For Radiated above 1GHz:

| Support Equipment | | | | |
|--------------------------|------------------|-------------------|-------------------|---------------|
| No. | Equipment | Brand Name | Model Name | FCC ID |
| A | Notebook | DELL | E4300 | N/A |
| B | Thread Fixture | AzureWave | 3510 | N/A |
| C | EUT Fixture | AzureWave | 2646-i4 | N/A |
| D | Notebook | DELL | E4300 | N/A |

2.6 Test Setup Diagram

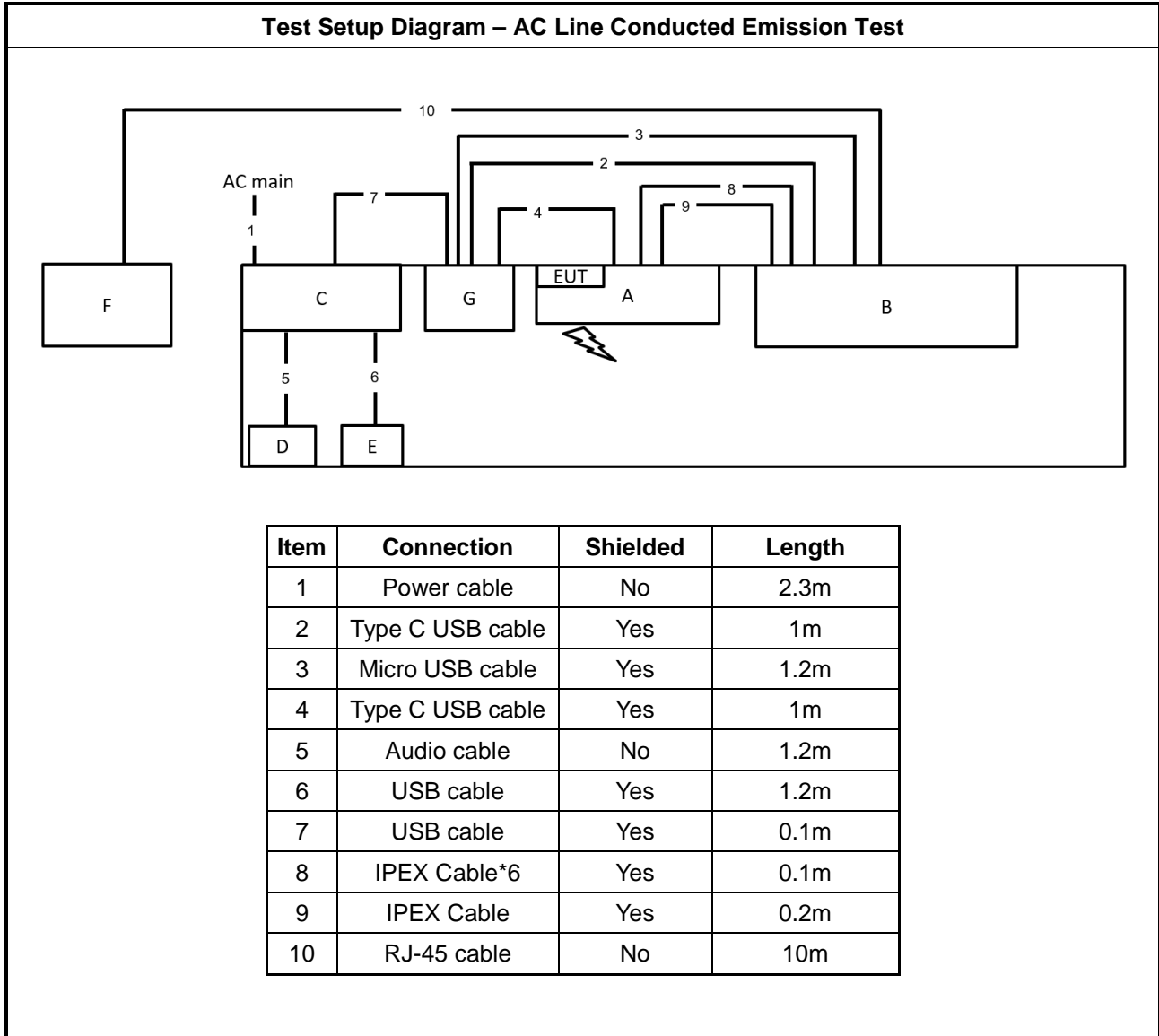

Test Setup Diagram - Radiated < 1GHz Test

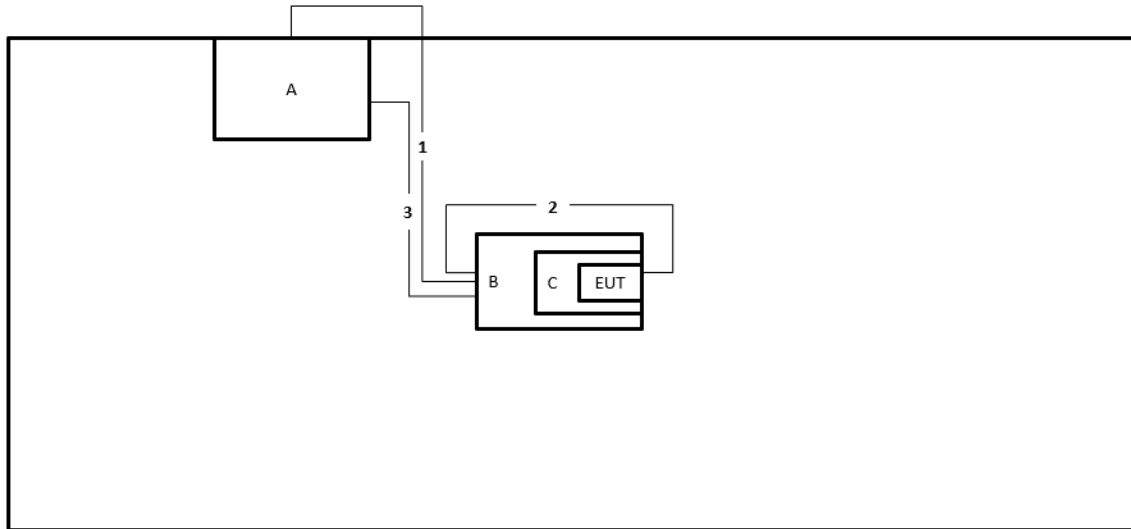

| Item | Connection | Shielded | Length |
|------|------------------|----------|--------|
| 1 | RJ-45 cable | No | 1m |
| 2 | Type-C USB cable | Yes | 1m |
| 3 | Type-C USB cable | Yes | 1m |

Test Setup Diagram - Radiated > 1GHz Test

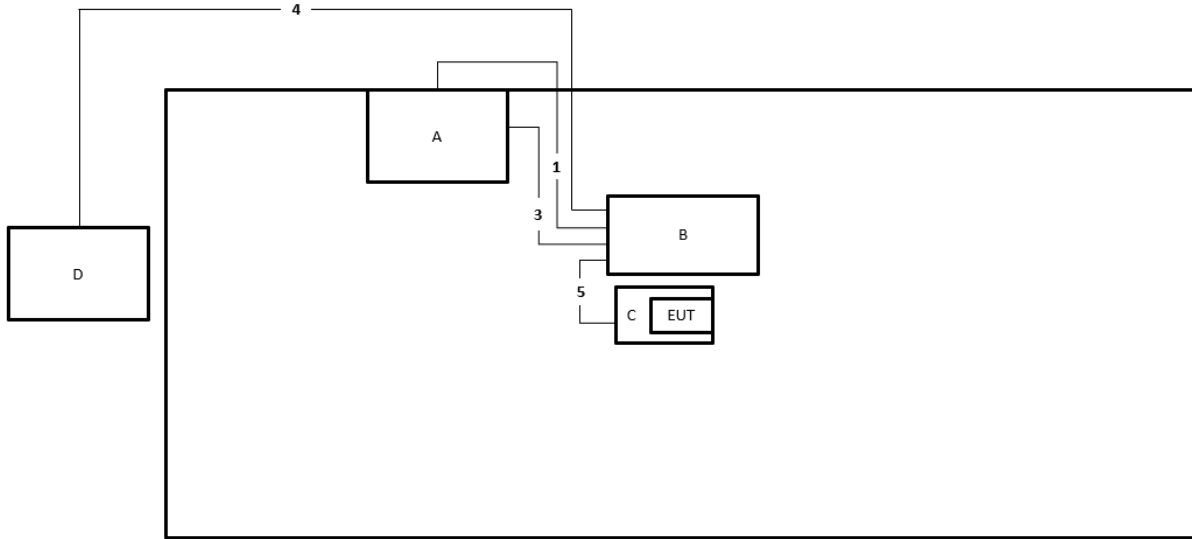

| Item | Connection | Shielded | Length |
|------|------------------|----------|--------|
| 1 | Micro USB cable | Yes | 1m |
| 2 | Type-C USB cable | Yes | 1m |
| 3 | Type-C USB cable | Yes | 1m |
| 4 | RJ-45 cable | No | 10m |
| 5 | IPEX Cable*6 | Yes | 0.1m |



3 Transmitter Test Result

3.1 AC Power-line Conducted Emissions

3.1.1 AC Power-line Conducted Emissions Limit

| AC Power-line Conducted Emissions Limit | | |
|---|------------|-----------|
| Frequency Emission (MHz) | Quasi-Peak | Average |
| 0.15-0.5 | 66 - 56 * | 56 - 46 * |
| 0.5-5 | 56 | 46 |
| 5-30 | 60 | 50 |

Note 1: * Decreases with the logarithm of the frequency.

3.1.2 Measuring Instruments

Refer a test equipment and calibration data table in this test report.

3.1.3 Test Procedures

| Test Method |
|--|
| <input checked="" type="checkbox"/> Refer as ANSI C63.10-2013, clause 6.2 for AC power-line conducted emissions. |

3.1.4 Test Setup

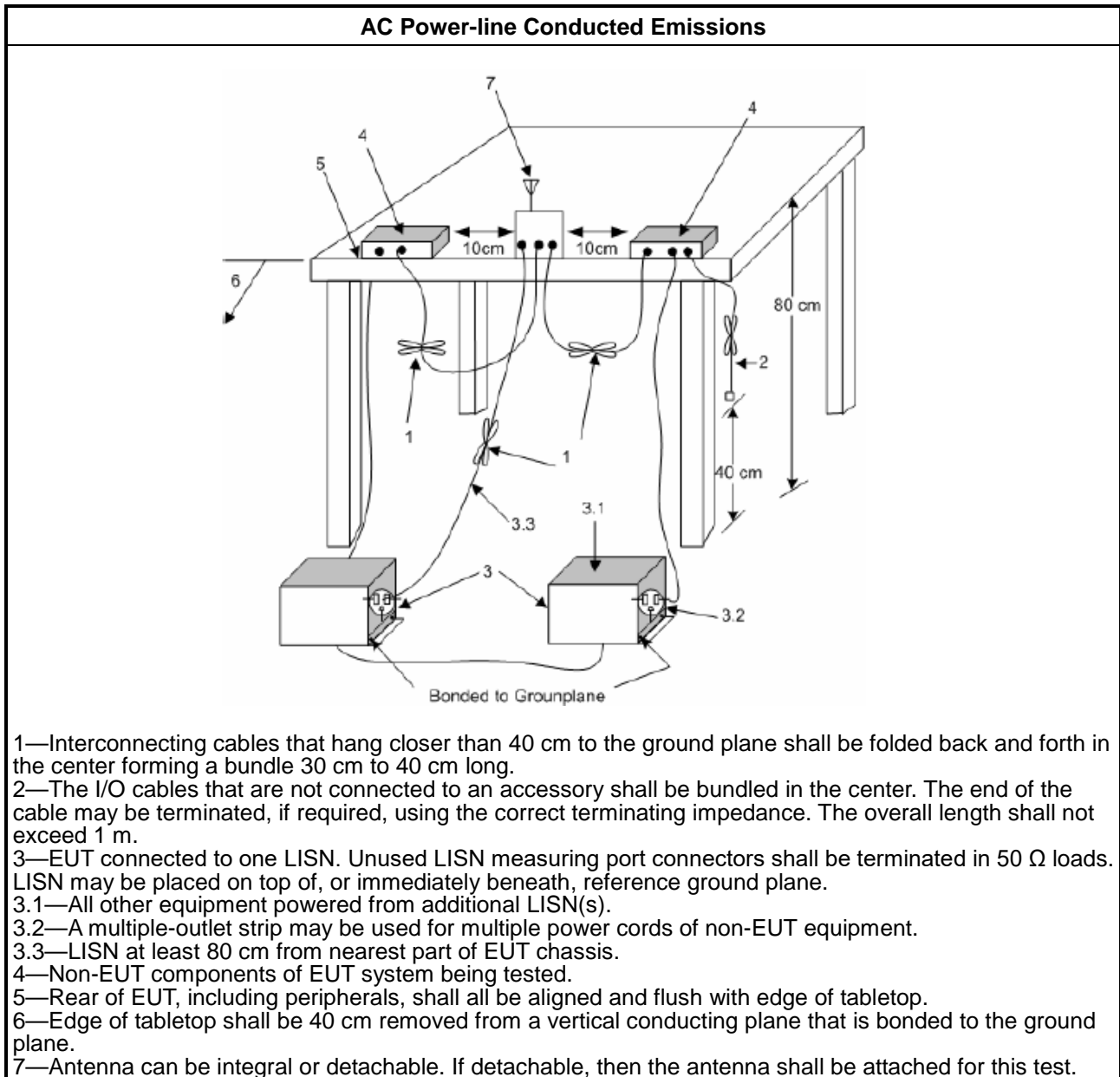

3.1.5 Measurement Results Calculation

The measured Level is calculated using:

- a. Corrected Reading: LISN Factor (LISN) + Attenuator (AT/AUX) + Cable Loss (CL) + Read Level (Raw) = Level
- b. Margin = -Limit + Level

3.1.6 Test Result of AC Power-line Conducted Emissions

Refer as Appendix A

3.2 DTS Bandwidth

3.2.1 6dB Bandwidth Limit

| 6dB Bandwidth Limit |
|---|
| Systems using digital modulation techniques: |
| <ul style="list-style-type: none"> ▪ 6 dB bandwidth \geq 500 kHz. |

3.2.2 Measuring Instruments

Refer a test equipment and calibration data table in this test report.

3.2.3 Test Procedures

| Test Method |
|---|
| <ul style="list-style-type: none"> ▪ For the emission bandwidth shall be measured using one of the options below: |
| <input checked="" type="checkbox"/> Refer as FCC KDB 558074, clause 8.2 & C63.10 clause 11.8.1 Option 1 for 6 dB bandwidth measurement. |
| <input type="checkbox"/> Refer as FCC KDB 558074, clause 8.2 & C63.10 clause 11.8.2 Option 2 for 6 dB bandwidth measurement. |
| <input type="checkbox"/> Refer as ANSI C63.10, clause 6.9.1 for occupied bandwidth testing. |

3.2.4 Test Setup

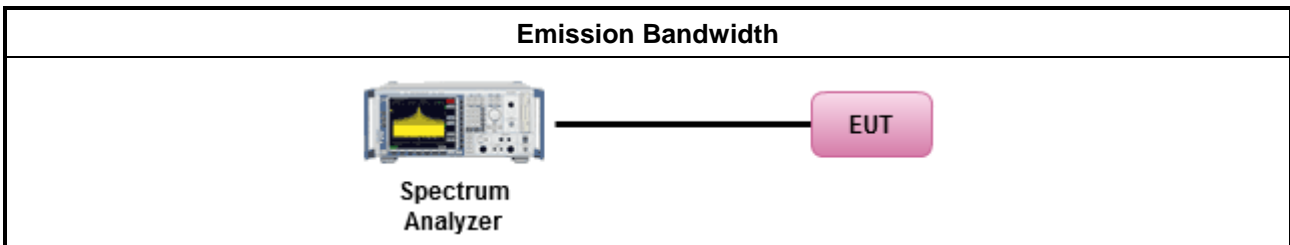

3.2.5 Test Result of Emission Bandwidth

Refer as Appendix B



3.3 Maximum Conducted Output Power

3.3.1 Maximum Conducted Output Power Limit

| Maximum Conducted Output Power Limit | |
|--|---|
| | <ul style="list-style-type: none"> ▪ If $G_{TX} \leq 6$ dBi, then $P_{Out} \leq 30$ dBm (1 W) |
| | <ul style="list-style-type: none"> ▪ Point-to-multipoint systems (P2M): If $G_{TX} > 6$ dBi, then $P_{Out} = 30 - (G_{TX} - 6)$ dBm |
| | <ul style="list-style-type: none"> ▪ Point-to-point systems (P2P): If $G_{TX} > 6$ dBi, then $P_{Out} = 30 - (G_{TX} - 6)/3$ dBm |
| | <ul style="list-style-type: none"> ▪ Smart antenna system (SAS): |
| | <ul style="list-style-type: none"> - Single beam: If $G_{TX} > 6$ dBi, then $P_{Out} = 30 - (G_{TX} - 6)/3$ dBm |
| | <ul style="list-style-type: none"> - Overlap beam: If $G_{TX} > 6$ dBi, then $P_{Out} = 30 - (G_{TX} - 6)/3$ dBm |
| | <ul style="list-style-type: none"> - Aggregate power on all beams: If $G_{TX} > 6$ dBi, then $P_{Out} = 30 - (G_{TX} - 6)/3 + 8$ dB dBm |
| <p>P_{Out} = maximum peak conducted output power or maximum conducted output power in dBm, G_{TX} = the maximum transmitting antenna directional gain in dBi.</p> | |

3.3.2 Measuring Instruments

Refer a test equipment and calibration data table in this test report.



3.3.3 Test Procedures

| Test Method | |
|---|--|
| <ul style="list-style-type: none"> ▪ Maximum Peak Conducted Output Power | |
| | <input type="checkbox"/> Refer as FCC KDB 558074, clause 8.3.1.1 & C63.10 clause 11.9.1.1 (RBW ≥ EBW method). |
| | <input type="checkbox"/> Refer as FCC KDB 558074, clause 8.3.1.3 & C63.10 clause 11.9.1.3 (peak power meter). |
| <ul style="list-style-type: none"> ▪ Maximum Conducted Output Power | |
| [duty cycle ≥ 98% or external video / power trigger] | |
| | <input type="checkbox"/> Refer as FCC KDB 558074, clause 8.3.2.2 & C63.10 clause 11.9.2.2.2 Method AVGSA-1. |
| | <input type="checkbox"/> Refer as FCC KDB 558074, clause 8.3.2.2 & C63.10 clause 11.9.2.2.3 Method AVGSA-1A. (alternative) |
| duty cycle < 98% and average over on/off periods with duty factor | |
| | <input type="checkbox"/> Refer as FCC KDB 558074, clause 8.3.2.2 & C63.10 clause 11.9.2.2.4 Method AVGSA-2. |
| | <input type="checkbox"/> Refer as FCC KDB 558074, clause 8.3.2.2 & C63.10 clause 11.9.2.2.5 Method AVGSA-2A (alternative) |
| | <input type="checkbox"/> Refer as FCC KDB 558074, clause 8.3.2.2 & C63.10 clause 11.9.2.2.6 Method AVGSA-3 |
| | <input type="checkbox"/> Refer as FCC KDB 558074, clause 8.3.2.2 & C63.10 clause 11.9.2.2.7 Method AVGSA-3A (alternative) |
| Measurement using a power meter (PM) | |
| | <input type="checkbox"/> Refer as FCC KDB 558074, clause 8.3.2.3 & C63.10 clause 11.9.2.3.1 Method AVGPM (using an RF average power meter). |
| | <input checked="" type="checkbox"/> Refer as FCC KDB 558074, clause 8.3.2.3 & C63.10 clause 11.9.2.3.2 Method AVGPM-G (using an gate RF average power meter). |
| <ul style="list-style-type: none"> ▪ For conducted measurement. | |
| | <ul style="list-style-type: none"> ▪ If the EUT supports multiple transmit chains using options given below: Refer as FCC KDB 662911, In-band power measurements. Using the measure-and-sum approach, measured all transmit ports individually. Sum the power (in linear power units e.g., mW) of all ports for each individual sample and save them. |
| | <ul style="list-style-type: none"> ▪ If multiple transmit chains, EIRP calculation could be following as methods: $P_{total} = P_1 + P_2 + \dots + P_n$ (calculated in linear unit [mW] and transfer to log unit [dBm]) $EIRP_{total} = P_{total} + DG$ |

3.3.4 Test Setup

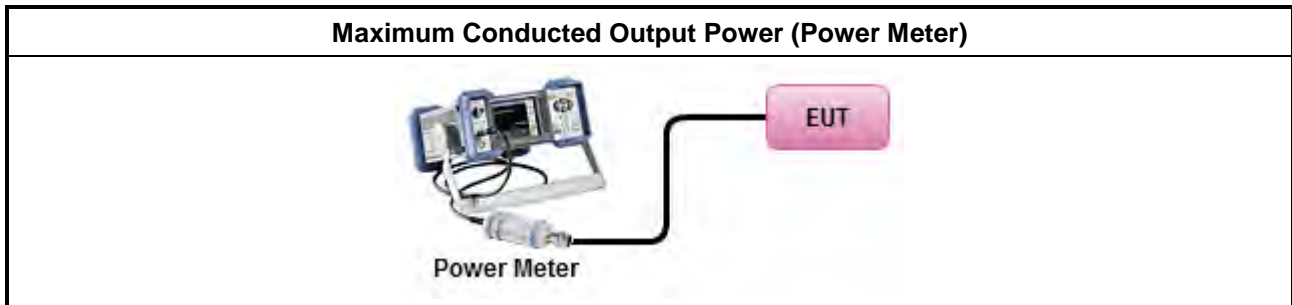

3.3.5 Test Result of Maximum Conducted Output Power

Refer as Appendix C



3.4 Power Spectral Density

3.4.1 Power Spectral Density Limit

| Power Spectral Density Limit |
|---|
| <ul style="list-style-type: none"> Power Spectral Density (PSD) \leq 8 dBm/3kHz |

3.4.2 Measuring Instruments

Refer a test equipment and calibration data table in this test report.

3.4.3 Test Procedures

| Test Method |
|---|
| <ul style="list-style-type: none"> Peak power spectral density procedures that the same method as used to determine the conducted output power. If maximum peak conducted output power was measured to demonstrate compliance to the output power limit, then the peak PSD procedure below (Method PKPSD) shall be used. If maximum conducted output power was measured to demonstrate compliance to the output power limit, then one of the average PSD procedures shall be used, as applicable based on the following criteria (the peak PSD procedure is also an acceptable option). |
| <input checked="" type="checkbox"/> Refer as FCC KDB 558074, clause 8.4 & C63.10 clause 11.10 Method Max. PSD. |
| <ul style="list-style-type: none"> For conducted measurement. <ul style="list-style-type: none"> If The EUT supports multiple transmit chains using options given below: <ul style="list-style-type: none"> <input type="checkbox"/> Option 1: Measure and sum the spectra across the outputs. Refer as FCC KDB 662911, In-band power spectral density (PSD). Sample all transmit ports simultaneously using a spectrum analyzer for each transmit port. Where the trace bin-by-bin of each transmit port summing can be performed. (i.e., in the first spectral bin of output 1 is summed with that in the first spectral bin of output 2 and that from the first spectral bin of output 3, and so on up to the NTX output to obtain the value for the first frequency bin of the summed spectrum.). Add up the amplitude (power) values for the different transmit chains and use this as the new data trace. <input type="checkbox"/> Option 2: Measure and sum spectral maxima across the outputs. With this technique, spectra are measured at each output of the device at the required resolution bandwidth. The maximum value (peak) of each spectrum is determined. These maximum values are then summed mathematically in linear power units across the outputs. These operations shall be performed separately over frequency spans that have different out-of-band or spurious emission limits, <input type="checkbox"/> Option 3: Measure and add 10 log(N) dB, where N is the number of transmit chains. Refer as FCC KDB 662911, In-band power spectral density (PSD). Performed at each transmit chains and each transmit chains shall be compared with the limit have been reduced with 10 log(N). Or each transmit chains shall be add 10 log(N) to compared with the limit. |

3.4.4 Test Setup

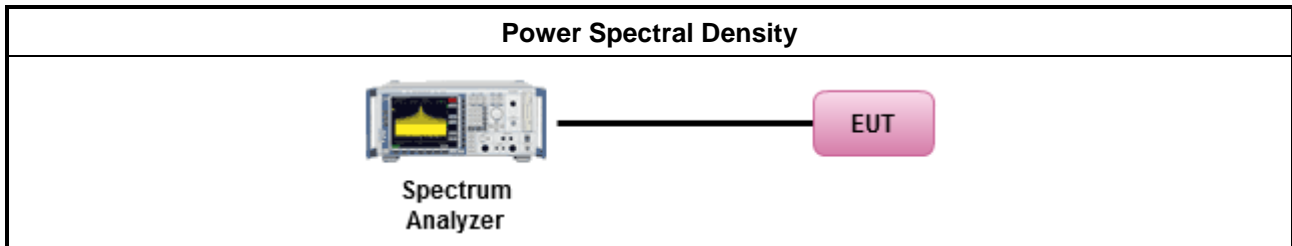

3.4.5 Test Result of Power Spectral Density

Refer as Appendix D

3.5 Emissions in Non-restricted Frequency Bands

3.5.1 Emissions in Non-restricted Frequency Bands Limit

| Un-restricted Band Emissions Limit | |
|------------------------------------|-------------|
| RF output power procedure | Limit (dBc) |
| Peak output power procedure | 20 |
| Average output power procedure | 30 |

Note 1: If the peak output power procedure is used to measure the fundamental emission power to demonstrate compliance to requirements, then the peak conducted output power measured within any 100 kHz outside the authorized frequency band shall be attenuated by at least 20 dB relative to the maximum measured in-band peak PSD level.

Note 2: If the average output power procedure is used to measure the fundamental emission power to demonstrate compliance to requirements, then the power in any 100 kHz outside of the authorized frequency band shall be attenuated by at least 30 dB relative to the maximum measured in-band average PSD level.

3.5.2 Measuring Instruments

Refer a test equipment and calibration data table in this test report.

3.5.3 Test Procedures

| Test Method |
|---|
| <ul style="list-style-type: none"> Refer as FCC KDB 558074, clause 8.5 for unwanted emissions into non-restricted bands. |

3.5.4 Test Setup

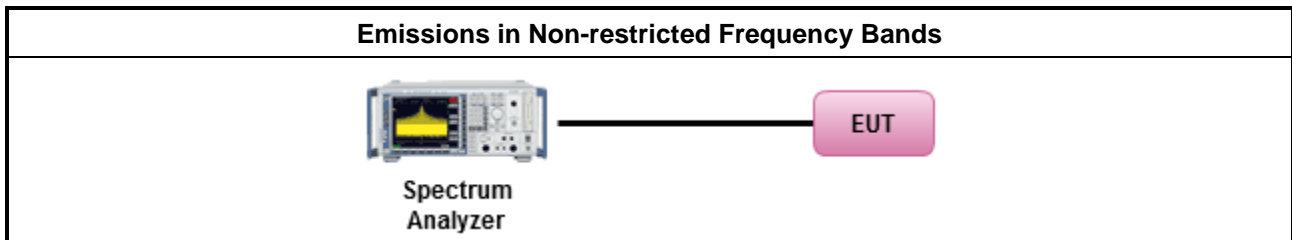

3.5.5 Test Result of Emissions in Non-restricted Frequency Bands

Refer as Appendix E



3.6 Emissions in Restricted Frequency Bands

3.6.1 Emissions in Restricted Frequency Bands Limit

| Restricted Band Emissions Limit | | | |
|---------------------------------|-----------------------|-------------------------|----------------------|
| Frequency Range (MHz) | Field Strength (uV/m) | Field Strength (dBuV/m) | Measure Distance (m) |
| 0.009~0.490 | 2400/F(kHz) | 48.5 - 13.8 | 300 |
| 0.490~1.705 | 24000/F(kHz) | 33.8 - 23 | 30 |
| 1.705~30.0 | 30 | 29 | 30 |
| 30~88 | 100 | 40 | 3 |
| 88~216 | 150 | 43.5 | 3 |
| 216~960 | 200 | 46 | 3 |
| Above 960 | 500 | 54 | 3 |

Note 1: Test distance for frequencies at or above 30 MHz, measurements may be performed at a distance other than the limit distance provided they are not performed in the near field and the emissions to be measured can be detected by the measurement equipment. When performing measurements at a distance other than that specified, the results shall be extrapolated to the specified distance using an extrapolation factor of 20 dB/decade (inverse of linear distance for field-strength measurements, inverse of linear distance-squared for power-density measurements).

Note 2: Test distance for frequencies at below 30 MHz, measurements may be performed at a distance closer than the EUT limit distance; however, an attempt should be made to avoid making measurements in the near field. When performing measurements below 30 MHz at a closer distance than the limit distance, the results shall be extrapolated to the specified distance by either making measurements at a minimum of two or more distances on at least one radial to determine the proper extrapolation factor or by using the square of an inverse linear distance extrapolation factor (40 dB/decade). The test report shall specify the extrapolation method used to determine compliance of the EUT.

Note 3: Using the distance of 1m during the test for above 18 GHz, and the test value to correct for the distance factor at 3m.

3.6.2 Measuring Instruments

Refer a test equipment and calibration data table in this test report.



3.6.3 Test Procedures

| Test Method | |
|---|--|
| <ul style="list-style-type: none"> ▪ The average emission levels shall be measured in [duty cycle \geq 98 or duty factor]. | |
| <ul style="list-style-type: none"> ▪ Refer as ANSI C63.10, clause 6.10.3 band-edge testing shall be performed at the lowest frequency channel and highest frequency channel within the allowed operating band. | |
| <ul style="list-style-type: none"> ▪ For the transmitter unwanted emissions shall be measured using following options below: | |
| | <ul style="list-style-type: none"> ▪ Refer as FCC KDB 558074, clause 8.6 for unwanted emissions into restricted bands. |
| | <input type="checkbox"/> Refer as FCC KDB 558074, clause 8.6 & C63.10 clause 11.12.2.5.1(trace averaging for duty cycle \geq 98%). |
| | <input type="checkbox"/> Refer as FCC KDB 558074, clause 8.6 & C63.10 clause 11.12.2.5.2(trace averaging + duty factor). |
| | <input checked="" type="checkbox"/> Refer as FCC KDB 558074, clause 8.6 & C63.10 clause 11.12.2.5.3(Reduced VBW \geq 1/T). |
| | <input type="checkbox"/> Refer as ANSI C63.10, clause 11.12.2.5.3 (Reduced VBW). VBW \geq 1/T, where T is pulse time. |
| | <input type="checkbox"/> Refer as ANSI C63.10, clause 7.5 average value of pulsed emissions. |
| | <input checked="" type="checkbox"/> Refer as FCC KDB 558074, clause 8.6 & C63.10 clause 11.12.2.4 measurement procedure peak limit. |
| <ul style="list-style-type: none"> ▪ For the transmitter band-edge emissions shall be measured using following options below: | |
| | <ul style="list-style-type: none"> ▪ Refer as FCC KDB 558074 clause 8.7 & c63.10 clause 11.13.1, When the performing peak or average radiated measurements, emissions within 2 MHz of the authorized band edge may be measured using the marker-delta method described below. |
| | <ul style="list-style-type: none"> ▪ Refer as FCC KDB 558074, clause 8.7 (ANSI C63.10, clause 6.10.6) for marker-delta method for band-edge measurements. |
| | <ul style="list-style-type: none"> ▪ Refer as FCC KDB 558074, clause 8.7 for narrower resolution bandwidth (100kHz) using the band power and summing the spectral levels (i.e., 1 MHz). |
| | <ul style="list-style-type: none"> ▪ For conducted unwanted emissions into restricted bands (absolute emission limits). Devices with multiple transmit chains using options given below: (1) Measure and sum the spectra across the outputs or (2) Measure and add 10 log(N) dB |
| | <ul style="list-style-type: none"> ▪ For FCC KDB 662911 The methodology described here may overestimate array gain, thereby resulting in apparent failures to satisfy the out-of-band limits even if the device is actually compliant. In such cases, compliance may be demonstrated by performing radiated tests around the frequencies at which the apparent failures occurred. |

3.6.4 Test Setup

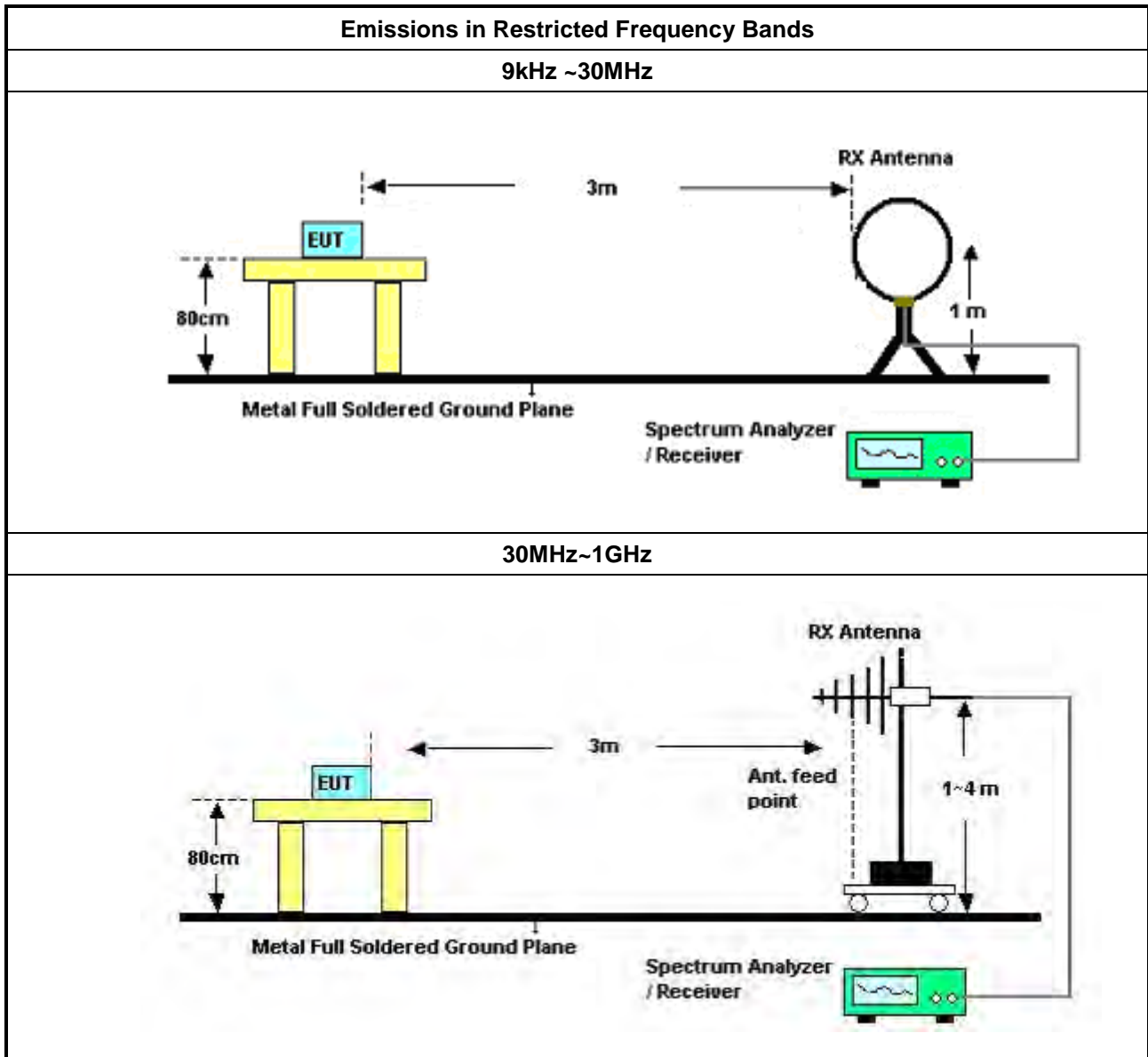

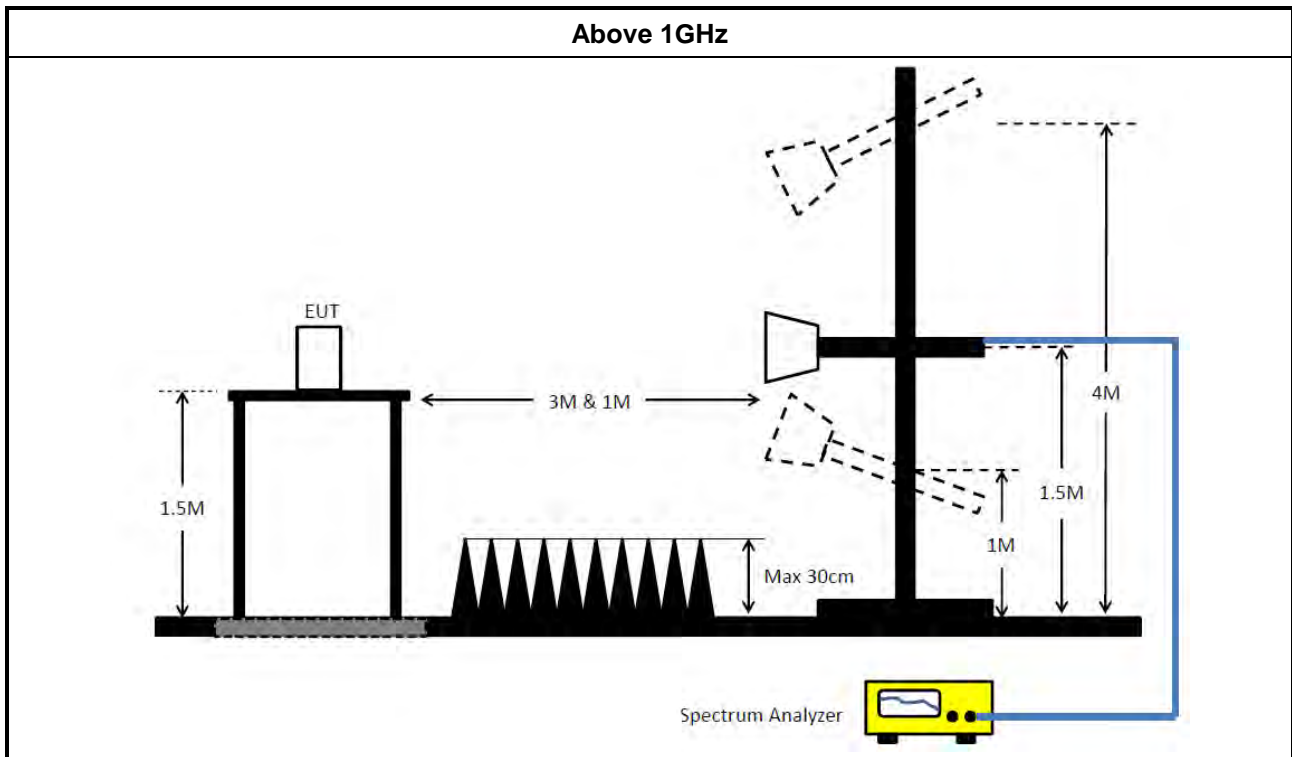

3.6.5 Measurement Results Calculation

The measured Level is calculated using:

Corrected Reading: Antenna factor (AF) + Cable loss (CL) + Read level (Raw) - Preamp factor (PA)(if applicable) = Level.

3.6.6 Emissions in Restricted Frequency Bands (Below 30MHz)

There is a comparison data of both open-field test site and alternative test site - semi-Anechoic chamber according to KDB414788 Radiated Test Site, and the result came out very similar.

All amplitude of spurious emissions that are attenuated by more than 20 dB below the permissible value has no need to be reported.

The radiated emissions were investigated from 9 kHz or the lowest frequency generated within the device, up to the 10th harmonic or 40 GHz, whichever is appropriate.

3.6.7 Test Result of Emissions in Restricted Frequency Bands

Refer as Appendix F



4 Test Equipment and Calibration Data

| Instrument | Brand | Model No. | Serial No. | Characteristics | Calibration Date | Calibration Due Date | Remark |
|------------------------------------|--------------|-------------------|------------------|-----------------|------------------|----------------------|-----------------------|
| LISN | Schwarzbeck | NSLK 8127 | 8127650 | 9kHz ~ 30MHz | Apr. 15, 2024 | Apr. 14, 2025 | Conduction (CO02-CB) |
| LISN | Schwarzbeck | NSLK 8127 | 8127478 | 9kHz ~ 30MHz | Feb. 06, 2025 | Feb. 05, 2026 | Conduction (CO02-CB) |
| EMI Receiver | Agilent | N9038A | MY52260140 | 9kHz ~ 8.4GHz | May 15, 2024 | May 14, 2025 | Conduction (CO02-CB) |
| COND Cable | Woken | Cable | 02 | 0.15MHz ~ 30MHz | Oct. 16, 2024 | Oct. 15, 2025 | Conduction (CO02-CB) |
| Pulse Limiter | Schwarzbeck | VTSD 9561F-N | 00378 | 9kHz ~ 30MHz | Oct. 16, 2024 | Oct. 15, 2025 | Conduction (CO02-CB) |
| Test Software | SPORTON | SENSE-EMI | V5.11 | 150kHz-30MHz | N.C.R. | N.C.R. | Conduction (CO02-CB) |
| Loop Antenna | Teseq | HLA 6121 | 65417 | 9kHz - 30MHz | Oct. 16, 2024 | Oct. 15, 2025 | Radiation (03CH06-CB) |
| 3m Semi Anechoic Chamber NSA | TDK | SAC-3M | 03CH06-CB | 30 MHz ~ 1 GHz | Aug. 02, 2024 | Aug. 01, 2025 | Radiation (03CH06-CB) |
| Bilog Antenna with 6 dB attenuator | TESEQ & EMCI | CBL6112D & N-6-06 | 37878 & AT-N0606 | 20MHz ~ 2GHz | Jul. 29, 2024 | Jul. 28, 2025 | Radiation (03CH06-CB) |
| Pre-Amplifier | Agilent | 310N | 187290 | 0.1MHz ~ 1GHz | Nov. 02, 2024 | Nov. 01, 2025 | Radiation (03CH06-CB) |
| Signal analyzer | R&S | FSV3044 | 101667 | 9kHz~44GHz | Aug. 20, 2024 | Aug. 19, 2025 | Radiation (03CH06-CB) |
| EMI Test Receiver | R&S | ESR7 | 102172 | 9kHz ~ 7GHz | Oct. 21, 2024 | Oct. 20, 2025 | Radiation (03CH06-CB) |
| RF Cable-low | Woken | RG402 | Low Cable-05+68 | 30MHz~1GHz | Oct. 24, 2024 | Oct. 23, 2025 | Radiation (03CH06-CB) |
| Test Software | SPORTON | SENSE-EMI | V5.11.8 | 30MHz-40GHz | N.C.R. | N.C.R. | Radiation (03CH06-CB) |
| 3m Semi Anechoic Chamber VSWR | TDK | SAC-3M | 03CH03-CB | 1GHz ~18GHz 3m | May 03, 2024 | May 02, 2025 | Radiation (03CH03-CB) |
| Horn Antenna | ETS-Lindgren | 3115 | 6821 | 750MHz~18GHz | Feb. 20, 2025 | Feb. 19, 2026 | Radiation (03CH03-CB) |
| Horn Antenna | Schwarzbeck | BBHA 9170 | BBHA9170252 | 15GHz ~ 40GHz | Sep. 23, 2024 | Sep. 22, 2025 | Radiation (03CH03-CB) |
| Pre-Amplifier | Agilent | 8449B | 3008A02097 | 1GHz ~ 26.5GHz | Jun. 29, 2024 | Jun. 28, 2025 | Radiation (03CH03-CB) |
| Pre-Amplifier | SGH | SGH184 | 20221107-3 | 18GHz ~ 40GHz | Nov. 25, 2024 | Nov. 24, 2025 | Radiation (03CH03-CB) |
| Spectrum Analyzer | R&S | FSP40 | 100019 | 9kHz ~ 40GHz | Jun. 11, 2024 | Jun. 10, 2025 | Radiation (03CH03-CB) |
| RF Cable-high | Woken | RG402 | High Cable-20+29 | 1GHz ~ 18GHz | Oct. 01, 2024 | Sep. 30, 2025 | Radiation (03CH03-CB) |



| Instrument | Brand | Model No. | Serial No. | Characteristics | Calibration Date | Calibration Due Date | Remark |
|-------------------------------|--------------|-----------------|------------------|-------------------|------------------|----------------------|-----------------------|
| RF Cable-high | Woken | RG402 | High Cable-29 | 1GHz ~ 18GHz | Oct. 01, 2024 | Sep. 30, 2025 | Radiation (03CH03-CB) |
| High Cable | Woken | WCA0929M | 40G#5+6 | 1GHz ~ 40 GHz | Oct. 01, 2024 | Sep. 30, 2025 | Radiation (03CH03-CB) |
| Test Software | SPORTON | SENSE-15247_DTS | V5.11.23 | 2.4GHz-2.4835G Hz | N.C.R. | N.C.R. | Radiation (03CH03-CB) |
| 3m Semi Anechoic Chamber VSWR | TDK | SAC-3M | 03CH01-CB | 1GHz ~18GHz 3m | May 04, 2024 | May 03, 2025 | Radiation (03CH01-CB) |
| Horn Antenna | ETS-Lindgren | 3115 | 00143147 | 750MHz~18GHz | Oct. 18, 2024 | Oct. 17, 2025 | Radiation (03CH01-CB) |
| Horn Antenna | Schwarzbeck | BBHA 9170 | BBHA9170252 | 15GHz ~ 40GHz | Sep. 23, 2024 | Sep. 22, 2025 | Radiation (03CH01-CB) |
| Pre-Amplifier | Agilent | 8449B | 3008A02121 | 1GHz ~ 26.5GHz | May 17, 2024 | May 16, 2025 | Radiation (03CH01-CB) |
| Pre-Amplifier | SGH | SGH184 | 20221107-3 | 18GHz ~ 40GHz | Nov. 25, 2024 | Nov. 24, 2025 | Radiation (03CH01-CB) |
| Signal Analyzer | R&S | FSV3044 | 101437 | 10kHz ~ 44GHz | Dec. 12, 2024 | Dec. 11, 2025 | Radiation (03CH01-CB) |
| RF Cable-high | Woken | RG402 | High Cable-16 | 1 GHz ~ 18 GHz | Oct. 01, 2024 | Sep. 30, 2025 | Radiation (03CH01-CB) |
| RF Cable-high | Woken | RG402 | High Cable-16+17 | 1 GHz ~ 18 GHz | Oct. 01, 2024 | Sep. 30, 2025 | Radiation (03CH01-CB) |
| High Cable | Woken | WCA0929M | 40G#5+6 | 1GHz ~ 40 GHz | Oct. 01, 2024 | Sep. 30, 2025 | Radiation (03CH01-CB) |
| High Cable | Woken | WCA0929M | 40G#5+6 | 1GHz ~ 40 GHz | Oct. 01, 2024 | Sep. 30, 2025 | Radiation (03CH01-CB) |
| Test Software | SPORTON | SENSE-15247_DTS | V5.11.23 | 2.4GHz-2.4835G Hz | N.C.R. | N.C.R. | Radiation (03CH01-CB) |
| Spectrum analyzer | R&S | FSV40 | 100979 | 9kHz~40GHz | May 27, 2024 | May 26, 2025 | Conducted (TH01-CB) |
| Switch | SPTCB | SP-SWI | SWI-01 | 1~18 GHz | Oct. 02, 2024 | Oct. 01, 2025 | Conducted (TH01-CB) |
| RF Cable-high | Woken | RG402 | High Cable-06 | 1 GHz – 18 GHz | Oct. 01, 2024 | Sep. 30, 2025 | Conducted (TH01-CB) |
| RF Cable-high | Woken | RG402 | High Cable-07 | 1 GHz – 18 GHz | Oct. 01, 2024 | Sep. 30, 2025 | Conducted (TH01-CB) |
| RF Cable-high | Woken | RG402 | High Cable-08 | 1 GHz – 18 GHz | Oct. 01, 2024 | Sep. 30, 2025 | Conducted (TH01-CB) |
| RF Cable-high | Woken | RG402 | High Cable-09 | 1 GHz – 18 GHz | Oct. 01, 2024 | Sep. 30, 2025 | Conducted (TH01-CB) |
| RF Cable-high | Woken | RG402 | High Cable-10 | 1 GHz – 18 GHz | Oct. 01, 2024 | Sep. 30, 2025 | Conducted (TH01-CB) |
| Power Sensor | Agilent | E9327A | US40442088 | 50MHz~18GHz | Mar. 01, 2024 | Feb. 28, 2025 | Conducted (TH01-CB) |
| Power Meter | Agilent | E4416A | MY45100745 | 50MHz~18GHz | Jul. 12, 2024 | Jul. 11, 2025 | Conducted (TH01-CB) |



| Instrument | Brand | Model No. | Serial No. | Characteristics | Calibration Date | Calibration Due Date | Remark |
|---------------|---------|-----------------|------------|-------------------|------------------|----------------------|---------------------|
| Test Software | SPORTON | SENSE-15247_DTS | V5.11.23 | 2.4GHz-2.4835G Hz | N.C.R. | N.C.R. | Conducted (TH01-CB) |

Note: Calibration Interval of instruments listed above is one year.

N.C.R. means Non-Calibration required.



Summary

| Mode | Result | Type | Freq (Hz) | Level (dBuV) | Limit (dBuV) | Margin (dB) | Condition |
|--------|--------|------|-----------|--------------|--------------|-------------|-----------|
| Mode 4 | Pass | QP | 150k | 51.99 | 66.00 | -14.01 | Line |

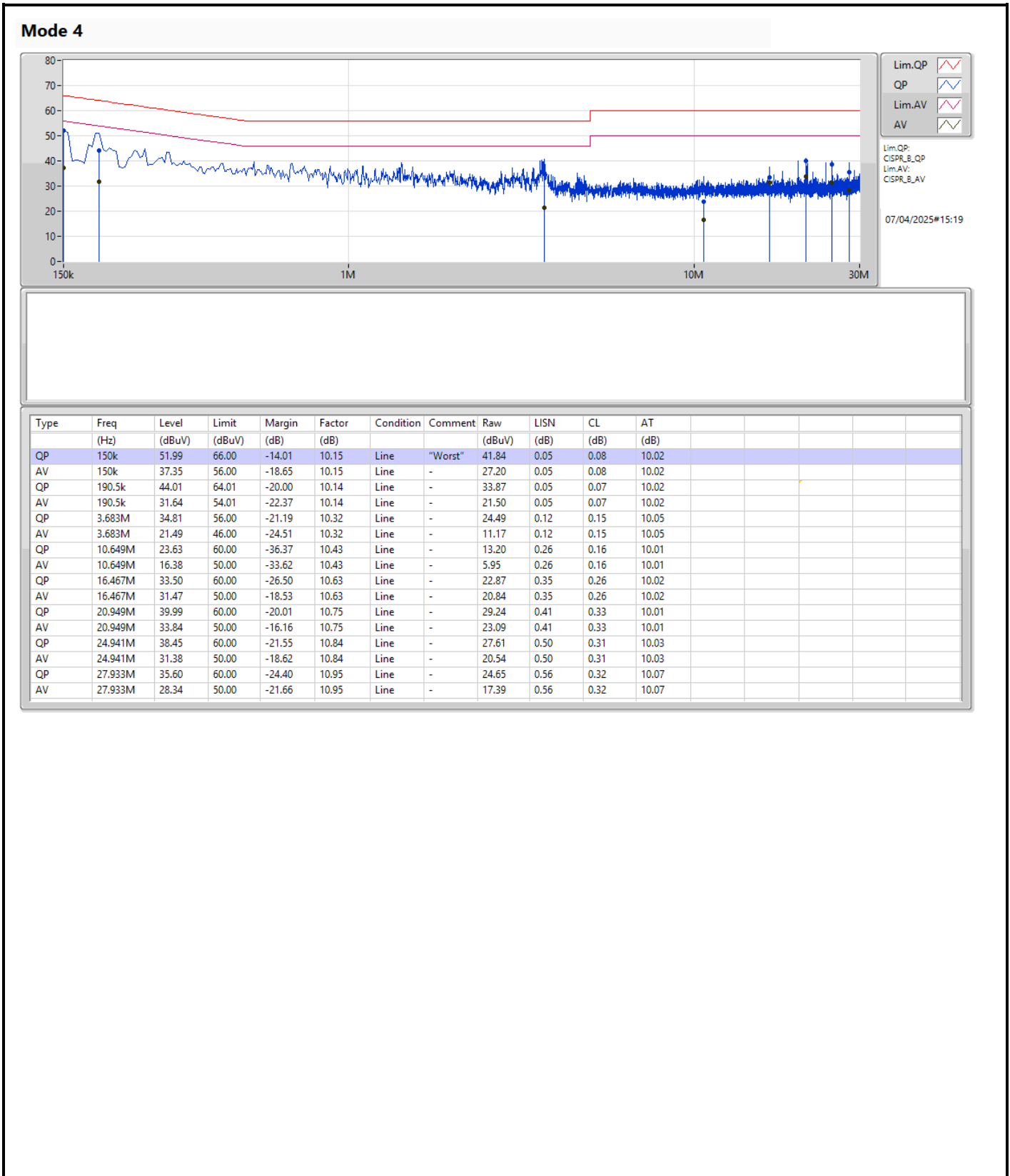

Mode 4

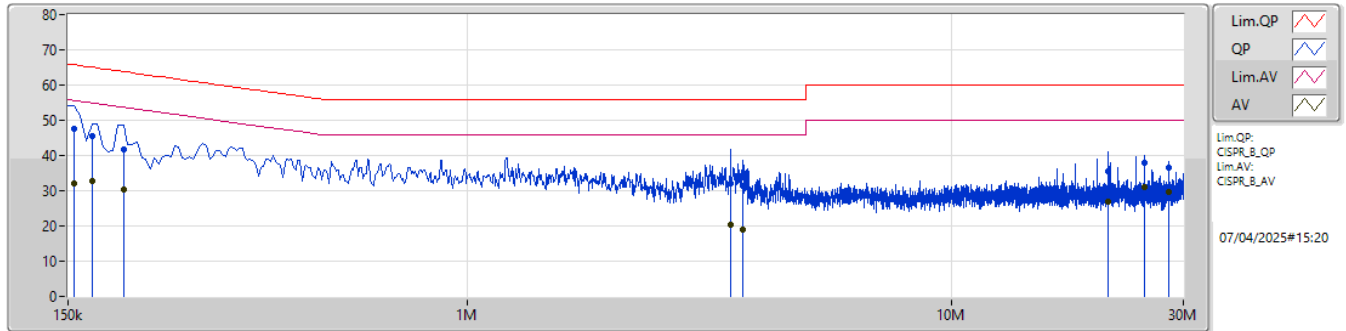

| Type | Freq (Hz) | Level (dBuV) | Limit (dBuV) | Margin (dB) | Factor (dB) | Condition | Comment | Raw (dBuV) | LISN (dB) | CL (dB) | AT (dB) |
|------|-----------|--------------|--------------|-------------|-------------|-----------|---------|------------|-----------|---------|---------|
| QP | 154.5k | 47.46 | 65.75 | -18.29 | 10.15 | Neutral | "Worst" | 37.31 | 0.05 | 0.08 | 10.02 |
| AV | 154.5k | 32.14 | 55.75 | -23.61 | 10.15 | Neutral | - | 21.99 | 0.05 | 0.08 | 10.02 |
| QP | 168k | 45.39 | 65.06 | -19.67 | 10.15 | Neutral | - | 35.24 | 0.05 | 0.08 | 10.02 |
| AV | 168k | 32.65 | 55.06 | -22.41 | 10.15 | Neutral | - | 22.50 | 0.05 | 0.08 | 10.02 |
| QP | 195k | 41.87 | 63.82 | -21.95 | 10.14 | Neutral | - | 31.73 | 0.05 | 0.07 | 10.02 |
| AV | 195k | 30.37 | 53.82 | -23.45 | 10.14 | Neutral | - | 20.23 | 0.05 | 0.07 | 10.02 |
| QP | 3.494M | 32.05 | 56.00 | -23.95 | 10.30 | Neutral | - | 21.75 | 0.10 | 0.15 | 10.05 |
| AV | 3.494M | 20.27 | 46.00 | -25.73 | 10.30 | Neutral | - | 9.97 | 0.10 | 0.15 | 10.05 |
| QP | 3.71M | 31.47 | 56.00 | -24.53 | 10.31 | Neutral | - | 21.16 | 0.11 | 0.15 | 10.05 |
| AV | 3.71M | 18.83 | 46.00 | -27.17 | 10.31 | Neutral | - | 8.52 | 0.11 | 0.15 | 10.05 |
| QP | 20.954M | 35.68 | 60.00 | -24.32 | 10.61 | Neutral | - | 25.07 | 0.27 | 0.33 | 10.01 |
| AV | 20.954M | 27.01 | 50.00 | -22.99 | 10.61 | Neutral | - | 16.40 | 0.27 | 0.33 | 10.01 |
| QP | 24.941M | 38.10 | 60.00 | -21.90 | 10.64 | Neutral | - | 27.46 | 0.30 | 0.31 | 10.03 |
| AV | 24.941M | 30.92 | 50.00 | -19.08 | 10.64 | Neutral | - | 20.28 | 0.30 | 0.31 | 10.03 |
| QP | 27.933M | 36.38 | 60.00 | -23.62 | 10.71 | Neutral | - | 25.67 | 0.32 | 0.32 | 10.07 |
| AV | 27.933M | 29.66 | 50.00 | -20.34 | 10.71 | Neutral | - | 18.95 | 0.32 | 0.32 | 10.07 |



Summary

| Mode | Max-N dB (Hz) | Max-OBW (Hz) | ITU-Code | Min-N dB (Hz) | Min-OBW (Hz) |
|----------------------|---------------|--------------|----------|---------------|--------------|
| 2.4-2.4835GHz | - | - | - | - | - |
| Thread_3MHz_Nss1_1TX | 1.613M | 2.396M | 2M40G1D | 1.605M | 2.253M |

Max-N dB = Maximum 6dB down bandwidth; Max-OBW = Maximum 99% occupied bandwidth;
Min-N dB = Minimum 6dB down bandwidth; Min-OBW = Minimum 99% occupied bandwidth

Result

| Mode | Result | Limit (Hz) | Port 1-N dB (Hz) | Port 1-OBW (Hz) |
|----------------------|--------|------------|------------------|-----------------|
| Thread_3MHz_Nss1_1TX | - | - | - | - |
| 2405MHz | Pass | 500k | 1.613M | 2.396M |
| 2440MHz | Pass | 500k | 1.613M | 2.382M |
| 2480MHz | Pass | 500k | 1.605M | 2.253M |

Port X-N dB = Port X 6dB down bandwidth;
Port X-OBW = Port X 99% occupied bandwidth

2.4-2.4835GHz_Thread_3MHz_Nss1_1TX

EBW

2405MHz

27/03/2025

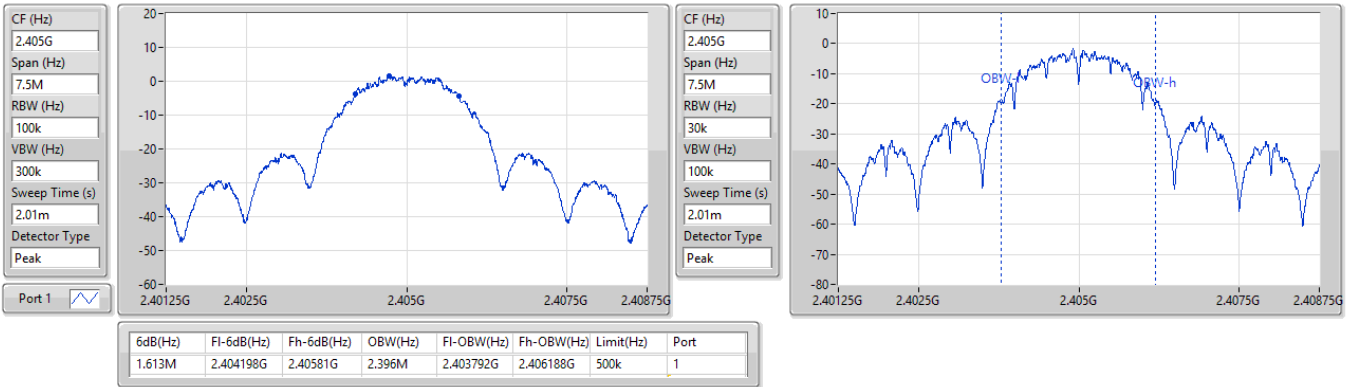

2.4-2.4835GHz_Thread_3MHz_Nss1_1TX

EBW

2440MHz

27/03/2025

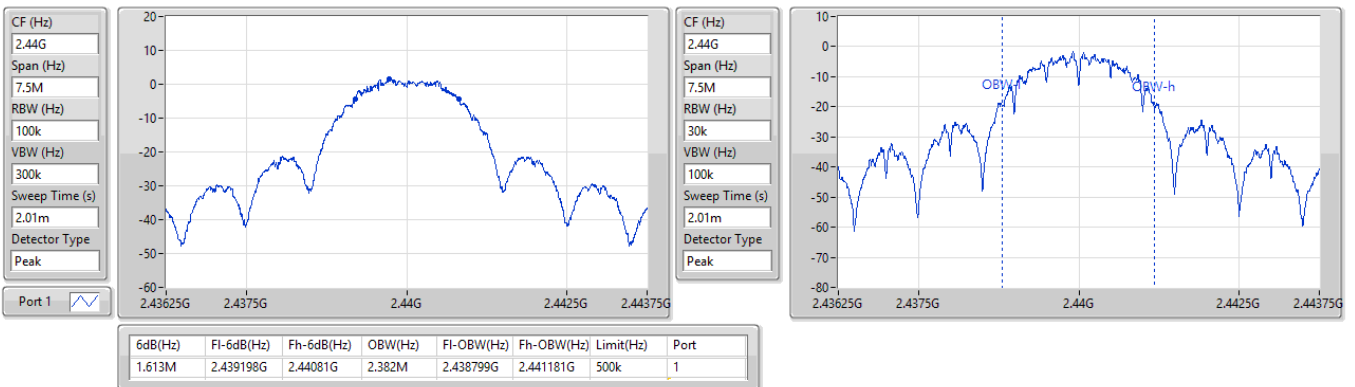

2.4-2.4835GHz_Thread_3MHz_Nss1_1TX

EBW

2480MHz

27/03/2025

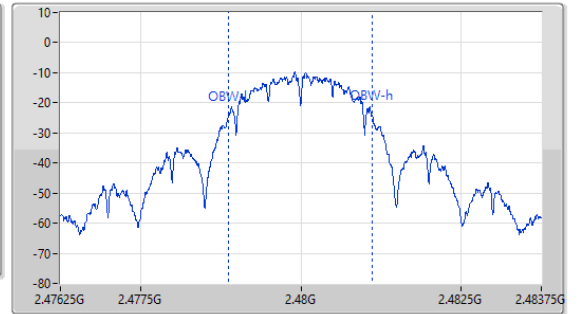
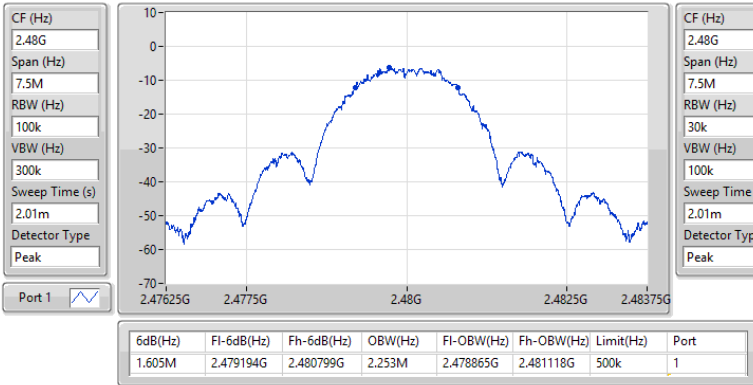



Summary

| Mode | Total Power (dBm) | Total Power (W) |
|----------------------|-------------------|-----------------|
| 2.4-2.4835GHz | - | - |
| Thread_3MHz_Nss1_1TX | 5.63 | 0.00366 |



Result

| Mode | Result | DG (dBi) | Port 1 (dBm) | Total Power (dBm) | Power Limit (dBm) |
|----------------------|--------|----------|--------------|-------------------|-------------------|
| Thread_3MHz_Nss1_1TX | - | - | - | - | - |
| 2405MHz | Pass | 3.50 | 5.54 | 5.54 | 30.00 |
| 2440MHz | Pass | 3.50 | 5.63 | 5.63 | 30.00 |
| 2475MHz | Pass | 3.50 | 5.59 | 5.59 | 30.00 |
| 2480MHz | Pass | 3.50 | -2.27 | -2.27 | 30.00 |

DG = Directional Gain; Port X = Port X output power;
Inf = There's no restriction for the limit.



Summary

| Mode | PD (dBm/RBW) |
|----------------------|-----------------|
| 2.4-2.4835GHz | - |
| Thread_3MHz_Nss1_1TX | -10.13 |

RBW = 3kHz;



Result

| Mode | Result | DG (dBi) | Port 1 (dBm/RBW) | PD (dBm/RBW) | PD Limit (dBm/RBW) |
|----------------------|--------|----------|------------------|--------------|--------------------|
| Thread_3MHz_Nss1_1TX | - | - | - | - | - |
| 2405MHz | Pass | 3.50 | -10.39 | -10.39 | 8.00 |
| 2440MHz | Pass | 3.50 | -10.13 | -10.13 | 8.00 |
| 2480MHz | Pass | 3.50 | -18.14 | -18.14 | 8.00 |

DG = Directional Gain; RBW = 3kHz;
PD = trace bin-by-bin of each transmits port summing can be performed maximum power density; Port X = Port X Power Density;
Inf = There's no restriction for the limit.

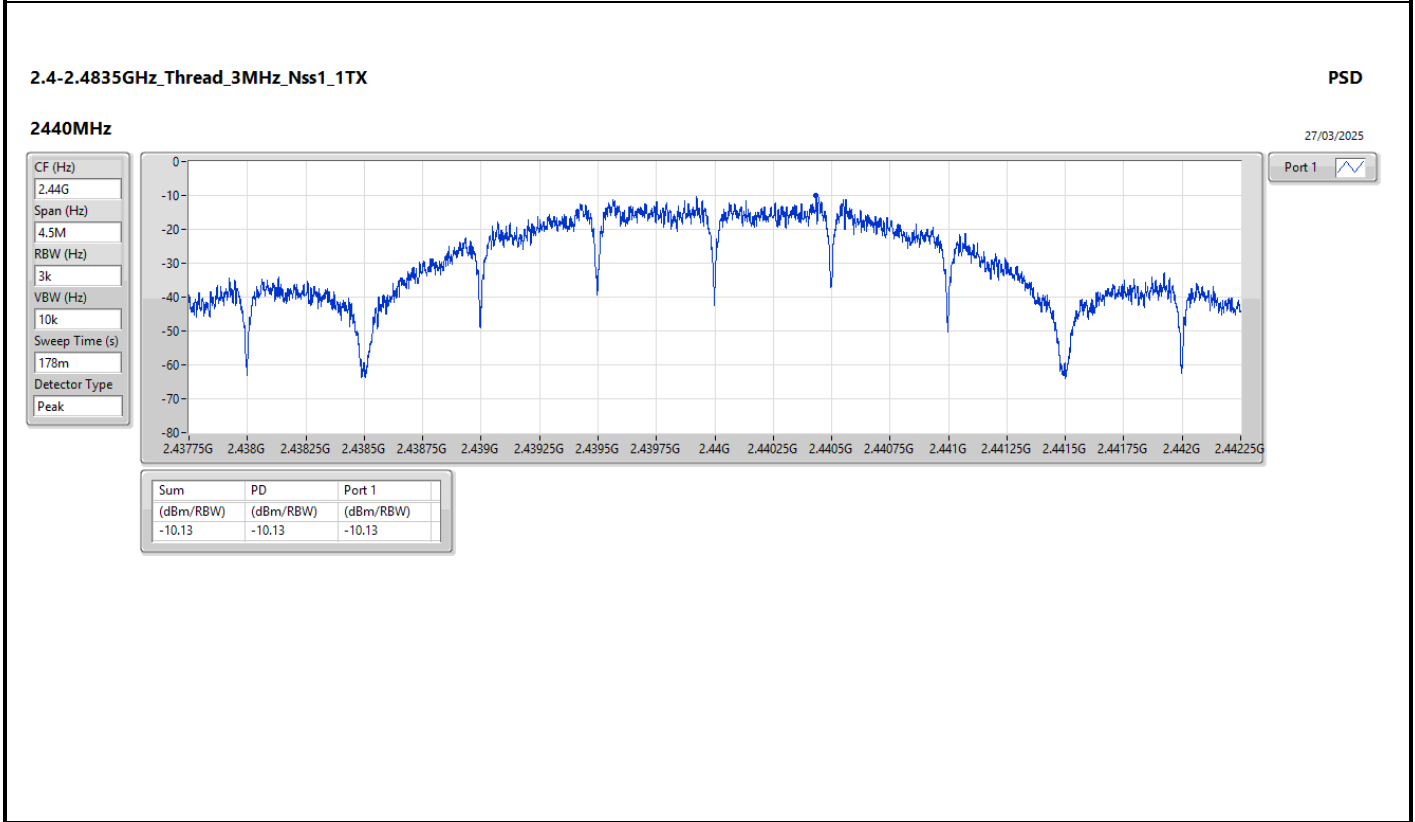
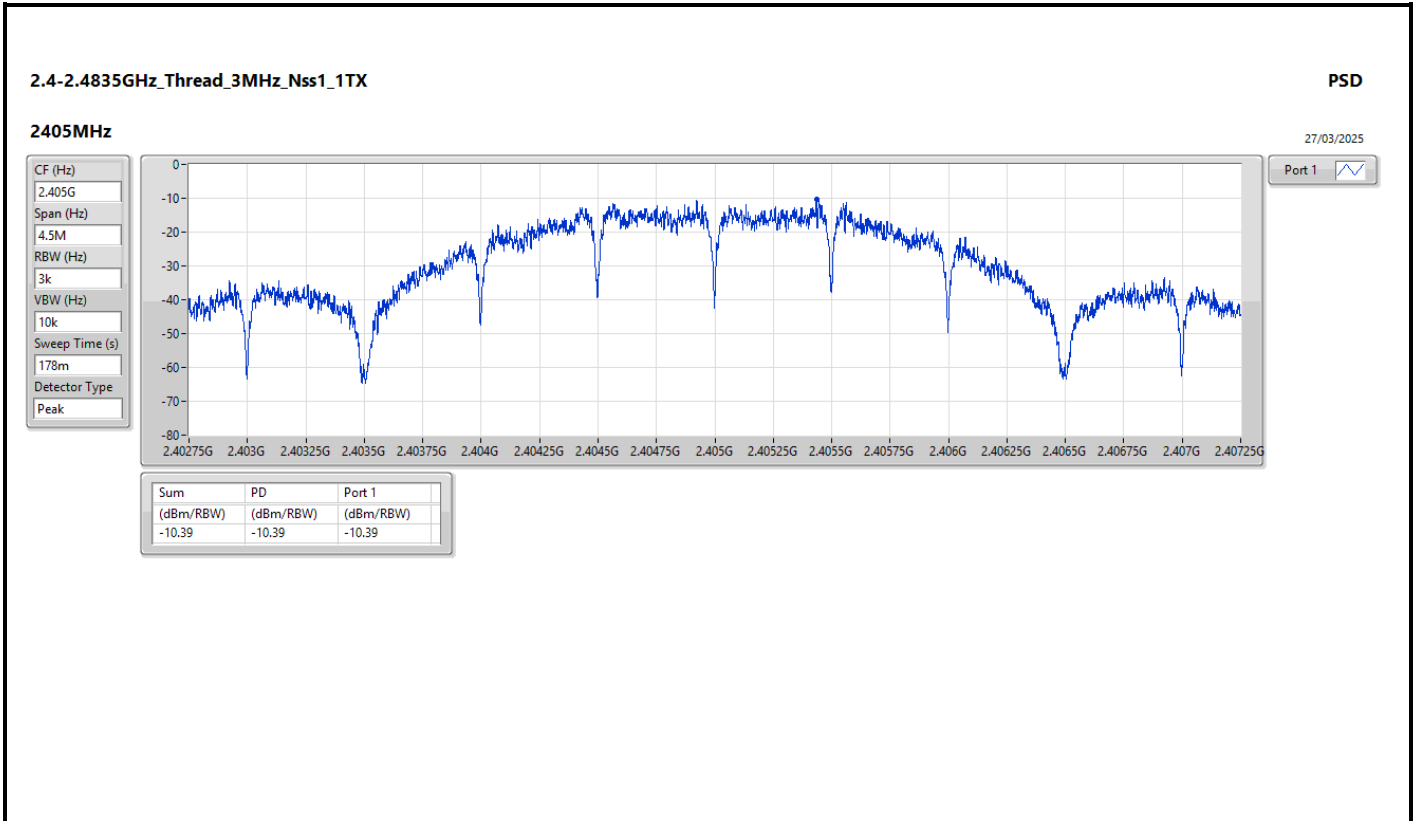

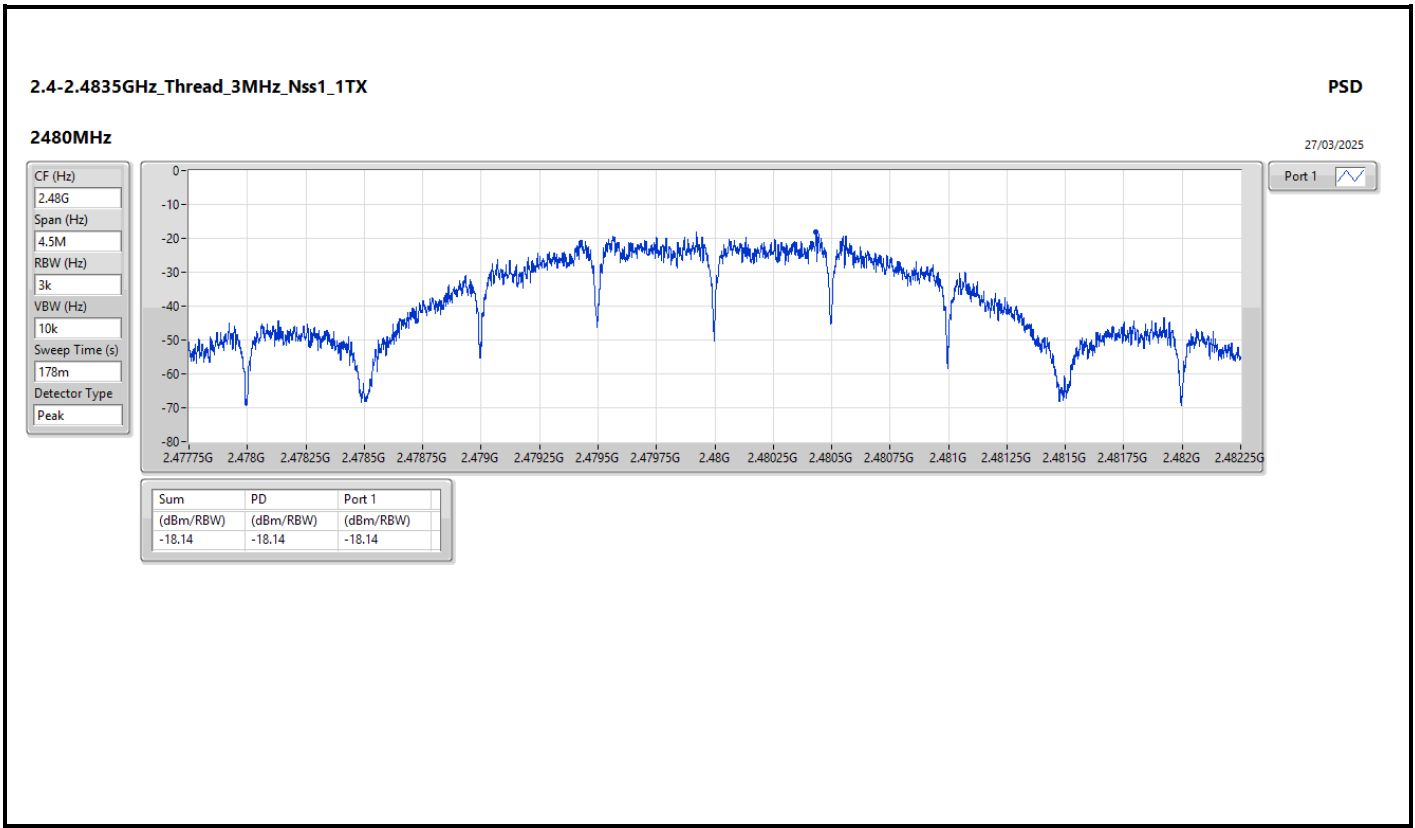



Summary

| Mode | Result | Ref (Hz) | Ref (dBm) | Limit (dBm) | Freq (Hz) | Level (dBm) | Freq (Hz) | Level (dBm) | Freq (Hz) | Level (dBm) | Freq (Hz) | Level (dBm) | Port |
|----------------------|--------|----------|-----------|-------------|-----------|-------------|-----------|-------------|-----------|-------------|-----------|-------------|------|
| 2.4-2.4835GHz | - | - | - | - | - | - | - | - | - | - | - | - | - |
| Thread_3MHz_Nss1_1TX | Pass | 2.43975G | 1.68 | -28.32 | 2.1836G | -54.52 | 2.39995G | -40.12 | 2.4G | -39.98 | 21.56996G | -45.97 | 1 |



Result

| Mode | Result | Ref (Hz) | Ref (dBm) | Limit (dBm) | Freq (Hz) | Level (dBm) | Freq (Hz) | Level (dBm) | Freq (Hz) | Level (dBm) | Freq (Hz) | Level (dBm) | Port |
|----------------------|--------|----------|-----------|-------------|-----------|-------------|-----------|-------------|-----------|-------------|-----------|-------------|------|
| Thread_3MHz_Nss1_1TX | - | - | - | - | - | - | - | - | - | - | - | - | - |
| 2405MHz | Pass | 2.43975G | 1.68 | -28.32 | 2.1836G | -54.52 | 2.39995G | -40.12 | 2.4G | -39.98 | 21.56996G | -45.97 | 1 |
| 2440MHz | Pass | 2.43975G | 1.68 | -28.32 | 2.05595G | -54.30 | 2.39993G | -54.36 | 2.4G | -56.56 | 21.64312G | -44.96 | 1 |
| 2480MHz | Pass | 2.43975G | 1.68 | -28.32 | 71.37M | -54.47 | 2.39546G | -54.56 | 2.4G | -57.21 | 21.68814G | -45.52 | 1 |

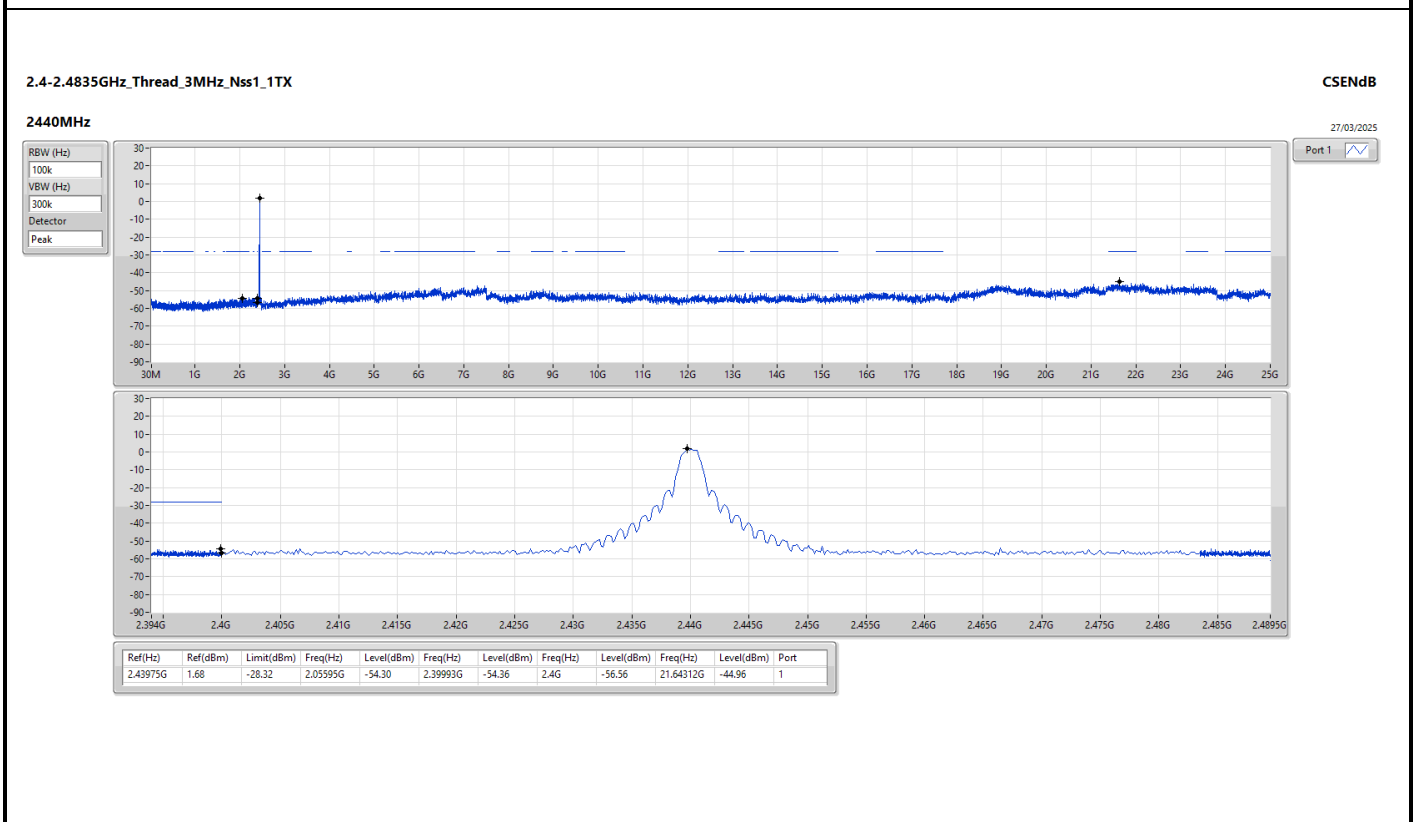
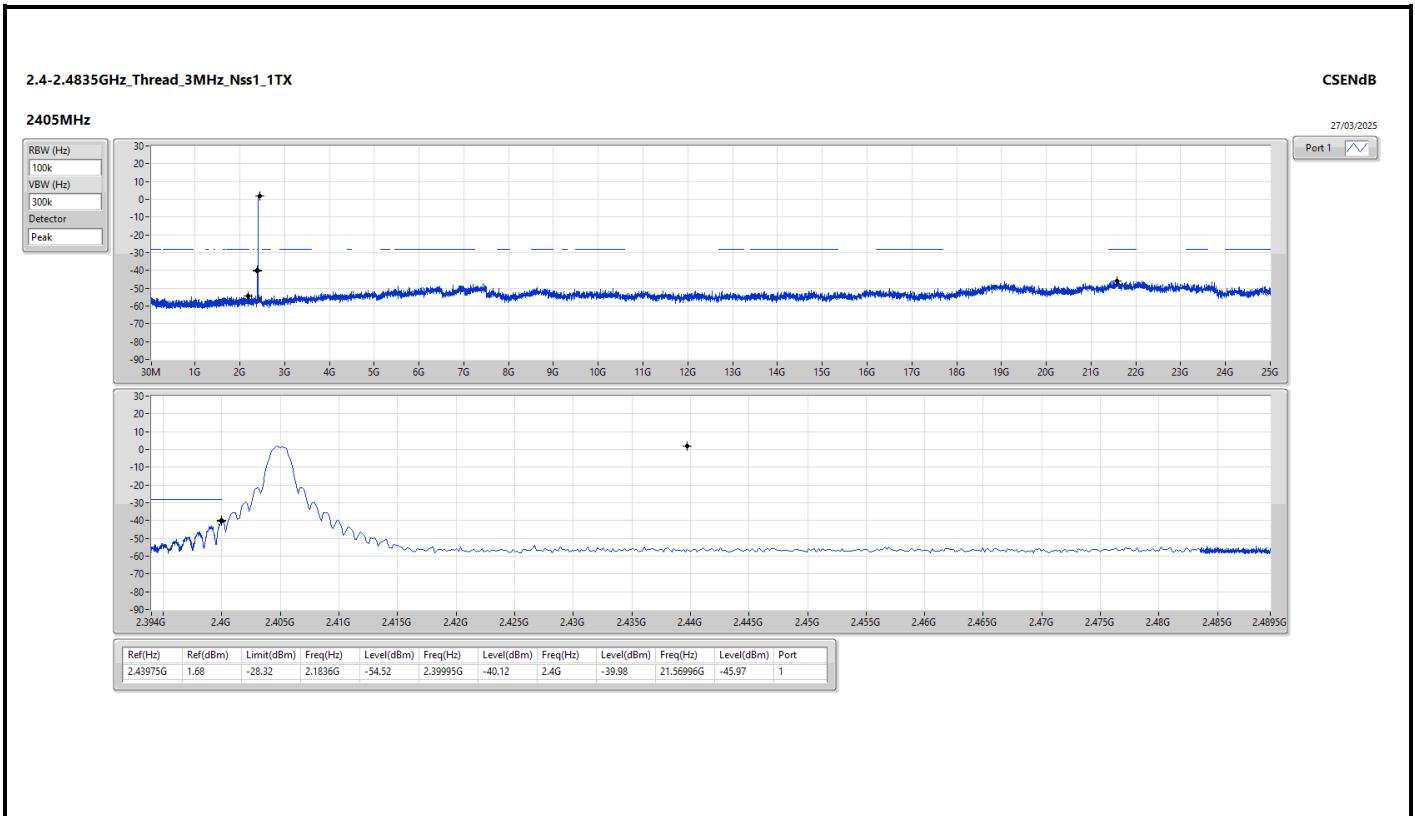

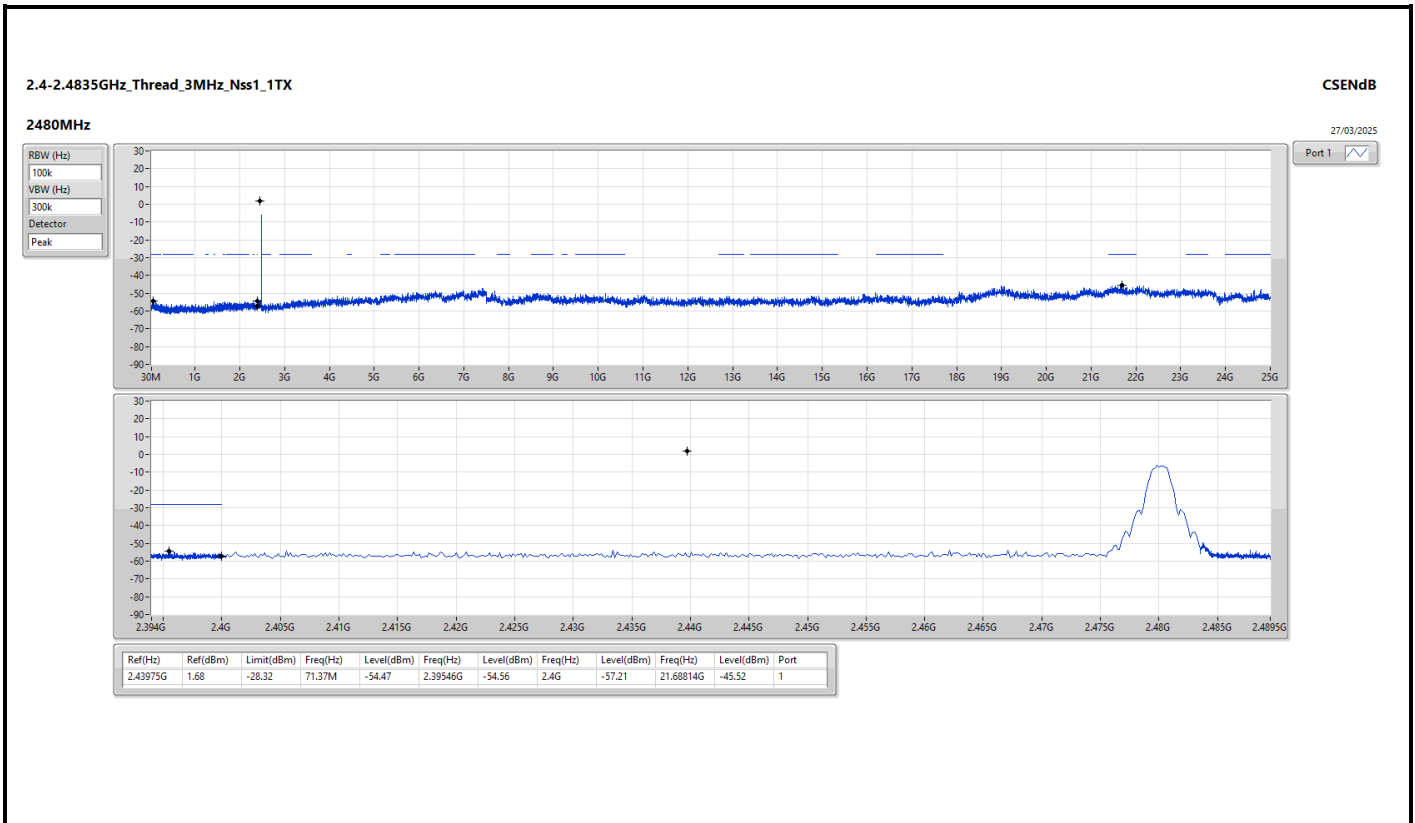



Summary

| Mode | Result | Type | Freq (Hz) | Level (dBuV/m) | Limit (dBuV/m) | Margin (dB) | Condition |
|--------|--------|------|-----------|----------------|----------------|-------------|-----------|
| Mode 1 | Pass | QP | 375.32M | 42.94 | 46.00 | -3.06 | Vertical |

Mode 1

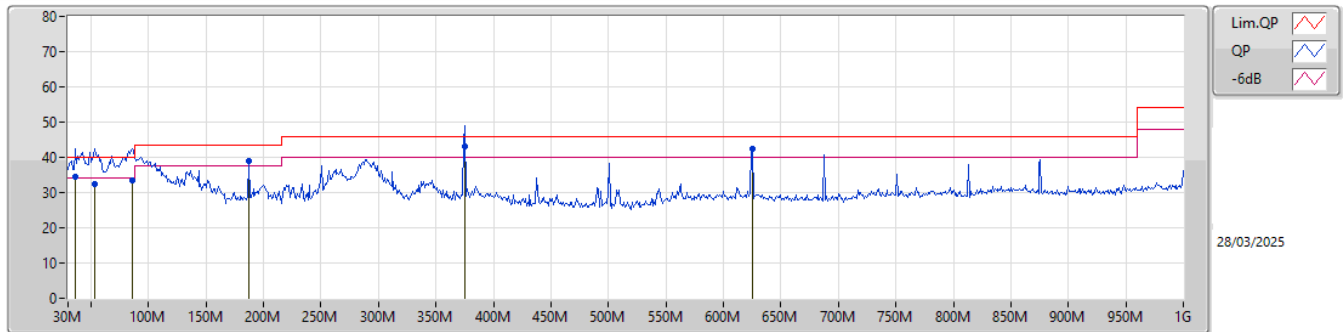

| Type | Freq (Hz) | Level (dBuV/m) | Limit (dBuV/m) | Margin (dB) | Factor (dB/m) | Dist (m) | Condition | Azimuth (°) | Height (m) | Comment | Raw (dBuV) | AF (dB/m) | CL (dB) | PA (dB) |
|------|--------------|-------------------|-------------------|----------------|------------------|-------------|-----------|----------------|---------------|---------|---------------|--------------|------------|------------|
| QP | 36.79M | 34.58 | 40.00 | -5.42 | -11.13 | 3 | Vertical | 350 | 3.00 | - | 45.71 | 20.57 | 0.58 | 32.28 |
| QP | 53.28M | 32.53 | 40.00 | -7.47 | -18.66 | 3 | Vertical | 220 | 1.25 | - | 51.19 | 12.94 | 0.68 | 32.28 |
| QP | 86.26M | 33.45 | 40.00 | -6.55 | -17.32 | 3 | Vertical | 220 | 1.25 | - | 50.77 | 14.03 | 0.97 | 32.32 |
| PK | 187.14M | 38.92 | 43.50 | -4.58 | -15.87 | 3 | Vertical | 147 | 1.00 | - | 54.79 | 14.88 | 1.35 | 32.10 |
| QP | 375.32M | 42.94 | 46.00 | -3.06 | -9.18 | 3 | Vertical | 183 | 1.25 | "Worst" | 52.12 | 20.78 | 1.93 | 31.89 |
| QP | 625.58M | 42.25 | 46.00 | -3.75 | -4.27 | 3 | Vertical | 36 | 1.00 | - | 46.52 | 24.96 | 2.51 | 31.74 |

Mode 1

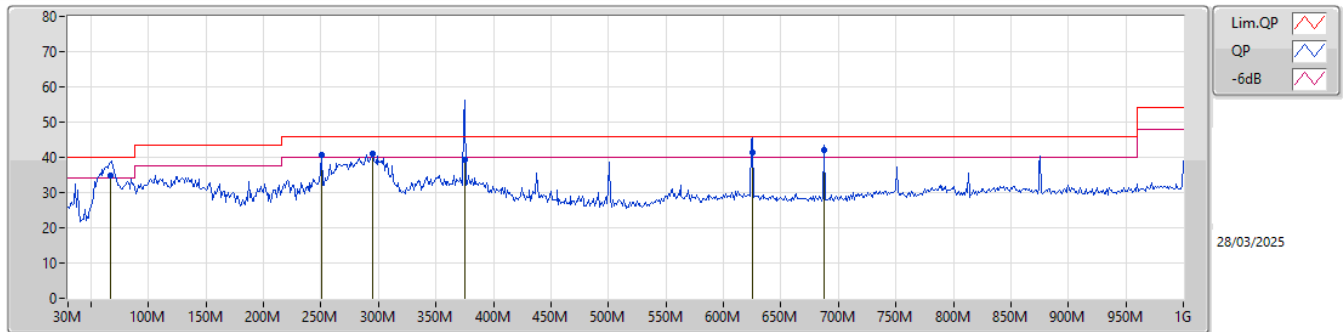

| Type | Freq (Hz) | Level (dBuV/m) | Limit (dBuV/m) | Margin (dB) | Factor (dB/m) | Dist (m) | Condition | Azimuth (°) | Height (m) | Comment | Raw (dBuV) | AF (dB/m) | CL (dB) | PA (dB) |
|------|-----------|----------------|----------------|-------------|---------------|----------|------------|-------------|------------|---------|------------|-----------|---------|---------|
| QP | 66.86M | 34.78 | 40.00 | -5.22 | -19.57 | 3 | Horizontal | 148 | 3.00 | - | 54.35 | 12.08 | 0.80 | 32.45 |
| PK | 250.19M | 40.60 | 46.00 | -5.40 | -12.26 | 3 | Horizontal | 345 | 1.25 | - | 52.86 | 18.32 | 1.56 | 32.14 |
| PK | 294.81M | 40.92 | 46.00 | -5.08 | -11.47 | 3 | Horizontal | 261 | 1.00 | - | 52.39 | 18.96 | 1.67 | 32.10 |
| QP | 375.32M | 39.34 | 46.00 | -6.66 | -9.18 | 3 | Horizontal | 165 | 1.00 | - | 48.52 | 20.78 | 1.93 | 31.89 |
| QP | 625.58M | 41.42 | 46.00 | -4.58 | -4.27 | 3 | Horizontal | 49 | 1.50 | - | 45.69 | 24.96 | 2.51 | 31.74 |
| QP | 687.66M | 42.08 | 46.00 | -3.92 | -4.14 | 3 | Horizontal | 155 | 1.25 | "Worst" | 46.22 | 25.07 | 2.60 | 31.81 |



Summary

| Mode | Result | Type | Freq (Hz) | Level (dBuV/m) | Limit (dBuV/m) | Margin (dB) | Dist (m) | Condition | Azimuth (°) | Height (m) | Comments |
|----------------------|--------|------|--------------|-------------------|-------------------|----------------|-------------|-----------|----------------|---------------|----------|
| 2.4-2.4835GHz | - | - | - | - | - | - | - | - | - | - | - |
| Thread_3MHz_Nss1_1TX | Pass | AV | 2.4835G | 51.40 | 54.00 | -2.60 | 3 | Vertical | 274 | 1.88 | - |

2.4-2.4835GHz_Thread_3MHz_Nss1_1TX

2405MHz_TX

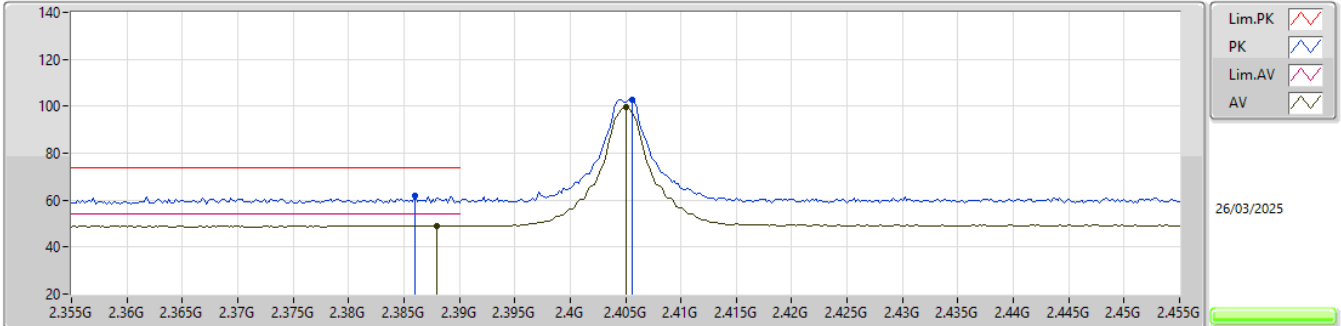

EUT_Z_1TX
Setting 6
03-P-J-10

| Type | Freq (Hz) | Level (dBuV/m) | Limit (dBuV/m) | Margin (dB) | Raw (dBuV) | Dist (m) | Condition | Azimuth (°) | Height (m) | Comment | AF (dB) | CL (dB) | PA (dB) |
|------|-----------|----------------|----------------|-------------|------------|----------|-----------|-------------|------------|---------|---------|---------|---------|
| PK | 2.386G | 61.70 | 74.00 | -12.30 | 28.54 | 3 | Vertical | 288 | 1.42 | - | 28.36 | 4.80 | - |
| AV | 2.388G | 49.18 | 54.00 | -4.82 | 16.00 | 3 | Vertical | 288 | 1.42 | - | 28.38 | 4.80 | - |
| PK | 2.4056G | 102.77 | Inf | -Inf | 69.64 | 3 | Vertical | 288 | 1.42 | - | 28.30 | 4.83 | - |
| AV | 2.405G | 99.45 | Inf | -Inf | 66.32 | 3 | Vertical | 288 | 1.42 | - | 28.30 | 4.83 | - |

2.4-2.4835GHz_Thread_3MHz_Nss1_1TX

2405MHz_TX

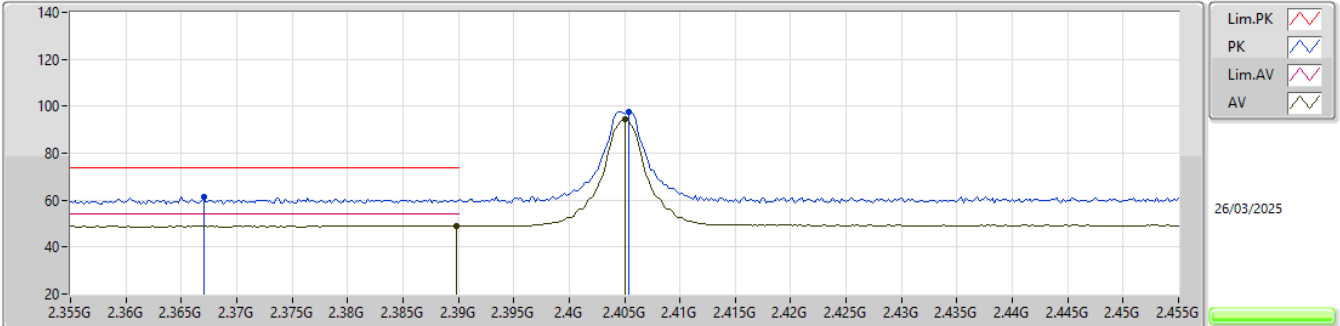

EUT_Z_1TX
Setting 6
03-P-J-10

| Type | Freq (Hz) | Level (dBuV/m) | Limit (dBuV/m) | Margin (dB) | Raw (dBuV) | Dist (m) | Condition | Azimuth (°) | Height (m) | Comment | AF (dB) | CL (dB) | PA (dB) |
|------|-----------|----------------|----------------|-------------|------------|----------|------------|-------------|------------|---------|---------|---------|---------|
| PK | 2.367G | 61.43 | 74.00 | -12.57 | 28.35 | 3 | Horizontal | 335 | 1.80 | - | 28.30 | 4.78 | - |
| AV | 2.3898G | 49.22 | 54.00 | -4.78 | 16.01 | 3 | Horizontal | 335 | 1.80 | - | 28.40 | 4.81 | - |
| PK | 2.4054G | 97.68 | Inf | -Inf | 64.55 | 3 | Horizontal | 335 | 1.80 | - | 28.30 | 4.83 | - |
| AV | 2.405G | 94.34 | Inf | -Inf | 61.21 | 3 | Horizontal | 335 | 1.80 | - | 28.30 | 4.83 | - |

2.4-2.4835GHz_Thread_3MHz_Nss1_1TX

2405MHz_TX

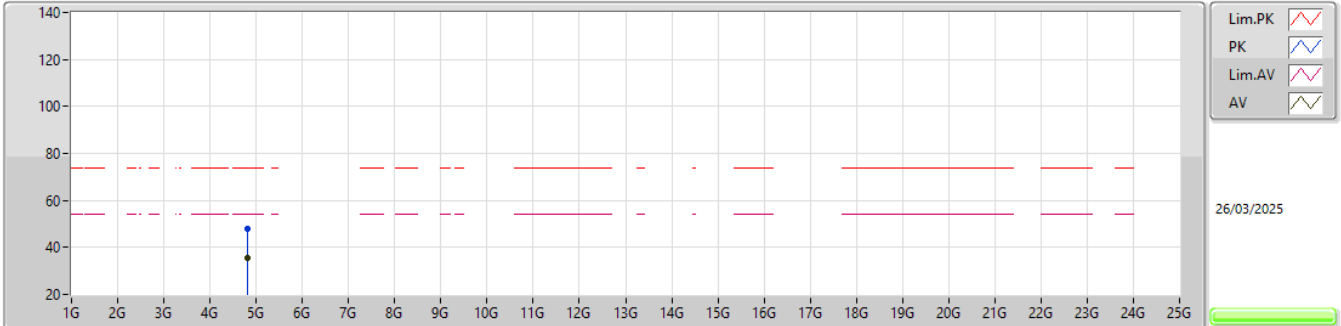





EUTZ_1TX
Setting 6
03-P-J-10

| Type | Freq | Level | Limit | Margin | Raw | Dist | Condition | Azimuth | Height | Comment | AF | CL | PA |
|------|----------|----------|----------|--------|--------|------|-----------|---------|--------|---------|-------|------|-------|
| | (Hz) | (dBuV/m) | (dBuV/m) | (dB) | (dBuV) | (m) | | (°) | (m) | | (dB) | (dB) | (dB) |
| PK | 4.80998G | 47.89 | 74.00 | -26.11 | 42.59 | 3 | Vertical | 357 | 1.57 | - | 33.42 | 7.21 | 35.33 |
| AV | 4.81108G | 35.34 | 54.00 | -18.66 | 30.04 | 3 | Vertical | 357 | 1.57 | - | 33.42 | 7.21 | 35.33 |

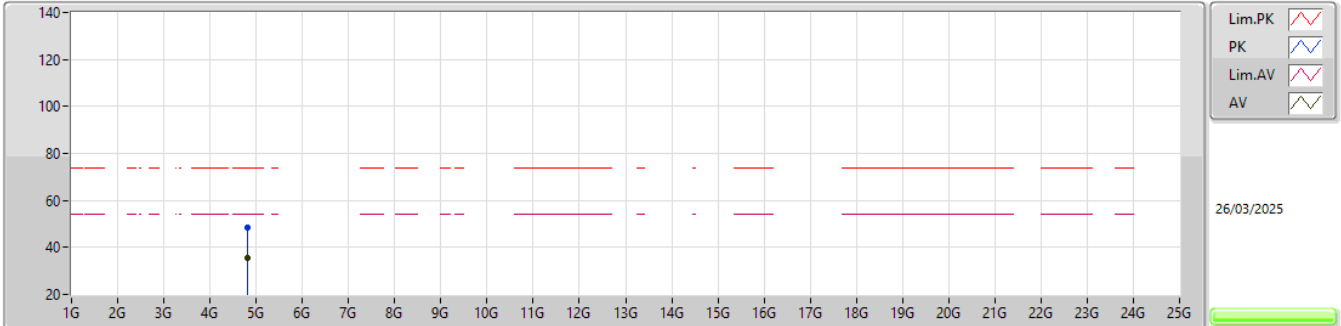
2.4-2.4835GHz_Thread_3MHz_Nss1_1TX

2405MHz_TX



Lim.PK 
 PK 
 Lim.AV 
 AV 

26/03/2025

EUT_Z_1TX
 Setting 6
 03-P-J-10

| Type | Freq (Hz) | Level (dBuV/m) | Limit (dBuV/m) | Margin (dB) | Raw (dBuV) | Dist (m) | Condition | Azimuth (*) | Height (m) | Comment | AF (dB) | CL (dB) | PA (dB) |
|------|-----------|----------------|----------------|-------------|------------|----------|------------|-------------|------------|---------|---------|---------|---------|
| PK | 4.80848G | 48.54 | 74.00 | -25.46 | 43.24 | 3 | Horizontal | 183 | 2.87 | - | 33.42 | 7.21 | 35.33 |
| AV | 4.81296G | 35.27 | 54.00 | -18.73 | 29.96 | 3 | Horizontal | 183 | 2.87 | - | 33.43 | 7.21 | 35.33 |

2.4-2.4835GHz_Thread_3MHz_Nss1_1TX

2440MHz_TX

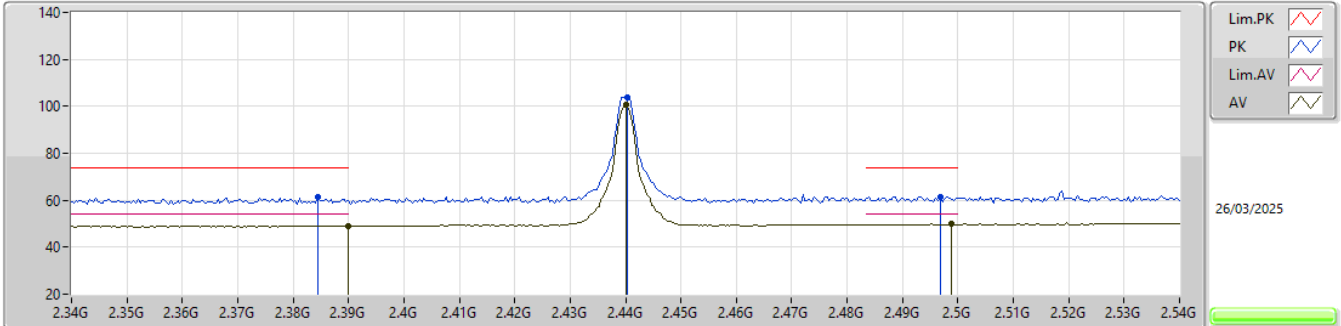

EUTZ_1TX
Setting 6
03-P-J-10

| Type | Freq (Hz) | Level (dBuV/m) | Limit (dBuV/m) | Margin (dB) | Raw (dBuV) | Dist (m) | Condition | Azimuth (°) | Height (m) | Comment | AF (dB) | CL (dB) | PA (dB) |
|------|-----------|----------------|----------------|-------------|------------|----------|-----------|-------------|------------|---------|---------|---------|---------|
| PK | 2.3844G | 61.36 | 74.00 | -12.64 | 28.22 | 3 | Vertical | 288 | 1.29 | - | 28.34 | 4.80 | - |
| AV | 2.39G | 49.22 | 54.00 | -4.78 | 16.01 | 3 | Vertical | 288 | 1.29 | - | 28.40 | 4.81 | - |
| PK | 2.4404G | 103.99 | Inf | -Inf | 70.73 | 3 | Vertical | 288 | 1.29 | - | 28.40 | 4.86 | - |
| AV | 2.44G | 100.65 | Inf | -Inf | 67.39 | 3 | Vertical | 288 | 1.29 | - | 28.40 | 4.86 | - |
| PK | 2.4968G | 61.62 | 74.00 | -12.38 | 28.22 | 3 | Vertical | 288 | 1.29 | - | 28.47 | 4.93 | - |
| AV | 2.4988G | 49.80 | 54.00 | -4.20 | 16.38 | 3 | Vertical | 288 | 1.29 | - | 28.49 | 4.93 | - |

2.4-2.4835GHz_Thread_3MHz_Nss1_1TX

2440MHz_TX

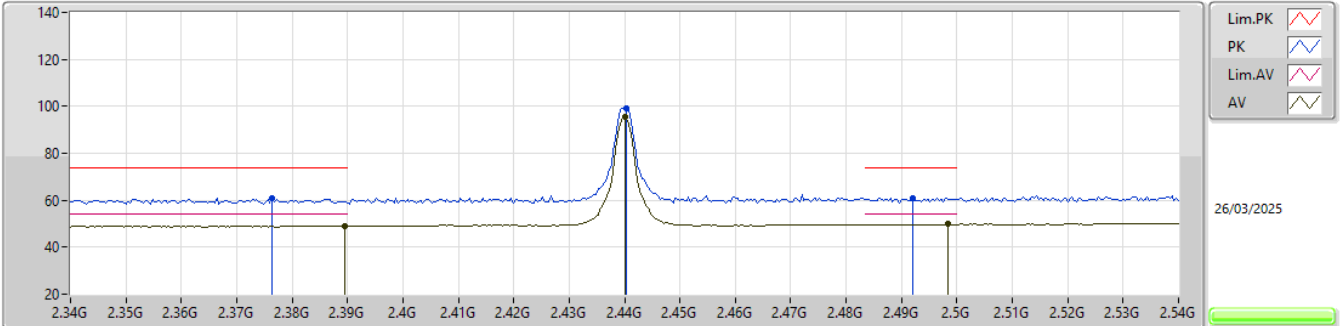

EUT_Z_1TX
Setting 6
03-P-J-10

| Type | Freq (Hz) | Level (dBuV/m) | Limit (dBuV/m) | Margin (dB) | Raw (dBuV) | Dist (m) | Condition | Azimuth (°) | Height (m) | Comment | AF (dB) | CL (dB) | PA (dB) |
|------|-----------|----------------|----------------|-------------|------------|----------|------------|-------------|------------|---------|---------|---------|---------|
| PK | 2.3764G | 61.11 | 74.00 | -12.89 | 28.02 | 3 | Horizontal | 33 | 1.37 | - | 28.30 | 4.79 | - |
| AV | 2.3896G | 49.22 | 54.00 | -4.78 | 16.01 | 3 | Horizontal | 33 | 1.37 | - | 28.40 | 4.81 | - |
| PK | 2.4404G | 99.02 | Inf | -Inf | 65.76 | 3 | Horizontal | 33 | 1.37 | - | 28.40 | 4.86 | - |
| AV | 2.44G | 95.68 | Inf | -Inf | 62.42 | 3 | Horizontal | 33 | 1.37 | - | 28.40 | 4.86 | - |
| PK | 2.492G | 61.04 | 74.00 | -12.96 | 27.70 | 3 | Horizontal | 33 | 1.37 | - | 28.42 | 4.92 | - |
| AV | 2.4984G | 49.79 | 54.00 | -4.21 | 16.38 | 3 | Horizontal | 33 | 1.37 | - | 28.48 | 4.93 | - |

2.4-2.4835GHz_Thread_3MHz_Nss1_1TX

2440MHz_TX

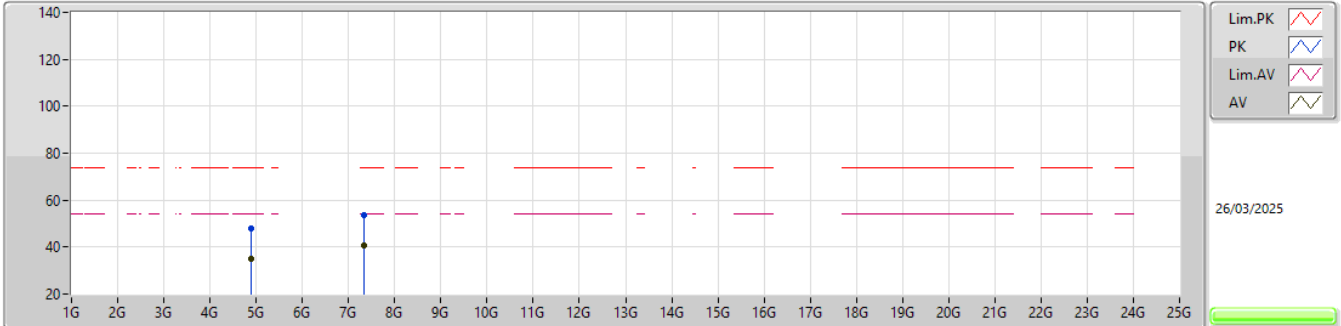

EUT_Z_1TX
Setting 6
03-P-J-10

| Type | Freq (Hz) | Level (dBuV/m) | Limit (dBuV/m) | Margin (dB) | Raw (dBuV) | Dist (m) | Condition | Azimuth (°) | Height (m) | Comment | AF (dB) | CL (dB) | PA (dB) |
|------|-----------|----------------|----------------|-------------|------------|----------|-----------|-------------|------------|---------|---------|---------|---------|
| PK | 4.8812G | 47.96 | 74.00 | -26.04 | 42.55 | 3 | Vertical | 147 | 2.69 | - | 33.56 | 7.18 | 35.33 |
| AV | 4.87752G | 35.20 | 54.00 | -18.80 | 29.79 | 3 | Vertical | 147 | 2.69 | - | 33.56 | 7.18 | 35.33 |
| PK | 7.32468G | 53.47 | 74.00 | -20.53 | 43.16 | 3 | Vertical | 232 | 2.03 | - | 36.85 | 8.62 | 35.16 |
| AV | 7.3243G | 40.44 | 54.00 | -13.56 | 30.13 | 3 | Vertical | 232 | 2.03 | - | 36.85 | 8.62 | 35.16 |

2.4-2.4835GHz_Thread_3MHz_Nss1_1TX

2440MHz_TX

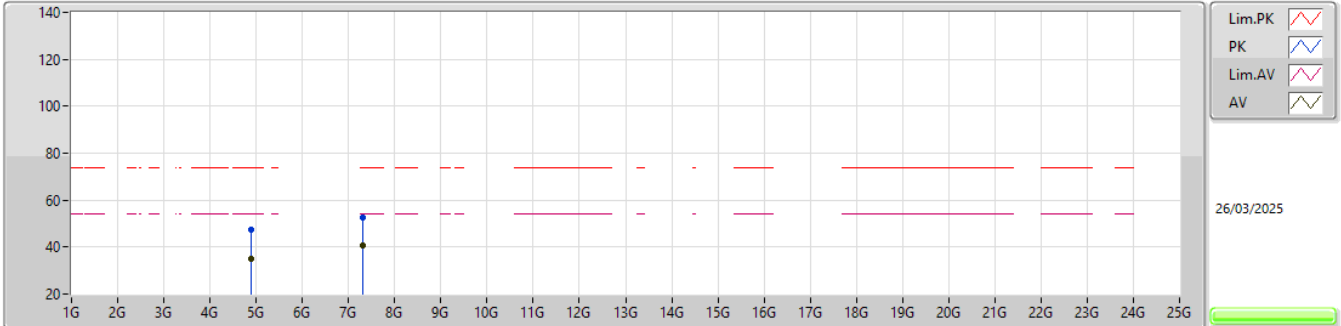

EUT_Z_1TX
Setting 6
03-P-J-10

| Type | Freq (Hz) | Level (dBuV/m) | Limit (dBuV/m) | Margin (dB) | Raw (dBuV) | Dist (m) | Condition | Azimuth (°) | Height (m) | Comment | AF (dB) | CL (dB) | PA (dB) |
|------|--------------|-------------------|-------------------|----------------|---------------|-------------|------------|----------------|---------------|---------|------------|------------|------------|
| PK | 4.87804G | 47.28 | 74.00 | -26.72 | 41.87 | 3 | Horizontal | 285 | 2.11 | - | 33.56 | 7.18 | 35.33 |
| AV | 4.87762G | 35.20 | 54.00 | -18.80 | 29.79 | 3 | Horizontal | 285 | 2.11 | - | 33.56 | 7.18 | 35.33 |
| PK | 7.31818G | 52.66 | 74.00 | -21.34 | 42.36 | 3 | Horizontal | 222 | 2.65 | - | 36.84 | 8.62 | 35.16 |
| AV | 7.32126G | 40.47 | 54.00 | -13.53 | 30.17 | 3 | Horizontal | 222 | 2.65 | - | 36.84 | 8.62 | 35.16 |

2.4-2.4835GHz_Thread_3MHz_Nss1_1TX

2475MHz_TX

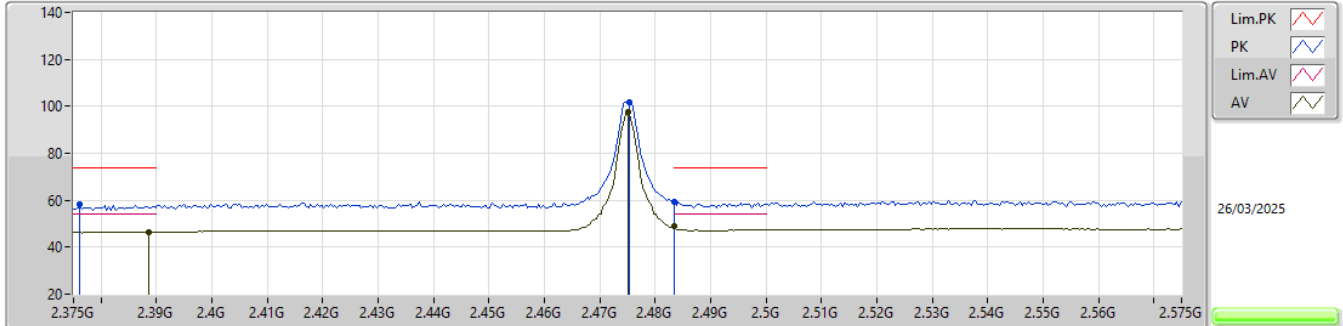

EUTZ_1TX
Setting 6
01-C-E-6

| Type | Freq (Hz) | Level (dBuV/m) | Limit (dBuV/m) | Margin (dB) | Raw (dBuV) | Dist (m) | Condition | Azimuth (°) | Height (m) | Comment | AF (dB) | CL (dB) | PA (dB) |
|------|-----------|----------------|----------------|-------------|------------|----------|-----------|-------------|------------|---------|---------|---------|---------|
| PK | 2.3762G | 58.12 | 74.00 | -15.88 | 27.06 | 3 | Vertical | 261 | 1.58 | - | 27.34 | 3.72 | - |
| AV | 2.3886G | 46.40 | 54.00 | -7.60 | 15.29 | 3 | Vertical | 261 | 1.58 | - | 27.39 | 3.72 | - |
| PK | 2.4754G | 101.95 | Inf | -Inf | 70.40 | 3 | Vertical | 261 | 1.58 | - | 27.75 | 3.80 | - |
| AV | 2.475G | 97.60 | Inf | -Inf | 66.05 | 3 | Vertical | 261 | 1.58 | - | 27.75 | 3.80 | - |
| PK | 2.4835G | 59.36 | 74.00 | -14.64 | 27.71 | 3 | Vertical | 261 | 1.58 | - | 27.84 | 3.81 | - |
| AV | 2.4835G | 49.00 | 54.00 | -5.00 | 17.35 | 3 | Vertical | 261 | 1.58 | - | 27.84 | 3.81 | - |

2.4-2.4835GHz_Thread_3MHz_Nss1_1TX

2475MHz_TX

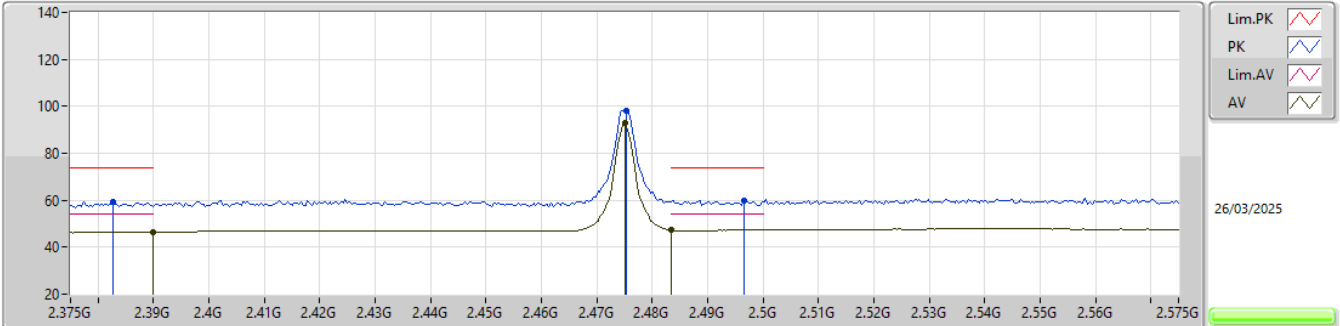

EUTZ_1TX
Setting 6
01-C-E-6

| Type | Freq (Hz) | Level (dBuV/m) | Limit (dBuV/m) | Margin (dB) | Raw (dBuV) | Dist (m) | Condition | Azimuth (°) | Height (m) | Comment | AF (dB) | CL (dB) | PA (dB) |
|------|-----------|----------------|----------------|-------------|------------|----------|------------|-------------|------------|---------|---------|---------|---------|
| PK | 2.3826G | 59.20 | 74.00 | -14.80 | 28.15 | 3 | Horizontal | 251 | 1.80 | - | 27.33 | 3.72 | - |
| AV | 2.3898G | 46.47 | 54.00 | -7.53 | 15.35 | 3 | Horizontal | 251 | 1.80 | - | 27.40 | 3.72 | - |
| PK | 2.4754G | 98.04 | Inf | -Inf | 66.49 | 3 | Horizontal | 251 | 1.80 | - | 27.75 | 3.80 | - |
| AV | 2.475G | 92.69 | Inf | -Inf | 61.14 | 3 | Horizontal | 251 | 1.80 | - | 27.75 | 3.80 | - |
| PK | 2.4966G | 59.93 | 74.00 | -14.07 | 28.13 | 3 | Horizontal | 251 | 1.80 | - | 27.97 | 3.83 | - |
| AV | 2.4835G | 47.30 | 54.00 | -6.70 | 15.65 | 3 | Horizontal | 251 | 1.80 | - | 27.84 | 3.81 | - |

2.4-2.4835GHz_Thread_3MHz_Nss1_1TX

2480MHz_TX

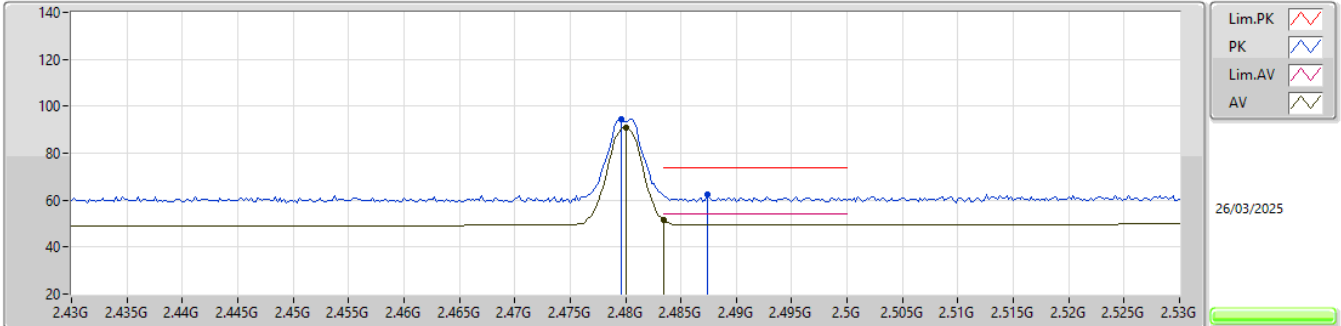

EUT_Z_1TX
Setting 0
03-P-J-10

| Type | Freq (Hz) | Level (dBuV/m) | Limit (dBuV/m) | Margin (dB) | Raw (dBuV) | Dist (m) | Condition | Azimuth (°) | Height (m) | Comment | AF (dB) | CL (dB) | PA (dB) |
|------|-----------|----------------|----------------|-------------|------------|----------|-----------|-------------|------------|---------|---------|---------|---------|
| PK | 2.4796G | 94.42 | Inf | -Inf | 61.11 | 3 | Vertical | 274 | 1.88 | - | 28.40 | 4.91 | - |
| AV | 2.48G | 91.06 | Inf | -Inf | 57.75 | 3 | Vertical | 274 | 1.88 | - | 28.40 | 4.91 | - |
| PK | 2.4874G | 62.23 | 74.00 | -11.77 | 28.91 | 3 | Vertical | 274 | 1.88 | - | 28.40 | 4.92 | - |
| AV | 2.4835G | 51.40 | 54.00 | -2.60 | 18.09 | 3 | Vertical | 274 | 1.88 | - | 28.40 | 4.91 | - |

2.4-2.4835GHz_Thread_3MHz_Nss1_1TX

2480MHz_TX

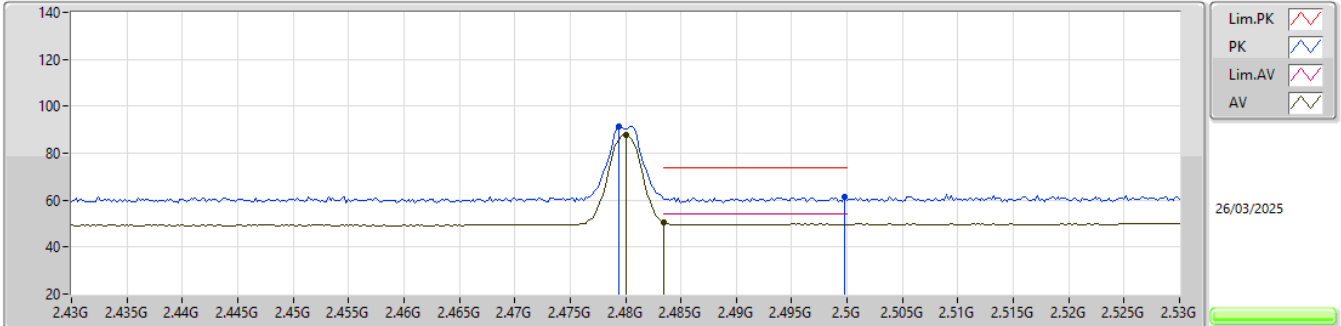

EUT_Z_1TX
Setting 0
03-P-J-10

| Type | Freq (Hz) | Level (dBuV/m) | Limit (dBuV/m) | Margin (dB) | Raw (dBuV) | Dist (m) | Condition | Azimuth (°) | Height (m) | Comment | AF (dB) | CL (dB) | PA (dB) |
|------|-----------|----------------|----------------|-------------|------------|----------|------------|-------------|------------|---------|---------|---------|---------|
| PK | 2.4794G | 91.37 | Inf | -Inf | 58.06 | 3 | Horizontal | 303 | 1.79 | - | 28.40 | 4.91 | - |
| AV | 2.48G | 87.96 | Inf | -Inf | 54.65 | 3 | Horizontal | 303 | 1.79 | - | 28.40 | 4.91 | - |
| PK | 2.4998G | 61.15 | 74.00 | -12.85 | 27.72 | 3 | Horizontal | 303 | 1.79 | - | 28.50 | 4.93 | - |
| AV | 2.4835G | 50.57 | 54.00 | -3.43 | 17.26 | 3 | Horizontal | 303 | 1.79 | - | 28.40 | 4.91 | - |

2.4-2.4835GHz_Thread_3MHz_Nss1_1TX

2480MHz_TX

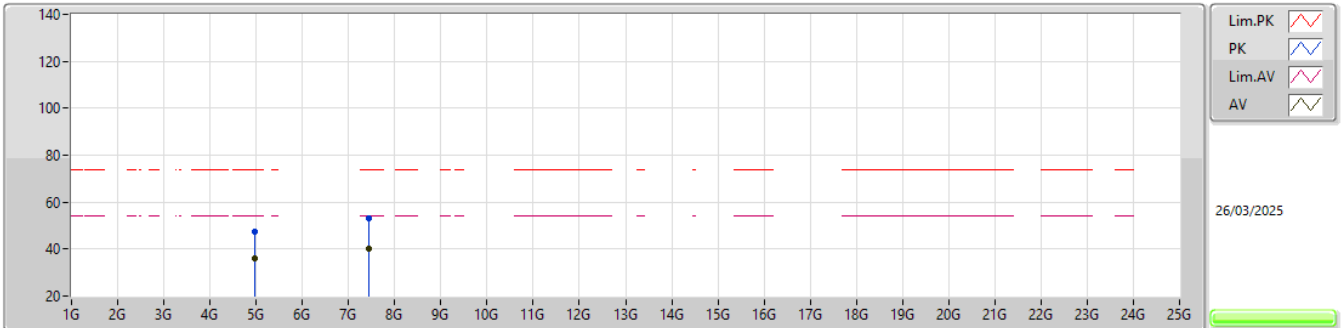

EUT_Z_1TX
Setting 0
03-P-J-10

| Type | Freq (Hz) | Level (dBuV/m) | Limit (dBuV/m) | Margin (dB) | Raw (dBuV) | Dist (m) | Condition | Azimuth (°) | Height (m) | Comment | AF (dB) | CL (dB) | PA (dB) |
|------|-----------|----------------|----------------|-------------|------------|----------|-----------|-------------|------------|---------|---------|---------|---------|
| PK | 4.96714G | 47.58 | 74.00 | -26.42 | 42.13 | 3 | Vertical | 193 | 2.56 | - | 33.63 | 7.15 | 35.33 |
| AV | 4.96084G | 36.23 | 54.00 | -17.77 | 30.79 | 3 | Vertical | 193 | 2.56 | - | 33.62 | 7.15 | 35.33 |
| PK | 7.44232G | 53.04 | 74.00 | -20.96 | 42.48 | 3 | Vertical | 166 | 2.43 | - | 37.00 | 8.73 | 35.17 |
| AV | 7.45308G | 40.35 | 54.00 | -13.65 | 29.79 | 3 | Vertical | 360 | 1.80 | - | 36.99 | 8.74 | 35.17 |

2.4-2.4835GHz_Thread_3MHz_Nss1_1TX

2480MHz_TX

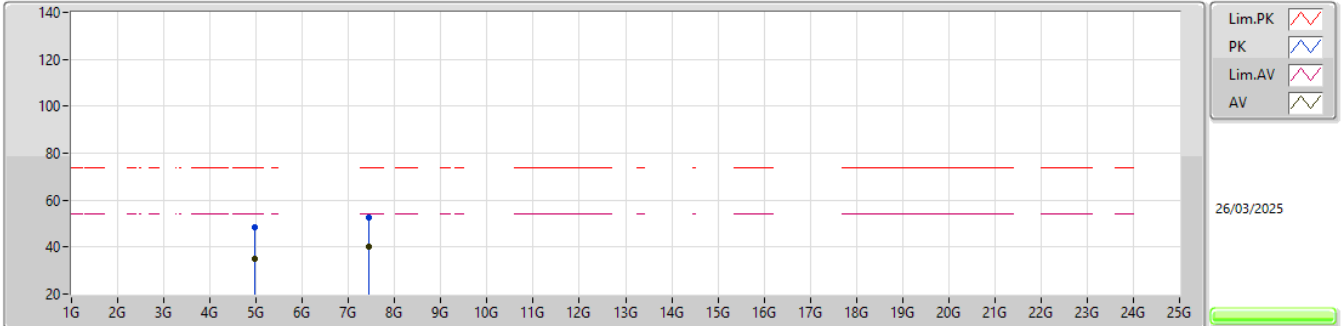

EUTZ_1TX
Setting 0
03-P-J-10

| Type | Freq (Hz) | Level (dBuV/m) | Limit (dBuV/m) | Margin (dB) | Raw (dBuV) | Dist (m) | Condition | Azimuth (°) | Height (m) | Comment | AF (dB) | CL (dB) | PA (dB) |
|------|-----------|----------------|----------------|-------------|------------|----------|------------|-------------|------------|---------|---------|---------|---------|
| PK | 4.957G | 48.19 | 74.00 | -25.81 | 42.75 | 3 | Horizontal | 312 | 2.05 | - | 33.61 | 7.16 | 35.33 |
| AV | 4.96226G | 35.18 | 54.00 | -18.82 | 29.74 | 3 | Horizontal | 312 | 2.05 | - | 33.62 | 7.15 | 35.33 |
| PK | 7.44172G | 52.79 | 74.00 | -21.21 | 42.24 | 3 | Horizontal | 152 | 2.02 | - | 37.00 | 8.72 | 35.17 |
| AV | 7.43846G | 40.37 | 54.00 | -13.63 | 29.82 | 3 | Horizontal | 152 | 2.02 | - | 37.00 | 8.72 | 35.17 |