

Test Report for FCC & IC

Report Number		ESTRGC2309-006		
Applicant	Company name	Suprema Inc		
	Address	17F-5, Parkview office tower, 248, Jeongjail-ro Bundang-gu, Seongnam-si, Gyeonggi-do South Korea		
	Telephone	+82-031-240-4333		
Product	Product name	Biostation 2a		
	Model No.	BS2A-OAPWB	Manufacturer	Suprema Inc
	Serial No.	NONE	Country of origin	KOREA
Test date	13-Sep-23 ~ 22-Sep-23		Date of issue	30-Sep-23
Testing location	140-16, Eongmalli-ro, Majang-myeon, Icheon-si, Gyeonggi-do, Rep. of Korea			
FCC ID	TKWBS2A-OAPWB			
ISED ID	23080-BS2AOAPWB			
FCC Rule Part(s)	FCC PART 15 Subpart C (15.247), ANSI C 63.10(2013)			
ISED Rule Part(s)	RSS-247 (2017)			
Test result				Complied
Measurement facility registration number		FCC:659627		
Measurement facility registration number		ISED:4475A		
Tested by	Engineer H.G. Lee			(Signature)
Reviewed by	Engineering Manager I.K. Hong			(Signature)
Abbreviation	OK, Pass = Complied, Fail = Failed, N/A = not applicable			
<p>* Note</p> <ul style="list-style-type: none"> - This test report is not permitted to copy partly without our permission - This test result is dependent on only equipment to be used - This test report is not related to KOLAS accreditation - Additional models name: BS2A-ODPB(Delete wifi module) 				

Contents

1. Laboratory Information	3
1.1 General	3
2. Description of EUT	4
3. Test Standards	5
4. Measurement Condition	8
5. OPERATIONAL DESCRIPTION	11
6. TEST METHODOLOGY	11
6.1 Conducted Spurious Emission Test on AC Power Line	11
6.2 Radiated Emission Test	11
7 TEST RESULTS FOR BLUETOOTH LOW ENERGY	12
7.1 Maximum Peak Conducted Output Power	12
7.2 Maximum Power Spectral Density	15
7.3 DTS Bandwidth & 99% Bandwidth	17
7.4 Emissions in non-restricted frequency bands and Conducted Spurious Emission.....	20
7.5 Spurious Radiated Emissions & Restricted Bands of Operation.....	24
8 Conducted Spurious Emission on AC Power lines	37

1. Laboratory Information

1.1 General

This EUT (Equipment Under Test) has been shown to be capable of compliance with the applicable technical standards and is tested in accordance with the measurement procedures as indicated in this report. ESTECH Lab attests to accuracy of test data. All measurement reported herein were performed by ESTECH Co., Ltd. ESTECH Lab assume full responsibility for the completeness of these measurements and vouch for the qualifications of all persons taking them.

1.2 Test Lab.

Corporation Name : ESTECH Co., Ltd.

Head Office : Suite 1015 World Meridian II, 123 Gasan Digital 2-ro, Geumcheon-gu,
Seoul 153-759, R. O. Korea

EMC/Telecom/Safety Test Lab : 140-16, Eongmalli-ro, Majang-myeon, Icheon-si,
Gyeonggi-do, Rep. of Korea

1.3 Official Qualification(s)

MSIP : Granted Accreditation from Ministry of Information & Communication for EMC, Safety and Telecommunication

KOLAS : Accredited Lab By Korea Laboratory Accreditation Schema base on CENELEC

FCC : Filed Laboratory at Federal Communications Commission

VCCI : Granted Accreditation from Voluntary Control Council for Interference from ITE

ISED : Accredited Lab By Canada Laboratory Accreditation

2. Description of EUT

2.1 Summary of Equipment Under Test

Product : Biostation 2a
 Model Number : BSA2-OAPWB
 Serial Number : NONE
 Manufacturer : Suprema Inc
 Transfer Rate : BLE
 Channel Spacing : 1 MHz
 PEAK Output Power : -0.89 dBm, 0.81 mW
 Power Rating : INPUT: AC(100 - 240) V, (50-60)Hz, 1.7 A
 OUTPUT: DC 24 V, 2.5 A
 Receipt Date : 2023-Aug-28

X-tal list(s) or Frequencies generated : The highest operating frequency is 2480 MHz(Bluetooth)
 Bluetooth : 2.4 GHz

Software version:V01
 Hardware version:V1.0.0

2.2 General descriptions of EUT

General Characteristics	CPU / RAM / ROM	Hexa core CPU (Cortex A72 Dual-core 1.8GHz, Cortex A53 Quad core 1.4Ghz)
	RAM / ROM	4GB RAM / 32GB ROM
	OS	Android 11
	Dimensions	139mm/5.47inch(W) x 230mm/2.87inch(H) x 28(22)mm, 1.10/(0.86)inch : (D)(Minimum Thickness)
	Weight	320g/11.3oz with 4,000mA battery
	Buttons	5 front buttons / 5 side buttons
	Battery / Backup battery	Standard : 1860mAh Li-Ion / Extended : 4000mAh Li-Ion / NFC, IC Card Battery : 2860mAh Li-Ion Backup battery : 200mAh Li-Polymer
	Audio / LED / Sensor	Audio : Speaker, Receiver, Mic / LED : 1 charging status Sensor : Acceleration, Compass, Proximity, Ambient Light Sensor
	Display / Touch	4.3 Inch, WVGA(480x800) / Capacitive, multi touch, Gorilla glass 3
	Expansion Slot / SAM	Micro SDXC / 2 SAM Slot
	Communication	USB Host/Client : USB2.0 High Speed, External Serial RS232C, RJ45 Port (Use 1Slot/4Slot Cradle)
	Power	DC Jack 5V / 3.5A Adaptor

3. Test Standards

Test Standard : FCC PART 15 Subpart C (15.247)

This Standard sets out the regulations under which an intentional, unintentional, or incidental radiator may be operated without an individual license. It also contains the technical specifications, administrative requirements and other conditions relating to the marketing of Part 15 devices.

Test Standard : RSS-247

RSS-Gen must be used in conjunction with other RSSs, as applicable to the specific type of radio apparatus, for assessing its compliance with ISED requirements.

Test Method : ANSI C 63.10 (2013)

This standard sets forth uniform methods of measurement of radio-frequency (RF) signals and noise emitted from both unintentional and intentional emitters of RF energy in the frequency range 9 kHz to 40 GHz. Methods for the measurement of radiated and AC power-line conducted radio noise are covered and may be applied to any such equipment unless otherwise specified by individual equipment requirements. These methods cover measurement of certain devices that deliberately radiate energy, such as intentional emitters, but does not cover licensed transmitters. This standard is not intended for certification/approval of avionic equipment or for industrial, scientific, and medical (ISM) equipment. These methods apply to the measurement of individual units or systems comprised of multiple units.

BT Basic Data Rate / Enhanced Data Rate

Test Description	FCC Part Section(s)	ISED Part Section(s)	Test Result
Maximum conducted output power	15.247 (b)(3)	RSS 247 Issue 2, Section 5.4 (d)	Pass
Maximum Power Spectral Density	15.247(e)	RSS 247 Issue 2, Section 5.2 (b)	Pass
DTS Bandwidth	15.247(a)(2)	RSS 247 Issue 2, Section 5.2 (a)	Pass
Emissions in non-restricted frequency bands	15.247(d)	RSS 247 Issue 2, Section 5.5	Pass
Conducted Spurious Emission on AC Power lines	15.207	RSS-Gen Issue 5, Section 8.9 /8.10	Pass

Notes:

1). No tests were applied because the fundamental level did not exceed the spurious limit per part 15.209.

30 MHz - 1 GHz

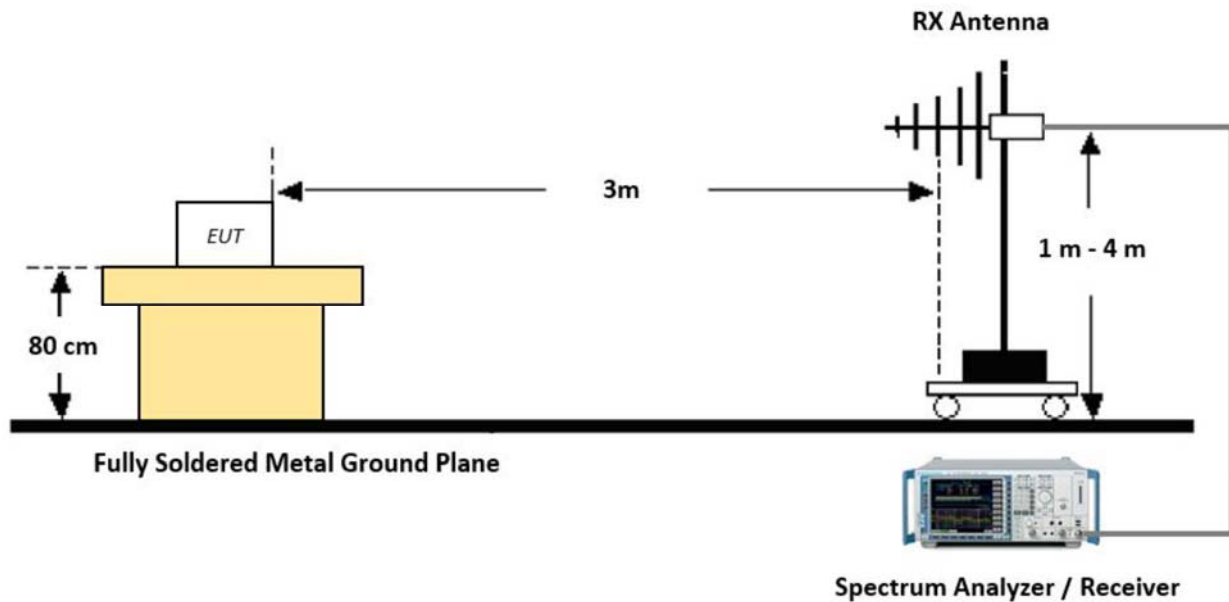

Test Procedure of Radiated spurious emissions (Below 1GHz)

1. The EUT was placed on a non-conductive table located on semi-anechoic chamber.
2. The EUT is placed on a turntable, which is 0.8m above ground plane.
3. We have done x, y, z planes in EUT and horizontal and vertical polarization in detecting antenna.
4. The turntable shall be rotated for 360 degrees to determine the position of maximum emission level.

5. Spectrum Setting

(1) Measurement Type (Peak):

- Measured Frequency Range: 30 MHz – 1 GHz
- Detector = Peak
- Trace = Max hold
- RBW = 100 kHz
- VBW $\geq 3 \times$ RBW

(2) Measurement Type(Quasi-peak):

- Measured Frequency Range: 30 MHz – 1 GHz
- Detector = Quasi-Peak
- RBW = 120 kHz

In general, the method (1) is mainly used

6. Total = Reading Value + Antenna Factor (A.F) + Cable Loss (C.L)

1 GHz – 26.5 GHz

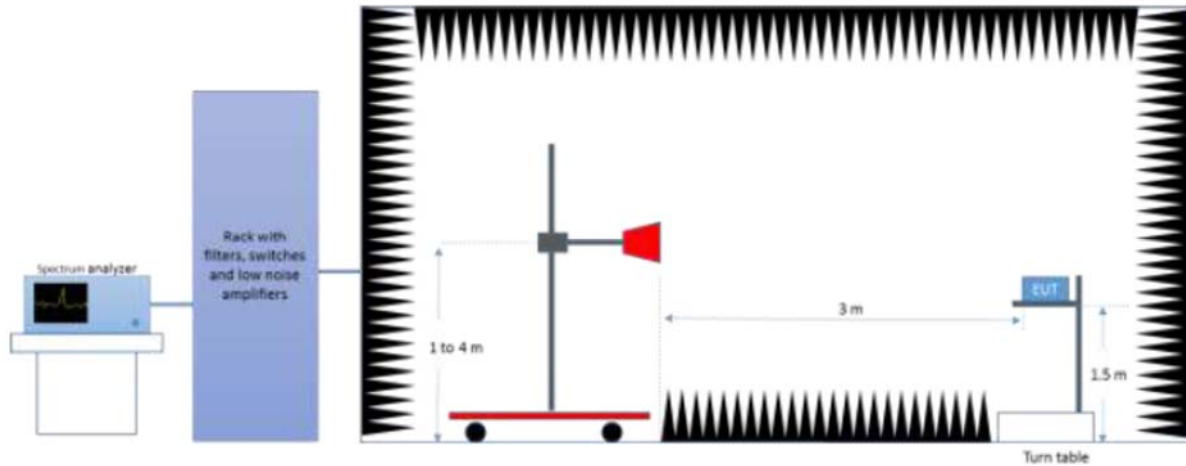

Test Procedure of Radiated spurious emissions (Above 1GHz)

1. The EUT was placed on a non-conductive table located on semi-anechoic chamber.
2. The EUT is placed on a turntable, which is 0.8m above ground plane.
3. We have done x, y, z planes in EUT and horizontal and vertical polarization in detecting antenna.
4. The turntable shall be rotated for 360 degrees to determine the position of maximum emission level.
5. Spectrum Setting

(1) Measurement Type (Peak):

- Measured Frequency Range: 1 GHz – 26.5 GHz
- Detector = Peak
- Trace = Max hold
- RBW = 1 MHz
- VBW $\geq 3 \times$ RBW

(2) Measurement Type(Average):

- Measured Frequency Range: 1 GHz – 26.5 GHz
- Detector = average or rms
- RBW = 1 MHz

In general, the method (1) is mainly used

6. Total = Reading Value + Antenna Factor (A.F) + Cable Loss (C.L)

4. Measurement Condition

4.1 EUT Operation.

- * The EUT was in the following operation mode during all testing
- * The operational conditions of the EUT was determined by the manufacturer according to emission
- * Execute a RF test program to enable EUT under transmission/receiving condition continuously at specific channel frequency.
- * Transmit mode was each test. Each channel (low, middle, high), also set the test after
- * The EUT was measured up to tenth harmonic or 40 GHz of the highest operating frequencies.

4.2 Configuration and Peripherals

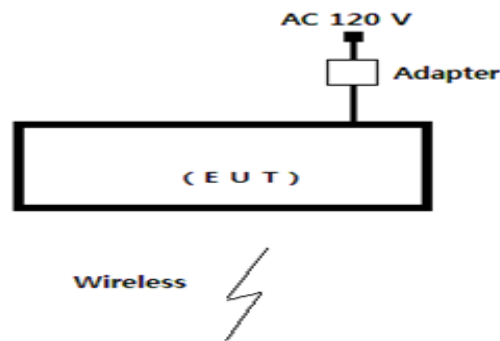

4.3 EUT and Support equipment

Equipment Name	Model Name	S/N	Manufacturer	Remark
Biostation 2a	BS2A-OAPBW	NONE	Suprema Inc	EUT
Adapter	KPL-060M-VI	NONE	Channel Well technology (Guangzhou)Co.,Ltd.	
Notebook	NT550XEZ	NONE	Samsung Electronics Vieteam Co.,Ltd.	
Adapter	EP-TA845 001	NONE	Solum Vina Company Limited	

4.4 List of frequencies

Frequency Band (MHz)	Channel No.	Channel Frequency (MHz)
BLE (2400 – 2483.5)	0	2402
	1	2404
	2	2406
	:	:
	:	:
	18	2438
	19	2440
	20	2442
	:	:
	:	:
	37	2476
	38	2478
	39	2480

List of BLE center Frequencies

4.5 Measurement equipments (Conducted)

Description	Model	Serial Number	Cal. Date	Cal. Due Date
Spectrum Analyzer	E440A	US42041291	28-Nov-22	28-Nov-23
Spectrum Analyzer	FSV40	100939	28-Nov-22	28-Nov-23
Power meter	N1912A	MY45100570	28-Nov-22	28-Nov-23
Power sensor	A1921A	MY45240427	28-Nov-22	28-Nov-23
RF Cable	Length: 100 cm	-		

4.6 Measurement equipments(Radiated setup)

Equipment Name	Type	Manufacturer	Serial No.	Cal. Date	Cal. Due Date
TEST Receiver	ESCI7	ROHDE & SCHWARZ	100916	12-Jun-23	12-Jun-24
LOOP Antenna	HFH2-Z2	ROHDE & SCHWARZ	100188	29-Aug-22	29-Aug-24
Logbicon Antenna	VULB 9168	SCHWARZBECK	193	09-Dec-21	09-Dec-23
Turn Table	DT3000-2t	Innco System GmbH	N/A	-	-
Antenna Mast	MA4000-EP	Innco System GmbH	N/A	-	-
PREAMPLIFIER	8449B	HP	3008A00581	12-Jun-23	12-Jun-24
Horn Antenna	LB-42-15-C-SF	A-INFOMF	J2020079000055	11-Nov-22	11-Nov-23
Horn Antenna	BBHA9120D	SCHWARZBECK	469	08-Nov-22	08-Nov-23
TEST Receiver	ESU	ROHDE & SCHWARZ	100529	12-Jun-23	12-Jun-24
Turn Table	DT1500-S	Innco System GmbH	N/A	-	-
Antenna Mast	MA4000-EP	Innco System GmbH	N/A	-	-
Antenna Master & Turn table controller	CO2000-P	Innco System GmbH	CO2000/642 /28051111/L	-	-

4.7 Conducted Spurious Emission on AC Power lines Measurement equipments

Equipment Name	Type	Manufacturer	Serial No.	Cal. Date	Cal. Due Date
TEST Receiver	ESHS 30	Rohde & Schwarz	828765/002	28-Jun-23	28-Jun-24
LISN	ESH2-Z5	Rohde & Schwarz	836679/025	28-Jun-23	28-Jun-24
Pulse Limiter	ESH3-Z2	Rohde & Schwarz	NONE	28-Jun-23	28-Jun-24

5. OPERATIONAL DESCRIPTION

Vscan Air SL is a handheld, pocket sized, battery powered general purpose diagnostic ultrasound system. The system consists of a probe with two heads. One for deep scanning (Sector) and another one for shallow scanning (Linear). The probe can be paired with a mobile device through WiFi, to see the ultrasound image. Mobile device needs an app (available in iOS & android) to enable pairing and ultrasound imaging. The internal battery operation is designed for providing approximately one hour of active scanning capacity with a fully charged battery. The probe supports Qi wireless charging to charge the battery. Probe will automatically turn off during charging.

6. TEST METHODOLOGY

6.1 Conducted Spurious Emission Test on AC Power Line

Measured levels of ac power-line conducted emission across the 50 Ω LISN port (to which the EUT is connected). All emission voltage and current measurements shall be made on each current-carrying conductor at the plug end of the EUT power cord by the use of mating plugs and receptacles on the LISN, if used. Equipment shall be tested with power cords that are normally supplied or recommended by the manufacturer and that have electrical and shielding characteristics that are the same as those cords normally supplied or recommended by the manufacturer. The device is placed on the test table, raised 80cm above the reference ground plane. The vertical conducting plane is located 40cm to the rear of the device. AC Conducted emission measurement is made over frequency range from 150kHz to 30MHz, this measurement was performed with EUT powered by 2 methods and both method are tested individually, one with an AC adaptor with 110V AC 60Hz supply and second with Wireless charger with supply 110V AC 60Hz.

6.2 Radiated Emission Test

The radiated emission measurement was performed according to the procedures in ANSI C63.10-2013. The equipment under test (EUT) was placed at the middle of the 80 cm high turntable for below 1 GHz & 1.5 m height for above 1 GHz measurement, and the EUT is 3 meters far from the measuring antenna. The turntable was rotated 360° for obtaining the maximum emission. The height of the measuring antennas was scanned between 1 m and 4 m, and the antenna rotated to repeat the measurements for both the horizontal and vertical antenna polarizations. Repeat the measurement steps until the maximum emissions were obtained. The measurement above 1000 MHz was performed by horn antenna, The measurement below 30 MHz was performed by loop antenna, Measurement from 30 MHz to 200 MHz was performed by Baloon and Biconical Antenna, and measurement from 200 MHz to 1 GHz was performed by Log-Periodic Antenna. The EUT was rotated around the X-, Y-, and Z-Axis and the results from worst case axis are recorded

7 TEST RESULTS FOR BLUETOOTH LOW ENERGY

7.1 Maximum Peak Conducted Output Power

Result	Pass
Test Specification	FCC part 15 Subpart C 15.247 (b)(3) / RSS 247 Issue 2, Section 5.4 (d)
Test Method	Subclause 11.9.1.1 of ANSI C63.10
Measurement Bandwidth	1MHz
Detector	Peak
Port of testing	Antenna port
Requirement	Power \leq 1 W (30 dBm) & e.i.r.p \leq 4 W (36 dBm)

Test Method:

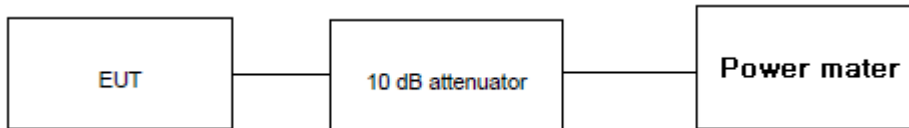

Test Condition

Normal Test Condition:

Temperature (Norm) = + 22.3 °C	Voltage =24.0 V Adapter	Relative humidity: 58%
--------------------------------	-------------------------	------------------------

KDB Guidelines applied:

Measurements were made as per section 8.3.1 in KDB 558074.00 D01 15.247 Measurement Guidance v05r02.

Test results:

Note:

1. All the losses are included during measurement and final values are mentioned in the test report.
2. Peak Output power (dBm) = Measured peak power (dBm) + Attenuator factor (10dB) + Cable loss (1.0dB)
3. This product do not support additional beamforming gain / directional gain, it uses signal antenna and hence directional gain of the single antenna is 2.12 dBi

Test data

Data Rate	Channel Frequency (MHz)	Measured Peak Power (dBm)	Measured Peak Power (mW)	e.i.r.p (dBm)	Power Limit (dBm)	e.i.r.p Limit (dBm)
1 Mbps	2402	-1.05	0.79	1.07	30	36
	2440	-0.90	0.81	1.22	30	36
	2480	-0.89	0.81	1.23	30	36

Data Rate	Channel Frequency (MHz)	Measured Average Power (dBm)	Measured Average Power (mW)	e.i.r.p (dBm)	Power Limit (dBm)	e.i.r.p Limit (dBm)
1 Mbps	2402	-9.41	0.11	-7.29	30	36
	2440	-9.15	0.12	-7.03	30	36
	2480	-9.11	0.12	-6.99	30	36

Test plot

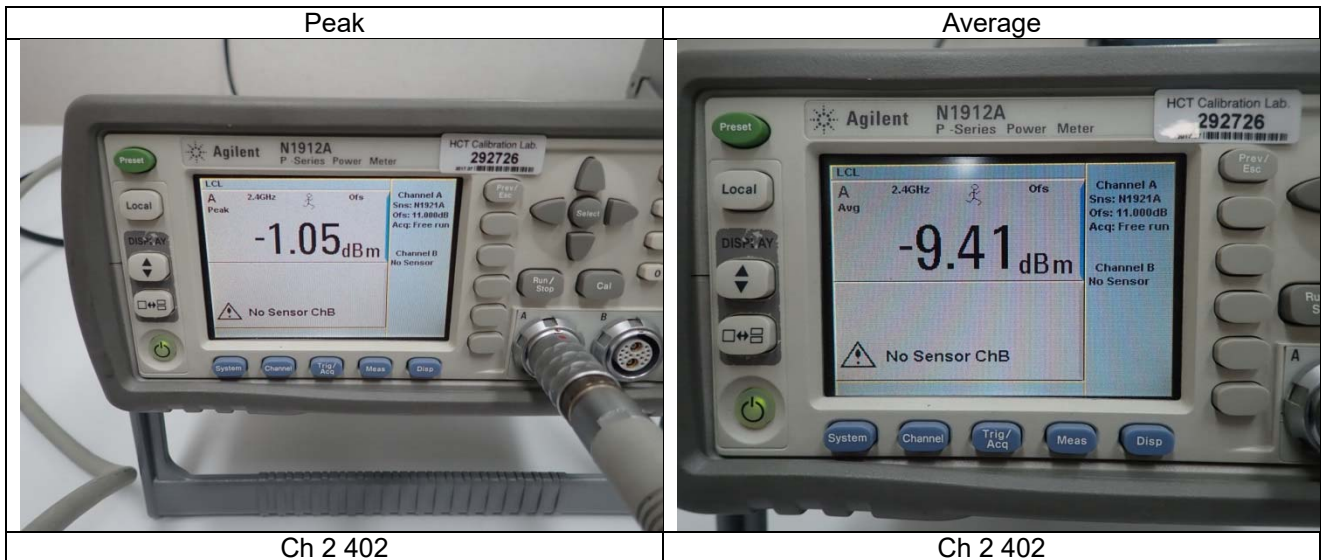



Ch 2 440



Ch 2 440

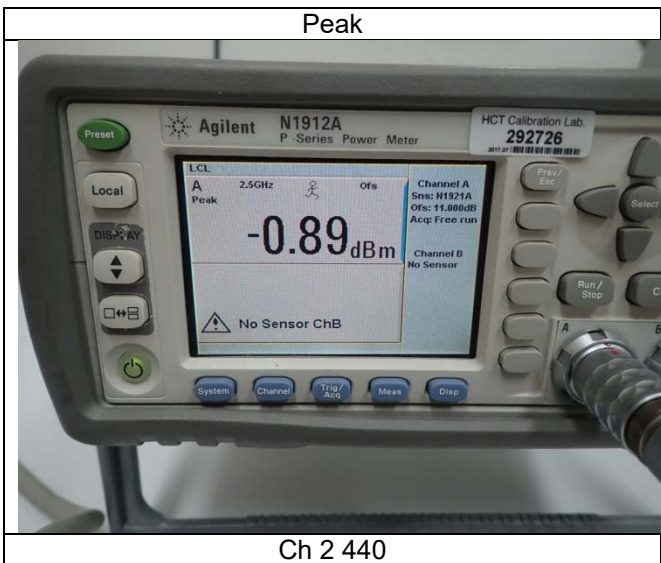

Ch 2 440

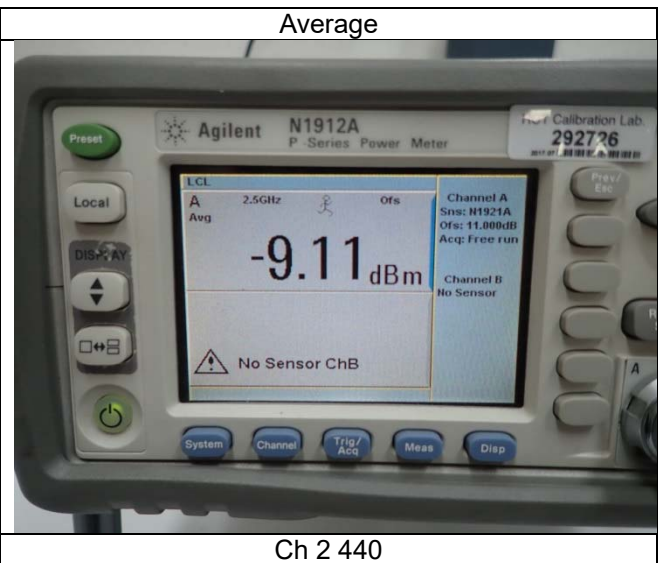

Ch 2 440

7.2 Maximum Power Spectral Density

Result	Pass
Test Specification	FCC part 15 Subpart C 15.247 (e) / RSS 247 Issue 2, Section 5.2 (b)
Test Method	Subclause 11.10.2 of ANSI C63.10
Measurement Bandwidth	3 kHz
Detector	Peak detector
Port of testing	Antenna port
Requirement	For digitally modulated systems, the power spectral density conducted from the intentional radiator to the antenna shall not be greater than 8 dBm

Test Method:

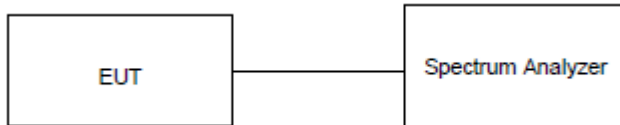

Test Condition

Normal Test Condition:

Temperature (Norm) = + 22.3 °C	Voltage =24.0 V Adapter	Relative humidity: 58%
--------------------------------	-------------------------	------------------------

KDB Guidelines applied:

Measurements were made as per section 8.4 in KDB 558074 D01 15.247 Measurement Guidance v05r02.

Test results:

Note:

1. All the losses are included during measurement and final values are mentioned in the test report.
2. Peak Output power (dBm) = Measured peak power (dBm) + Cable loss (1.0dB)
3. This product do not support additional beamforming gain / directional gain, it uses signal antenna and hence directional gain of the single antenna is 2.12 dBi

Data rate	Channel Frequency (MHz)	Maximum Peak PSD (dBm/3 kHz)	Limit (dBm/3 kHz)
1Mbps	2402	-18.74	8
	2440	-18.23	8
	2480	-17.83	8

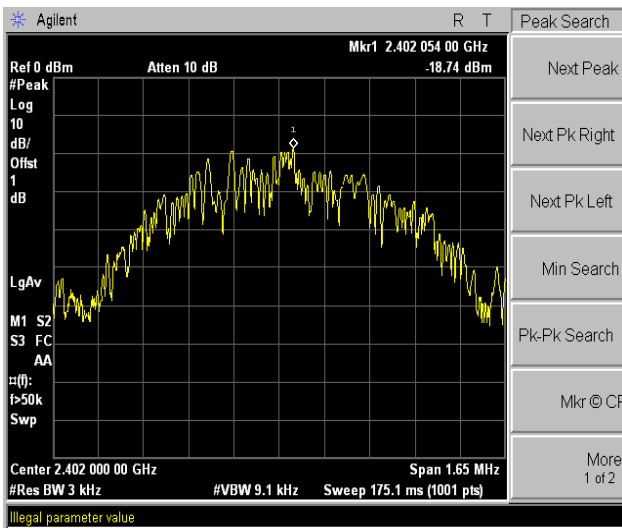

Channel Frequency: 2402MHz

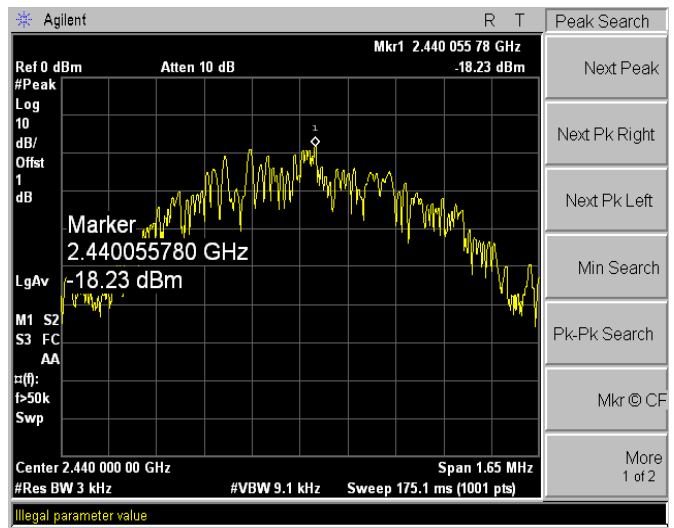

Channel Frequency: 2440MHz

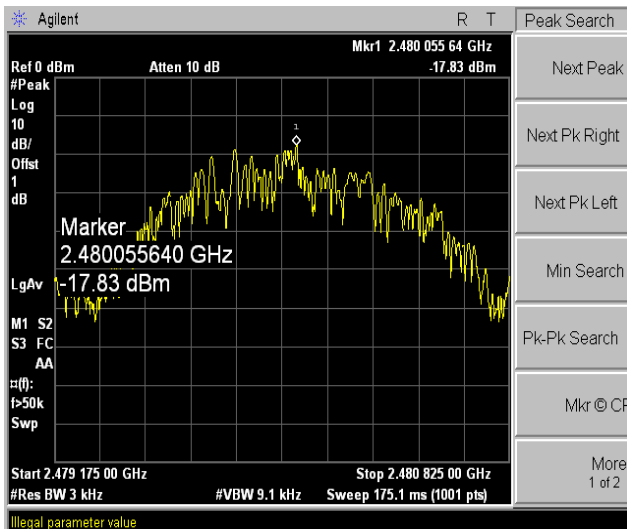

Channel Frequency: 2480MHz

7.3 DTS Bandwidth & 99% Bandwidth

Result	Pass
Test Specification	FCC part 15 Subpart C 15.247 (a) (2) / RSS 247 Issue 2, Section 5.2 (a)
Test Method	Subclause 11.8.1 of ANSI C63.10
Measurement Bandwidth	100 kHz for x dB bandwidth 1 to 5% of OCB for 99% bandwidth
Detector	Peak
Port of testing	Antenna port
Requirement	The minimum 6 dB bandwidth shall be at least 500 kHz

Test Method:

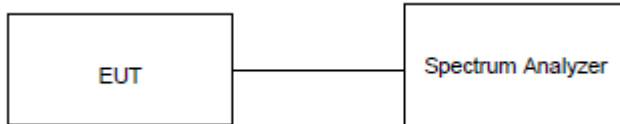

Test Condition

Normal Test Condition:

Temperature (Norm) = + 22.3 °C	Voltage =24.0 V Adapter	Relative humidity: 57%
--------------------------------	-------------------------	------------------------

KDB Guidelines applied:

Measurements were made as per section 8.2 in KDB 558074 D01 15.247 Measurement Guidance v05r02.

Test results:

Note:

1. All the losses are included during measurement and final values are mentioned in the test report.
2. Peak Output power (dBm) = Measured Peak power (dBm) + Cable loss (1.0dB)
3. This product do not support additional beamforming gain / directional gain, it uses signal antenna and hence directional gain of the single antenna is 2.12 dBi

Data rate	Channel Frequency (MHz)	6 dB Bandwidth (MHz)	99% OBW (MHz)	Minimum Limit (MHz)
1Mbps	2402	0.72	1.02	0.5
	2440	0.70	1.03	0.5
	2480	0.64	1.03	0.5

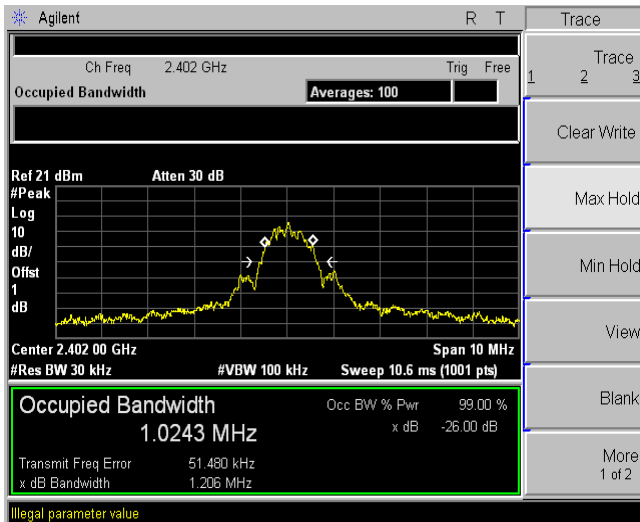

OCB 99%

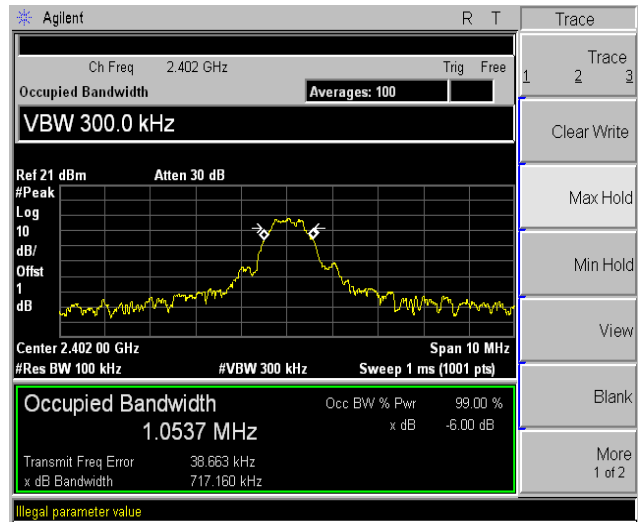

DTS Bandwidth (6dB BW)

Channel Frequency: 2402MHz

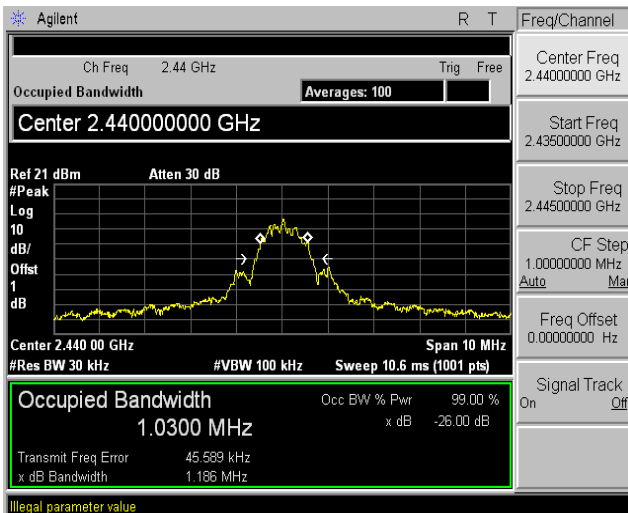

OCB 99%

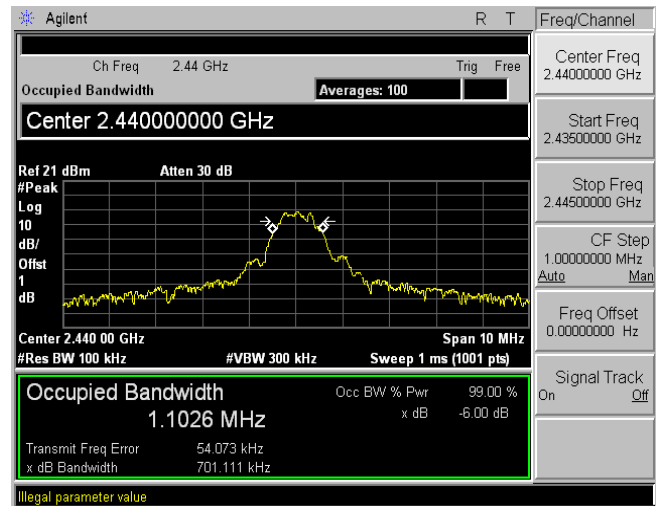

DTS Bandwidth (6dB BW)

Channel Frequency: 2440MHz

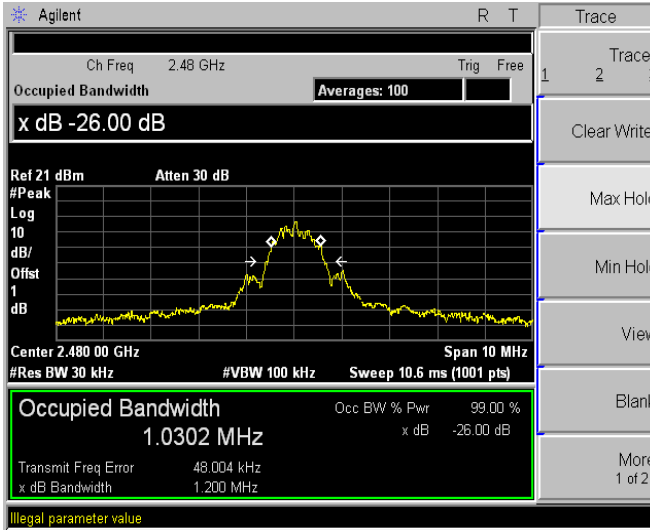

OCB 99%

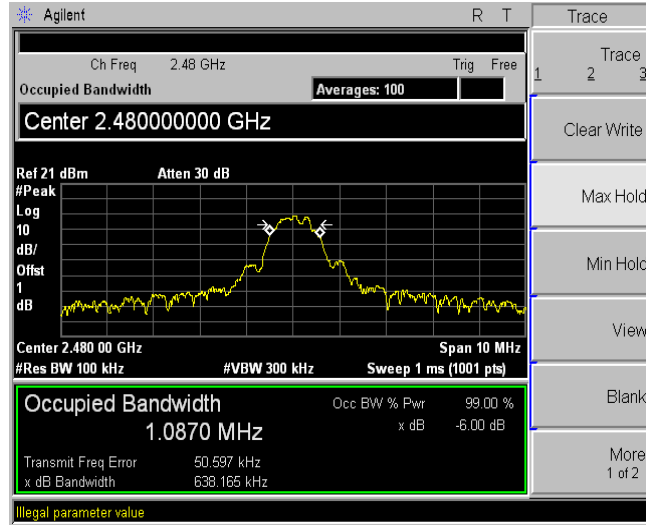

DTS Bandwidth (6dB BW)

Channel Frequency: 2480MHz

7.4 Emissions in non-restricted frequency bands and Conducted Spurious Emission

Result

Pass

Test Specification	FCC part 15 Subpart C 15.247 (d) / RSS 247 Issue 2, Section 5.5
Test Method	Subclause 11.11 of ANSI C63.10
Measurement Bandwidth	100 kHz
Detector	Peak
Port of testing	Antenna port
Requirement	In any 100kHz bandwidth outside the frequency band in which the spread spectrum or digitally modulated intentional radiator is operating, the radio frequency power that is produced by the intentional radiator shall be at least 30dB below that in the 100kHz bandwidth within the band that contains the highest level of the desired power, based on either an RF conducted or a radiated measurement, provided the transmitter demonstrates compliance with the peak conducted power limits If the transmitter complies with the conducted power limits based on the use of RMS averaging over a time interval, the attenuation required under this paragraph shall be 30 dB instead of 20 dB

Test Method:

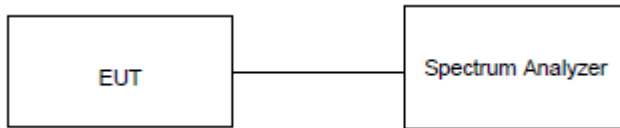

Test Condition

Normal Test Condition:

Temperature (Norm) = + 22.3 °C	Voltage =24.0 V Adapter	Relative humidity: 58%
--------------------------------	-------------------------	------------------------

KDB Guidelines applied:

Measurements were made as per section 8.5 in KDB 558074 D01 15.247 Measurement Guidance v05r02.

Test results:

Note:

1. All the losses are included during measurement and final values are mentioned in the test report.
2. Peak Output power (dBm) = Measured peak power (dBm) + Cable loss (1.0dB)
3. This product do not support additional beamforming gain / directional gain, it uses signal antenna and hence directional gain of the single antenna is 2.12 dBi

7.4.1 Band edge and reference plots

Data rate	Channel Frequency (MHz)	Reference Value (B) (dBm)	Band edge Frequency (MHz)	Value at Band edge (A) (dBm)	A-B (dBc)	Minimum Limit (dBc)
1Mbps	2402	-0.85	2400	-50.47	51.32	30
	2480	-0.19	2483.5	-53.26	53.45	30

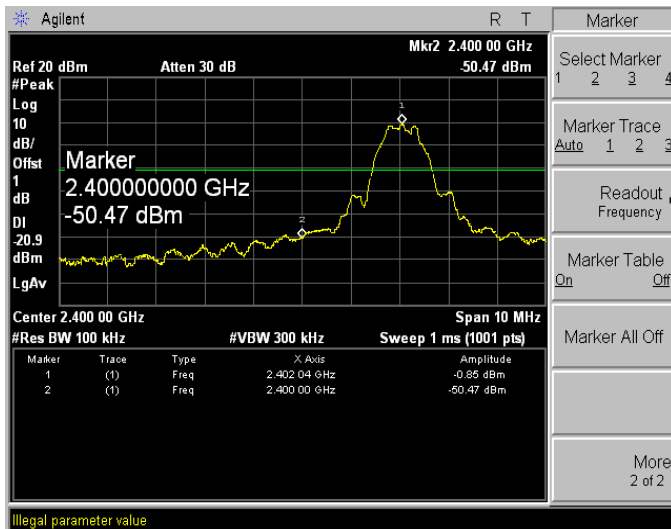

Reference Plot for Channel Frequency 2402MHz

Channel Frequency: 2402MHz

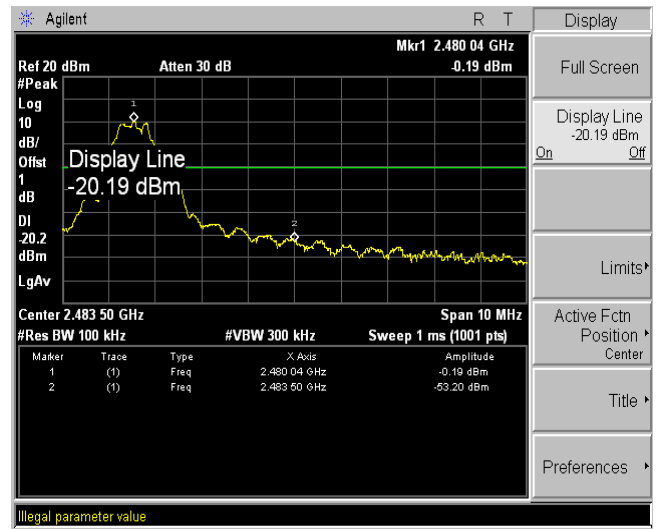

Reference Plot for Channel Frequency 2480MHz

Channel Frequency: 2480MHz

7.4.2 Out-Of-Band Emissions

Channel Frequency BLE 2402 MHz

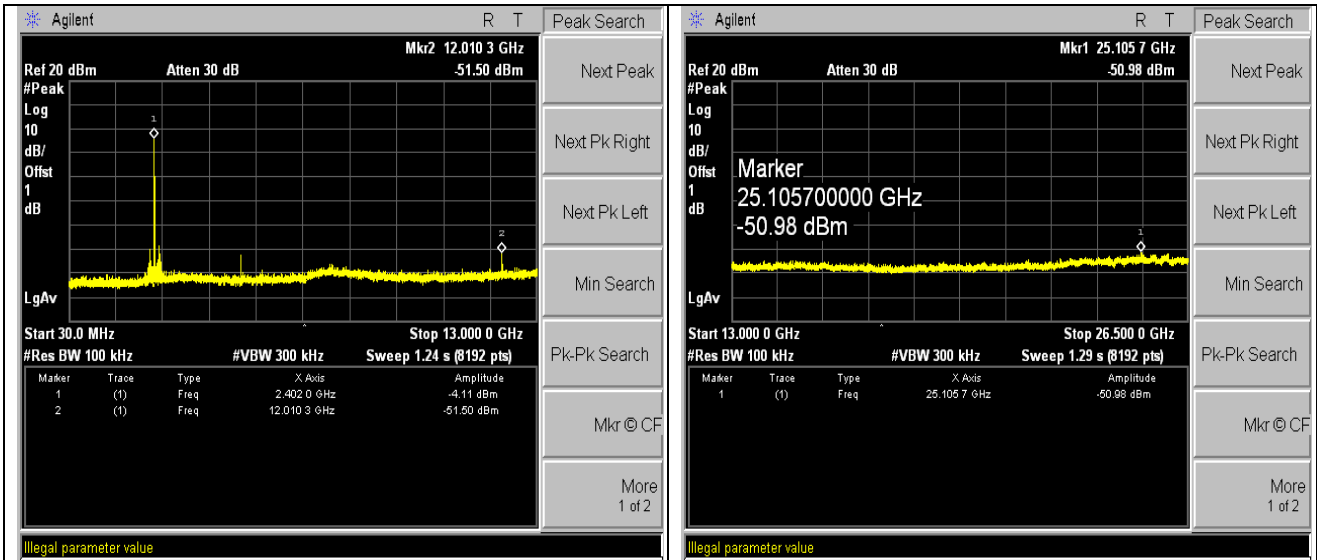

Channel Frequency BLE 2440 MHz

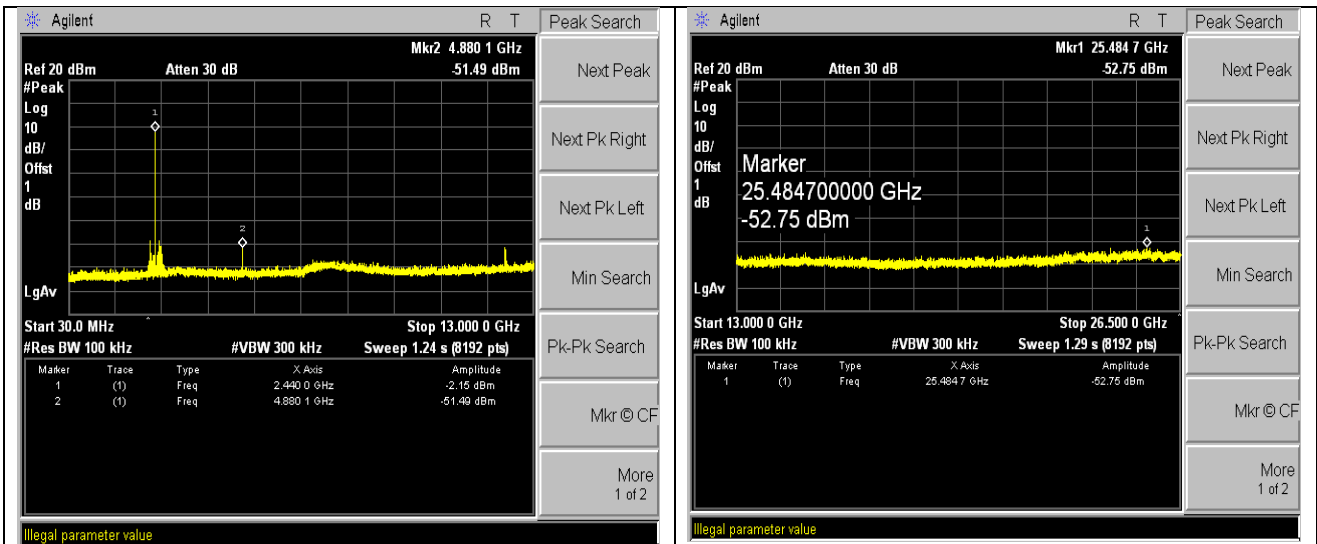

Channel Frequency BLE 2480 MHz

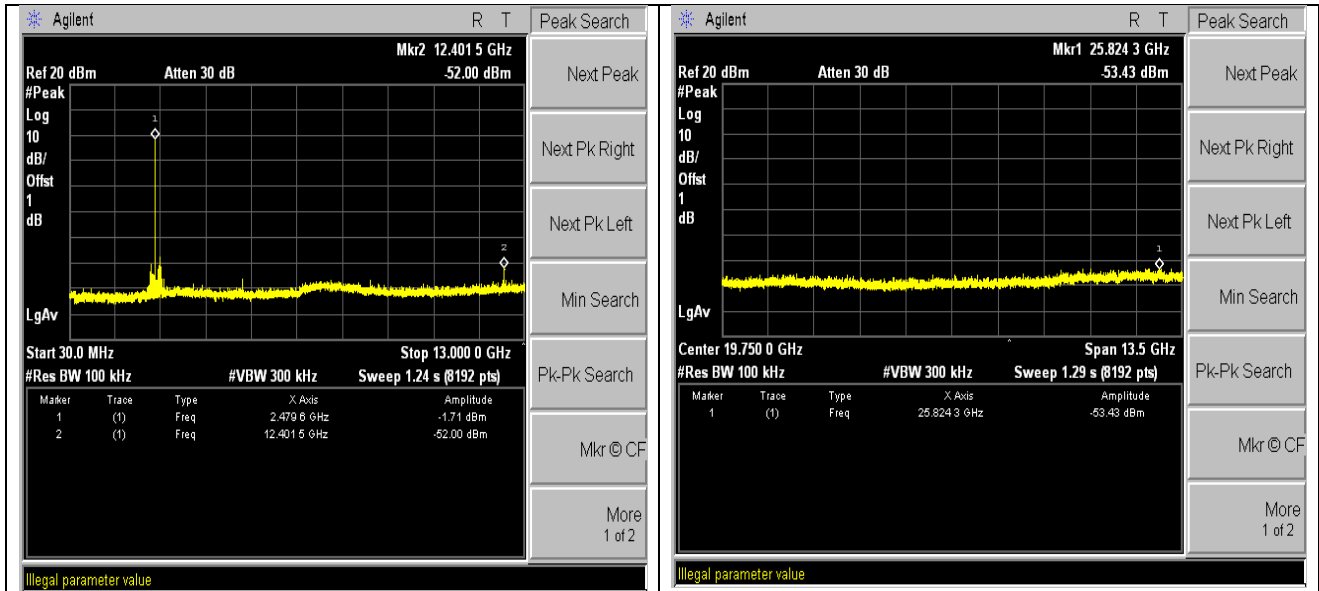

7.5 Spurious Radiated Emissions & Restricted Bands of Operation

Result	Pass
Test Specification	FCC part 15 Subpart C 15.247 (d) / (15.209 & 15.205) RSS-Gen Issue 5, Section 8.9 /8.10
Test Method	ANSI C63.10
Measurement Location	Semi Anechoic Chamber 30MHz - 1 GHz Fully Anechoic Chamber 1 GHz - 40GHz
Measurement Bandwidth	100 kHz for frequency range < 1GHz 1 MHz for Frequency range >1GHz
Detector	Antenna port
Measuring Distance	3 m
Requirement	As per the limits mentioned in the below table
Test setup	Refer TEST METHODOLOGY

Frequency (MHz)	FCC Field strength ($\mu\text{V}/\text{m}$)	ISED Field strength ($\mu\text{V}/\text{m}$)	Distance of Measurement (m)
0.009 – 0.490	2400/F(kHz)	6.37/F(F in kHz)	300*
0.490 – 1.705	24000/F(kHz)	63.7/F(F in kHz)	30*
1.705 -30	30	0.08	30*
30-88	100	100	3
88-216	150	150	3
216-960	200	200	3
Above 960	500	500	3

Remark: * The limit shows in the table above of frequency range 0.009 – 0.490, 0.490 – 1.705 MHz and 1.705-30MHz is at 300 meter, 30 meter and 30 meter range respectively, which corresponds to 128.51 – 93.80, 73.80 – 62.96 and 69.54.00 dB $\mu\text{V}/\text{m}$ at 3m range by extrapolation calculation and the measurement of loop antenna. The emission limits shown in the above table are based on measurements employing a CISPR quasi-peak detector except for the frequency bands 9–90 kHz, 110–490 kHz and above 1000 MHz Radiated emission limits in these three bands are based on measurements employing an average detector.

Test procedures

Radiated emissions from the EUT were measured according to the dictates in section 11.11 & 11.12 of ANSI C63.10-2013 and only the radiated emissions of the configuration that produced the worst case emissions are reported in this section.

Test Procedures for emission above 30 MHz

1. The EUT was placed on the top of a rotating table 0.8 meters above the ground at a 3 meter anechoic chamber test site below 1 GHz and 1.5 meters above the ground at a 3 meter anechoic chamber test site above 1 GHz. The table was rotated 360 degrees to determine the position of the highest radiation.
2. During performing radiated emission below 1 GHz, the EUT was set 3 meters away from the interference receiving antenna, which was mounted on the top of a variable-height antenna tower. During performing radiated emission above 1 GHz, the EUT was set 3 meter away from the interference-receiving antenna.
3. The antenna is a bi-log antenna, a horn antenna and its height is varied from one meter to four meters above the ground to determine the maximum value of the field strength. Both horizontal and vertical polarizations of the antenna are set to make the measurement.
4. For each suspected emission, the EUT was arranged to its worst case and then the antenna was tuned to heights from 1 meter to 4 meters and the table was turned from 0 degrees to 360 degrees to find the maximum reading.
5. For measurements below 1 GHz resolution bandwidth is set to 100 kHz for peak detection measurements or 120 kHz for quasi-peak detection measurements. Peak detection is used unless otherwise noted as quasi-peak.
6. For measurements Above 1 GHz resolution bandwidth is set to 1 MHz, the video bandwidth is set to 3 MHz for peak measurements and as applicable for average measurements..

Test Condition

Normal Test Condition:

Temperature (Norm) = + 22.3 °C	Voltage =24.0 V Adapter	Relative humidity: 57 %
--------------------------------	-------------------------	-------------------------

Test results:

Test results for frequency range 9kHz – 30MHz

No emissions found in frequency range 9 kHz to 30 MHz, and measured levels are below 20dB from the limit line, hence not reported

Test results for frequency range 30MHz – 1GHz

Frequency (MHz)	Reading (dB μV)	Position (V/H)	Height (m)	Correction Factor		Result Value(Quasi-peak)		
				Ant Factor (dB)	Cable (dB)	Limit (dB $\mu V/m$)	Result (dB $\mu V/m$)	Margin (dB)
96.10	23.55	V	1.0	11.80	2.33	43.50	37.68	-5.82
150.00	23.69	V	1.0	13.57	2.63	43.50	39.89	-3.61
350.00	16.45	H	1.3	17.90	3.54	46.00	37.89	-8.11
720.00	14.09	H	1.1	20.35	3.96	46.00	38.40	-7.60
750.00	11.39	H	1.0	23.10	4.70	46.00	39.19	-6.81
800.00	9.08	H	1.0	24.20	5.08	46.00	38.36	-7.64
Remark	<p>H : Horizontal, V : Vertical TEST MODE : BT BLE (CH : 19 - 2 440 MHz)</p> <p>*Checked in all 3 axis and the maximum measured data were reported.(Worst data is X axis of position)</p> <p>*CL = Cable Loss(In case of below 1 000 MHz)</p> <p>*Result Value = Reading + Ant Factor + Cable loss</p> <p>*The resolution bandwidth and video bandwidth of test receiver/spectrum analyzer is 120 kHz for Quasi-peak detection at frequency below 1 GHz.</p>							

BLE 1M Polarity:Horizontal

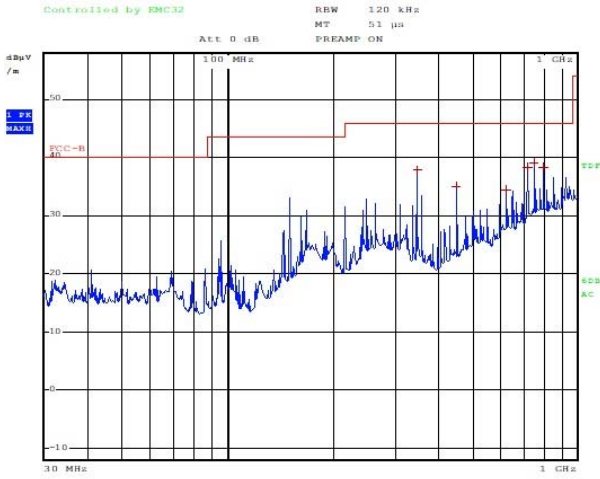

ESTR-23-00245

BLE 1M Polarity:Vertical

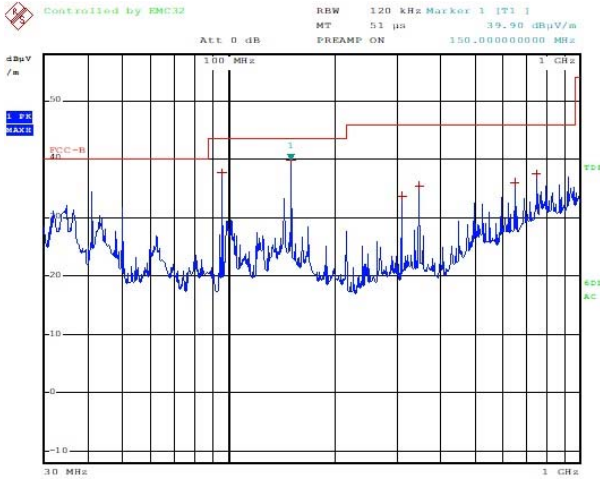

ESTR-23-00245

Test results for the frequencies above 1GHz

Test Data(Low)

BLE 1Mbps

Measurement Distance : 3 m

Frequency (MHz)	Reading (dB μ V)	Position (V/H)	Height (m)	Correction Factor		Duty Cycle Correction(dB)	Result Value		
				Ant Factor (dB)	AMP & Cable (dB)		Limit (dB μ V/m)	Result (dB μ V/m)	Margin (dB)
PEAK(RBW: 1 MHz VBW: 3 MHz)									
2390.00	47.80	H	1.6	27.73	-29.72		74.00	45.81	-28.19
2390.00	47.45	V	1.6	27.73	-29.72		74.00	45.46	-28.54
4804.00	48.24	H	1.5	31.40	-27.26		74.00	52.38	-21.62
4804.00	49.15	V	1.5	31.40	-27.26		74.00	53.29	-20.71
AV(RBW: 1 MHz VBW: 3 MHz)									
2390.00	36.15	H	1.6	27.73	-29.72	7.857	54.00	42.02	-11.98
2390.00	36.12	V	1.6	27.73	-29.72	7.857	54.00	41.99	-12.01
4804.00	34.06	H	1.5	31.40	-27.26	7.857	54.00	46.06	-7.94
4804.00	34.51	V	1.5	31.40	-27.26	7.857	54.00	46.51	-7.49
Remark	<p>H : Horizontal, V : Vertical TEST MODE : CH : 0 - 2 402 MHz (x postion)</p> <p>*The TX signal wasn't detected from 3th harmonics.</p> <p>*Checked in all 3 axis and the maximum measured data were reported.(Worst data is X axis of position)</p> <p>*Total = Reading Value + Antenna Factor + Cable Loss - Amp Gain + Duty Cycle Correction</p> <p>*This test was radiated up to 26.5 GHz but no noise was measured.</p>								

Test Data(Mid)

BLE 1Mbps

Measurement Distance : 3 m

Frequency (MHz)	Reading (dB μV)	Position (V/H)	Height (m)	Correction Factor		Duty Cycle Correction(dB)	Result Value		
				Ant Factor (dB)	AMP & Cable (dB)		Limit (dB $\mu V/m$)	Result (dB $\mu V/m$)	Margin (dB)
PEAK(RBW: 1 MHz VBW: 3 MHz)									
4880.00	49.47	H	1.5	31.56	-27.08		74.00	53.95	-20.05
4880.00	47.72	V	1.6	31.56	-27.08		74.00	52.20	-21.80
AV(RBW: 1 MHz VBW: 3 MHz)									
4880.00	35.03	H	1.5	31.56	-27.08	7.857	54.00	47.37	-6.63
4880.00	34.94	V	1.6	31.56	-27.08	7.857	54.00	47.28	-6.72
Remark	<p>H : Horizontal, V : Vertical TEST MODE : CH : 19 - 2 440 MHz (x position)</p> <p>*The TX signal wasn't detected from 3th harmonics.</p> <p>*Checked in all 3 axis and the maximum measured data were reported.(Worst data is X axis of position)</p> <p>*Total = Reading Value + Antenna Factor + Cable Loss - Amp Gain + Duty Cycle Correction</p> <p>*This test was radiated up to 26.5 GHz but no noise was measured.</p>								

Test Data(High)

BLE 1Mbps

Measurement Distance : 3 m

Frequency (MHz)	Reading (dB μV)	Position (V/H)	Height (m)	Correction Factor		Duty Cycle Correction(dB)	Result Value		
				Ant Factor (dB)	AMP & Cable (dB)		Limit (dB $\mu V/m$)	Result (dB $\mu V/m$)	Margin (dB)
PEAK(RBW: 1 MHz VBW: 3 MHz)									
2390.00	47.80	H	1.6	27.73	-29.72		74.00	45.81	-28.19
2390.00	47.45	V	1.6	27.73	-29.72		74.00	45.46	-28.54
4804.00	48.24	H	1.5	31.40	-27.26		74.00	52.38	-21.62
4804.00	49.15	V	1.5	31.40	-27.26		74.00	53.29	-20.71
AV(RBW: 1 MHz VBW: 3 MHz)									
2390.00	36.15	H	1.6	27.73	-29.72	7.857	54.00	42.02	-11.98
2390.00	36.12	V	1.6	27.73	-29.72	7.857	54.00	41.99	-12.01
4804.00	34.06	H	1.5	31.40	-27.26	7.857	54.00	46.06	-7.94
4804.00	34.51	V	1.5	31.40	-27.26	7.857	54.00	46.51	-7.49
Remark	<p>H : Horizontal, V : Vertical TEST MODE : CH : 39 - 2 480 MHz (x postion)</p> <p>*The TX signal wasn't detected from 3th harmonics.</p> <p>*Checked in all 3 axis and the maximum measured data were reported.(Worst data is X axis of position)</p> <p>*Total = Reading Value + Antenna Factor + Cable Loss - Amp Gain + Duty Cycle Correction</p> <p>*This test was radiated up to 26.5 GHz but no noise was measured.</p>								

Restricted Band Edges

Band Edges(BLE CH Low)

Detector mode : Peak

Polarity : Horizontal

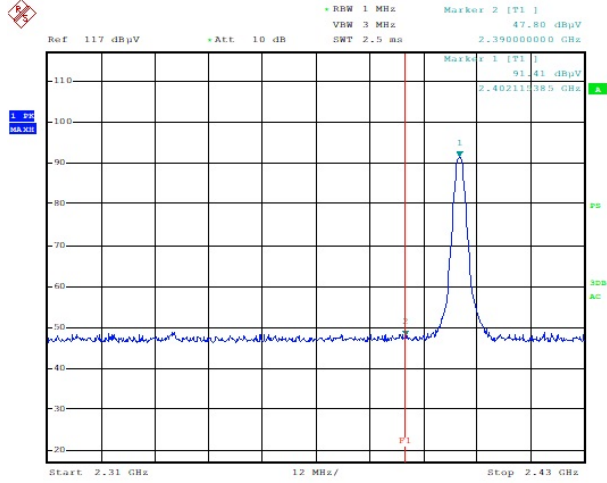

ESTR-23-00245

Detector mode : Average

Polarity : Horizontal

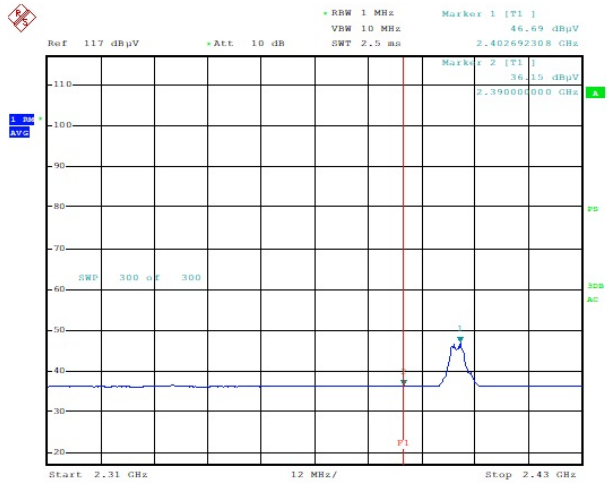

ESTR-23-00245

Band Edges(BLE CH Low)

Detector mode : Peak

Polarity : Vertical

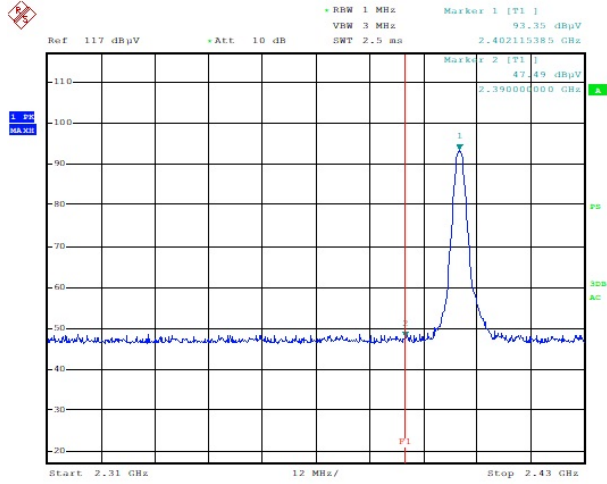

ESTR-22-00245

Detector mode : Average

Polarity : Vertical

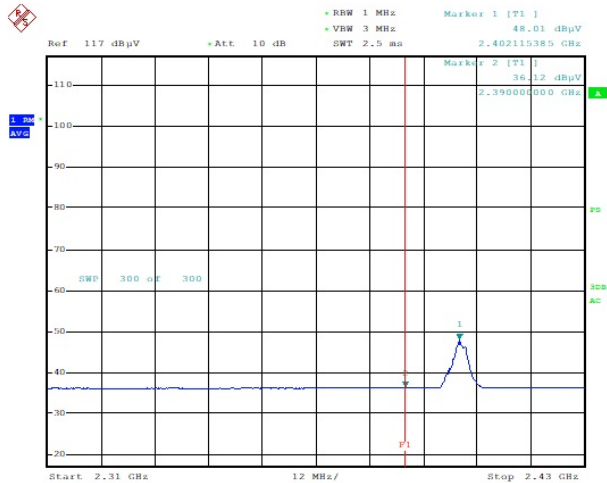

ESTR-23-00245

Band Edges(BLE CH High)

Detector mode : Peak

Polarity : Horizontal

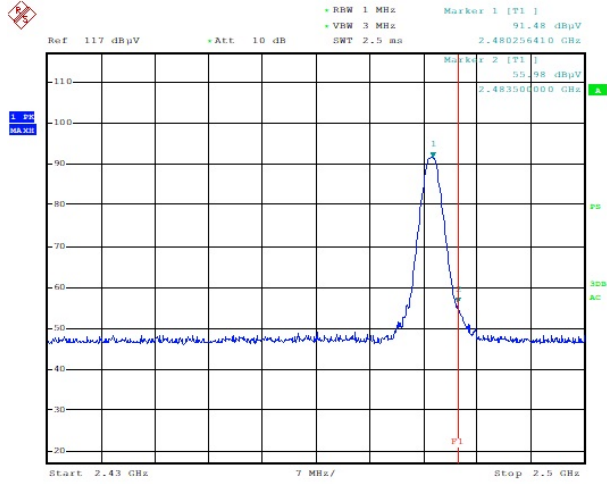

ESTR-22-00245

Detector mode : Average

Polarity : Horizontal

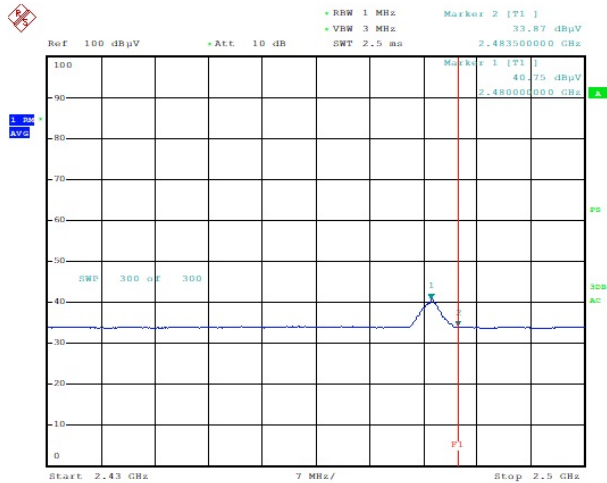

ESTR-22-00245

Band Edges(BLE CH High)

Detector mode : Peak

Polarity : Vertical

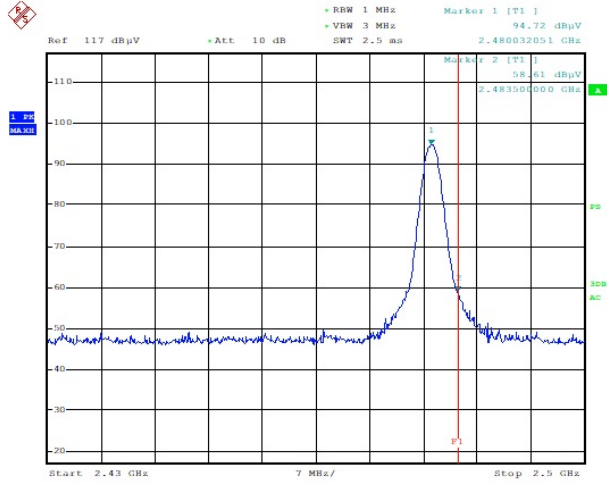

ESTR-22-00245

Detector mode : Average

Polarity : Vertical

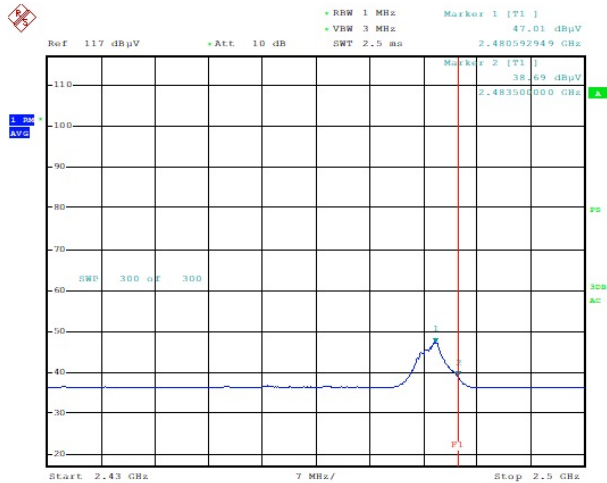

ESTR-23-00245

Modulation: Band Edges BLE CH Low

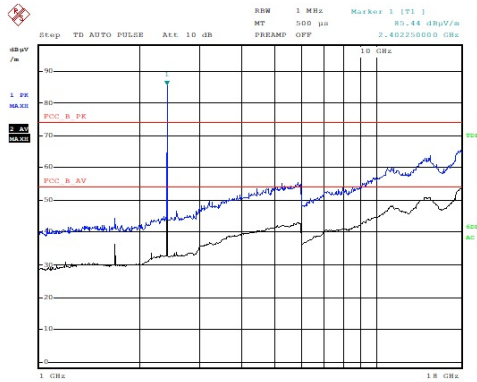

ESTR-23-00245

Polarity:Horizontal

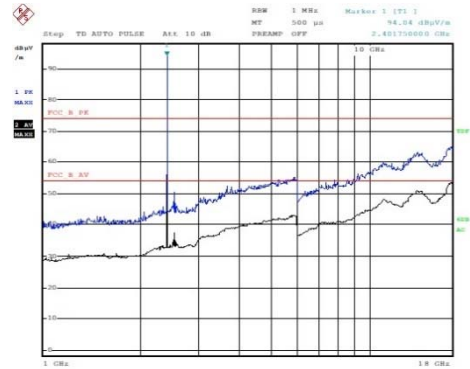

ESTR-23-00245

Polarity:Vertical

Modulation: Band Edges BLE CH Mid

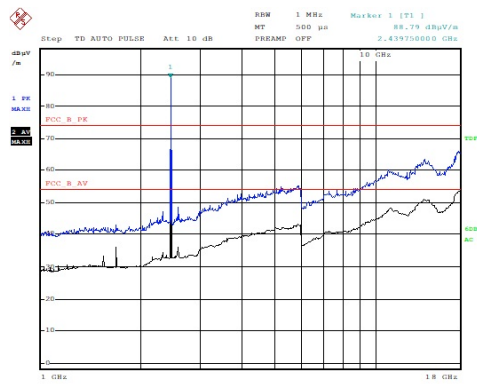

ESTR-23-00245

Polarity:Horizontal

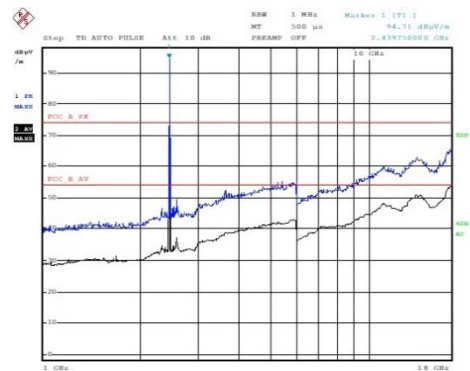

ESTR-23-00245

Polarity:Vertical

Modulation: Band Edges BLE CH High

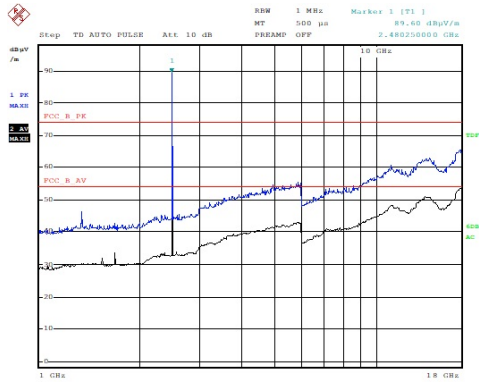

ESTR-23-00245

Polarity:Horizontal

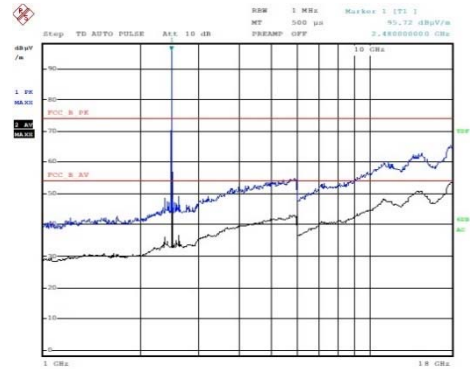

ESTR-23-00245

Polarity:Vertical

8 Conducted Spurious Emission on AC Power lines

Result

Pass

Test Specification	FCC Part 15 Section 15.207 / RSS Gen Issue 5 Section 8.8
Test Method	ANSI C 63.10-2013
Testing Location	Screened room
Measurement Bandwidth	9 kHz
Frequency Range	150kHz – 30MHz
Supply Voltage	: 120VAC,60Hz
Test Method	Refer TEST METHODOLOGY

***Note: The product has tested with AC to DC adapter**

Limits of section 15.207

Frequency of emission (MHz)	Conducted limit (dBµV)	
	Quasi-peak (dBµV)	Average (dBµV)
0.15-0.5	66-56*	56-46*
0.5-5	56	46
5-30	60	50

* Decreases with the logarithm of the frequency

Normal Test Condition:

Temperature (Norm) = + 22.3 °C	Voltage =24.0 V Adapter	Relative humidity: 58 %
--------------------------------	-------------------------	-------------------------

Test results

BLE									
Frequency (MHz)	Correction Factor		Line (H/N)	Quasi-peak Value			Average Value		
	Lisn (dB)	Cable (dB)		Limit (dB μV)	Reading (dB μV)	Result (dB μV)	Limit (dB μV)	Reading (dB μV)	Result (dB)
0.15	0.06	0.15	N	59.83	39.71	39.92	49.83	25.64	25.85
0.17	0.06	0.15	H	58.93	37.99	38.20	48.93	24.92	25.13
0.20	0.06	0.15	H	58.00	33.81	34.01	48.00	22.38	22.58
0.42	0.05	0.14	H	57.93	43.89	44.08	47.93	36.58	36.77
7.99	0.05	0.14	N	56.81	38.74	38.93	46.81	34.14	34.33
12.47	0.05	0.14	N	56.76	35.10	35.29	46.76	30.53	30.72
Remark	H : Hot Line, N : Neutral Line *Correction Factor = Lisn + Cable *Result = Correction Factor + Reading								

Test Plots

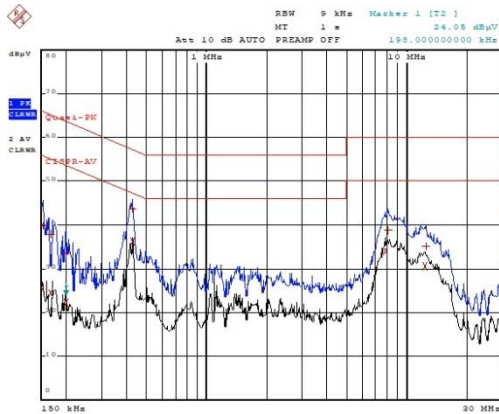

HOT LINE

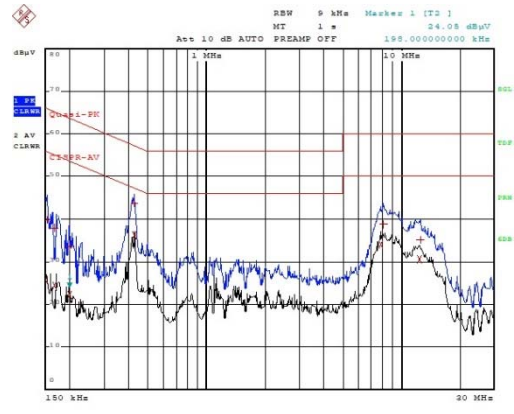

NUETRAL LINE