

FCC

SAR

TEST REPORT

ISSUED BY
Shenzhen BALUN Technology Co., Ltd.



FOR
X1 MAX FDD-LTE Smartphone

ISSUED TO
TP-LINK Technologies Co., Ltd.

Building 24-1F/3F/4F/5F, 28-1F/2F/3F/4F Science and Technology Park, Shennan Road, Nanshan District, Shenzhen City, Guangdong Province, P.R. China



Tested by: Zong Liyao
Zong Liyao
(Engineer)

Date May 19, 2017

Approved by: Wei Yanquan
Wei Yanquan
(Chief Engineer)

Date May 19, 2017



Report No.: BL-SZ1730238-701

EUT Name: X1 MAX FDD-LTE Smartphone

Model Name: TP903C

Brand Name: neffos

FCC ID: TE7X1MAXV1

Test Standard: FCC 47 CFR Part 2.1093

ANSI C95.1: 1999, IEEE 1528: 2013

Maximum SAR: Head (1 g): 0.807 W/kg

Body-worn (1 g): 1.058W/kg

Hotspot (1 g): 1.058W/kg

Test Conclusion: Pass

Test Date: Mar. 17, 2017 ~ Apr. 24, 2017

Date of Issue: May 19, 2017

NOTE: This test report can be duplicated completely for the legal use with the approval of the applicant; it shall not be reproduced except in full, without the written approval of Shenzhen BALUN Technology Co., Ltd. BALUN Laboratory. Any objections should be raised within thirty days from the date of issue. To validate the report, please visit BALUN website.

Revision History

Version	Issue Date	Revisions Content
<u>Rev. 01</u>	<u>May 15, 2017</u>	<u>Initial Issue</u>
<u>Rev. 02</u>	<u>May 19, 2017</u>	<u>Added a note about dual SIM card slots describe in page 6.</u>

TABLE OF CONTENTS

1	GENERAL INFORMATION.....	5
1.1	Identification of the Testing Laboratory.....	5
1.2	Identification of the Responsible Testing Location.....	5
1.3	Test Environment Condition.....	5
1.4	Announce.....	5
2	PRODUCT INFORMATION.....	6
2.1	Applicant Information.....	6
2.2	Manufacturer Information.....	6
2.3	Factory Information.....	6
2.4	General Description for Equipment under Test (EUT).....	6
2.5	Ancillary Equipment.....	7
2.6	Technical Information.....	8
3	SUMMARY OF TEST RESULTS.....	9
3.1	Test Standards.....	9
3.2	Device Category and SAR Limit.....	9
3.3	Test Result Summary.....	11
3.4	Test Uncertainty.....	12
4	SAR MEASUREMENT SYSTEM.....	13
4.1	Definition of Specific Absorption Rate (SAR).....	13
4.2	SATIMO SAR System.....	13
5	SYSTEM VERIFICATION.....	22
5.1	Antenna Port Test Requirement.....	22
5.2	Purpose of System Check.....	22
5.3	System Check Setup.....	22
6	EUT TEST POSITION CONFIGURATUONS.....	23

6.1	Head Exposure Conditions	23
6.2	Body-worn Position Conditions	24
6.3	Hotspot Mode Exposure Position Conditions	25
7	SAR MEASUREMENT PROCEDURES	26
7.1	SAR Measurement Process Diagram	26
7.2	SAR Scan General Requirements	27
7.3	SAR Measurement Procedure	28
7.4	Area & Zoom Scan Procedures	28
8	CONDUCTED RF OUPUT POWER	29
8.1	GSM	29
8.2	WCDMA	30
8.3	LTE	31
8.4	WIFI	36
8.5	Bluetooth	37
9	EUT ANTENNA LOCATION SKETCH	38
9.1	SAR Test Exclusion Consider Table	39
9.2	10g Extremity Exposure Consider	42
10	TEST RESULTS	43
10.1	GSM 850	43
10.2	GSM 1900	44
10.3	WCDMA Band 2	44
10.4	WCDMA Band 4	45
10.5	WCDMA Band 5	45
10.6	LTE Band 2 (20MHz Bandwidth)	46
10.7	LTE Band 4 (20MHz Bandwidth)	47
10.8	LTE Band 7 (20MHz Bandwidth)	48
10.9	WIFI 2.4GHz	49
10.10	WIFI 5GHz	49
11	SAR Measurement Variability	50
12	SIMULTANEOUS TRANSMISSION	51
12.1	Simultaneous Transmission Mode Consider	51

12.2 Estimated SAR Calculation.....52

12.3 Sum SAR of Simultaneous Transmission53

13 TEST EQUIPMENTS LIST55

ANNEX A SIMULATING LIQUID VERIFICATION RESULT56

ANNEX B SYSTEM CHECK RESULT57

ANNEX C TEST DATA.....86

ANNEX D EUT EXTERNAL PHOTOS108

ANNEX E SAR TEST SETUP PHOTOS108

ANNEX F CALIBRATION REPORT108

1 GENERAL INFORMATION

1.1 Identification of the Testing Laboratory

Company Name	Shenzhen BALUN Technology Co., Ltd.
Address	Block B, 1st FL, Baisha Science and Technology Park, Shahe Xi Road, Nanshan District, Shenzhen, Guangdong Province, P. R. China
Phone Number	+86 755 6685 0100

1.2 Identification of the Responsible Testing Location

Test Location	Shenzhen BALUN Technology Co., Ltd.
Address	Block B, 1st FL, Baisha Science and Technology Park, Shahe Xi Road, Nanshan District, Shenzhen, Guangdong Province, P. R. China
Accreditation Certificate	<p>The laboratory has been listed by Industry Canada to perform electromagnetic emission measurements. The recognition numbers of test site are 11524A-1.</p> <p>The laboratory has been listed by US Federal Communications Commission to perform electromagnetic emission measurements. The recognition numbers of test site are 832625.</p> <p>The laboratory is a testing organization accredited by China National Accreditation Service for Conformity Assessment (CNAS) according to ISO/IEC 17025. The accreditation certificate number is L6791.</p>
Description	All measurement facilities used to collect the measurement data are located at Block B, FL 1, Baisha Science and Technology Park, Shahe Xi Road, Nanshan District, Shenzhen, Guangdong Province, P. R. China 518055

1.3 Test Environment Condition

Ambient Temperature	20 to 23°C
Ambient Relative Humidity	30 to 60%
Ambient Pressure	100 to 102KPa

1.4 Announce

- (1) The test report reference to the report template version v2.2.
- (2) The test report is invalid if not marked with the signatures of the persons responsible for preparing and approving the test report.
- (3) The test report is invalid if there is any evidence and/or falsification.
- (4) The results documented in this report apply only to the tested sample, under the conditions and modes of operation as described herein.
- (5) This document may not be altered or revised in any way unless done so by BALUN and all revisions are duly noted in the revisions section.
- (6) Content of the test report, in part or in full, cannot be used for publicity and/or promotional purposes without prior written approval from the laboratory.

2 PRODUCT INFORMATION

2.1 Applicant Information

Applicant	TP-LINK Technologies Co., Ltd.
Address	Building 24-1F/3F/4F/5F, 28-1F/2F/3F/4F Science and Technology Park, Shennan Road, Nanshan District, Shenzhen City, Guangdong Province, P.R. China

2.2 Manufacturer Information

Manufacturer	TP-LINK Technologies Co., Ltd.
Address	Building 24-1F/3F/4F/5F, 28-1F/2F/3F/4F Science and Technology Park, Shennan Road, Nanshan District, Shenzhen City, Guangdong Province, P.R. China

2.3 Factory Information

Factory	N/A
Address	N/A

2.4 General Description for Equipment under Test (EUT)

EUT Name	X1 MAX FDD-LTE Smartphone
Model Name Under Test	TP903C
Series Model Name	TP903C, TP903CXYZZ
Description of Model Name Differentiation	The equipment model TP903C and TP903CXYZZ(X=2 or 4 (2 indicates Cloudy Grey, 4 indicates Sunrise Gold); Y=6 or A (A indicates the memory is 4G RAM + 64G Flash, 6 indicates the memory is 3G RAM + 32G Flash); ZZ indicates different national.) are the EUT model, the electrical parameters and internal structure of circuit are same. Only the model name, colors, memory versions and shipping country are different.
Hardware Version	N/A
Software Version	N/A
Dimensions (Approx.)	152mm x 76mm x 7mm
Weight (Approx.)	N/A
Network and Wireless connectivity	2G Network GSM 850/1900; GPRS Class 12; EDGE Class 12; 3G Network WCDMA Band 2/4/5, HSDPA, HSUPA; 4G Network FDD LTE Band 2/4/7; WIFI 802.11a, 802.11b, 802.11g and 802.11n (HT20/40); Bluetooth, GPS, FM, GLONASS
Note: The EUT is a mobile phone, which supports dual SIM card slots under the same transceiver. Both SIM card slots support GSM, WCDMA and LTE, and both SIM slots share the same transceiver, so only SIM1 was tested in this report.	

2.5 Ancillary Equipment

Ancillary Equipment 1	Battery	
	Brand Name	neffos
	Model No.	NBL-35A3000
	Serial No.	N/A
	Capacitance	3000 mAh
	Rated Voltage	3.85 V
	Limited Voltage	4.40 V
Ancillary Equipment 2	Adapter	
	Brand Name	neffos
	Model No.	N090200-2B3 (US Plug)
	Serial No.	N/A
	Rated Input	100-240 V~, 0.3 A, 50/60 Hz
Rated Output	5 V=, 3 A or 9 V=, 2 A or 12 V=, 1.5 A	
Ancillary Equipment 3	USB Cable	
	Length (Approx.)	100 cm
Ancillary Equipment 4	Earphone	
	Length (Approx.)	125 cm

2.6 Technical Information

The requirement for the following technical information of the EUT was tested in this report:

Operating Mode	GSM, WCDMA, FDD-LTE, 2.4G WLAN, 5G WLAN, Bluetooth		
Frequency Range	GSM 850	TX: 824 MHz ~ 849 MHz	RX: 869 MHz ~ 894 MHz
	GSM 1900	TX: 1850 MHz ~ 1910 MHz	RX: 1930 MHz ~ 1990 MHz
	WCDMA Band 2	TX: 1850 MHz ~ 1910 MHz	RX: 1930 MHz ~ 1990 MHz
	WCDMA Band 4	TX: 1710 MHz ~ 1755 MHz	RX: 2110 MHz ~ 2155 MHz
	WCDMA Band 5	TX: 824 MHz ~ 849 MHz	RX: 869 MHz ~ 894 MHz
	LTE Band 2	TX: 1850 MHz ~ 1910 MHz	RX: 1930 MHz ~ 1990 MHz
	LTE Band 4	TX: 1710 MHz ~ 1755 MHz	RX: 2110 MHz ~ 2155 MHz
	LTE Band 7	TX: 2500 MHz ~ 2570 MHz	RX: 2620 MHz ~ 2690 MHz
	802.11b/g/n(HT20/HT40)	2400~2483.5 MHz	
	802.11a/n(HT20/HT40)	5150 MHz~ 5250 MHz	
		5725 MHz~ 5850 MHz	
Bluetooth	2400~2483.5 MHz		
Antenna Type	WWAN: PIFA Antenna WLAN: PIFA Antenna Bluetooth: PIFA Antenna		
DTM	Not Support		
Hotspot Function	Support		
Power Reduction	Not Support		
Exposure Category	General Population/Uncontrolled exposure		
EUT Stage	Portable Device		
Product	Type		
	<input checked="" type="checkbox"/> Production unit	<input type="checkbox"/> Identical prototype	

3 SUMMARY OF TEST RESULTS

3.1 Test Standards

No.	Identity	Document Title
1	47 CFR Part 2	Frequency Allocations and Radio Treaty Matters; General Rules and Regulations
2	ANSI/IEEE Std. C95.1-1999	IEEE Standard for Safety Levels with Respect to Human Exposure to Radio Frequency Electromagnetic Fields, 3 kHz to 300 GHz
3	IEEE Std. 1528-2013	Recommended Practice for Determining the Peak Spatial-Average Specific Absorption Rate (SAR) in the Human Head from Wireless Communications Devices: Measurement Techniques
4	FCC KDB 447498 D01 v06	Mobile and Portable Device RF Exposure Procedures and Equipment Authorization Policies
5	FCC KDB 941225 D01 v03r01	3G SAR MEAUREMENT PROCEDURES
6	FCC KDB 941225 D05 v02r05	SAR Evaluation Considerations for LTE Devices
7	FCC KDB 941225 D06 v02r01	SAR Evaluation Procedures for Portable Devices with Wireless Router Capabilities
8	FCC KDB 865664 D01 v01r04	SAR Measurement 100 MHz to 6 GHz
9	FCC KDB 865664 D02 v01r02	RF Exposure Reporting
10	FCC KDB 648474 D04 v01r03	SAR Evaluation Considerations for Wireless Handsets
11	KDB 248227 D01 v02r02	SAR Guidance for IEEE 802.11 (Wi-Fi) Transmitters

3.2 Device Category and SAR Limit

This device belongs to portable device category because its radiating structure is allowed to be used within 20 centimeters of the body of the user. Limit for General Population/Uncontrolled exposure should be applied for this device, it is 1.6 W/kg as averaged over any 1 gram of tissue.

Table of Exposure Limits:

Body Position	SAR Value (W/Kg)	
	General Population/ Uncontrolled Exposure	Occupational/ Controlled Exposure
Whole-Body SAR (averaged over the entire body)	0.08	0.4
Partial-Body SAR (averaged over any 1 gram of tissue)	1.60	8.0
SAR for hands, wrists, feet and ankles (averaged over any 10 grams of tissue)	4.0	20.0

NOTE:

General Population/Uncontrolled: Locations where there is the exposure of individuals who have no knowledge or control of their exposure. General population/uncontrolled exposure limits are applicable to situations in which the general public may be exposed or in which persons who are exposed as a consequence of their employment may not be made fully aware of the potential for exposure or cannot exercise control over their exposure. Members of the general public would come under this category when exposure is not employment-related; for example, in the case of a wireless transmitter that exposes persons in its vicinity.

Occupational/Controlled: Locations where there is exposure that may be incurred by persons who are aware of the potential for exposure. In general, occupational/controlled exposure limits are applicable to situations in which persons are exposed as a consequence of their employment, who have been made fully aware of the potential for exposure and can exercise control over their exposure. This exposure category is also applicable when the exposure is of a transient nature due to incidental passage through a location where the exposure levels may be higher than the general population/uncontrolled limits, but the exposed person is fully aware of the potential for exposure and can exercise control over his or her exposure by leaving the area or by some other appropriate means.

3.3 Test Result Summary

3.3.1 Highest SAR (1 g Value)

Band	Maximum Scaled SAR (W/kg)			Maximum Report SAR (W/kg)			Limit (W/kg)
	Head	Body-worn	Hotspot	Head	Body-worn	Hotspot	
GSM 850	0.308	0.573	0.837	0.807	1.058	1.058	1.6
GSM 1900	0.119	0.324	0.711				
WCDMA Band 2	0.232	0.582	0.906				
WCDMA Band 4	0.211	0.938	1.052				
WCDMA Band 5	0.331	0.460	0.460				
LTE Band 2	0.182	0.686	0.855				
LTE Band 4	0.239	1.058	1.058				
LTE Band 7	0.308	0.611	0.890				
2.4G WLAN	0.557	0.200	0.200				
5.2G WLAN	0.807	0.490	0.490				
5.8G WLAN	0.518	0.370	0.370				
Verdict	Pass						

3.3.2 Highest Simultaneous SAR

Position	Simultaneous Configuration	Simultaneous SAR (W/kg)	Limit (W/kg)	Verdict
Head	WCDMA RMC + 5G WLAN	1.138	1.6	Pass
Body-worn	LTE QPSK + 5G WLAN	1.548	1.6	Pass
Hotspot Mode	LTE QPSK + 5G WLAN	1.548	1.6	Pass

3.4 Test Uncertainty

According to KDB 865664 D01, when the highest measured 1 g SAR within a frequency band is < 1.5 W/kg, the extensive SAR measurement uncertainty analysis is not required in SAR reports submitted for equipment approval.

The maximum 1 g SAR for the EUT in this report is 1.058 W/kg, which is lower than 1.5 W/kg, so the the extensive SAR measurement uncertainty analysis is not required in this report.

4 SAR MEASUREMENT SYSTEM

4.1 Definition of Specific Absorption Rate (SAR)

SAR is related to the rate at which energy is absorbed per unit mass in an object exposed to a radio field. The SAR distribution in a biological body is complicated and is usually carried out by experimental techniques or numerical modeling. The standard recommends limits for two tiers of groups, occupational/controlled and general population/uncontrolled, based on a person's awareness and ability to exercise control over his or her exposure. In general, occupational / controlled exposure limits are higher than the limits for general population /uncontrolled.

The SAR definition is the time derivative (rate) of the incremental energy (dW) absorbed by (dissipated in) an incremental mass (dm) contained in a volume element (dv) of a given density (ρ). The equation description is as below:

$$\text{SAR} = \frac{d}{dt} \left(\frac{dW}{dm} \right) = \frac{d}{dt} \left(\frac{dW}{\rho dv} \right)$$

SAR is expressed in units of Watts per kilogram (W/kg) SAR measurement can be related to the electrical field in the tissue by

$$\text{SAR} = \frac{\sigma E^2}{\rho}$$

Where: σ is the conductivity of the tissue,

ρ is the mass density of the tissue and E is the RMS electrical field strength.

4.2 SATIMO SAR System

4.2.1 SATIMO SAR System Diagram

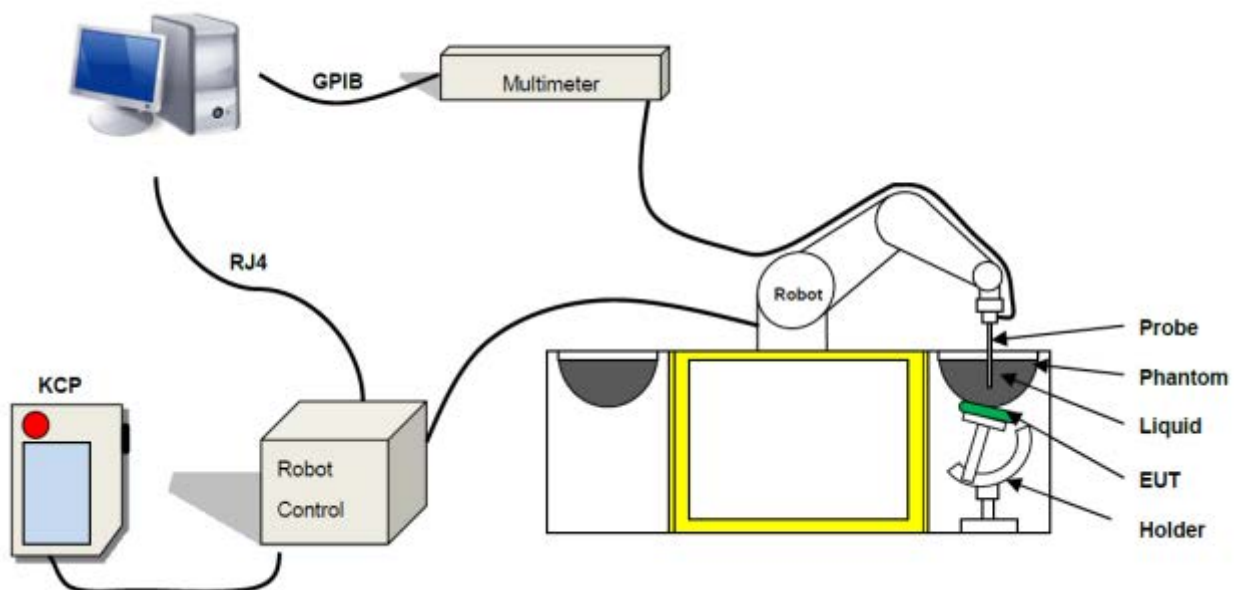

These measurements were performed with the automated near-field scanning system OPENSAR from SATIMO. The system is based on a high precision robot (working range: 850 mm), which positions the probes with a positional repeatability of better than ± 0.02 mm. Special E- and H-field probes have been developed for measurements close to material discontinuity, the sensors of which are directly loaded with a Schottky diode and connected via highly resistive lines to the data acquisition unit.

The SAR measurements were conducted with dosimetric probe (manufactured by SATIMO), designed in the classical triangular configuration and optimized for dosimetric evaluation. The probe has been calibrated according to the procedure described in SAR standard with accuracy of better than $\pm 10\%$. The spherical isotropy was evaluated with the procedure described in SAR standard and found to be better than ± 0.25 dB. The phantom used was the SAM Phantom as described in FCC supplement C, IEEE P1528.

4.2.2 Robot

The SATIMO SAR system uses the high precision robots from KUKA. For the 6-axis controller system, the robot controller version (KUKA) from KUKA is used. The KUKA robot series have many features that are important for our application:



- High precision (repeatability ± 0.035 mm)
- High reliability (industrial design)
- Jerk-free straight movements
- Low ELF interference (the closed metallic construction shields against motor control fields)

4.2.3 E-Field Probe

For the measurements the Specific Dosimetric E-Field Probe SN 34/15 EPGO 265 with following specifications is used

- Dynamic range: 0.01-100 W/kg
- Tip Diameter : 2.5 mm
- Lower detection limit : 7 mW/kg
(repeatability better than ± 1 mm)
- Probe linearity: ± 0.07 dB

- Calibration range: 450 MHz to 5800 MHz for head & body simulating liquid.

Angle between probe axis (evaluation axis) and surface normal line: less than 30°



E-Field Probe Calibration Process

Probe calibration is realized, in compliance with CENELEC EN 62209-1/-2 and IEEE 1528 std, with CALISAR, Antennessa proprietary calibration system. The calibration is performed with the IEC62209-1/2 annexe technique using reference guide at the five frequencies.

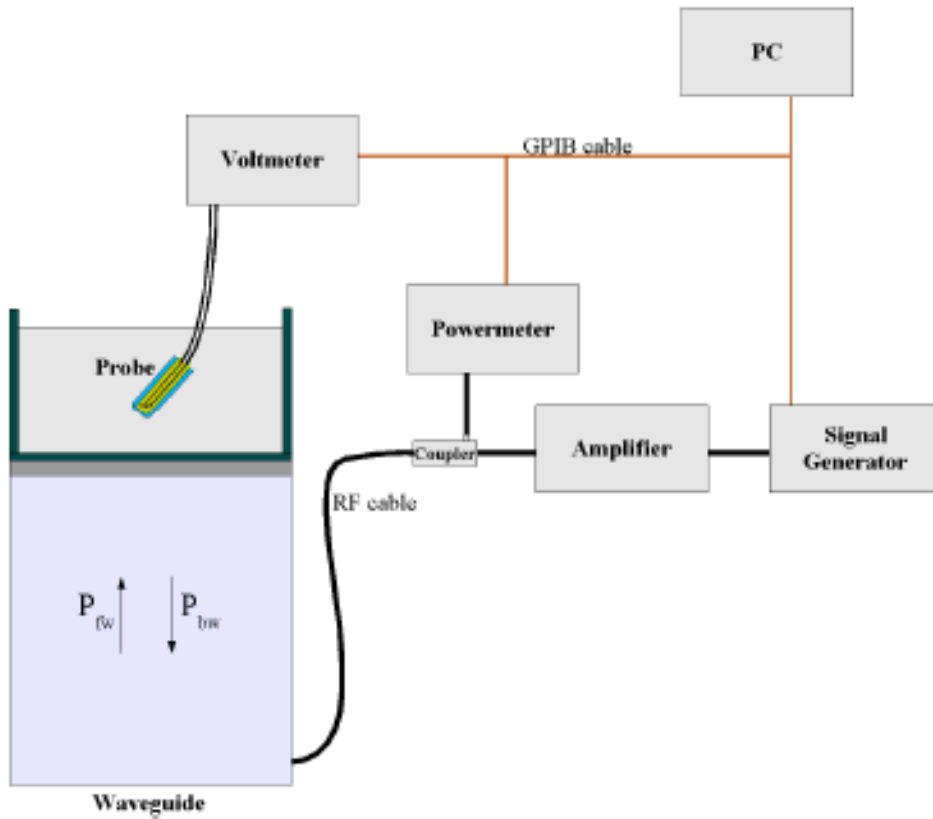

$$SAR = \frac{4(P_{fw} - P_{bw})}{ab\sigma} \cos^2 \left(\pi \frac{y}{a} \right) c^{(2\pi/\sigma)}$$

Where :

- P_{fw} = Forward Power
- P_{bw} = Backward Power
- a and b = Waveguide Dimensions
- l = Skin Depth

Keithley configuration

Rate = Medium; Filter =ON; RDGS=10; FILTER TYPE =MOVING AVERAGE; RANGE AUTO After each calibration, a SAR measurement is performed on a validation dipole and compared with a NPL calibrated probe, to verify it.

The calibration factors, CF(N), for the 3 sensors corresponding to dipole 1, dipole 2 and dipole 3 are:

$$CF(N)=SAR(N)/V_{lin}(N) \quad (N=1,2,3)$$

The linearised output voltage $V_{lin}(N)$ is obtained from the displayed output voltage $V(N)$ using

$$V_{lin}(N)=V(N)*(1+V(N)/DCP(N)) \quad (N=1,2,3)$$

Where the DCP is the diode compression point in mV.

4.2.4 Phantoms

For the measurements the Specific Anthropomorphic Mannequin (SAM) defined by the IEEE SCC-34/SC2 group is used. The phantom is a polyurethane shell integrated in a wooden table. The thickness of the phantom amounts to 2mm +/- 0.2mm. It enables the dosimetric evaluation of left and right phone usage and includes an additional flat phantom part for the simplified performance check. The phantom set-up includes a cover, which prevents the evaporation of the liquid.

Photo of Phantom SN 30/13 SAM103



Photo of Phantom SN 30/13 SAM104



Serial Number	Positionner Material	Permittivity	Loss Tangent
SN 30/13 SAM103	Gelcoat with fiberglass	3.4	0.02
SN 30/13 SAM104	Gelcoat with fiberglass	3.4	0.02

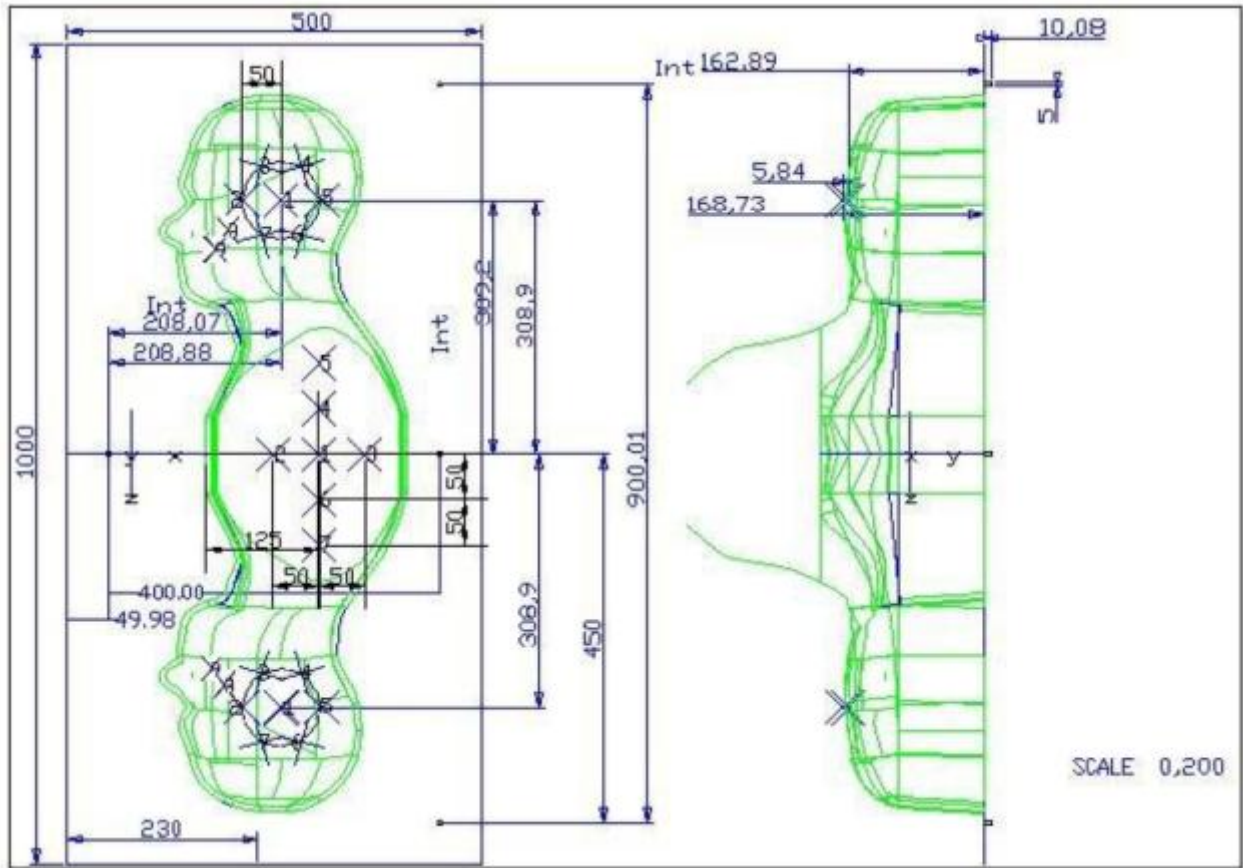

Serial Number	Left Head		Right Head		Flat Part	
SN 30/13 SAM103	2	2.00	2	2.03	1	2.09
	3	2.02	3	2.05	2	2.10
	4	2.04	4	2.04	3	2.09
	5	2.04	5	2.07	4	2.11
	6	2.02	6	2.07	5	2.11
	7	2.01	7	2.09	6	2.09
	8	2.04	8	2.10	7	2.11
	9	2.02	9	2.09	-	-
	SN 30/13 SAM104	2	2.05	2	2.06	1
3		2.08	3	2.03	2	2.03
4		2.05	4	2.03	3	2.01
5		2.06	5	2.02	4	2.03
6		2.08	6	2.02	5	2.03
7		2.06	7	2.04	6	2.00
8		2.07	8	2.04	7	1.98
9		2.07	9	2.05	-	-

4.2.5 Device Holder

The SAR in the phantom is approximately inversely proportional to the square of the distance between the source and the liquid surface. For a source at 5 mm distance, a positioning uncertainty of ± 0.5 mm would produce a SAR uncertainty of ± 20 %. Accurate device positioning is therefore crucial for accurate and repeatable measurements. The positions in which the devices must be measured are defined by the standards.



Serial Number	Holder Material	Permittivity	Loss Tangent
SN 25/13 MSH87	Deirin	3.7	0.005
SN 25/13 MSH88	Deirin	3.7	0.005

The positioning system allows obtaining cheek and tilting position with a very good accuracy. In compliance with CENELEC, the tilt angle uncertainty is lower than 1° .

4.2.6 Simulating Liquid

For SAR measurement of the field distribution inside the phantom, the phantom must be filled with homogeneous tissue simulating liquid to a depth of at least 15 cm. For head SAR testing, the liquid height from the ear reference point (ERP) of the phantom to the liquid top surface is larger than 15 cm. For body SAR testing, the liquid height from the center of the flat phantom to the liquid top surface is larger than 15 cm. The nominal dielectric values of the tissue simulating liquids in the phantom and the tolerance of 5%.

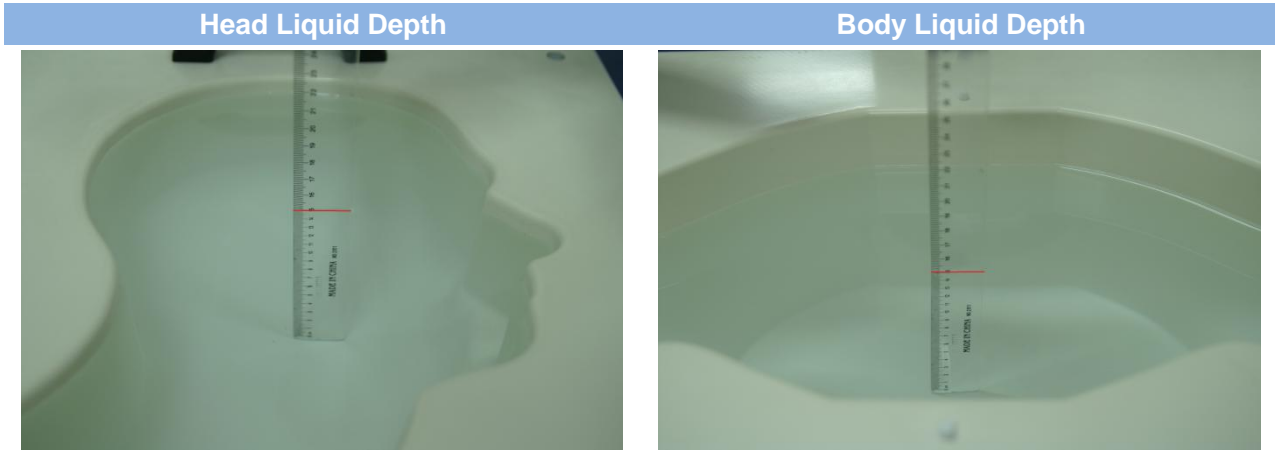

The following table gives the recipes for tissue simulating liquid and the theoretical Conductivity/Permittivity.

Head (Reference IEEE1528)								
Frequency (MHz)	Water (%)	Sugar (%)	Cellulose (%)	Salt (%)	Preventol (%)	DGBE (%)	Conductivity σ (S/m)	Permittivity ϵ
750	41.1	57.0	0.2	1.4	0.2	0	0.89	41.9
835	40.3	57.9	0.2	1.4	0.2	0	0.90	41.5
900	40.3	57.9	0.2	1.4	0.2	0	0.97	41.5
1800, 1900, 2000	55.2	0	0	0.3	0	44.5	1.4	40.0
2450	55.0	0	0	0.1	0	44.9	1.80	39.2
2600	54.9	0	0	0.1	0	45.0	1.96	39.0
Frequency(MHz)	Water (%)	Hexyl Carbitol (%)			Triton X-100 (%)		Conductivity σ (S/m)	Permittivity ϵ
5200	62.52	17.24			17.24		4.66	36.0
5800	62.52	17.24			17.24		5.27	35.3
Body (From instrument manufacturer)								
Frequency (MHz)	Water (%)	Sugar (%)	Cellulose (%)	Salt (%)	Preventol (%)	DGBE (%)	Conductivity σ (S/m)	Permittivity ϵ
750	51.7	47.2	0	0.9	0.1	0	0.96	55.5
835	50.8	48.2	0	0.9	0.1	0	0.97	55.2
900	50.8	48.2	0	0.9	0.1	0	1.05	55.0
1800, 1900, 2000	70.2	0	0	0.4	0	29.4	1.52	53.3
2450	68.6	0	0	0.1	0	31.3	1.95	52.7
2600	68.2	0	0	0.1	0	31.7	2.16	52.5

Frequency(MHz)	Water	DGBE (%)	Salt (%)	Conductivity σ (S/m)	Permittivity ϵ
5200	78.60	21.40	/	5.54	47.86
5800	78.50	21.40	0.1	6.0	48.20

5 SYSTEM VERIFICATION

5.1 Antenna Port Test Requirement

The SATIMO SAR system is equipped with one or more system validation kits. These units together with the predefined measurement procedures within the SATIMO software enable the user to conduct the system performance check and system validation. System validation kit includes a dipole, tripod holder to fix it underneath the flat phantom and a corresponding distance holder.

5.2 Purpose of System Check

The system performance check verifies that the system operates within its specifications. System and operator errors can be detected and corrected. It is recommended that the system performance check be performed prior to any usage of the system in order to guarantee reproducible results. The system performance check uses normal SAR measurements in a simplified setup with a well characterized source. This setup was selected to give a high sensitivity to all parameters that might fail or vary over time. The system check does not intend to replace the calibration of the components, but indicates situations where the system uncertainty is exceeded due to drift or failure.

5.3 System Check Setup

In the simplified setup for system evaluation, the EUT is replaced by a calibrated dipole and the power source is replaced by a continuous wave that comes from a signal generator. The calibrated dipole must be placed beneath the flat phantom section of the SAM twin phantom with the correct distance holder. The distance holder should touch the phantom surface with a light pressure at the reference marking and be oriented parallel to the long side of the phantom. The equipment setup is shown below:

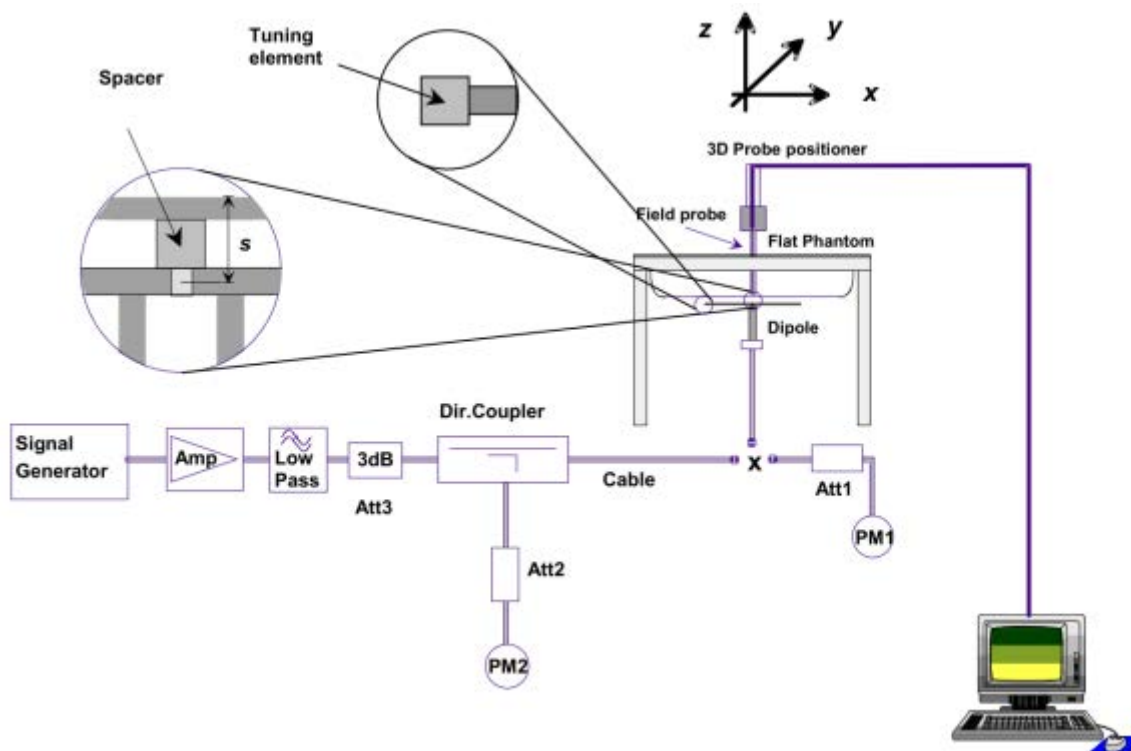

6 EUT TEST POSITION CONFIGURATIONS

According to KDB 648474 D04 Handset, handsets are tested for SAR compliance in head, body-worn accessory and other use configurations described in the following subsections.

6.1 Head Exposure Conditions

Head exposure is limited to next to the ear voice mode operations. Head SAR compliance is tested according to the test positions defined in IEEE Std 1528-2013 using the SAM phantom illustrated as below.

6.1.1 Define two imaginary lines on the handset

- The vertical center line passes through two points on the front side of the handset - the midpoint of the width w_t of the handset at the level of the acoustic output, and the midpoint of the width w_b of the bottom of the handset.
- The horizontal line is perpendicular to the vertical centerline and passes through the center of the acoustic output. The horizontal line is also tangential to the face of the handset at point A.
- The two lines intersect at point A. Note that for many handsets, point A coincides with the center of the acoustic output; however, the acoustic output may be located elsewhere on the horizontal line. Also note that the vertical centerline is not necessarily parallel to the front face of the handset, especially for clamshell handsets, handsets with flip covers, and other irregularly shaped handsets.

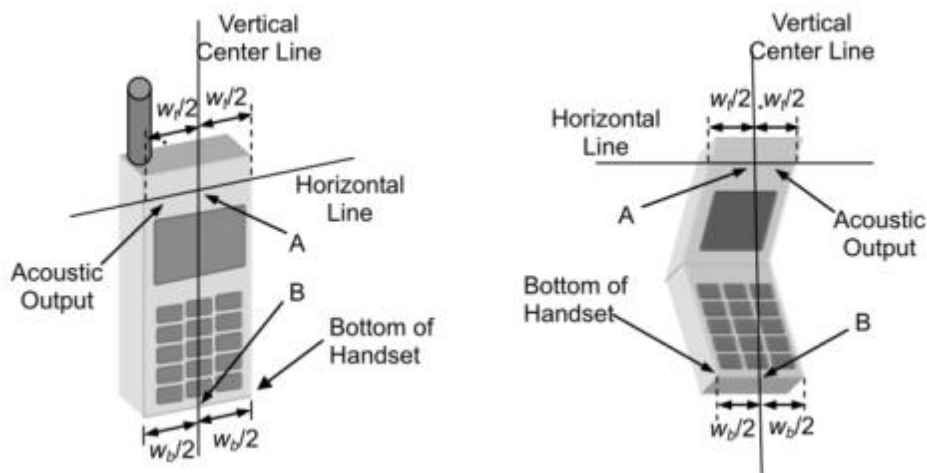

6.1.2 Cheek Position

- To position the device with the vertical center line of the body of the device and the horizontal line crossing the center piece in a plane parallel to the sagittal plane of the phantom. While maintaining the device in this plane, align the vertical center line with the reference plane containing the three ear and mouth reference point (M: Mouth, RE: Right Ear, and LE: Left Ear) and align the center of the ear piece with the line RE-LE.
- To move the device towards the phantom with the ear piece aligned with the line LE-RE until the phone touched the ear. While maintaining the device in the reference plane and maintaining the phone contact with the ear, move the bottom of the phone until any point on the front side is in contact with the cheek of the phantom or until contact with the ear is lost.



6.1.3 Tilted Position

- (a) To position the device in the “cheek” position described above.
- (b) While maintaining the device the reference plane described above and pivoting against the ear, moves it outward away from the mouth by an angle of 15 degrees or until contact with the ear is lost.



6.2 Body-worn Position Conditions

Body-worn accessory exposure is typically related to voice mode operations when handsets are carried in body-worn accessories. The body-worn accessory procedures in KDB 447498 are used to test for body-worn accessory SAR compliance, without a headset connected to it. This enables the test results for such configuration to be compatible with that required for hotspot mode when the body-worn accessory test separation distance is greater than or equal to that required for hotspot mode. When the reported SAR for a body-worn accessory, measured without a headset connected to the handset, is $> 1.2 \text{ W/kg}$, the highest reported SAR configuration for that wireless mode and frequency band should be repeated for that body-worn accessory with a headset attached to the handset.

Body-worn accessories that do not contain metallic or conductive components may be tested according to worst-case exposure configurations, typically according to the smallest test separation distance required for the group of body-worn accessories with similar operating and exposure characteristics. All body-worn accessories containing metallic components are tested in conjunction with the host device.

Body-worn accessory SAR compliance is based on a single minimum test separation distance for all wireless and operating modes applicable to each body-worn accessory used by the host, and according to the relevant voice and/or data mode transmissions and operations. If a body-worn accessory supports voice only operations in its normal and expected use conditions, testing of data mode for body-worn compliance is not required. A conservative minimum test separation distance for supporting off-the-shelf body-worn accessories that may be acquired by

users of consumer handsets is used to test for body-worn accessory SAR compliance. This distance is determined by the handset manufacturer, according to the requirements of Supplement C 01-01. Devices that are designed to operate on the body of users using lanyards and straps, or without requiring additional body-worn accessories, will be tested using a conservative minimum test separation distance ≤ 5 mm to support compliance.

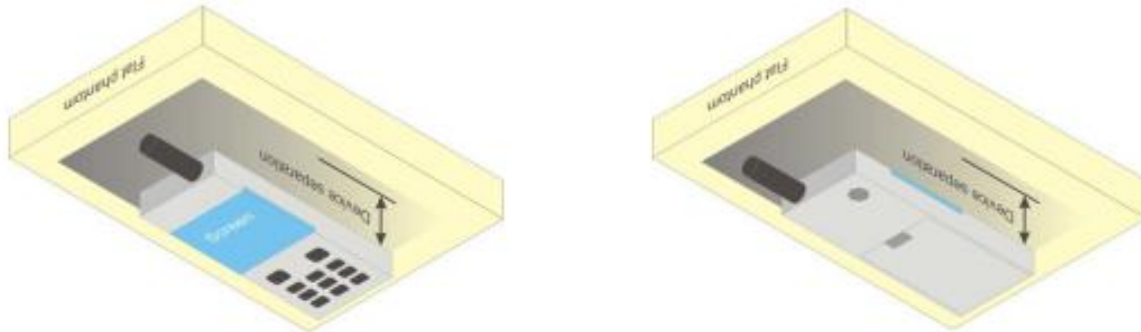

6.3 Hotspot Mode Exposure Position Conditions

For handsets that support hotspot mode operations, with wireless router capabilities and various web browsing functions, the relevant hand and body exposure conditions are tested according to the hotspot SAR procedures in KDB 941225. A test separation distance of 10 mm is required between the phantom and all surfaces and edges with a transmitting antenna located within 25 mm from that surface or edge. When the form factor of a handset is smaller than 9 cm x 5 cm, a test separation distance of 5 mm (instead of 10 mm) is required for testing hotspot mode. When the separation distance required for body-worn accessory testing is larger than or equal to that tested for hotspot mode, in the same wireless mode and for the same surface of the phone, the hotspot mode SAR data may be used to support body-worn accessory SAR compliance for that particular configuration (surface).

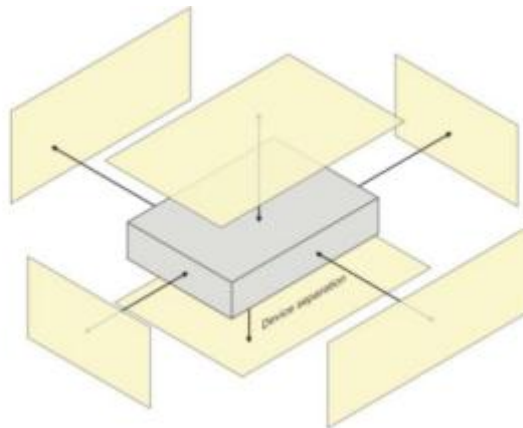

7 SAR MEASUREMENT PROCEDURES

7.1 SAR Measurement Process Diagram

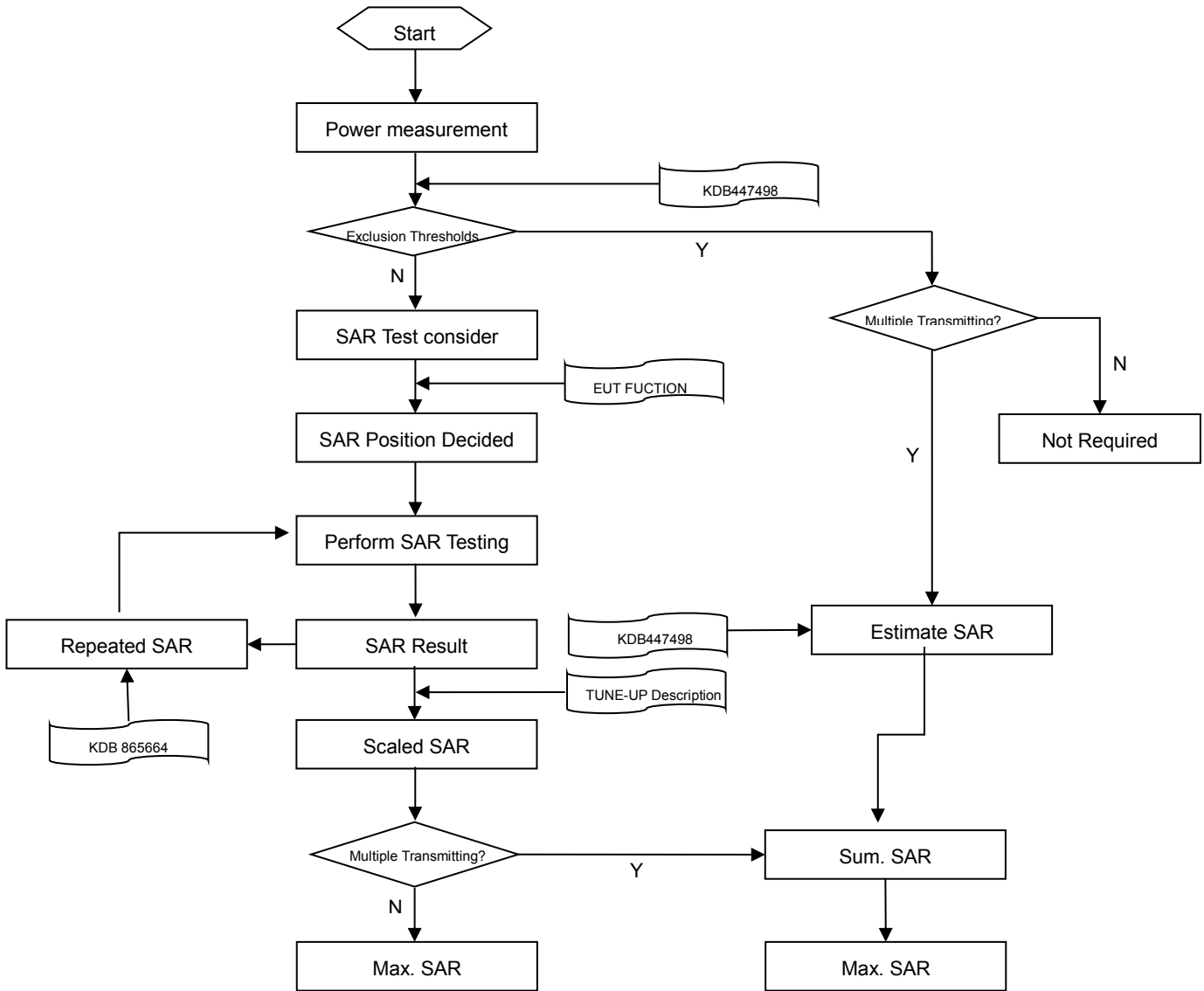

7.2 SAR Scan General Requirements

Probe boundary effect error compensation is required for measurements with the probe tip closer than half a probe tip diameter to the phantom surface. Both the probe tip diameter and sensor offset distance must satisfy measurement protocols; to ensure probe boundary effect errors are minimized and the higher fields closest to the phantom surface can be correctly measured and extrapolated to the phantom surface for computing 1-g SAR. Tolerances of the post-processing algorithms must be verified by the test laboratory for the scan resolutions used in the SAR measurements, according to the reference distribution functions specified in IEEE Std 1528-2013.

		$\leq 3\text{GHz}$	$> 3\text{GHz}$
Maximum distance from closest measurement point (geometric center of probe sensors) to phantom surface		$5 \pm 1 \text{ mm}$	$\frac{1}{2} \cdot \delta \cdot \ln(2) \pm 0.5 \text{ mm}$
Maximum probe angle from probe axis to phantom surface normal at the measurement location		$30^\circ \pm 1^\circ$	$20^\circ \pm 1^\circ$
Maximum area scan spatial resolution: $\Delta x \text{ Area}$, $\Delta y \text{ Area}$		$\leq 2 \text{ GHz}: \leq 15 \text{ mm}$ $2 - 3 \text{ GHz}: \leq 12 \text{ mm}$	$3-4 \text{ GHz}: \leq 12 \text{ mm}$ $4 - 6 \text{ GHz}: \leq 10 \text{ mm}$
		When the x or y dimension of the test device, in the measurement plane orientation, is smaller than the above, the measurement resolution must be \leq the corresponding x or y dimension of the test device with at least one measurement point on the test device.	
Maximum zoom scan spatial resolution: $\Delta x \text{ Zoom}$, $\Delta y \text{ Zoom}$		$\leq 2 \text{ GHz}: \leq 8 \text{ mm}$ $2 - 3 \text{ GHz}: \leq 5 \text{ mm}^*$	$3-4 \text{ GHz}: \leq 5 \text{ mm}^*$ $4 - 6 \text{ GHz}: \leq 4 \text{ mm}^*$
Maximum zoom scan spatial resolution, normal to phantom surface	uniform grid: $\Delta z \text{ Zoom} (n)$	$\leq 5 \text{ mm}$	$3-4 \text{ GHz}: \leq 4 \text{ mm}$
			$4-5 \text{ GHz}: \leq 3 \text{ mm}$
			$5-6 \text{ GHz}: \leq 2 \text{ mm}$
	graded grid	$\Delta z \text{ Zoom} (1)$: between 1st two points closest to phantom surface	$\leq 4 \text{ mm}$
$4-5 \text{ GHz}: \leq 2.5 \text{ mm}$			
	$\Delta z \text{ Zoom} (n>1)$: between subsequent points	$\leq 1.5 \cdot \Delta z \text{ Zoom} (n-1)$	
Minimum zoom scan volume	x, y, z	$\geq 30 \text{ mm}$	$3-4 \text{ GHz}: \geq 28 \text{ mm}$
			$4-5 \text{ GHz}: \geq 25 \text{ mm}$
			$5-6 \text{ GHz}: \geq 22 \text{ mm}$

Note:

- δ is the penetration depth of a plane-wave at normal incidence to the tissue medium; see draft standard IEEE P1528-2011 for details.
- * When zoom scan is required and the reported SAR from the area scan based 1-g SAR estimation procedures of KDB 447498 is $\leq 1.4 \text{ W/kg}$, $\leq 8 \text{ mm}$, $\leq 7 \text{ mm}$ and $\leq 5 \text{ mm}$ zoom scan resolution may be applied, respectively, for 2 GHz to 3GHz, 3 GHz to 4 GHz and 4 GHz to 6 GHz.

7.3 SAR Measurement Procedure

The following steps are used for each test position

- Establish a call with the maximum output power with a base station simulator. The connection between the mobile and the base station simulator is established via air interface
- Measurement of the local E-field value at a fixed location. This value serves as a reference value for calculating a possible power drift.
- Measurement of the SAR distribution with a grid of 8 to 16mm * 8 to 16 mm and a constant distance to the inner surface of the phantom. Since the sensors cannot directly measure at the inner phantom surface, the values between the sensors and the inner phantom surface are extrapolated. With these values the area of the maximum SAR is calculated by an interpolation scheme.
- Around this point, a cube of 30 * 30 * 30 mm or 32 * 32 * 32 mm is assessed by measuring 5 or 8 * 5 or 8*4 or 5 mm. With these data, the peak spatial-average SAR value can be calculated.

7.4 Area & Zoom Scan Procedures

First Area Scan is used to locate the approximate location(s) of the local peak SAR value(s). The measurement grid within an Area Scan is defined by the grid extent, grid step size and grid offset. Next, in order to determine the EM field distribution in a three-dimensional spatial extension, Zoom Scan is required. The Zoom Scan is performed around the highest E-field value to determine the averaged SAR-distribution over 10 g. Area scan and zoom scan resolution setting follows KDB 865664 D01 quoted below.

When the 1-g SAR of the highest peak is within 2 dB of the SAR limit, additional zoom scans are required for other peaks within 2 dB of the highest peak that have not been included in any zoom scan to ensure there is no increase in SAR.

8 CONDUCTED RF OUTPUT POWER

8.1 GSM

GSM 850 Band	Burst Average Power(dBm)			Frame-averaged power(dBm)		
Channel	128	190	251	128	190	251
GSM (GMSK, 1-Slot)	32.78	32.76	32.76	23.78	23.76	23.76
GPRS (GMSK, 1-Slot)	32.81	32.79	32.77	23.81	23.79	23.77
GPRS (GMSK, 2-Slots)	31.65	31.52	31.43	25.65	25.52	25.43
GPRS (GMSK, 3-Slots)	30.30	30.11	28.86	26.04	25.85	24.60
GPRS (GMSK, 4-Slots)	29.34	29.07	28.87	26.34	26.07	25.87
EGPRS (8PSK, 1-Slot)	30.31	30.25	30.42	21.31	21.25	21.42
EGPRS (8PSK, 2-Slots)	28.57	28.54	28.52	22.57	22.54	22.52
EGPRS (8PSK, 3-Slots)	27.03	26.04	27.09	22.77	21.78	22.83
EGPRS (8PSK, 4-Slots)	26.16	26.03	26.20	23.16	23.03	23.20
GSM 1900 Band	Burst Average Power(dBm)			Frame-averaged power(dBm)		
Channel	512	661	810	512	661	810
GSM (GMSK, 1-Slot)	30.29	30.31	30.34	21.29	21.31	21.34
GPRS (GMSK, 1-Slot)	30.28	30.32	30.36	21.28	21.32	21.36
GPRS (GMSK, 2-Slots)	28.60	28.81	29.04	22.60	22.81	23.04
GPRS (GMSK, 3-Slots)	27.19	27.47	27.82	22.93	23.21	23.56
GPRS (GMSK, 4-Slots)	26.16	26.76	26.87	23.16	23.76	23.87
EGPRS (8PSK, 1-Slot)	29.95	29.83	29.68	20.95	20.83	20.68
EGPRS (8PSK, 2-Slots)	28.53	28.40	28.31	22.53	22.40	22.31
EGPRS (8PSK, 3-Slots)	27.23	27.14	27.06	22.97	22.88	22.80
EGPRS (8PSK, 4-Slots)	26.11	26.10	26.19	23.11	23.10	23.19

Note 1: SAR testing was performed on the maximum frame-Peaked power mode.

Note 2: The frame-averaged power is linearly proportion to the slot number configured and it is linearly scaled the maximum burst-averaged power based on time slots. The calculated method is shown as below:

Frame-averaged power = Burst averaged power (1 Tx Slot) - 9 dB

Frame-averaged power = Burst averaged power (2 Tx Slots) - 6 dB

Frame-averaged power = Burst averaged power (3 Tx Slots) - 4.26 dB

Frame-averaged power = Burst averaged power (4 Tx Slots) - 3 dB

8.2 WCDMA

WCDMA Band	Band 2			Band 4		
Channel	9262	9400	9538	1312	1412	1513
RMC 12.2Kbps	22.89	22.49	22.95	22.80	23.37	22.84
HSDPA Subtest-1	21.93	21.57	22.05	22.28	22.49	21.93
HSDPA Subtest-2	21.80	21.61	22.04	22.33	22.40	21.80
HSDPA Subtest-3	21.41	21.16	21.60	21.85	21.96	21.35
HSDPA Subtest-4	21.38	21.12	21.57	21.80	21.93	21.33
HSUPA Subtest-1	19.33	19.64	20.07	20.32	20.46	19.88
HSUPA Subtest-2	19.34	19.63	20.07	20.33	20.41	19.86
HSUPA Subtest-3	20.34	20.59	21.07	21.38	21.49	20.85
HSUPA Subtest-4	18.90	19.08	19.59	19.84	19.91	19.36
HSUPA Subtest-5	20.85	20.54	21.00	21.30	21.37	20.90
Band	Band 5			-		
Channel	4132	4182	4233	-	-	-
RMC 12.2Kbps	22.27	22.30	22.16	-	-	-
HSDPA Subtest-1	21.23	21.35	21.23	-	-	-
HSDPA Subtest-2	21.29	21.35	21.21	-	-	-
HSDPA Subtest-3	20.80	20.89	20.75	-	-	-
HSDPA Subtest-4	20.75	20.86	20.73	-	-	-
HSUPA Subtest-1	19.33	19.39	19.17	-	-	-
HSUPA Subtest-2	19.25	19.30	19.22	-	-	-
HSUPA Subtest-3	20.32	20.34	20.19	-	-	-
HSUPA Subtest-4	18.82	18.89	18.74	-	-	-
HSUPA Subtest-5	20.26	20.30	20.20	-	-	-

8.3 LTE

FDD LTE Band 2							
Bandwidth (MHz)	RB Set	Power (dBm)					
		QPSK			16QAM		
	Channel	18700	18900	19100	18700	18900	19100
20MHz	1 (RB_Pos:0)	22.97	22.94	22.90	22.38	22.20	22.03
	1 (RB_Pos:50)	22.74	22.68	22.71	22.22	21.90	21.89
	1 (RB_Pos:99)	22.87	22.77	22.60	22.32	21.93	21.95
	50 (RB_Pos:0)	21.81	21.73	21.76	20.84	20.71	20.74
	50 (RB_Pos:25)	21.77	21.59	21.62	20.79	20.57	20.58
	50 (RB_Pos:50)	21.80	21.52	21.61	20.84	20.49	20.56
	100 (RB_Pos:0)	21.82	21.64	21.72	20.87	20.63	20.70
Bandwidth (MHz)	RB Set	Power (dBm)					
		QPSK			16QAM		
	Channel	18675	18900	19125	18675	18900	19125
15MHz	1 (RB_Pos:0)	22.93	22.89	23.08	21.68	22.07	22.15
	1 (RB_Pos:38)	22.77	22.69	22.95	21.58	21.85	22.06
	1 (RB_Pos:74)	22.81	22.68	22.76	21.61	21.82	22.02
	36 (RB_Pos:0)	21.86	21.79	22.00	20.79	20.74	20.89
	36 (RB_Pos:20)	21.82	21.71	21.95	20.74	20.65	20.83
	36 (RB_Pos:39)	21.81	21.65	21.95	20.76	20.59	20.82
	75 (RB_Pos:0)	21.85	21.72	21.99	20.80	20.63	20.88
Bandwidth (MHz)	RB Set	Power (dBm)					
		QPSK			16QAM		
	Channel	18650	18900	19150	18650	18900	19150
10MHz	1 (RB_Pos:0)	23.02	22.78	23.07	21.71	21.97	21.96
	1 (RB_Pos:25)	22.96	22.71	23.06	21.70	21.88	21.92
	1 (RB_Pos:49)	22.96	22.68	22.86	21.72	21.83	21.88
	25 (RB_Pos:0)	21.81	21.60	22.00	20.85	20.62	21.08
	25 (RB_Pos:12)	21.81	21.55	21.97	20.85	20.56	21.05
	25 (RB_Pos:25)	21.82	21.51	21.95	20.85	20.50	21.01
	50 (RB_Pos:0)	21.83	21.55	21.97	20.84	20.53	21.00
Bandwidth (MHz)	RB Set	Power (dBm)					
		QPSK			16QAM		
	Channel	18625	18900	19175	18625	18900	19175
5MHz	1 (RB_Pos:0)	22.94	22.57	22.97	22.03	21.95	21.88
	1 (RB_Pos:13)	22.93	22.53	22.99	22.00	21.91	21.85
	1 (RB_Pos:24)	22.93	22.53	22.92	22.03	21.89	21.87
	12 (RB_Pos:0)	21.99	21.58	21.96	21.03	20.66	20.95
	12 (RB_Pos:6)	22.02	21.60	21.99	21.06	20.67	20.98
	12 (RB_Pos:13)	21.99	21.53	21.94	21.04	20.62	20.92
	25 (RB_Pos:0)	21.97	21.51	21.90	21.00	20.54	20.83
Bandwidth (MHz)	RB Set	Power (dBm)					
		QPSK			16QAM		

	Channel	18615	18900	19185	18615	18900	19185
3.0MHz	1 (RB_Pos:0)	23.10	22.64	22.95	21.81	21.85	21.82
	1 (RB_Pos:8)	23.04	22.57	22.91	21.76	21.76	21.71
	1 (RB_Pos:14)	23.09	22.62	23.03	21.82	21.79	21.77
	8 (RB_Pos:0)	22.10	21.64	22.01	21.17	20.65	20.96
	8 (RB_Pos:3)	22.13	21.68	22.07	21.19	20.67	20.99
	8 (RB_Pos:7)	22.16	21.68	22.08	21.21	20.66	21.00
	15 (RB_Pos:0)	22.12	21.57	21.96	21.12	20.59	20.87
Bandwidth (MHz)	RB Set	Power (dBm)					
		QPSK			16QAM		
	Channel	18607	18900	19193	18607	18900	19193
1.4MHz	1 (RB_Pos:0)	23.02	22.54	22.81	22.04	21.83	21.74
	1 (RB_Pos:3)	23.01	22.54	22.86	21.99	21.74	21.67
	1 (RB_Pos:5)	23.06	22.53	22.89	22.09	21.82	21.78
	3 (RB_Pos:0)	23.01	22.55	22.81	22.13	21.70	21.92
	3 (RB_Pos:1)	23.05	22.55	22.82	22.06	21.68	21.95
	3 (RB_Pos:3)	23.08	22.55	22.75	22.04	21.73	21.96
	6 (RB_Pos:0)	22.02	21.53	21.92	21.06	20.38	20.88

LTE Band 4							
Bandwidth (MHz)	RB Set	Power (dBm)					
		QPSK			16QAM		
20 MHz	Channel	20050	20175	20300	20050	20175	20300
	1 (RB_Pos:0)	23.39	23.68	23.58	22.55	22.96	22.76
	1 (RB_Pos:50)	23.01	23.49	23.27	22.44	22.76	22.52
	1 (RB_Pos:99)	23.14	23.57	23.38	22.51	22.82	22.57
	50 (RB_Pos:0)	21.97	22.58	22.41	21.00	21.59	21.39
	50 (RB_Pos:25)	21.97	22.43	22.23	21.00	21.43	21.22
	50 (RB_Pos:50)	21.97	22.35	22.24	21.01	21.36	21.23
	100 (RB_Pos:0)	21.96	22.48	22.34	21.03	21.47	21.34
15 MHz	Channel	20025	20175	20325	20025	20175	20325
	1 (RB_Pos:0)	23.19	23.64	23.63	21.94	22.85	22.75
	1 (RB_Pos:38)	23.07	23.52	23.39	21.89	22.71	22.58
	1 (RB_Pos:74)	23.09	23.54	23.48	21.92	22.74	22.57
	36 (RB_Pos:0)	22.11	22.59	22.47	21.05	21.55	21.39
	36 (RB_Pos:20)	22.11	22.53	22.40	21.05	21.48	21.31
	36 (RB_Pos:39)	22.13	22.49	22.39	21.07	21.44	21.31
	75 (RB_Pos:0)	22.16	22.55	22.45	21.10	21.50	21.39
10 MHz	Channel	20000	20175	20350	20000	20175	20350
	1 (RB_Pos:0)	23.28	23.55	23.26	22.04	22.74	22.20
	1 (RB_Pos:25)	23.24	23.52	23.20	22.09	22.71	22.13
	1 (RB_Pos:49)	23.29	23.54	23.24	22.12	22.71	22.11
	25 (RB_Pos:0)	22.17	22.44	22.16	21.20	21.47	21.27
	25 (RB_Pos:12)	22.21	22.39	22.15	21.25	21.40	21.25
	25 (RB_Pos:25)	22.24	22.32	22.14	21.28	21.35	21.24
	50 (RB_Pos:0)	22.22	22.39	22.16	21.21	21.41	21.21
5 MHz	Channel	19975	20175	20375	19975	20175	20375
	1 (RB_Pos:0)	23.41	23.37	22.98	22.35	22.75	21.96
	1 (RB_Pos:13)	23.39	23.37	22.98	22.36	22.74	21.92
	1 (RB_Pos:24)	23.42	23.37	22.98	22.40	22.75	21.95
	12 (RB_Pos:0)	22.33	22.40	21.97	21.38	21.50	21.02
	12 (RB_Pos:6)	22.37	22.43	22.02	21.43	21.52	21.06
	12 (RB_Pos:13)	22.38	22.36	21.99	21.44	21.47	21.02
	25 (RB_Pos:0)	22.37	22.37	21.97	21.37	21.41	20.93
3 MHz	Channel	19965	20175	20385	19965	20175	20385
	1 (RB_Pos:0)	23.36	23.43	22.87	22.13	22.64	21.84
	1 (RB_Pos:8)	23.33	23.37	22.83	22.09	22.59	21.74
	1 (RB_Pos:14)	23.40	23.44	22.90	22.16	22.63	21.80
	8 (RB_Pos:0)	22.44	22.46	21.97	21.49	21.46	20.96
	8 (RB_Pos:3)	22.48	22.46	22.00	21.52	21.46	21.00
	8 (RB_Pos:7)	22.49	22.49	22.04	21.54	21.49	21.03
	15 (RB_Pos:0)	22.43	22.42	21.96	21.42	21.42	20.92

	Channel	19957	20175	20393	19957	20175	20393
1.4 MHz	1 (RB_Pos:0)	23.38	23.38	22.80	22.34	22.69	21.84
	1 (RB_Pos:3)	23.34	23.38	22.84	22.29	22.61	21.77
	1 (RB_Pos:5)	23.38	23.38	22.84	22.39	22.70	21.87
	3 (RB_Pos:0)	23.33	23.42	22.92	22.43	22.58	22.08
	3 (RB_Pos:1)	23.37	23.43	22.91	22.40	22.57	22.11
	3 (RB_Pos:3)	23.39	23.44	22.86	22.39	22.63	22.14
	6 (RB_Pos:0)	22.35	22.35	21.87	21.38	21.23	20.94

LTE Band 7							
Bandwidth (MHz)	RB Set	Power (dBm)					
		QPSK			16QAM		
20 MHz	Channel	20850	21100	21350	20850	21100	21350
	1 (RB_Pos:0)	22.69	22.65	22.76	22.07	21.83	21.51
	1 (RB_Pos:50)	22.54	22.11	21.96	21.86	21.57	21.54
	1 (RB_Pos:99)	22.64	22.49	22.02	21.82	21.89	21.9
	50 (RB_Pos:0)	21.42	21.57	21.56	20.48	20.54	19.97
	50 (RB_Pos:25)	21.46	21.14	20.88	20.53	19.84	20.34
	50 (RB_Pos:50)	21.44	21.19	21.12	20.48	20.26	20.13
	100 (RB_Pos:0)	21.43	21.24	21.48	20.48	20.48	20.49
15 MHz	Channel	20825	21100	21375	20825	21100	21375
	1 (RB_Pos:0)	22.58	22.48	22.72	21.34	21.97	21.48
	1 (RB_Pos:38)	22.46	22.17	22.28	21.29	21.43	21.30
	1 (RB_Pos:74)	22.59	22.34	22.41	21.36	21.67	21.50
	36 (RB_Pos:0)	21.48	21.61	21.64	20.43	20.61	20.45
	36 (RB_Pos:20)	21.51	21.42	21.50	20.47	20.48	20.32
	36 (RB_Pos:39)	21.56	21.49	21.47	20.50	20.36	20.41
	75 (RB_Pos:0)	21.55	21.56	21.58	20.50	20.58	20.51
10 MHz	Channel	20800	21100	21400	20800	21100	21400
	1 (RB_Pos:0)	22.44	22.23	22.36	21.22	21.78	21.36
	1 (RB_Pos:25)	22.45	22.17	22.21	21.26	21.6	21.33
	1 (RB_Pos:49)	22.54	22.18	22.36	21.34	21.73	21.33
	25 (RB_Pos:0)	21.30	21.39	21.42	20.37	20.48	20.56
	25 (RB_Pos:12)	21.38	21.32	21.37	20.46	20.43	20.52
	25 (RB_Pos:25)	21.46	21.37	21.37	20.53	20.48	20.52
	50 (RB_Pos:0)	21.41	21.42	21.43	20.43	20.49	20.51
5 MHz	Channel	20775	21100	21425	20775	21100	21425
	1 (RB_Pos:0)	22.43	22.00	22.3	21.38	21.69	21.33
	1 (RB_Pos:13)	22.41	22.14	22.36	21.39	21.6	21.29
	1 (RB_Pos:24)	22.45	21.99	22.37	21.43	21.67	21.34
	12 (RB_Pos:0)	21.32	21.27	21.38	20.43	20.47	20.47
	12 (RB_Pos:6)	21.39	21.27	21.41	20.49	20.47	20.50
	12 (RB_Pos:13)	21.40	21.24	21.39	20.50	20.45	20.48
	25 (RB_Pos:0)	21.37	21.25	21.37	20.41	20.40	20.40

8.4 WIFI

8.4.1 2.4GWIFI

Band (GHz)	Mode	Channel	Freq. (MHz)	Peak Power (dBm)	SAR Test Require.
2.4 (2.4~2.4835)	802.11b	1	2412	13.43	No
		6	2437	14.42	Yes
		11	2462	13.52	No
	802.11g	1	2412	14.27	No
		6	2437	15.37	No
		11	2462	14.76	No
	802.11n(HT20)	1	2412	12.39	No
		6	2437	13.48	No
		11	2462	12.63	No
	802.11n(HT40)	3	2422	12.01	No
		6	2437	12.53	No
		9	2452	11.90	No

Note: According KDB 248227 D01 SAR is not required for the following 2.4 GHz OFDM conditions. When the highest reported SAR for DSSS is adjusted by the ratio of OFDM to DSSS specified maximum output power and the adjusted SAR is ≤ 1.2 W/kg.
 adjusted SAR = Report SAR * (max power(OFDM)/ max power(DSSS))=0.557 * 1.26=0.702, so the 2.4GHz OFDM SAR test is not required.

8.4.2 5GWIFI

Band (GHz)	Mode	Channel	Freq. (MHz)	Peak Power (dBm)	SAR Test Require.
5.2 (5.15~5.25)	802.11a	36	5180	12.40	Yes
		44	5220	12.35	No
		48	5240	11.76	No
	802.11n(HT20)	36	5180	12.29	No
		44	5220	11.90	No
		48	5240	11.72	No
	802.11n(HT40)	38	5190	11.58	No
		46	5230	11.93	No
	5.8 (5.725~5.850)	802.11a	149	5745	11.16
157			5785	11.65	Yes
165			5825	11.05	No
802.11n(HT20)		149	5745	10.61	No
		157	5785	11.13	Yes
		165	5825	10.65	No
802.11n(HT40)		151	5755	9.73	No
		159	5795	10.23	No

8.5 Bluetooth

Mode	GFSK			$\pi/4$ -DQPSK		
Channel	0	39	78	0	39	78
Frequency (MHz)	2402	2441	2480	2402	2441	2480
Peak Power (dBm)	4.42	4.87	4.90	3.70	4.26	4.23
Mode	8-DPSK			BLE		
Channel	0	39	78	0	19	39
Frequency (MHz)	2402	2441	2480	2402	2440	2480
Peak Power (dBm)	3.83	4.40	4.40	-2.80	-1.63	-2.35

9 EUT ANTENNA LOCATION SKETCH

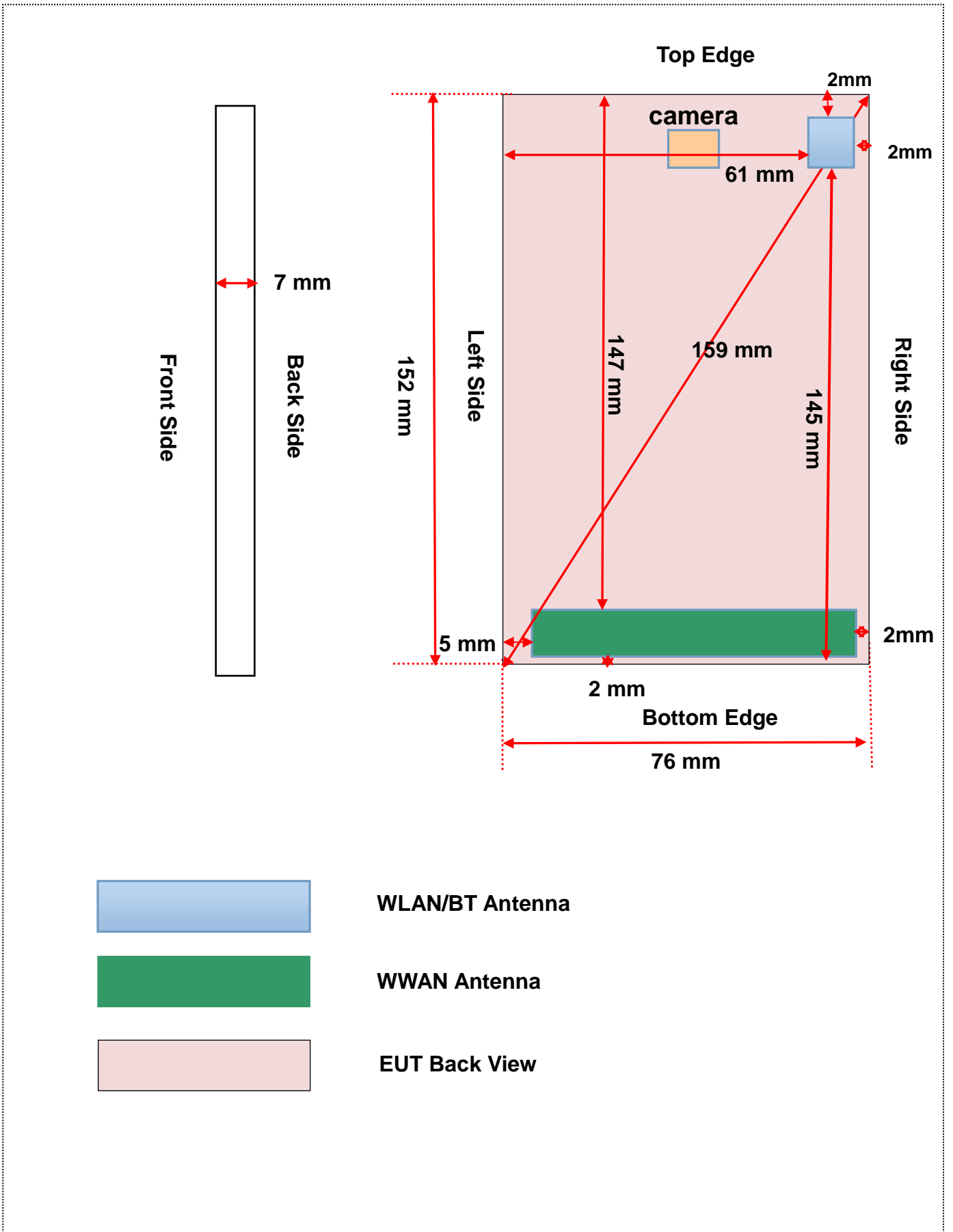

9.1 SAR Test Exclusion Consider Table

According with FCC KDB 447498 D01, Appendix A, <SAR Test Exclusion Thresholds for 100 MHz - 6 GHz and ≤ 50 mm> Table, this Device SAR test configurations consider as following :

Band	Mode	Max. Peak Power		Test Position Configurations					
		dBm	mW	Head	Front/ Back	Left Edge	Right Edge	Top Edge	Bottom Edge
GSM 850	Distance to User			<5mm	<5 mm	5mm	<5 mm	147 mm	<5mm
	Voice	32.90	1949.84	Yes	Yes	Yes	Yes	No	Yes
	Data	29.45	881.05	No	Yes	Yes	Yes	No	Yes
GSM 1900	Distance to User			<5mm	<5 mm	5mm	<5 mm	147 mm	<5mm
	Voice	30.45	1109.17	Yes	Yes	Yes	Yes	No	Yes
	Data	26.95	495.45	No	Yes	Yes	Yes	No	Yes
WCDMA Band 2	Distance to User			<5mm	<5 mm	5mm	<5 mm	147 mm	<5mm
	RMC	23.05	201.84	Yes	Yes	Yes	Yes	No	Yes
WCDMA Band 4	Distance to User			<5mm	<5 mm	5mm	<5 mm	147 mm	<5mm
	RMC	23.45	221.31	Yes	Yes	Yes	Yes	No	Yes
WCDMA Band 5	Distance to User			<5mm	<5 mm	5mm	<5 mm	147 mm	<5mm
	RMC	22.40	173.78	Yes	Yes	Yes	Yes	No	Yes
LTE Band 2	Distance to User			<5mm	<5 mm	5mm	<5 mm	147 mm	<5mm
	QPSK	23.05	201.84	Yes	Yes	Yes	Yes	No	Yes
LTE Band 4	Distance to User			<5mm	<5 mm	5mm	<5 mm	147 mm	<5mm
	QPSK	23.75	237.15	Yes	Yes	Yes	Yes	No	Yes
LTE Band 7	Distance to User			<5mm	<5 mm	5mm	<5 mm	147 mm	<5mm
	QPSK	22.85	192.75	Yes	Yes	Yes	Yes	No	Yes
WLAN 2.4 G	Distance to User			<5mm	<5mm	61mm	<5mm	<5mm	145mm
	802.11b	14.55	28.51	Yes	Yes	No	Yes	Yes	No
	802.11g	15.45	35.08	No	No	No	No	No	No
	802.11n(HT20)	13.60	22.91	No	No	No	No	No	No
	802.11n(HT40)	12.65	18.41	No	No	No	No	No	No
WLAN 5.2 G	Distance to User			<5mm	<5mm	61mm	<5mm	<5mm	145mm
	802.11a	12.50	17.78	Yes	Yes	No	Yes	Yes	No
	802.11n(HT20)	12.40	17.38	No	No	No	No	No	No
	802.11n(HT40)	12.05	16.03	No	No	No	No	No	No
WLAN 5.8 G	Distance to User			<5mm	<5mm	61mm	<5mm	<5mm	145mm
	802.11a	11.75	14.96	No	No	No	No	No	No
	802.11n(HT20)	11.25	13.34	Yes	Yes	No	Yes	Yes	No
	802.11n(HT40)	10.75	11.89	Yes	Yes	No	Yes	Yes	No
Bluetooth	Distance to User			<5mm	<5mm	61mm	<5mm	<5mm	145mm
	Bluetooth BR/EDR	5.00	3.16	No	No	No	No	No	No
	Bluetooth BLE	-1.50	0.71	No	No	No	No	No	No

Note:

1. Maximum power is the source-based time-average power and represents the maximum RF output power among production units.
2. Per KDB 447498 D01, for larger devices, the test separation distance of adjacent edge configuration is determined by the closest separation between the antenna and the user.
3. Per KDB 447498 D01, standalone SAR test exclusion threshold is applied; If the distance of the antenna to the user is < 5mm, 5mm is used to determine SAR exclusion threshold
4. Per KDB 447498 D01, the 1-g and 10-g SAR test exclusion thresholds for 100 MHz to 6 GHz at test separation distances ≤ 50 mm are determined by:
$$\left[\frac{\text{(max. power of channel, including tune-up tolerance, mW)}}{\text{(min. test separation distance, mm)}} \cdot \sqrt{f(\text{GHz})} \right] \leq 3.0$$
 for 1-g SAR and ≤ 7.5 for 10-g extremity SAR
 - a. $f(\text{GHz})$ is the RF channel transmit frequency in GHz
 - b. Power and distance are rounded to the nearest mW and mm before calculation
 - c. The result is rounded to one decimal place for comparison
 - d. For < 50 mm distance, we just calculate mW of the exclusion threshold value (3.0) to do compare.This formula is $[3.0] / \sqrt{f(\text{GHz})} \cdot \text{(min. test separation distance, mm)} = \text{exclusion threshold of mW}$.
5. Per KDB 447498 D01, at 100 MHz to 6 GHz and for test separation distances > 50 mm, the SAR test exclusion threshold is determined according to the following:
 - a. [Threshold at 50 mm in step 1) + (test separation distance - 50 mm) · (f(MHz)/150)] mW, at 100 MHz to 1500 MHz
 - b. [Threshold at 50 mm in step 1) + (test separation distance - 50 mm) · 10] mW at > 1500 MHz and ≤ 6 GHz
6. Per KDB 941225 D01, When the maximum output power and tune-up tolerance specified for production units in a secondary mode is $\leq 1/4$ dB higher than the primary mode or when the highest reported SAR of the primary mode is scaled by the ratio of specified maximum output power and tune-up tolerance of secondary to primary mode and the adjusted SAR is ≤ 1.2 W/kg, SAR measurement is not required for the secondary mode.
7. Per KDB 941225 D05, SAR test reduction is applied using the following criteria:
 - a. Start with the largest channel bandwidth and measure SAR for QPSK with 1 RB, and 50% RB allocation, using the RB offset and required test channel combination with the highest maximum output power among RB offsets at the upper edge, middle and lower edge of each required test channel.
 - b. When the reported SAR is > 0.8 W/kg, testing for other Channels is performed at the highest output power level for 1RB, and 50% RB configuration for that channel.
 - c. Testing for 100% RB configuration is performed at the highest output power level for 100% RB configuration across the Low, Mid and High Channel when the highest reported SAR for 1 RB and 50% RB are > 0.8 W/kg. Testing for the remaining required channels is not needed because the reported SAR for 100% RB Allocation < 1.45 W/kg.
 - d. Testing for 16-QAM modulation is not required because the reported SAR for QPSK is < 1.45 W/Kg and its output power is not more than 0.5 dB higher than that of QPSK.
 - e. Testing for the other channel bandwidths is not required because the reported SAR for the highest channel bandwidth is < 1.45 W/Kg and its output power is not more than 0.5 dB higher than that of the highest channel bandwidth.
8. Per KDB 248227 D01 SAR is not required for the following 2.4 GHz OFDM conditions.
 - a. When the reported SAR of the highest measured maximum output power channel for the exposure configuration is ≤ 0.8 W/kg, no further SAR testing is required for 802.11b DSSS in that exposure configuration.
 - b. When the reported SAR is > 0.8 W/kg, SAR is required for that exposure configuration using the next highest measured output power channel. When any reported SAR is > 1.2 W/kg, SAR is required for the third channel.
9. Per KDB 248227 D01 SAR is not required for the following 2.4 GHz OFDM conditions.
 - a. When KDB Publication 447498 D01 SAR test exclusion applies to the OFDM configuration.
 - b. When the highest reported SAR for DSSS is adjusted by the ratio of OFDM to DSSS specified maximum output

power and the adjusted SAR is ≤ 1.2 W/kg.

10. Per KDB 248227 D01 SAR is not required for the following U-NII-1 and U-NII-2A bands conditions.
 - a. When the same maximum output power is specified for both bands, begin SAR measurement in U-NII-2A band by applying the OFDM SAR requirements. If the highest reported SAR for a test configuration is ≤ 1.2 W/kg, SAR is not required for U-NII-1 band for that configuration (802.11 mode and exposure condition); otherwise, each band is tested independently for SAR.
 - b. When different maximum output power is specified for the bands, begin SAR measurement in the band with higher specified maximum output power. The highest reported SAR for the tested configuration is adjusted by the ratio of lower to higher specified maximum output power for the two bands. When the adjusted SAR is ≤ 1.2 W/kg, SAR is not required for the band with lower maximum output power in that test configuration; otherwise, each band is tested independently for SAR.
11. Per KDB 248227 D01 5G WLAN Subsequent Test Configuration Procedures
SAR measurement requirements for the remaining 802.11 transmission mode configurations that have not been tested in the initial test configuration are determined separately for each standalone and aggregated frequency band, in each exposure condition, according to the maximum output power specified for production units.
 - a. When SAR test exclusion provisions of KDB Publication 447498 D01 are applicable and SAR measurement is not required for the initial test configuration, SAR is also not required for the next highest maximum output power transmission mode subsequent test configuration(s) in that frequency band or aggregated band and exposure configuration.
 - b. When the highest reported SAR for the initial test configuration (when applicable, include subsequent highest output channels), according to the initial test position or fixed exposure position requirements, is adjusted by the ratio of the subsequent test configuration to initial test configuration specified maximum output power and the adjusted SAR is ≤ 1.2 W/kg, SAR is not required for that subsequent test configuration.

9.2 10g Extremity Exposure Consider

According with FCC KDB 648474 D04, for smart phones with a display diagonal dimension > 15.0 cm or an overall diagonal dimension > 16.0 cm that provide similar mobile web access and multimedia support found in mini-tablets or UMPC mini-tablets that support voice calls next to the ear, unless it is confirmed otherwise through KDB inquiries, the following phablet procedures should be applied to evaluate SAR compliance for each applicable wireless modes and frequency band. Devices marketed as phablets, regardless of form factors and operating characteristics must be tested as a phablet to determine SAR compliance;

The UMPC mini-tablet procedures must also be applied to test the SAR of all surfaces and edges with an antenna located at ≤ 25 mm from that surface or edge, in direct contact with a flat phantom, for 10-g extremity SAR according to the body-equivalent tissue dielectric parameters in KDB 865664 to address interactive hand use exposure conditions. The UMPC mini-tablet 1-g SAR at 5 mm is not required. When hotspot mode applies, 10-g extremity SAR is required only for the surfaces and edges with hotspot mode 1-g reported SAR > 1.2 W/kg.

Conclusion:

The EUT hotspot mode 1-g reported SAR is 1.058 W/Kg, which is less than 1.2W/Kg, 10-g extremity SAR is not required.

10 TEST RESULTS

10.1 GSM 850

Mode	Position	Dist. (mm)	Ch.	Freq. (MHz)	Power Drift (%)	1 g Meas. SAR (W/Kg)	Meas. Power (dBm)	Max. tune-up Power(dBm)	Scaling Factor	1 g Scaled SAR (W/Kg)	Meas. No.
Head											
Voice	Left Cheek	0	128	824.2	3.81	0.209	32.78	32.90	1.03	0.215	/
	Left Tilt	0	128	824.2	1.46	0.103	32.78	32.90	1.03	0.106	/
	Right Cheek	0	128	824.2	-0.78	0.300	32.78	32.90	1.03	0.308	1#
	Right Tilt	0	128	824.2	-1.09	0.101	32.78	32.90	1.03	0.104	/
Body-worn Accessory											
Voice	Front Side	10	128	824.2	0.26	0.372	32.78	32.90	1.03	0.382	/
	Back Side	10	128	824.2	-0.93	0.557	32.78	32.90	1.03	0.573	/
Hotspot											
GPRS 4 slots	Front Side	10	128	824.2	0.72	0.431	29.34	29.45	1.03	0.442	/
	Back Side	10	128	824.2	-0.01	0.816	29.34	29.45	1.03	0.837	2#
		10	190	836.6	0.07	0.693	29.07	29.45	1.09	0.756	/
		10	251	848.8	-2.76	0.632	28.87	29.45	1.14	0.722	/
	Left Edge	10	128	824.2	-1.20	0.556	29.34	29.45	1.03	0.570	/
	Right Edge	10	128	824.2	-2.03	0.178	29.34	29.45	1.03	0.183	/
	Bottom Edge	10	128	824.2	2.44	0.482	29.34	29.45	1.03	0.494	/
Note: SAR is not required for EGPRS (8PSK) mode because its output power is less than that of GPRS Mode.											

10.2 GSM 1900

Mode	Position	Dist. (mm)	Ch.	Freq. (MHz)	Power Drift (%)	1 g Meas. SAR (W/Kg)	Meas. Power (dBm)	Max. tune-up Power(dBm)	Scaling Factor	1 g Scaled SAR (W/Kg)	Meas. No.
Head											
Voice	Left Cheek	0	810	1909.8	-1.17	0.116	30.34	30.45	1.03	0.119	3#
	Left Tilt	0	810	1909.8	-1.03	0.064	30.34	30.45	1.03	0.066	/
	Right Cheek	0	810	1909.8	-1.79	0.066	30.34	30.45	1.03	0.068	/
	Right Tilt	0	810	1909.8	-0.93	0.049	30.34	30.45	1.03	0.050	/
Body-worn Accessory											
Voice	Front Side	10	810	1909.8	0.13	0.316	30.34	30.45	1.03	0.324	/
	Back Side	10	810	1909.8	-2.12	0.285	30.34	30.45	1.03	0.292	/
Hotspot											
GPRS 4 slots	Front Side	10	810	1909.8	0.20	0.453	26.87	26.95	1.02	0.461	/
	Back Side	10	810	1909.8	0.31	0.441	26.87	26.95	1.02	0.449	/
	Left Edge	10	810	1909.8	-2.22	0.128	26.87	26.95	1.02	0.130	/
	Right Edge	10	810	1909.8	-2.01	0.235	26.87	26.95	1.02	0.239	/
	Bottom Edge	10	810	1909.8	-2.51	0.698	26.87	26.95	1.02	0.711	4#
Note: SAR is not required for EGPRS (8PSK) mode because its output power is less than that of GPRS Mode.											

10.3 WCDMA Band 2

Mode	Position	Dist. (mm)	Ch.	Freq. (MHz)	Power Drift (%)	1 g Meas. SAR (W/Kg)	Meas. Power (dBm)	Max. tune-up Power(dBm)	Scaling Factor	1 g Scaled SAR (W/Kg)	Meas. No.
Head											
RMC	Left Cheek	0	9538	1907.6	-1.33	0.227	22.95	23.05	1.02	0.232	5#
	Left Tilt	0	9538	1907.6	0.87	0.111	22.95	23.05	1.02	0.114	/
	Right Cheek	0	9538	1907.6	1.82	0.133	22.95	23.05	1.02	0.136	/
	Right Tilt	0	9538	1907.6	1.53	0.061	22.95	23.05	1.02	0.062	/
Body-worn Accessory& Hotspot											
RMC	Front Side	10	9538	1907.6	-0.71	0.569	22.95	23.05	1.02	0.582	/
	Back Side	10	9538	1907.6	-0.23	0.603	22.95	23.05	1.02	0.617	/
	Left Edge	10	9538	1907.6	-0.15	0.143	22.95	23.05	1.02	0.146	/
	Right Edge	10	9538	1907.6	-0.36	0.264	22.95	23.05	1.02	0.270	/
	Bottom Edge	10	9538	1907.6	-0.94	0.885	22.95	23.05	1.02	0.906	6#
		10	9262	1852.4	-0.41	0.839	22.89	23.05	1.04	0.870	/
		10	9400	1880.0	-2.83	0.778	22.49	23.05	1.14	0.885	/

10.4 WCDMA Band 4

Mode	Position	Dist. (mm)	Ch.	Freq. (MHz)	Power Drift (%)	1 g Meas. SAR (W/Kg)	Meas. Power (dBm)	Max. tune-up Power(dBm)	Scaling Factor	1 g Scaled SAR (W/Kg)	Meas. No.
Head											
RMC	Left Cheek	0	1412	1732.4	-4.12	0.207	23.37	23.45	1.02	0.211	7#
	Left Tilt	0	1412	1732.4	-4.19	0.156	23.37	23.45	1.02	0.159	/
	Right Cheek	0	1412	1732.4	-1.26	0.160	23.37	23.45	1.02	0.163	/
	Right Tilt	0	1412	1732.4	-4.23	0.109	23.37	23.45	1.02	0.111	/
Body-worn Accessory& Hotspot											
RMC	Front Side	10	1412	1732.4	-0.36	0.613	23.37	23.45	1.02	0.624	/
	Back Side	10	1412	1732.4	-0.05	0.905	23.37	23.45	1.02	0.922	/
		10	1312	1712.4	0.60	0.808	22.80	23.45	1.16	0.938	/
		10	1513	1752.6	-1.14	0.804	22.84	23.45	1.15	0.925	/
	Left Edge	10	1412	1732.4	-1.67	0.197	23.37	23.45	1.02	0.201	/
	Right Edge	10	1412	1732.4	-1.94	0.243	23.37	23.45	1.02	0.248	/
	Bottom Edge	10	1412	1732.4	-1.27	0.843	23.37	23.45	1.02	0.859	/
		10	1312	1712.4	-2.78	0.906	22.80	23.45	1.16	1.052	8#
		10	1513	1752.6	-1.23	0.824	22.84	23.45	1.15	0.948	/

10.5 WCDMA Band 5

Mode	Position	Dist. (mm)	Ch.	Freq. (MHz)	Power Drift (%)	1 g Meas. SAR (W/Kg)	Meas. Power (dBm)	Max. tune-up Power(dBm)	Scaling Factor	1 g Scaled SAR (W/Kg)	Meas. No.
Head											
RMC	Left Cheek	0	4182	836.40	-0.17	0.256	22.30	22.40	1.02	0.262	/
	Left Tilt	0	4182	836.40	1.36	0.209	22.30	22.40	1.02	0.214	/
	Right Cheek	0	4182	836.40	3.57	0.323	22.30	22.40	1.02	0.331	9#
	Right Tilt	0	4182	836.40	-0.79	0.139	22.30	22.40	1.02	0.142	/
Body-worn Accessory& Hotspot											
RMC	Front Side	10	4182	836.40	1.30	0.205	22.30	22.40	1.02	0.210	/
	Back Side	10	4182	836.40	-0.15	0.450	22.30	22.40	1.02	0.460	10#
	Left Edge	10	4182	836.40	-0.93	0.305	22.30	22.40	1.02	0.312	/
	Right Edge	10	4182	836.40	-0.23	0.102	22.30	22.40	1.02	0.104	/
	Bottom Edge	10	4182	836.40	0.62	0.296	22.30	22.40	1.02	0.302	/

10.6LTE Band 2 (20MHz Bandwidth)

Mode	Position	Dist. (mm)	Ch.	Freq. (MHz)	RB Numb.	RB Start	Power Drift (%)	1 g Meas. SAR (W/Kg)	Meas. Power (dBm)	Max. tune-up Power (dBm)	Scaling Factor	1 g Scaled SAR (W/Kg)	Meas. No.
Head													
QPSK	Left Cheek	0	18700	1860	1	Low	0.53	0.179	22.97	23.05	1.02	0.182	11#
			18700	1860	50	Low	1.36	0.137	21.81	21.90	1.02	0.140	/
	Left Tilt	0	18700	1860	1	Low	-3.40	0.105	22.97	23.05	1.02	0.107	/
			18700	1860	50	Low	-2.35	0.084	21.81	21.90	1.02	0.086	/
	Right Cheek	0	18700	1860	1	Low	-4.22	0.154	22.97	23.05	1.02	0.157	/
			18700	1860	50	Low	-1.68	0.112	21.81	21.90	1.02	0.114	/
	Right Tilt	0	18700	1860	1	Low	1.05	0.045	22.97	23.05	1.02	0.046	/
			18700	1860	50	Low	-4.02	0.034	21.81	21.90	1.02	0.035	/
Body-worn Accessory& Hotspot													
QPSK	Front Side	10	18700	1860	1	Low	-1.32	0.502	22.97	23.05	1.02	0.511	/
			18700	1860	50	Low	-0.97	0.395	21.81	21.90	1.02	0.403	/
	Back Side	10	18700	1860	1	Low	-0.61	0.673	22.97	23.05	1.02	0.686	/
			18700	1860	50	Low	-0.43	0.536	21.81	21.90	1.02	0.547	/
	Left Edge	10	18700	1860	1	Low	1.23	0.123	22.97	23.05	1.02	0.125	/
			18700	1860	50	Low	0.96	0.115	21.81	21.90	1.02	0.117	/
	Right Edge	10	18700	1860	1	Low	-1.36	0.202	22.97	23.05	1.02	0.206	/
			18700	1860	50	Low	0.46	0.156	21.81	21.90	1.02	0.159	/
	Bottom Edge	10	18700	1860	1	Low	-1.21	0.839	22.97	23.05	1.02	0.855	12#
			18900	1880	1	Low	-1.06	0.817	22.94	23.05	1.03	0.838	/
			19100	1900	1	Low	-1.30	0.806	22.90	23.05	1.04	0.834	/
			18700	1860	50	Low	0.69	0.648	21.81	21.90	1.02	0.662	/
18700			1860	100	Low	0.72	0.646	21.82	21.90	1.02	0.658	/	

10.7 LTE Band 4 (20MHz Bandwidth)

Mode	Position	Dist. (mm)	Ch.	Freq. (MHz)	RB Numb.	RB Start	Power Drift (%)	1 g Meas. SAR (W/Kg)	Meas. Power (dBm)	Max. tune-up Power (dBm)	Scaling Factor	1 g Scaled SAR (W/Kg)	Meas. No.	
Head														
QPSK	Left Cheek	0	20175	1732.5	1	Low	-4.17	0.235	23.68	23.75	1.02	0.239	13#	
			20175	1732.5	50	Low	-3.03	0.178	22.58	22.70	1.03	0.183	/	
	Left Tilt	0	20175	1732.5	1	Low	-2.66	0.146	23.68	23.75	1.02	0.148	/	
			20175	1732.5	50	Low	-2.42	0.117	22.58	22.70	1.03	0.120	/	
	Right Cheek	0	20175	1732.5	1	Low	-4.11	0.177	23.68	23.75	1.02	0.180	/	
			20175	1732.5	50	Low	-1.55	0.139	22.58	22.70	1.03	0.143	/	
	Right Tilt	0	20175	1732.5	1	Low	-1.64	0.091	23.68	23.75	1.02	0.092	/	
			20175	1732.5	50	Low	-0.89	0.077	22.58	22.70	1.03	0.079	/	
Body-worn Accessory& Hotspot														
QPSK	Front Side	10	20175	1732.5	1	Low	-0.25	0.641	23.68	23.75	1.02	0.651	/	
			20175	1732.5	50	Low	-2.58	0.454	22.58	22.70	1.03	0.467	/	
	Back Side	10	20175	1732.5	1	Low	-0.69	0.918	23.68	23.75	1.02	0.933	/	
			20050	1720	1	Low	-0.41	0.974	23.39	23.75	1.09	1.058	14#	
			20300	1745	1	Low	-0.46	0.890	23.58	23.75	1.04	0.926	/	
			20175	1732.5	50	Low	-0.85	0.699	22.58	22.70	1.03	0.719	/	
	Left Edge	10	20175	1732.5	1	Low	0.96	0.215	23.68	23.75	1.02	0.218	/	
			20175	1732.5	50	Low	1.28	0.127	22.58	22.70	1.03	0.131	/	
	Right Edge	10	20175	1732.5	1	Low	-1.66	0.280	23.68	23.75	1.02	0.285	/	
			20175	1732.5	50	Low	0.58	0.153	22.58	22.70	1.03	0.157	/	
	Bottom Edge	10	20175	1732.5	1	Low	-2.14	0.895	23.68	23.75	1.02	0.910	/	
			20050	1720	1	Low	-1.92	0.970	23.39	23.75	1.09	1.054	/	
			20300	1745	1	Low	-1.26	0.858	23.58	23.75	1.04	0.892	/	
			20175	1732.5	50	Low	-1.57	0.699	22.58	22.70	1.03	0.719	/	
				20175	1732.5	100	Low	-0.97	0.656	22.48	22.60	1.03	0.674	/

10.8 LTE Band 7 (20MHz Bandwidth)

Mode	Position	Dist. (mm)	Ch.	Freq. (MHz)	RB Numb.	RB Start	Power Drift (%)	1 g Meas. SAR (W/Kg)	Meas. Power (dBm)	Max. tune-up Power (dBm)	Scaling Factor	1 g Scaled SAR (W/Kg)	Meas. No.
Head													
QPSK	Left Cheek	0	21350	2560	1	Low	-3.79	0.302	22.76	22.85	1.02	0.308	15#
			21100	2535	50	Low	-1.26	0.228	21.57	21.65	1.02	0.232	/
	Left Tilt	0	21350	2560	1	Low	0.63	0.128	22.76	22.85	1.02	0.131	/
			21100	2535	50	Low	1.29	0.110	21.57	21.65	1.02	0.112	/
	Right Cheek	0	21350	2560	1	Low	0.00	0.147	22.76	22.85	1.02	0.150	/
			21100	2535	50	Low	3.24	0.113	21.57	21.65	1.02	0.115	/
	Right Tilt	0	21350	2560	1	Low	-1.29	0.097	22.76	22.85	1.02	0.099	/
			21100	2535	50	Low	-0.93	0.086	21.57	21.65	1.02	0.088	/
Body-worn Accessory& Hotspot													
QPSK	Front Side	10	21350	2560	1	Low	0.60	0.574	22.76	22.85	1.02	0.586	/
			21100	2535	50	Low	1.24	0.382	21.57	21.65	1.02	0.389	/
	Back Side	10	21350	2560	1	Low	-3.88	0.598	22.76	22.85	1.02	0.611	/
			21100	2535	50	Low	-2.03	0.425	21.57	21.65	1.02	0.433	/
	Left Edge	10	21350	2560	1	Low	-2.35	0.055	22.76	22.85	1.02	0.056	/
			21100	2535	50	Low	-1.41	0.037	21.57	21.65	1.02	0.038	/
	Right Edge	10	21350	2560	1	Low	-2.53	0.312	22.76	22.85	1.02	0.319	/
			21100	2535	50	Low	-1.03	0.176	21.57	21.65	1.02	0.179	/
	Bottom Edge	10	21350	2560	1	Low	1.52	0.872	22.76	22.85	1.02	0.890	16#
			20850	2510	1	Low	-1.33	0.705	22.69	22.85	1.04	0.731	/
21100			2535	1	Low	-1.32	0.777	22.65	22.85	1.05	0.814	/	
21100			2535	50	Low	-0.51	0.531	21.57	21.65	1.02	0.541	/	
			21350	2560	100	Low	-1.20	0.597	21.48	21.60	1.03	0.614	/

10.9 WIFI 2.4GHZ

Mode	Position	Dist. (mm)	Ch.	Freq. (MHz)	Power Drift (%)	1 g Meas. SAR (W/Kg)	Meas. Power (dBm)	Max. tune-up Power (dBm)	Scaling Factor	Duty Cycle (%)	Duty Cycle Scaling Factor	1 g Scaled SAR (W/Kg)	Meas. No.
Head													
802.11 b	Left Cheek	0	6	2437	3.18	0.281	14.42	14.55	1.03	99.21	1.008	0.292	/
	Left Tilt	0	6	2437	-1.36	0.196	14.42	14.55	1.03	99.21	1.008	0.204	/
	Right Cheek	0	6	2437	1.79	0.537	14.42	14.55	1.03	99.21	1.008	0.557	17#
	Right Tilt	0	6	2437	2.52	0.397	14.42	14.55	1.03	99.21	1.008	0.412	/
Body													
802.11 b	Front Side	10	6	2437	-2.46	0.143	14.42	14.55	1.03	99.21	1.008	0.148	/
	Back Side	10	6	2437	-3.87	0.192	14.42	14.55	1.03	99.21	1.008	0.200	18#
	Right Edge	10	6	2437	-1.03	0.170	14.42	14.55	1.03	99.21	1.008	0.176	/
	Top Edge	10	6	2437	-2.56	0.152	14.42	14.55	1.03	99.21	1.008	0.158	/

10.10 WIFI 5GHz

Fre. Band	Mode	Position	Dist. (mm)	Ch.	Freq. (MHz)	Power Drift (%)	1 g Meas. SAR (W/Kg)	Meas. Power (dBm)	Max. tune-up Power (dBm)	Scaling Factor	Duty Cycle (%)	Duty Cycle Scaling Factor	1 g Scaled SAR (W/Kg)	Meas. No.
Head														
5.2G	802.11 a	Left Cheek	0	36	5180	-1.98	0.579	12.40	12.50	1.02	96.50	1.036	0.613	/
		Left Tilt	0	36	5180	1.58	0.454	12.40	12.50	1.02	96.50	1.036	0.482	/
		Right Cheek	0	36	5180	-3.06	0.761	12.40	12.50	1.02	96.50	1.036	0.807	19#
			0	44	5220	2.35	0.732	12.35	12.50	1.04	96.50	1.036	0.785	/
		Right Tilt	0	48	5240	1.29	0.649	11.76	12.50	1.19	96.50	1.036	0.797	/
			0	36	5180	-3.24	0.758	12.40	12.50	1.02	96.50	1.036	0.804	/
			0	44	5220	2.54	0.725	12.35	12.50	1.04	96.50	1.036	0.778	/
			0	48	5240	3.88	0.627	11.76	12.50	1.19	96.50	1.036	0.773	/
5.8G	802.11 a	Left Cheek	0	157	5785	0.90	0.317	11.65	11.75	1.02	95.83	1.044	0.338	/
		Left Tilt	0	157	5785	3.52	0.285	11.65	11.75	1.02	95.83	1.044	0.305	/
		Right Cheek	0	157	5785	-3.45	0.447	11.65	11.75	1.02	95.83	1.044	0.477	/
		Right Tilt	0	157	5785	-3.71	0.485	11.65	11.75	1.02	95.83	1.044	0.518	20#
Body														
5.2G	802.11 a	Front Side	10	36	5180	-3.00	0.188	12.40	12.50	1.02	96.50	1.036	0.199	/
		Back Side	10	36	5180	-3.46	0.462	12.40	12.50	1.02	96.50	1.036	0.490	21#
		Right Edge	10	36	5180	1.35	0.206	12.40	12.50	1.02	96.50	1.036	0.219	/
		Top Edge	10	36	5180	-2.26	0.333	12.40	12.50	1.02	96.50	1.036	0.353	/
5.8G	802.11 a	Front Side	10	157	5785	-3.07	0.163	11.65	11.75	1.02	95.83	1.044	0.174	/
		Back Side	10	157	5785	-3.38	0.346	11.65	11.75	1.02	95.83	1.044	0.370	22#
		Right Edge	10	157	5785	-2.94	0.177	11.65	11.75	1.02	95.83	1.044	0.189	/
		Top Edge	10	157	5785	0.77	0.215	11.65	11.75	1.02	95.83	1.044	0.230	/
Note: For this band, the EUT does not support Power Reduction under Hotspot mode.														

11 SAR Measurement Variability

According to KDB 865664 D01, SAR measurement variability was assessed for each frequency band, which is determined by the SAR probe calibration point and tissue-equivalent medium used for the device measurements. When both head and body tissue-equivalent media are required for SAR measurements in a frequency band, the variability measurement procedures should be applied to the tissue medium with the highest measured SAR, using the highest measured SAR configuration for that tissue-equivalent medium. Alternatively, if the highest measured SAR for both head and body tissue-equivalent media are ≤ 1.45 W/kg and the ratio of these highest SAR values, i.e., largest divided by smallest value, is ≤ 1.10 , the highest SAR configuration for either head or body tissue-equivalent medium may be used to perform the repeated measurement. These additional measurements are repeated after the completion of all measurements requiring the same head or body tissue-equivalent medium in a frequency band. The test device should be returned to ambient conditions (normal room temperature) with the battery fully charged before it is re-mounted on the device holder for the repeated measurement(s) to minimize any unexpected variations in the repeated results.

SAR repeated measurement procedure:

1. When the highest measured SAR is < 0.80 W/kg, repeated measurement is not required.
2. When the highest measured SAR is ≥ 0.80 W/kg, repeat that measurement once.
3. If the ratio of largest to smallest SAR for the original and first repeated measurements is > 1.20 , or when the original or repeated measurement is ≥ 1.45 W/kg, perform a second repeated measurement.
4. If the ratio of largest to smallest SAR for the original, first and second repeated measurements is > 1.20 , and the original, first or second repeated measurement is ≥ 1.5 W/kg, perform a third repeated measurement.

Frequency Band (MHz)	Wireless Band	RF Exposure Conditions	Test Position	Highest Measured SAR (W/kg)	Repeated SAR (Yes/No)	Highest Measured SAR (W/kg)	Largest to Smallest SAR Ratio
850	GSM 850	Body	Back Side	0.816	Yes	0.811	1.01
1750	WCDMA Band 4	Body	Bottom Edge	0.906	Yes	0.893	1.01
	LTE Band 4	Body	Bottom Edge	0.974	Yes	0.963	1.01
1900	WCDMA Band 2	Body	Bottom Edge	0.885	Yes	0.867	1.02
	LTE Band 2	Body	Bottom Edge	0.839	Yes	0.831	1.01
2600	LTE Band 7	Body	Bottom Edge	0.872	Yes	0.866	1.01

Note: The ratio of largest to smallest SAR for the original and first repeated measurements is < 1.20 , the second repeated measurement is not required.

12 SIMULTANEOUS TRANSMISSION

Simultaneous transmission SAR test exclusion is determined for each operating configuration and exposure condition according to the reported standalone SAR of each applicable simultaneous transmitting antenna. When the sum of SAR 1g of all simultaneously transmitting antennas in an operating mode and exposure condition combination is within the SAR limit (SAR 1g 1.6 W/kg), the simultaneous transmission SAR is not required. When the sum of SAR 1g is greater than the SAR limit (SAR 1g 1.6 W/kg), SAR test exclusion is determined by the SAR to Peak Location Ratio (SPLSR).

12.1 Simultaneous Transmission Mode Consider

NO.	Mode	2.4G WLAN & 5G WLAN & 2.4G Bluetooth		
		Head	Body-worn	Hotspot
1	GSM (Voice)	+ 2.4G WLAN	+ 2.4G WLAN	--
		+ 5G WLAN	+ 5G WLAN	--
		--	+ Bluetooth	--
2	GSM (Data)	--	--	+ 2.4G WLAN
		--	--	+ 5G WLAN
3	WCDMA RMC	+ 2.4G WLAN	+ 2.4G WLAN	+ 2.4G WLAN
		+ 5G WLAN	+ 5G WLAN	+ 5G WLAN
		--	+ Bluetooth	--
4	LTE	+ 2.4G WLAN	+ 2.4G WLAN	+ 2.4G WLAN
		+ 5G WLAN	+ 5G WLAN	+ 5G WLAN
		--	+ Bluetooth	--

Note:

- 2G&3G&4G share the same antenna and can't transmit simultaneously.
- The Bluetooth and WLAN share the same antenna, can't transmitting together.
- Both the 2.4G WLAN and 5G WLAN can transmit simultaneously with each WWAN.
- Both 2.4G WLAN and 5G WLAN supports hotspot mode.

12.2 Estimated SAR Calculation

According to KDB 447498 D01 when standalone SAR test exclusion applies to an antenna that transmits simultaneously with other antennas, the standalone SAR was estimated according to following formula to result in substantially conservative SAR values of ≤ 0.4 W/kg to determine simultaneous transmission SAR test exclusion.

$$\text{Estimated SAR} = \frac{\text{Max. Tune Up Power (mw)}}{\text{Min Test Separation Distance}} * \frac{\sqrt{f_{\text{GHz}}}}{x} \quad (\text{where } x = 7.5 \text{ for 1-g SAR})$$

If the minimum test separation distance is < 5 mm, a distance of 5 mm is used for estimated SAR calculation. When the test separation distance is > 50 mm, the 0.4 W/kg is used for SAR-1g.

Band	Mode	Position	Antenna To user (mm)	SAR Testing	Max. Tune-up Power (dBm)	Max. Tune-up Power (mW)	Frequency (GHz)	Calculation Distance/Gap (mm)	Estimated SAR (W/kg)
Bluetooth	GFSK	Front side	10	NO	5.00	3.16	2480	10	0.066
		Back Side	10	NO	5.00	3.16	2480	10	0.066
		Right Edge	10	NO	5.00	3.16	2480	10	0.066
		Top Edge	10	NO	5.00	3.16	2480	10	0.066

12.3 Sum SAR of Simultaneous Transmission

12.3.1 Sum Head SAR of Simultaneous Transmission

Simultaneous Mode	Mode	Max. 1g SAR (W/kg)	1g Sum SAR (W/kg)	SPLSR (Yes/No)
GSM Voice + 2.4G WLAN	GSM Voice	0.308	0.865	No
	2.4G WLAN	0.557		
GSM Voice + 5G WLAN	GSM Voice	0.308	1.115	No
	5G WLAN	0.807		
WCDMA RMC +2.4G WLAN	WCDMA RMC	0.331	0.888	No
	2.4G WLAN	0.557		
WCDMA RMC +5G WLAN	WCDMA RMC	0.331	1.138	No
	5G WLAN	0.807		
LTE QPSK + 2.4G WLAN	LTE QPSK	0.308	0.865	No
	2.4G WLAN	0.557		
LTE QPSK + 5G WLAN	LTE QPSK	0.308	1.115	No
	5G WLAN	0.807		

12.3.2 Sum Body-worn SAR of Simultaneous Transmission

Simultaneous Mode	Mode	Max. 1g SAR (W/kg)	1g Sum SAR (W/kg)	SPLSR (Yes/No)
GSM Voice +Bluetooth	GSM Voice	0.573	0.639	No
	Bluetooth	0.066		
GSM Voice + 2.4G WLAN	GSM Voice	0.573	0.773	No
	2.4G WLAN	0.200		
GSM Voice + 5G WLAN	GSM Voice	0.573	1.063	No
	5G WLAN	0.490		
WCDMA RMC +Bluetooth	WCDMA RMC	0.938	1.004	No
	Bluetooth	0.066		
WCDMA RMC +2.4G WLAN	WCDMA RMC	0.938	1.138	No
	2.4G WLAN	0.200		
WCDMA RMC + 5G WLAN	WCDMA RMC	0.938	1.428	No
	5G WLAN	0.490		
LTE QPSK + Bluetooth	LTE QPSK	1.058	1.124	No
	Bluetooth	0.066		
LTE QPSK + 2.4G WLAN	LTE QPSK	1.058	1.454	No
	2.4G WLAN	0.200		
LTE QPSK + 5G WLAN	LTE QPSK	1.058	1.548	No
	5G WLAN	0.490		

12.3.3 Sum Hotspot mode SAR of Simultaneous Transmission

Simultaneous Mode	Mode	Max. 1g SAR (W/kg)	1g Sum SAR (W/kg)	SPLSR (Yes/No)
GSM DATA + 2.4G WLAN	GSM DATA	0.837	1.037	No
	2.4G WLAN	0.200		
GSM DATA + 5G WLAN	GSM DATA	0.837	1.327	No
	5G WLAN	0.490		
WCDMA RMC + 2.4G WLAN	WCDMA RMC	1.052	1.252	No
	2.4G WLAN	0.200		
WCDMA RMC +5G WLAN	WCDMA RMC	1.052	1.522	No
	5G WLAN	0.490		
LTE QPSK + 2.4G WLAN	LTE QPSK	1.058	1.258	No
	2.4G WLAN	0.200		
LTE QPSK + 5G WLAN	LTE QPSK	1.058	1.548	No
	5G WLAN	0.490		

13 TEST EQUIPMENTS LIST

Description	Manufacturer	Model	Serial No.	Cal. Date	Cal. Due
PC	Dell	N/A	N/A	N/A	N/A
835MHz Dipole	SATIMO	SID 835	S/N 25/13 DIP 0G835-246	2015/03/16	2018/03/15
1800MHz Dipole	SATIMO	SID 1900	S/N 25/13 DIP 1G800-248	2015/03/16	2018/03/15
1900MHz Dipole	SATIMO	SID 1900	S/N 25/13 DIP 1G900-249	2015/03/16	2018/03/15
2450MHz Dipole	SATIMO	SID 2450	S/N 25/13 DIP 2G450-251	2015/03/16	2018/03/15
2600MHz Dipole	SATIMO	SID 2600	SN 25/13 DIP 2G600-254	2015/03/16	2018/03/15
Waveguide	SATIMO	SWG5500	S/N 30/13 DIP WGA24	2015/03/16	2018/03/15
E-Field Probe	MVG	SSE2	S/N 34/15 EPGO 265	2016/09/15	2017/09/14
Antenna	SATIMO	ANTA3	SN 17/13 ZNTA45	N/A	N/A
Phantom1	SATIMO	SAM	SN 30/13 SAM103	N/A	N/A
Phantom2	SATIMO	SAM	SN 30/13 SAM104	N/A	N/A
Dielectric Probe Kit	SATIMO	SCLMP	SN 25/13 OCPG56	2016/07/13	2017/07/12
MultiMeter	Keithley	MultiMeter 2000	4024022	2016/07/13	2017/07/12
Signal Generator	R&S	SMF100A	1167.0000k02/104260	2016/07/13	2017/07/12
Power Meter	Agilent	E4419B	GB40201833	2016/07/13	2017/07/12
Power Sensor	Agilent	E9300A	MY41498012	2016/07/13	2017/07/12
Power Sensor	Agilent	E9300A	MY41499891	2016/07/13	2017/07/12
Power Amplifier	SATIMO	6552B	22374	N/A	N/A
Wireless Communication Test Set	Agilent	8960-E5515C	MY50260493	2016/07/13	2017/07/12
Wireless Communication Test Set	R&S	CMW 500	138884	2016/07/13	2017/07/12
Network Analyzer	R&S	ZVL-6	101380	2016/07/13	2017/07/12
Attenuator	COM-MW	ZA-S1-31	1305003187	N/A	N/A
Directional coupler	AA-MCS	AAMCS-UDC	000272	N/A	N/A

Note: Per KDB 865664 Dipole SAR Validation Verification, BALUN LAB has adopted 3 years calibration intervals. On annual basis, every measurement dipole has been evaluated and is in compliance with the following criteria:

1. There is no physical damage on the dipole;
2. System validation with specific dipole is within 10% of calibrated value;
3. Return-loss in within 20% of calibrated measurement.

ANNEX A SIMULATING LIQUID VERIFICATION RESULT

The dielectric parameters of the liquids were verified prior to the SAR evaluation using an SCLMP Dielectric Probe Kit.

Date	Liquid Type	Fre. (MHz)	Temp. (°C)	Meas. Conductivity (σ) (S/m)	Meas. Permittivity (ϵ)	Target Conductivity (σ) (S/m)	Target Permittivity (ϵ)	Conductivity Tolerance (%)	Permittivity Tolerance (%)
2017.03.23	Head	835	21.5	0.89	41.68	0.90	41.50	-1.11	0.43
2017.03.30	Body	835	21.0	0.98	54.33	0.97	55.20	1.03	-1.58
2017.03.29	Head	1800	21.1	1.37	40.68	1.40	40.00	-2.14	1.70
2017.03.27	Body	1800	21.2	1.49	52.99	1.52	53.30	-1.97	-0.58
2017.03.17	Head	1900	21.4	1.42	39.94	1.40	40.00	1.43	-0.15
2017.03.21	Body	1900	21.1	1.55	52.18	1.52	53.30	1.97	-2.10
2017.04.16	Head	2450	21.6	1.83	38.96	1.80	39.20	1.67	-0.61
2017.04.18	Body	2450	21.4	1.99	52.03	1.95	52.70	2.05	-1.27
2017.03.18	Head	2600	21.2	1.98	38.59	1.96	39.00	1.02	-1.05
2017.03.19	Body	2600	21.4	2.15	51.53	2.16	52.50	-0.46	-1.85
2017.04.19	Head	5200	21.1	4.79	36.42	4.66	36.00	2.79	1.17
2017.04.21	Body	5200	20.9	5.26	49.13	5.30	49.00	-0.75	0.27
2017.04.20	Head	5800	21.2	5.49	34.35	5.27	35.30	4.17	-2.69
2017.04.24	Body	5800	21.3	5.96	48.15	6.00	48.20	-0.67	-0.10

Note: The tolerance limit of Conductivity and Permittivity is $\pm 5\%$.

ANNEX B SYSTEM CHECK RESULT

Comparing to the original SAR value provided by SATIMO, the validation data should be within its specification of 10%(for 1 g).

Date	Liquid Type	Freq. (MHz)	Power (mW)	Measured SAR (W/kg)	Normalized SAR (W/kg)	Dipole SAR (W/kg)	Tolerance (%)	Targeted SAR(W/kg)	Tolerance (%)
2017.03.23	Head	835	100	0.894	8.94	9.81	-8.87	9.56	-6.49
2017.03.30	Body	835	100	0.982	9.82	10.53	-6.74	9.56	2.72
2017.03.29	Head	1800	100	3.867	38.67	38.70	-0.08	38.40	0.70
2017.03.27	Body	1800	100	4.071	40.71	40.40	0.77	38.40	6.02
2017.03.17	Head	1900	100	4.031	40.31	40.75	-1.08	39.70	1.54
2017.03.21	Body	1900	100	4.163	41.63	42.06	-1.02	39.70	4.86
2017.04.16	Head	2450	100	5.353	53.53	54.29	-1.40	52.40	2.16
2017.04.18	Body	2450	100	5.313	53.13	54.70	-2.87	52.40	1.39
2017.03.18	Head	2600	100	5.498	54.98	57.40	-4.22	55.30	-0.58
2017.03.19	Body	2600	100	5.870	58.70	57.40	2.26	55.30	6.15
2017.04.19	Head	5200	100	15.399	153.99	157.80	-2.41	159.00	-3.15
2017.04.21	Body	5200	100	15.416	154.16	155.12	-0.62	159.00	-3.04
2017.04.20	Head	5800	100	18.256	182.56	179.53	1.69	181.20	0.75
2017.04.24	Body	5800	100	17.379	173.79	173.19	0.35	181.20	-4.09

Note: The tolerance limit of System validation $\pm 10\%$.

System Performance Check Data(835 MHz Head)

Type: Phone measurement (Complete)
 E-Field Probe: SN 34/15 SSE2 EPGO265
 Area scan resolution: dx=8 mm,dy=8 mm
 Zoom scan resolution: dx=8 mm, dy=8 mm, dz=5 mm
 Date of measurement: 2017.03.23
 Measurement duration: 13 minutes 30 seconds

Experimental conditions.

Phantom File	surf_sam_plan.txt
Phantom	Validation plane
Band	835 MHz
Signal	CW
Frequency (MHz)	835.000000
Relative permittivity (real part)	41.681342
Conductivity (S/m)	0.890384
Power drift (%)	0.180000
Ambient Temperature:	22.7C
Liquid Temperature:	21.5C
ConvF:	2.04
Crest factor:	1:1

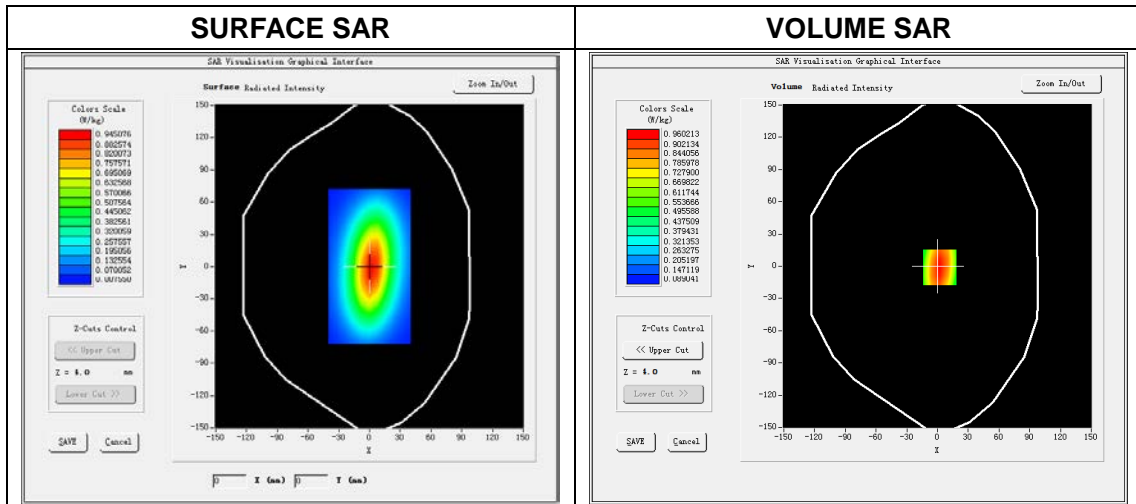

Maximum location: X=1.00, Y=-1.00
 SAR Peak: 1.26 W/kg

SAR 10 g (W/Kg)	0.586932
SAR 1 g (W/Kg)	0.894176

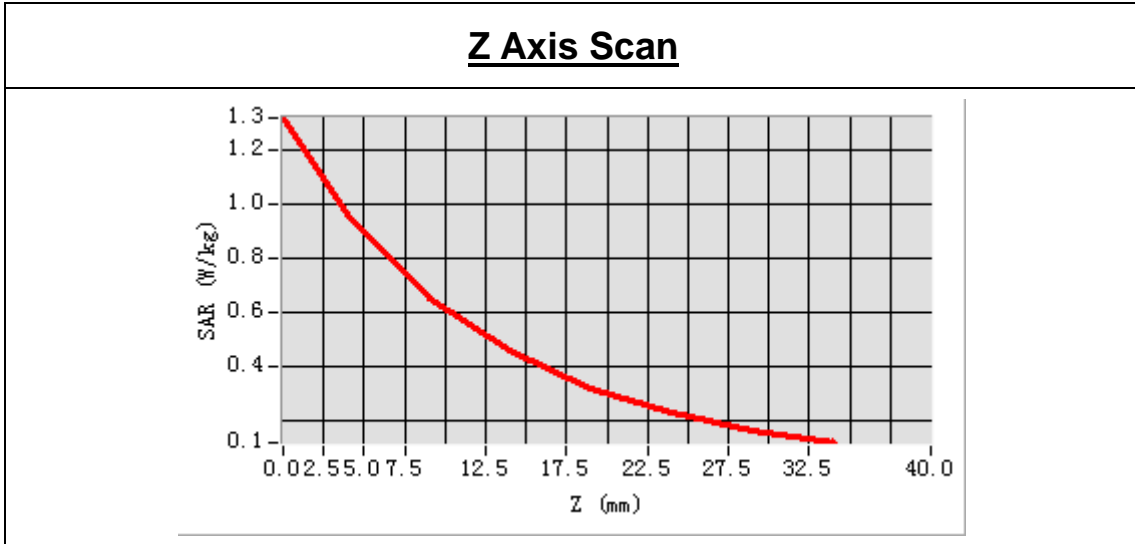

3D screen shot	Hot spot position

System Performance Check Data(835 MHz Body)

Type: Phone measurement (Complete)
 E-Field Probe: SN 34/15 SSE2 EPGO265
 Area scan resolution: dx=8 mm,dy=8 mm
 Zoom scan resolution: dx=8 mm, dy=8 mm, dz=5 mm
 Date of measurement: 2017.03.30
 Measurement duration: 14 minutes 23 seconds

Experimental conditions.

Phantom File	surf_sam_plan.txt
Phantom	Validation plane
Band	835 MHz
Signal	CW
Frequency (MHz)	835.000000
Relative permittivity (real part)	54.328615
Conductivity (S/m)	0.981324
Power drift (%)	-0.120000
Ambient Temperature:	22.2C
Liquid Temperature:	21.0C
ConvF:	2.12
Crest factor:	1:1

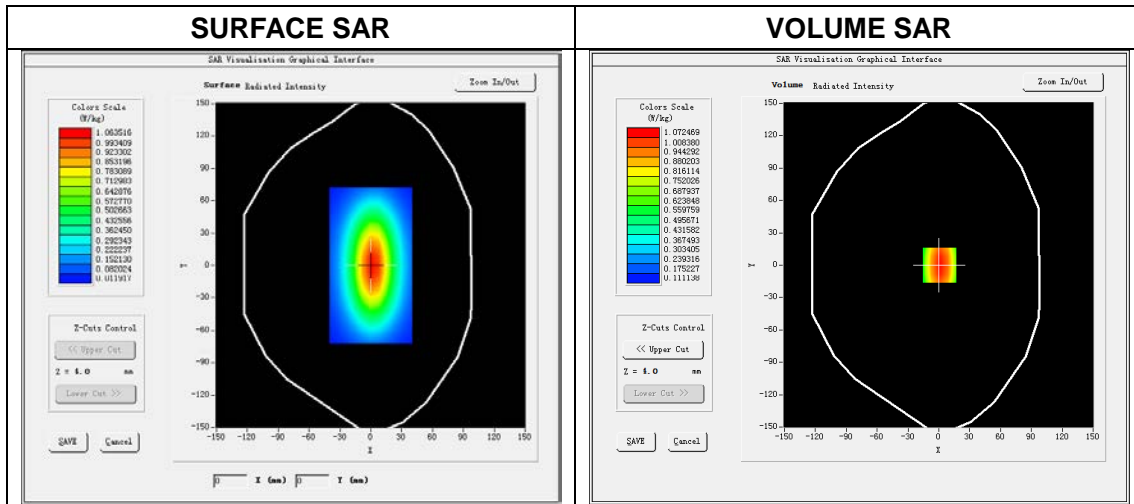

Maximum location: X=1.00, Y=0.00
 SAR Peak: 1.46 W/kg

SAR 10 g (W/Kg)	0.668514
SAR 1 g (W/Kg)	0.982024

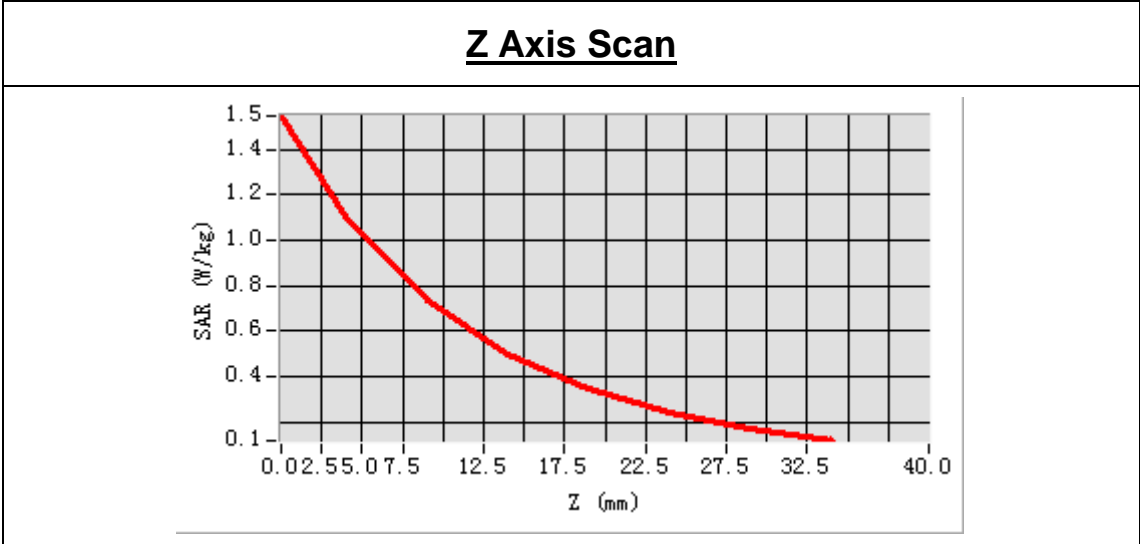

3D screen shot	Hot spot position

System Performance Check Data(1800MHz Head)

Type: Phone measurement (Complete)
 E-Field Probe: SN 34/15 SSE2 EPGO265
 Area scan resolution: dx=8 mm,dy=8 mm
 Zoom scan resolution: dx=8 mm, dy=8 mm, dz=5 mm
 Date of measurement: 2017.03.29
 Measurement duration: 13 minutes 27 seconds

Experimental conditions.

Phantom File	surf_sam_plan.txt
Phantom	Validation plane
Band	1800MHz
Signal	CW
Frequency (MHz)	1800.000000
Relative permittivity (real part)	40.681975
Conductivity (S/m)	1.374960
Power drift (%)	0.420000
Ambient Temperature:	22.4C
Liquid Temperature:	21.1C
ConvF:	2.04
Crest factor:	1:1

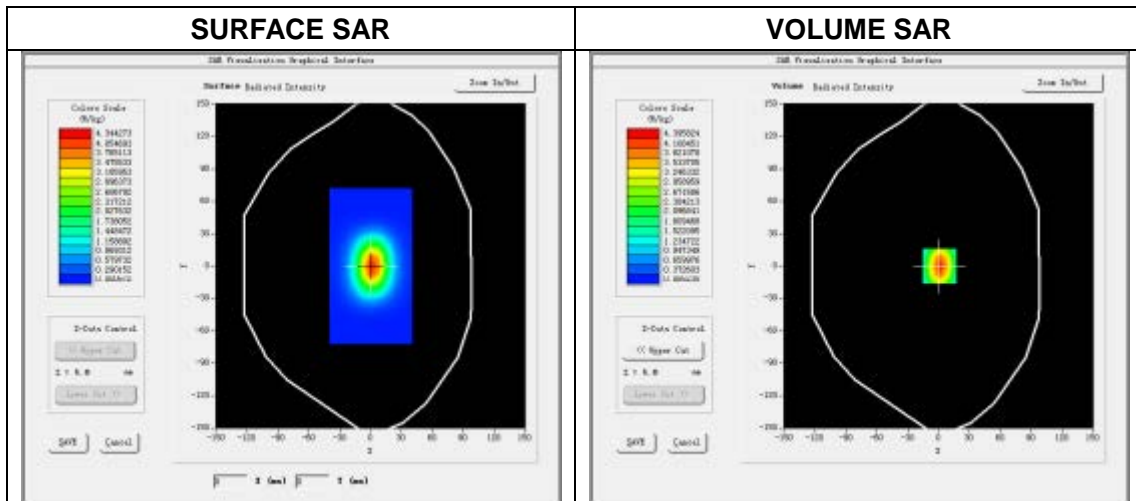

Maximum location: X=1.00, Y=0.00
 SAR Peak: 6.46 W/kg

SAR 10 g (W/Kg)	1.920314
SAR 1g (W/Kg)	3.867184

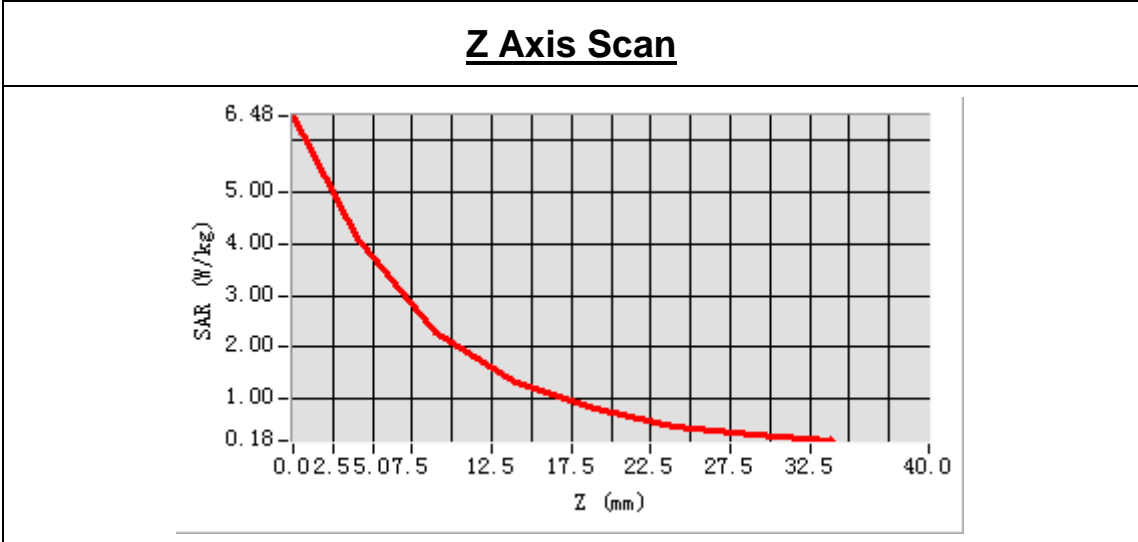

3D screen shot	Hot spot position

System Performance Check Data(1800MHz Body)

Type: Phone measurement (Complete)
 E-Field Probe: SN 34/15 SSE2 EPGO265
 Area scan resolution: dx=8 mm,dy=8 mm
 Zoom scan resolution: dx=8 mm, dy=8 mm, dz=5 mm
 Date of measurement: 2017.03.27
 Measurement duration: 14 minutes 36 seconds

Experimental conditions.

Phantom File	surf_sam_plan.txt
Phantom	Validation plane
Band	1800MHz
Signal	CW
Frequency (MHz)	1800.000000
Relative permittivity (real part)	52.985611
Conductivity (S/m)	1.487654
Power drift (%)	-1.130000
Ambient Temperature:	22.5C
Liquid Temperature:	21.2C
ConvF:	2.08
Crest factor:	1:1

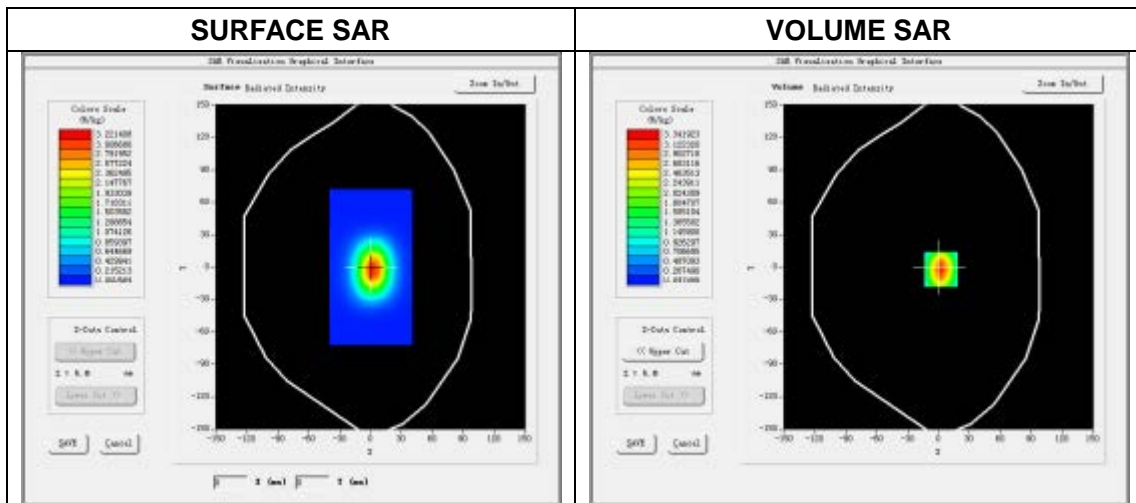

Maximum location: X=2.00, Y=-1.00
 SAR Peak: 6.86 W/kg

SAR 10 g (W/Kg)	2.104346
SAR 1g (W/Kg)	4.071270

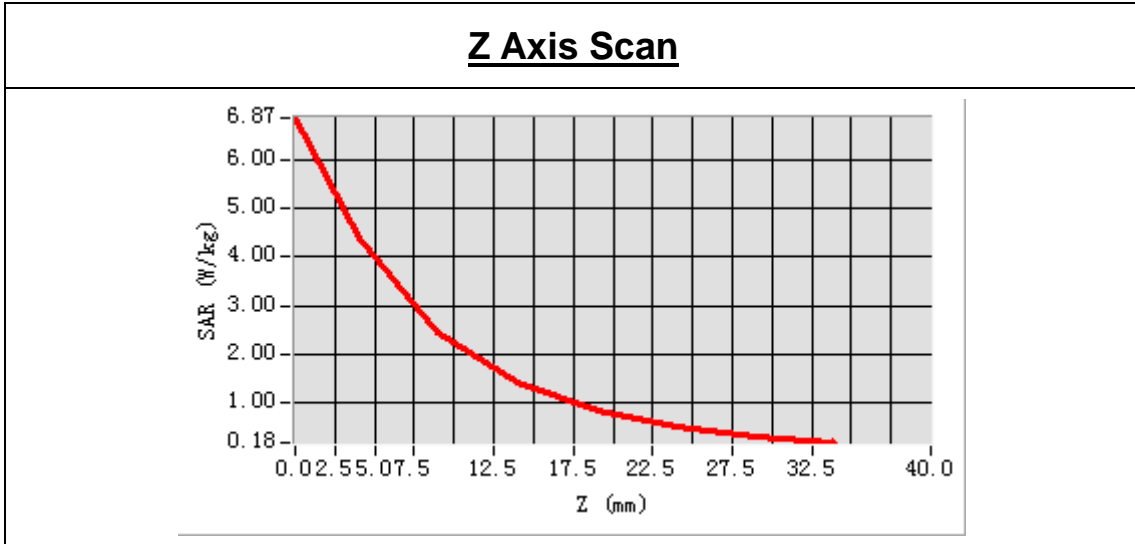

3D screen shot	Hot spot position

System Performance Check Data(1900MHz Head)

Type: Phone measurement (Complete)
 E-Field Probe: SN 34/15 SSE2 EPGO265
 Area scan resolution: dx=8 mm,dy=8 mm
 Zoom scan resolution: dx=8 mm, dy=8 mm, dz=5 mm
 Date of measurement: 2017.03.17
 Measurement duration: 13 minutes 55 seconds

Experimental conditions.

Phantom File	surf_sam_plan.txt
Phantom	Validation plane
Band	1900MHz
Signal	CW
Frequency (MHz)	1900.000000
Relative permittivity (real part)	39.939681
Conductivity (S/m)	1.424179
Power drift (%)	-0.130000
Ambient Temperature:	22.6C
Liquid Temperature:	21.4C
ConvF:	2.35
Crest factor:	1:1

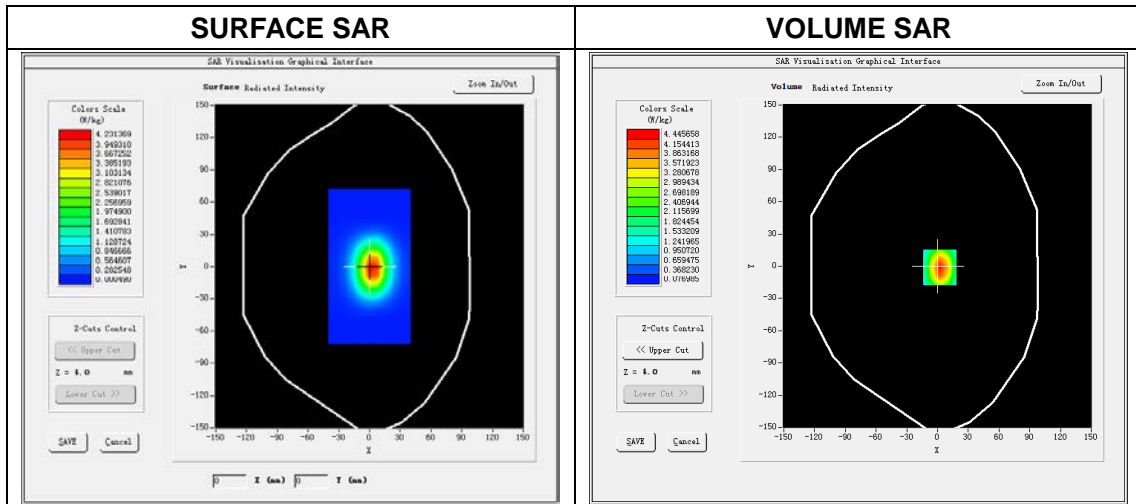

Maximum location: X=2.00, Y=-1.00
 SAR Peak: 6.71W/kg

SAR 10g (W/Kg)	1.980635
SAR 1g (W/Kg)	4.031458

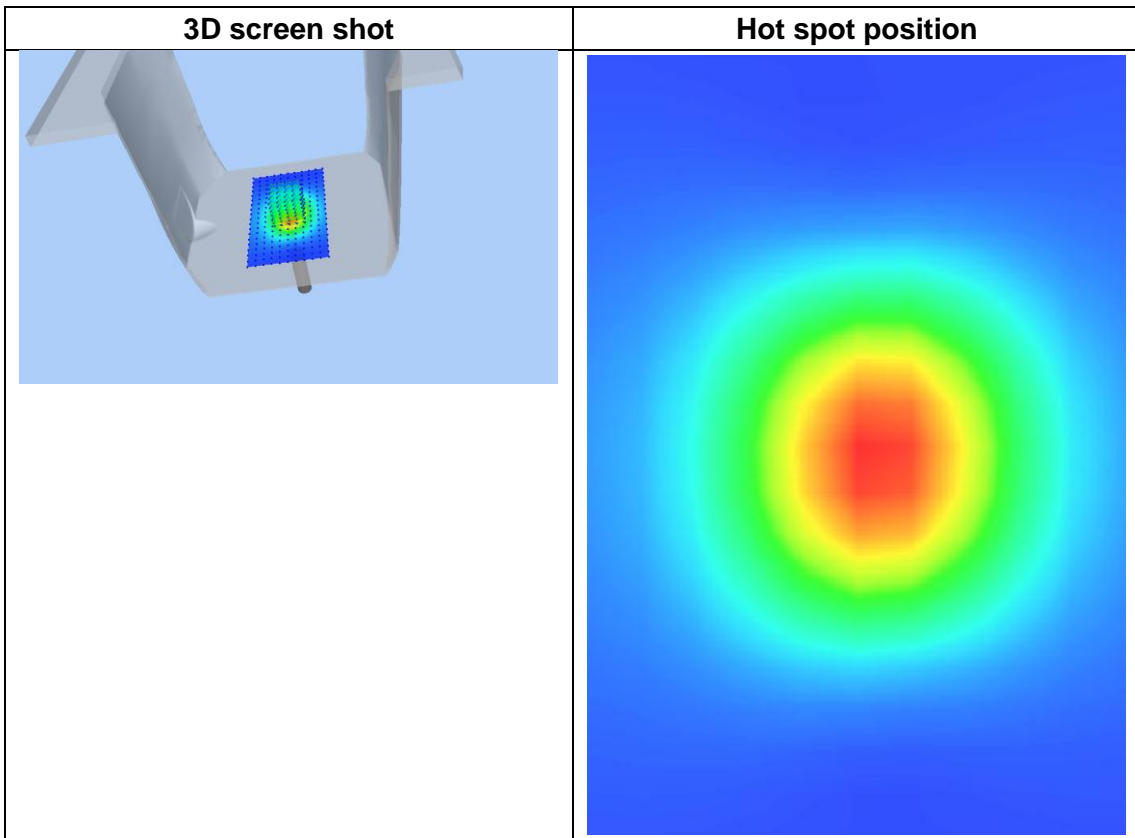
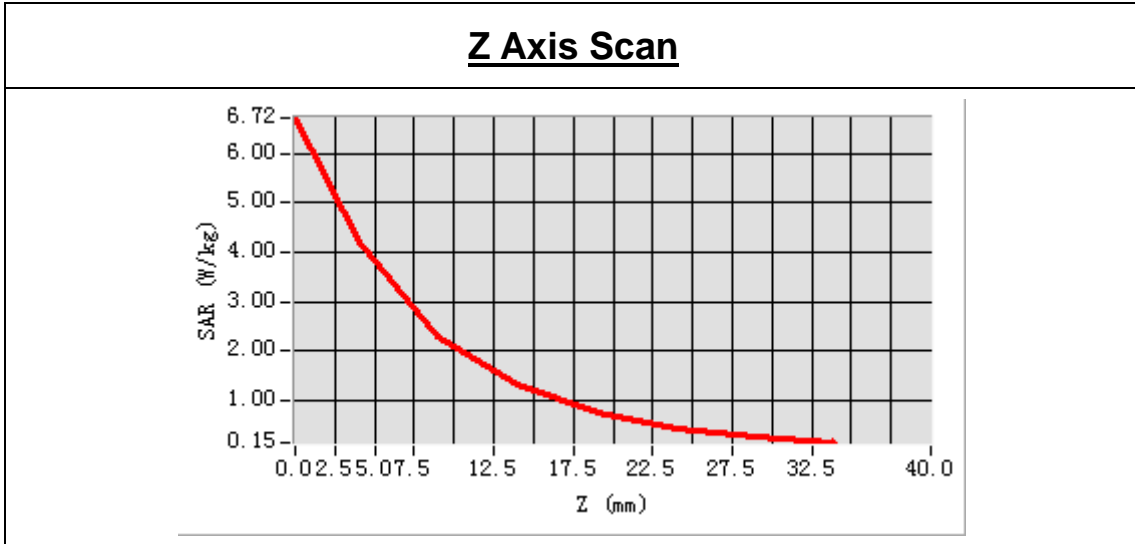

System Performance Check Data(1900MHz Body)

Type: Phone measurement (Complete)
 E-Field Probe: SN 34/15 SSE2 EPGO265
 Area scan resolution: dx=8mm,dy=8mm
 Zoom scan resolution: dx=8mm, dy=8mm, dz=5mm
 Date of measurement: 2017.03.21
 Measurement duration: 13 minutes 23 seconds

Experimental conditions.

Phantom File	surf_sam_plan.txt
Phantom	Validation plane
Band	1900MHz
Signal	CW
Frequency (MHz)	1900.000000
Relative permittivity (real part)	52.184101
Conductivity (S/m)	1.550034
Power drift (%)	0.230000
Ambient Temperature:	22.3C
Liquid Temperature:	21.1C
ConvF:	2.42
Crest factor:	1:1

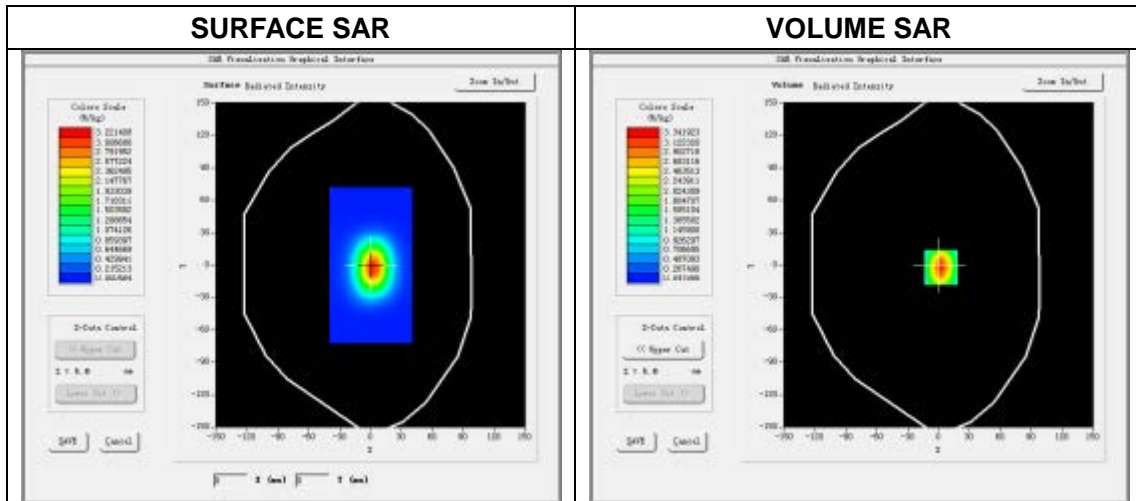

Maximum location: X=2.00, Y=-1.00
 SAR Peak: 6.97W/kg

SAR 10g (W/Kg)	2.139341
SAR 1g (W/Kg)	4.163487

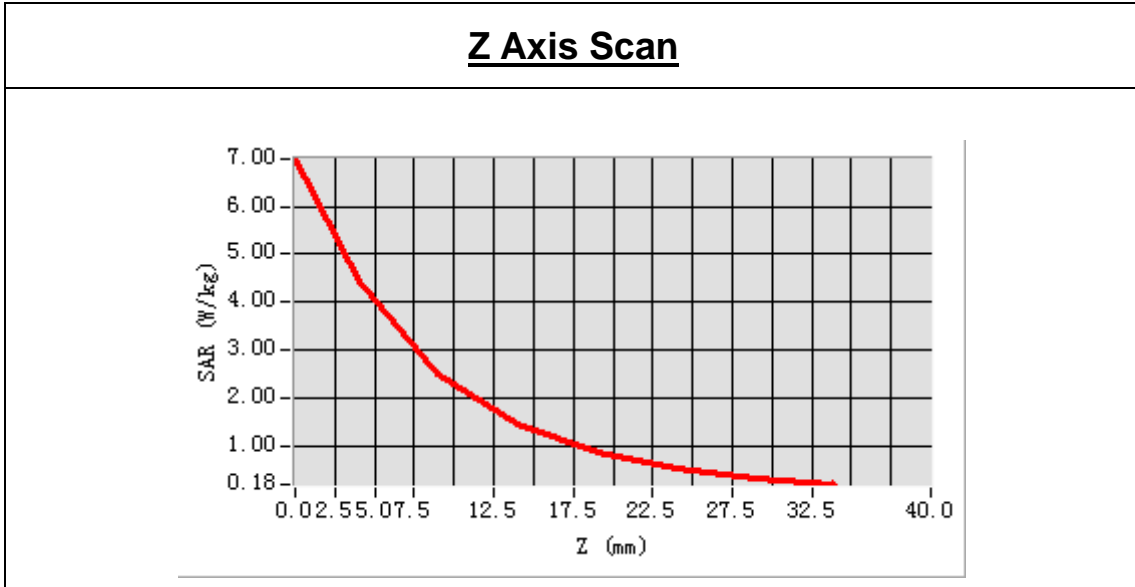

3D screen shot	Hot spot position

System Performance Check Data(2450MHz Head)

Type: Phone measurement (Complete)
 E-Field Probe: SN 34/15 SSE2 EPGO265
 Area scan resolution: dx=8mm,dy=8mm
 Zoom scan resolution: dx=5mm, dy=5mm, dz=5mm
 Date of measurement: 2017.04.16
 Measurement duration: 19 minutes 33 seconds

Experimental conditions.

Phantom File	surf_sam_plan.txt
Phantom	Validation plane
Band	2450MHz
Signal	CW
Frequency (MHz)	2450.000000
Relative permittivity (real part)	38.958257
Conductivity (S/m)	1.830152
Power drift (%)	-1.210000
Ambient Temperature:	22.4C
Liquid Temperature:	21.6C
ConvF:	2.47
Crest factor:	1:1

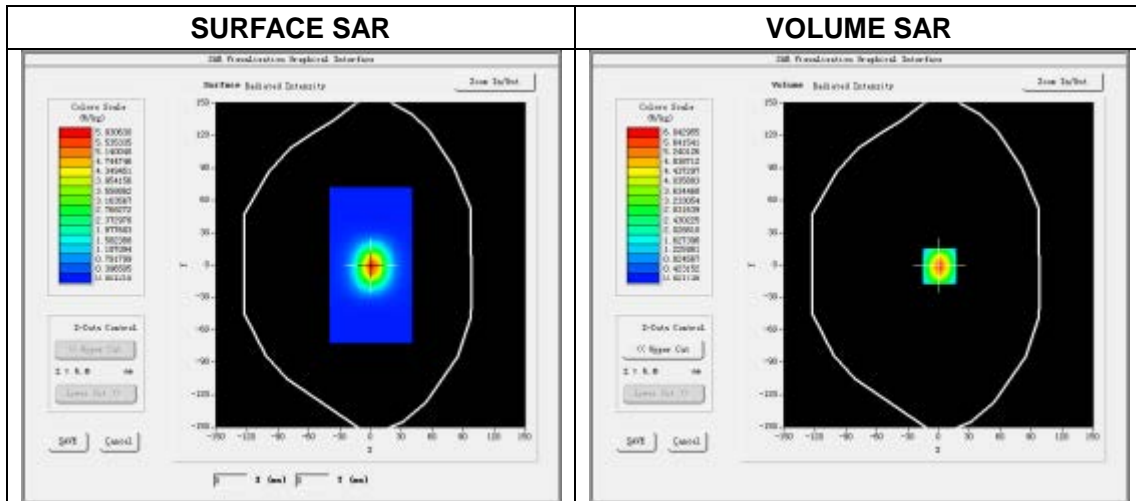

Maximum location: X=0.00, Y=-1.00
 SAR Peak: 9.57W/kg

SAR 10g (W/Kg)	2.379545
SAR 1g (W/Kg)	5.353241

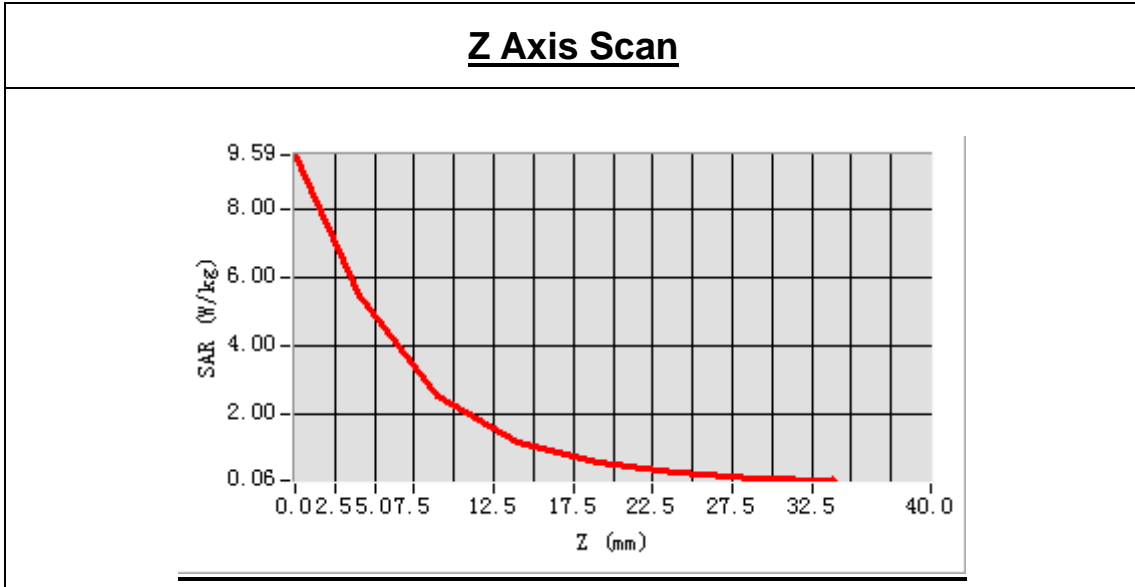

3D screen shot	Hot spot position

System Performance Check Data(2450MHz Body)

Type: Phone measurement (Complete)
 E-Field Probe: SN 34/15 SSE2 EPGO265
 Area scan resolution: dx=8 mm,dy=8 mm
 Zoom scan resolution: dx=5 mm, dy=5 mm, dz=5 mm
 Date of measurement: 2017.04.18
 Measurement duration: 18 minutes 36 seconds

Experimental conditions.

Phantom File	surf_sam_plan.txt
Phantom	Validation plane
Band	2450MHz
Signal	CW
Frequency (MHz)	2450.000000
Relative permittivity (real part)	52.026179
Conductivity (S/m)	1.987356
Power drift (%)	0.930000
Ambient Temperature:	22.6C
Liquid Temperature:	21.4C
ConvF:	2.55
Crest factor:	1:1

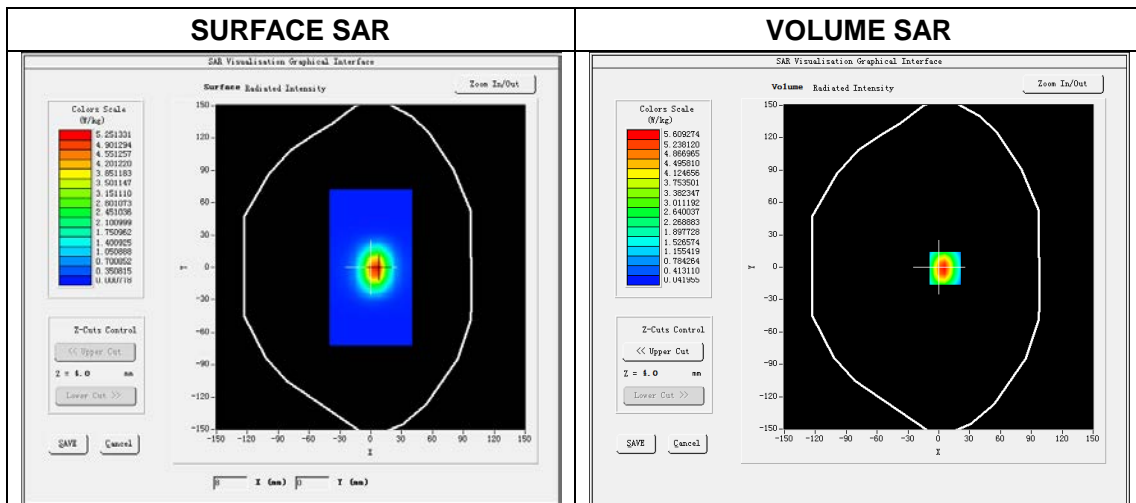

Maximum location: X=-2.00, Y=0.00
 SAR Peak: 9.64W/kg

SAR 10g (W/Kg)	2.373158
SAR 1g (W/Kg)	5.312544

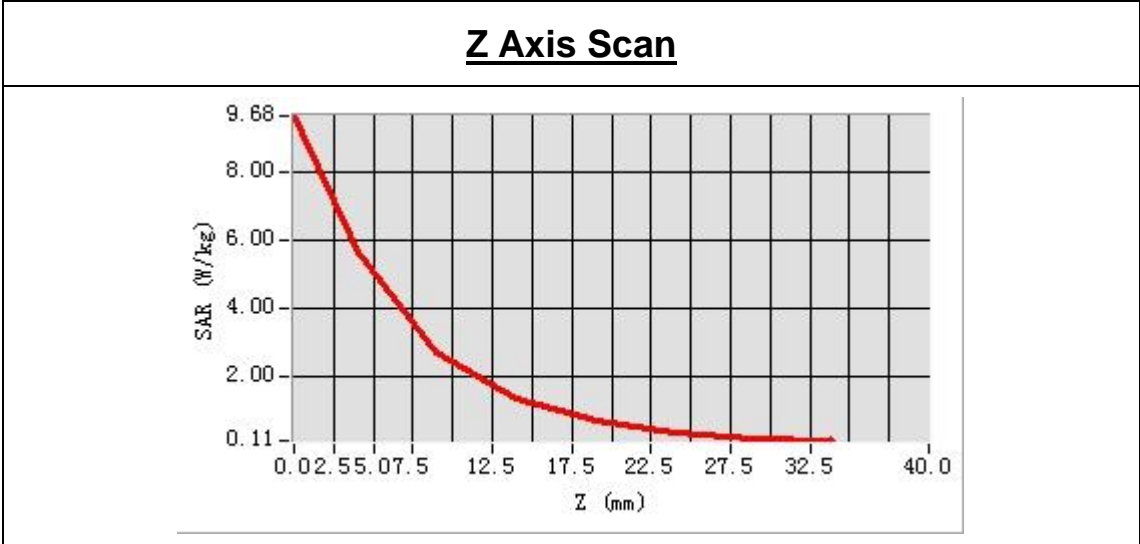

3D screen shot	Hot spot position

System Performance Check Data(2600MHz Head)

Type: Phone measurement (Complete)
 E-Field Probe: SN 34/15 SSE2 EPGO265
 Area scan resolution: dx=8 mm,dy=8 mm
 Zoom scan resolution: dx=5 mm, dy=5 mm, dz=5 mm
 Date of measurement: 2017.03.18
 Measurement duration: 18 minutes 39 seconds

Experimental conditions.

Phantom File	surf_sam_plan.txt
Phantom	Validation plane
Band	2600MHz
Signal	CW
Frequency (MHz)	2600.000000
Relative permittivity (real part)	38.591358
Conductivity (S/m)	1.983652
Power drift (%)	-0.180000
Ambient Temperature:	22.3C
Liquid Temperature:	21.2C
ConvF:	2.36
Crest factor:	1:1



Maximum location: X=1.00, Y=0.00
SAR Peak: 10.41 W/kg

SAR 10 g (W/Kg)	2.419235
SAR 1g (W/Kg)	5.498391

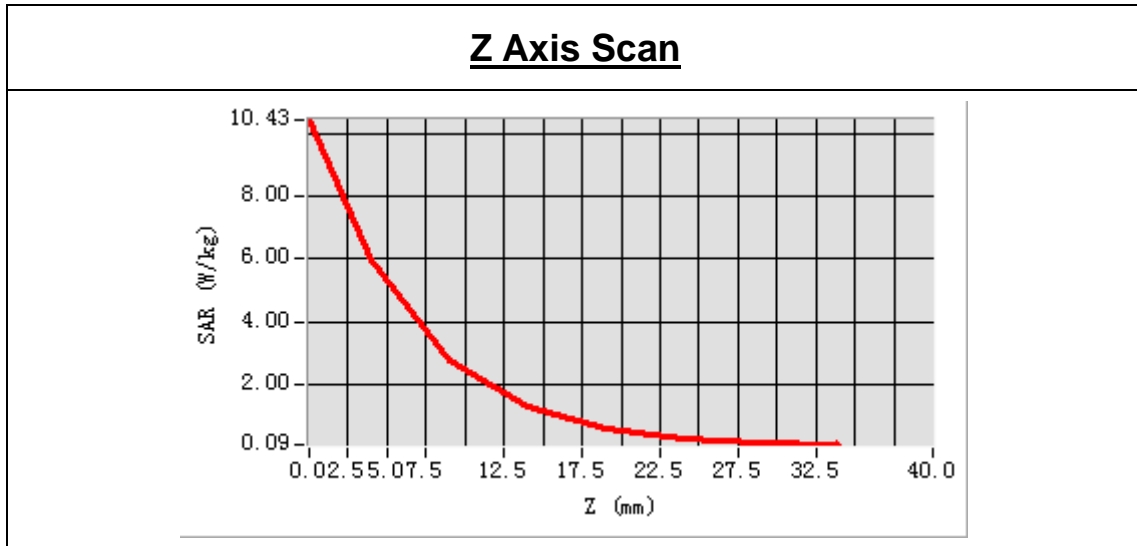

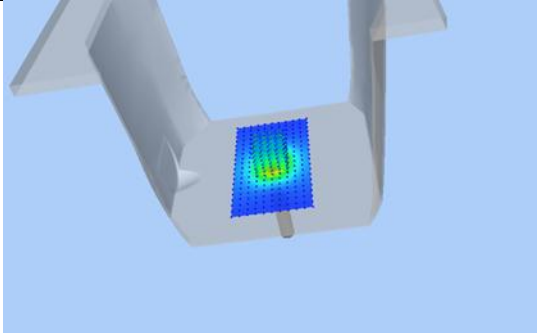
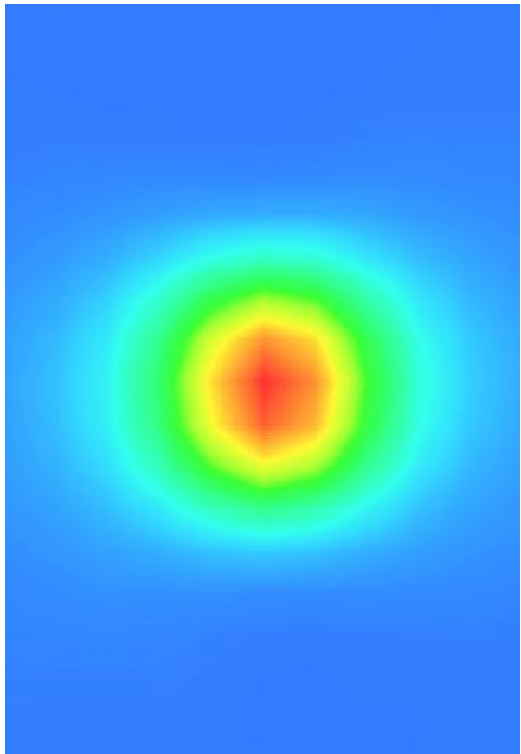
<p style="text-align: center;">3D screen shot</p>	<p style="text-align: center;">Hot spot position</p>
	

System Performance Check Data(2600MHz Body)

Type: Phone measurement (Complete)
 E-Field Probe: SN 34/15 SSE2 EPGO265
 Area scan resolution: dx=8mm,dy=8mm
 Zoom scan resolution: dx=5mm, dy=5mm, dz=5mm
 Date of measurement: 2017.03.19
 Measurement duration: 19 minutes 28 seconds

Experimental conditions.

Phantom File	surf_sam_plan.txt
Phantom	Validation plane
Band	2600MHz
Signal	CW
Frequency (MHz)	2600.000000
Relative permittivity (real part)	51.533618
Conductivity (S/m)	2.154841
Power drift (%)	-0.350000
Ambient Temperature:	22.8C
Liquid Temperature:	21.4C
ConvF:	2.43
Crest factor:	1:1

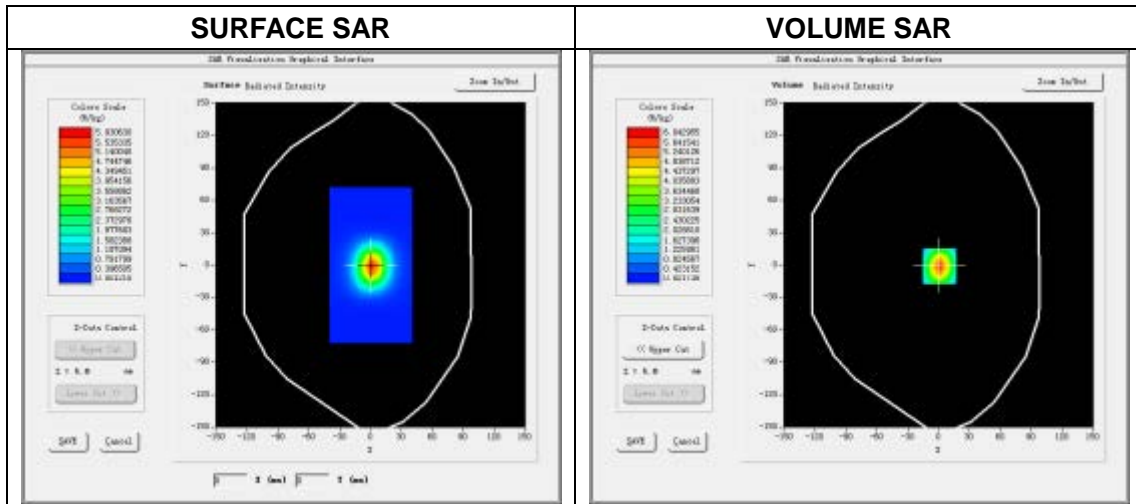

Maximum location: X=0.00, Y=-1.00
 SAR Peak: 9.52W/kg

SAR 10g (W/Kg)	2.495516
SAR 1g (W/Kg)	5.870154

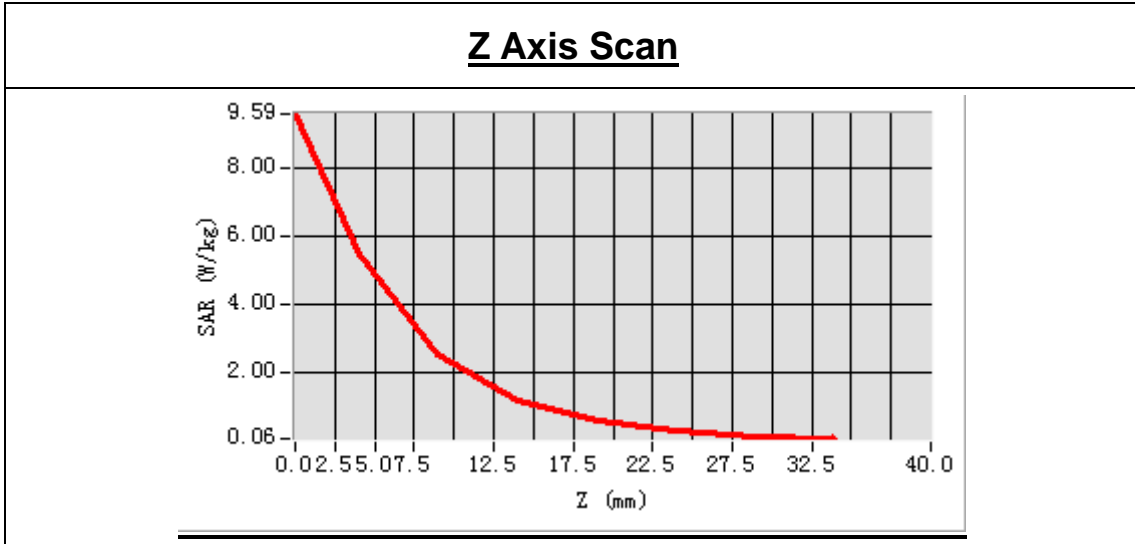

3D screen shot	Hot spot position

System Performance Check Data(5200 MHz Head)

Type: Phone measurement (Complete)
 E-Field Probe: SN 34/15 SSE2 EPGO265
 Area scan resolution: dx=8 mm,dy=8 mm
 Zoom scan resolution: dx=4 mm, dy=4 mm, dz=2 mm
 Date of measurement: 2017.04.19
 Measurement duration: 30 minutes 26 seconds

Experimental conditions.

Phantom File	surf_sam_plan.txt
Phantom	Validation plane
Band	5200 MHz
Signal	CW
Frequency (MHz)	5200.000000
Relative permittivity (real part)	36.415258
Conductivity (S/m)	4.792585
Power drift (%)	0.210000
Ambient Temperature:	22.3C
Liquid Temperature:	21.1C
ConvF:	1.81
Crest factor:	1:1

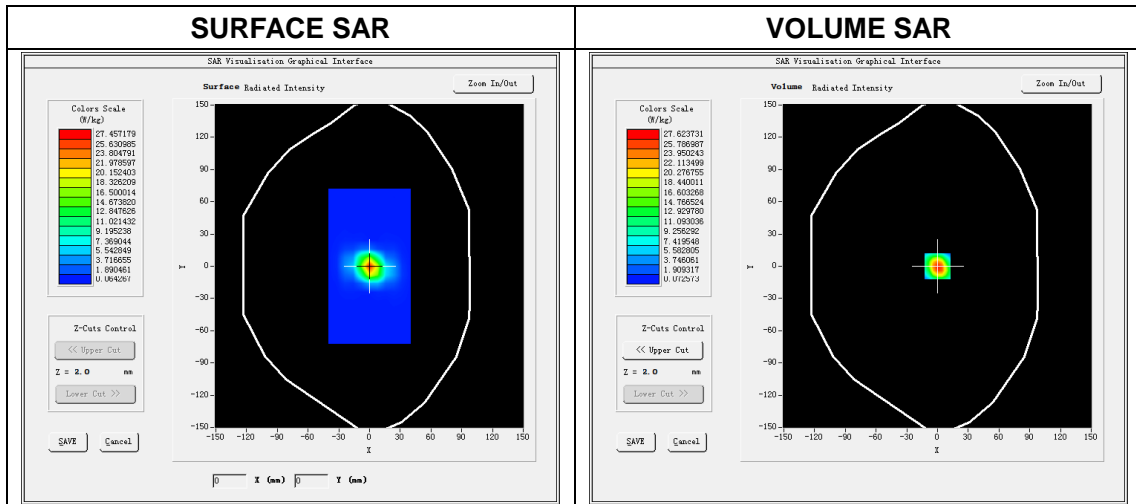

Maximum location: X=0.00, Y=0.00

SAR Peak: 44.7 W/kg

SAR 10 g (W/Kg)	5.282463
SAR 1 g (W/Kg)	15.399158

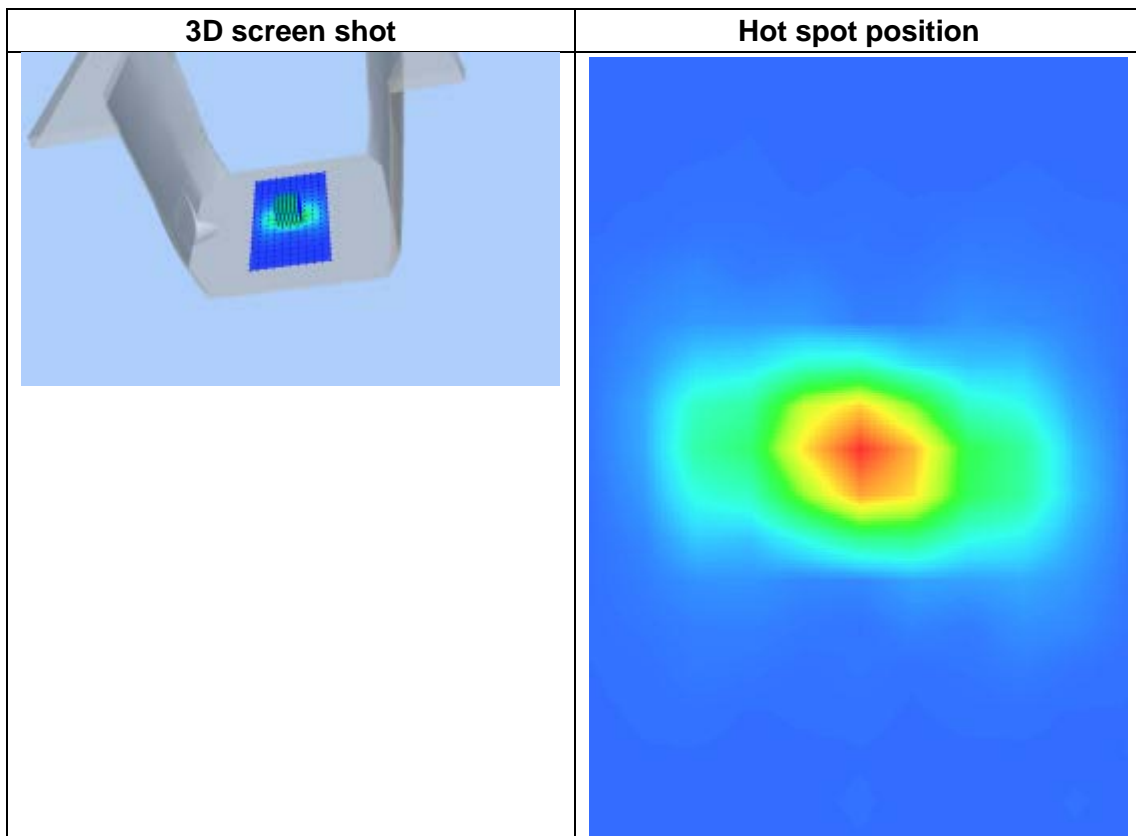
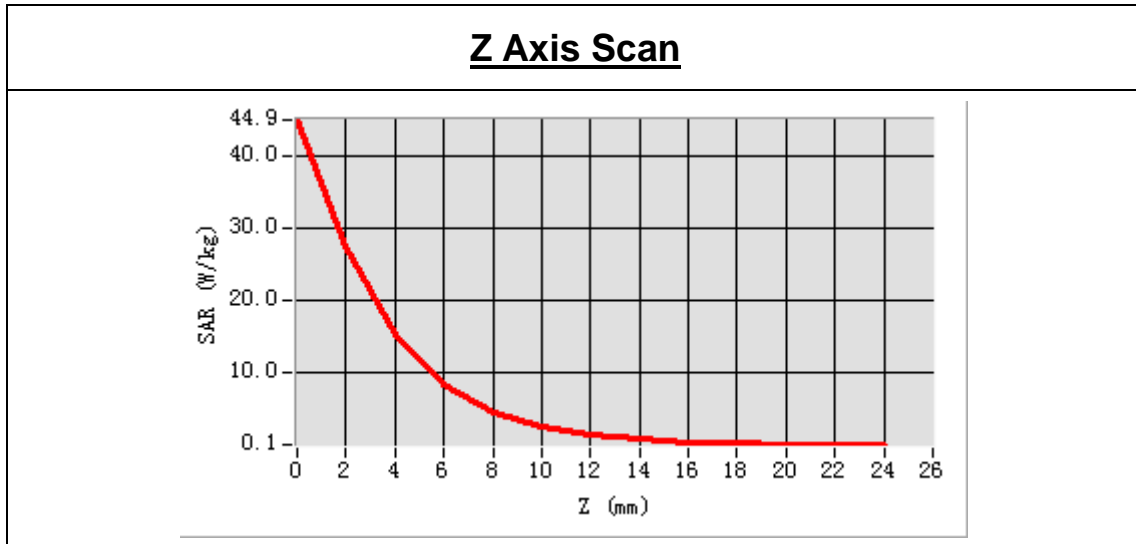

System Performance Check Data(5200 MHz Body)

Type: Phone measurement (Complete)
 E-Field Probe: SN 34/15 SSE2 EPGO265
 Area scan resolution: dx=8 mm,dy=8 mm
 Zoom scan resolution: dx=4 mm, dy=4 mm, dz=2 mm
 Date of measurement: 2017.04.21
 Measurement duration: 29 minutes 37 seconds

Experimental conditions.

Phantom File	surf_sam_plan.txt
Phantom	Validation plane
Band	5200 MHz
Signal	CW
Frequency (MHz)	5200.000000
Relative permittivity (real part)	49.132479
Conductivity (S/m)	5.257382
Power drift (%)	0.280000
Ambient Temperature:	22.1C
Liquid Temperature:	20.9C
ConvF:	1.85
Crest factor:	1:1

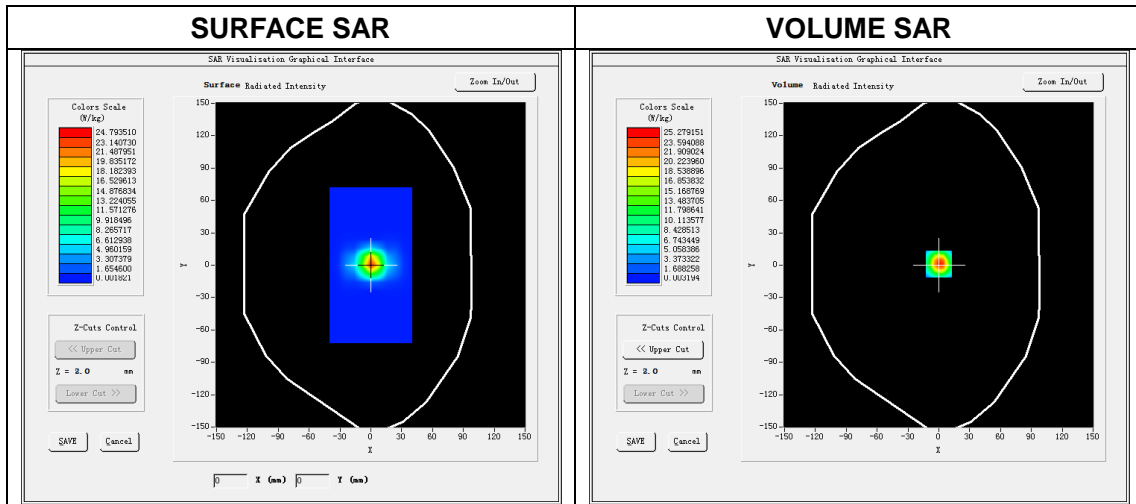

Maximum location: X=0.00, Y=1.00
 SAR Peak: 41.18 W/kg

SAR 10 g (W/Kg)	5.413725
SAR 1 g (W/Kg)	15.416258

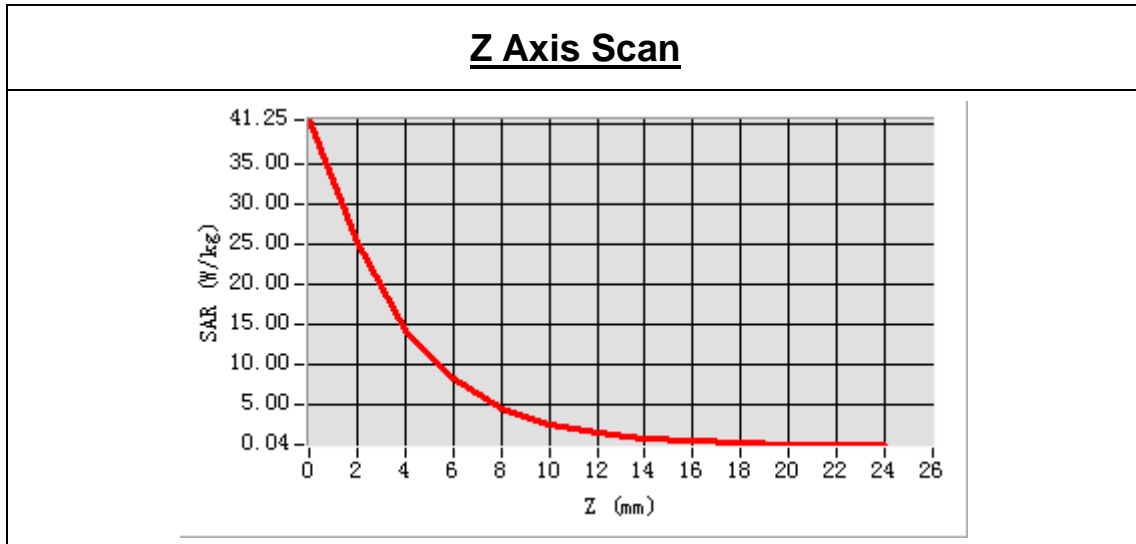

3D screen shot	Hot spot position

System Performance Check Data(5800 MHz Head)

Type: Phone measurement (Complete)
 E-Field Probe: SN 34/15 SSE2 EPGO265
 Area scan resolution: dx=8 mm,dy=8 mm
 Zoom scan resolution: dx=4 mm, dy=4 mm, dz=2 mm
 Date of measurement: 2017.04.20
 Measurement duration: 29 minutes 37 seconds

Experimental conditions.

Phantom File	surf_sam_plan.txt
Phantom	Validation plane
Band	5800 MHz
Signal	CW
Frequency (MHz)	5800.000000
Relative permittivity (real part)	34.351392
Conductivity (S/m)	5.494376
Power drift (%)	1.350000
Ambient Temperature:	22.4C
Liquid Temperature:	21.2C
ConvF:	1.88
Crest factor:	1:1

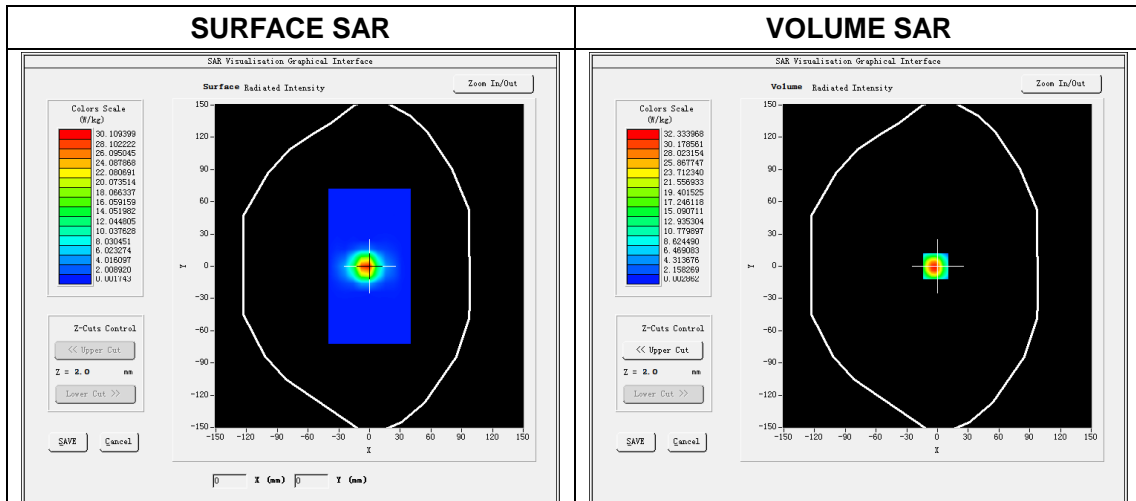

Maximum location: X=-2.00, Y=0.00
 SAR Peak: 51.15W/kg

SAR 10g (W/Kg)	6.162549
SAR 1g (W/Kg)	18.256235

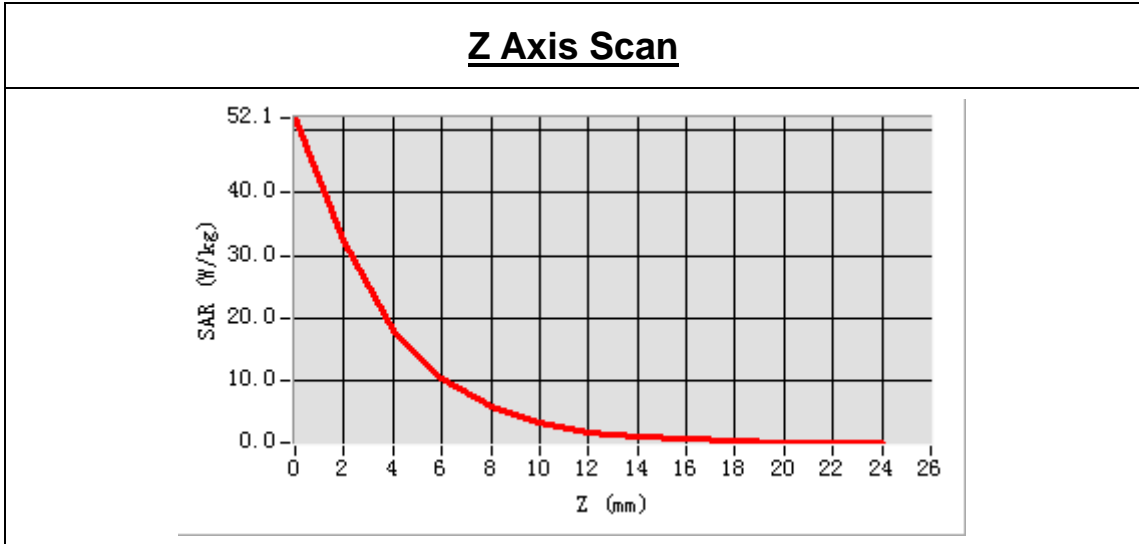

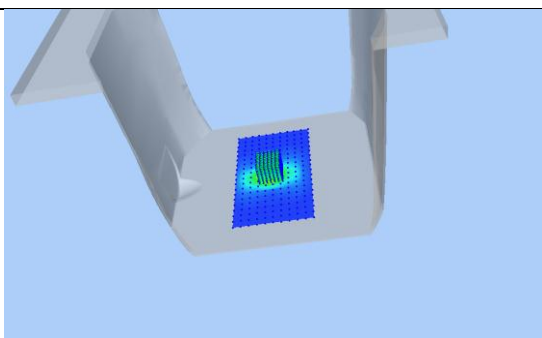
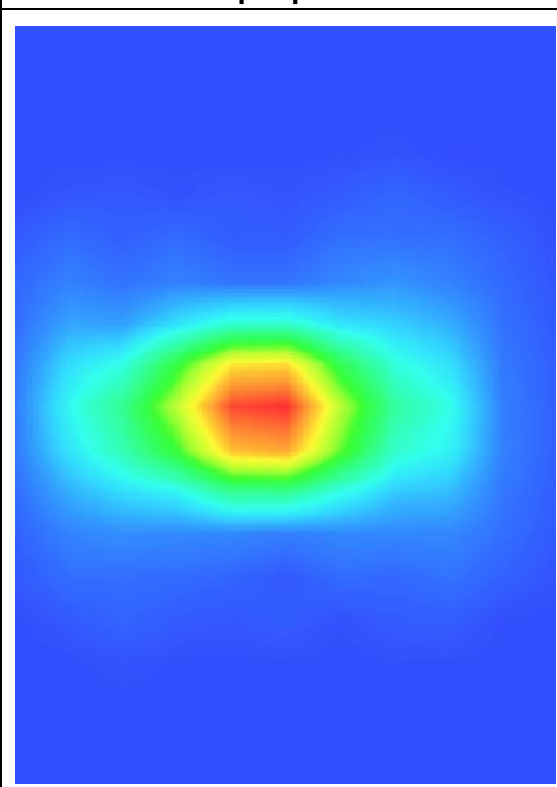
3D screen shot	Hot spot position
	

System Performance Check Data(5800 MHz Body)

Type: Phone measurement (Complete)
 E-Field Probe: SN 34/15 SSE2 EPGO265
 Area scan resolution: dx=8 mm,dy=8 mm
 Zoom scan resolution: dx=4 mm, dy=4 mm, dz=2 mm
 Date of measurement: 2017.04.24
 Measurement duration: 29 minutes 31 seconds

Experimental conditions.

Phantom File	surf_sam_plan.txt
Phantom	Validation plane
Band	5800 MHz
Signal	CW
Frequency (MHz)	5800.000000
Relative permittivity (real part)	48.145306
Conductivity (S/m)	5.963132
Power drift (%)	0.950000
Ambient Temperature:	22.5C
Liquid Temperature:	21.3C
ConvF:	1.93
Crest factor:	1:1

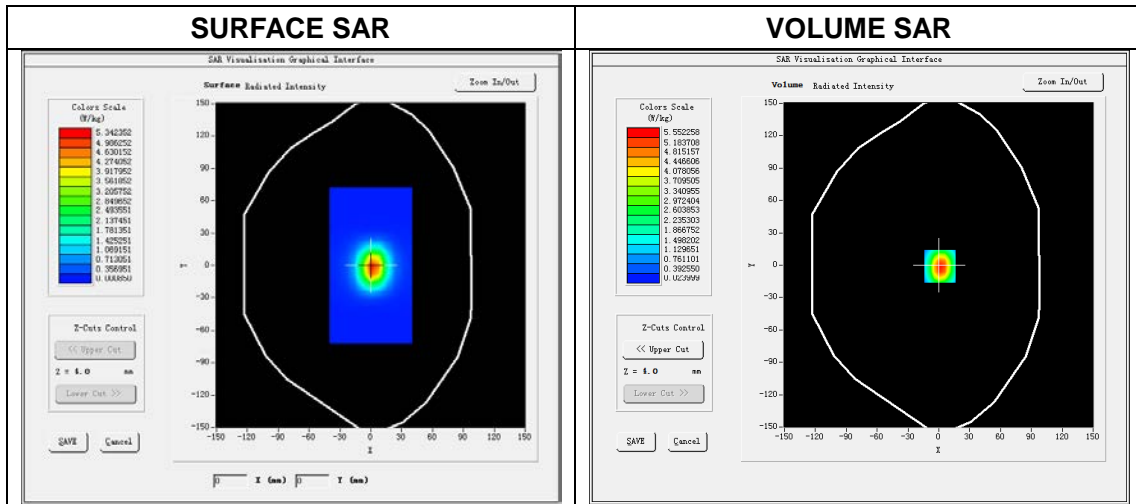

Maximum location: X=2.00, Y=-1.00
 SAR Peak: 51.27 W/kg

SAR 10 g (W/Kg)	5.895802
SAR 1 g (W/Kg)	17.379326

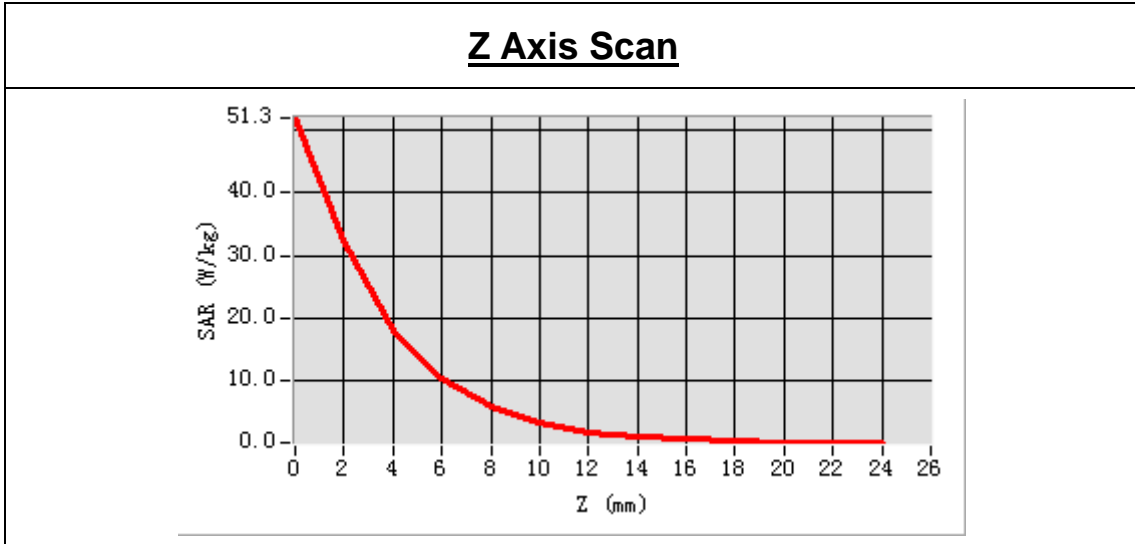

3D screen shot	Hot spot position

ANNEX C TEST DATA

MEAS. 1 Right Head with Cheek on Low Channel in GSM 850 mode

Test Date: 23/3/2017
Measurement duration: 11 minutes 24 seconds
Signal: GSM, f=824.2 MHz, Duty Cycle: 1:8.3
Liquid Parameters: Permittivity: 41.97; Conductivity: 0.89 S/m
Test condition: Ambient Temperature: 22.7°C, Liquid Temperature: 21.5°C
Probe: SN 34/15 SSE2 EPGO265, ConvF: 2.04
Area Scan: sam_direct_droit2_surf10mm.txt, h= 5.00 mm
Zoom Scan: 5x5x7,dx=8mm, dy=8mm, dz=5mm,Complete
Maximum location: X=-46.000000, Y=-46.000000
SAR 10g (W/Kg): 0.221403
SAR 1g (W/Kg): 0.299570
Power drift (%): -0.78
3D screen shot

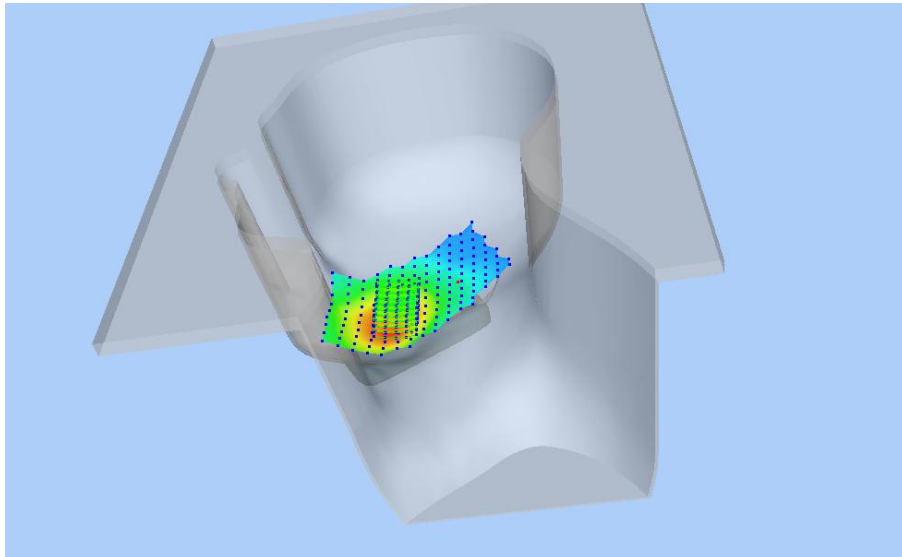

Z Axis Scan

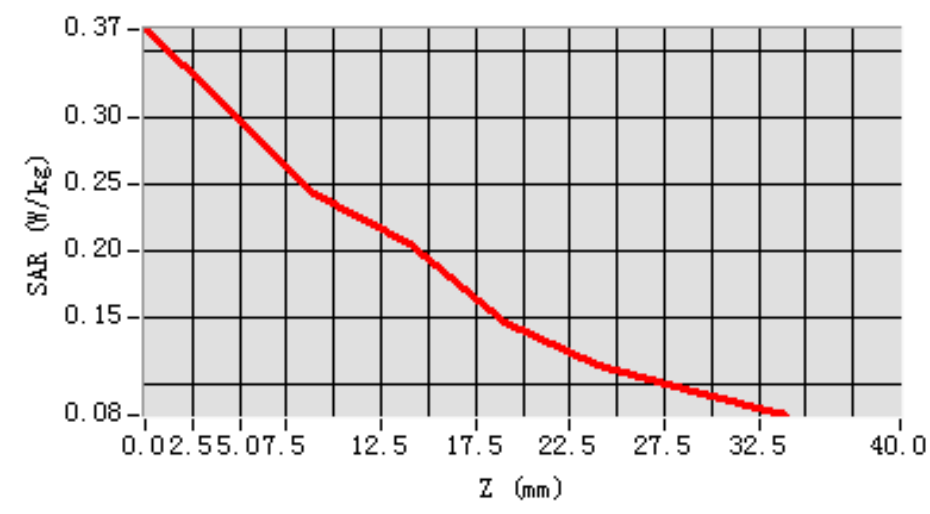

MEAS. 2 Body Plane with Back Side 10mm on Low Channel in GPRS 850 mode

Test Date: 30/3/2017
Measurement duration: 10 minutes 31 seconds
Signal: GSM, f=824.2 MHz, Duty Cycle: 1:2.0
Liquid Parameters: Permittivity: 54.84; Conductivity: 0.98 S/m
Test condition: Ambient Temperature: 22.2°C, Liquid Temperature: 21.0°C
Probe: SN 34/15 SSE2 EPGO265, ConvF: 2.12
Area Scan: sam_direct_droit2_surf10mm.txt, h= 5.00 mm
Zoom Scan: 5x5x7,dx=8mm, dy=8mm, dz=5mm,Complete
Maximum location: X=0.000000, Y=-22.000000
SAR 10g (W/Kg): 0.452004
SAR 1g (W/Kg): 0.816001
Power drift (%): -0.01
3D screen shot

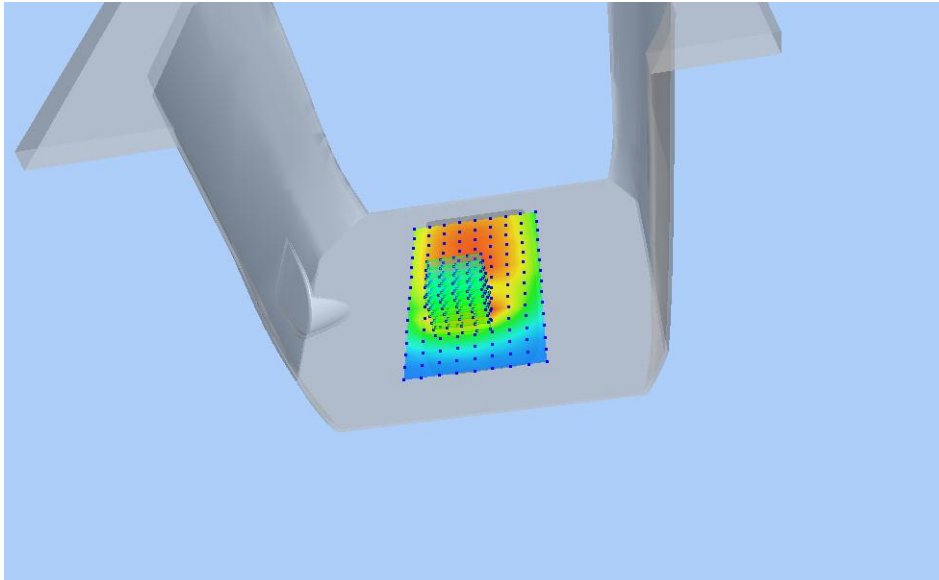

Z Axis Scan

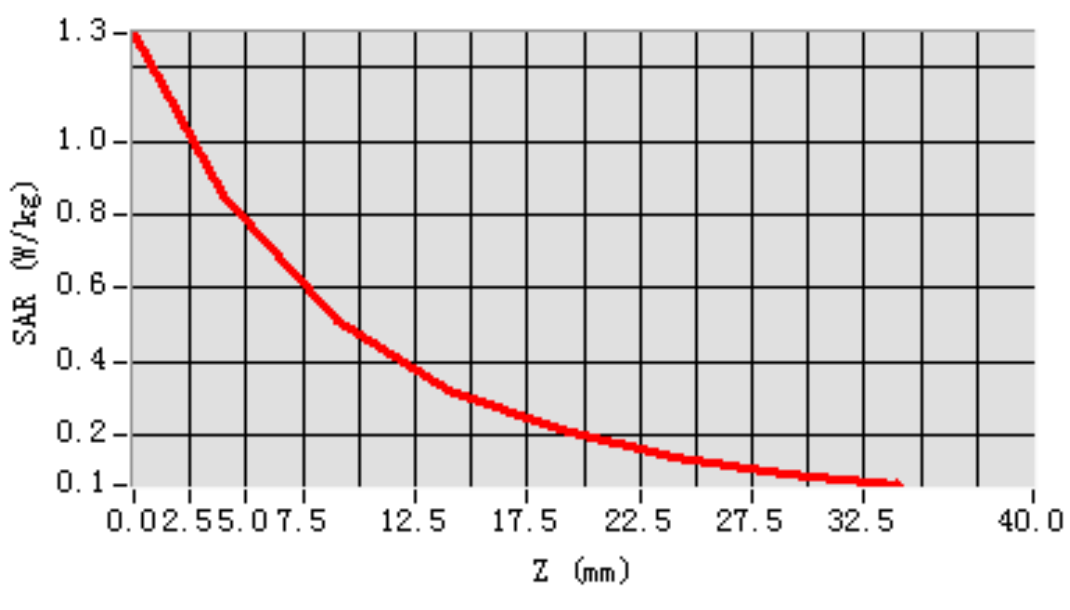

MEAS. 3 Left Head with Cheek on High Channel in GSM 1900 mode

Test Date: 17/3/2017
Measurement duration: 12 minutes 17 seconds
Signal: GSM, f=1909.8 MHz, Duty Cycle: 1:8.3
Liquid Parameters: Permittivity: 39.84; Conductivity: 1.44 S/m
Test condition: Ambient Temperature: 22.6°C, Liquid Temperature: 21.4°C
Probe: SN 34/15 SSE2 EPGO265, ConvF: 2.35
Area Scan: sam_direct_droit2_surf10mm.txt, h= 5.00 mm
Zoom Scan: 5x5x7,dx=8mm, dy=8mm, dz=5mm,Complete
Maximum location: X=-56.000000, Y=-66.000000
SAR 10g (W/Kg): 0.069392
SAR 1g (W/Kg): 0.116017
Power drift (%): -1.17
3D screen shot

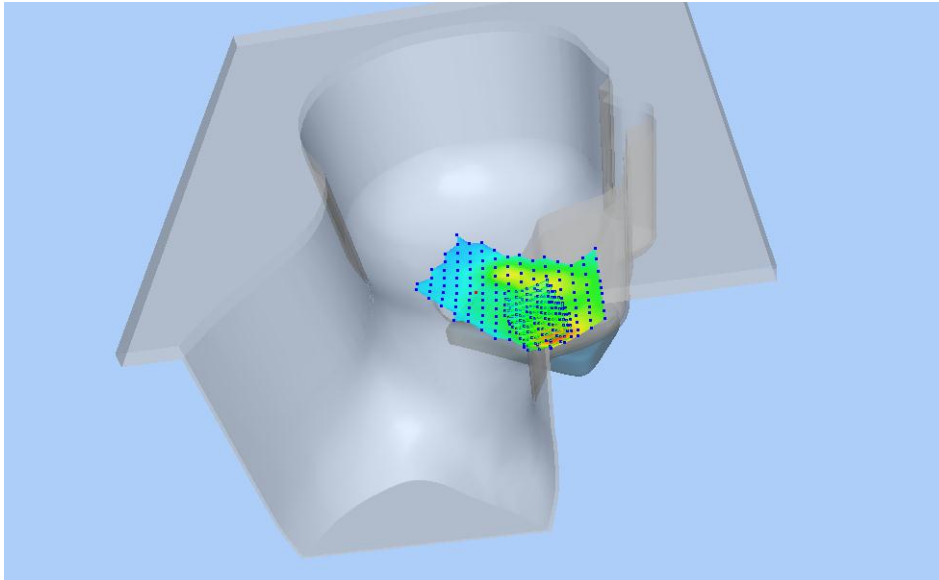

Z Axis Scan

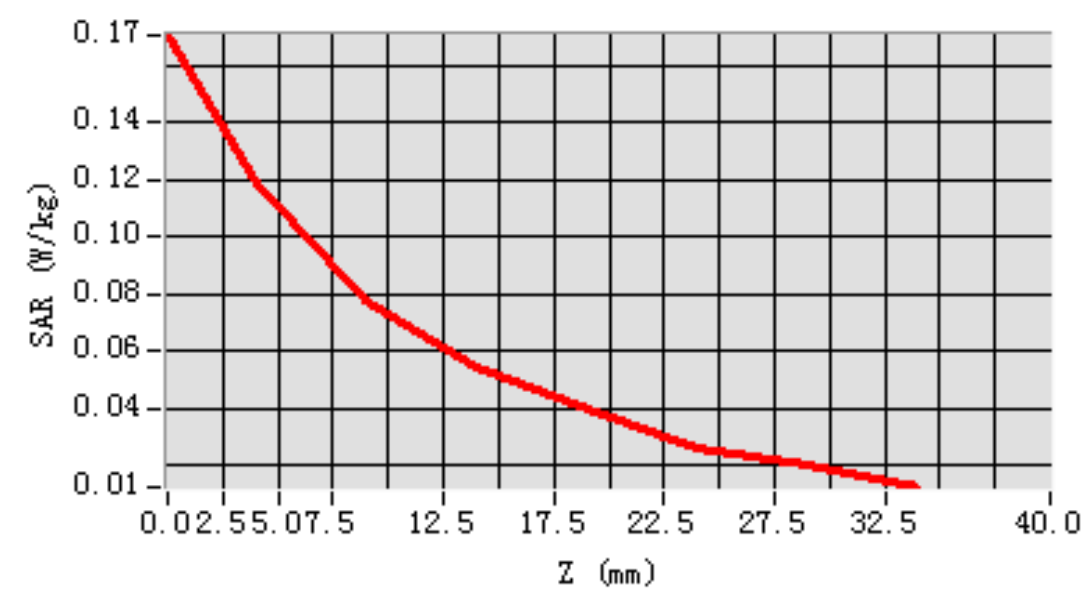

MEAS. 4 Body Plane with Bottom Edge 10mm on High Channel in GPRS 1900

mode

Test Date: 21/3/2017
Measurement duration: 12 minutes 19 seconds
Signal: GSM, f=1909.8 MHz, Duty Cycle: 1:2.0
Liquid Parameters: Permittivity: 51.33; Conductivity: 1.56 S/m
Test condition: Ambient Temperature: 22.3°C, Liquid Temperature: 21.1°C
Probe: SN 34/15 SSE2 EPGO265, ConvF: 2.42
Area Scan: sam_direct_droit2_surf10mm.txt, h= 5.00 mm
Zoom Scan: 5x5x7,dx=8mm, dy=8mm, dz=5mm,Complete
Maximum location: X=0.000000, Y=-12.000000
SAR 10g (W/Kg): 0.377871
SAR 1g (W/Kg): 0.697535
Power drift (%): -2.51
3D screen shot

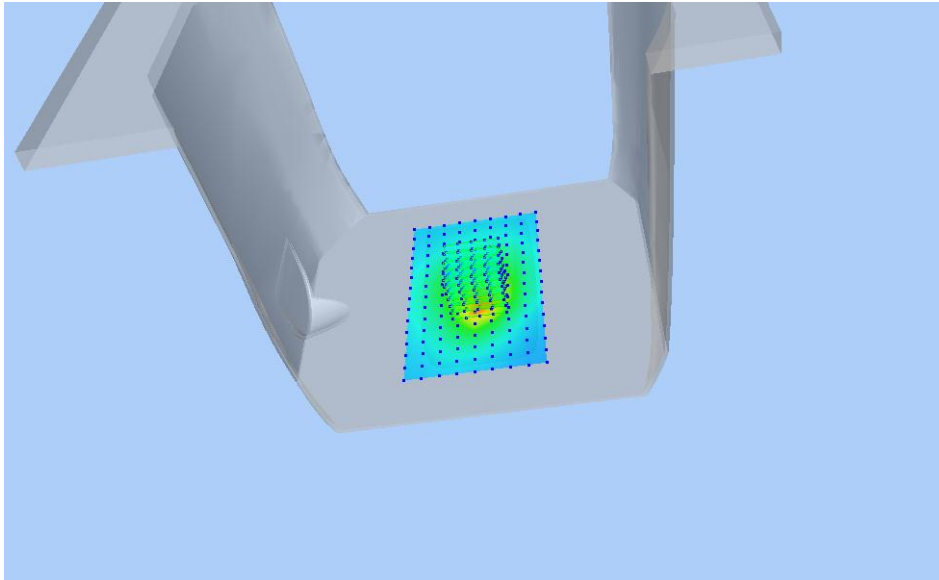

Z Axis Scan

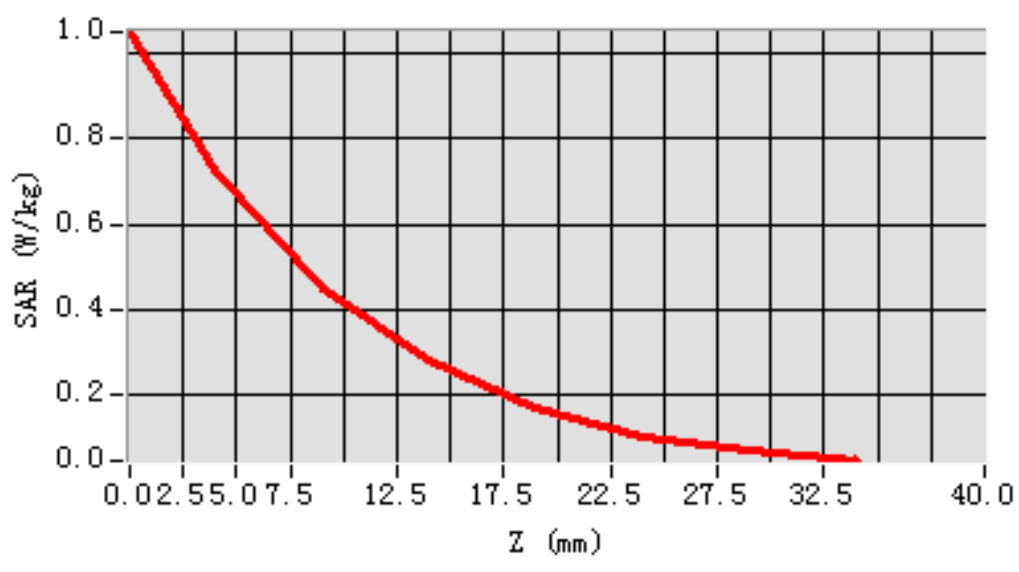

MEAS. 5 Left Head with Cheek on High Channel in WCDMA Band 2 mode

Test Date: 17/3/2017
Measurement duration: 12 minutes 15 seconds
Signal: WCDMA, f=1907.6 MHz, Duty Cycle: 1:1.0
Liquid Parameters: Permittivity: 39.86; Conductivity: 1.43 S/m
Test condition: Ambient Temperature: 22.6°C, Liquid Temperature: 21.4°C
Probe: SN 34/15 SSE2 EPGO265, ConvF: 2.35
Area Scan: sam_direct_droit2_surf10mm.txt, h= 5.00 mm
Zoom Scan: 5x5x7,dx=8mm, dy=8mm, dz=5mm,Complete
Maximum location: X=-56.000000, Y=-66.000000
SAR 10g (W/Kg): 0.138211
SAR 1g (W/Kg): 0.227106
Power drift (%): -1.33
3D screen shot

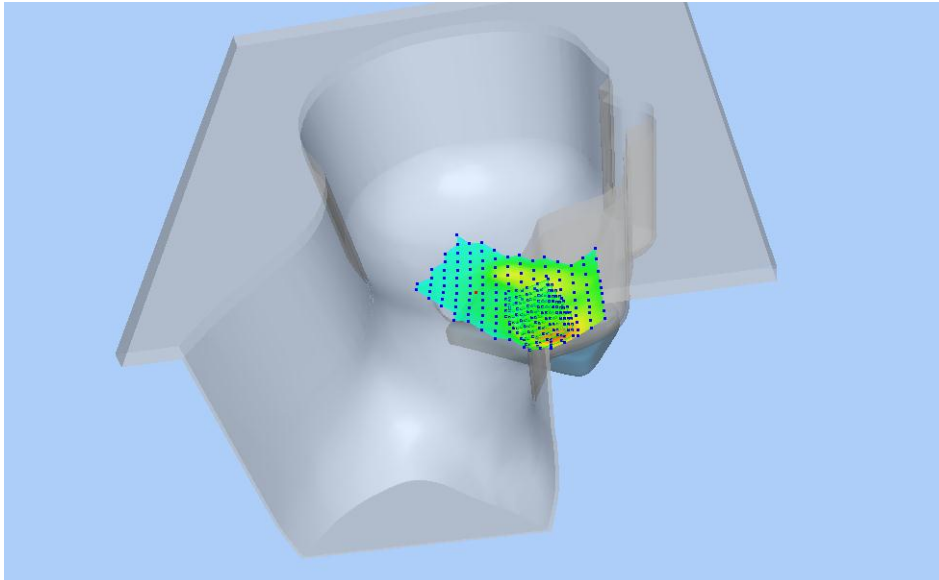

Z Axis Scan

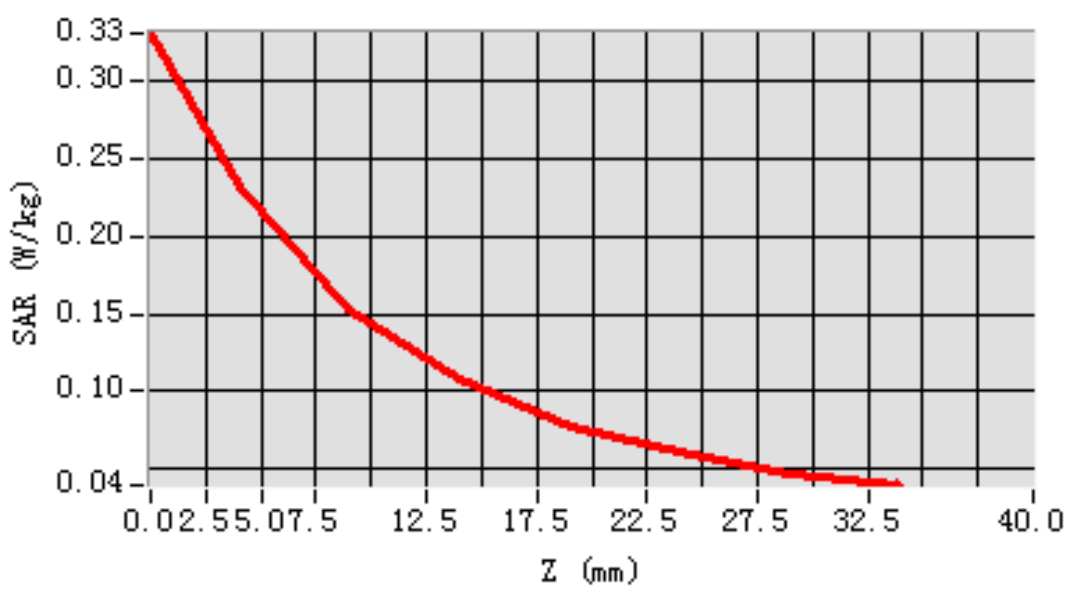

MEAS. 6 Body Plane with Bottom Edge 10mm on High Channel in WCDMA

Band 2 mode

Test Date:	21/3/2017
Measurement duration:	12 minutes 21 seconds
Signal:	WCDMA, f=1907.6 MHz, Duty Cycle: 1:1.0
Liquid Parameters:	Permittivity: 51.49; Conductivity: 1.56 S/m
Test condition:	Ambient Temperature: 22.3°C, Liquid Temperature: 21.1°C
Probe:	SN 34/15 SSE2 EPGO265, ConvF: 2.42
Area Scan:	sam_direct_droit2_surf10mm.txt, h= 5.00 mm
Zoom Scan:	5x5x7,dx=8mm, dy=8mm, dz=5mm,Complete
Maximum location:	X=0.000000, Y=-12.000000
SAR 10g (W/Kg):	0.485365
SAR 1g (W/Kg):	0.885137
Power drift (%):	-0.94
3D screen shot	

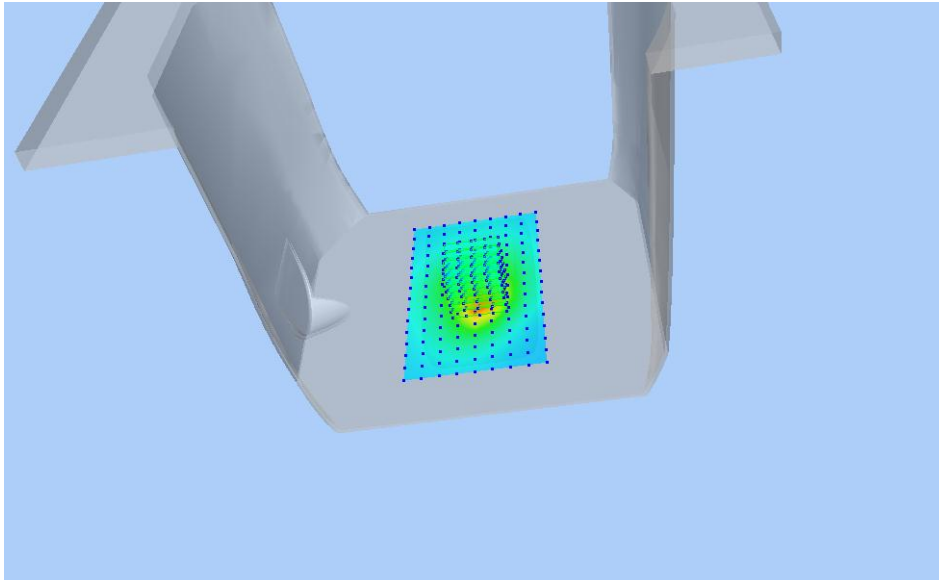

Z Axis Scan

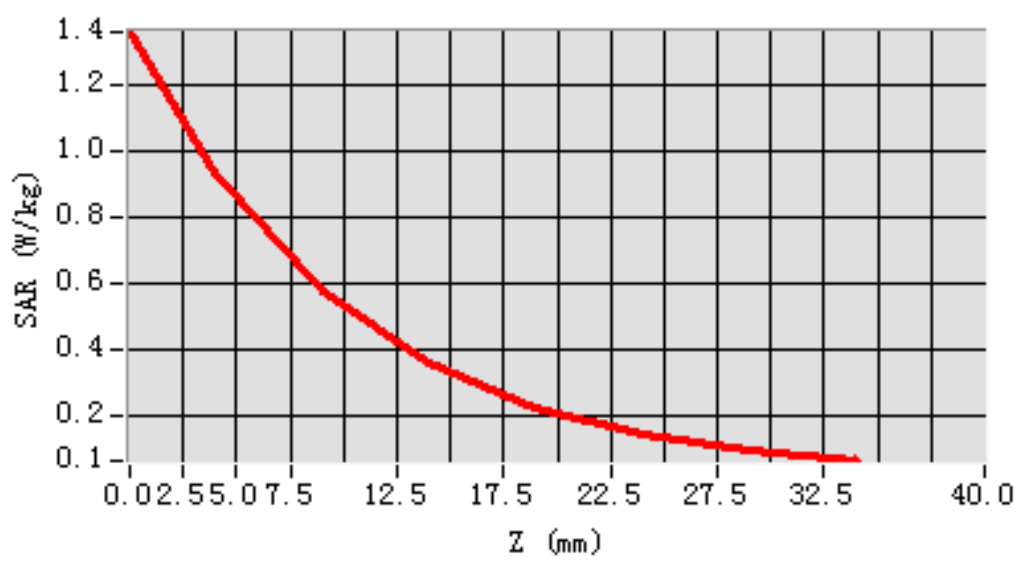

MEAS. 7 Left Head with Cheek on Middle Channel in WCDMA Band 4 mode

Test Date: 29/3/2017
Measurement duration: 11 minutes 34 seconds
Signal: WCDMA, f=1732.4 MHz, Duty Cycle: 1:1.0
Liquid Parameters: Permittivity: 41.43; Conductivity: 1.35 S/m
Test condition: Ambient Temperature: 22.4°C, Liquid Temperature: 21.1°C
Probe: SN 34/15 SSE2 EPGO265, ConvF: 2.04
Area Scan: sam_direct_droit2_surf10mm.txt, h= 5.00 mm
Zoom Scan: 5x5x7,dx=8mm, dy=8mm, dz=5mm,Complete
Maximum location: X=-46.000000, Y=-56.000000
SAR 10g (W/Kg): 0.134069
SAR 1g (W/Kg): 0.207369
Power drift (%): -4.12
3D screen shot

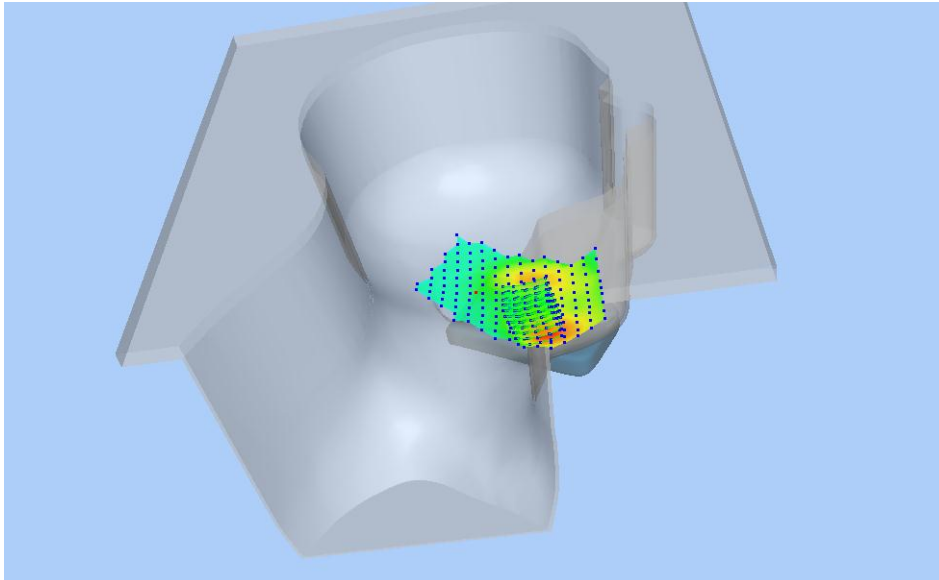

Z Axis Scan

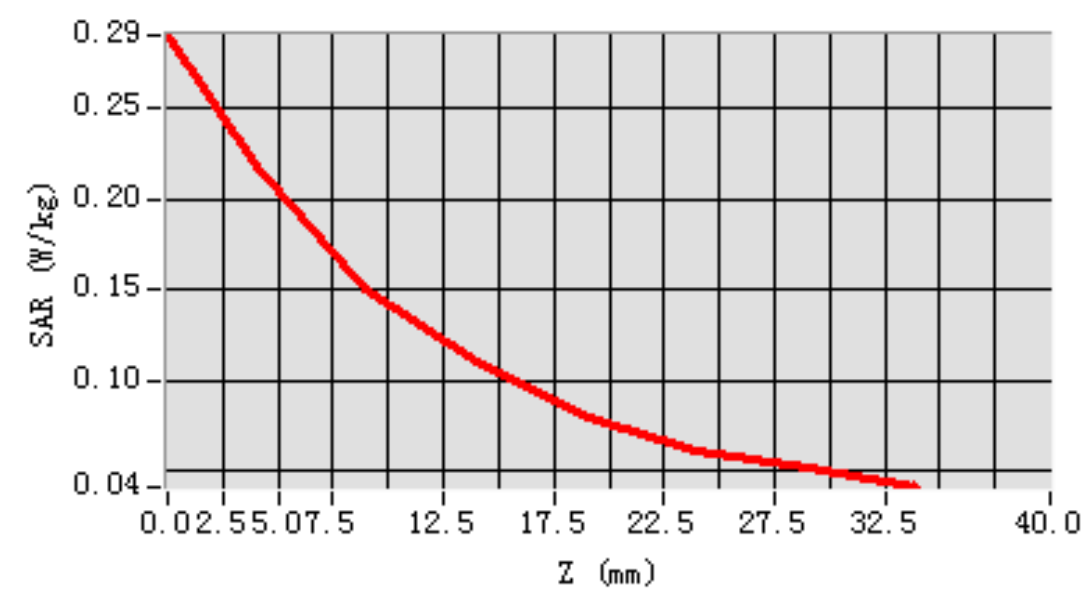

MEAS. 8 Body Plane with Bottom Edge 10mm on Low Channel in WCDMA

Band 4 mode

Test Date:	27/3/2017
Measurement duration:	11 minutes 55 seconds
Signal:	WCDMA, f=1712.4 MHz, Duty Cycle: 1:1.0
Liquid Parameters:	Permittivity: 53.81; Conductivity: 1.46 S/m
Test condition:	Ambient Temperature: 22.5°C, Liquid Temperature: 21.2°C
Probe:	SN 34/15 SSE2 EPGO265, ConvF: 2.08
Area Scan:	sam_direct_droit2_surf10mm.txt, h= 5.00 mm
Zoom Scan:	5x5x7,dx=8mm, dy=8mm, dz=5mm,Complete
Maximum location:	X=0.000000, Y=-2.000000
SAR 10g (W/Kg):	0.501895
SAR 1g (W/Kg):	0.905729
Power drift (%):	-2.78
3D screen shot	

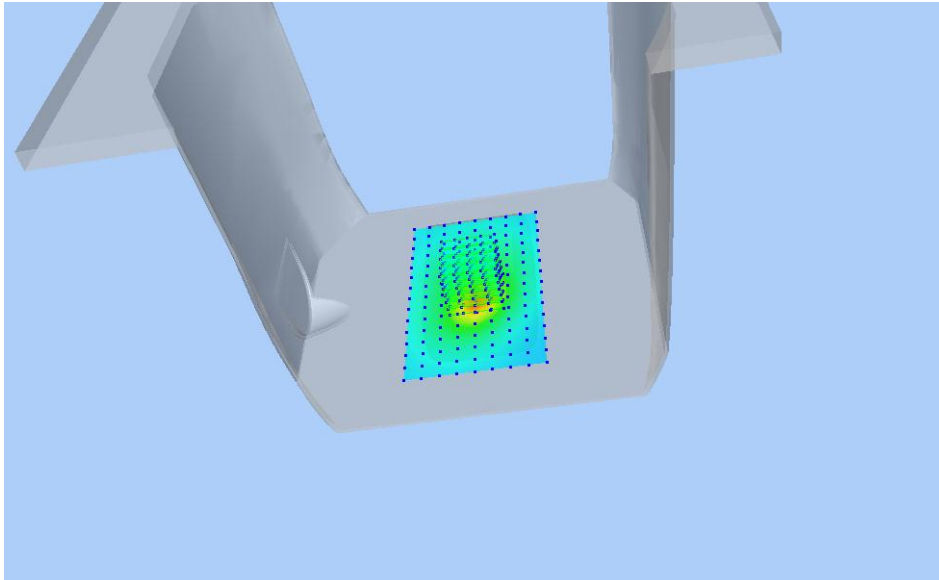

Z Axis Scan

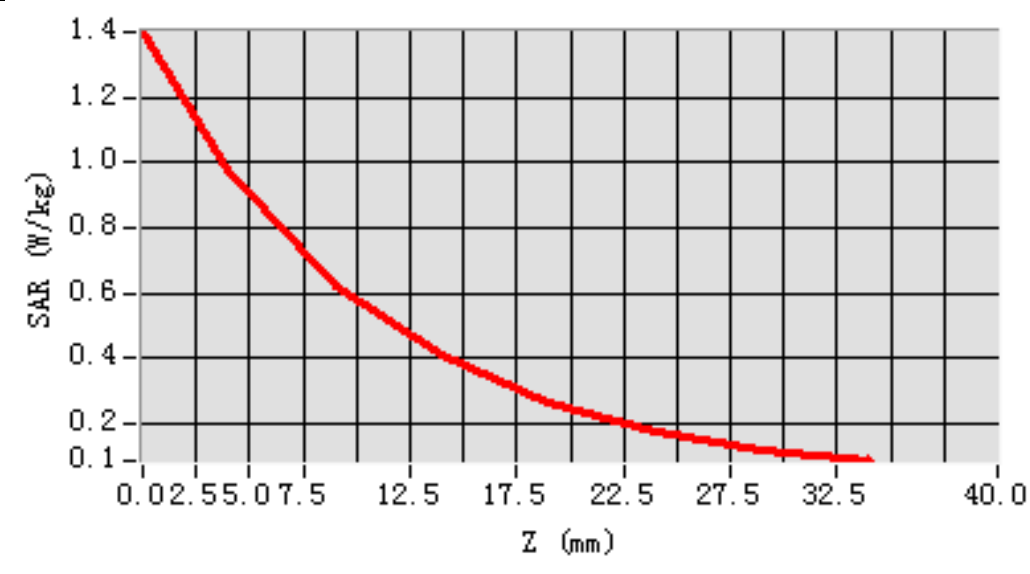

MEAS. 9 Right Head with Cheek on Middle Channel in WCDMA Band 5 mode

Test Date: 23/3/2017
Measurement duration: 11 minutes 13 seconds
Signal: WCDMA, f=836.4 MHz, Duty Cycle: 1:1.0
Liquid Parameters: Permittivity: 41.64; Conductivity: 0.89 S/m
Test condition: Ambient Temperature: 22.7°C, Liquid Temperature: 21.5°C
Probe: SN 34/15 SSE2 EPGO265, ConvF: 2.04
Area Scan: sam_direct_droit2_surf10mm.txt, h= 5.00 mm
Zoom Scan: 5x5x7,dx=8mm, dy=8mm, dz=5mm,Complete
Maximum location: X=-56.000000, Y=-46.000000
SAR 10g (W/Kg): 0.248550
SAR 1g (W/Kg): 0.323284
Power drift (%): 3.57
3D screen shot

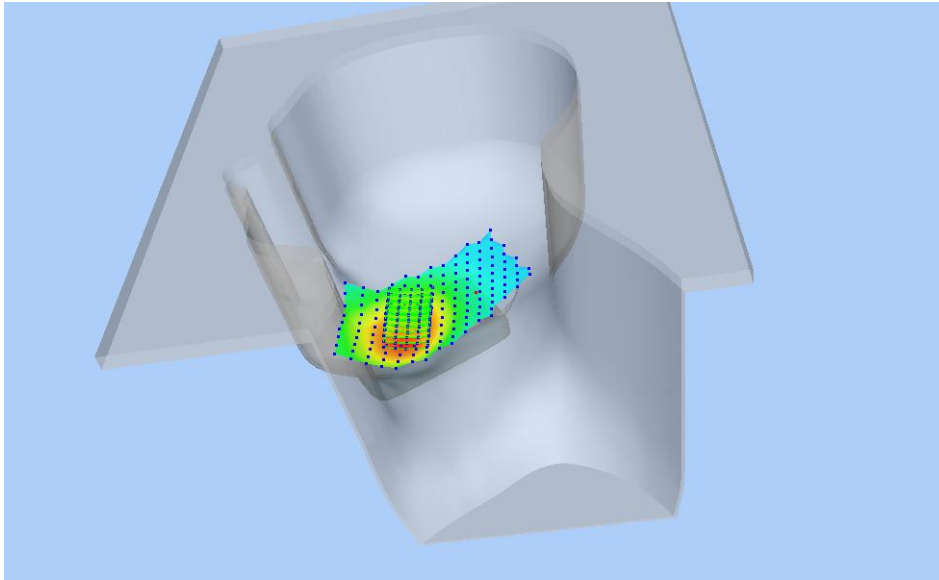

Z Axis Scan

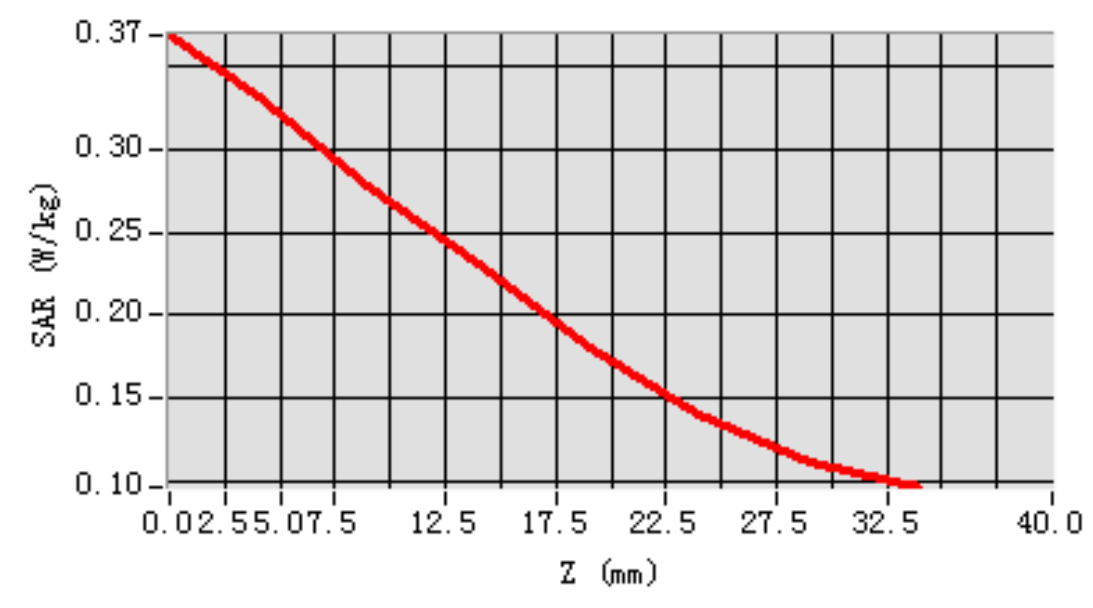

MEAS. 10 Body Plane with Back Side 10mm on Middle Channel in WCDMA

Band 5 mode

Test Date:	30/3/2017
Measurement duration:	11 minutes 43 seconds
Signal:	WCDMA, f=836.4 MHz, Duty Cycle: 1:1.0
Liquid Parameters:	Permittivity: 53.76; Conductivity: 0.99 S/m
Test condition:	Ambient Temperature: 22.2°C, Liquid Temperature: 21.0°C
Probe:	SN 34/15 SSE2 EPGO265, ConvF: 2.12
Area Scan:	sam_direct_droit2_surf10mm.txt, h= 5.00 mm
Zoom Scan:	5x5x7,dx=8mm, dy=8mm, dz=5mm,Complete
Maximum location:	X=0.000000, Y=-32.000000
SAR 10g (W/Kg):	0.257269
SAR 1g (W/Kg):	0.450314
Power drift (%):	-0.15
3D screen shot	

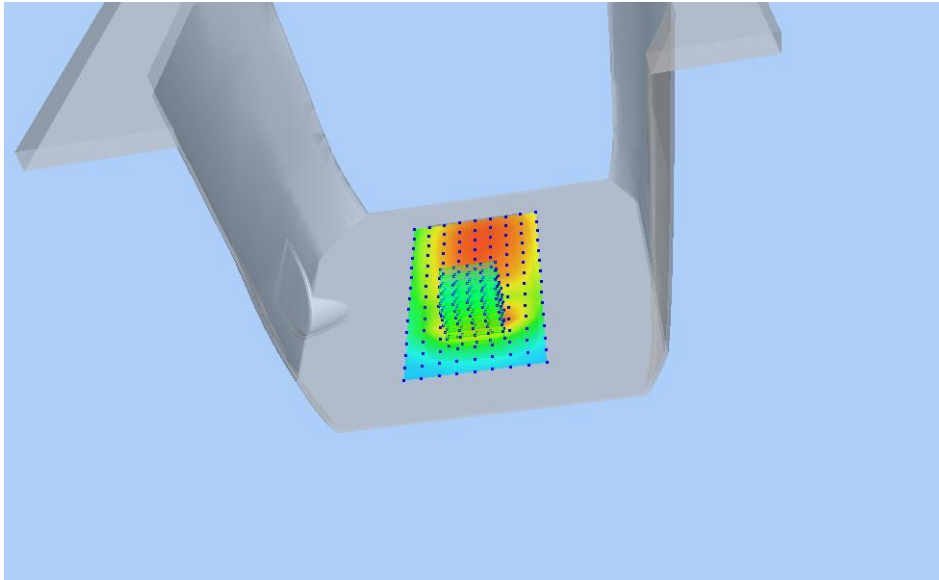

Z Axis Scan

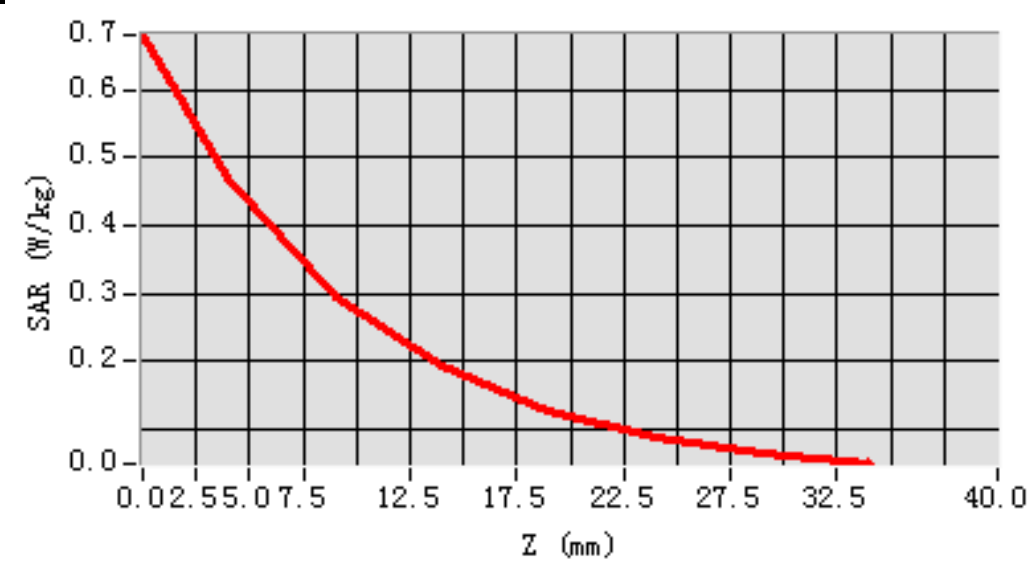

MEAS. 11 Left Head with Cheek on Low Channel in LTE Band 2 mode with 1RB

Test Date: 17/3/2017
Measurement duration: 12 minutes 15 seconds
Signal: LTE, f=1860.0 MHz, Duty Cycle: 1:1.0
Liquid Parameters: Permittivity: 39.96; Conductivity: 1.40 S/m
Test condition: Ambient Temperature: 22.6°C, Liquid Temperature: 21.4°C
Probe: SN 34/15 SSE2 EPGO265, ConvF: 2.35
Area Scan: sam_direct_droit2_surf10mm.txt, h= 5.00 mm
Zoom Scan: 5x5x7,dx=8mm, dy=8mm, dz=5mm,Complete
Maximum location: X=-56.000000, Y=-66.000000
SAR 10g (W/Kg): 0.114329
SAR 1g (W/Kg): 0.178942
Power drift (%): 0.53
3D screen shot

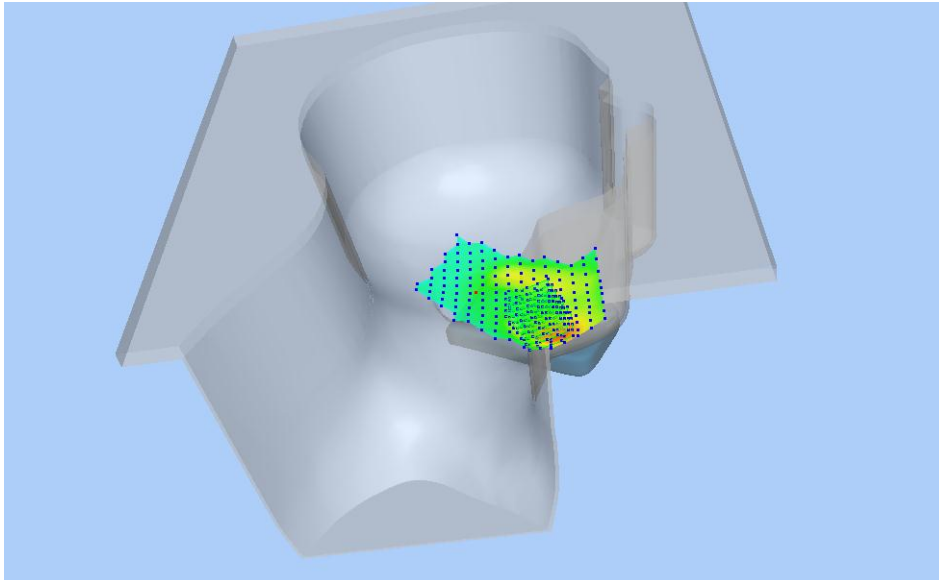

Z Axis Scan

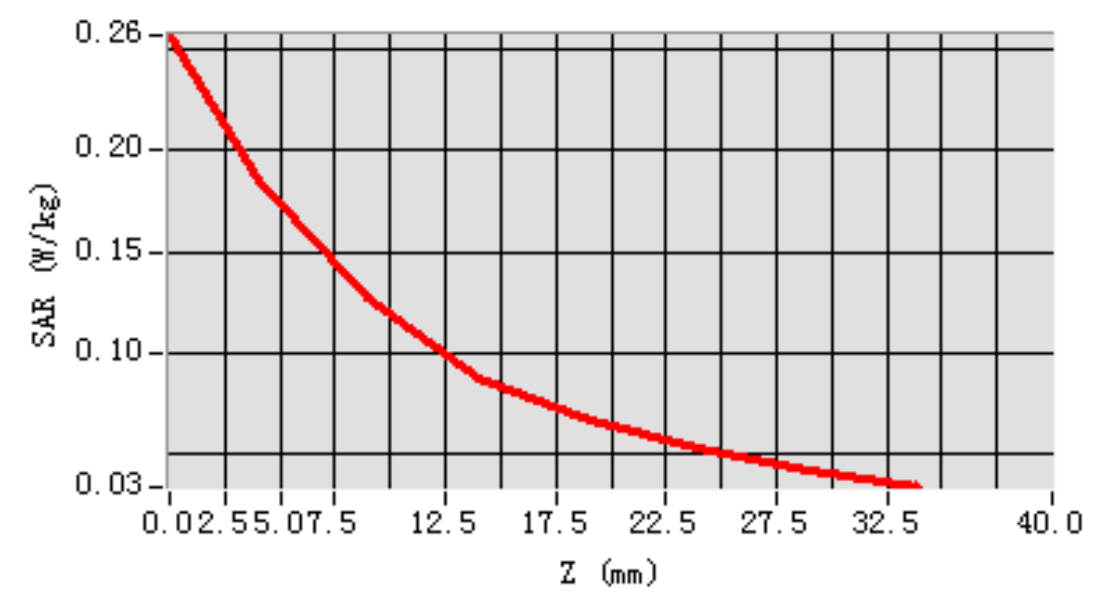

MEAS. 12 Body Plane with Bottom Edge 10mm on Low Channel in LTE Band 2 mode with 1RB

Test Date:	21/3/2017
Measurement duration:	12 minutes 0 seconds
Signal:	LTE, f=1860.0 MHz, Duty Cycle: 1:1.0
Liquid Parameters:	Permittivity: 53.84; Conductivity: 1.54 S/m
Test condition:	Ambient Temperature: 22.3°C, Liquid Temperature: 21.1°C
Probe:	SN 34/15 SSE2 EPGO265, ConvF: 2.42
Area Scan:	sam_direct_droit2_surf10mm.txt, h= 5.00 mm
Zoom Scan:	5x5x7,dx=8mm, dy=8mm, dz=5mm,Complete
Maximum location:	X=0.000000, Y=-2.000000
SAR 10g (W/Kg):	0.458881
SAR 1g (W/Kg):	0.838606
Power drift (%):	-1.21
3D screen shot	

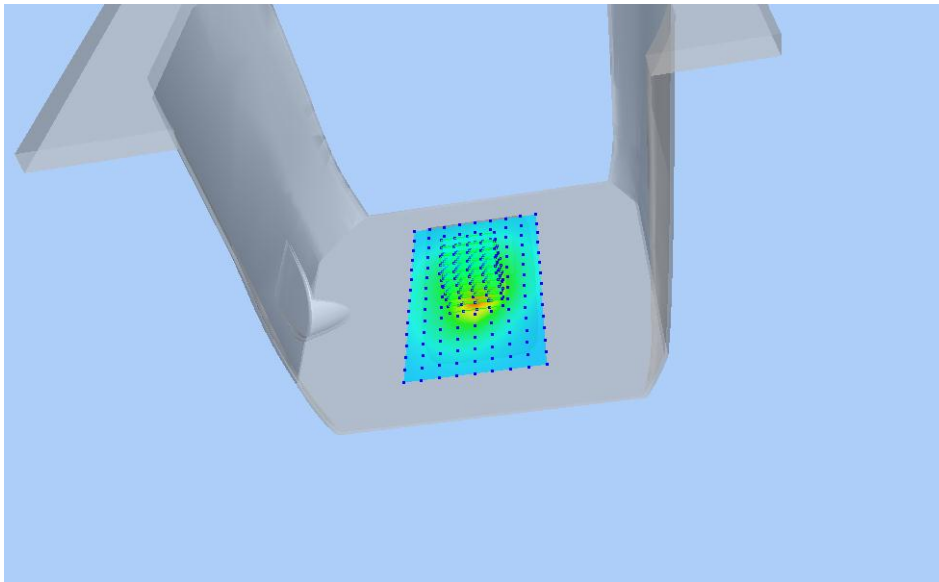

Z Axis Scan

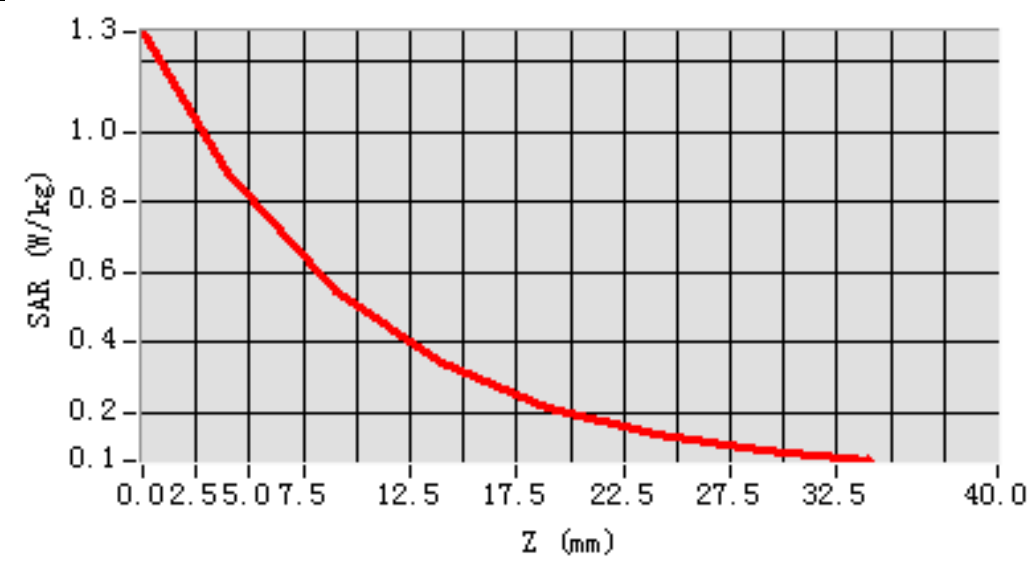

MEAS. 13 Left Head with Cheek on Middle Channel in LTE Band 4 mode with

1RB

Test Date: 29/3/2017
Measurement duration: 11 minutes 35 seconds
Signal: LTE, f=1732.5 MHz, Duty Cycle: 1:1.0
Liquid Parameters: Permittivity: 41.42; Conductivity: 1.35 S/m
Test condition: Ambient Temperature: 22.4°C, Liquid Temperature: 21.1°C
Probe: SN 34/15 SSE2 EPGO265, ConvF: 2.04
Area Scan: sam_direct_droit2_surf10mm.txt, h= 5.00 mm
Zoom Scan: 5x5x7,dx=8mm, dy=8mm, dz=5mm,Complete
Maximum location: X=-46.000000, Y=-56.000000
SAR 10g (W/Kg): 0.149416
SAR 1g (W/Kg): 0.234860
Power drift (%): -4.17
3D screen shot

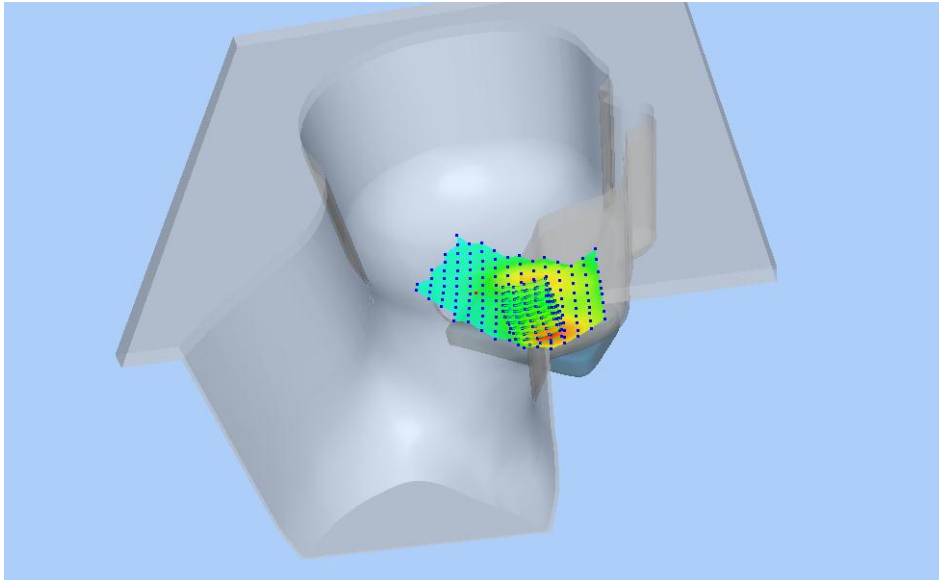

Z Axis Scan

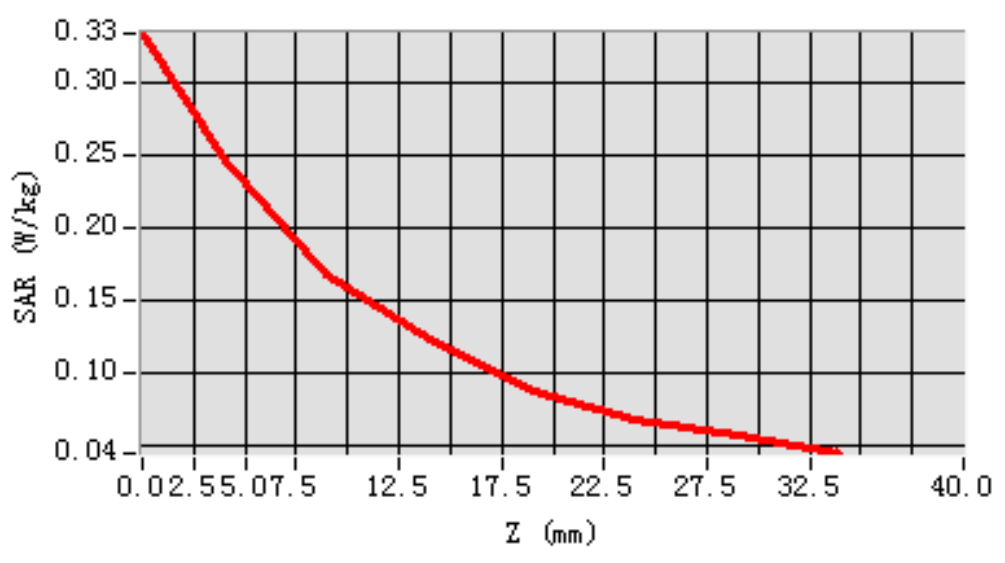

MEAS. 14 Body Plane with Back Side 10mm on Low Channel in LTE Band 4

mode with 1RB

Test Date:	27/3/2017
Measurement duration:	13 minutes 18 seconds
Signal:	LTE, f=1720.0 MHz, Duty Cycle: 1:1.0
Liquid Parameters:	Permittivity: 53.23; Conductivity: 1.47 S/m
Test condition:	Ambient Temperature: 22.5°C, Liquid Temperature: 21.2°C
Probe:	SN 34/15 SSE2 EPGO265, ConvF: 2.08
Area Scan:	sam_direct_droit2_surf10mm.txt, h= 5.00 mm
Zoom Scan:	5x5x7,dx=8mm, dy=8mm, dz=5mm,Complete
Maximum location:	X=10.000000, Y=-12.000000
SAR 10g (W/Kg):	0.528002
SAR 1g (W/Kg):	0.973659
Power drift (%):	-0.41
3D screen shot	

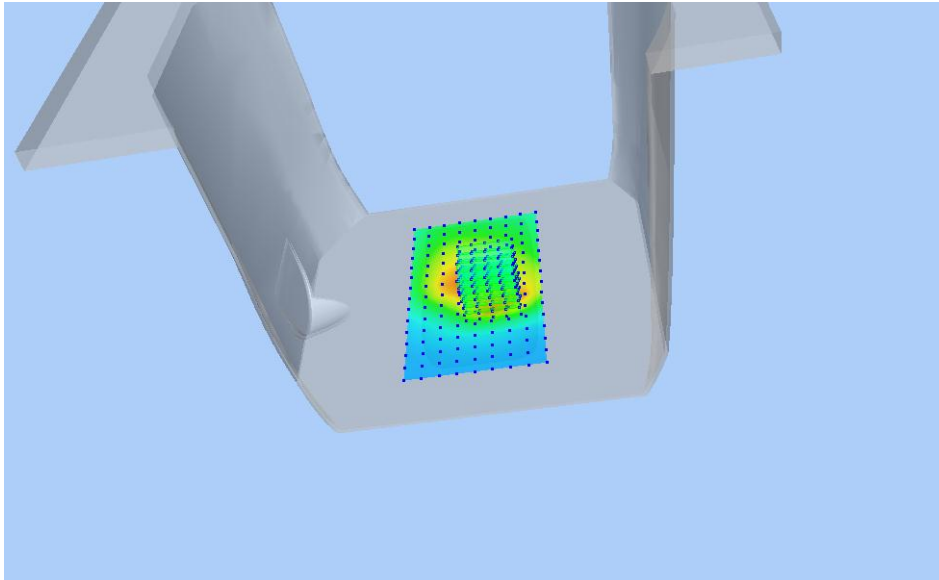

Z Axis Scan

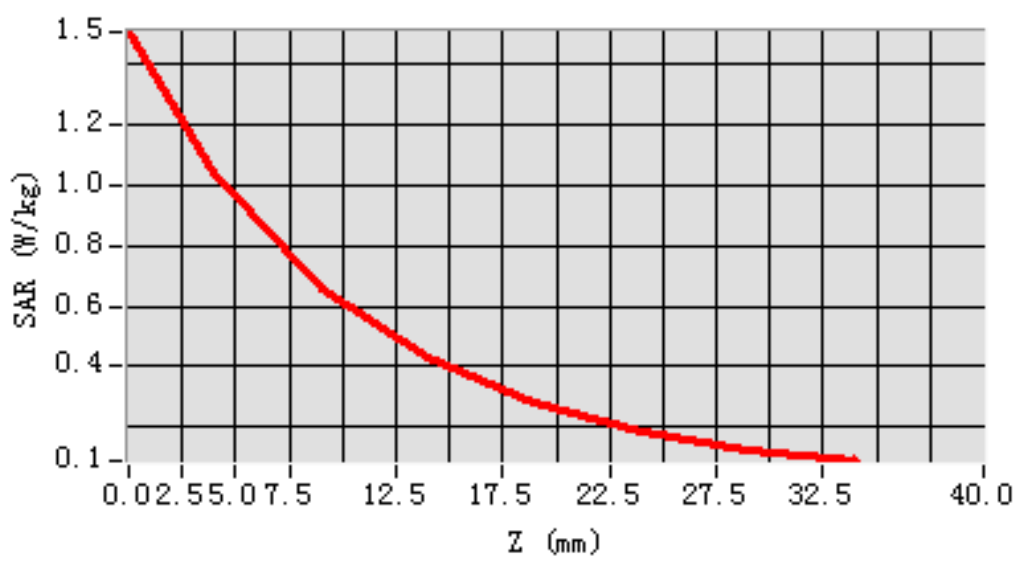

MEAS. 15 Left Head with Cheek on High Channel in LTE Band 7 mode with

1RB

Test Date: 18/3/2017
Measurement duration: 16 minutes 19 seconds
Signal: LTE, f=2560.0 MHz, Duty Cycle: 1:1.0
Liquid Parameters: Permittivity: 38.69; Conductivity: 1.96 S/m
Test condition: Ambient Temperature: 22.3°C, Liquid Temperature: 21.2°C
Probe: SN 34/15 SSE2 EPGO265, ConvF: 2.36
Area Scan: sam_direct_droit2_surf10mm.txt, h= 5.00 mm
Zoom Scan: 7x7x7,dx=5mm, dy=5mm, dz=5mm,Complete
Maximum location: X=-46.000000, Y=-56.000000
SAR 10g (W/Kg): 0.170199
SAR 1g (W/Kg): 0.301585
Power drift (%): -3.79
3D screen shot

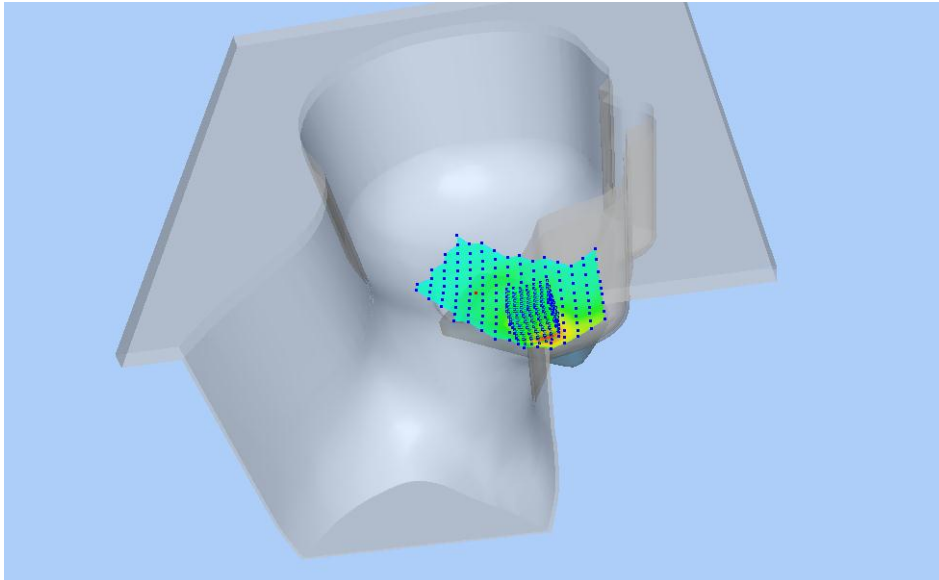

Z Axis Scan

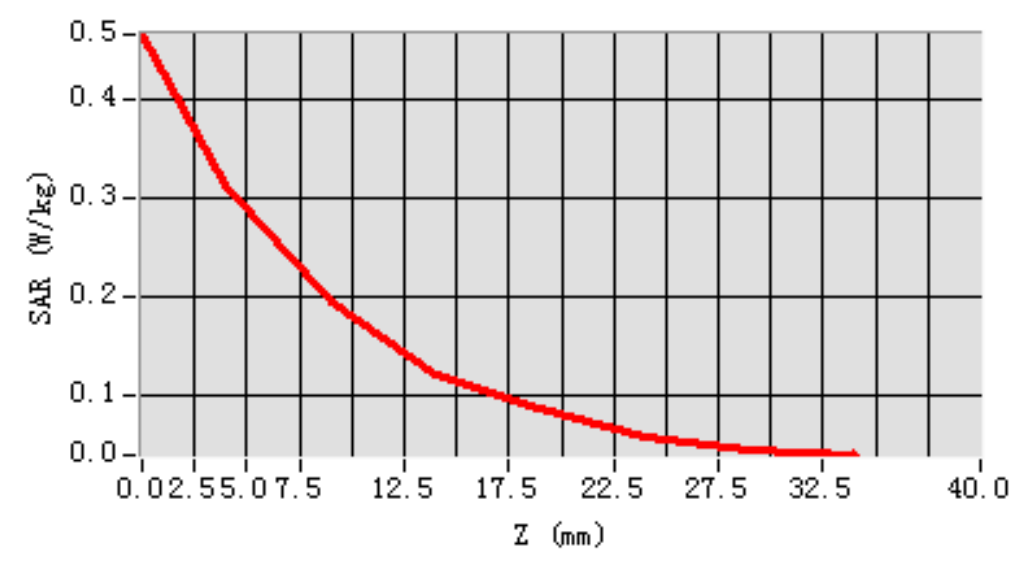

MEAS. 16 Body Plane with Bottom Edge 10mm on High Channel in LTE Band 7

mode with 1RB

Test Date:	19/3/2017
Measurement duration:	16 minutes 43 seconds
Signal:	LTE, f=2560.0 MHz, Duty Cycle: 1:1.0
Liquid Parameters:	Permittivity: 51.93; Conductivity: 2.09 S/m
Test condition:	Ambient Temperature: 22.8°C, Liquid Temperature: 21.4°C
Probe:	SN 34/15 SSE2 EPGO265, ConvF: 2.43
Area Scan:	sam_direct_droit2_surf10mm.txt, h= 5.00 mm
Zoom Scan:	7x7x7,dx=5mm, dy=5mm, dz=5mm,Complete
Maximum location:	X=0.000000, Y=8.000000
SAR 10g (W/Kg):	0.436552
SAR 1g (W/Kg):	0.872380
Power drift (%):	1.52
3D screen shot	

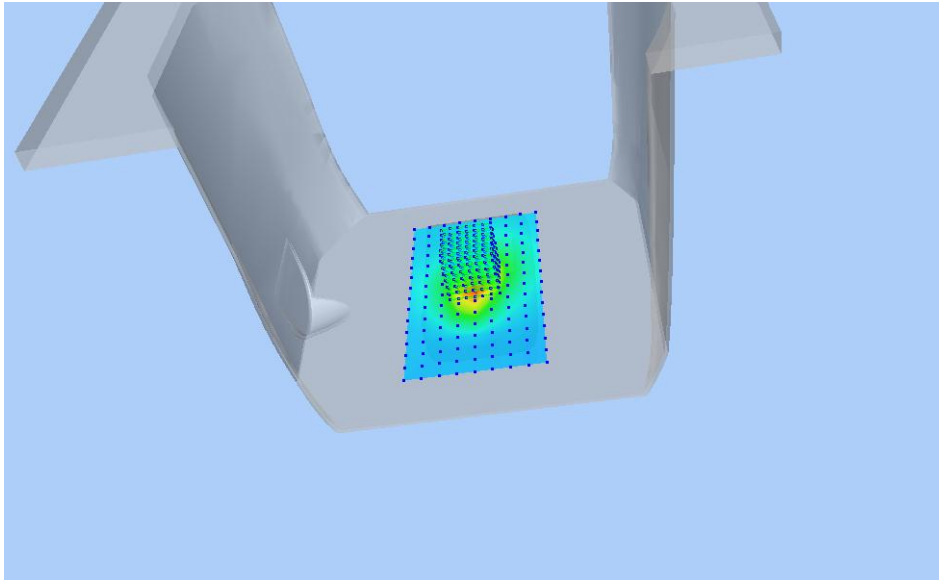

Z Axis Scan

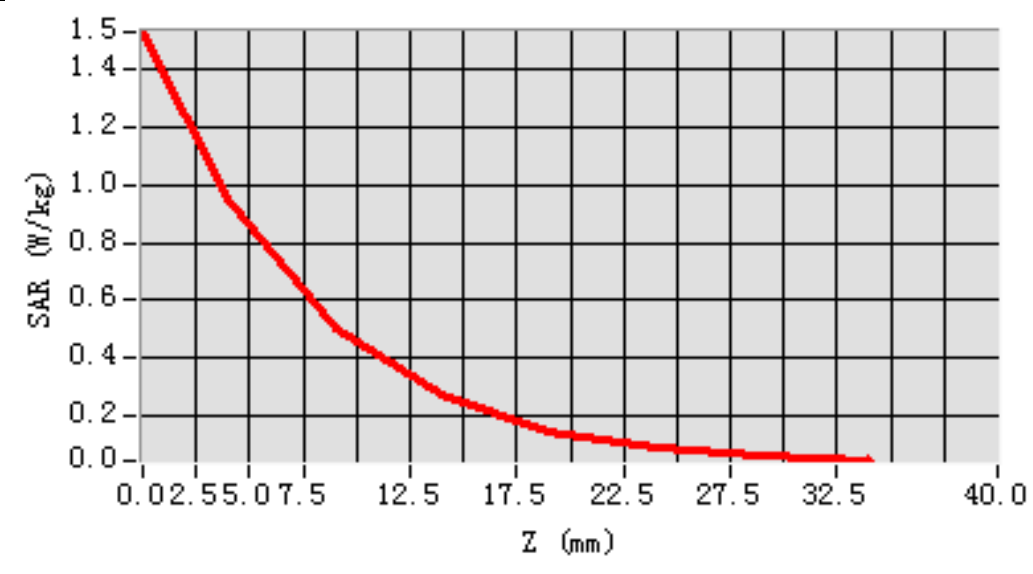

MEAS. 17 Right Head with Cheek on Middle Channel in IEEE 802.b mode

Test Date: 16/4/2017
Measurement duration: 13 minutes 56 seconds
Signal: WLAN, f=2437.0 MHz, Duty Cycle: 1:1.0
Liquid Parameters: Permittivity: 39.44; Conductivity: 1.82 S/m
Test condition: Ambient Temperature: 22.4°C, Liquid Temperature: 21.6°C
Probe: SN 34/15 SSE2 EPGO265, ConvF: 2.47
Area Scan: sam_direct_droit2_surf10mm.txt, h= 5.00 mm
Zoom Scan: 7x7x7,dx=5mm, dy=5mm, dz=5mm,Complete
Maximum location: X=-16.000000, Y=24.000000
SAR 10g (W/Kg): 0.276999
SAR 1g (W/Kg): 0.537168
Power drift (%): 1.79
3D screen shot

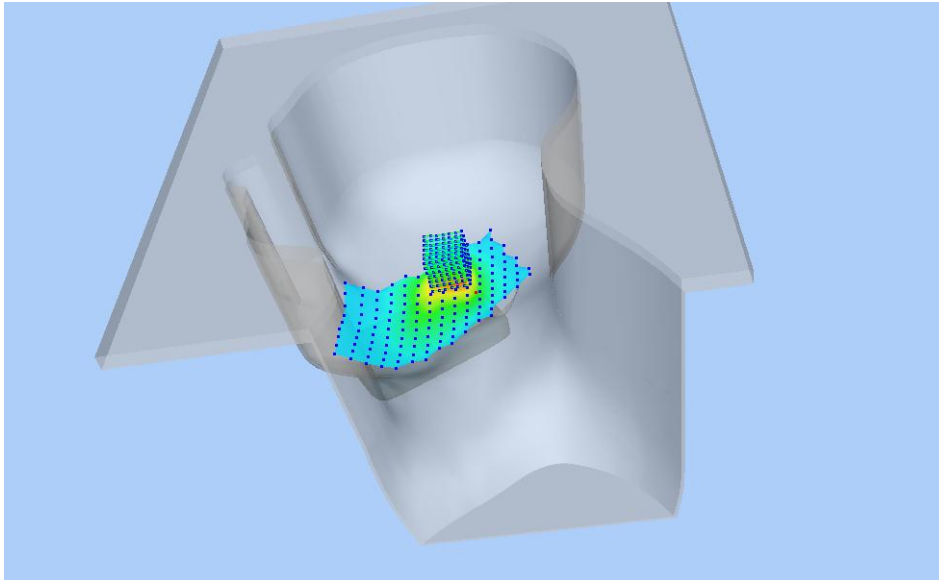

Z Axis Scan

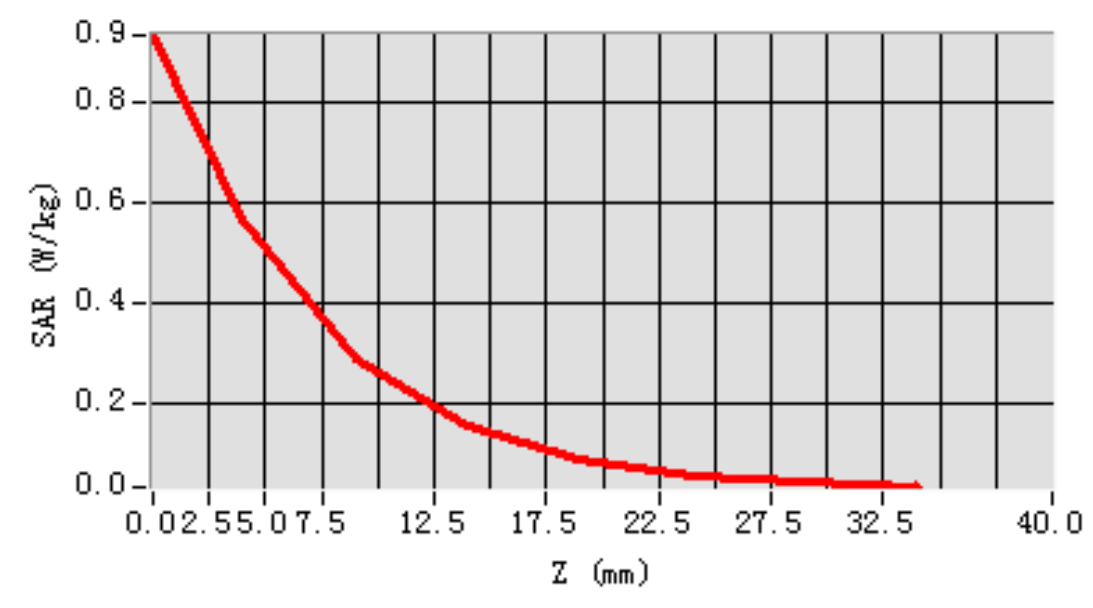

MEAS. 18 Body Plane with Back Side 10 mm on Middle Channel in IEEE 802.b

mode

Test Date:	18/4/2017
Measurement duration:	18 minutes 48 seconds
Signal:	WLAN, f=2437.0 MHz, Duty Cycle: 1:1.0
Liquid Parameters:	Permittivity: 52.34; Conductivity: 1.98 S/m
Test condition:	Ambient Temperature: 22.6°C, Liquid Temperature: 21.4°C
Probe:	SN 34/15 SSE2 EPGO265, ConvF: 2.55
Area Scan:	sam_direct_droit2_surf10mm.txt, h= 5.00 mm
Zoom Scan:	7x7x7,dx=5mm, dy=5mm, dz=5mm,Complete
Maximum location:	X=10.000000, Y=-12.000000
SAR 10g (W/Kg):	0.106142
SAR 1g (W/Kg):	0.192233
Power drift (%):	-3.87
3D screen shot	

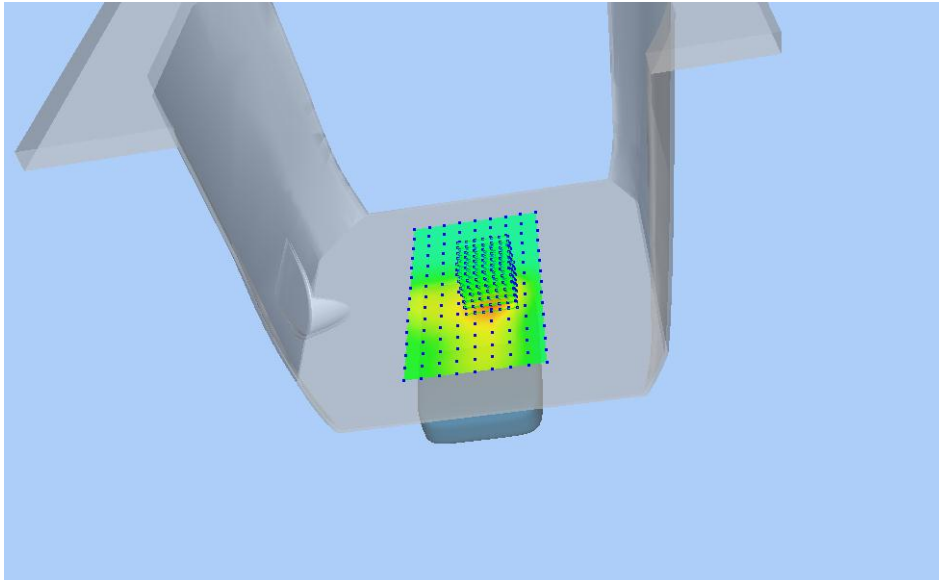

Z Axis Scan

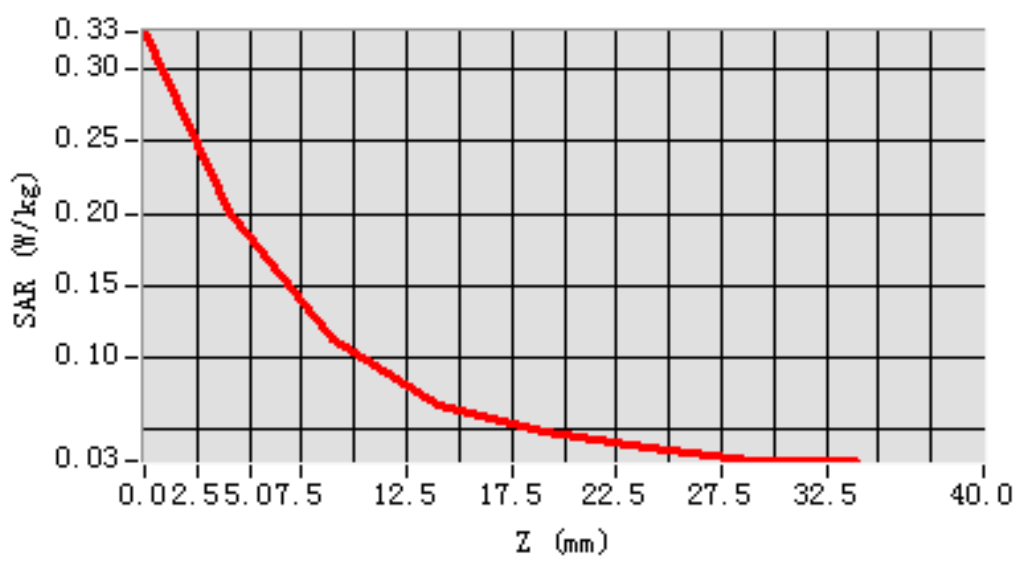

MEAS. 19 Right Head with Cheek on Channel 36 in IEEE 802.a mode

Test Date: 19/4/2017
Measurement duration: 19 minutes 51 seconds
Signal: WLAN, f=5180.0 MHz, Duty Cycle: 1:1.04
Liquid Parameters: Permittivity: 36.65; Conductivity: 4.76 S/m
Test condition: Ambient Temperature: 22.3°C, Liquid Temperature: 21.1°C
Probe: SN 34/15 SSE2 EPGO265, ConvF: 1.81
Area Scan: sam_direct_droit2_surf10mm.txt, h= 5.00 mm
Zoom Scan: 7x7x12,dx=4mm, dy=4mm, dz=2mm,Complete
Maximum location: X=-6.000000, Y=24.000000
SAR 10g (W/Kg): 0.251504
SAR 1g (W/Kg): 0.760632
Power drift (%): -3.06
3D screen shot

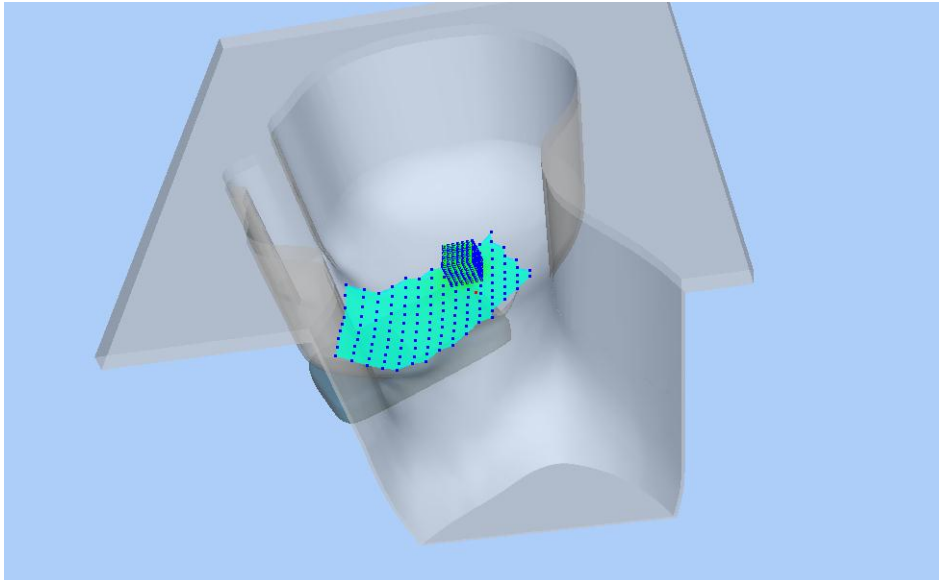

Z Axis Scan

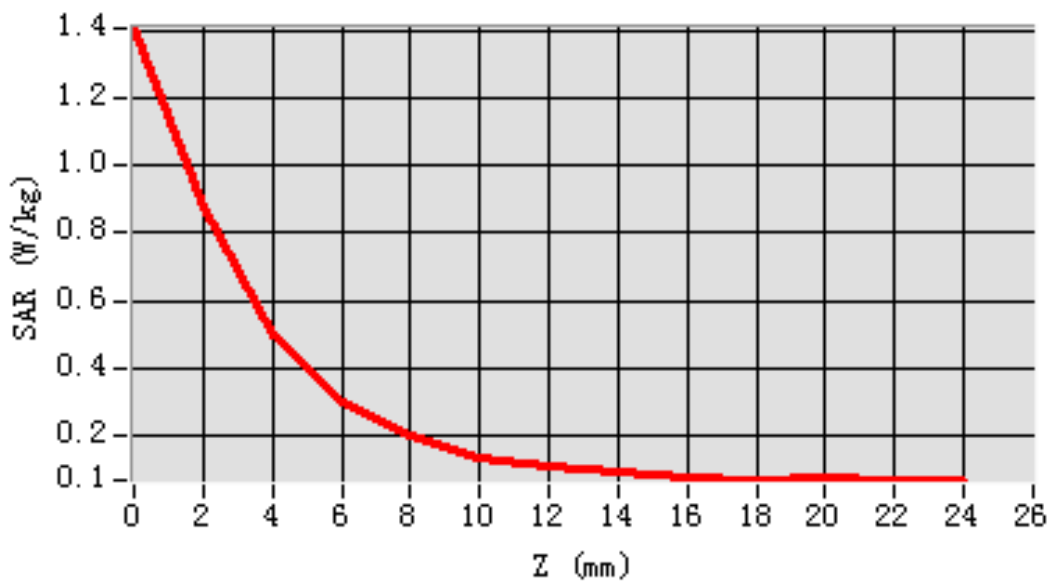

MEAS. 20 Right Head with Tilt on Channel 157 in IEEE 802.a mode

Test Date: 20/4/2017
Measurement duration: 19 minutes 44 seconds
Signal: WLAN, f=5785.0 MHz, Duty Cycle: 1:1.04
Liquid Parameters: Permittivity: 34.45; Conductivity: 5.47 S/m
Test condition: Ambient Temperature: 22.4°C, Liquid Temperature: 21.2°C
Probe: SN 34/15 SSE2 EPGO265, ConvF: 1.88
Area Scan: sam_direct_droit2_surf10mm.txt, h= 5.00 mm
Zoom Scan: 7x7x12,dx=4mm, dy=4mm, dz=2mm,Complete
Maximum location: X=-6.000000, Y=24.000000
SAR 10g (W/Kg): 0.184465
SAR 1g (W/Kg): 0.485452
Power drift (%): -3.71
3D screen shot

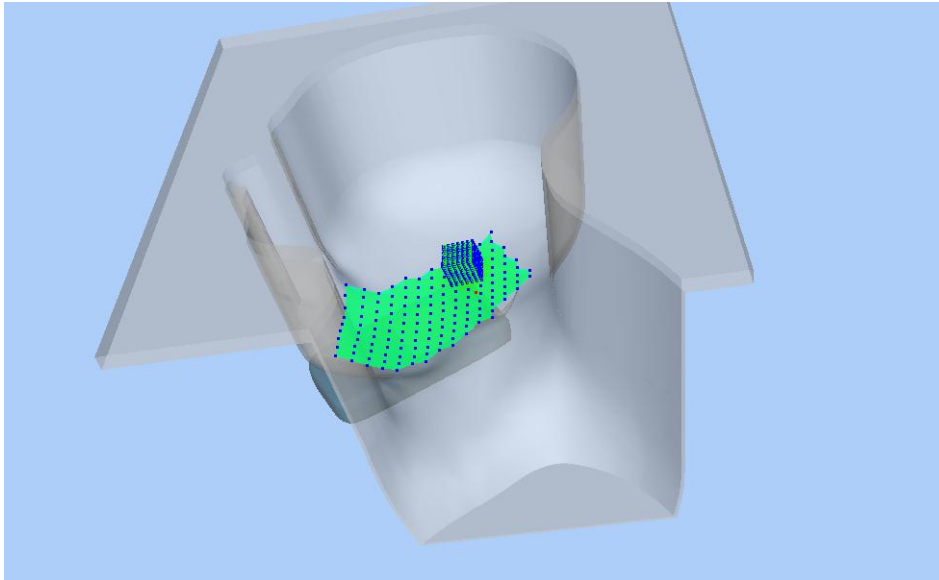

Z Axis Scan

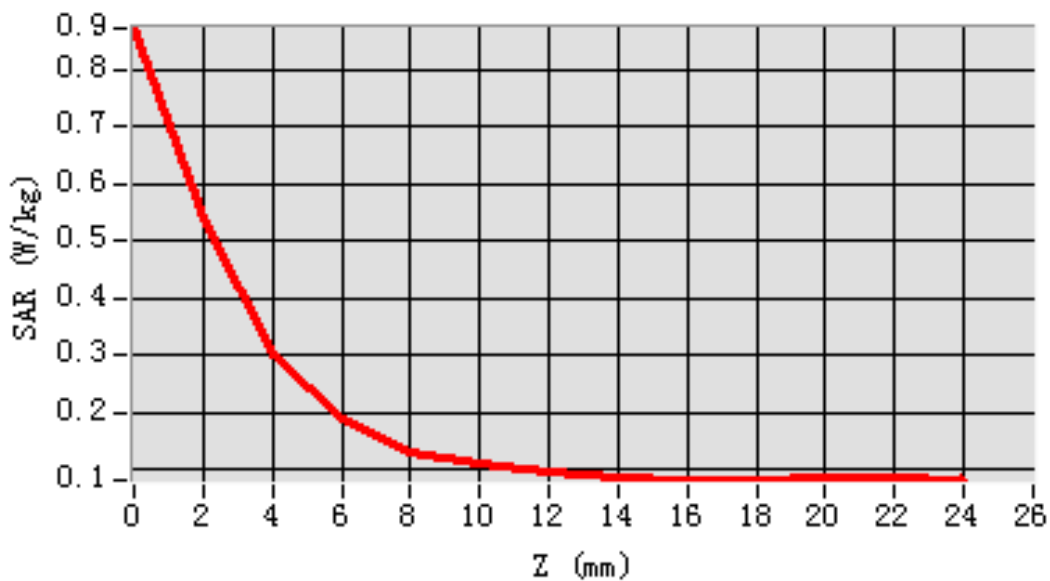

MEAS. 21 Body Plane with Back Side 10 mm on Channel 36 in IEEE 802.a

mode

Test Date: 21/4/2017
Measurement duration: 25 minutes 46 seconds
Signal: WLAN, f=5180.0 MHz, Duty Cycle: 1:1.04
Liquid Parameters: Permittivity: 49.35; Conductivity: 5.23 S/m
Test condition: Ambient Temperature: 22.1°C, Liquid Temperature: 20.9°C
Probe: SN 34/15 SSE2 EPGO265, ConvF: 1.85
Area Scan: sam_direct_droit2_surf10mm.txt, h= 5.00 mm
Zoom Scan: 7x7x12,dx=4mm, dy=4mm, dz=2mm,Complete
Maximum location: X=0.000000, Y=-28.000000
SAR 10g (W/Kg): 0.224089
SAR 1g (W/Kg): 0.462405
Power drift (%): -3.46
3D screen shot

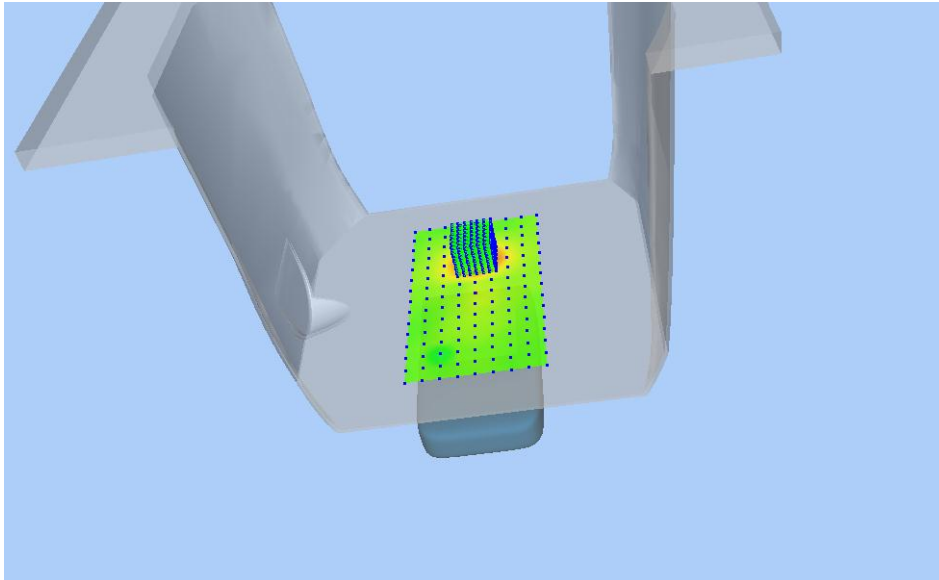

Z Axis Scan

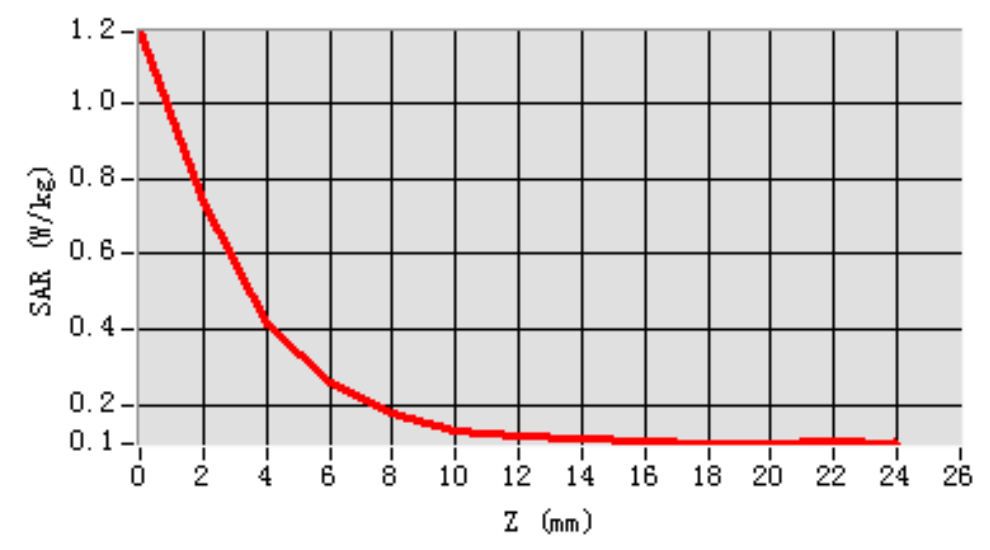

MEAS. 22 Body Plane with Back Side 10 mm on Channel 157 in IEEE 802.a

mode

Test Date:	24/4/2017
Measurement duration:	26 minutes 15 seconds
Signal:	WLAN, f=5785.0 MHz, Duty Cycle: 1:1.04
Liquid Parameters:	Permittivity: 48.32; Conductivity: 5.95 S/m
Test condition:	Ambient Temperature: 22.5°C, Liquid Temperature: 21.3°C
Probe:	SN 34/15 SSE2 EPGO265, ConvF: 1.93
Area Scan:	sam_direct_droit2_surf10mm.txt, h= 5.00 mm
Zoom Scan:	7x7x12,dx=4mm, dy=4mm, dz=2mm,Complete
Maximum location:	X=-20.000000, Y=-22.000000
SAR 10g (W/Kg):	0.179234
SAR 1g (W/Kg):	0.346322
Power drift (%):	-3.38
3D screen shot	

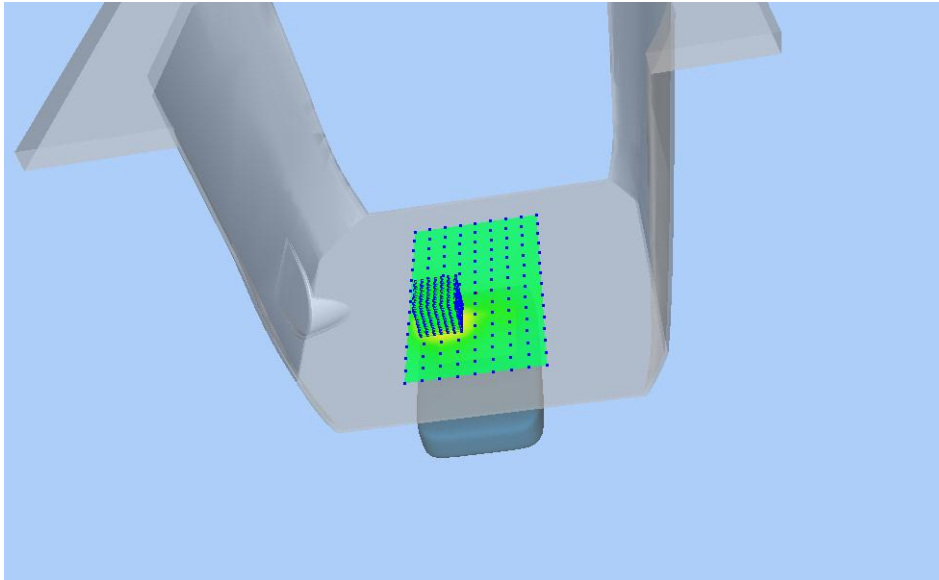

Z Axis Scan

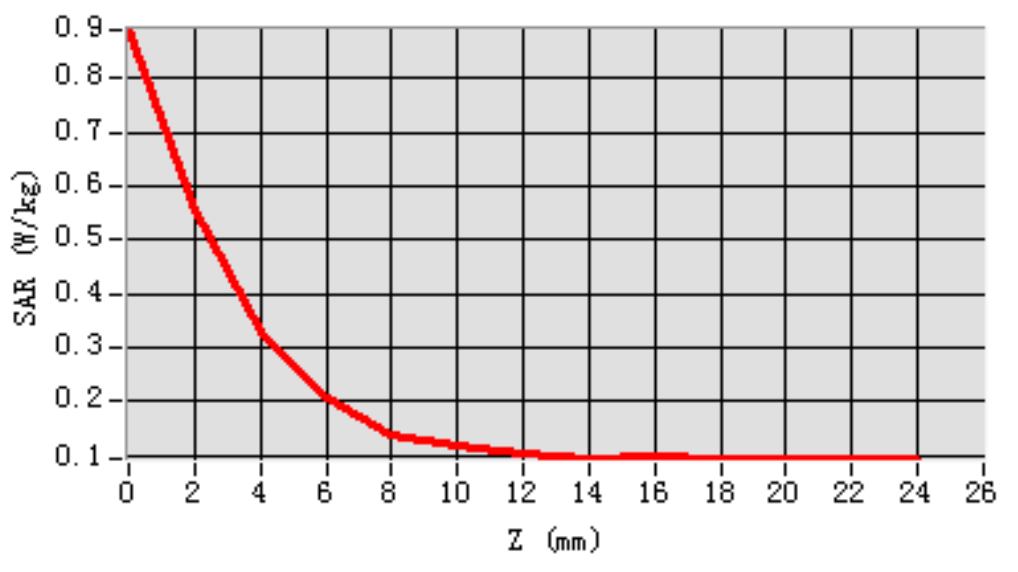

ANNEX D EUT EXTERNAL PHOTOS

Please refer the document "BL-SZ1730238-AW.pdf".

ANNEX E SAR TEST SETUP PHOTOS

Please refer the document "BL-SZ1730238-AS.pdf".

ANNEX F CALIBRATION REPORT

Please refer the document "CALIBRATION REPORT.pdf".

--END OF REPORT--