

FCC Radio Test Report

FCC ID: TE7HC2220G1UV1

This report concerns: **Original Grant**

Project No. : 1904C065
Equipment : AC2200 Home Wi-Fi System
Test Model : HC2220-G1u
Series Model : N/A
Applicant : TP-Link Technologies Co., Ltd.
Address : Building 24(floors1,3,4,5) and 28(floors1-4) Central
Science and Technology Park, Shennan Rd,
Nanshan, Shenzhen, China

Date of Receipt : Apr. 16, 2019
Date of Test : Apr. 17, 2019~Jun. 18, 2019
Issued Date : Jul. 16, 2019
Tested by : BTL Inc.

Testing Engineer : 
(Chay Cai)

Technical Manager : 
(Steven Lu)

Authorized Signatory : 
(Ethan Ma)

B T L I N C .

No.3, Jinshagang 1st Road, Shixia, Dalang Town, Dongguan,
Guangdong, China.

TEL: +86-769-8318-3000 FAX: +86-769-8319-6000



Certificate #5123.02

Declaration

BTL represents to the client that testing is done in accordance with standard procedures as applicable and that test instruments used has been calibrated with standards traceable to international standard(s) and/or national standard(s).

BTL's reports apply only to the specific samples tested under conditions. It is manufacture's responsibility to ensure that additional production units of this model are manufactured with the identical electrical and mechanical components. **BTL** shall have no liability for any declarations, inferences or generalizations drawn by the client or others from **BTL** issued reports.

The report must not be used by the client to claim product certification, approval, or endorsement by NVLAP, NIST, A2LA, or any agency of the U.S. Government.

This report is the confidential property of the client. As a mutual protection to the clients, the public and ourselves, the test report shall not be reproduced, except in full, without our written approval.

BTL's laboratory quality assurance procedures are in compliance with the **ISO/IEC 17025** requirements, and accredited by the conformity assessment authorities listed in this test report.

BTL is not responsible for the sampling stage, so the results only apply to the sample as received.

The information, data and test plan are provided by manufacturer which may affect the validity of results, so it is manufacturer's responsibility to ensure that the apparatus meets the essential requirements of applied standards and in all the possible configurations as representative of its intended use.

Limitation

For the use of the authority's logo is limited unless the Test Standard(s)/Scope(s)/Item(s) mentioned in this test report is (are) included in the conformity assessment authorities acceptance respective.

Please note that the measurement uncertainty is provided for informational purpose only and are not use in determining the Pass/Fail results.

Table of Contents	Page
REPORT ISSUED HISTORY	6
1 . GENERAL SUMMARY	7
2 . SUMMARY OF TEST RESULTS	8
2.1 TEST FACILITY	9
2.2 MEASUREMENT UNCERTAINTY	9
3 . GENERAL INFORMATION	10
3.1 GENERAL DESCRIPTION OF EUT	10
3.2 DESCRIPTION OF TEST MODES	12
3.3 PARAMETERS OF TEST SOFTWARE	15
3.4 DUTY CYCLE	16
3.5 BLOCK DIAGRAM SHOWING THE CONFIGURATION OF SYSTEM TESTED	17
3.6 SUPPORT UNITS	17
4 . AC POWER LINE CONDUCTED EMISSIONS TEST	18
4.1 LIMIT	18
4.2 TEST PROCEDURE	18
4.3 DEVIATION FROM TEST STANDARD	18
4.4 TEST SETUP	19
4.5 EUT OPERATION CONDITIONS	19
4.6 EUT TEST CONDITIONS	19
4.7 TEST RESULTS	19
5 . RADIATED EMISSIONS TEST	20
5.1 LIMIT	20
5.2 TEST PROCEDURE	21
5.3 DEVIATION FROM TEST STANDARD	21
5.4 TEST SETUP	22
5.5 EUT OPERATION CONDITIONS	23
5.6 EUT TEST CONDITIONS	23
5.7 TEST RESULTS - 9 KHZ TO 30 MHZ	23
5.8 TEST RESULTS - 30 MHZ TO 1000 MHZ	23
5.9 TEST RESULTS - ABOVE 1000 MHZ	23
6 . BANDWIDTH TEST	24
6.1 LIMIT	24

Table of Contents	Page
6.2 TEST PROCEDURE	24
6.3 DEVIATION FROM STANDARD	24
6.4 TEST SETUP	24
6.5 EUT OPERATION CONDITIONS	24
6.6 EUT TEST CONDITIONS	24
6.7 TEST RESULTS	24
7 . MAXIMUM AVERAGE OUTPUT POWER TEST	25
7.1 LIMIT	25
7.2 TEST PROCEDURE	25
7.3 DEVIATION FROM STANDARD	25
7.4 TEST SETUP	25
7.5 EUT OPERATION CONDITIONS	25
7.6 EUT TEST CONDITIONS	25
7.7 TEST RESULTS	25
8 . CONDUCTED SPURIOUS EMISSIONS	26
8.1 LIMIT	26
8.2 TEST PROCEDURE	26
8.3 DEVIATION FROM STANDARD	26
8.4 TEST SETUP	26
8.5 EUT OPERATION CONDITIONS	26
8.6 EUT TEST CONDITIONS	26
8.7 TEST RESULTS	26
9 . POWER SPECTRAL DENSITY TEST	27
9.1 LIMIT	27
9.2 TEST PROCEDURE	27
9.3 DEVIATION FROM STANDARD	27
9.4 TEST SETUP	27
9.5 EUT OPERATION CONDITIONS	27
9.6 EUT TEST CONDITIONS	27
9.7 TEST RESULTS	27
10 . MEASUREMENT INSTRUMENTS LIST	28
11 . EUT TEST PHOTO	30
APPENDIX A - AC POWER LINE CONDUCTED EMISSIONS	34

Table of Contents**Page**

APPENDIX B - RADIATED EMISSION - 9 KHZ TO 30 MHZ	37
APPENDIX C - RADIATED EMISSION - 30 MHZ TO 1000 MHZ	42
APPENDIX D - RADIATED EMISSION- ABOVE 1000 MHZ	45
APPENDIX E - BANDWIDTH	167
APPENDIX F - MAXIMUM AVERAGE OUTPUT POWER	174
APPENDIX G - CONDUCTED SPURIOUS EMISSIONS	181
APPENDIX H - POWER SPECTRAL DENSITY	194

REPORT ISSUED HISTORY

Report Version	Description	Issued Date
R00	Original Issue.	Jul. 16, 2019

1. GENERAL SUMMARY

Equipment : AC2200 Home Wi-Fi System
Brand Name : tp-link
Test Model : HC2220-G1u
Series Model : N/A
Applicant : TP-Link Technologies Co., Ltd.
Manufacturer : TP-Link Technologies Co., Ltd.
Address : Building 24(floors1,3,4,5) and 28(floors1-4) Central Science and Technology Park, Shennan Rd, Nanshan, Shenzhen, China
Factory : TP-Link Technologies Co., Ltd.
Address : Building 24(floors1,3,4,5) and 28(floors1-4) Central Science and Technology Park, Shennan Rd, Nanshan, Shenzhen, China
Date of Test : Apr. 17, 2019~Jun. 18, 2019
Test Sample : Engineering Sample No.: D190403890 for conducted, D190403887 for radiated.
Standard(s) : FCC Part15, Subpart C (15.247)
ANSI C63.10-2013
FCC KDB 558074 D01 DTS Meas Guidance v05r02
FCC KDB 662911 D01 Multiple Transmitter Output v02r01

The above equipment has been tested and found compliance with the requirement of the relative standards by BTL Inc.

The test data, data evaluation, and equipment configuration contained in our test report (Ref No. BTL-FCCP-1-1904C065) were obtained utilizing the test procedures, test instruments, test sites that has been accredited by the Authority of A2LA according to the ISO/IEC 17025 quality assessment standard and technical standard(s).

Test results included in this report are only for the WLAN 2.4 GHz part.

2. SUMMARY OF TEST RESULTS

Test procedures according to the technical standard(s):

Applied Standard(s): FCC Part15, Subpart C (15.247)				
Standard(s) Section	Test Item	Test Result	Judgment	Remark
15.207	AC Power Line Conducted Emissions	APPENDIX A	PASS	-----
15.247(d) 15.205(a) 15.209(a)	Radiated Emissions	APPENDIX B APPENDIX C APPENDIX D	PASS	-----
15.247(a)(2)	Bandwidth	APPENDIX E	PASS	-----
15.247(b)(3)	Maximum Average Output Power	APPENDIX F	PASS	-----
15.247(d)	Conducted Spurious Emissions	APPENDIX G	PASS	-----
15.247(e)	Power Spectral Density	APPENDIX H	PASS	-----
15.203	Antenna Requirement	-----	PASS	Note (2)

Note:

- (1) "N/A" denotes test is not applicable in this test report.
- (2) The device what use a permanently attached antenna were considered sufficient to comply with the provisions of 15.203.

2.1 TEST FACILITY

The test facilities used to collect the test data in this report is at the location of No.3,Jinshagang 1st Road, Shixia, Dalang Town, Dongguan, Guangdong, China.

BTL's Test Firm Registration Number for FCC: 357015

BTL's Designation Number for FCC: CN1240

2.2 MEASUREMENT UNCERTAINTY

ISO/IEC 17025 requires that an estimate of the measurement uncertainties associated with the emissions test results be included in the report. The measurement uncertainties given below are based on a 95% confidence level (based on a coverage factor (k=2))

The BTL measurement uncertainty as below table:

A. AC power line conducted emissions test:

Test Site	Method	Measurement Frequency Range	U, (dB)
DG-C02	CISPR	150 kHz ~ 30 MHz	2.32

B. Radiated emissions test:

Test Site	Method	Measurement Frequency Range	Ant. H / V	U, (dB)
DG-CB03	CISPR	9 KHz~30 MHz	V	3.79
		9 KHz~30 MHz	H	3.57
		30 MHz~200 MHz	V	3.82
		30 MHz~200 MHz	H	3.78
		200 MHz~1,000 MHz	V	4.10
		200 MHz~1,000 MHz	H	4.06
		1 GHz~18 GHz	V	3.12
		1 GHz~18 GHz	H	3.68
		18 GHz~40 GHz	V	4.15
		18 GHz~40 GHz	H	4.14

Note: Unless specifically mentioned, the uncertainty of measurement has not been taken into account to declare the compliance or non-compliance to the specification.

3. GENERAL INFORMATION

3.1 GENERAL DESCRIPTION OF EUT

Equipment	AC2200 Home Wi-Fi System
Brand Name	tp-link
Test Model	HC2220-G1u
Series Model	N/A
Model Difference(s)	N/A
Power Source	DC voltage supplied from AC/DC adapter. Brand/ Model: AMC/ EUSA+24120-2000
Power Rating	I/P: 100-240V~ 50/60Hz 0.6A O/P: 12V --- 2A
Operation Frequency	2412 MHz ~ 2462 MHz
Modulation Type	IEEE 802.11b: DSSS IEEE 802.11g: OFDM IEEE 802.11n: OFDM
Bit Rate of Transmitter	IEEE 802.11b: 11/5.5/2/1 Mbps IEEE 802.11g: 54/48/36/24/18/12/9/6 Mbps IEEE 802.11n: up to 400 Mbps
Maximum Average Output Power Non-Beamforming	IEEE 802.11b: 25.73 dBm (0.3741 W) IEEE 802.11g: 25.95 dBm (0.3936 W) IEEE 802.11n (HT20): 26.07 dBm (0.4046 W) IEEE 802.11n (HT40): 21.17 dBm (0.1309 W)
Maximum Average Output Power Beamforming	IEEE 802.11n (HT20): 25.95 dBm (0.3936 W) IEEE 802.11n (HT40): 26.22 dBm (0.4188 W)

Note:

- For a more detailed features description, please refer to the manufacturer's specifications or the user's manual.
- Channel List:

CH01 - CH11 for 802.11b, 802.11g, 802.11n(20 MHz) CH03 - CH09 for 802.11n(40 MHz)							
Channel	Frequency (MHz)	Channel	Frequency (MHz)	Channel	Frequency (MHz)	Channel	Frequency (MHz)
01	2412	04	2427	07	2442	10	2457
02	2417	05	2432	08	2447	11	2462
03	2422	06	2437	09	2452		

3. Antenna Specification:

Ant.	Brand	Model Name	Antenna Type	Connector	Gain (dBi)
1	TP-LINK	N/A	PIFA	I-PEX	4.36
2	TP-LINK	N/A	PIFA	I-PEX	4.36

Note: This EUT supports CDD, and all antennas have the same gain,

(1) For Non Beamforming function, Directional gain= $G_{ANT} + \text{Array Gain}$,

For power spectral density measurements, Array Gain= $10\log(N_{ANT}/N_{SS})$ dB

Directional gain= $4.36 + 10\log(2/1) = 7.37$. So, the power density limit is $8 - 7.37 + 6 = 6.63$

(2) For Beamforming function, Beamforming gain: 3 dB, so Directional gain= $3 + 4.36 = 7.36$

Then, the output Power limit is $30 - 7.36 + 6 = 28.64$

the power density limit is $8 - 7.36 + 6 = 6.64$

4. Table for Antenna Configuration:

Non Beamforming

Operating Mode	2TX	
	TX Mode	
IEEE 802.11b		V (Ant. 1 + Ant. 2)
IEEE 802.11g		V (Ant. 1 + Ant. 2)
IEEE 802.11n (HT20)		V (Ant. 1 + Ant. 2)
IEEE 802.11n (HT40)		V (Ant. 1 + Ant. 2)

Beamforming

Operating Mode	2TX	
	TX Mode	
IEEE 802.11n (HT20)		V (Ant. 1 + Ant. 2)
IEEE 802.11n (HT40)		V (Ant. 1 + Ant. 2)

3.2 DESCRIPTION OF TEST MODES

The test system was pre-tested based on the consideration of all possible combinations of EUT operation mode.

Pretest Mode	Description
Mode 1	TX B Mode Channel 01/06/11
Mode 2	TX G Mode Channel 01/06/11
Mode 3	TX N-20 MHz Mode Channel 01/06/11
Mode 4	TX N-40 MHz Mode Channel 03/06/09
Mode 5	TX B Mode Channel 01/02/06/10/11
Mode 6	TX G Mode Channel 01/02/06/10/11
Mode 7	TX N-20 MHz Mode Channel 01/02/06/10/11
Mode 8	TX N-40 MHz Mode Channel 03/04/06/08/09
Mode 9	TX N40 Mode Channel 06 (Beamforming)

Following mode(s) as (were) found to be the worst case(s) and selected for the final test.

AC power line conducted emissions test	
Final Test Mode:	Description
Mode 9	TX N-40 MHz Mode Channel 06 (Beamforming)

Radiated emissions test - Below 1G	
Final Test Mode:	Description
Mode 9	TX N-40 MHz Mode Channel 06 (Beamforming)

Radiated emissions test – Above 1G for Non-Beamforming

Final Test Mode:	Description
Mode 1	TX B Mode Channel 01/06/11
Mode 2	TX G Mode Channel 01/06/11
Mode 3	TX N-20 MHz Mode Channel 01/06/11
Mode 4	TX N-40 MHz Mode Channel 03/06/09
Mode 5	TX B Mode Channel 01/02/06/10/11
Mode 6	TX G Mode Channel 01/02/06/10/11
Mode 7	TX N-20 MHz Mode Channel 01/02/06/10/11
Mode 8	TX N-40 MHz Mode Channel 03/04/06/08/09

Radiated emissions test – Above 1G for Beamforming

Final Test Mode:	Description
Mode 3	TX N-20 MHz Mode Channel 01/06/11
Mode 4	TX N-40 MHz Mode Channel 03/06/09
Mode 7	TX N-20 MHz Mode Channel 01/02/06/10/11
Mode 8	TX N-40 MHz Mode Channel 03/04/06/08/09

Conducted test for Non-Beamforming

Final Test Mode:	Description
Mode 1	TX B Mode Channel 01/06/11
Mode 2	TX G Mode Channel 01/06/11
Mode 3	TX N-20 MHz Mode Channel 01/06/11
Mode 4	TX N-40 MHz Mode Channel 03/06/09

Conducted test for Beamforming

Final Test Mode:	Description
Mode 3	TX N-20 MHz Mode Channel 01/06/11
Mode 4	TX N-40 MHz Mode Channel 03/06/09

NOTE:

- (1) The measurements are performed at the high, middle, low available channels.
- (2) All the bit rate of transmitter have been pretested and found the lowest rate is found to be the worst case and recorded.
- (3) For radiated emission below 1 GHz test, the IEEE 802.11n40 Channel 06 is found to be the worst case and recorded.
- (4) For radiated emission above 1 GHz test, 1GHz~26.5GHz have been pre-tested and in this report only recorded the worst case. The remaining spurious points are all below the limit value of 20dB.

3.3 PARAMETERS OF TEST SOFTWARE

Non-Beamforming

Test Software	QRCT v3.0-00233		
Frequency (MHz)	2412	2437	2462
IEEE 802.11b	21	22	22
IEEE 802.11g	17	22.5	18.5
IEEE 802.11n (HT20)	16.5	22.5	18.5
Frequency (MHz)	2422	2437	2452
IEEE 802.11n (HT40)	14	17	16

Beamforming

Test Software	QRCT v3.0-00233		
Frequency (MHz)	2412	2437	2462
IEEE 802.11n (HT20)	20.5	22.5	19
Frequency (MHz)	2422	2437	2452
IEEE 802.11n (HT40)	21	22.5	21

3.4 DUTY CYCLE

If duty cycle is $\geq 98\%$, duty factor is not required.
 If duty cycle is $< 98\%$, duty factor shall be considered.
 The output power = measured power + duty factor.

IEEE 802.11b

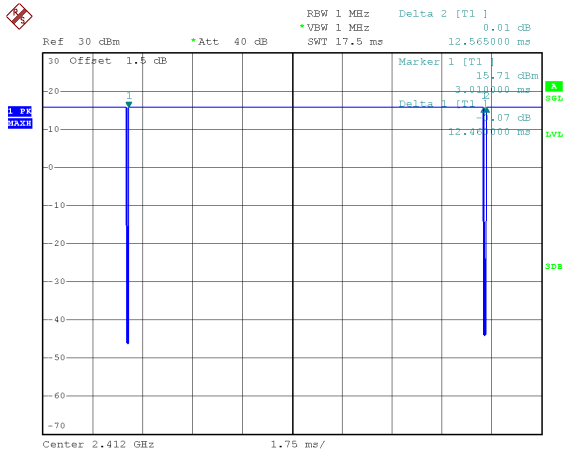

Date: 11.MAY.2019 17:26:05

Duty cycle = $12.460 \text{ ms} / 12.565 \text{ ms} = 99.16\%$
 Duty Factor = $10 \log(1/\text{Duty cycle}) = 0.00$

IEEE 802.11n (HT20)

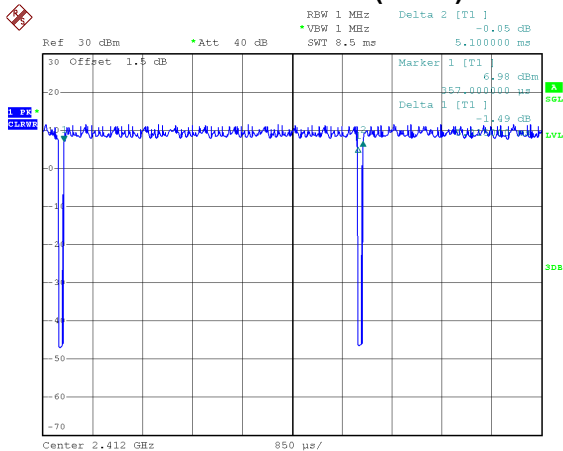

Date: 11.MAY.2019 17:28:38

Duty cycle = $5.015 \text{ ms} / 5.100 \text{ ms} = 98.33\%$
 Duty Factor = $10 \log(1/\text{Duty cycle}) = 0.00$

IEEE 802.11g

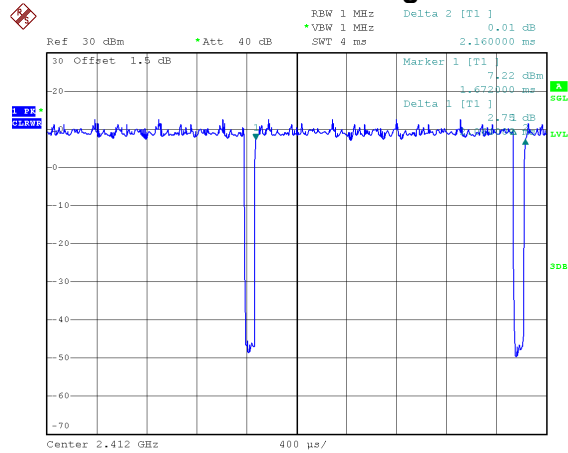

Date: 11.MAY.2019 17:27:31

Duty cycle = $2.064 \text{ ms} / 2.160 \text{ ms} = 95.56\%$
 Duty Factor = $10 \log(1/\text{Duty cycle}) = 0.20$

IEEE 802.11n (HT40)

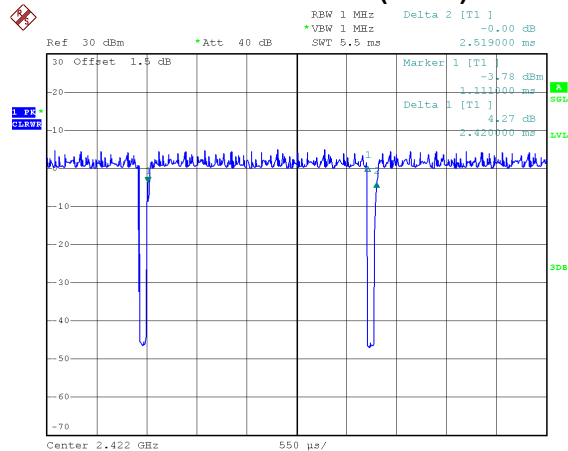

Date: 11.MAY.2019 17:29:14

Duty cycle = $2.420 \text{ ms} / 2.519 \text{ ms} = 96.07\%$
 Duty Factor = $10 \log(1/\text{Duty cycle}) = 0.17$

NOTE:

For IEEE 802.11g and IEEE 802.11n (HT20):
 For radiated emissions frequency above 1 GHz, the resolution bandwidth of test receiver/spectrum analyzer is 1 MHz and the video bandwidth is 1 kHz (Duty cycle $< 98\%$).

For IEEE 802.11n (HT40):
 For radiated emissions frequency above 1 GHz, the resolution bandwidth of test receiver/spectrum analyzer is 1 MHz and the video bandwidth is 2 kHz (Duty cycle $< 98\%$).

3.5 BLOCK DIAGRAM SHOWING THE CONFIGURATION OF SYSTEM TESTED

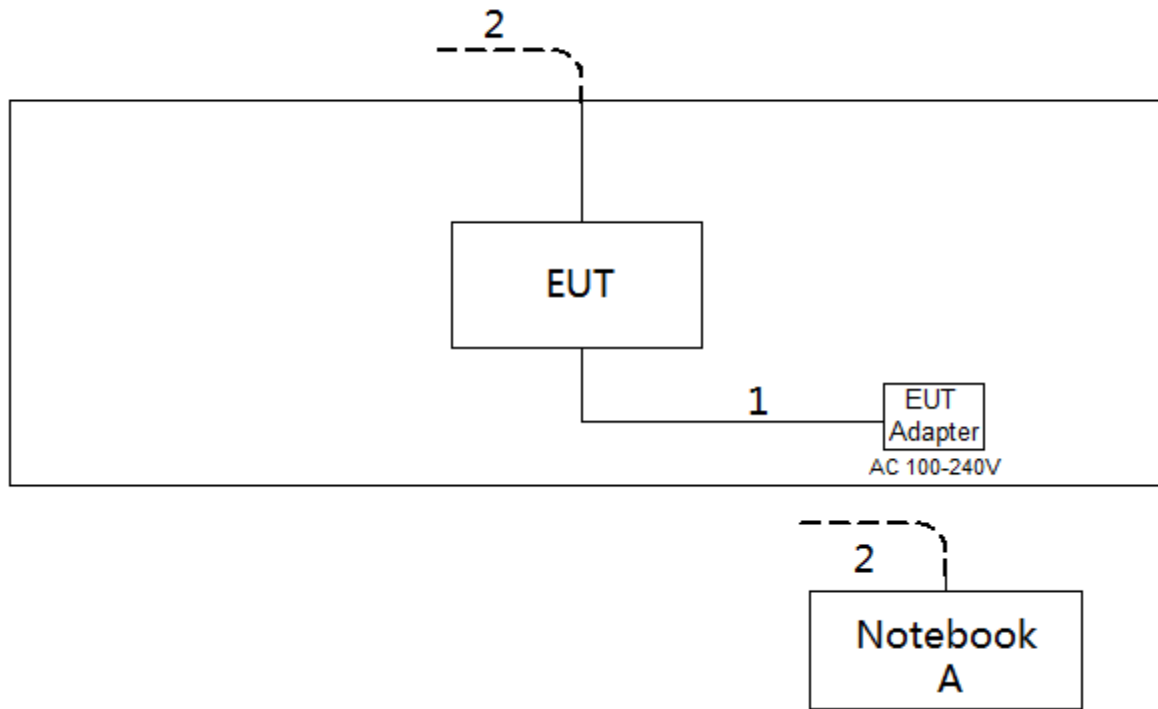

3.6 SUPPORT UNITS

Item	Equipment	Brand	Model No.	Series No.
A	Notebook	Dell	Inspiron 15-7559	N/A

Item	Cable Type	Shielded Type	Ferrite Core	Length
1	DC Cable	NO	NO	1.5m
2	RJ45 Cable	NO	NO	10m

4. AC POWER LINE CONDUCTED EMISSIONS TEST

4.1 LIMIT

Frequency of Emission (MHz)	Limit (dB μ V)	
	Quasi-peak	Average
0.15 - 0.50	66 - 56*	56 - 46*
0.50 - 5.0	56	46
5.0 - 30.0	60	50

NOTE:

- (1) The tighter limit applies at the band edges.
- (2) The limit of " * " marked band means the limitation decreases linearly with the logarithm of the frequency in the range.

The following table is the setting of the receiver

Receiver Parameters	Setting
Attenuation	10 dB
Start Frequency	0.15 MHz
Stop Frequency	30 MHz
IF Bandwidth	9 kHz

4.2 TEST PROCEDURE

- a. The EUT was placed 0.8 meters from the horizontal ground plane with EUT being connected to the power mains through a line impedance stabilization network (LISN). All other support equipment powered from additional LISN(s). The LISN provide 50 Ohm/ 50uH of coupling impedance for the measuring instrument.
- b. Interconnecting cables that hang closer than 40 cm to the ground plane shall be folded back and forth in the center forming a bundle 30 to 40 cm long.
- c. I/O cables that are not connected to a peripheral shall be bundled in the center. The end of the cable may be terminated, if required, using the correct terminating impedance. The overall length shall not exceed 1 m.
- d. LISN at least 80 cm from nearest part of EUT chassis.
- e. For the actual test configuration, please refer to the related Item -EUT Test Photos.

4.3 DEVIATION FROM TEST STANDARD

No deviation

4.4 TEST SETUP

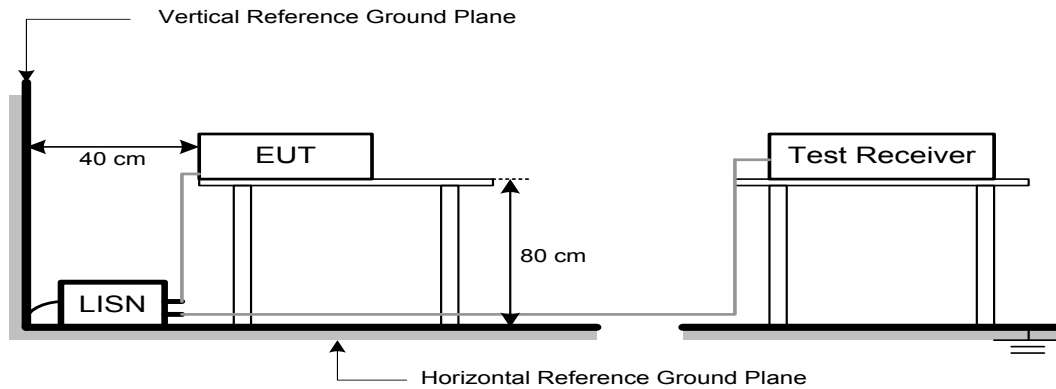

4.5 EUT OPERATION CONDITIONS

EUT was programmed to be in continuously transmitting mode.

4.6 EUT TEST CONDITIONS

Temperature: 25°C Relative Humidity: 53% Test Voltage: AC 120V/60Hz

4.7 TEST RESULTS

Please refer to the APPENDIX A.

5. RADIATED EMISSIONS TEST

5.1 LIMIT

In case the emission fall within the restricted band specified on 15.205(a), then the 15.209(a) limit in the table below has to be followed.

LIMITS OF RADIATED EMISSION MEASUREMENT (9 kHz-1000 MHz)

Frequency (MHz)	Field Strength (microvolts/meter)	Measurement Distance (meters)
0.009-0.490	2400/F(kHz)	300
0.490-1.705	24000/F(kHz)	30
1.705-30.0	30	30
30-88	100	3
88-216	150	3
216-960	200	3
Above 960	500	3

LIMITS OF RADIATED EMISSION MEASUREMENT (Above 1000 MHz)

Frequency (MHz)	(dBuV/m at 3 m)	
	Peak	Average
Above 1000	74	54

NOTE:

- (1) The limit for radiated test was performed according to FCC PART 15C.
- (2) The tighter limit applies at the band edges.
- (3) Emission level (dBuV/m)=20log Emission level (uV/m).
- (4) The test result calculated as following:
 Measurement Value = Reading Level + Correct Factor
 Correct Factor = Antenna Factor + Cable Loss - Amplifier Gain(if use)
 Margin Level = Measurement Value - Limit Value

Spectrum Parameter	Setting
Attenuation	Auto
Start Frequency	1000 MHz
Stop Frequency	10th carrier harmonic
RBW / VBW (Emission in restricted band)	1 MHz / 3 MHz for Peak, 1 MHz / 1/T for Average

Receiver Parameter	Setting
Attenuation	Auto
Start ~ Stop Frequency	9 kHz~90 kHz for PK/AVG detector
Start ~ Stop Frequency	90 kHz~110 kHz for QP detector
Start ~ Stop Frequency	110 kHz~490 kHz for PK/AVG detector
Start ~ Stop Frequency	490 kHz~30 MHz for QP detector
Start ~ Stop Frequency	30 MHz~1000 MHz for QP detector

5.2 TEST PROCEDURE

- a. The measuring distance of 3 m shall be used for measurements. The EUT was placed on the top of a rotating table 0.8 meter above the ground at a 3 meter semi-anechoic chamber. The table was rotated 360 degrees to determine the position of the highest radiation.(below 1 GHz)
- b. The measuring distance of 3 m shall be used for measurements. The EUT was placed on the top of a rotating table 1.5 meter above the ground at a 3 meter semi-anechoic chamber. The table was rotated 360 degrees to determine the position of the highest radiation.(above 1 GHz)
- c. The height of the equipment or of the substitution antenna shall be 0.8m or 1.5m; the height of the test antenna shall vary between 1 m to 4 m. Both horizontal and vertical polarizations of the antenna are set to make the measurement.
- d. For each suspected emission, the EUT was arranged to its worst case and then the antenna was tuned to heights find the maximum reading (used Bore sight function).
- e. The receiver system was set to peak and average detect function and specified bandwidth with maximum hold mode when the test frequency is above 1 GHz.
- f. The initial step in collecting radiated emission data is a receiver peak detector mode pre-scanning the measurement frequency range. Significant peaks are then marked and then Quasi Peak detector mode re-measured.
- g. All readings are Peak unless otherwise stated QP in column of Note. Peak denotes that the Peak reading compliance with the QP Limits and then QP Mode measurement didn't perform. (below 1 GHz)
- h. All readings are Peak Mode value unless otherwise stated AVG in column of Note. If the Peak Mode Measured value compliance with the Peak Limits and lower than AVG Limits, the EUT shall be deemed to meet both Peak & AVG Limits and then only Peak Mode was measured, but AVG Mode didn't perform. (above 1 GHz)
- i. For the actual test configuration, please refer to the related Item -EUT Test Photos.

5.3 DEVIATION FROM TEST STANDARD

No deviation

5.4 TEST SETUP

9 kHz-30 MHz

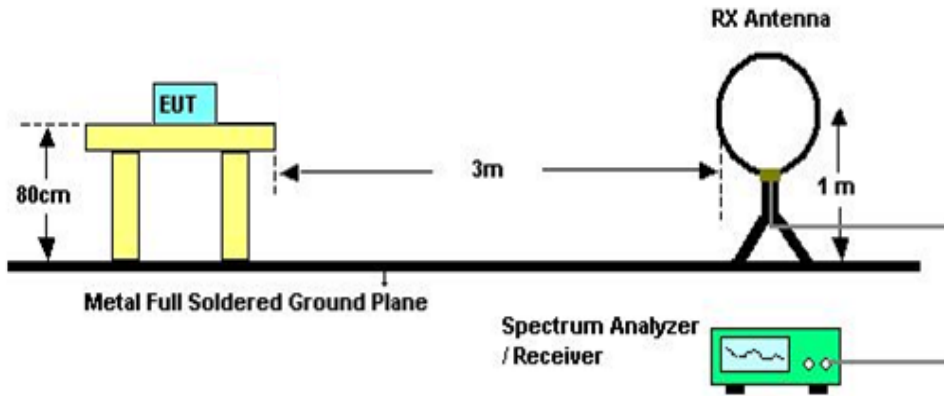

30 MHz to 1 GHz

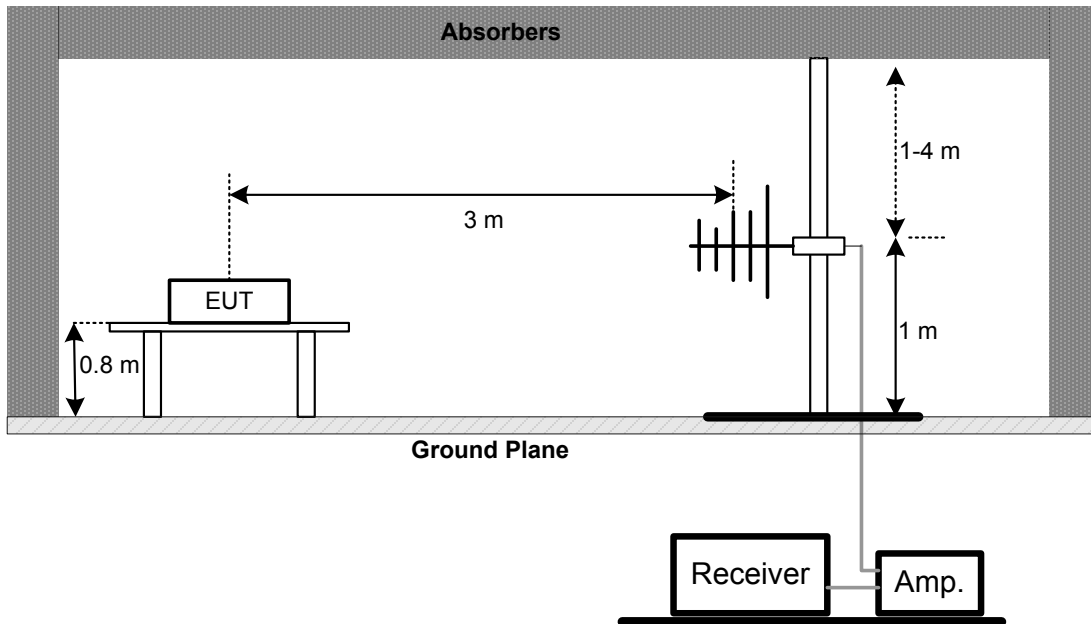

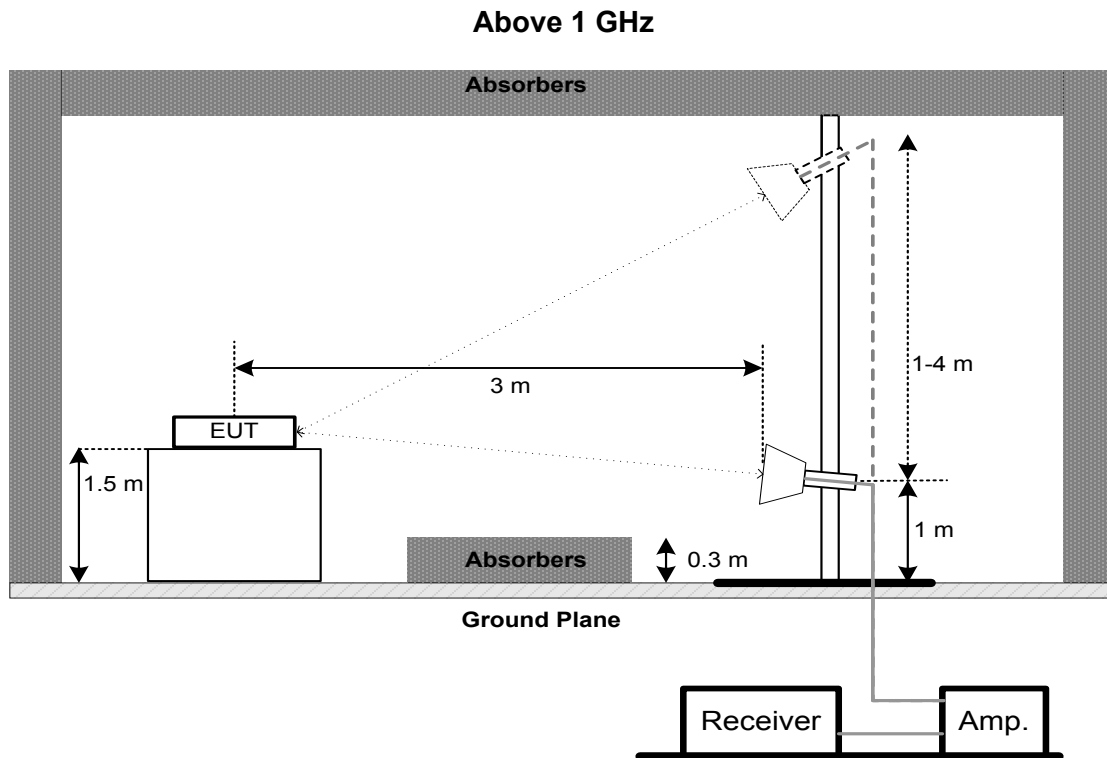

5.5 EUT OPERATION CONDITIONS

The EUT was programmed to be in continuously transmitting mode.

5.6 EUT TEST CONDITIONS

Temperature: 24°C Relative Humidity: 63% Test Voltage: AC 120V/60Hz

5.7 TEST RESULTS - 9 KHZ TO 30 MHZ

Please refer to the APPENDIX B

Remark:

- (1) Distance extrapolation factor = $40 \log(\text{specific distance} / \text{test distance})$ (dB).
- (2) Limit line = specific limits (dBuV) + distance extrapolation factor.

5.8 TEST RESULTS - 30 MHZ TO 1000 MHZ

Please refer to the APPENDIX C.

5.9 TEST RESULTS - ABOVE 1000 MHZ

Please refer to the APPENDIX D.

Remark:

- (1) No limit: This is fundamental signal, the judgment is not applicable.
For fundamental signal judgment was referred to Peak output test.

6. BANDWIDTH TEST

6.1 LIMIT

FCC Part15, Subpart C (15.247)		
Section	Test Item	Limit
15.247(a)(2)	6 dB Bandwidth	Minimum 500 kHz
	99% Emission Bandwidth	-

6.2 TEST PROCEDURE

- a. The EUT was directly connected to the spectrum analyzer and antenna output port as show in the block diagram below.
- b. Spectrum Setting:
 For 6 dB Bandwidth : RBW= 100 kHz, VBW=300 kHz, Sweep time = 2.5 ms.
 For 99% Emission Bandwidth B/G/N-20 Mode: RBW= 300 KHz, VBW=3 MHz, Sweep time = 2.5 ms.
 For 99% Emission Bandwidth N-40 Mode: RBW= 1 MHz, VBW=3 MHz, Sweep time = 2.5 ms.
- c. The bandwidth was performed in accordance with method 11.8.1 of ANSI C63.10-2013.

6.3 DEVIATION FROM STANDARD

No deviation.

6.4 TEST SETUP

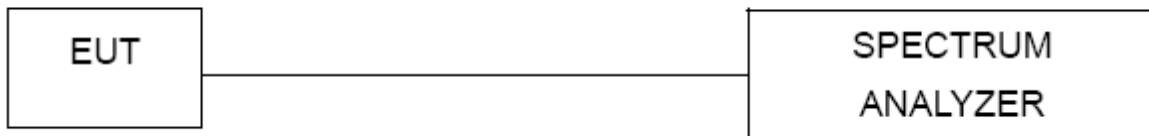

6.5 EUT OPERATION CONDITIONS

The EUT was programmed to be in continuously transmitting mode.

6.6 EUT TEST CONDITIONS

Temperature: 24°C Relative Humidity: 71% Test Voltage: AC 120V/60Hz

6.7 TEST RESULTS

Please refer to the APPENDIX E.

7. MAXIMUM AVERAGE OUTPUT POWER TEST

7.1 LIMIT

FCC Part15, Subpart C (15.247)		
Section	Test Item	Limit
15.247(b)(3)	Maximum Average Output Power	1 Watt or 30dBm

7.2 TEST PROCEDURE

- a. The EUT was directly connected to the power meter and antenna output port as show in the block diagram below.
- b. The maximum conducted output power was performed in accordance with method 11.9.2.3 of ANSI C63.10-2013 and FCC KDB 662911 D01 v02r01 Multiple Transmitter Output.

7.3 DEVIATION FROM STANDARD

No deviation.

7.4 TEST SETUP



7.5 EUT OPERATION CONDITIONS

The EUT was programmed to be in continuously transmitting mode.

7.6 EUT TEST CONDITIONS

Temperature: 24°C Relative Humidity: 71% Test Voltage: AC 120V/60Hz

7.7 TEST RESULTS

Please refer to the APPENDIX F.

8. CONDUCTED SPURIOUS EMISSIONS

8.1 LIMIT

In any 100 kHz bandwidth outside the frequency band in which the spread spectrum or digitally modulated intentional radiator is operating, the radio frequency power that is produced by the intentional radiator shall be at least 20 dB below that in the 100 kHz bandwidth within the band that contains the highest level of the desired power, based on either an RF conducted or a radiated measurement, provided the transmitter demonstrates compliance with the peak Output Power limits. If the transmitter complies with the Output Power limits based on the use of RMS averaging over a time interval, as permitted under paragraph (b)(3) of this section, the attenuation required under this paragraph shall be 30 dB instead of 20 dB. Attenuation below the general limits specified in Section 15.209(a) is not required.

8.2 TEST PROCEDURE

- a. The EUT was directly connected to the spectrum analyzer and antenna output port as show in the block diagram below.
- b. Spectrum Setting: RBW= 100 kHz, VBW=300 kHz, Sweep time = Auto.

8.3 DEVIATION FROM STANDARD

No deviation.

8.4 TEST SETUP

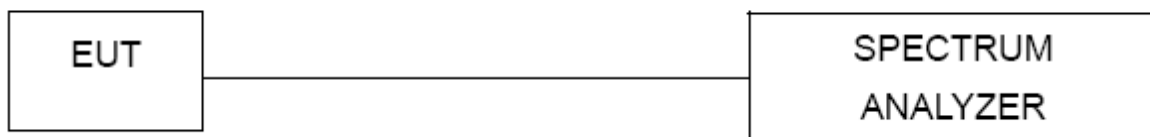

8.5 EUT OPERATION CONDITIONS

The EUT was programmed to be in continuously transmitting mode.

8.6 EUT TEST CONDITIONS

Temperature: 24°C Relative Humidity: 71% Test Voltage: AC 120V/60Hz

8.7 TEST RESULTS

Please refer to the APPENDIX G.

9. POWER SPECTRAL DENSITY TEST

9.1 LIMIT

FCC Part15, Subpart C (15.247)		
Section	Test Item	Limit
15.247(e)	Power Spectral Density	8 dBm (in any 3 kHz)

9.2 TEST PROCEDURE

- The EUT was directly connected to the spectrum analyzer and antenna output port as show in the block diagram below.
- Spectrum Setting: RBW=3 kHz, VBW=10 kHz, Sweep time = Auto.
- The Power Spectral Density was performed in accordance with method 11.10.2 of ANSI C63.10-2013.

9.3 DEVIATION FROM STANDARD

No deviation.

9.4 TEST SETUP



9.5 EUT OPERATION CONDITIONS

The EUT was programmed to be in continuously transmitting mode.

9.6 EUT TEST CONDITIONS

Temperature: 24°C Relative Humidity: 71% Test Voltage: AC 120V/60Hz

9.7 TEST RESULTS

Please refer to the APPENDIX H.

10. MEASUREMENT INSTRUMENTS LIST

AC Power Line Conducted Emissions					
Item	Kind of Equipment	Manufacturer	Type No.	Serial No.	Calibrated until
1	EMI Test Receiver	R&S	ESCI	100382	Mar. 10, 2020
2	LISN	EMCO	3816/2	52765	Mar. 10, 2020
3	50ohm Terminator	SHX	TF5-3	15041305	Mar. 10, 2020
4	Artificial-Mains Network	SCHWARZBECK	NSLK 8127	8127685	Mar. 10, 2020
5	TRANSIENT LIMITER	EM	EM-7600	772	Mar. 10, 2020
6	Measurement Software	Farad	EZ-EMC Ver.NB-03A1-01	N/A	N/A
7	Cable	N/A	RG223	12m	Mar. 12, 2020

Radiated Emissions - 9 kHz to 30 MHz					
Item	Kind of Equipment	Manufacturer	Type No.	Serial No.	Calibrated until
1	Loop Antenna	EM	EM-6876-1	230	Jan. 15, 2020
2	Cable	N/A	RG 213/U	C-102	May 31, 2020
3	EMI Test Receiver	R&S	ESCI	100895	Mar. 10, 2020
4	Measurement Software	Farad	EZ-EMC Ver.NB-03A1-01	N/A	N/A

Radiated Emissions - 30 MHz to 1 GHz					
Item	Kind of Equipment	Manufacturer	Type No.	Serial No.	Calibrated until
1	Antenna	Schwarzbeck	VULB9160	9160-3232	Mar. 09, 2020
2	Amplifier	HP	8447D	2944A09673	Aug. 11, 2019
3	Receiver	Agilent	N9038A	MY52130039	Aug. 11, 2019
4	Cable	emci	LMR-400(30MHz-1GHz)(8m+5m)	N/A	May 24, 2020
5	Controller	CT	SC100	N/A	N/A
6	Controller	MF	MF-7802	MF780208416	N/A
7	Measurement Software	Farad	EZ-EMC Ver.NB-03A1-01	N/A	N/A

Radiated Emissions - Above 1 GHz					
Item	Kind of Equipment	Manufacturer	Type No.	Serial No.	Calibrated until
1	Double Ridged Guide Antenna	ETS	3115	75789	Mar. 09, 2020
2	Broad-Band Horn Antenna	Schwarzbeck	BBHA 9170	9170319	Jun. 30, 2019
3	Amplifier	Agilent	8449B	3008A02333	Mar. 10, 2020
4	Microwave Preamplifier With Adaptor	EMC INSTRUMENT	EMC2654045	980039 & HA01	Mar. 10, 2020
5	Receiver	Agilent	N9038A	MY52130039	Aug. 11, 2019
6	Controller	CT	SC100	N/A	N/A
7	Controller	MF	MF-7802	MF780208416	N/A
8	Cable	mitron	B10-01-01-12M	18072744	Jul. 30, 2019
9	Measurement Software	Farad	EZ-EMC Ver.NB-03A1-01	N/A	N/A

Bandwidth					
Item	Kind of Equipment	Manufacturer	Type No.	Serial No.	Calibrated until
1	Spectrum Analyzer	R&S	FSP40	100185	Aug. 11, 2019

Maximum Average Output Power					
Item	Kind of Equipment	Manufacturer	Type No.	Serial No.	Calibrated until
1	P-series power meter	Agilent	N1911A	MY45100473	Aug. 11, 2019
2	wideband power sensor	Agilent	N1921A	MY51100041	Aug. 11, 2019

Antenna Conducted Spurious Emissions					
Item	Kind of Equipment	Manufacturer	Type No.	Serial No.	Calibrated until
1	Spectrum Analyzer	R&S	FSP40	100185	Aug. 11, 2019

Power Spectral Density					
Item	Kind of Equipment	Manufacturer	Type No.	Serial No.	Calibrated until
1	Spectrum Analyzer	R&S	FSP40	100185	Aug. 11, 2019

Remark: "N/A" denotes no model name, serial no. or calibration specified.
 All calibration period of equipment list is one year.

11. EUT TEST PHOTO**AC Power Line Conducted Emissions Test Photos**

Radiated Emissions Test Photos

9 kHz to 30 MHz



Radiated Emissions Test Photos

30 MHz to 1 GHz

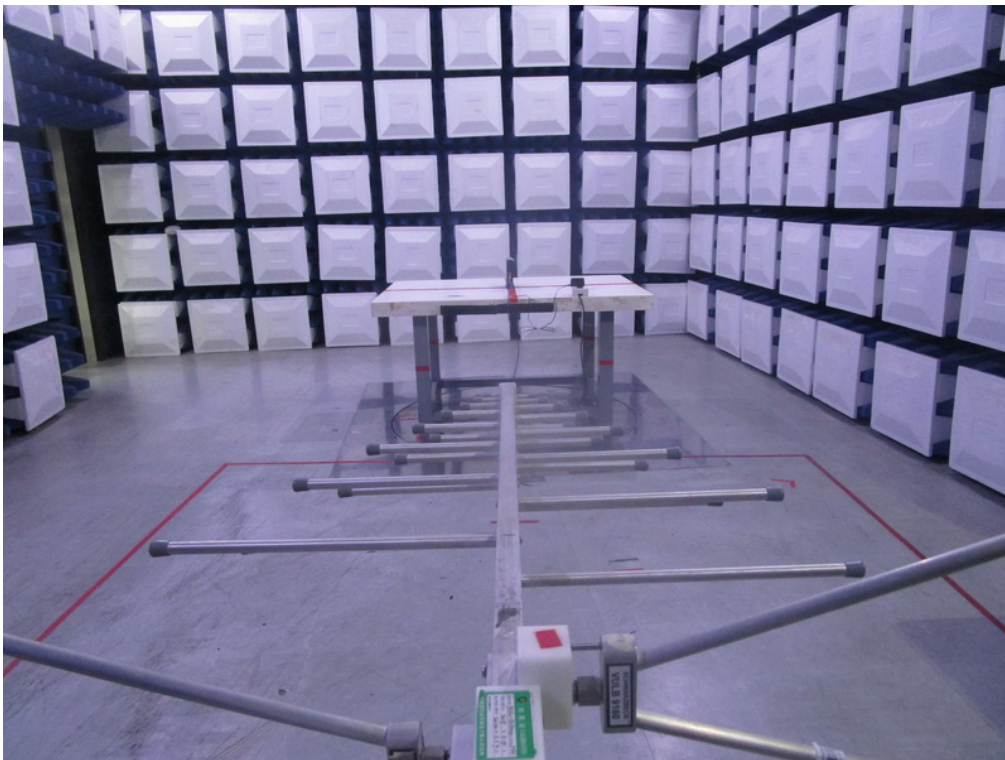
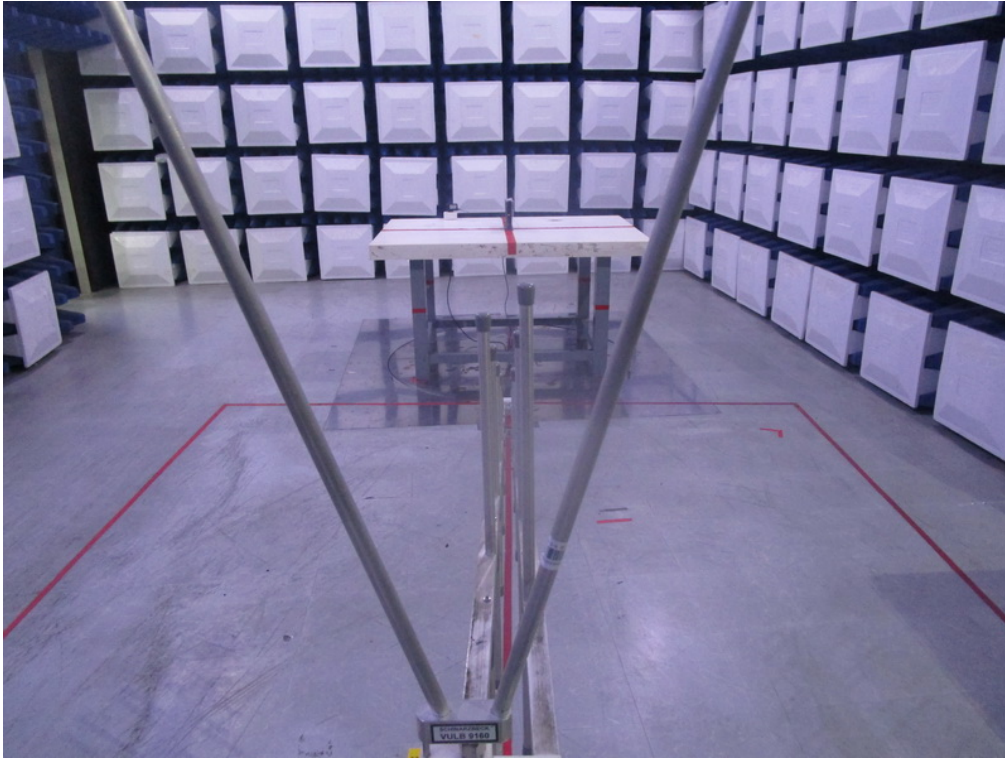

Radiated Emissions Test Photos

Above 1 GHz

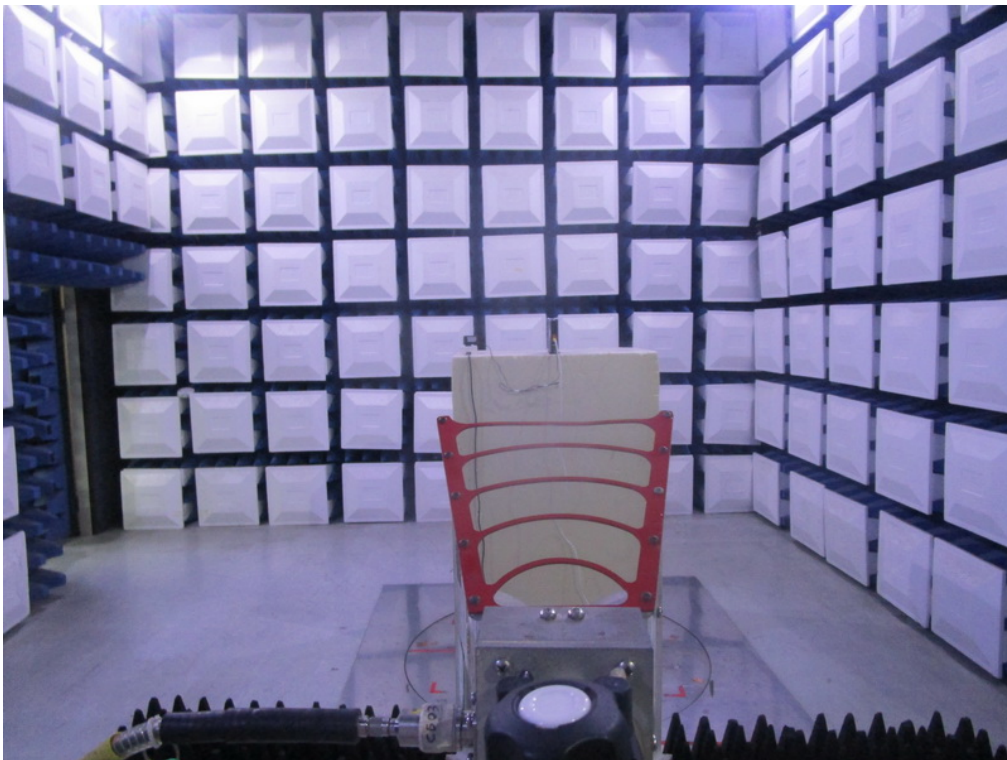

APPENDIX A - AC POWER LINE CONDUCTED EMISSIONS

Test Mode: TX N40 MODE CHANNEL 06

Line

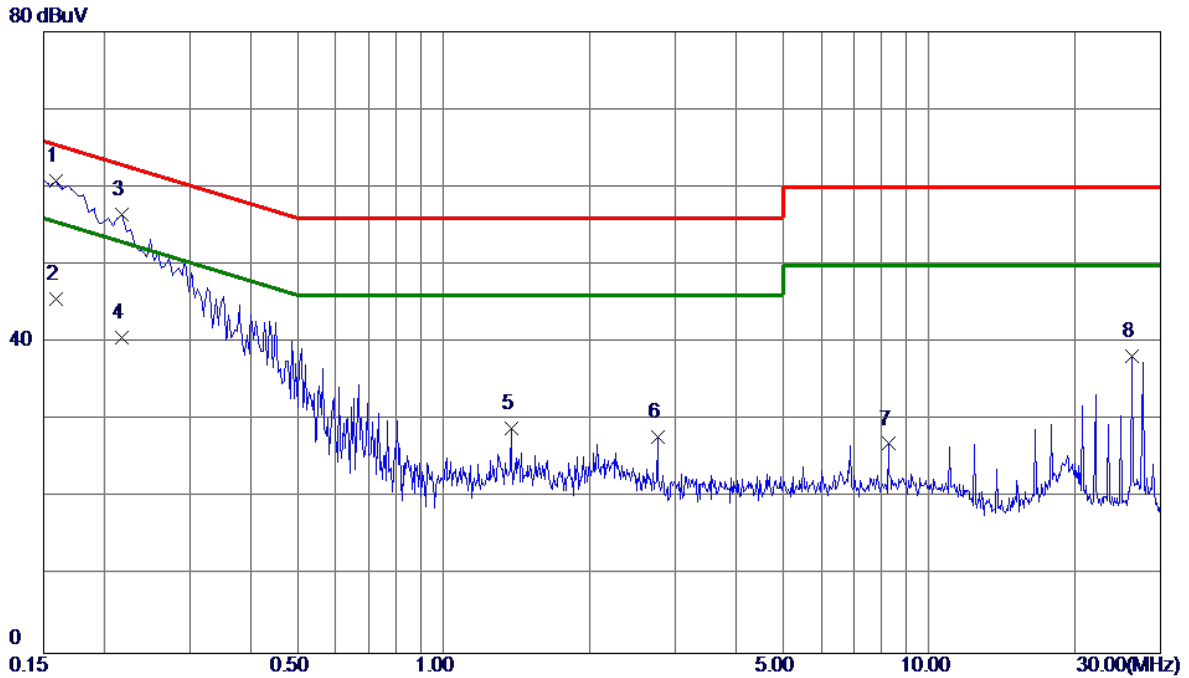

No.	Freq. MHz	Reading Level dBuV	Correct Factor dB	Measure ment dBuV	Limit dBuV	Margin dB	Detector	Comment
1 *	0.1590	50.27	10.48	60.75	65.52	-4.77	Peak	
2	0.1590	35.10	10.48	45.58	55.52	-9.94	AVG	
3	0.2175	45.98	10.48	56.46	62.91	-6.45	Peak	
4	0.2175	30.19	10.48	40.67	52.91	-12.24	AVG	
5	1.3784	18.36	10.59	28.95	56.00	-27.05	Peak	
6	2.7600	17.21	10.68	27.89	56.00	-28.11	Peak	
7	8.2770	16.07	10.89	26.96	60.00	-33.04	Peak	
8	26.1825	27.27	11.01	38.28	60.00	-21.72	Peak	

REMARKS:

- (1) Measurement Value = Reading Level + Correct Factor.
- (2) Margin Level = Measurement Value - Limit Value.

Test Mode: TX N40 MODE CHANNEL 06

Neutral

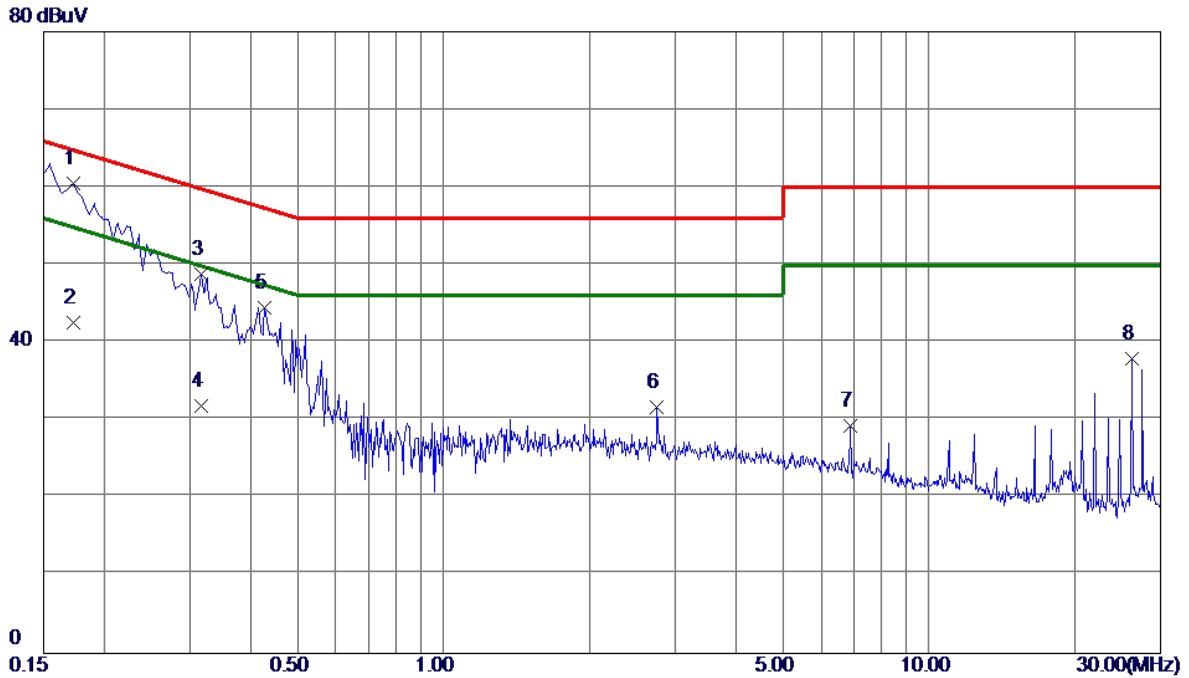

No.	Freq. MHz	Reading Level dBuV	Correct Factor dB	Measurement dBuV	Limit dBuV	Margin dB	Detector	Comment
1 *	0.1725	50.07	10.44	60.51	64.84	-4.33	Peak	
2	0.1725	32.10	10.44	42.54	54.84	-12.30	AVG	
3	0.3165	38.33	10.46	48.79	59.80	-11.01	Peak	
4	0.3165	21.40	10.46	31.86	49.80	-17.94	AVG	
5	0.4290	34.01	10.47	44.48	57.27	-12.79	Peak	
6	2.7510	20.99	10.64	31.63	56.00	-24.37	Peak	
7	6.8820	18.52	10.79	29.31	60.00	-30.69	Peak	
8	26.1375	26.97	11.01	37.98	60.00	-22.02	Peak	

REMARKS:

- (1) Measurement Value = Reading Level + Correct Factor.
- (2) Margin Level = Measurement Value - Limit Value.

APPENDIX B - RADIATED EMISSION - 9 KHZ TO 30 MHZ

Test Mode: TX N40 MODE CHANNEL 06

Ant 0°

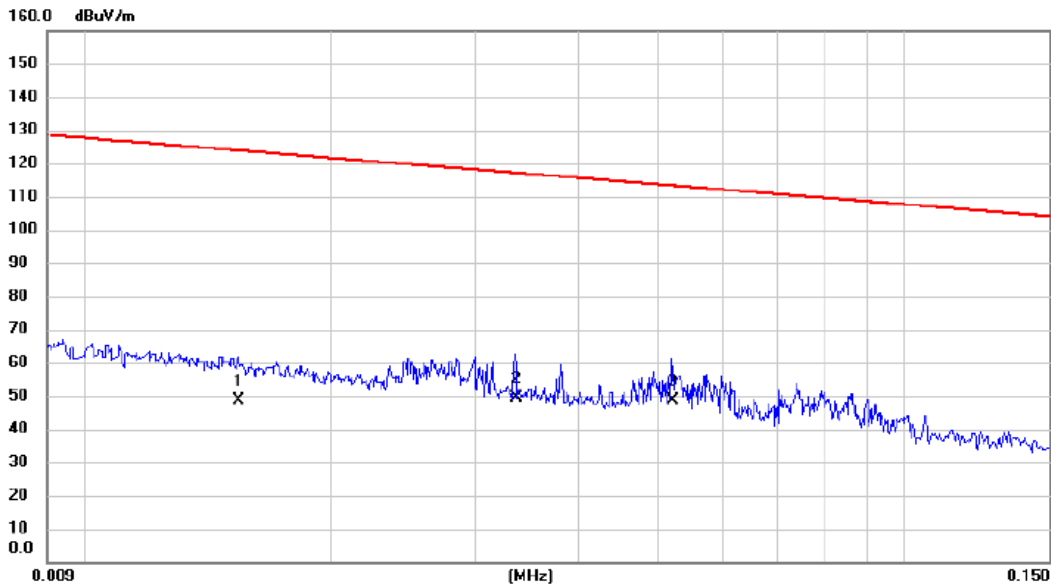

No.	Mk.	Freq. MHz	Reading Level dBuV	Correct Factor dB	Measure- ment dBuV/m	Limit dBuV/m	Margin dB	Detector	Comment
1		0.0154	33.50	15.20	48.70	123.85	-75.15	AVG	
2		0.0336	35.70	13.88	49.58	117.08	-67.50	AVG	
3	*	0.0521	34.90	13.90	48.80	113.27	-64.47	AVG	

REMARKS:

- (1) Measurement Value = Reading Level + Correct Factor.
- (2) Margin Level = Measurement Value - Limit Value.

Test Mode: TX N40 MODE CHANNEL 06

Ant 0°

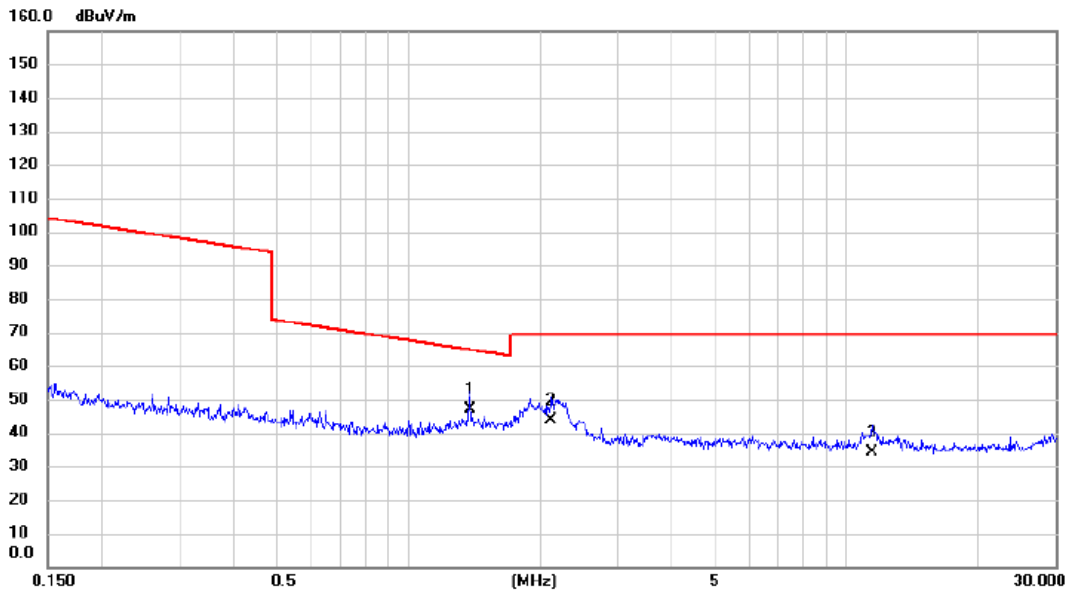

No.	Mk.	Freq. MHz	Reading Level dBuV	Correct Factor dB	Measure- ment dBuV/m	Limit dBuV/m	Margin dB	Detector	Comment
1	*	1.3810	34.80	12.24	47.04	64.80	-17.76	QP	
2		2.1213	31.90	11.75	43.65	69.54	-25.89	QP	
3		11.4376	22.40	11.61	34.01	69.54	-35.53	QP	

REMARKS:

- (1) Measurement Value = Reading Level + Correct Factor.
- (2) Margin Level = Measurement Value - Limit Value.

Test Mode: TX N40 MODE CHANNEL 06

Ant 90°

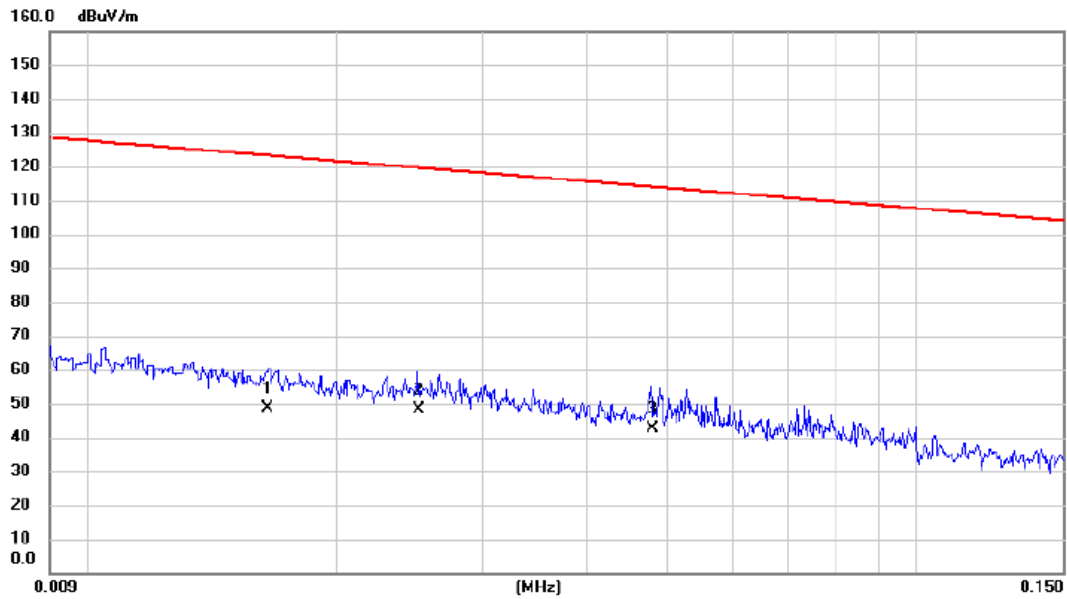

No.	Mk.	Freq. MHz	Reading Level dBuV	Correct Factor dB	Measure- ment dBuV/m	Limit dBuV/m	Margin dB	Detector	Comment
1		0.0165	33.77	14.87	48.64	123.26	-74.62	AVG	
2	*	0.0251	34.50	13.84	48.34	119.61	-71.27	AVG	
3		0.0480	28.70	13.92	42.62	113.98	-71.36	AVG	

REMARKS:

- (1) Measurement Value = Reading Level + Correct Factor.
- (2) Margin Level = Measurement Value - Limit Value.

Test Mode: TX N40 MODE CHANNEL 06

Ant 90°

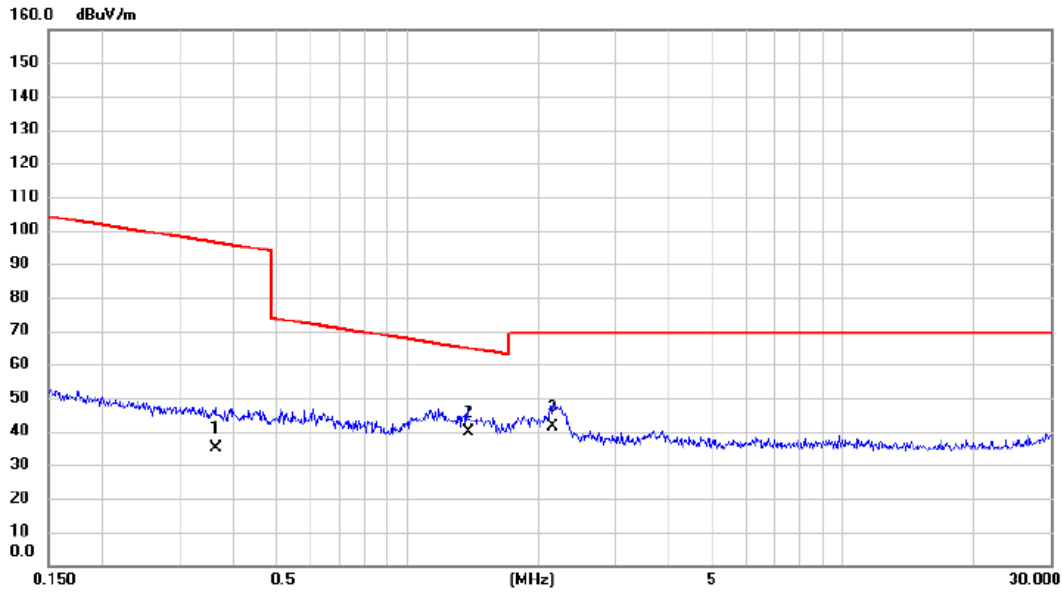

No.	Mk.	Freq. MHz	Reading Level dBuV	Correct Factor dB	Measure- ment dBuV/m	Limit dBuV/m	Margin dB	Detector	Comment
1		0.3634	21.80	13.39	35.19	96.40	-61.21	AVG	
2	*	1.3810	27.50	12.24	39.74	64.80	-25.06	QP	
3		2.1552	29.60	11.73	41.33	69.54	-28.21	QP	

REMARKS:

- (1) Measurement Value = Reading Level + Correct Factor.
- (2) Margin Level = Measurement Value - Limit Value.

APPENDIX C - RADIATED EMISSION - 30 MHZ TO 1000 MHZ

Test Mode: TX N40 MODE CHANNEL 06

Vertical

80 dBuV/m

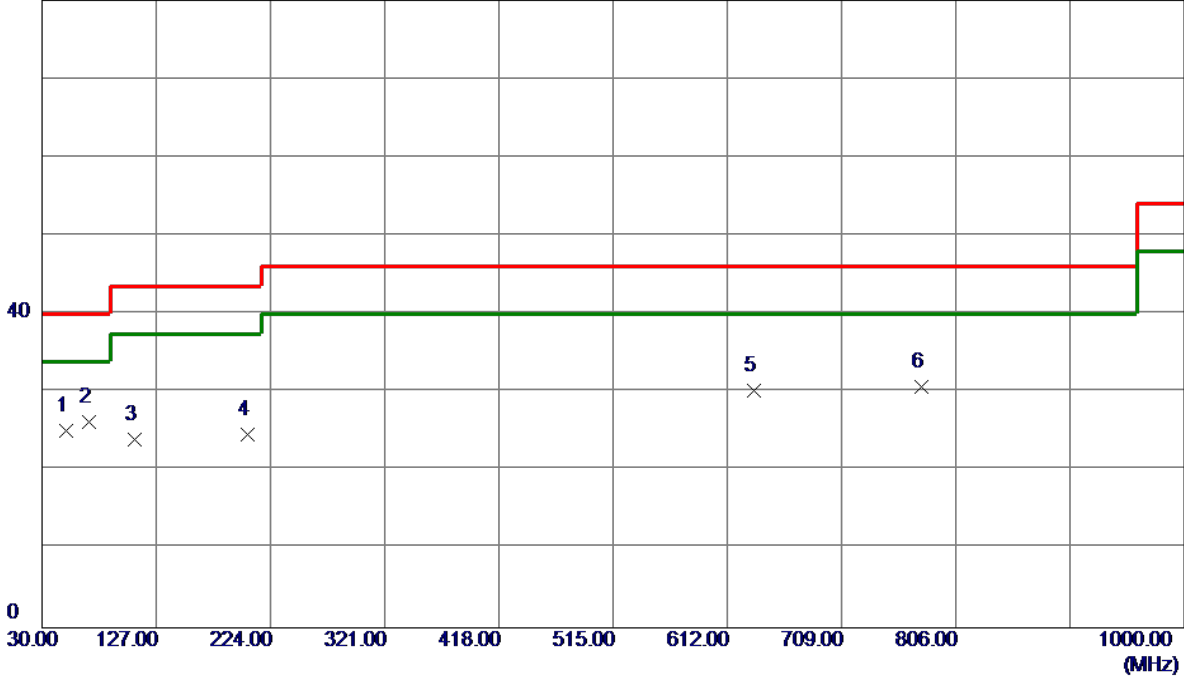

No.	Freq. MHz	Reading Level dBuV/m	Correct Factor dB	Measure ment dBuV/m	Limit dBuV/m	Margin dB	Detector	Comment
1	50.8550	39.05	-13.93	25.12	40.00	-14.88	Peak	
2 *	70.2550	42.54	-16.28	26.26	40.00	-13.74	Peak	
3	108.5700	38.74	-14.68	24.06	43.50	-19.44	Peak	
4	204.6000	40.14	-15.44	24.70	43.50	-18.80	Peak	
5	634.3100	35.28	-5.06	30.22	46.00	-15.78	Peak	
6	776.4150	34.09	-3.32	30.77	46.00	-15.23	Peak	

REMARKS:

- (1) Measurement Value = Reading Level + Correct Factor.
- (2) Margin Level = Measurement Value - Limit Value.

Test Mode: TX N40 MODE CHANNEL 06

Horizontal

80 dBuV/m

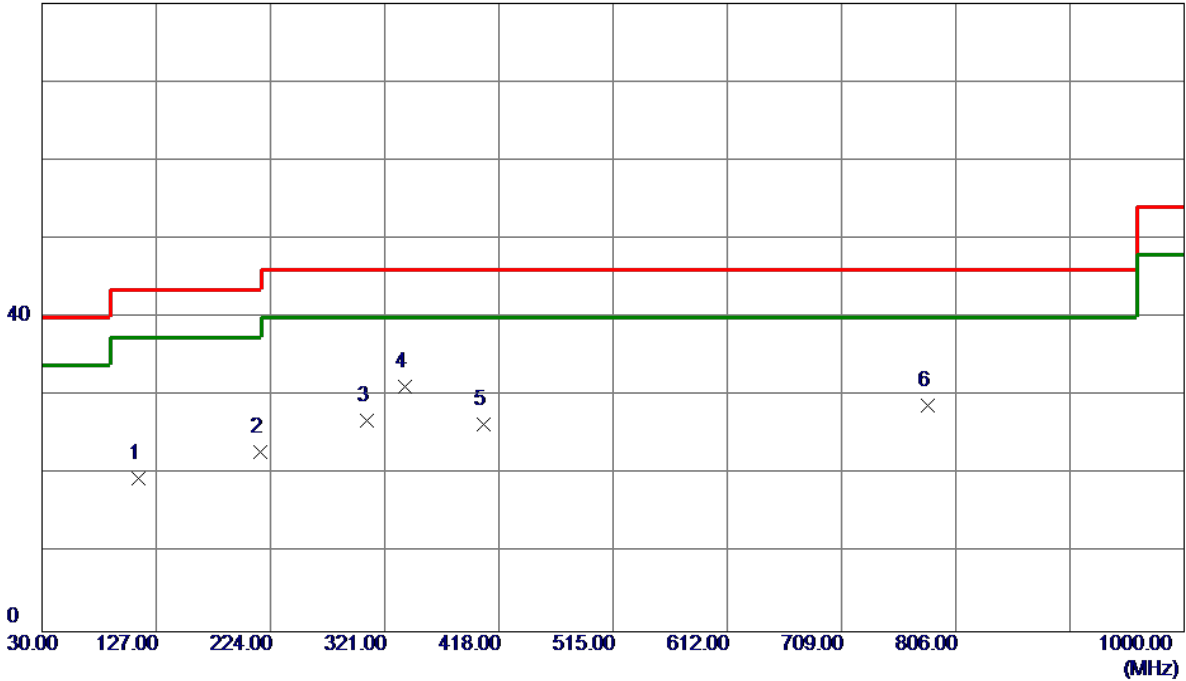

No.	Freq. MHz	Reading Level dBuV/m	Correct Factor dB	Measure ment dBuV/m	Limit dBuV/m	Margin dB	Detector	Comment
1	111.4800	33.87	-14.36	19.51	43.50	-23.99	Peak	
2	215.2700	38.11	-15.16	22.95	43.50	-20.55	Peak	
3	305.9650	38.26	-11.45	26.81	46.00	-19.19	Peak	
4 *	337.9750	42.11	-10.94	31.17	46.00	-14.83	Peak	
5	404.9050	35.74	-9.40	26.34	46.00	-19.66	Peak	
6	782.7199	32.09	-3.24	28.85	46.00	-17.15	Peak	

REMARKS:

- (1) Measurement Value = Reading Level + Correct Factor.
- (2) Margin Level = Measurement Value - Limit Value.

APPENDIX D - RADIATED EMISSION- ABOVE 1000 MHZ

Non-Beamforming

Orthogonal Axis	X
Test Mode:	TX B Mode 2412 MHz

Vertical

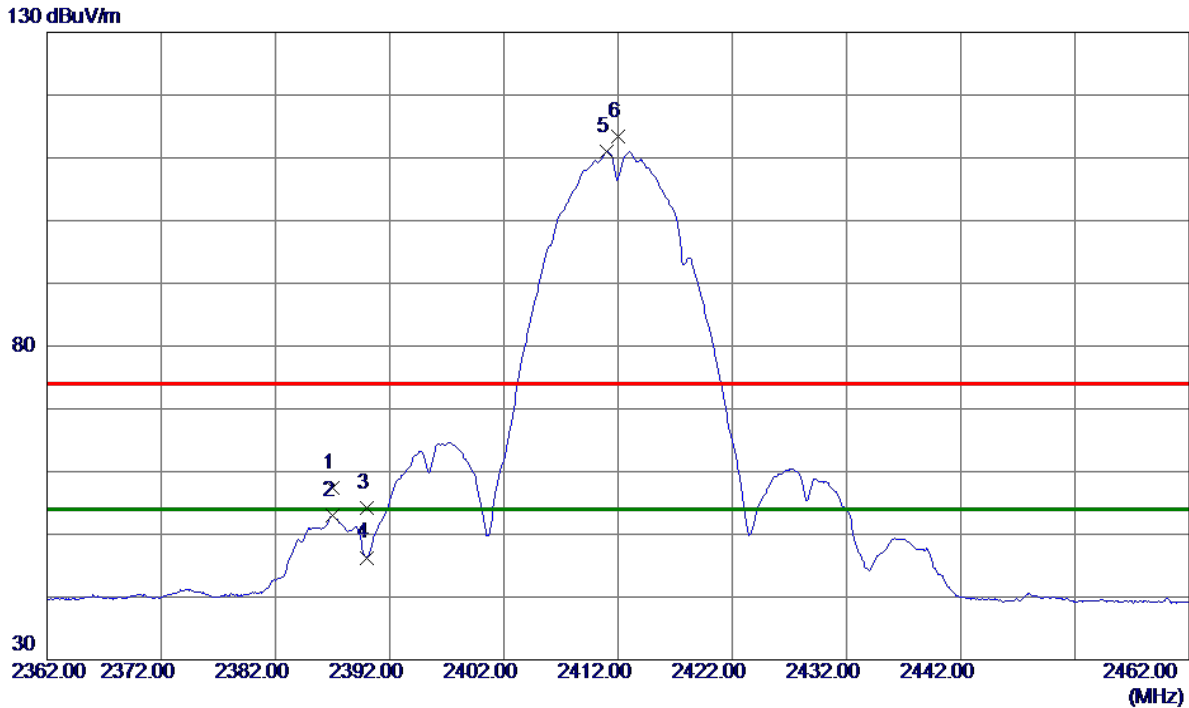

No.	Freq. MHz	Reading Level dBuV/m	Correct Factor dB	Measure ment dBuV/m	Limit dBuV/m	Margin dB	Detector	Comment
1	2387.0000	49.82	7.55	57.37	74.00	-16.63	Peak	
2	2387.0000	45.52	7.55	53.07	54.00	-0.93	AVG	
3	2390.0000	46.64	7.56	54.20	74.00	-19.80	Peak	
4	2390.0000	38.74	7.56	46.30	54.00	-7.70	AVG	
5 *	2411.0000	103.36	7.63	110.99	54.00	56.99	AVG	No Limit
6	2412.0000	105.85	7.64	113.49	74.00	39.49	Peak	No Limit

REMARKS:

- (1) Measurement Value = Reading Level + Correct Factor.
- (2) Margin Level = Measurement Value - Limit Value.

Orthogonal Axis	X
Test Mode:	TX B Mode 2412 MHz

Vertical

80 dBuV/m

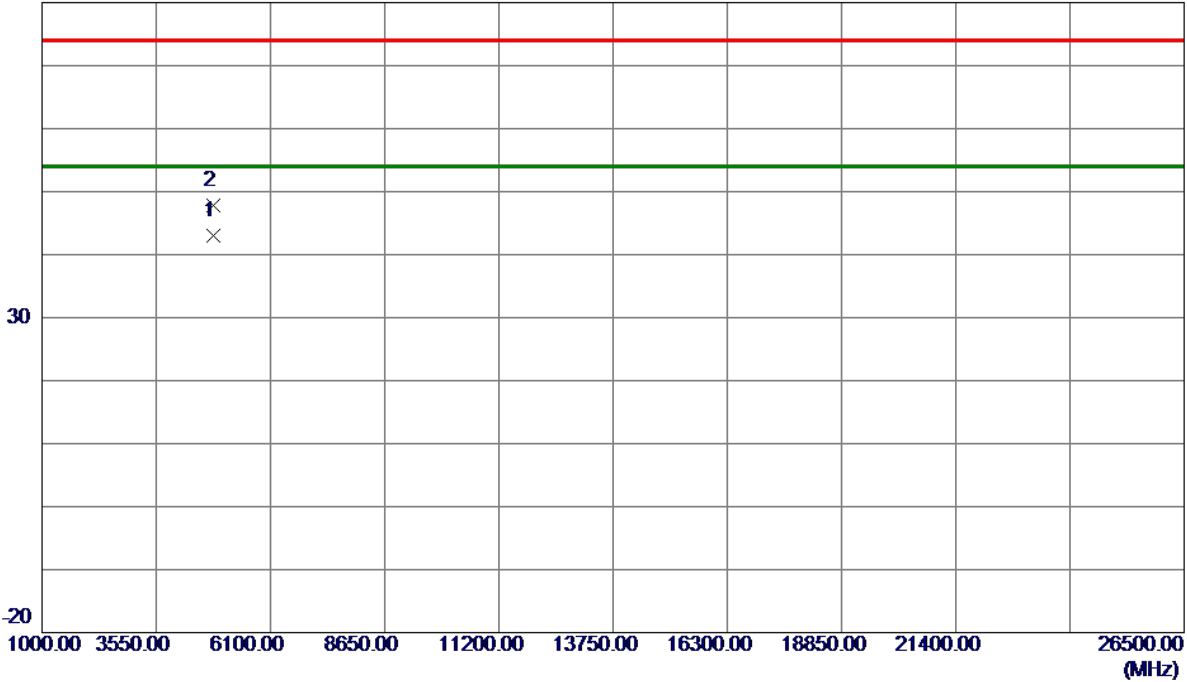

No.	Freq. MHz	Reading Level dBuV/m	Correct Factor dB	Measure ment dBuV/m	Limit dBuV/m	Margin dB	Detector	Comment
1 *	4823.9300	38.79	4.26	43.05	54.00	-10.95	AVG	
2	4824.1200	43.47	4.26	47.73	74.00	-26.27	Peak	

REMARKS:

- (1) Measurement Value = Reading Level + Correct Factor.
- (2) Margin Level = Measurement Value - Limit Value.

Orthogonal Axis	X
Test Mode:	TX B Mode 2412 MHz

Horizontal

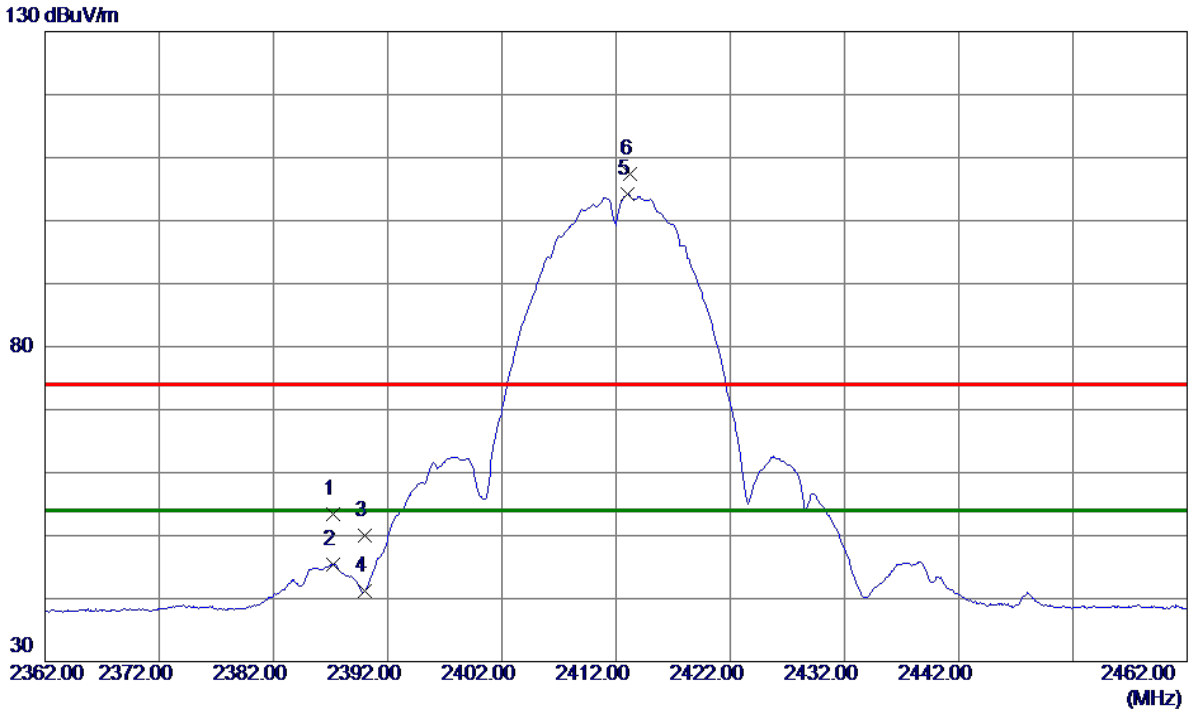

No.	Freq. MHz	Reading Level dBuV/m	Correct Factor dB	Measure ment dBuV/m	Limit dBuV/m	Margin dB	Detector	Comment
1	2387.2500	45.78	7.56	53.34	74.00	-20.66	Peak	
2	2387.2500	37.88	7.56	45.44	54.00	-8.56	AVG	
3	2390.0000	42.44	7.56	50.00	74.00	-24.00	Peak	
4	2390.0000	33.67	7.56	41.23	54.00	-12.77	AVG	
5 *	2413.0000	96.62	7.64	104.26	54.00	50.26	AVG	No Limit
6	2413.2000	99.68	7.64	107.32	74.00	33.32	Peak	No Limit

REMARKS:

- (1) Measurement Value = Reading Level + Correct Factor.
- (2) Margin Level = Measurement Value - Limit Value.

Orthogonal Axis	X
Test Mode:	TX B Mode 2412 MHz

Horizontal

80 dBuV/m

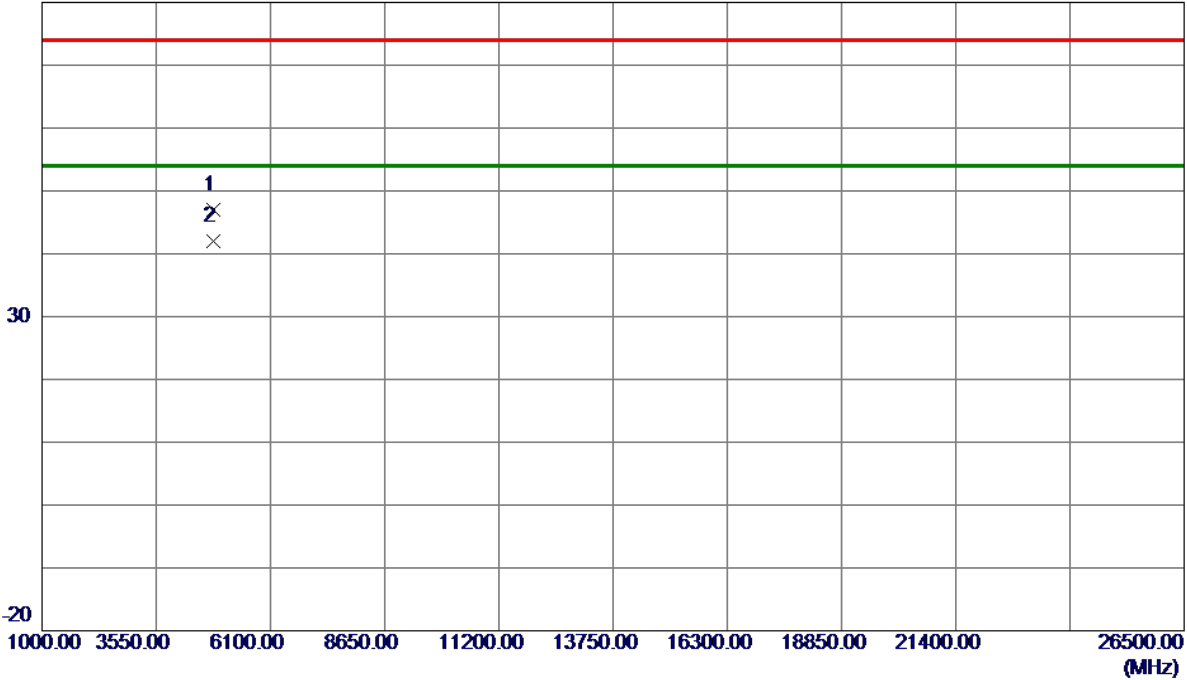

No.	Freq. MHz	Reading Level dBuV/m	Correct Factor dB	Measure ment dBuV/m	Limit dBuV/m	Margin dB	Detector	Comment
1	4823.8330	42.69	4.25	46.94	74.00	-27.06	Peak	
2 *	4823.8849	37.69	4.25	41.94	54.00	-12.06	AVG	

REMARKS:

- (1) Measurement Value = Reading Level + Correct Factor.
- (2) Margin Level = Measurement Value - Limit Value.

Orthogonal Axis	X
Test Mode:	TX B Mode 2417 MHz

Vertical

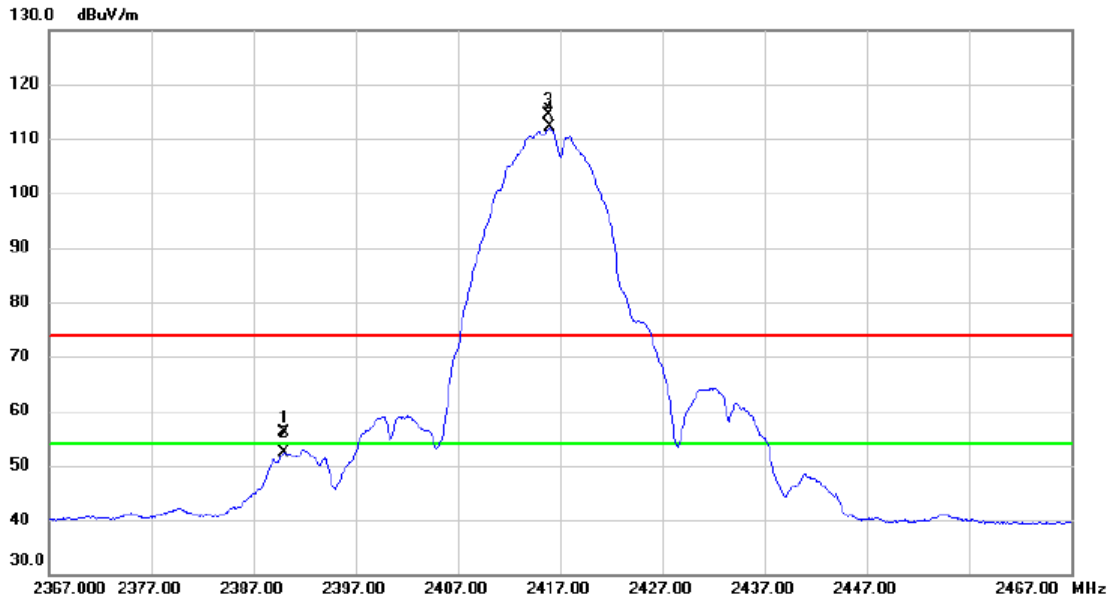

No.	Mk.	Freq. MHz	Reading Level dBuV	Correct Factor dB	Measure- ment dBuV/m	Limit dBuV/m	Margin dB	Detector	Comment
1		2390.000	48.53	7.57	56.10	74.00	-17.90	peak	
2		2390.000	44.76	7.57	52.33	54.00	-1.67	AVG	
3	X	2415.850	106.69	7.65	114.34	74.00	40.34	peak	No Limit
4	*	2416.000	104.38	7.66	112.04	54.00	58.04	AVG	No Limit

REMARKS:

- (1) Measurement Value = Reading Level + Correct Factor.
- (2) Margin Level = Measurement Value - Limit Value.

Orthogonal Axis	X
Test Mode:	TX B Mode 2417 MHz

Vertical

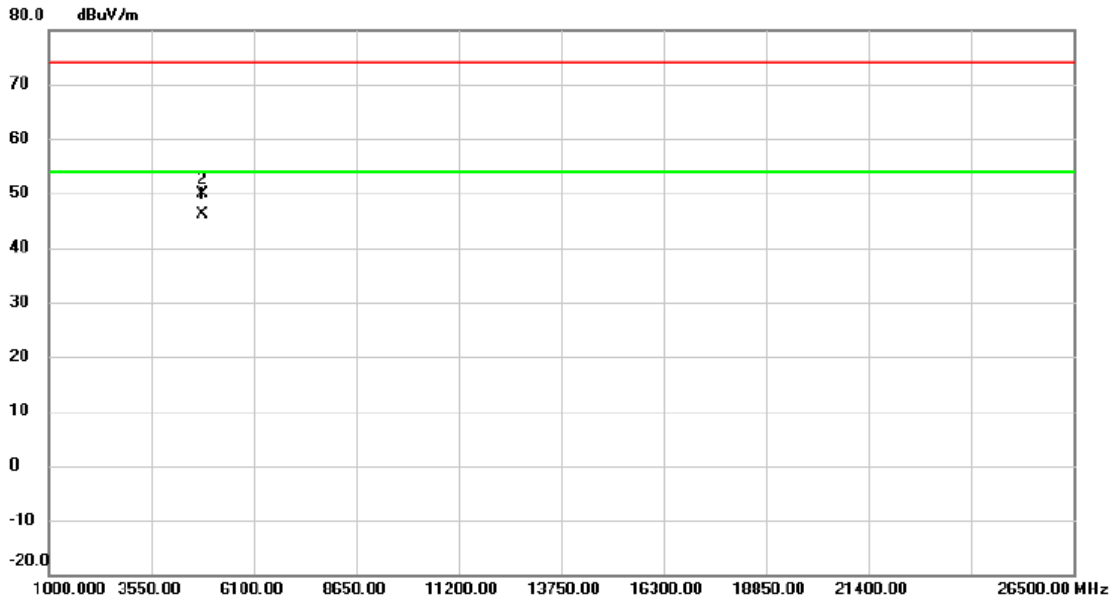

No.	Mk.	Freq.	Reading Level	Correct Factor	Measurement	Limit	Margin	Detector	Comment
		MHz	dBuV	dB	dBuV/m	dBuV/m	dB		
1	*	4833.909	41.88	4.29	46.17	54.00	-7.83	AVG	
2		4833.947	45.63	4.29	49.92	74.00	-24.08	peak	

REMARKS:

- (1) Measurement Value = Reading Level + Correct Factor.
- (2) Margin Level = Measurement Value - Limit Value.

Orthogonal Axis	X
Test Mode:	TX B Mode 2417 MHz

Horizontal

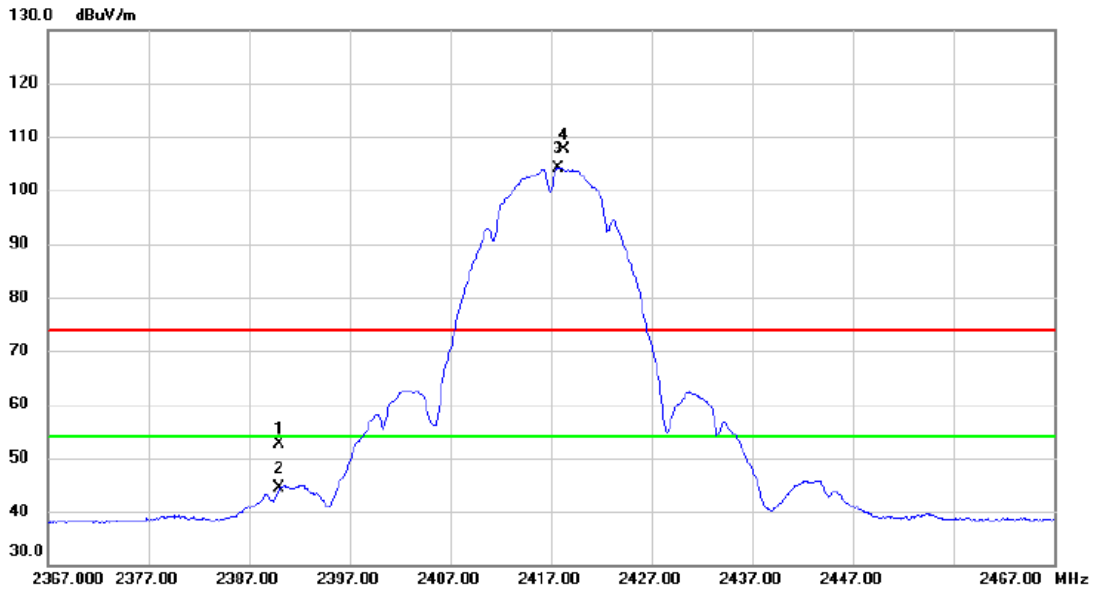

No.	Mk.	Freq. MHz	Reading Level dBuV	Correct Factor dB	Measure- ment dBuV/m	Limit dBuV/m	Margin dB	Detector	Comment
1		2390.000	45.08	7.57	52.65	74.00	-21.35	peak	
2		2390.000	36.78	7.57	44.35	54.00	-9.65	AVG	
3	*	2417.750	96.57	7.66	104.23	54.00	50.23	AVG	No Limit
4	X	2418.300	100.05	7.66	107.71	74.00	33.71	peak	No Limit

REMARKS:

(1) Measurement Value = Reading + Correct Factor.

(2) Margin Level = Measurement Value - Limit Value.

Orthogonal Axis	X
Test Mode:	TX B Mode 2417 MHz

Horizontal

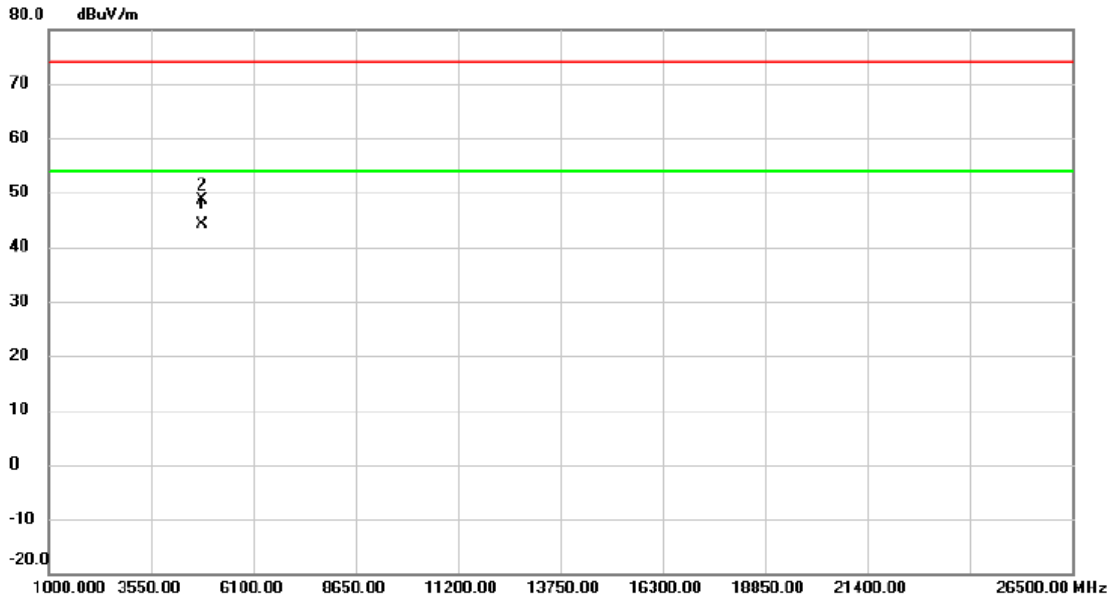

No.	Mk.	Freq. MHz	Reading Level dBuV	Correct Factor dB	Measure- ment dBuV/m	Limit dBuV/m	Margin dB	Detector	Comment
1	*	4833.919	39.91	4.29	44.20	54.00	-9.80	AVG	
2		4834.053	44.28	4.29	48.57	74.00	-25.43	peak	

REMARKS:

(1) Measurement Value = Reading Level + Correct Factor.

(2) Margin Level = Measurement Value - Limit Value.

Orthogonal Axis	X
Test Mode:	TX B Mode 2437 MHz

Vertical

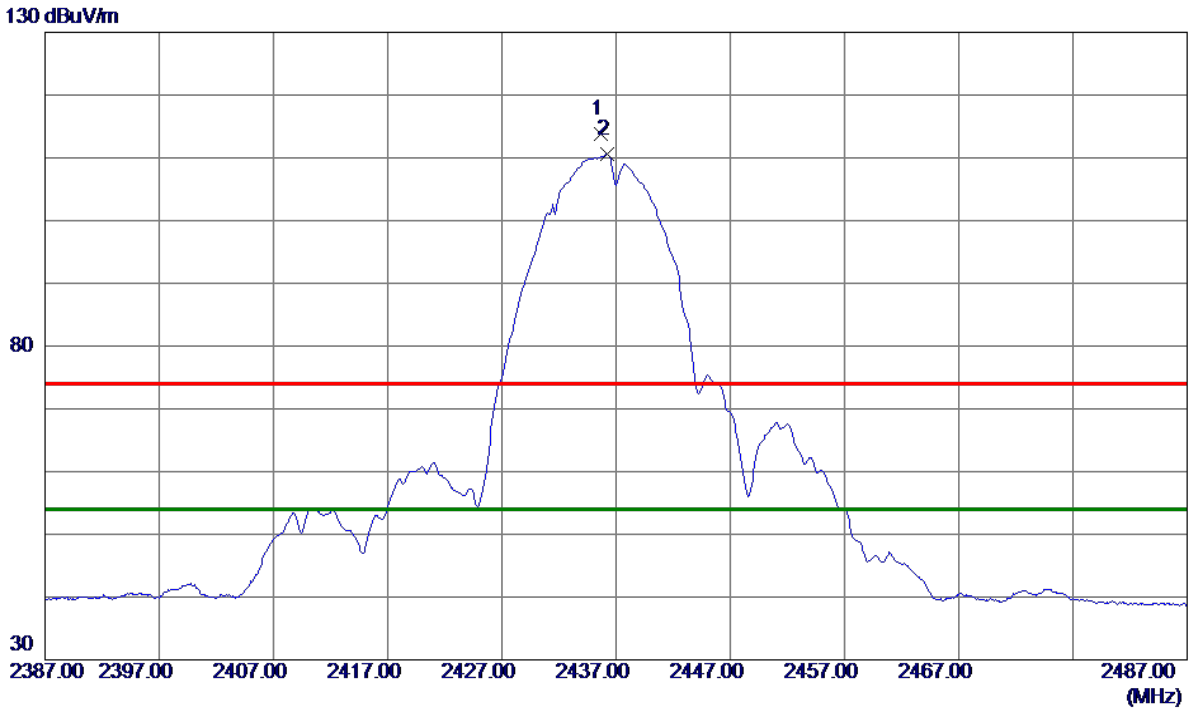

No.	Freq. MHz	Reading Level dBuV/m	Correct Factor dB	Measure ment dBuV/m	Limit dBuV/m	Margin dB	Detector	Comment
1	2435.7000	106.14	7.72	113.86	74.00	39.86	Peak	No Limit
2 *	2436.2500	102.84	7.72	110.56	54.00	56.56	AVG	No Limit

REMARKS:

- (1) Measurement Value = Reading Level + Correct Factor.
- (2) Margin Level = Measurement Value - Limit Value.

Orthogonal Axis	X
Test Mode:	TX B Mode 2437 MHz

Vertical

80 dBuV/m

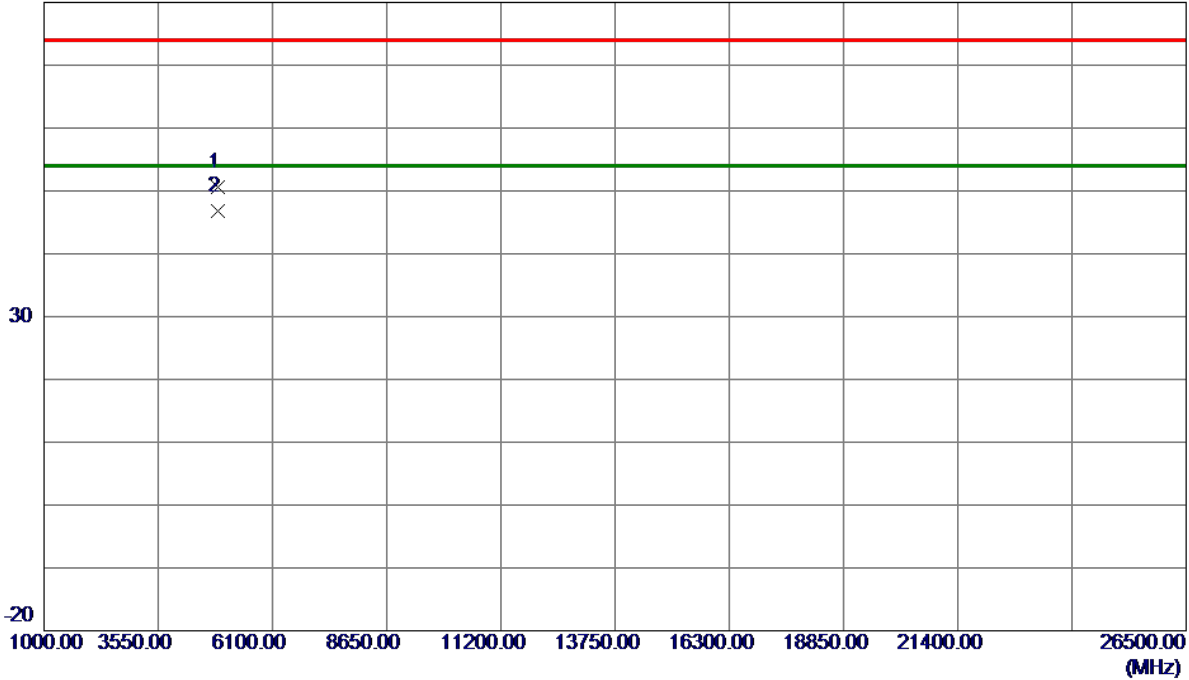

No.	Freq. MHz	Reading Level dBuV/m	Correct Factor dB	Measure ment dBuV/m	Limit dBuV/m	Margin dB	Detector	Comment
1	4873.9480	46.20	4.44	50.64	74.00	-23.36	Peak	
2 *	4873.9520	42.29	4.44	46.73	54.00	-7.27	AVG	

REMARKS:

- (1) Measurement Value = Reading Level + Correct Factor.
- (2) Margin Level = Measurement Value - Limit Value.

Orthogonal Axis	X
Test Mode:	TX B Mode 2437 MHz

Horizontal

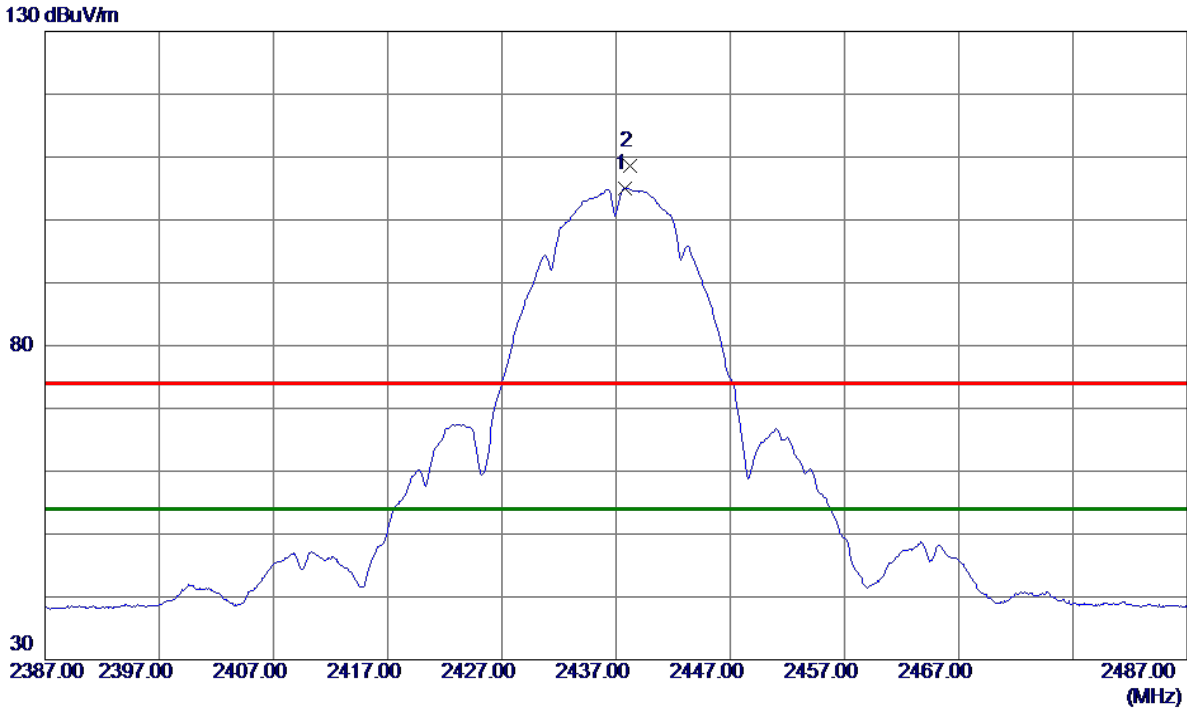

No.	Freq. MHz	Reading Level dBuV/m	Correct Factor dB	Measure ment dBuV/m	Limit dBuV/m	Margin dB	Detector	Comment
1 *	2437.7500	97.38	7.72	105.10	54.00	51.10	AVG	No Limit
2	2438.2000	100.83	7.72	108.55	74.00	34.55	Peak	No Limit

REMARKS:

- (1) Measurement Value = Reading Level + Correct Factor.
- (2) Margin Level = Measurement Value - Limit Value.

Orthogonal Axis	X
Test Mode:	TX B Mode 2437 MHz

Horizontal

80 dBuV/m

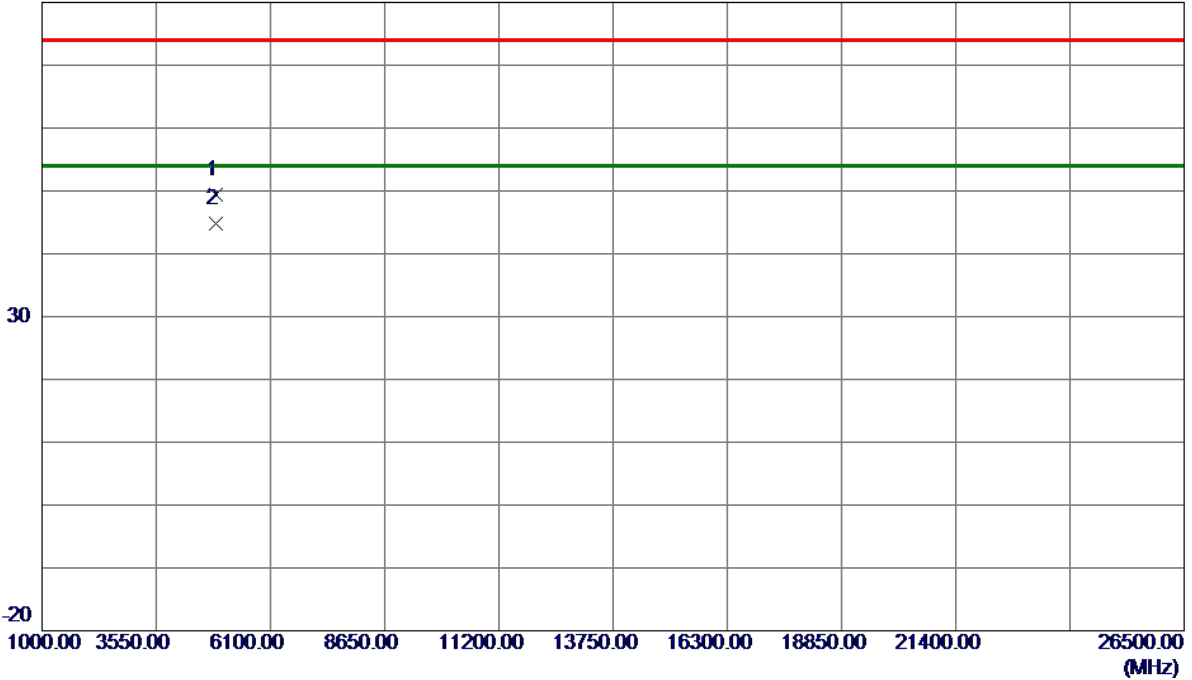

No.	Freq. MHz	Reading Level dBuV/m	Correct Factor dB	Measure ment dBuV/m	Limit dBuV/m	Margin dB	Detector	Comment
1	4873.8950	44.88	4.44	49.32	74.00	-24.68	Peak	
2 *	4873.9680	40.41	4.44	44.85	54.00	-9.15	AVG	

REMARKS:

(1) Measurement Value = Reading Level + Correct Factor.

(2) Margin Level = Measurement Value - Limit Value.

Orthogonal Axis	X
Test Mode:	TX B Mode 2457 MHz

Vertical

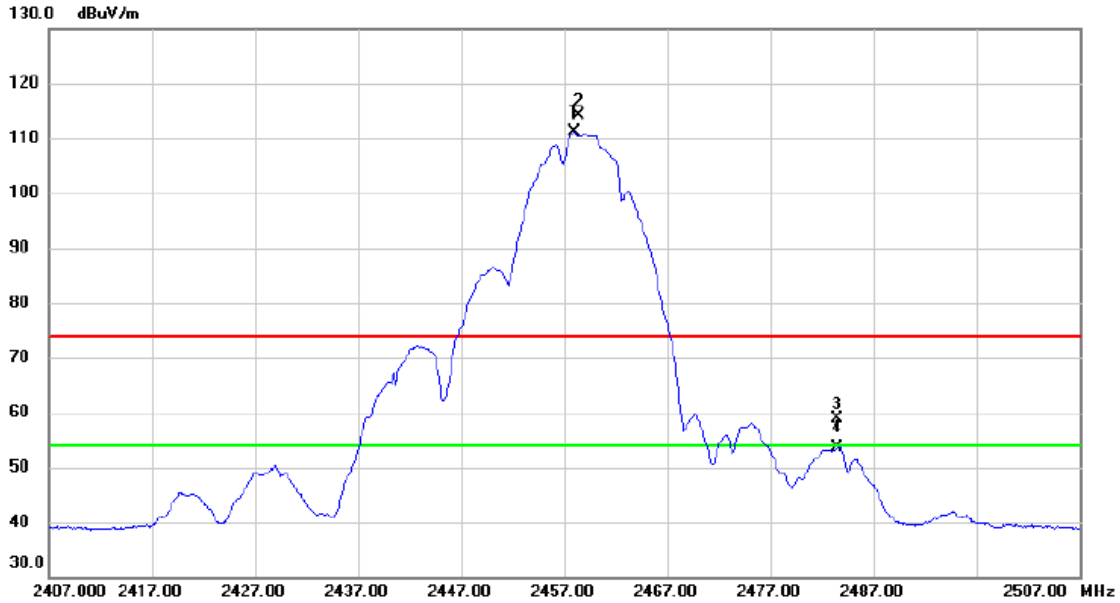

No.	Mk.	Freq. MHz	Reading Level dBuV	Correct Factor dB	Measure- ment dBuV/m	Limit dBuV/m	Margin dB	Detector	Comment
1	*	2458.000	103.37	7.79	111.16	54.00	57.16	AVG	No Limit
2	X	2458.450	106.45	7.79	114.24	74.00	40.24	peak	No Limit
3		2483.500	51.04	7.87	58.91	74.00	-15.09	peak	
4		2483.500	45.68	7.87	53.55	54.00	-0.45	AVG	

REMARKS:

- (1) Measurement Value = Reading Level + Correct Factor.
- (2) Margin Level = Measurement Value - Limit Value.

Orthogonal Axis	X
Test Mode:	TX B Mode 2457 MHz

Vertical

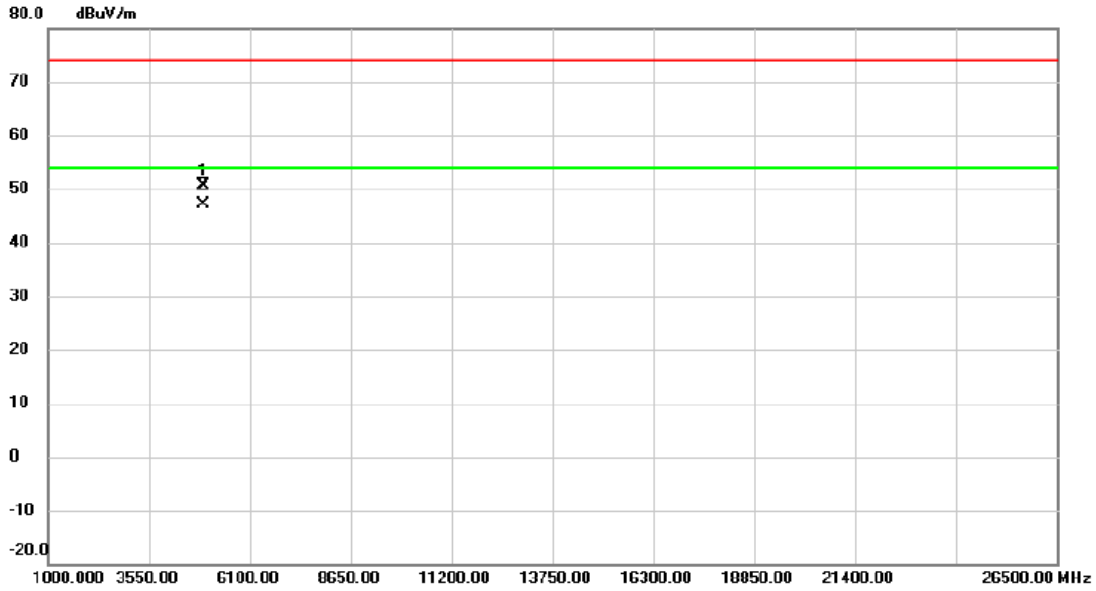

No.	Mk.	Freq. MHz	Reading Level dBuV	Correct Factor dB	Measure- ment dBuV/m	Limit dBuV/m	Margin dB	Detector	Comment
1		4913.862	45.99	4.58	50.57	74.00	-23.43	peak	
2	*	4914.013	42.58	4.58	47.16	54.00	-6.84	AVG	

REMARKS:

- (1) Measurement Value = Reading Level + Correct Factor.
- (2) Margin Level = Measurement Value - Limit Value.

Orthogonal Axis	X
Test Mode:	TX B Mode 2457 MHz

Horizontal

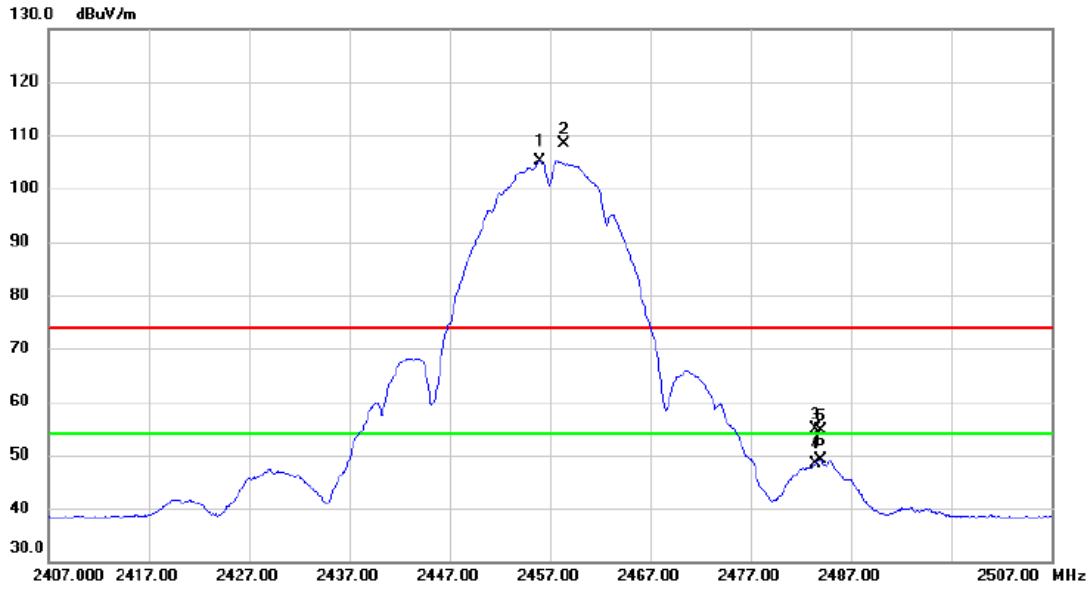

No.	Mk.	Freq. MHz	Reading Level dBuV	Correct Factor dB	Measure- ment dBuV/m	Limit dBuV/m	Margin dB	Detector	Comment
1	*	2456.000	97.37	7.78	105.15	54.00	51.15	AVG	No Limit
2	X	2458.350	100.69	7.79	108.48	74.00	34.48	peak	No Limit
3		2483.500	46.98	7.87	54.85	74.00	-19.15	peak	
4		2483.500	40.51	7.87	48.38	54.00	-5.62	AVG	
5		2484.000	46.73	7.87	54.60	74.00	-19.40	peak	
6		2484.000	41.26	7.87	49.13	54.00	-4.87	AVG	

REMARKS:

(1) Measurement Value = Reading Level + Correct Factor.

(2) Margin Level = Measurement Value - Limit Value.

Orthogonal Axis	X
Test Mode:	TX B Mode 2457 MHz

Horizontal

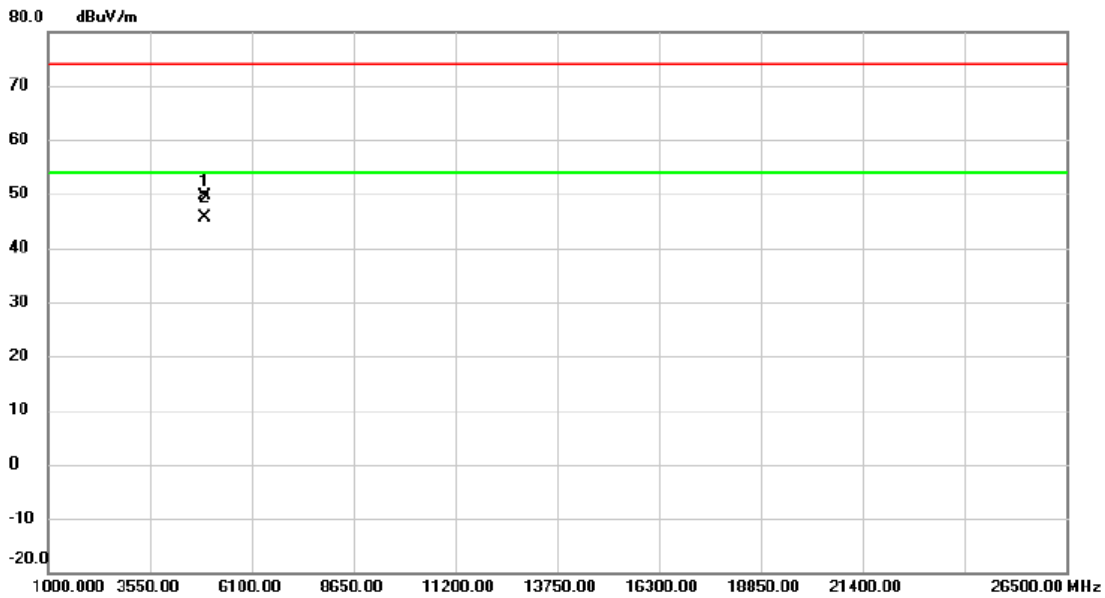

No.	Mk.	Freq. MHz	Reading Level dBuV	Correct Factor dB	Measure- ment dBuV/m	Limit dBuV/m	Margin dB	Detector	Comment
1		4913.861	44.96	4.58	49.54	74.00	-24.46	peak	
2	*	4913.920	41.08	4.58	45.66	54.00	-8.34	AVG	

REMARKS:

- (1) Measurement Value = Reading Level + Correct Factor.
- (2) Margin Level = Measurement Value - Limit Value.

Orthogonal Axis	X
Test Mode:	TX B Mode 2462 MHz

Vertical

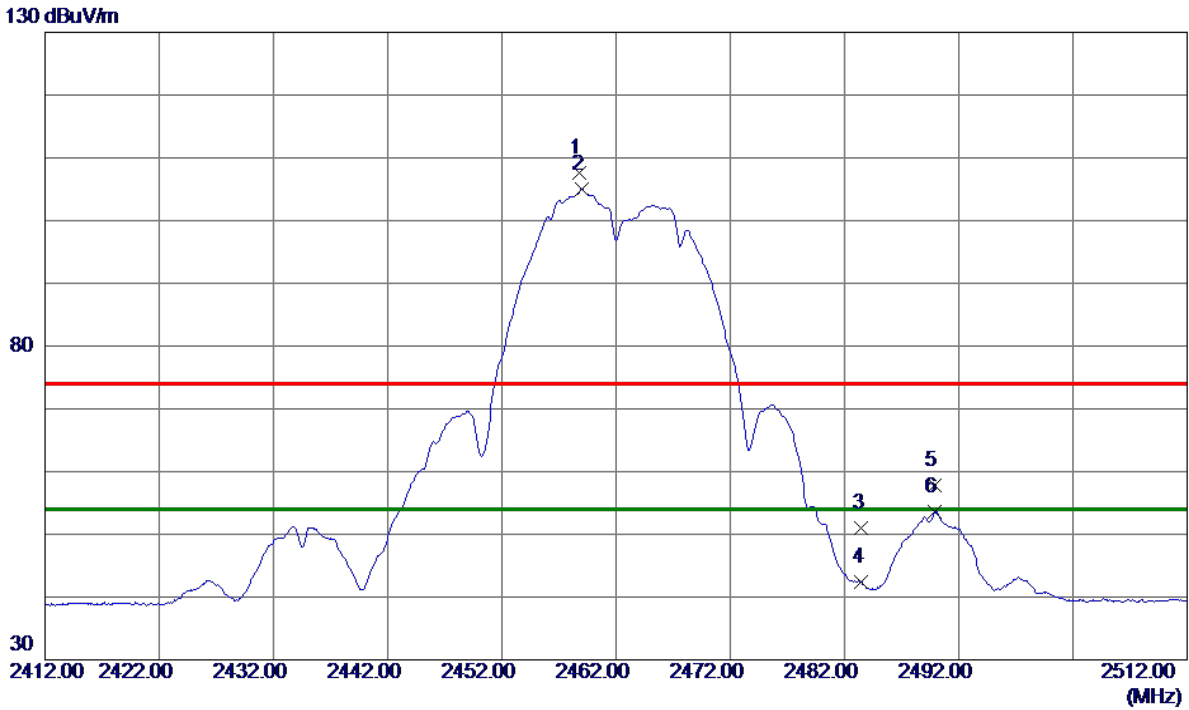

No.	Freq. MHz	Reading Level dBuV/m	Correct Factor dB	Measure ment dBuV/m	Limit dBuV/m	Margin dB	Detector	Comment
1	2458.8000	99.72	7.79	107.51	74.00	33.51	Peak	No Limit
2 *	2459.0000	97.28	7.79	105.07	54.00	51.07	AVG	No Limit
3	2483.5000	43.08	7.88	50.96	74.00	-23.04	Peak	
4	2483.5000	34.49	7.88	42.37	54.00	-11.63	AVG	
5	2489.9000	49.92	7.90	57.82	74.00	-16.18	Peak	
6	2489.9000	45.72	7.90	53.62	54.00	-0.38	AVG	

REMARKS:

- (1) Measurement Value = Reading Level + Correct Factor.
- (2) Margin Level = Measurement Value - Limit Value.

Orthogonal Axis	X
Test Mode:	TX B Mode 2462 MHz

Vertical

80 dBuV/m

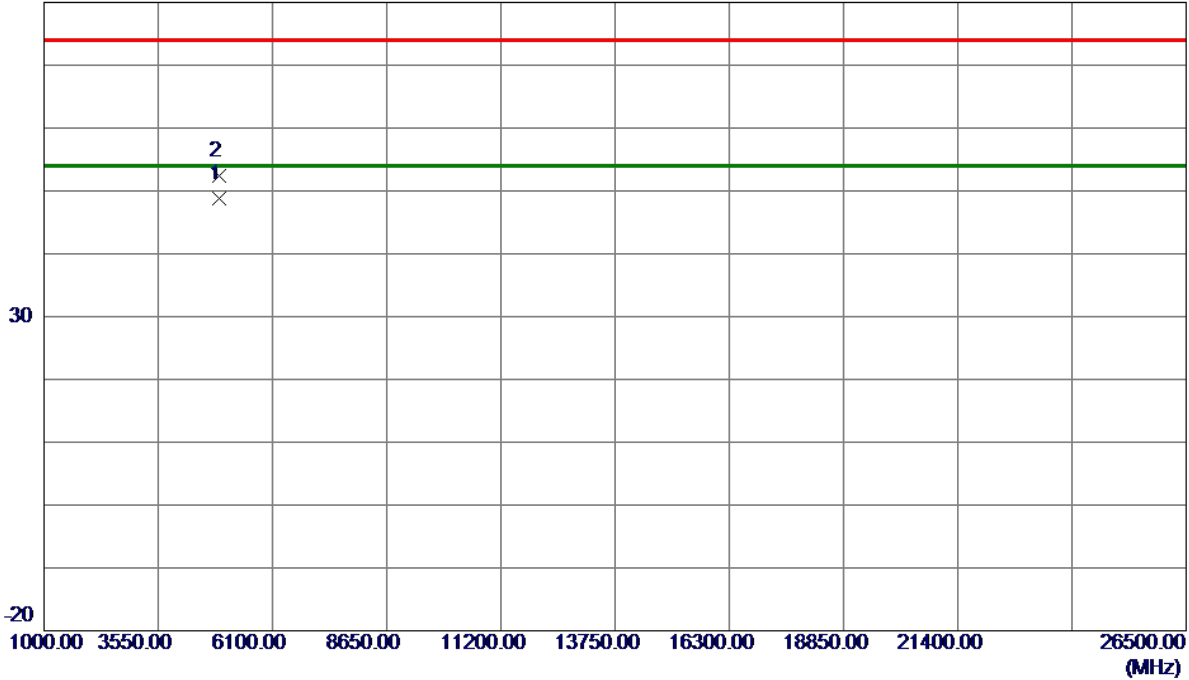

No.	Freq. MHz	Reading Level dBuV/m	Correct Factor dB	Measure ment dBuV/m	Limit dBuV/m	Margin dB	Detector	Comment
1 *	4923.9340	44.20	4.63	48.83	54.00	-5.17	AVG	
2	4924.0150	47.70	4.63	52.33	74.00	-21.67	Peak	

REMARKS:

- (1) Measurement Value = Reading Level + Correct Factor.
- (2) Margin Level = Measurement Value - Limit Value.

Orthogonal Axis	X
Test Mode:	TX B Mode 2462 MHz

Horizontal

130 dBuV/m

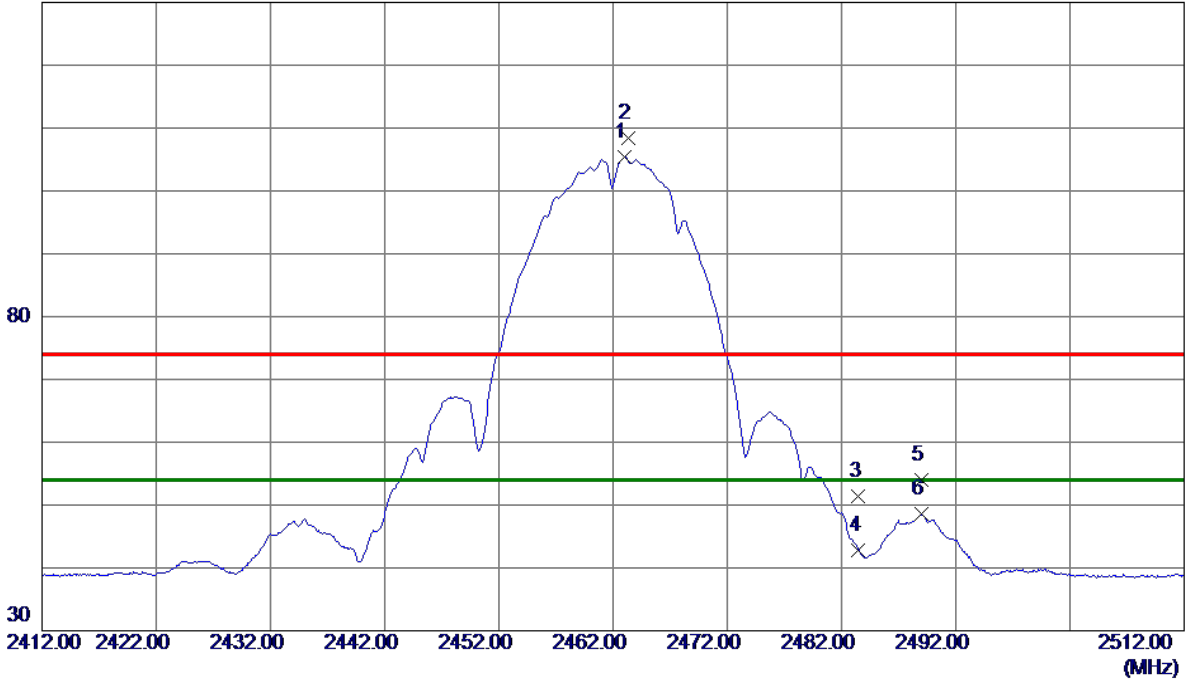

No.	Freq. MHz	Reading Level dBuV/m	Correct Factor dB	Measure ment dBuV/m	Limit dBuV/m	Margin dB	Detector	Comment
1 *	2463.0000	97.67	7.81	105.48	54.00	51.48	AVG	No Limit
2	2463.3500	100.56	7.81	108.37	74.00	34.37	Peak	No Limit
3	2483.5000	43.51	7.88	51.39	74.00	-22.61	Peak	
4	2483.5000	34.98	7.88	42.86	54.00	-11.14	AVG	
5	2489.0000	46.16	7.89	54.05	74.00	-19.95	Peak	
6	2489.0000	40.68	7.89	48.57	54.00	-5.43	AVG	

REMARKS:

- (1) Measurement Value = Reading Level + Correct Factor.
- (2) Margin Level = Measurement Value - Limit Value.

Orthogonal Axis	X
Test Mode:	TX B Mode 2462 MHz

Horizontal

80 dBuV/m

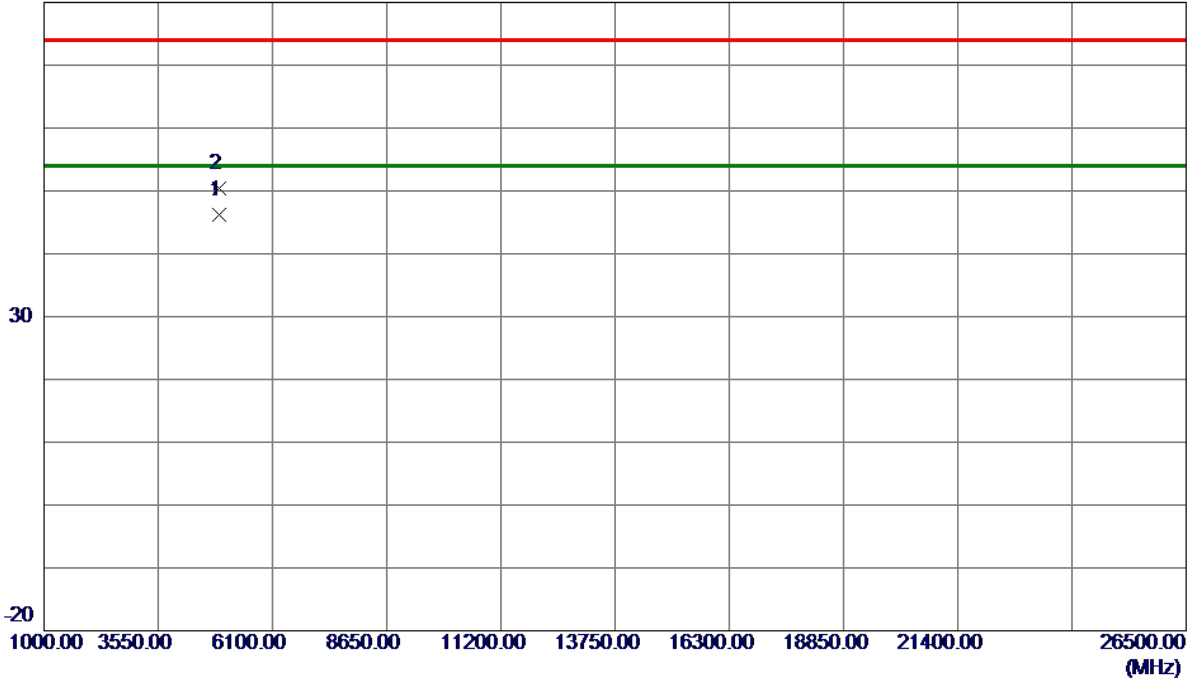

No.	Freq. MHz	Reading Level dBuV/m	Correct Factor dB	Measure ment dBuV/m	Limit dBuV/m	Margin dB	Detector	Comment
1 *	4923.9240	41.60	4.63	46.23	54.00	-7.77	AVG	
2	4923.9790	45.82	4.63	50.45	74.00	-23.55	Peak	

REMARKS:

(1) Measurement Value = Reading Level + Correct Factor.

(2) Margin Level = Measurement Value - Limit Value.

Orthogonal Axis	X
Test Mode:	TX G Mode 2412 MHz

Vertical

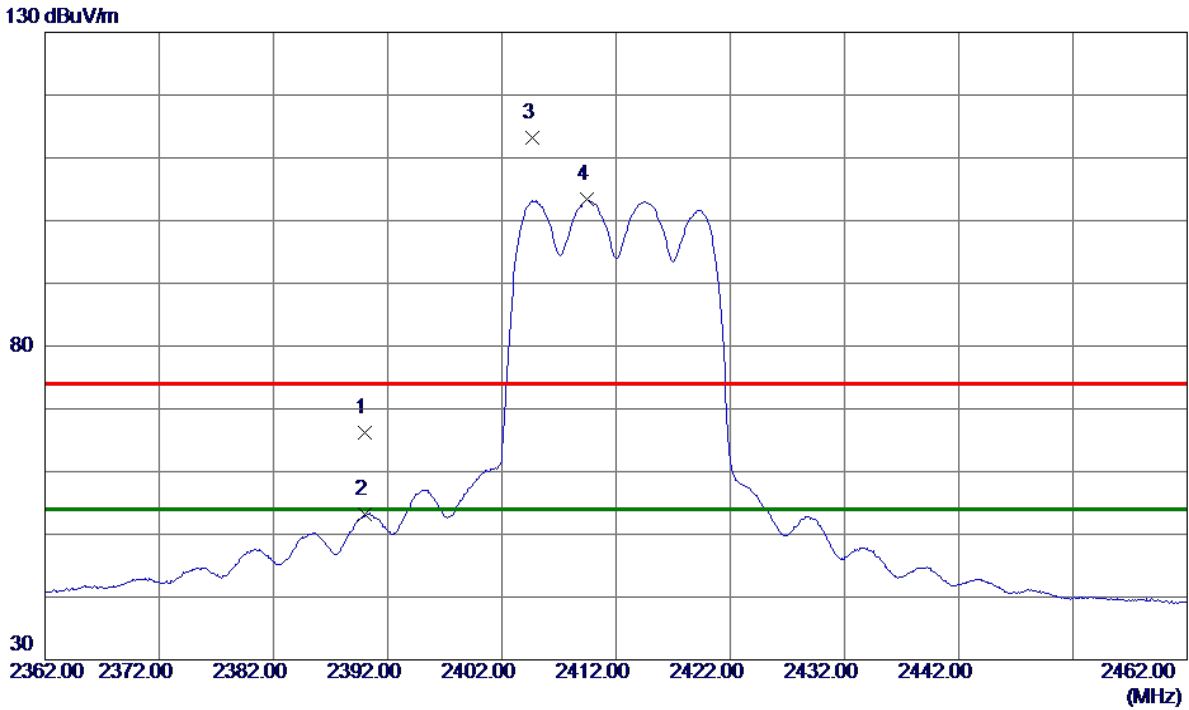

No.	Freq. MHz	Reading Level dBuV/m	Correct Factor dB	Measure ment dBuV/m	Limit dBuV/m	Margin dB	Detector	Comment
1	2390.0000	58.68	7.56	66.24	74.00	-7.76	Peak	
2	2390.0000	45.63	7.56	53.19	54.00	-0.81	AVG	
3	2404.6500	105.59	7.61	113.20	74.00	39.20	Peak	No Limit
4 *	2409.4500	95.71	7.63	103.34	54.00	49.34	AVG	No Limit

REMARKS:

- (1) Measurement Value = Reading Level + Correct Factor.
- (2) Margin Level = Measurement Value - Limit Value.

Orthogonal Axis	X
Test Mode:	TX G Mode 2412 MHz

Vertical

80 dBuV/m

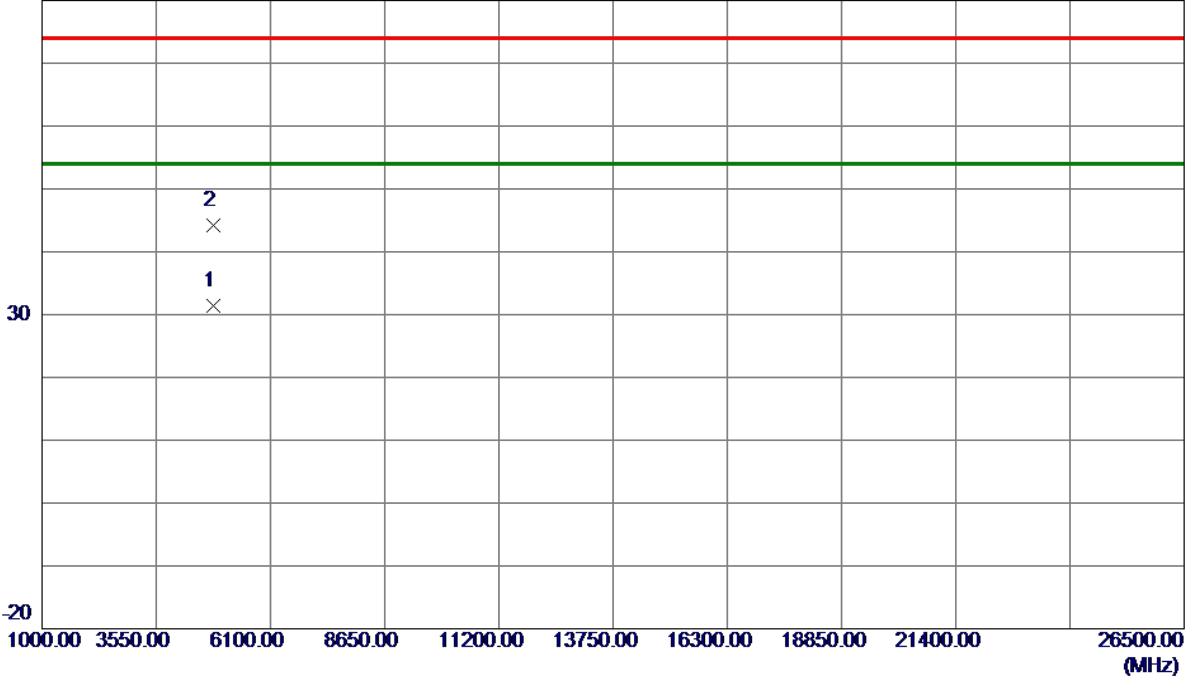

No.	Freq. MHz	Reading Level dBuV/m	Correct Factor dB	Measure ment dBuV/m	Limit dBuV/m	Margin dB	Detector	Comment
1 *	4823.9980	27.15	4.26	31.41	54.00	-22.59	AVG	
2	4825.3020	39.88	4.26	44.14	74.00	-29.86	Peak	

REMARKS:

- (1) Measurement Value = Reading Level + Correct Factor.
- (2) Margin Level = Measurement Value - Limit Value.

Orthogonal Axis	X
Test Mode:	TX G Mode 2412 MHz

Horizontal

130 dBuV/m

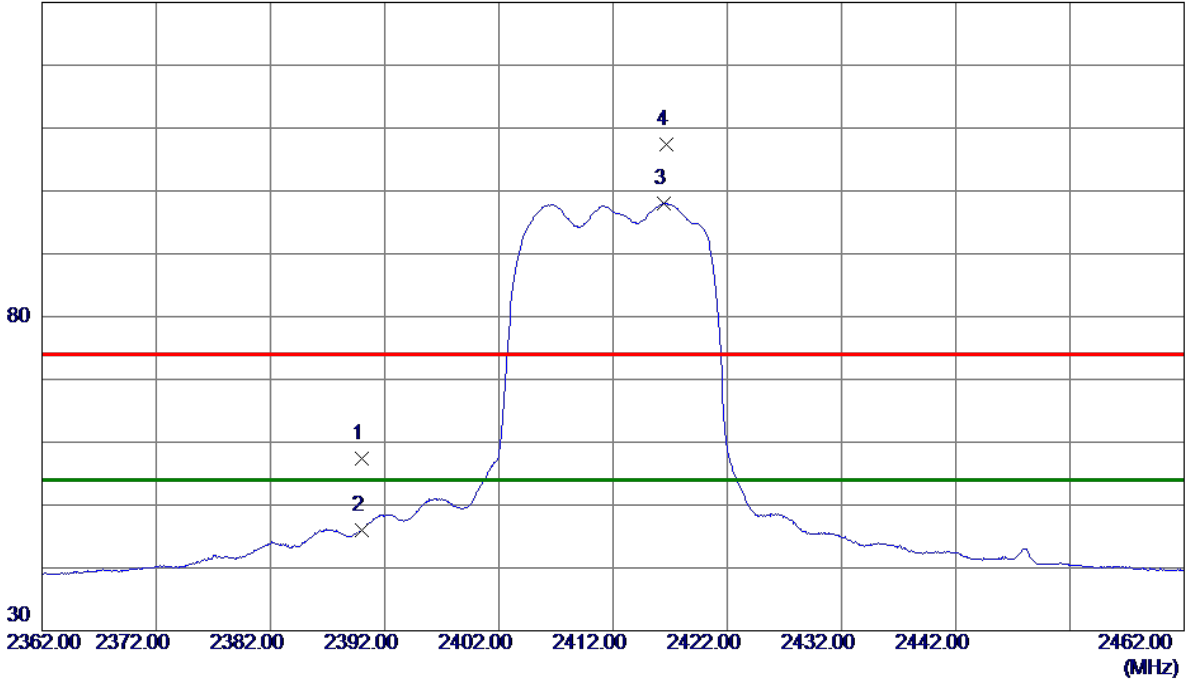

No.	Freq. MHz	Reading Level dBuV/m	Correct Factor dB	Measure ment dBuV/m	Limit dBuV/m	Margin dB	Detector	Comment
1	2390.0000	49.85	7.56	57.41	74.00	-16.59	Peak	
2	2390.0000	38.47	7.56	46.03	54.00	-7.97	AVG	
3 *	2416.4500	90.43	7.65	98.08	54.00	44.08	AVG	No Limit
4	2416.7000	99.71	7.65	107.36	74.00	33.36	Peak	No Limit

REMARKS:

- (1) Measurement Value = Reading Level + Correct Factor.
- (2) Margin Level = Measurement Value - Limit Value.

Orthogonal Axis	X
Test Mode:	TX G Mode 2412 MHz

Horizontal

80 dBuV/m

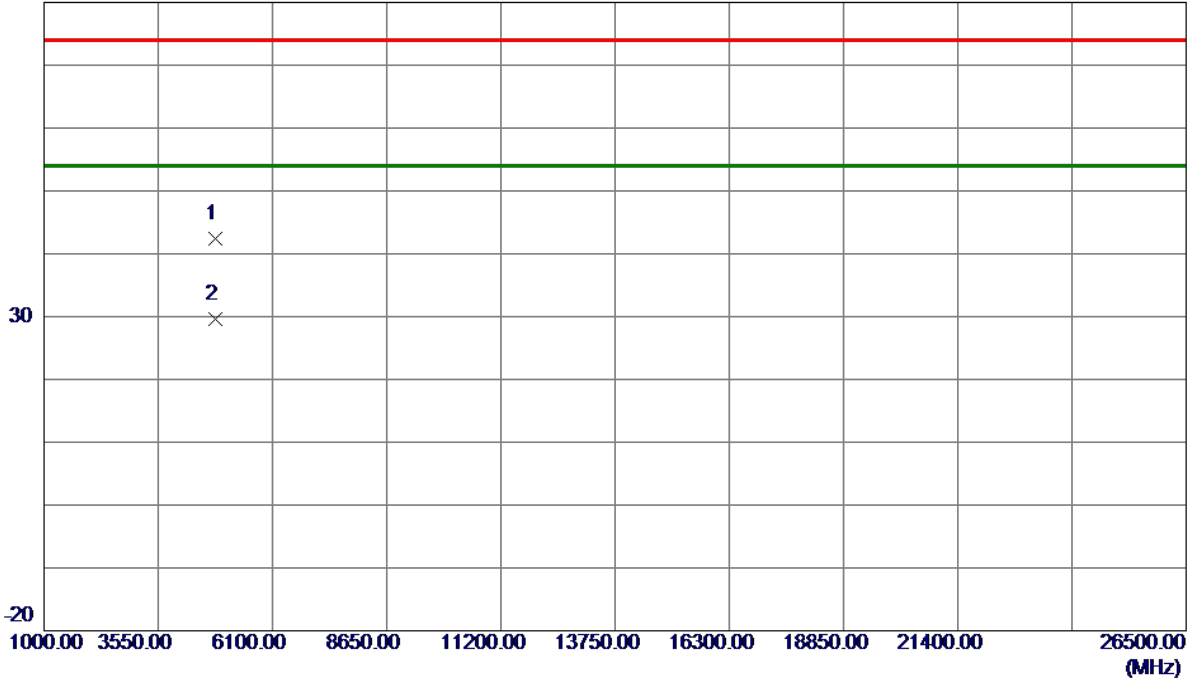

No.	Freq. MHz	Reading Level dBuV/m	Correct Factor dB	Measure ment dBuV/m	Limit dBuV/m	Margin dB	Detector	Comment
1	4822.5970	38.07	4.25	42.32	74.00	-31.68	Peak	
2 *	4823.8900	25.30	4.25	29.55	54.00	-24.45	AVG	

REMARKS:

(1) Measurement Value = Reading Level + Correct Factor.

(2) Margin Level = Measurement Value - Limit Value.

Orthogonal Axis	X
Test Mode:	TX G Mode 2417 MHz

Vertical

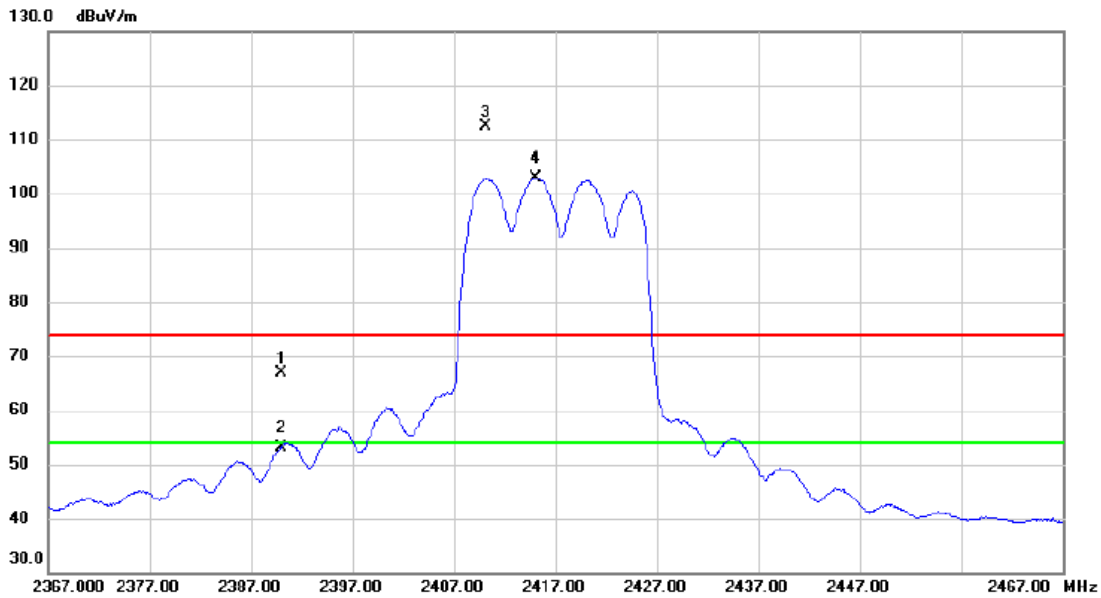

No.	Mk.	Freq. MHz	Reading Level dBuV	Correct Factor dB	Measure- ment dBuV/m	Limit dBuV/m	Margin dB	Detector	Comment
1		2390.000	59.42	7.57	66.99	74.00	-7.01	peak	
2		2390.000	45.65	7.57	53.22	54.00	-0.78	AVG	
3	X	2410.150	104.70	7.63	112.33	74.00	38.33	peak	No Limit
4	*	2415.050	95.26	7.65	102.91	54.00	48.91	AVG	No Limit

REMARKS:

- (1) Measurement Value = Reading Level + Correct Factor.
- (2) Margin Level = Measurement Value - Limit Value.

Orthogonal Axis	X
Test Mode:	TX G Mode 2417 MHz

Vertical

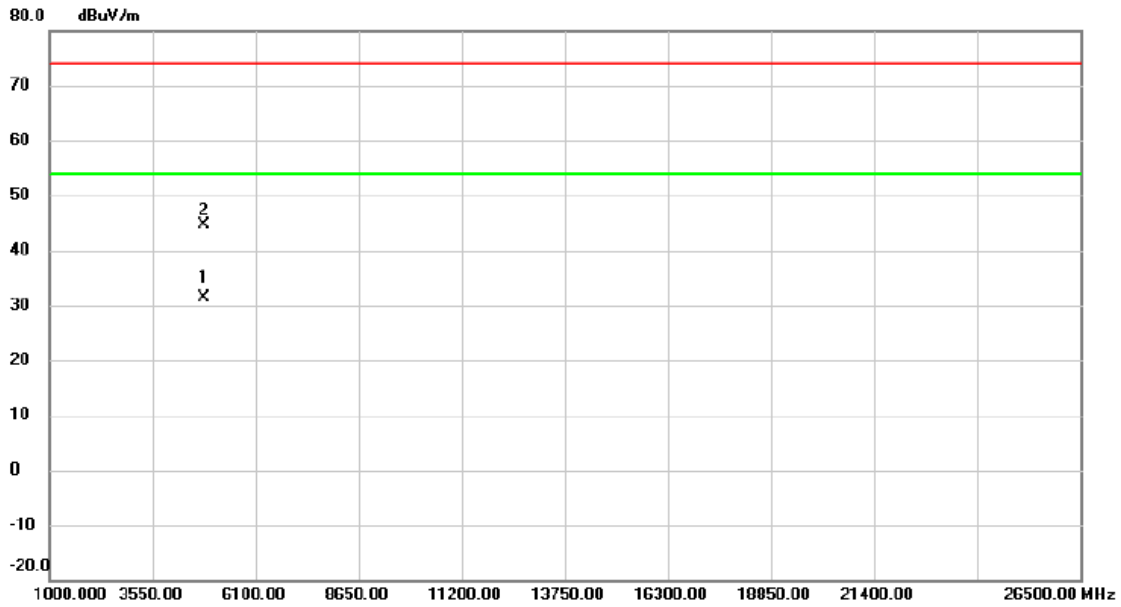

No.	Mk.	Freq. MHz	Reading Level dBuV	Correct Factor dB	Measure- ment dBuV/m	Limit dBuV/m	Margin dB	Detector	Comment
1	*	4834.273	27.20	4.29	31.49	54.00	-22.51	AVG	
2		4835.363	40.25	4.30	44.55	74.00	-29.45	peak	

REMARKS:

- (1) Measurement Value = Reading Level + Correct Factor.
- (2) Margin Level = Measurement Value - Limit Value.

Orthogonal Axis	X
Test Mode:	TX G Mode 2417 MHz

Horizontal

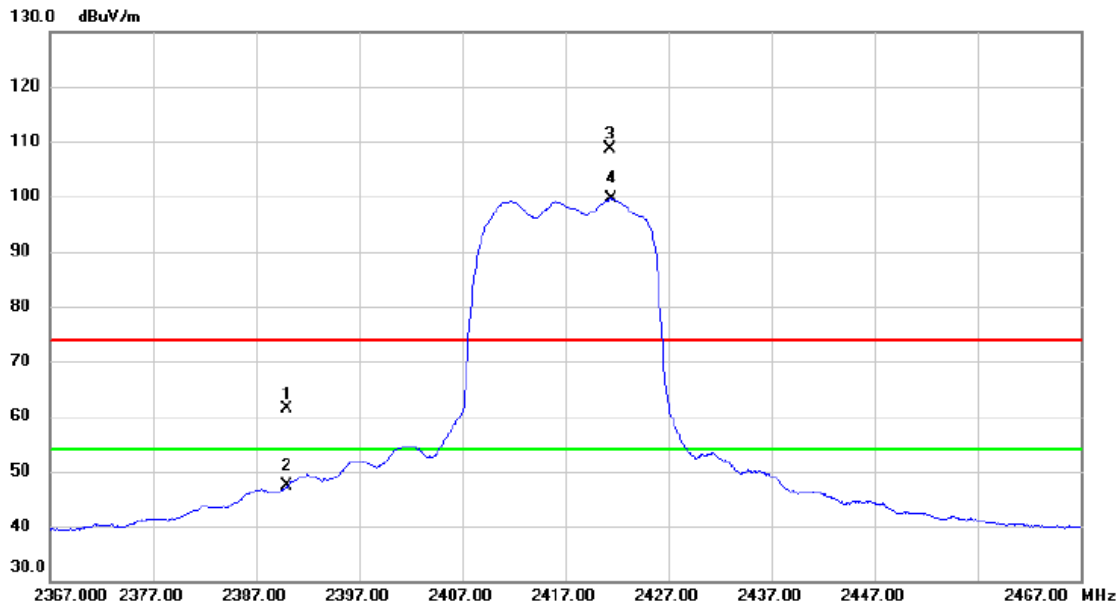

No.	Mk.	Freq. MHz	Reading Level dBuV	Correct Factor dB	Measure- ment dBuV/m	Limit dBuV/m	Margin dB	Detector	Comment
1		2390.000	53.84	7.57	61.41	74.00	-12.59	peak	
2		2390.000	39.74	7.57	47.31	54.00	-6.69	AVG	
3	X	2421.300	100.91	7.67	108.58	74.00	34.58	peak	No Limit
4	*	2421.400	91.86	7.67	99.53	54.00	45.53	AVG	No Limit

REMARKS:

- (1) Measurement Value = Reading Level + Correct Factor.
- (2) Margin Level = Measurement Value - Limit Value.

Orthogonal Axis	X
Test Mode:	TX G Mode 2417 MHz

Horizontal

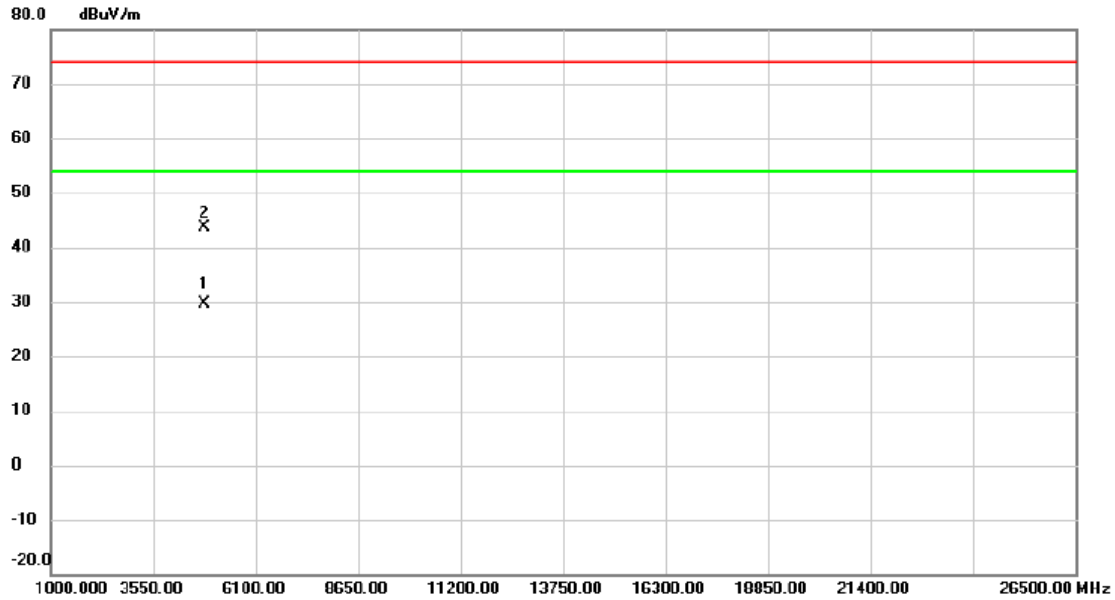

No.	Mk.	Freq. MHz	Reading Level dBuV	Correct Factor dB	Measure- ment dBuV/m	Limit dBuV/m	Margin dB	Detector	Comment
1	*	4834.015	25.22	4.29	29.51	54.00	-24.49	AVG	
2		4835.010	39.21	4.30	43.51	74.00	-30.49	peak	

REMARKS:

- (1) Measurement Value = Reading Level + Correct Factor.
- (2) Margin Level = Measurement Value - Limit Value.

Orthogonal Axis	X
Test Mode:	TX G Mode 2437 MHz

Vertical

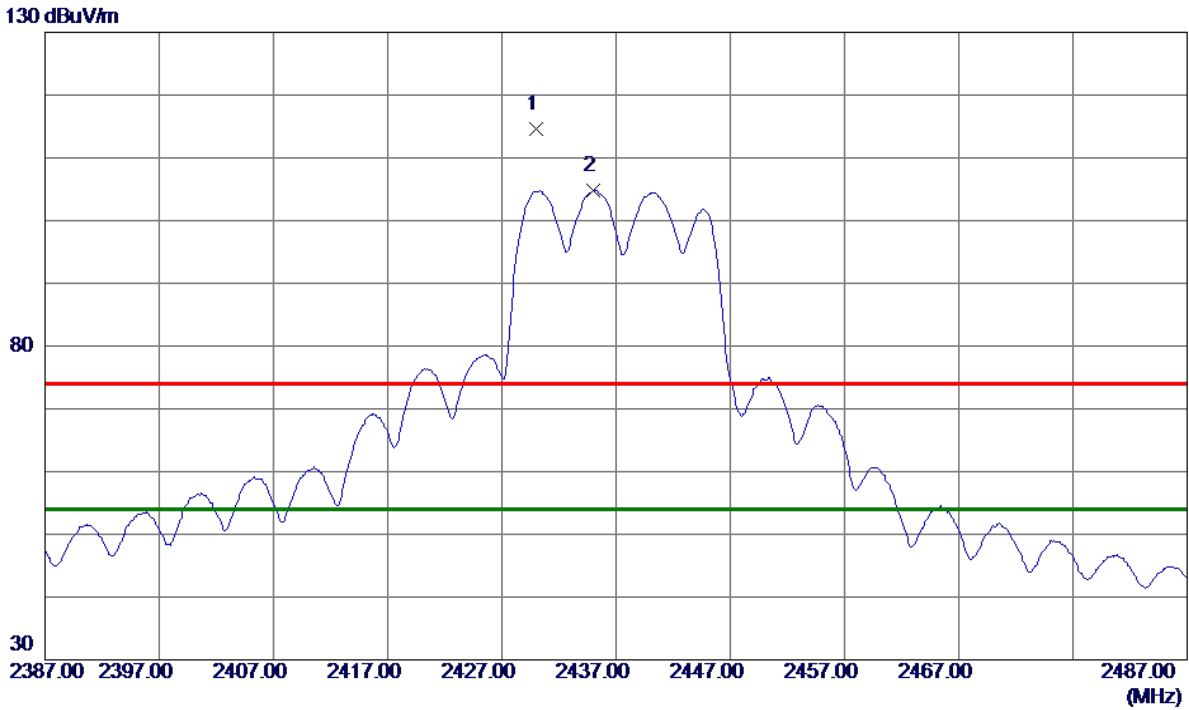

No.	Freq. MHz	Reading Level dBuV/m	Correct Factor dB	Measure ment dBuV/m	Limit dBuV/m	Margin dB	Detector	Comment
1	2430.0500	106.91	7.70	114.61	74.00	40.61	Peak	No Limit
2 *	2435.0500	97.08	7.71	104.79	54.00	50.79	AVG	No Limit

REMARKS:

- (1) Measurement Value = Reading Level + Correct Factor.
- (2) Margin Level = Measurement Value - Limit Value.

Orthogonal Axis	X
Test Mode:	TX G Mode 2437 MHz

Vertical

80 dBuV/m

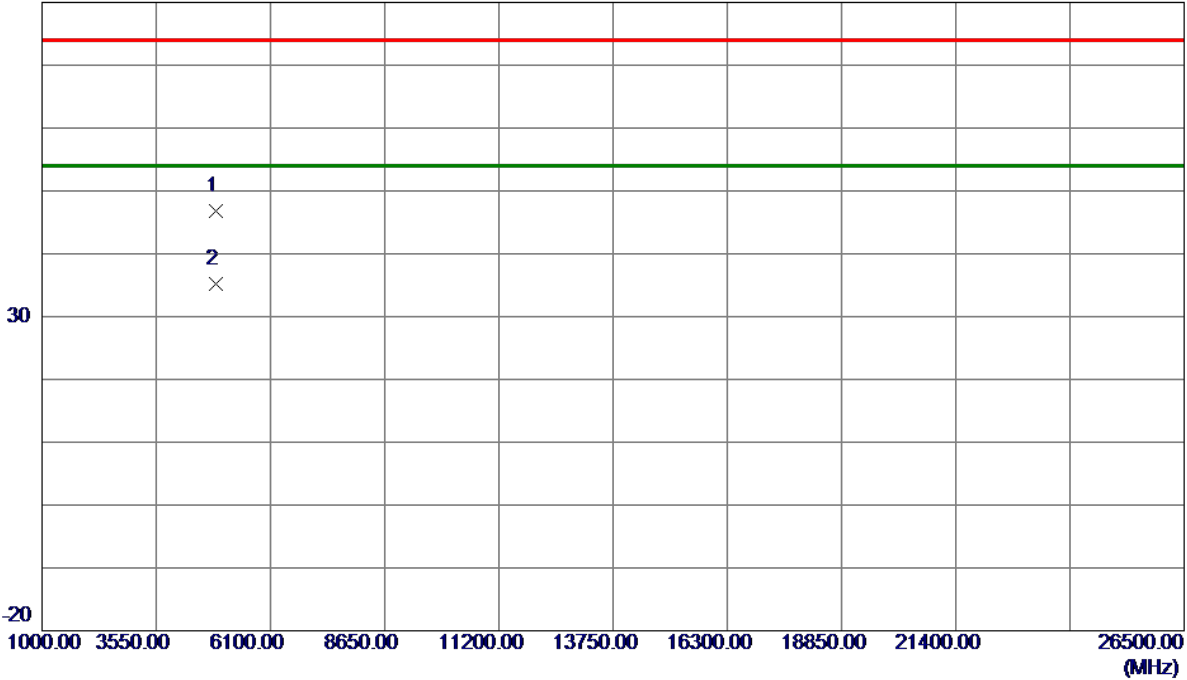

No.	Freq. MHz	Reading Level dBuV/m	Correct Factor dB	Measure ment dBuV/m	Limit dBuV/m	Margin dB	Detector	Comment
1	4874.1500	42.27	4.44	46.71	74.00	-27.29	Peak	
2 *	4874.3000	30.85	4.44	35.29	54.00	-18.71	AVG	

REMARKS:

- (1) Measurement Value = Reading Level + Correct Factor.
- (2) Margin Level = Measurement Value - Limit Value.

Orthogonal Axis	X
Test Mode:	TX G Mode 2437 MHz

Horizontal

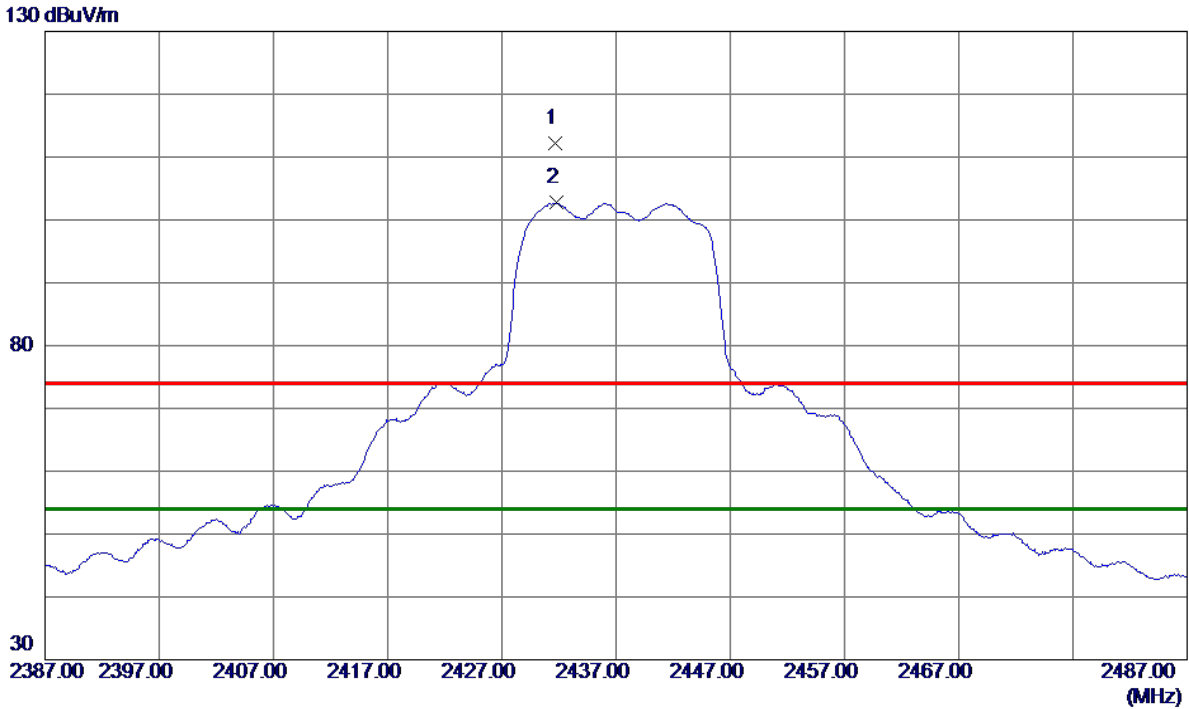

No.	Freq. MHz	Reading Level dBuV/m	Correct Factor dB	Measure ment dBuV/m	Limit dBuV/m	Margin dB	Detector	Comment
1	2431.6500	104.44	7.70	112.14	74.00	38.14	Peak	No Limit
2 *	2431.8000	95.01	7.70	102.71	54.00	48.71	AVG	No Limit

REMARKS:

- (1) Measurement Value = Reading Level + Correct Factor.
- (2) Margin Level = Measurement Value - Limit Value.

Orthogonal Axis	X
Test Mode:	TX G Mode 2437 MHz

Horizontal

80 dBuV/m

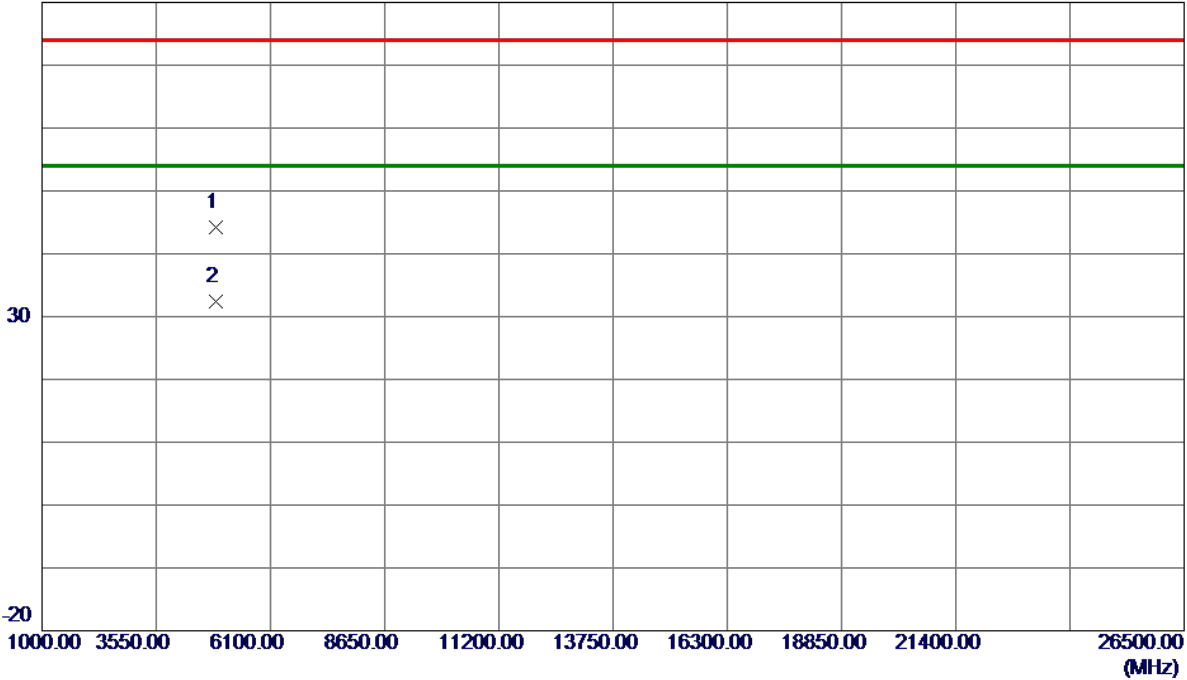

No.	Freq. MHz	Reading Level dBuV/m	Correct Factor dB	Measure ment dBuV/m	Limit dBuV/m	Margin dB	Detector	Comment
1	4870.7000	39.79	4.43	44.22	74.00	-29.78	Peak	
2 *	4874.2500	28.03	4.44	32.47	54.00	-21.53	AVG	

REMARKS:

(1) Measurement Value = Reading Level + Correct Factor.

(2) Margin Level = Measurement Value - Limit Value.

Orthogonal Axis	X
Test Mode:	TX G Mode 2457 MHz

Vertical

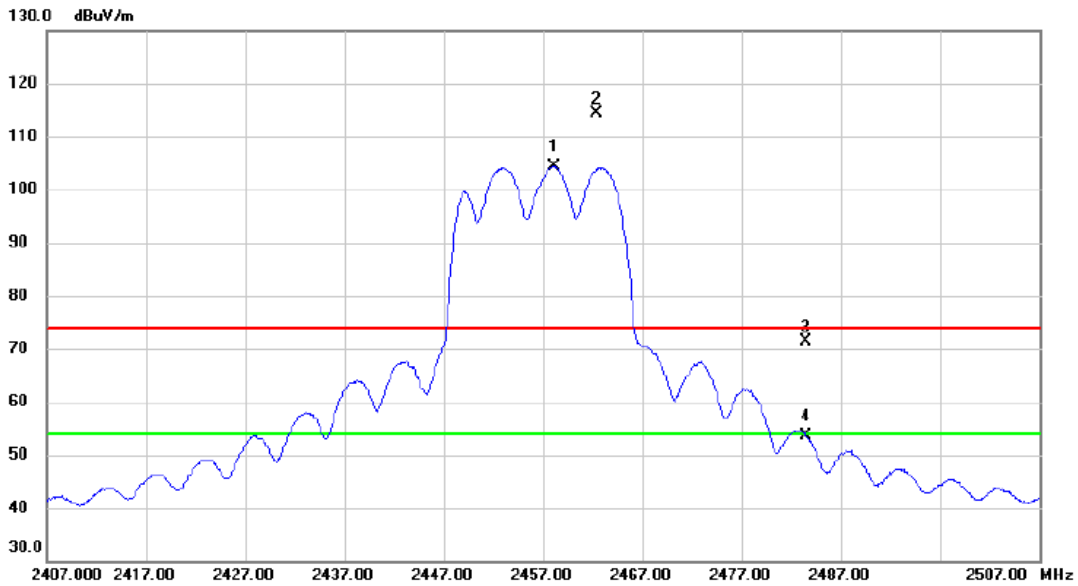

No.	Mk.	Freq. MHz	Reading Level dBuV	Correct Factor dB	Measure- ment dBuV/m	Limit dBuV/m	Margin dB	Detector	Comment
1	*	2458.150	96.66	7.79	104.45	54.00	50.45	AVG	No Limit
2	X	2462.450	106.50	7.80	114.30	74.00	40.30	peak	No Limit
3		2483.500	63.45	7.87	71.32	74.00	-2.68	peak	
4		2483.500	45.83	7.87	53.70	54.00	-0.30	AVG	

REMARKS:

- (1) Measurement Value = Reading Level + Correct Factor.
- (2) Margin Level = Measurement Value - Limit Value.

Orthogonal Axis	X
Test Mode:	TX G Mode 2457 MHz

Vertical

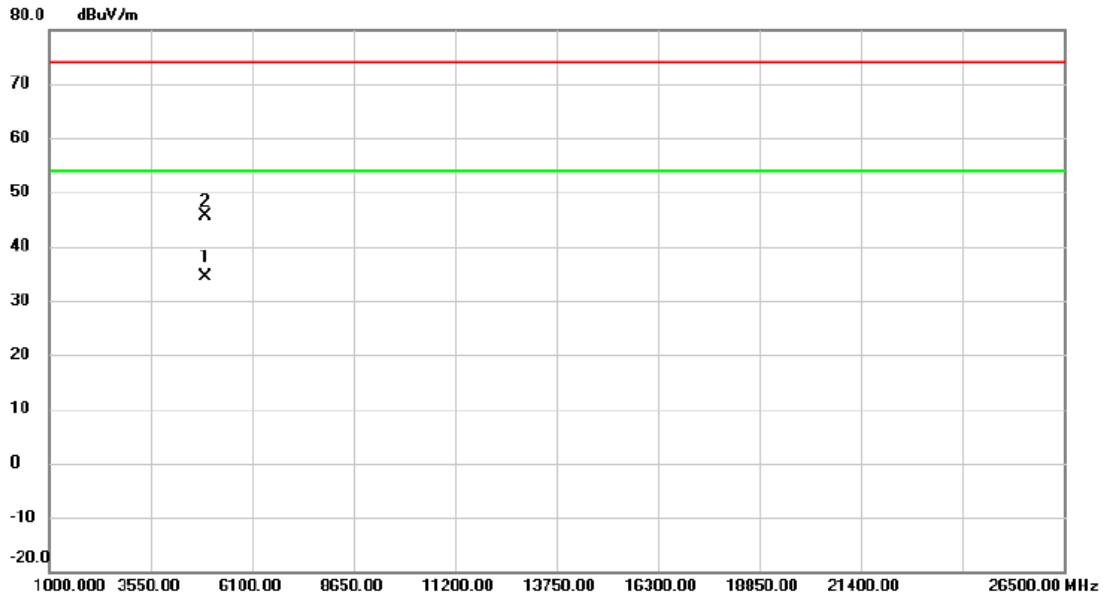

No.	Mk.	Freq. MHz	Reading Level dBuV	Correct Factor dB	Measure- ment dBuV/m	Limit dBuV/m	Margin dB	Detector	Comment
1	*	4914.300	29.77	4.58	34.35	54.00	-19.65	AVG	
2		4914.875	40.99	4.59	45.58	74.00	-28.42	peak	

REMARKS:

- (1) Measurement Value = Reading Level + Correct Factor.
- (2) Margin Level = Measurement Value - Limit Value.

Orthogonal Axis	X
Test Mode:	TX G Mode 2457 MHz

Horizontal

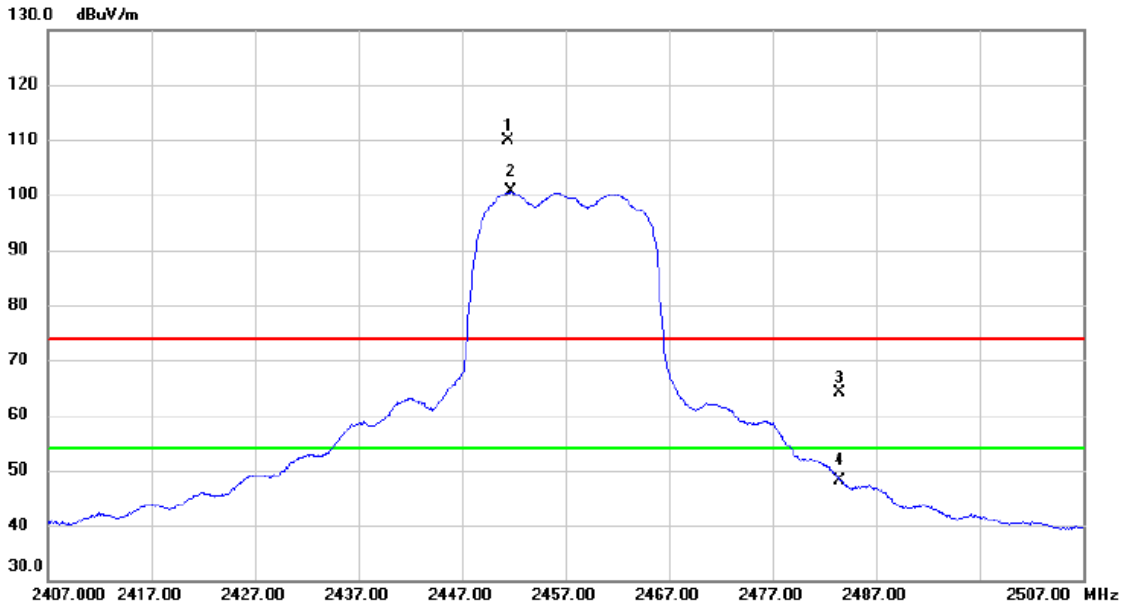

No.	Mk.	Freq. MHz	Reading Level dBuV	Correct Factor dB	Measure- ment dBuV/m	Limit dBuV/m	Margin dB	Detector	Comment
1	X	2451.500	102.16	7.77	109.93	74.00	35.93	peak	No Limit
2	*	2451.700	92.80	7.77	100.57	54.00	46.57	AVG	No Limit
3		2483.500	56.14	7.87	64.01	74.00	-9.99	peak	
4		2483.500	40.33	7.87	48.20	54.00	-5.80	AVG	

REMARKS:

- (1) Measurement Value = Reading Level + Correct Factor.
- (2) Margin Level = Measurement Value - Limit Value.

Orthogonal Axis	X
Test Mode:	TX G Mode 2457 MHz

Horizontal

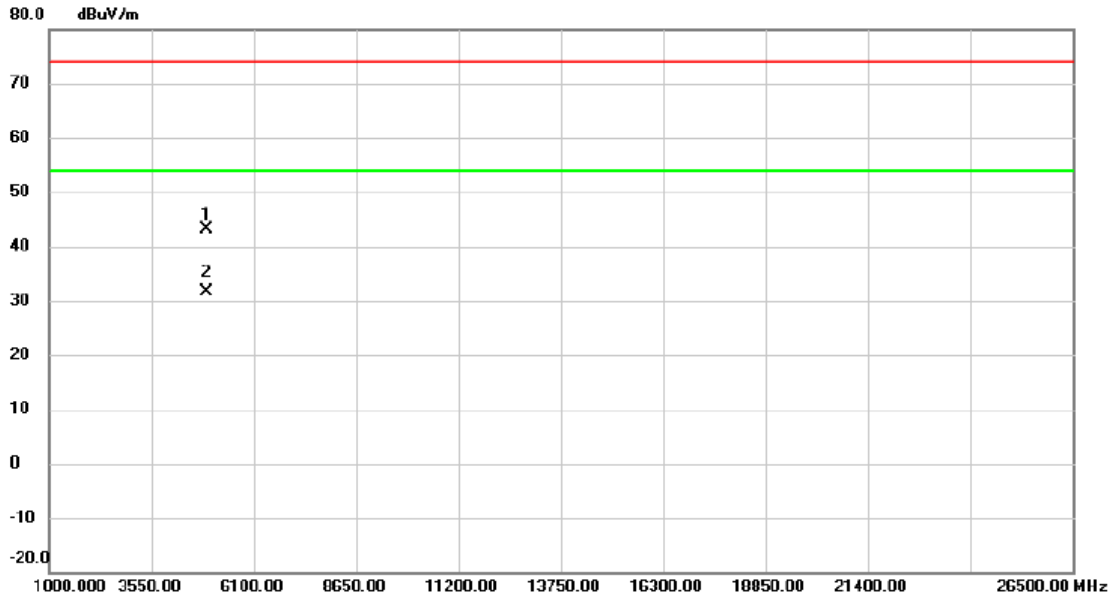

No.	Mk.	Freq. MHz	Reading Level dBuV	Correct Factor dB	Measure- ment dBuV/m	Limit dBuV/m	Margin dB	Detector	Comment
1		4910.050	38.43	4.58	43.01	74.00	-30.99	peak	
2	*	4910.525	26.94	4.58	31.52	54.00	-22.48	AVG	

REMARKS:

- (1) Measurement Value = Reading Level + Correct Factor.
- (2) Margin Level = Measurement Value - Limit Value.

Orthogonal Axis	X
Test Mode:	TX G Mode 2462 MHz

Vertical

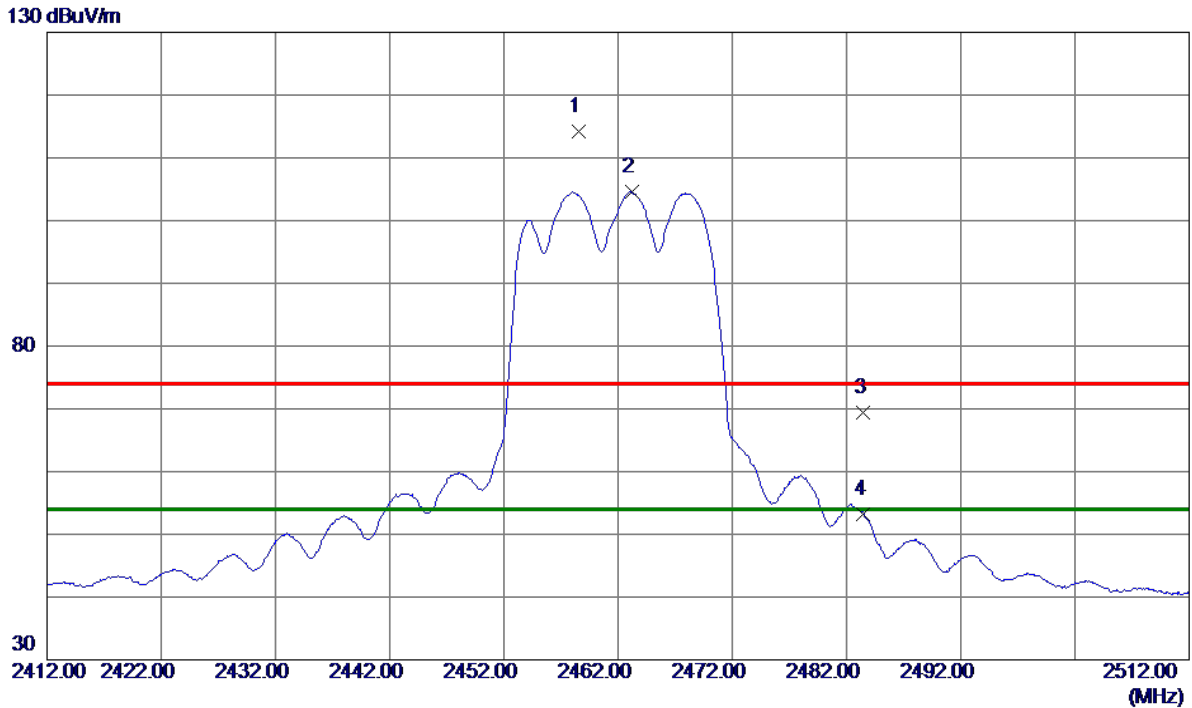

No.	Freq. MHz	Reading Level dBuV/m	Correct Factor dB	Measure ment dBuV/m	Limit dBuV/m	Margin dB	Detector	Comment
1	2458.6000	106.36	7.79	114.15	74.00	40.15	Peak	No Limit
2 *	2463.2000	96.82	7.81	104.63	54.00	50.63	AVG	No Limit
3	2483.5000	61.54	7.88	69.42	74.00	-4.58	Peak	
4	2483.5000	45.33	7.88	53.21	54.00	-0.79	AVG	

REMARKS:

- (1) Measurement Value = Reading Level + Correct Factor.
- (2) Margin Level = Measurement Value - Limit Value.

Orthogonal Axis	X
Test Mode:	TX G Mode 2462 MHz

Vertical

80 dBuV/m

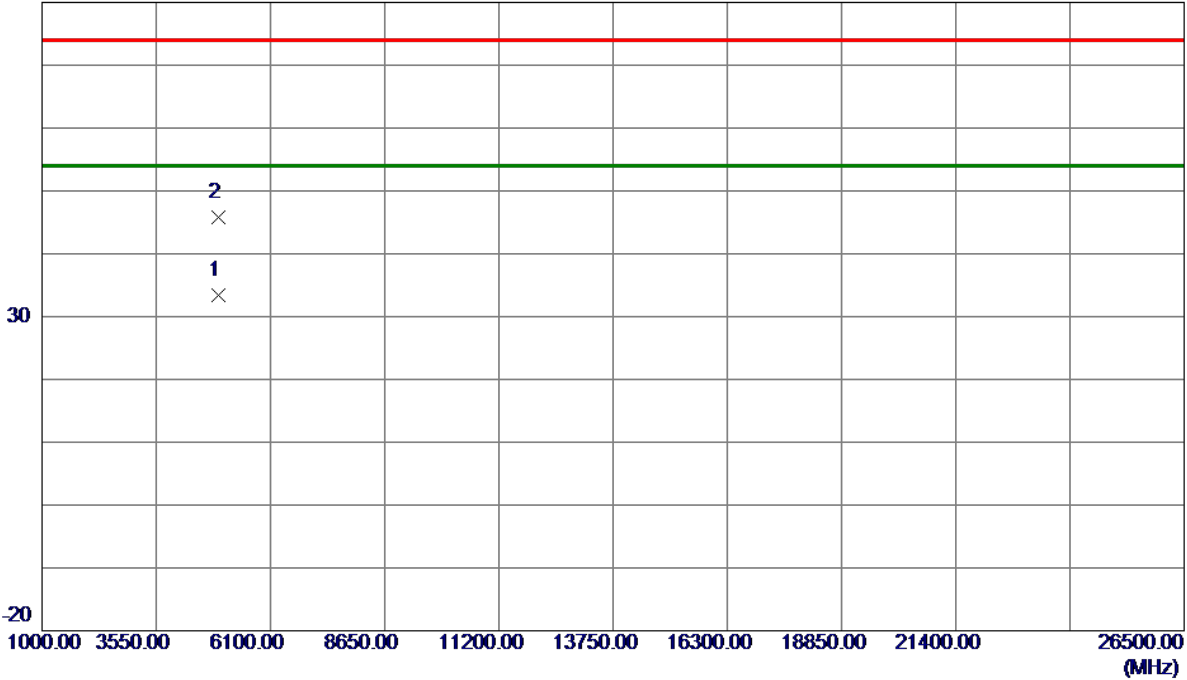

No.	Freq. MHz	Reading Level dBuV/m	Correct Factor dB	Measure ment dBuV/m	Limit dBuV/m	Margin dB	Detector	Comment
1 *	4924.3750	28.82	4.63	33.45	54.00	-20.55	AVG	
2	4935.1500	41.09	4.67	45.76	74.00	-28.24	Peak	

REMARKS:

- (1) Measurement Value = Reading Level + Correct Factor.
- (2) Margin Level = Measurement Value - Limit Value.

Orthogonal Axis	X
Test Mode:	TX G Mode 2462 MHz

Horizontal

130 dBuV/m

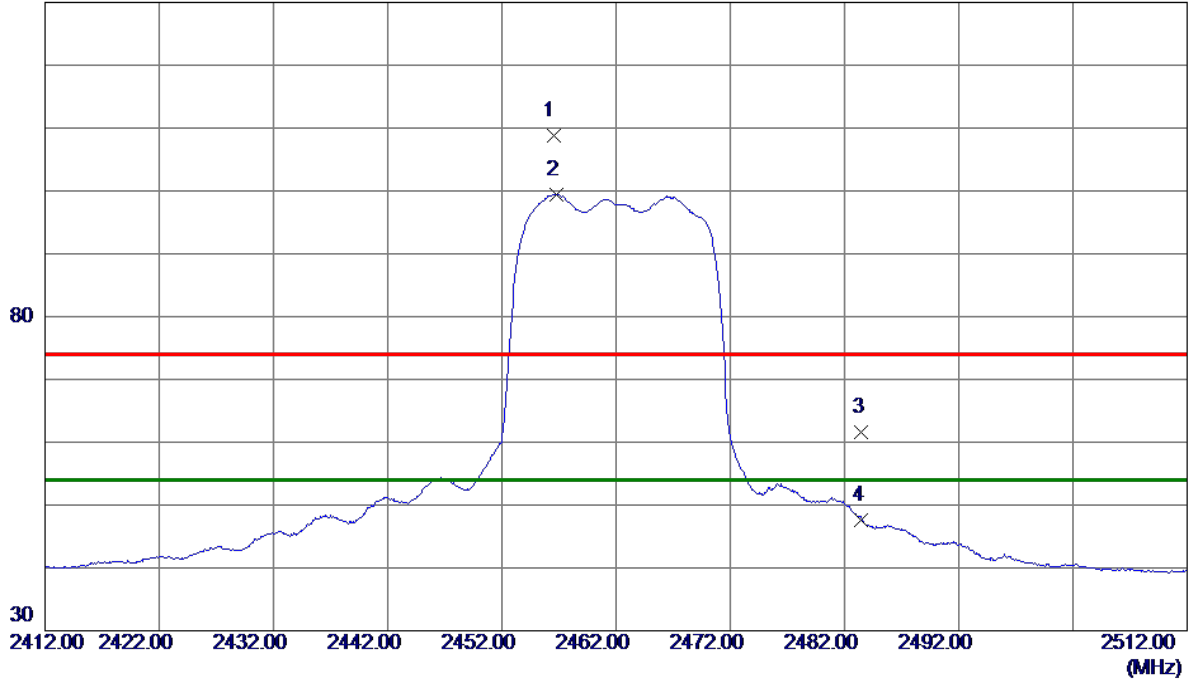

No.	Freq. MHz	Reading Level dBuV/m	Correct Factor dB	Measure ment dBuV/m	Limit dBuV/m	Margin dB	Detector	Comment
1	2456.5000	100.97	7.79	108.76	74.00	34.76	Peak	No Limit
2 *	2456.7500	91.68	7.79	99.47	54.00	45.47	AVG	No Limit
3	2483.5000	53.63	7.88	61.51	74.00	-12.49	Peak	
4	2483.5000	39.77	7.88	47.65	54.00	-6.35	AVG	

REMARKS:

- (1) Measurement Value = Reading Level + Correct Factor.
- (2) Margin Level = Measurement Value - Limit Value.

Orthogonal Axis	X
Test Mode:	TX G Mode 2462 MHz

Horizontal

80 dBuV/m

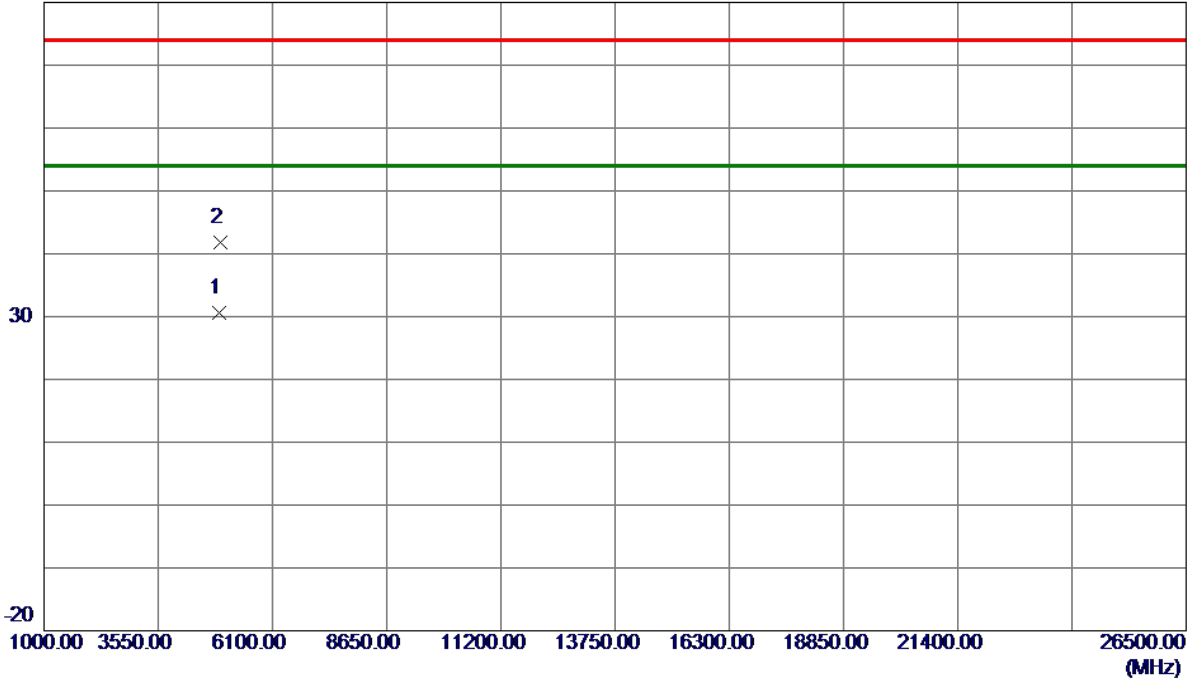

No.	Freq. MHz	Reading Level dBuV/m	Correct Factor dB	Measure ment dBuV/m	Limit dBuV/m	Margin dB	Detector	Comment
1 *	4924.0750	25.94	4.63	30.57	54.00	-23.43	AVG	
2	4928.9500	37.21	4.65	41.86	74.00	-32.14	Peak	

REMARKS:

- (1) Measurement Value = Reading Level + Correct Factor.
- (2) Margin Level = Measurement Value - Limit Value.

Orthogonal Axis	X
Test Mode:	TX N-20M Mode 2412 MHz

Vertical

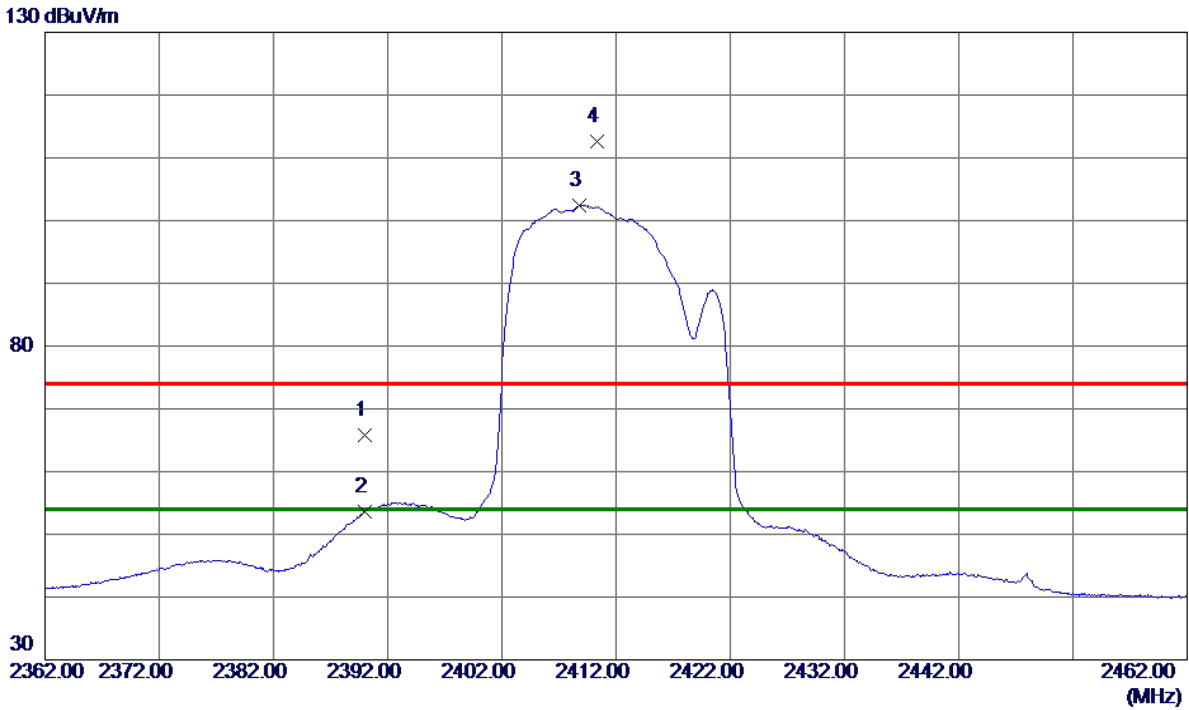

No.	Freq. MHz	Reading Level dBuV/m	Correct Factor dB	Measure ment dBuV/m	Limit dBuV/m	Margin dB	Detector	Comment
1	2390.0000	58.24	7.56	65.80	74.00	-8.20	Peak	
2	2390.0000	46.07	7.56	53.63	54.00	-0.37	AVG	
3 *	2408.8000	94.85	7.63	102.48	54.00	48.48	AVG	No Limit
4	2410.3500	104.91	7.63	112.54	74.00	38.54	Peak	No Limit

REMARKS:

- (1) Measurement Value = Reading Level + Correct Factor.
- (2) Margin Level = Measurement Value - Limit Value.

Orthogonal Axis	X
Test Mode:	TX N-20M Mode 2412 MHz

Vertical

80 dBuV/m

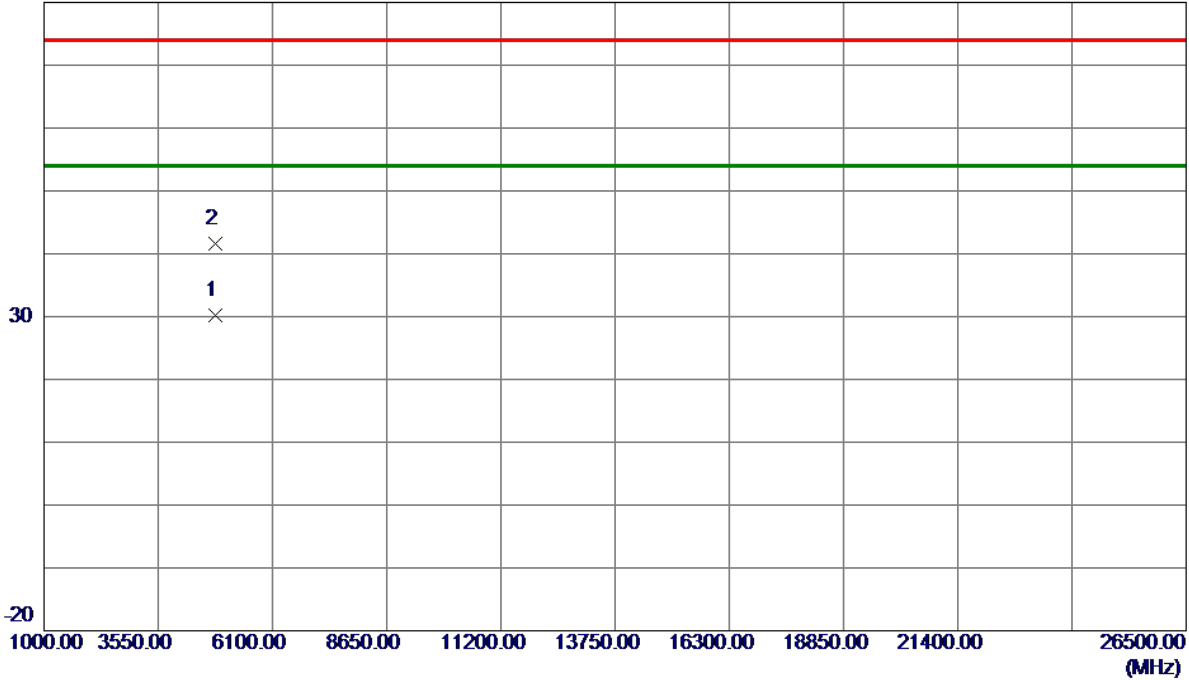

No.	Freq. MHz	Reading Level dBuV/m	Correct Factor dB	Measure ment dBuV/m	Limit dBuV/m	Margin dB	Detector	Comment
1 *	4822.6750	25.91	4.25	30.16	54.00	-23.84	AVG	
2	4825.8750	37.39	4.26	41.65	74.00	-32.35	Peak	

REMARKS:

- (1) Measurement Value = Reading Level + Correct Factor.
- (2) Margin Level = Measurement Value - Limit Value.

Orthogonal Axis	X
Test Mode:	TX N-20M Mode 2412 MHz

Horizontal

130 dBuV/m

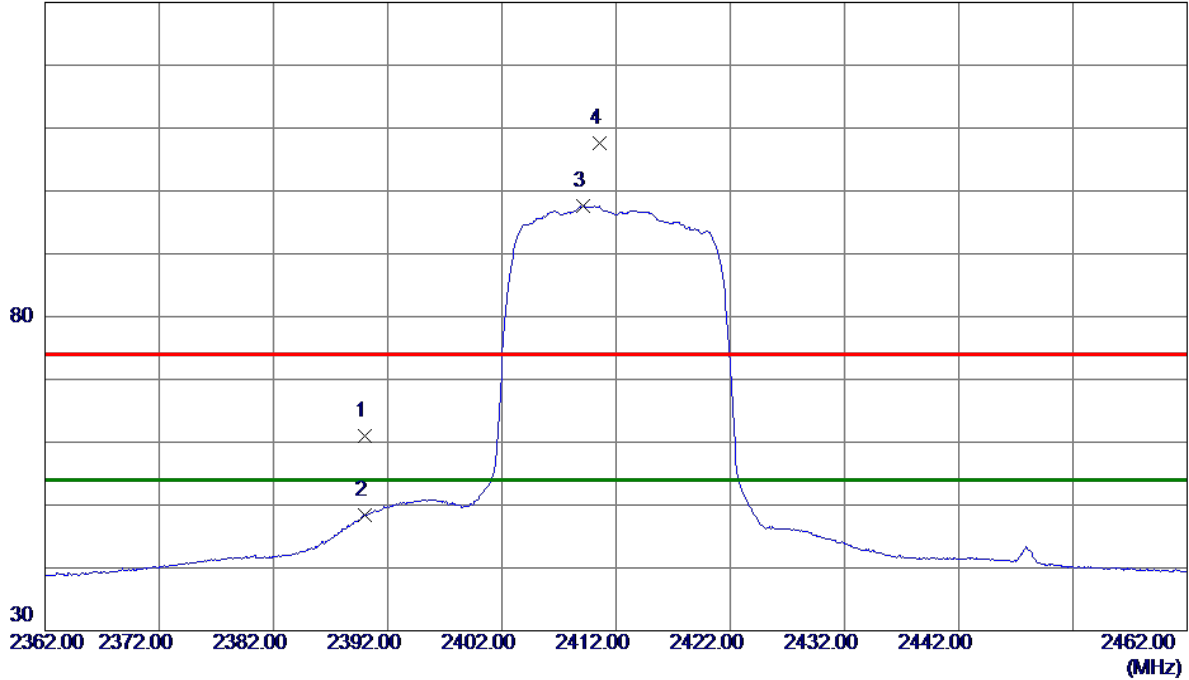

No.	Freq. MHz	Reading Level dBuV/m	Correct Factor dB	Measure ment dBuV/m	Limit dBuV/m	Margin dB	Detector	Comment
1	2390.0000	53.45	7.56	61.01	74.00	-12.99	Peak	
2	2390.0000	40.75	7.56	48.31	54.00	-5.69	AVG	
3 *	2409.1500	89.93	7.63	97.56	54.00	43.56	AVG	No Limit
4	2410.5500	99.98	7.63	107.61	74.00	33.61	Peak	No Limit

REMARKS:

- (1) Measurement Value = Reading Level + Correct Factor.
- (2) Margin Level = Measurement Value - Limit Value.

Orthogonal Axis	X
Test Mode:	TX N-20M Mode 2412 MHz

Horizontal

80 dBuV/m

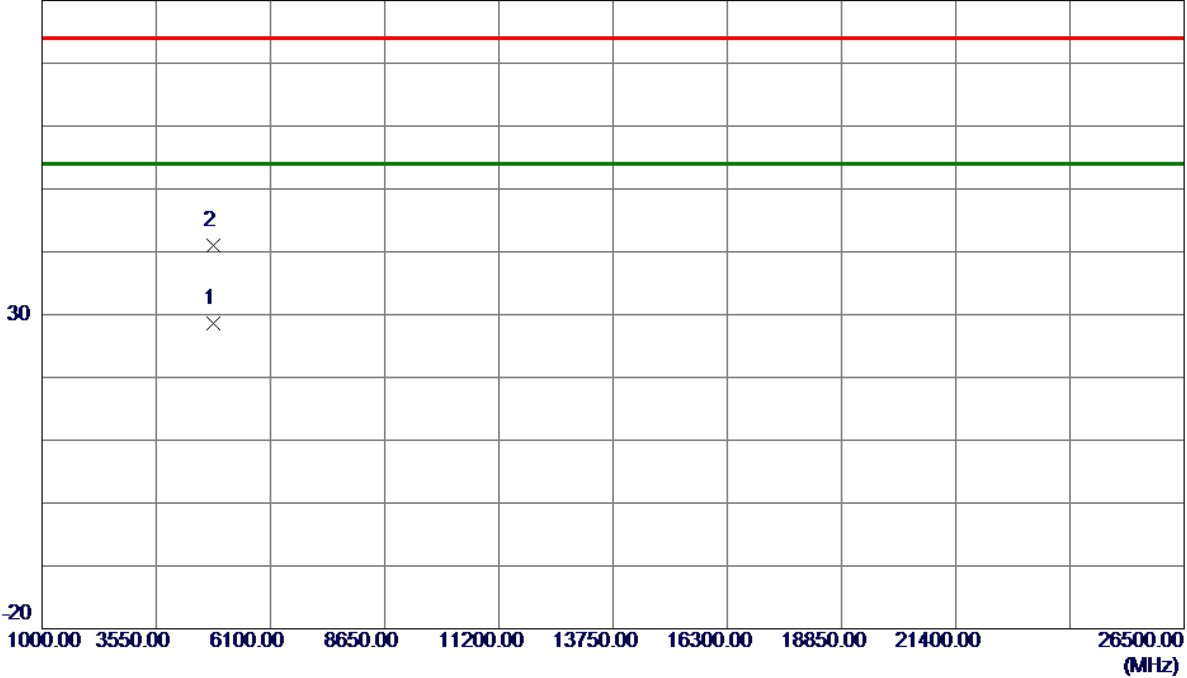

No.	Freq. MHz	Reading Level dBuV/m	Correct Factor dB	Measure ment dBuV/m	Limit dBuV/m	Margin dB	Detector	Comment
1 *	4822.7250	24.36	4.25	28.61	54.00	-25.39	AVG	
2	4823.0000	36.74	4.25	40.99	74.00	-33.01	Peak	

REMARKS:

- (1) Measurement Value = Reading Level + Correct Factor.
- (2) Margin Level = Measurement Value - Limit Value.

Orthogonal Axis	X
Test Mode:	TX N-20M Mode 2417 MHz

Vertical

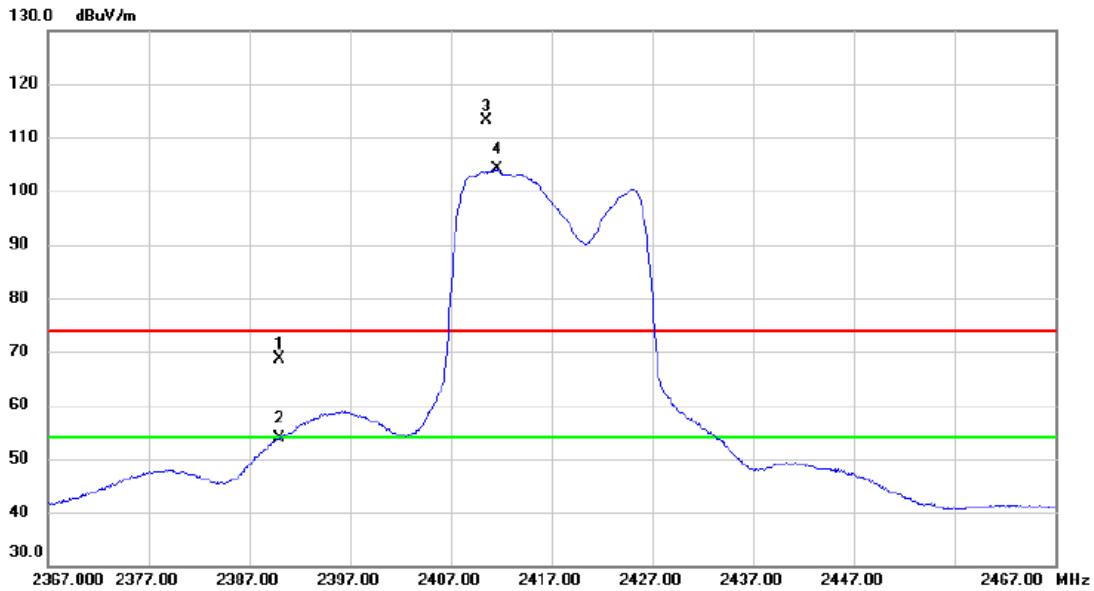

No.	Mk.	Freq. MHz	Reading Level dBuV	Correct Factor dB	Measure- ment dBuV/m	Limit dBuV/m	Margin dB	Detector	Comment
1		2390.000	61.12	7.57	68.69	74.00	-5.31	peak	
2		2390.000	46.19	7.57	53.76	54.00	-0.24	AVG	
3	X	2410.500	105.51	7.63	113.14	74.00	39.14	peak	No Limit
4	*	2411.600	96.44	7.64	104.08	54.00	50.08	AVG	No Limit

REMARKS:

- (1) Measurement Value = Reading Level + Correct Factor.
- (2) Margin Level = Measurement Value - Limit Value.

Orthogonal Axis	X
Test Mode:	TX N-20M Mode 2417 MHz

Vertical

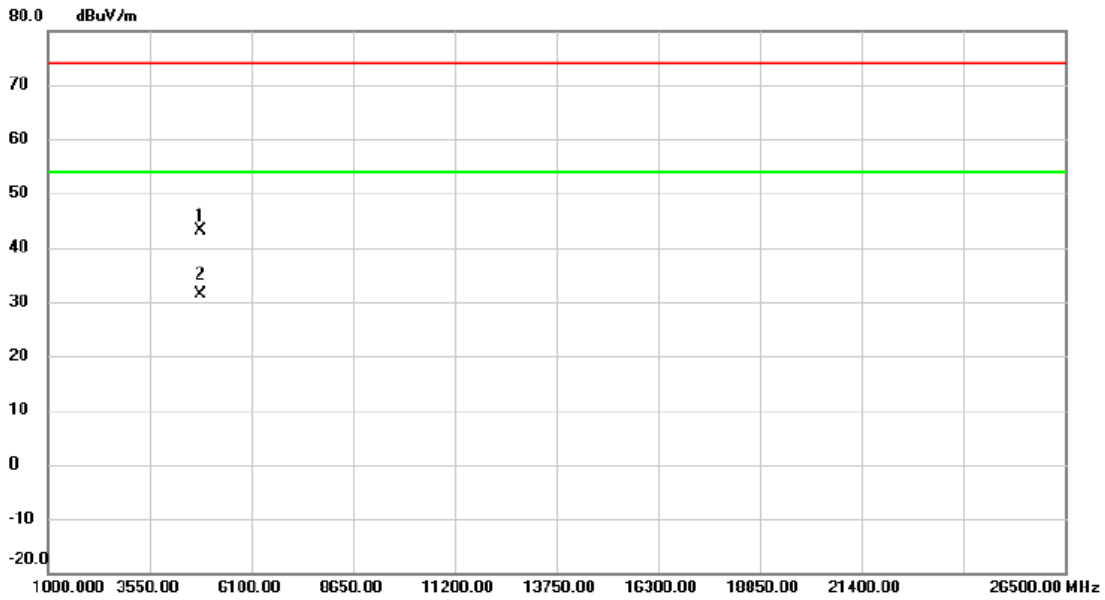

No.	Mk.	Freq. MHz	Reading Level dBuV	Correct Factor dB	Measure- ment dBuV/m	Limit dBuV/m	Margin dB	Detector	Comment
1		4833.825	38.93	4.29	43.22	74.00	-30.78	peak	
2	*	4833.875	27.18	4.29	31.47	54.00	-22.53	AVG	

REMARKS:

- (1) Measurement Value = Reading Level + Correct Factor.
- (2) Margin Level = Measurement Value - Limit Value.

Orthogonal Axis	X
Test Mode:	TX N-20M Mode 2417 MHz

Horizontal

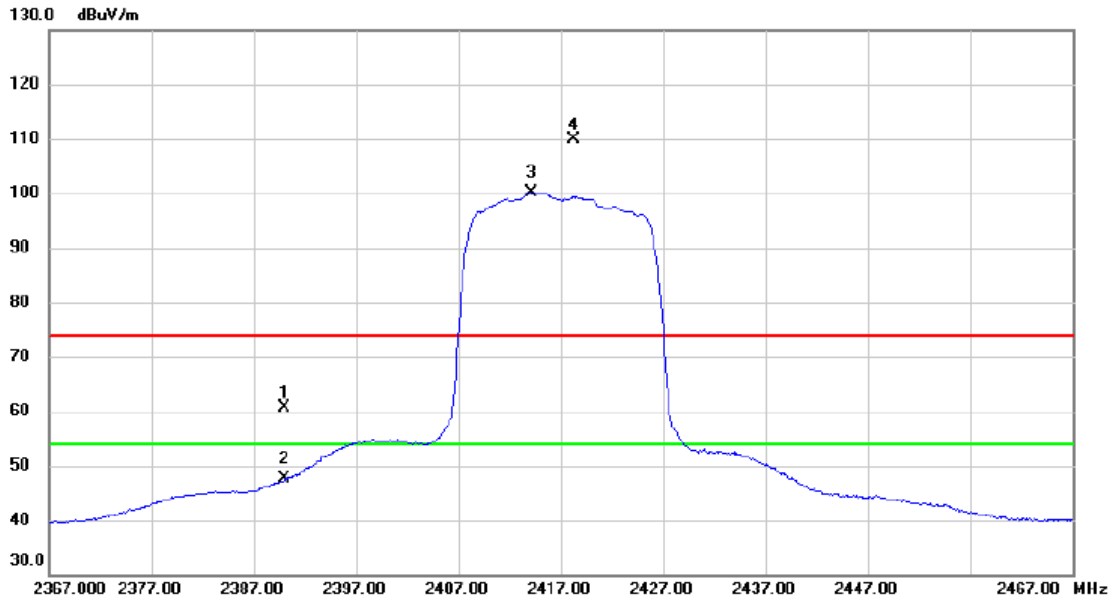

No.	Mk.	Freq.	Reading Level	Correct Factor	Measurement	Limit	Margin	Detector	Comment
		MHz	dBuV	dB	dBuV/m	dBuV/m	dB		
1		2390.000	53.08	7.57	60.65	74.00	-13.35	peak	
2		2390.000	39.94	7.57	47.51	54.00	-6.49	AVG	
3	*	2414.100	92.44	7.65	100.09	54.00	46.09	AVG	No Limit
4	X	2418.250	102.18	7.66	109.84	74.00	35.84	peak	No Limit

REMARKS:

- (1) Measurement Value = Reading Level + Correct Factor.
- (2) Margin Level = Measurement Value - Limit Value.

Orthogonal Axis	X
Test Mode:	TX N-20M Mode 2417 MHz

Horizontal

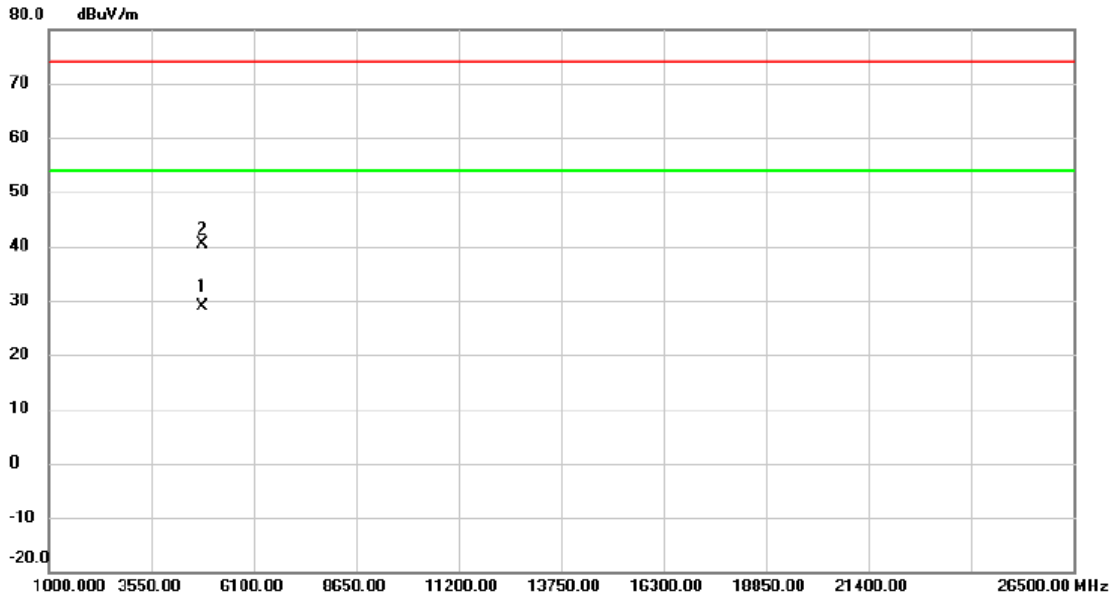

No.	Mk.	Freq. MHz	Reading Level dBuV	Correct Factor dB	Measure- ment dBuV/m	Limit dBuV/m	Margin dB	Detector	Comment
1	*	4824.180	24.50	4.26	28.76	54.00	-25.24	AVG	
2		4824.880	36.19	4.26	40.45	74.00	-33.55	peak	

REMARKS:

- (1) Measurement Value = Reading Level + Correct Factor.
- (2) Margin Level = Measurement Value - Limit Value.

Orthogonal Axis	X
Test Mode:	TX N-20M Mode 2437 MHz

Vertical

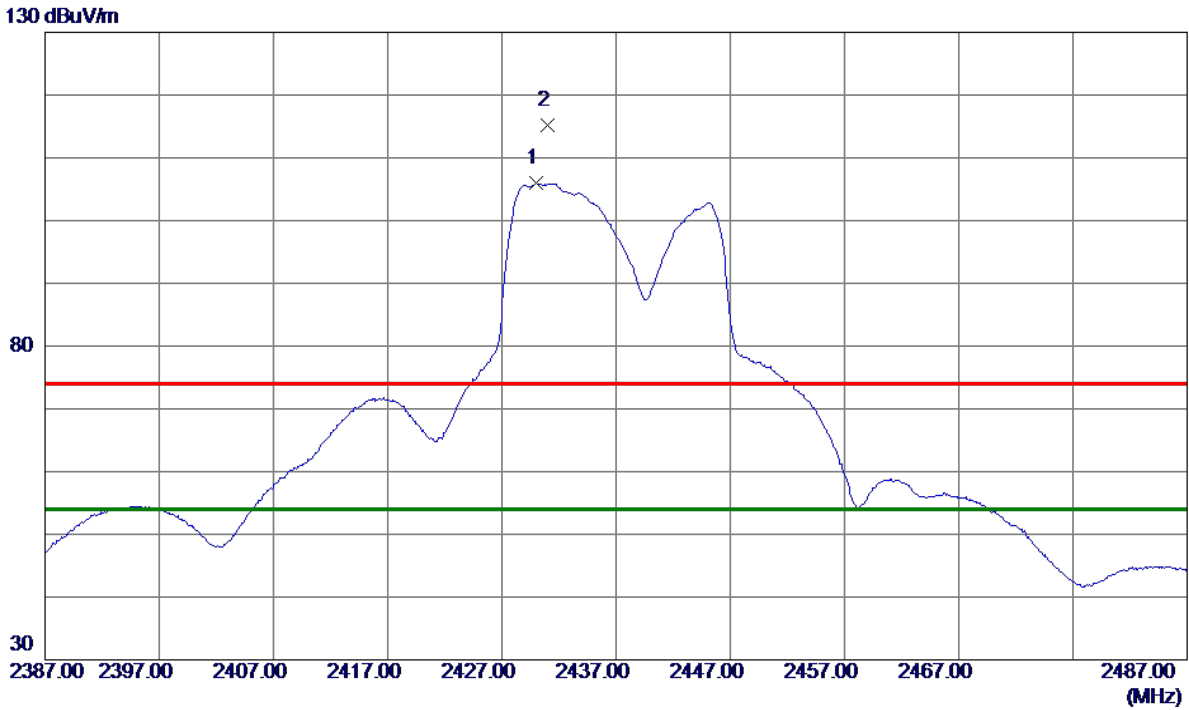

No.	Freq. MHz	Reading Level dBuV/m	Correct Factor dB	Measure ment dBuV/m	Limit dBuV/m	Margin dB	Detector	Comment
1 *	2430.0000	98.23	7.70	105.93	54.00	51.93	AVG	No Limit
2	2431.0500	107.57	7.70	115.27	74.00	41.27	Peak	No Limit

REMARKS:

- (1) Measurement Value = Reading Level + Correct Factor.
- (2) Margin Level = Measurement Value - Limit Value.

Orthogonal Axis	X
Test Mode:	TX N-20M Mode 2437 MHz

Vertical

80 dBuV/m

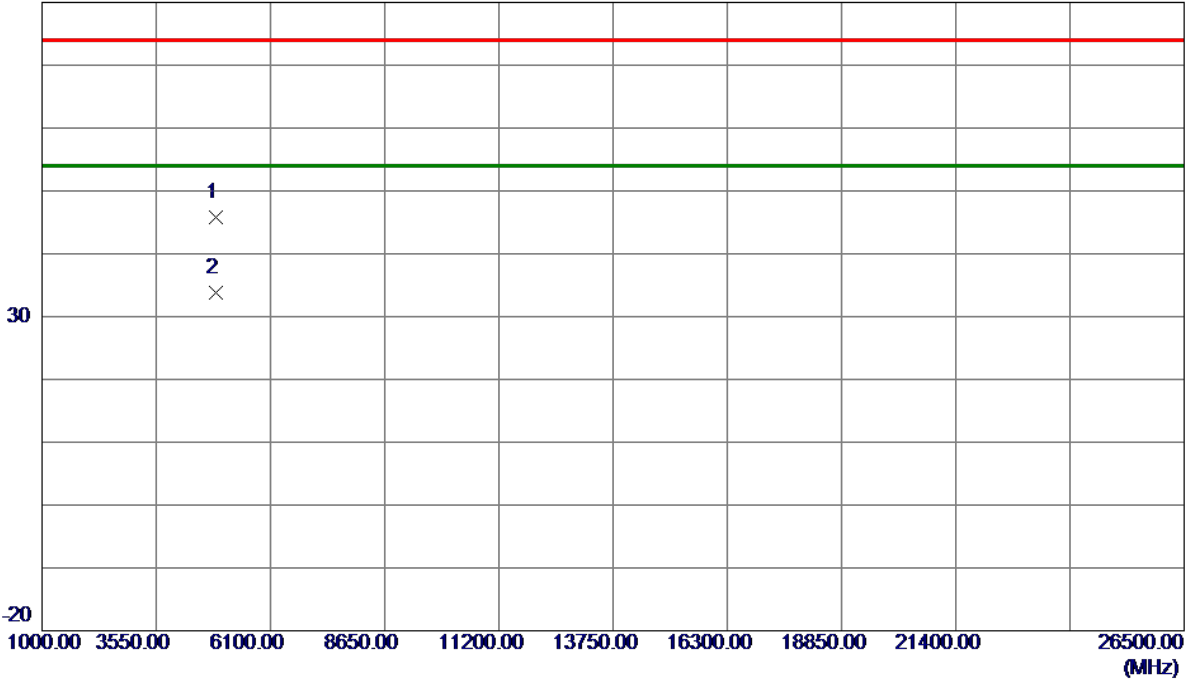

No.	Freq. MHz	Reading Level dBuV/m	Correct Factor dB	Measure ment dBuV/m	Limit dBuV/m	Margin dB	Detector	Comment
1	4869.0500	41.32	4.42	45.74	74.00	-28.26	Peak	
2 *	4873.7000	29.44	4.44	33.88	54.00	-20.12	AVG	

REMARKS:

- (1) Measurement Value = Reading Level + Correct Factor.
- (2) Margin Level = Measurement Value - Limit Value.

Orthogonal Axis	X
Test Mode:	TX N-20M Mode 2437 MHz

Horizontal

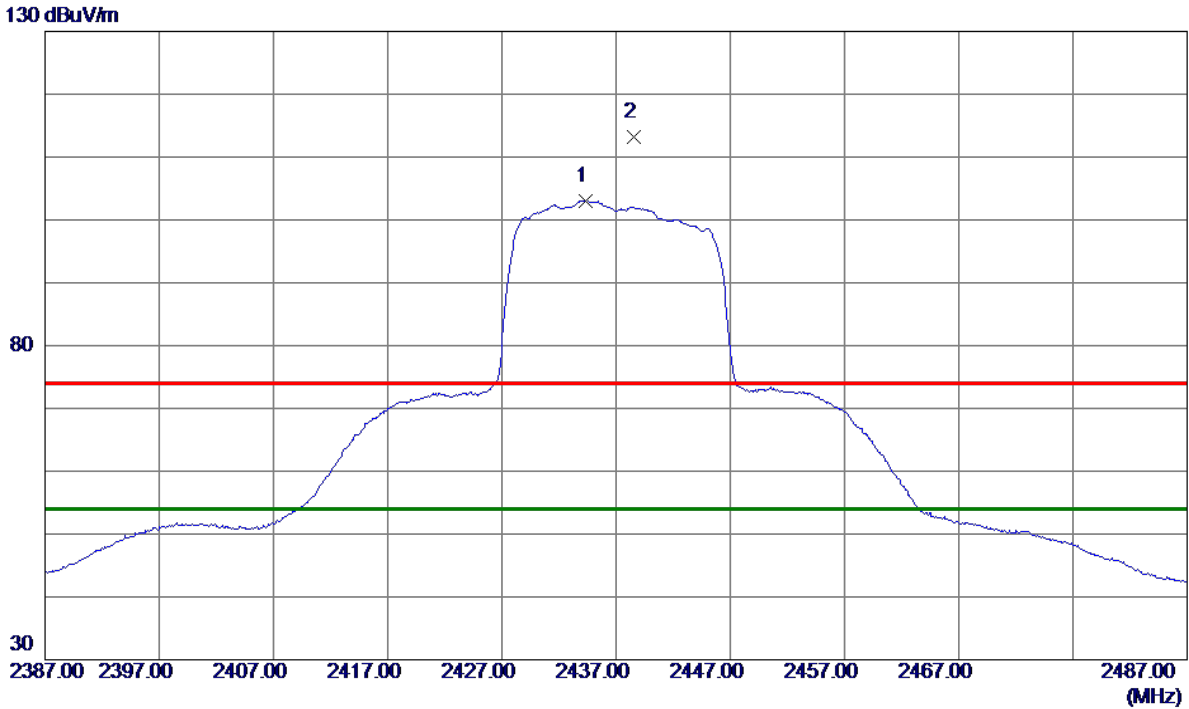

No.	Freq. MHz	Reading Level dBuV/m	Correct Factor dB	Measure ment dBuV/m	Limit dBuV/m	Margin dB	Detector	Comment
1 *	2434.3000	95.35	7.71	103.06	54.00	49.06	AVG	No Limit
2	2438.5500	105.55	7.73	113.28	74.00	39.28	Peak	No Limit

REMARKS:

- (1) Measurement Value = Reading Level + Correct Factor.
- (2) Margin Level = Measurement Value - Limit Value.

Orthogonal Axis	X
Test Mode:	TX N-20M Mode 2437 MHz

Horizontal

80 dBuV/m

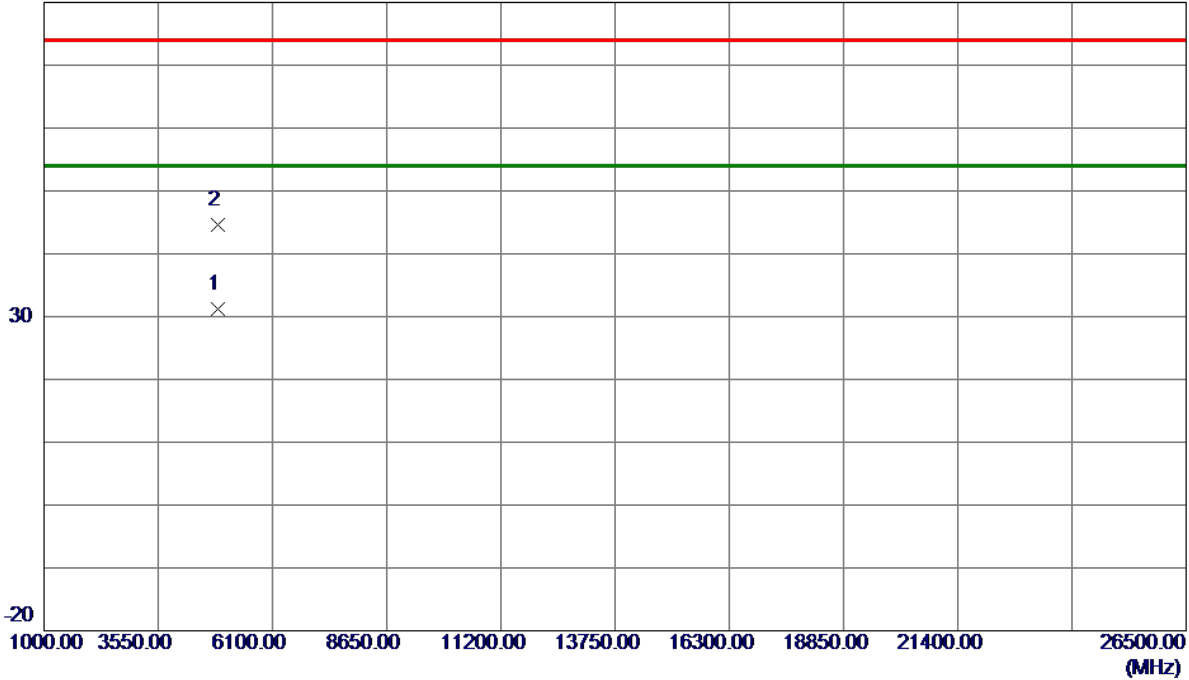

No.	Freq. MHz	Reading Level dBuV/m	Correct Factor dB	Measure ment dBuV/m	Limit dBuV/m	Margin dB	Detector	Comment
1 *	4873.2000	26.73	4.44	31.17	54.00	-22.83	AVG	
2	4873.8750	40.16	4.44	44.60	74.00	-29.40	Peak	

REMARKS:

- (1) Measurement Value = Reading Level + Correct Factor.
- (2) Margin Level = Measurement Value - Limit Value.

Orthogonal Axis	X
Test Mode:	TX N-20M Mode 2457 MHz

Vertical

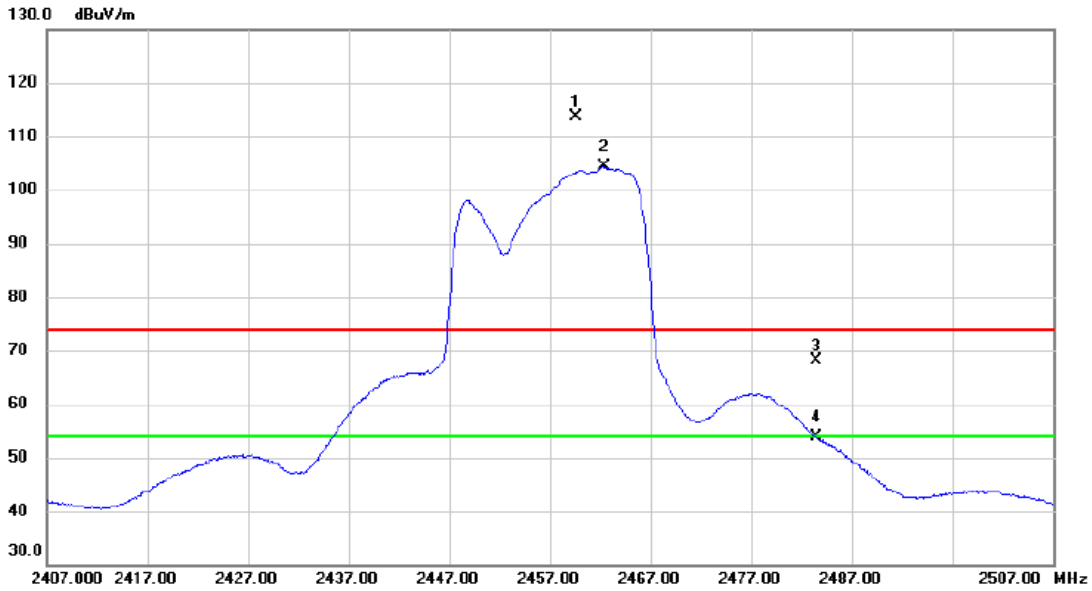

No.	Mk.	Freq. MHz	Reading Level dBuV	Correct Factor dB	Measure- ment dBuV/m	Limit dBuV/m	Margin dB	Detector	Comment
1	X	2459.600	105.78	7.79	113.57	74.00	39.57	peak	No Limit
2	*	2462.350	96.46	7.80	104.26	54.00	50.26	AVG	No Limit
3		2483.500	60.27	7.87	68.14	74.00	-5.86	peak	
4		2483.500	45.94	7.87	53.81	54.00	-0.19	AVG	

REMARKS:

- (1) Measurement Value = Reading Level + Correct Factor.
- (2) Margin Level = Measurement Value - Limit Value.

Orthogonal Axis	X
Test Mode:	TX N-20M Mode 2457 MHz

Vertical

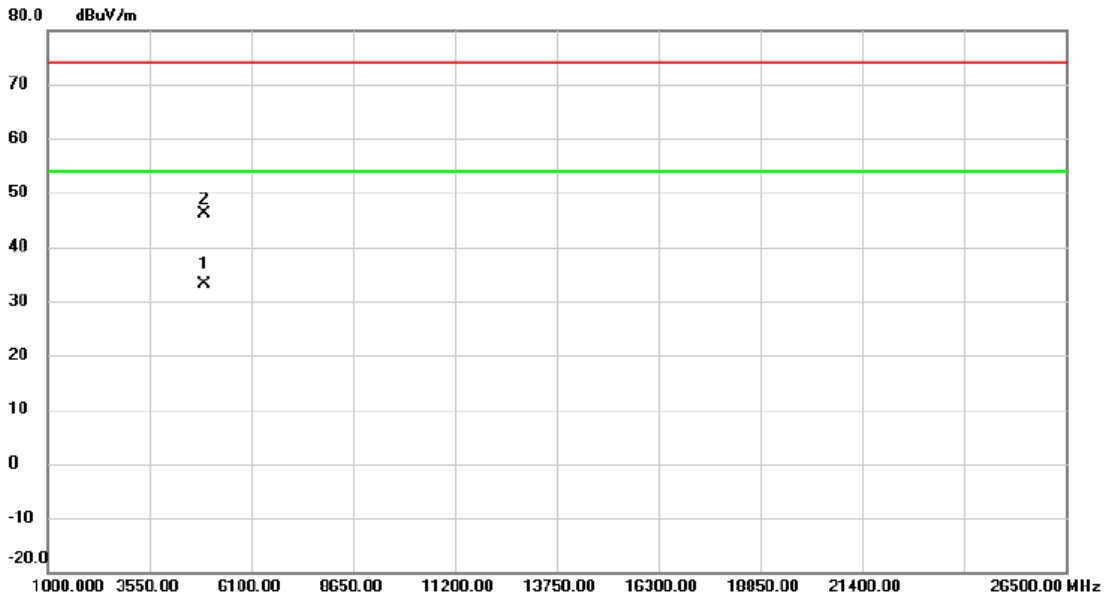

No.	Mk.	Freq. MHz	Reading Level dBuV	Correct Factor dB	Measure- ment dBuV/m	Limit dBuV/m	Margin dB	Detector	Comment
1	*	4913.925	28.55	4.58	33.13	54.00	-20.87	AVG	
2		4916.825	41.54	4.61	46.15	74.00	-27.85	peak	

REMARKS:

- (1) Measurement Value = Reading Level + Correct Factor.
- (2) Margin Level = Measurement Value - Limit Value.

Orthogonal Axis	X
Test Mode:	TX N-20M Mode 2457 MHz

Horizontal

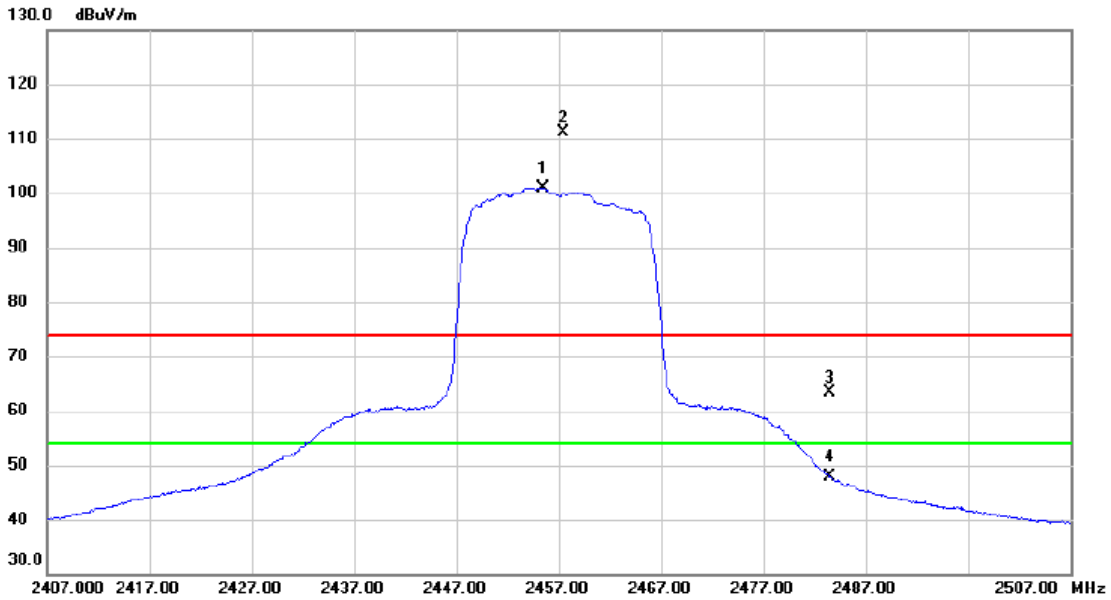

No.	Mk.	Freq. MHz	Reading Level dBuV	Correct Factor dB	Measure- ment dBuV/m	Limit dBuV/m	Margin dB	Detector	Comment
1	*	2455.400	93.22	7.78	101.00	54.00	47.00	AVG	No Limit
2	X	2457.400	103.29	7.79	111.08	74.00	37.08	peak	No Limit
3		2483.500	55.63	7.87	63.50	74.00	-10.50	peak	
4		2483.500	40.09	7.87	47.96	54.00	-6.04	AVG	

REMARKS:

- (1) Measurement Value = Reading Level + Correct Factor.
- (2) Margin Level = Measurement Value - Limit Value.

Orthogonal Axis	X
Test Mode:	TX N-20M Mode 2457 MHz

Horizontal

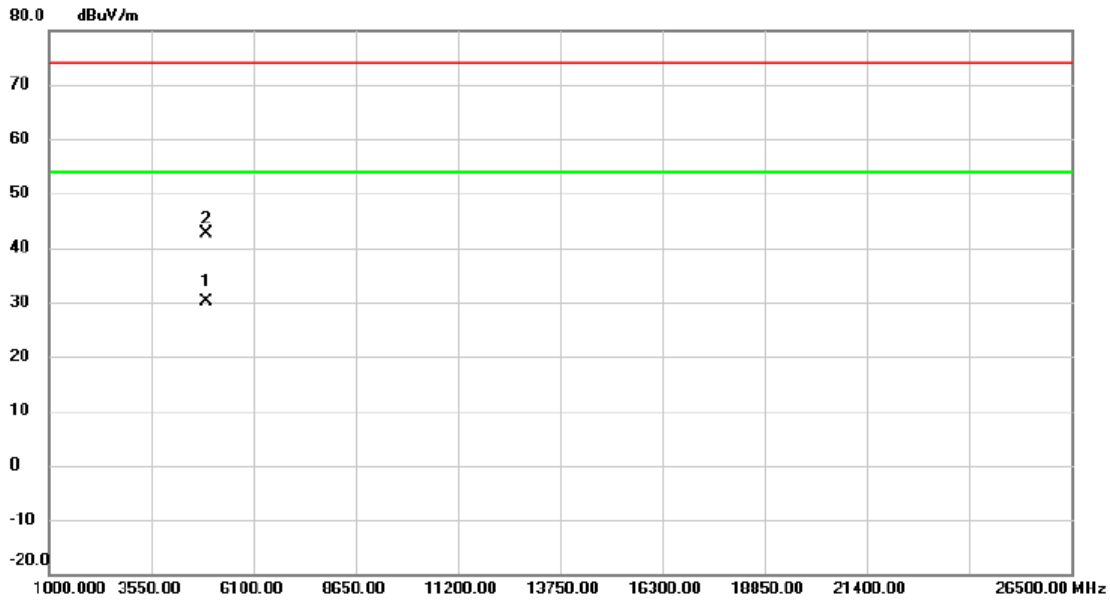

No.	Mk.	Freq. MHz	Reading Level dBuV	Correct Factor dB	Measure- ment dBuV/m	Limit dBuV/m	Margin dB	Detector	Comment
1	*	4912.750	25.53	4.58	30.11	54.00	-23.89	AVG	
2		4914.475	38.09	4.58	42.67	74.00	-31.33	peak	

REMARKS:

- (1) Measurement Value = Reading Level + Correct Factor.
- (2) Margin Level = Measurement Value - Limit Value.

Orthogonal Axis	X
Test Mode:	TX N-20M Mode 2462 MHz

Vertical

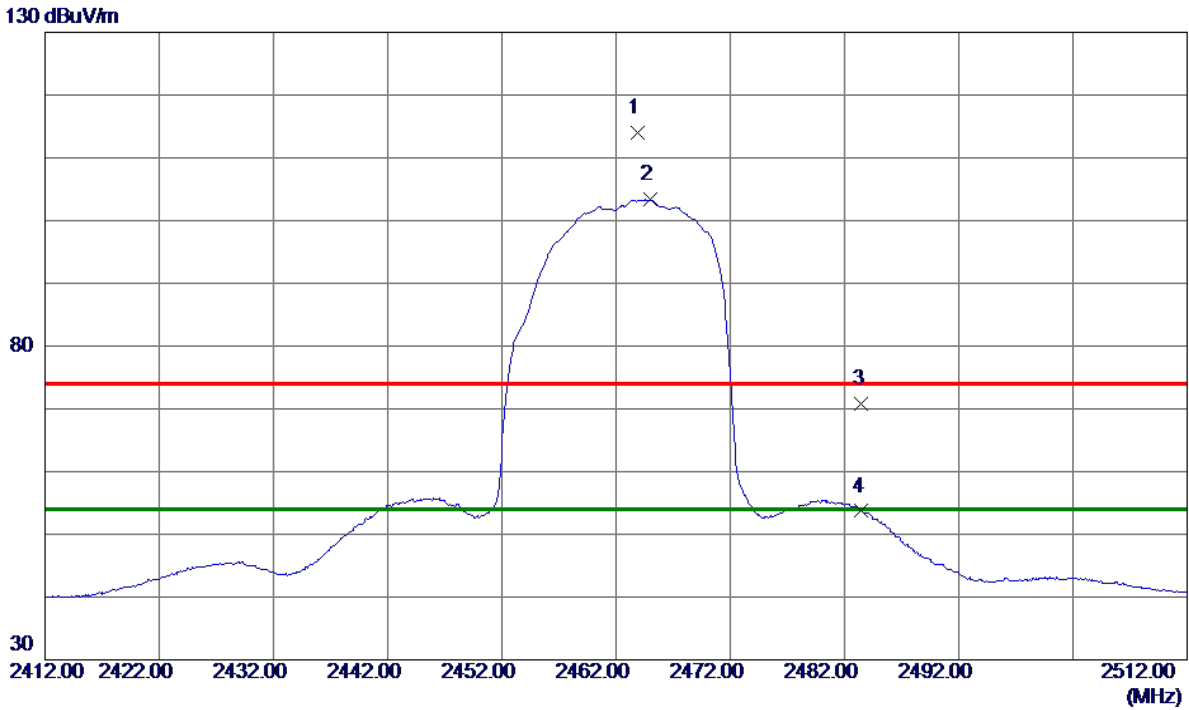

No.	Freq. MHz	Reading Level dBuV/m	Correct Factor dB	Measure ment dBuV/m	Limit dBuV/m	Margin dB	Detector	Comment
1	2463.8500	106.22	7.81	114.03	74.00	40.03	Peak	No Limit
2 *	2465.0500	95.54	7.81	103.35	54.00	49.35	AVG	No Limit
3	2483.5000	62.84	7.88	70.72	74.00	-3.28	Peak	
4	2483.5000	45.82	7.88	53.70	54.00	-0.30	AVG	

REMARKS:

- (1) Measurement Value = Reading Level + Correct Factor.
- (2) Margin Level = Measurement Value - Limit Value.

Orthogonal Axis	X
Test Mode:	TX N-20M Mode 2462 MHz

Vertical

80 dBuV/m

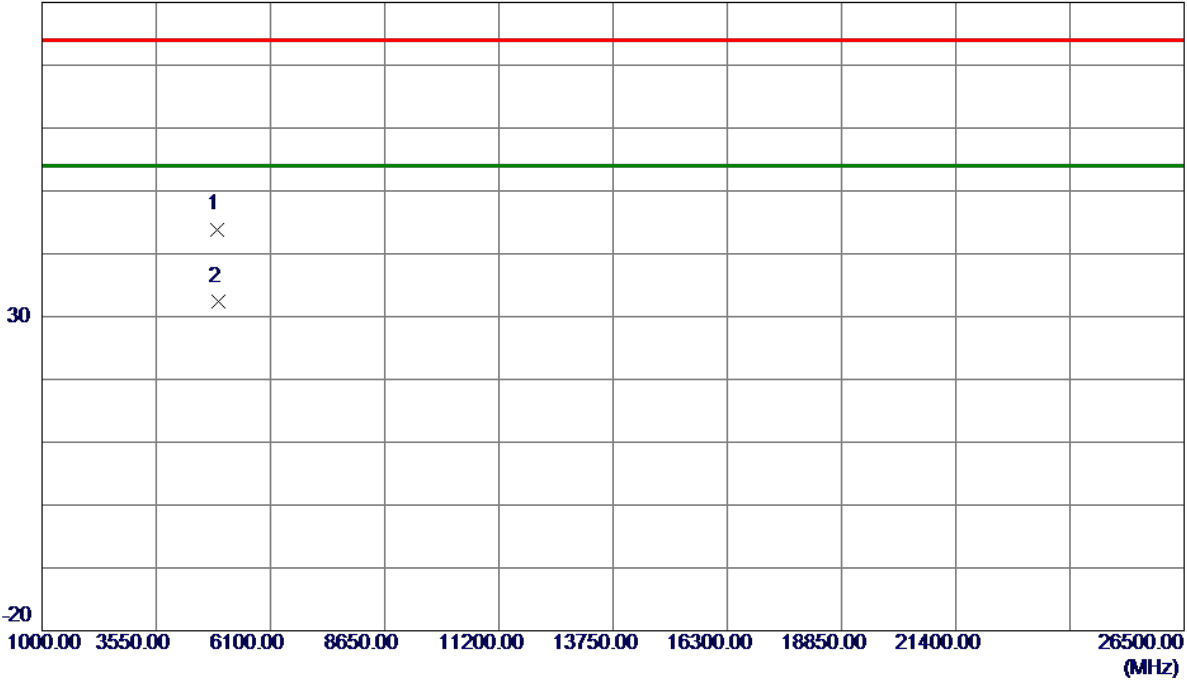

No.	Freq. MHz	Reading Level dBuV/m	Correct Factor dB	Measure ment dBuV/m	Limit dBuV/m	Margin dB	Detector	Comment
1	4923.4750	39.27	4.63	43.90	74.00	-30.10	Peak	
2 *	4924.2000	27.69	4.63	32.32	54.00	-21.68	AVG	

REMARKS:

- (1) Measurement Value = Reading Level + Correct Factor.
- (2) Margin Level = Measurement Value - Limit Value.

Orthogonal Axis	X
Test Mode:	TX N-20M Mode 2462 MHz

Horizontal

130 dBuV/m

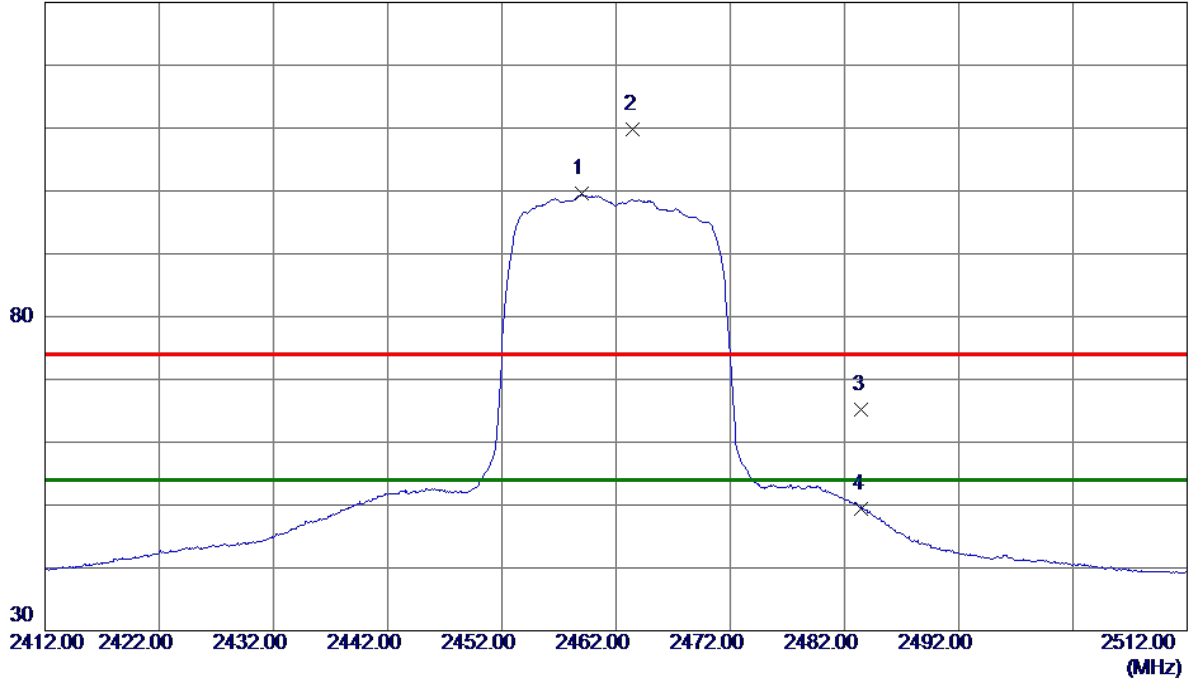

No.	Freq. MHz	Reading Level dBuV/m	Correct Factor dB	Measure ment dBuV/m	Limit dBuV/m	Margin dB	Detector	Comment
1 *	2459.0500	91.73	7.79	99.52	54.00	45.52	AVG	No Limit
2	2463.5000	101.99	7.81	109.80	74.00	35.80	Peak	No Limit
3	2483.5000	57.40	7.88	65.28	74.00	-8.72	Peak	
4	2483.5000	41.59	7.88	49.47	54.00	-4.53	AVG	

REMARKS:

- (1) Measurement Value = Reading Level + Correct Factor.
- (2) Margin Level = Measurement Value - Limit Value.

Orthogonal Axis	X
Test Mode:	TX N-20M Mode 2462 MHz

Horizontal

80 dBuV/m

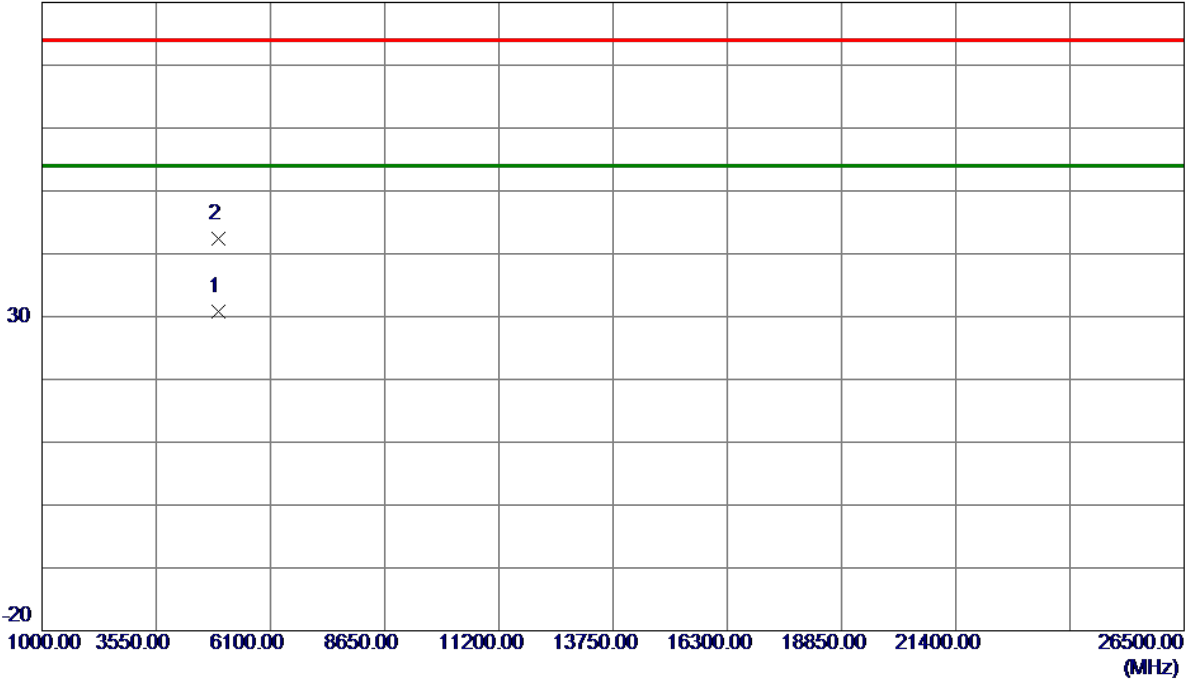

No.	Freq. MHz	Reading Level dBuV/m	Correct Factor dB	Measure ment dBuV/m	Limit dBuV/m	Margin dB	Detector	Comment
1 *	4926.6750	26.20	4.64	30.84	54.00	-23.16	AVG	
2	4928.3250	37.68	4.64	42.32	74.00	-31.68	Peak	

REMARKS:

- (1) Measurement Value = Reading Level + Correct Factor.
- (2) Margin Level = Measurement Value - Limit Value.

Orthogonal Axis	X
Test Mode:	TX N-40M Mode 2422MHz

Vertical

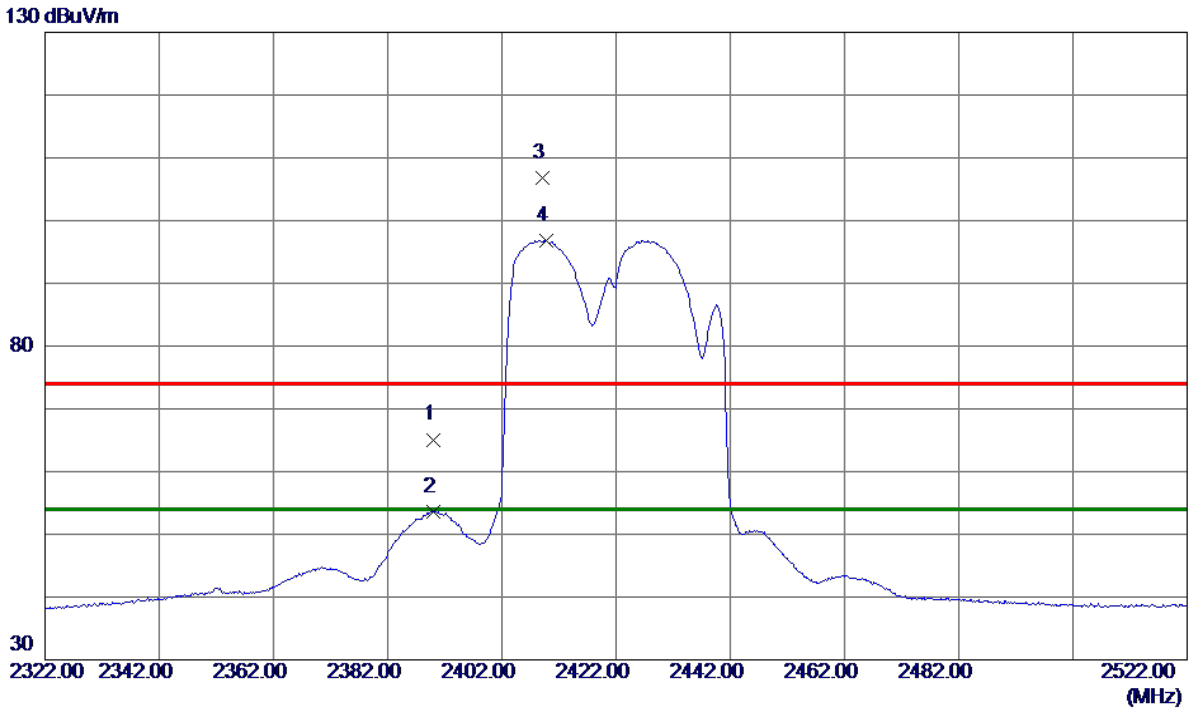

No.	Freq. MHz	Reading Level dBuV/m	Correct Factor dB	Measure ment dBuV/m	Limit dBuV/m	Margin dB	Detector	Comment
1	2390.0000	57.54	7.56	65.10	74.00	-8.90	Peak	
2	2390.0000	46.09	7.56	53.65	54.00	-0.35	AVG	
3	2409.1000	99.14	7.63	106.77	74.00	32.77	Peak	No Limit
4 *	2409.7000	89.19	7.63	96.82	54.00	42.82	AVG	No Limit

REMARKS:

- (1) Measurement Value = Reading Level + Correct Factor.
- (2) Margin Level = Measurement Value - Limit Value.

Orthogonal Axis	X
Test Mode:	TX N-40M Mode 2422MHz

Vertical

80 dBuV/m

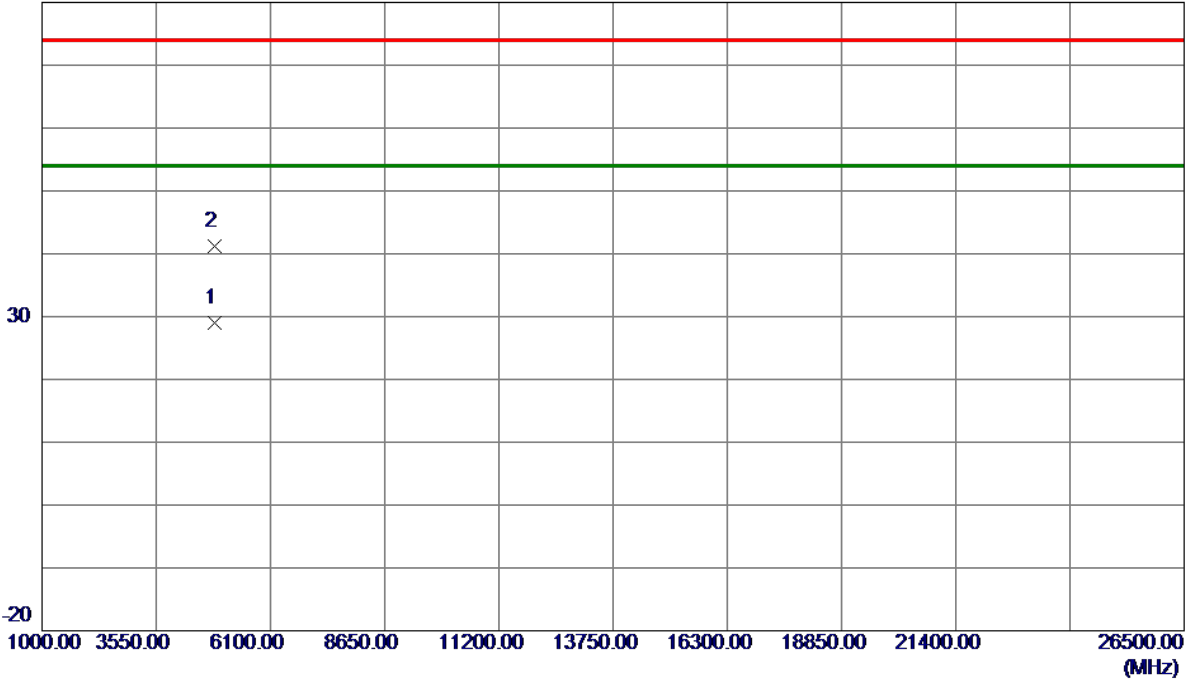

No.	Freq. MHz	Reading Level dBuV/m	Correct Factor dB	Measure ment dBuV/m	Limit dBuV/m	Margin dB	Detector	Comment
1 *	4843.6000	24.65	4.33	28.98	54.00	-25.02	AVG	
2	4846.1250	36.93	4.34	41.27	74.00	-32.73	Peak	

REMARKS:

- (1) Measurement Value = Reading Level + Correct Factor.
- (2) Margin Level = Measurement Value - Limit Value.

Orthogonal Axis	X
Test Mode:	TX N-40M Mode 2422MHz

Horizontal

130 dBuV/m

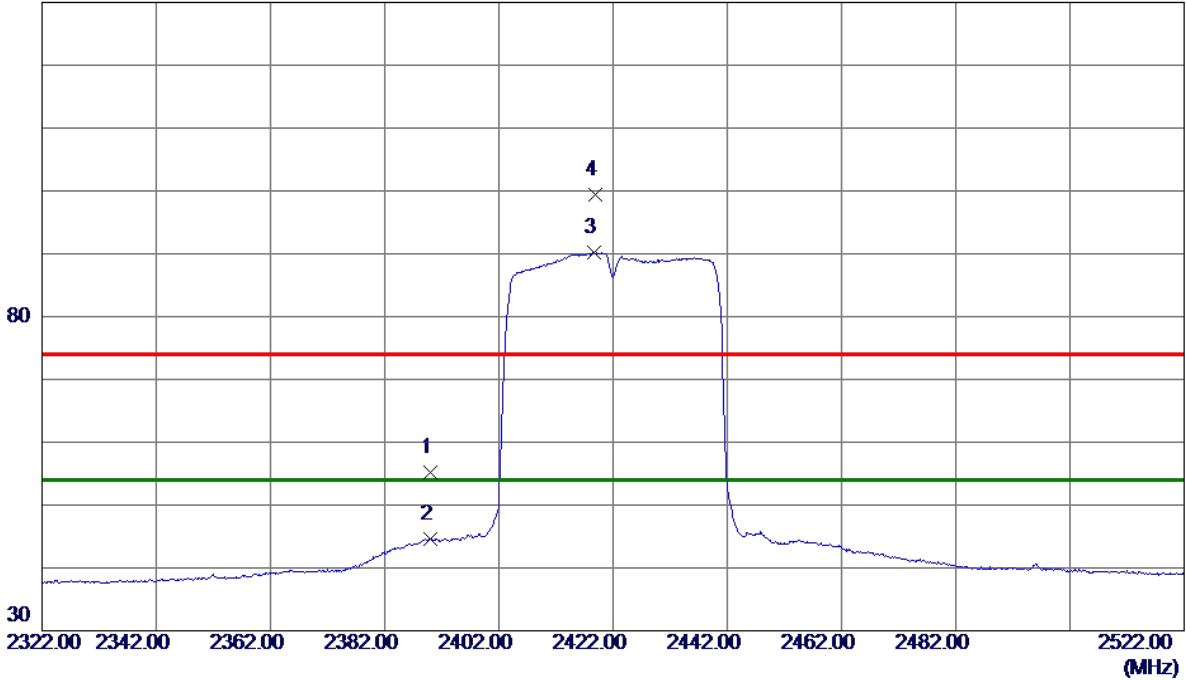

No.	Freq. MHz	Reading Level dBuV/m	Correct Factor dB	Measure ment dBuV/m	Limit dBuV/m	Margin dB	Detector	Comment
1	2390.0000	47.66	7.56	55.22	74.00	-18.78	Peak	
2	2390.0000	37.03	7.56	44.59	54.00	-9.41	AVG	
3 *	2418.6000	82.59	7.66	90.25	54.00	36.25	AVG	No Limit
4	2418.9000	91.83	7.66	99.49	74.00	25.49	Peak	No Limit

REMARKS:

- (1) Measurement Value = Reading Level + Correct Factor.
- (2) Margin Level = Measurement Value - Limit Value.

Orthogonal Axis	X
Test Mode:	TX N-40M Mode 2422MHz

Horizontal

80 dBuV/m

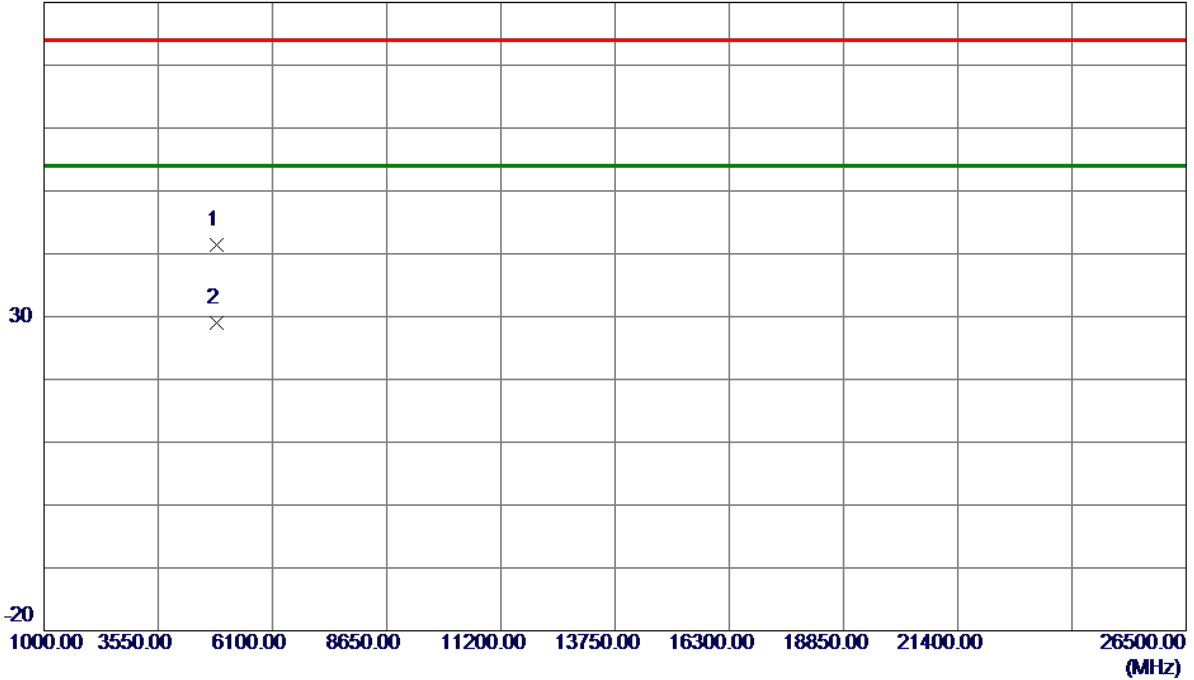

No.	Freq. MHz	Reading Level dBuV/m	Correct Factor dB	Measure ment dBuV/m	Limit dBuV/m	Margin dB	Detector	Comment
1	4847.1500	37.09	4.34	41.43	74.00	-32.57	Peak	
2 *	4860.6750	24.61	4.39	29.00	54.00	-25.00	AVG	

REMARKS:

- (1) Measurement Value = Reading Level + Correct Factor.
- (2) Margin Level = Measurement Value - Limit Value.

Orthogonal Axis	X
Test Mode:	TX N-40M Mode 2427 MHz

Vertical

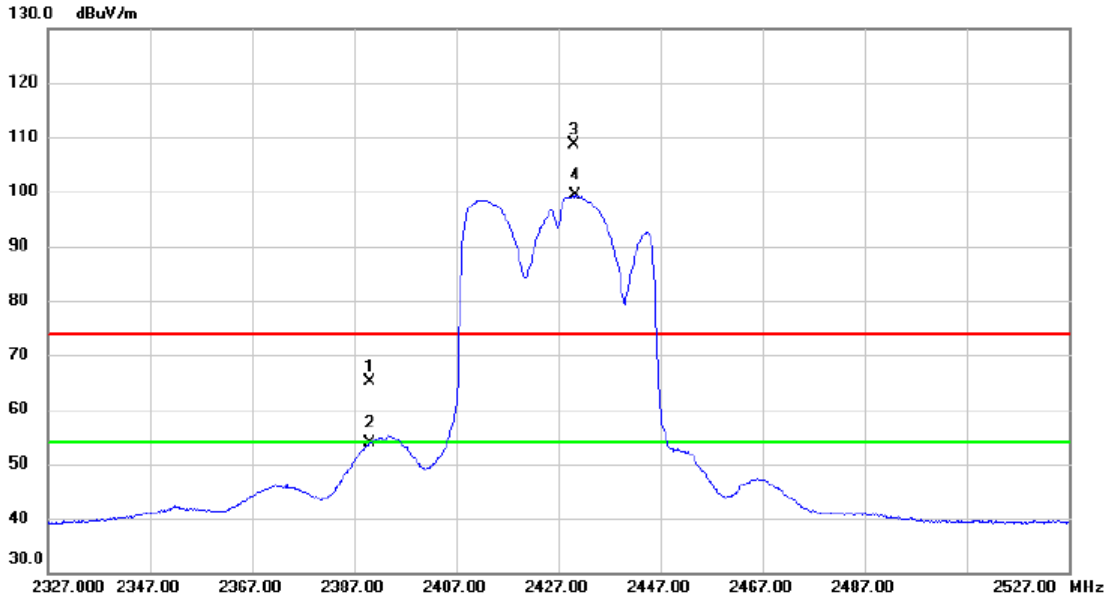

No.	Mk.	Freq. MHz	Reading Level dBuV	Correct Factor dB	Measure- ment dBuV/m	Limit dBuV/m	Margin dB	Detector	Comment
1		2390.000	57.56	7.57	65.13	74.00	-8.87	peak	
2		2390.000	46.23	7.57	53.80	54.00	-0.20	AVG	
3	X	2430.100	100.94	7.70	108.64	74.00	34.64	peak	No Limit
4	*	2430.400	91.64	7.70	99.34	54.00	45.34	AVG	No Limit

REMARKS:

- (1) Measurement Value = Reading Level + Correct Factor.
- (2) Margin Level = Measurement Value - Limit Value.

Orthogonal Axis	X
Test Mode:	TX N-40M Mode 2427 MHz

Vertical

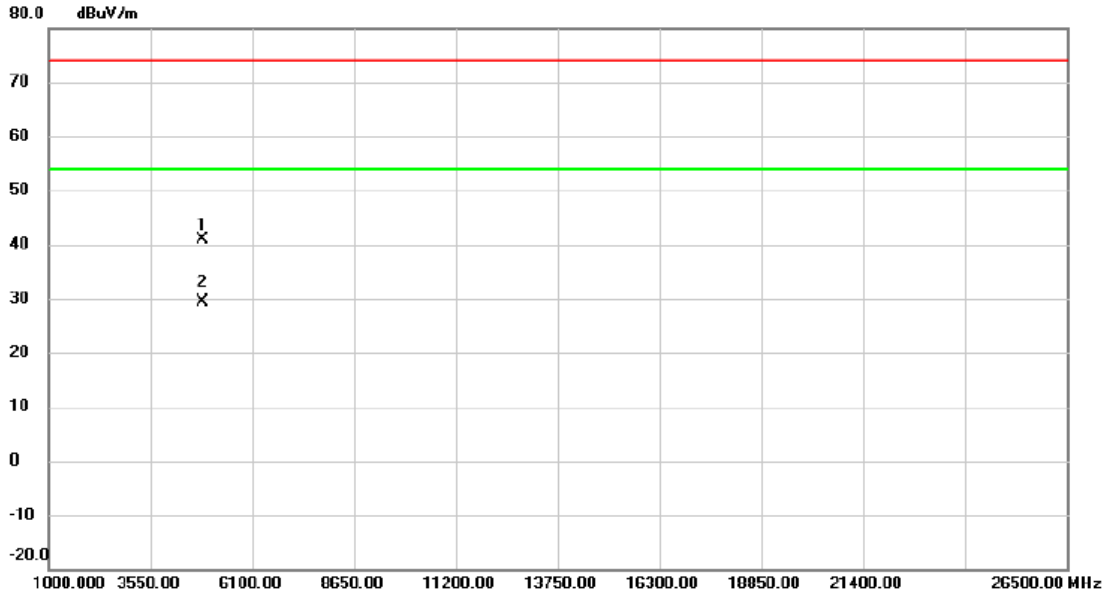

No.	Mk.	Freq. MHz	Reading Level dBuV	Correct Factor dB	Measure- ment dBuV/m	Limit dBuV/m	Margin dB	Detector	Comment
1		4851.225	36.49	4.36	40.85	74.00	-33.15	peak	
2	*	4859.325	24.97	4.38	29.35	54.00	-24.65	AVG	

REMARKS:

- (1) Measurement Value = Reading Level + Correct Factor.
- (2) Margin Level = Measurement Value - Limit Value.

Orthogonal Axis	X
Test Mode:	TX N-40M Mode 2427 MHz

Horizontal

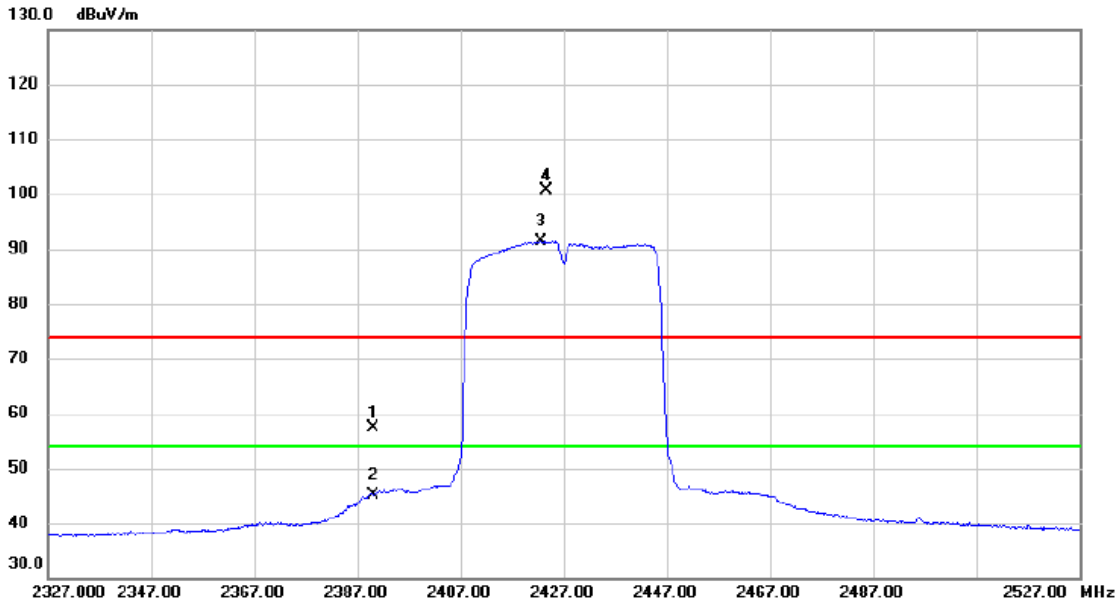

No.	Mk.	Freq. MHz	Reading Level dBuV	Correct Factor dB	Measure- ment dBuV/m	Limit dBuV/m	Margin dB	Detector	Comment
1		2390.000	49.87	7.57	57.44	74.00	-16.56	peak	
2		2390.000	37.62	7.57	45.19	54.00	-8.81	AVG	
3	*	2422.700	83.67	7.67	91.34	54.00	37.34	AVG	No Limit
4	X	2423.700	92.93	7.68	100.61	74.00	26.61	peak	No Limit

REMARKS:

(1) Measurement Value = Reading Level + Correct Factor.

(2) Margin Level = Measurement Value - Limit Value.

Orthogonal Axis	X
Test Mode:	TX N-40M Mode 2427 MHz

Horizontal

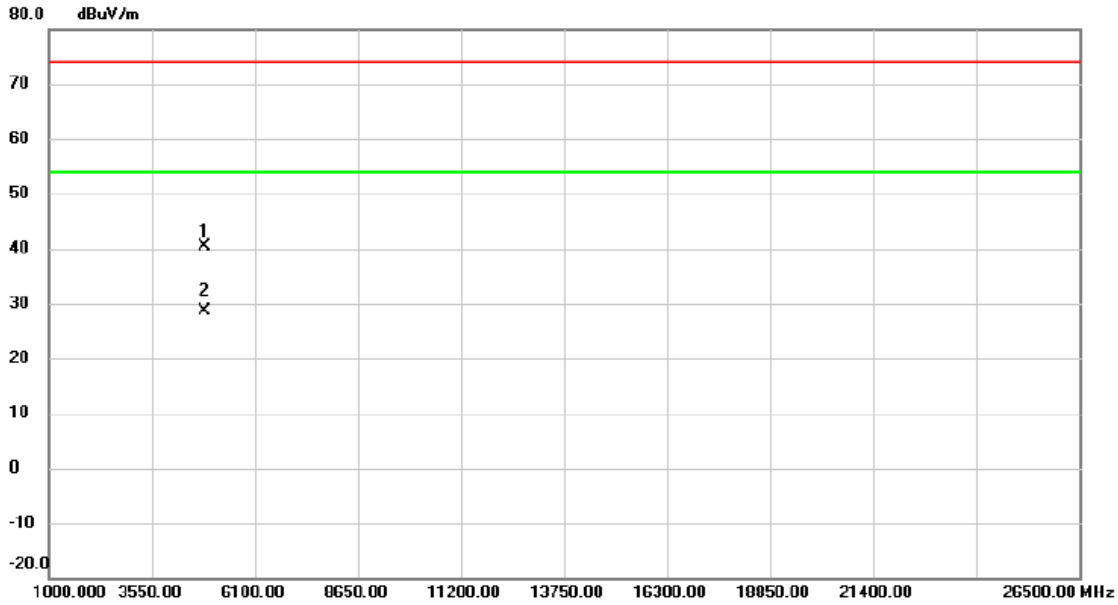

No.	Mk.	Freq. MHz	Reading Level dBuV	Correct Factor dB	Measure- ment dBuV/m	Limit dBuV/m	Margin dB	Detector	Comment
1		4859.550	36.11	4.39	40.50	74.00	-33.50	peak	
2	*	4867.875	24.30	4.42	28.72	54.00	-25.28	AVG	

REMARKS:

- (1) Measurement Value = Reading Level + Correct Factor.
- (2) Margin Level = Measurement Value - Limit Value.

Orthogonal Axis	X
Test Mode:	TX N-40M Mode 2437 MHz

Vertical

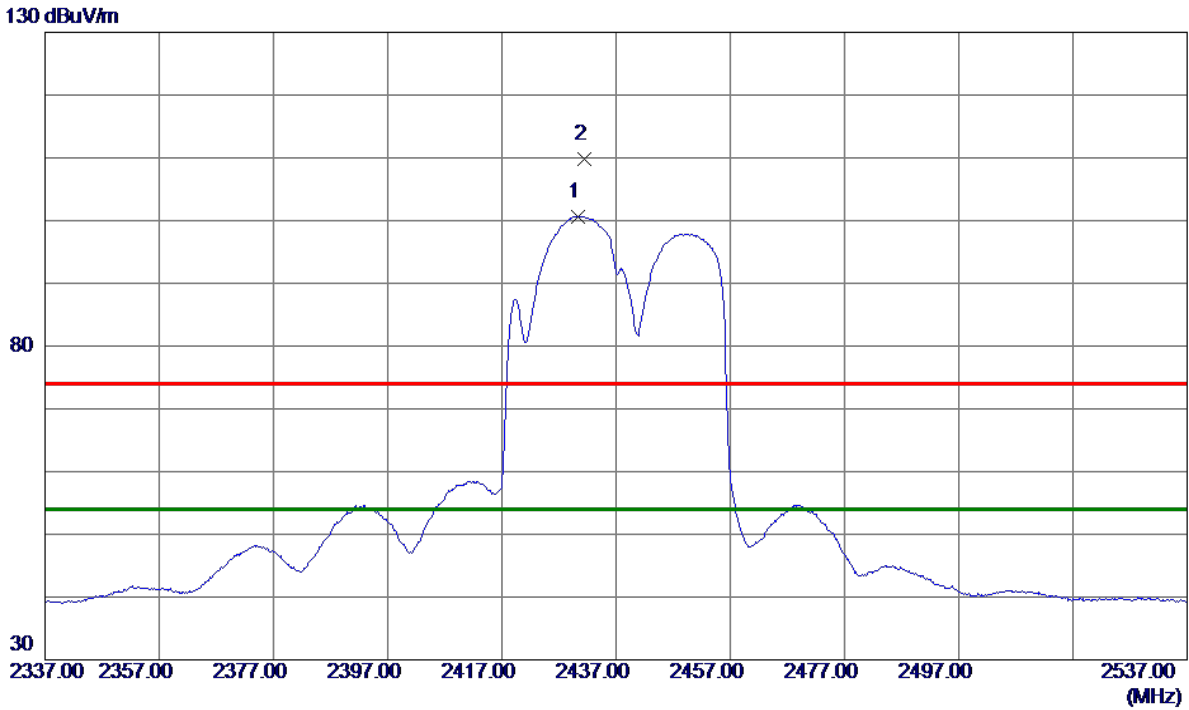

No.	Freq. MHz	Reading Level dBuV/m	Correct Factor dB	Measure ment dBuV/m	Limit dBuV/m	Margin dB	Detector	Comment
1 *	2430.4000	92.99	7.70	100.69	54.00	46.69	AVG	No Limit
2	2431.5000	102.17	7.70	109.87	74.00	35.87	Peak	No Limit

REMARKS:

- (1) Measurement Value = Reading Level + Correct Factor.
- (2) Margin Level = Measurement Value - Limit Value.

Orthogonal Axis	X
Test Mode:	TX N-40M Mode 2437 MHz

Vertical

80 dBuV/m

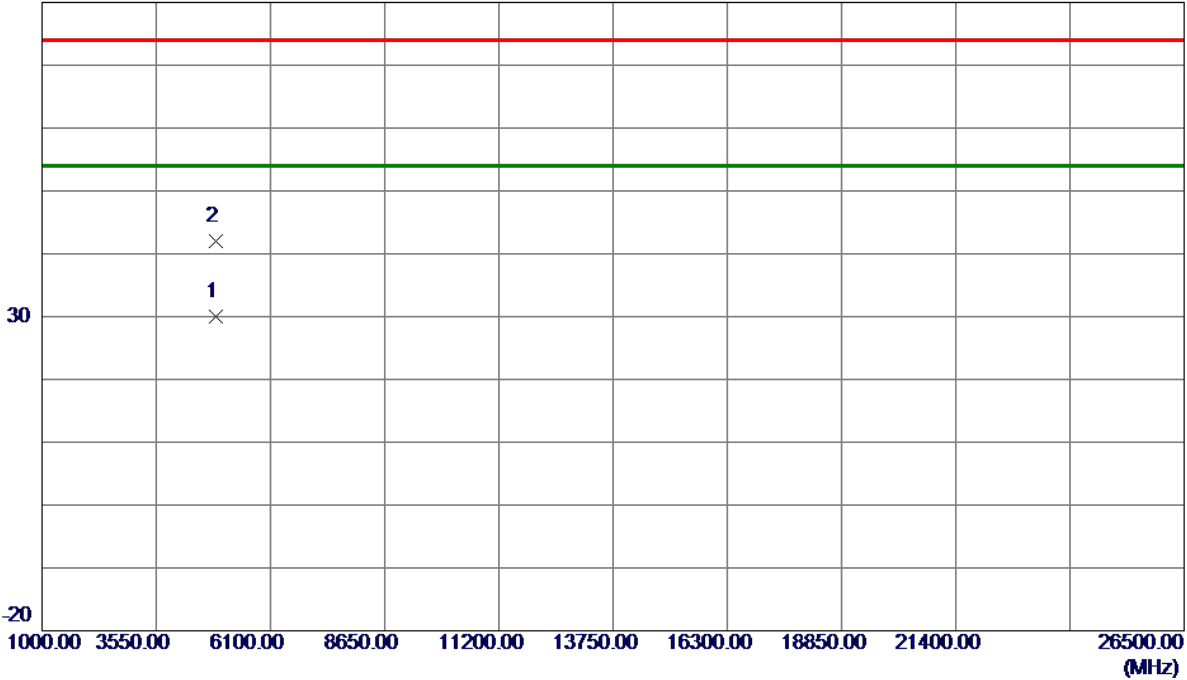

No.	Freq. MHz	Reading Level dBuV/m	Correct Factor dB	Measure ment dBuV/m	Limit dBuV/m	Margin dB	Detector	Comment
1 *	4873.7250	25.50	4.44	29.94	54.00	-24.06	AVG	
2	4875.6000	37.63	4.45	42.08	74.00	-31.92	Peak	

REMARKS:

- (1) Measurement Value = Reading Level + Correct Factor.
- (2) Margin Level = Measurement Value - Limit Value.

Orthogonal Axis	X
Test Mode:	TX N-40M Mode 2437 MHz

Horizontal

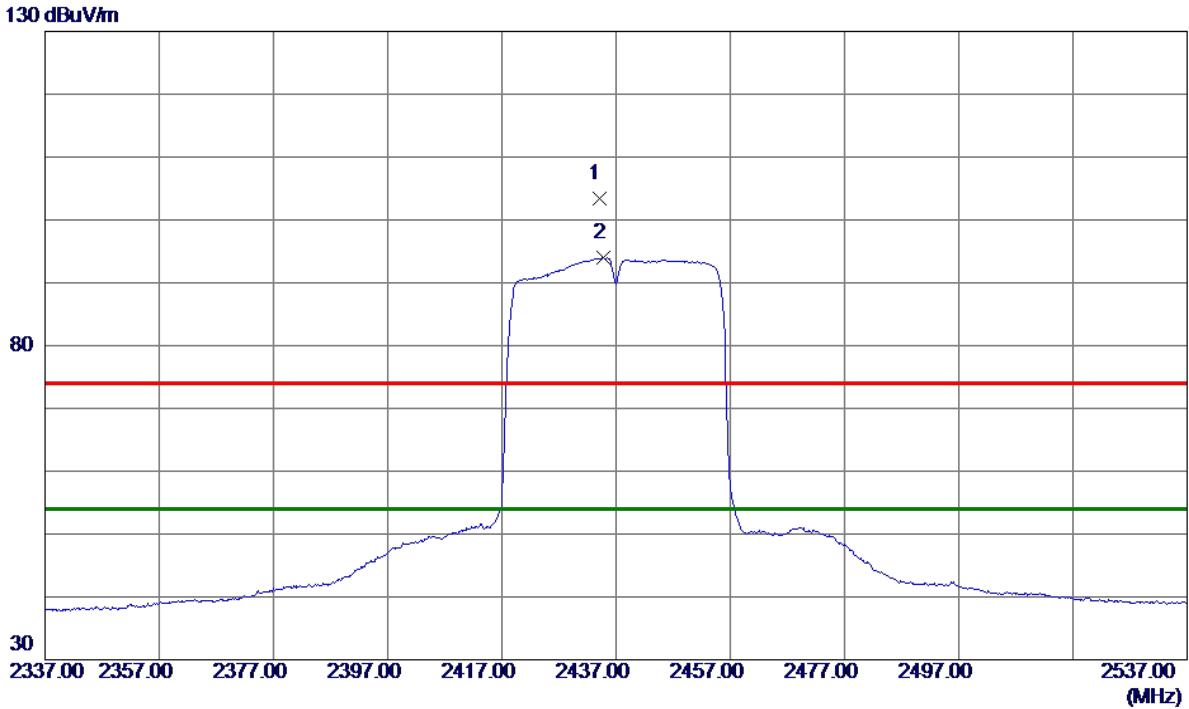

No.	Freq. MHz	Reading Level dBuV/m	Correct Factor dB	Measure ment dBuV/m	Limit dBuV/m	Margin dB	Detector	Comment
1	2434.0000	95.61	7.71	103.32	74.00	29.32	Peak	No Limit
2 *	2434.8000	86.25	7.71	93.96	54.00	39.96	AVG	No Limit

REMARKS:

- (1) Measurement Value = Reading Level + Correct Factor.
- (2) Margin Level = Measurement Value - Limit Value.

Orthogonal Axis	X
Test Mode:	TX N-40M Mode 2437 MHz

Horizontal

80 dBuV/m

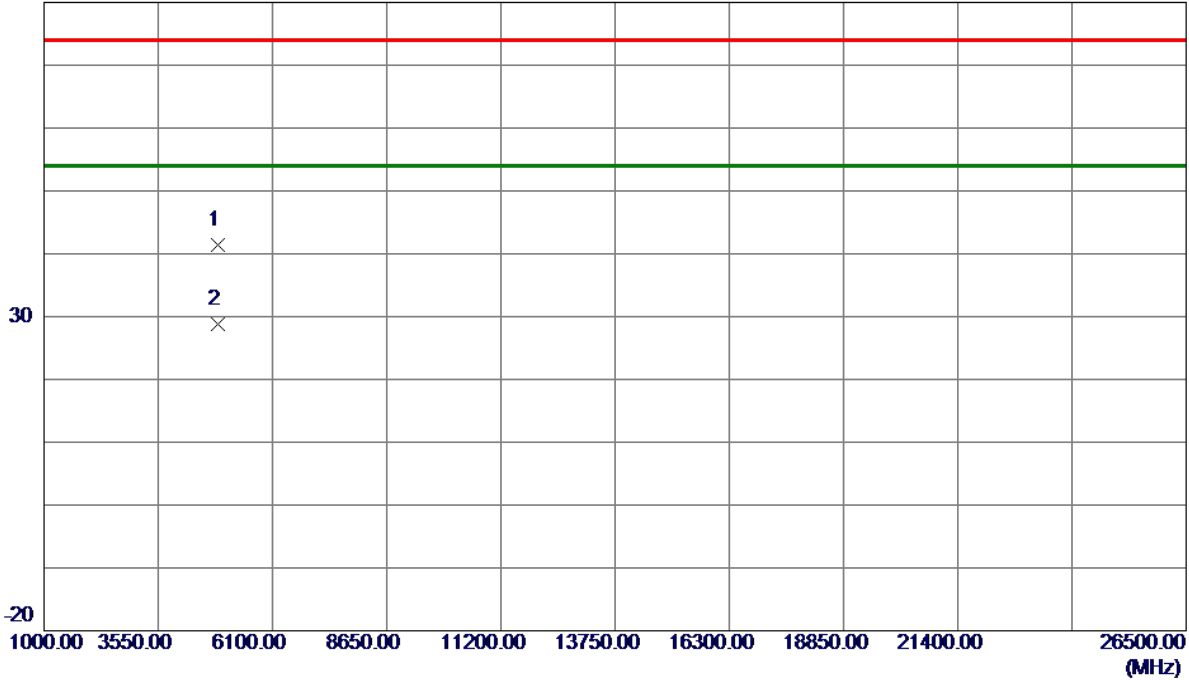

No.	Freq. MHz	Reading Level dBuV/m	Correct Factor dB	Measure ment dBuV/m	Limit dBuV/m	Margin dB	Detector	Comment
1	4871.8900	36.93	4.43	41.36	74.00	-32.64	Peak	
2 *	4872.9400	24.34	4.44	28.78	54.00	-25.22	AVG	

REMARKS:

- (1) Measurement Value = Reading Level + Correct Factor.
- (2) Margin Level = Measurement Value - Limit Value.

Orthogonal Axis	X
Test Mode:	TX N-40M Mode 2447 MHz

Vertical

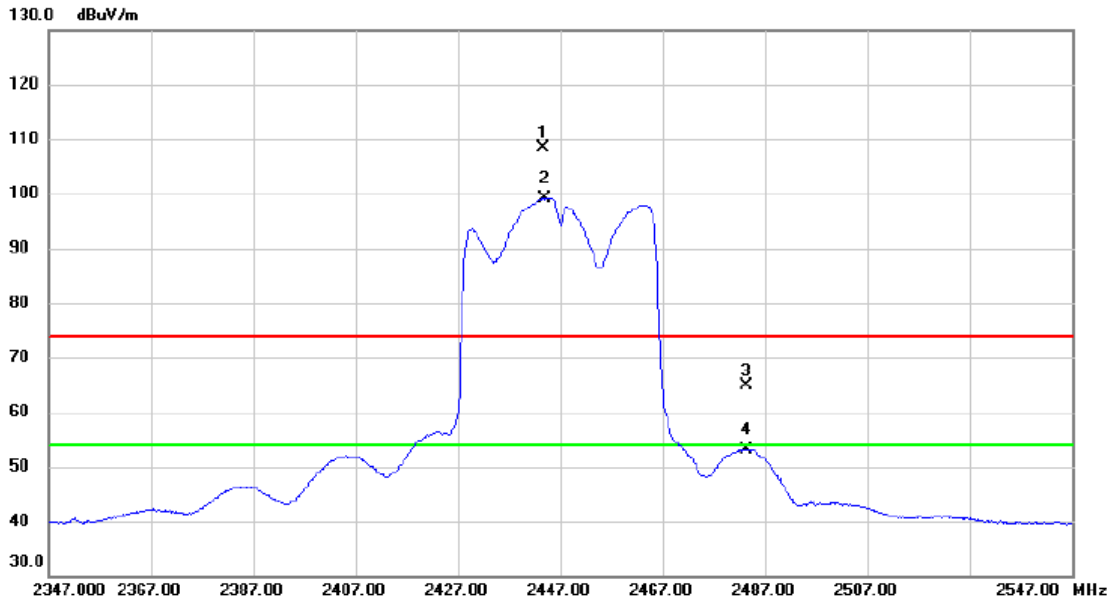

No.	Mk.	Freq. MHz	Reading Level dBuV	Correct Factor dB	Measure- ment dBuV/m	Limit dBuV/m	Margin dB	Detector	Comment
1	X	2443.700	100.74	7.75	108.49	74.00	34.49	peak	No Limit
2	*	2444.000	91.48	7.75	99.23	54.00	45.23	AVG	No Limit
3		2483.500	56.96	7.87	64.83	74.00	-9.17	peak	
4		2483.500	45.30	7.87	53.17	54.00	-0.83	AVG	

REMARKS:

- (1) Measurement Value = Reading Level + Correct Factor.
- (2) Margin Level = Measurement Value - Limit Value.

Orthogonal Axis	X
Test Mode:	TX N-40M Mode 2447 MHz

Vertical

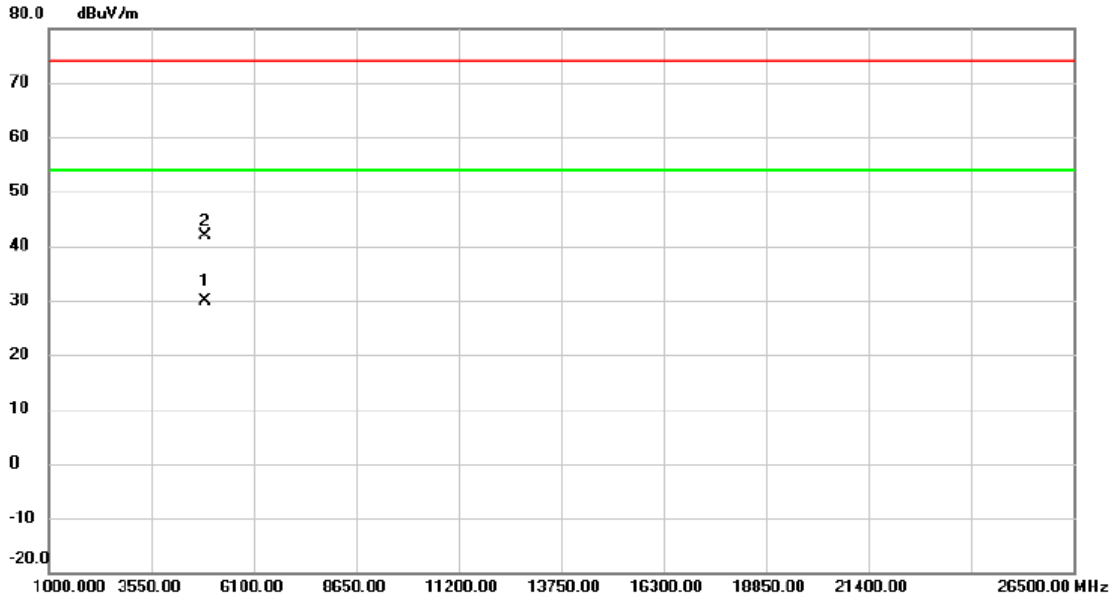

No.	Mk.	Freq.	Reading Level	Correct Factor	Measurement	Limit	Margin		
		MHz	dBuV	dB	dBuV/m	dBuV/m	dB	Detector	Comment
1	*	4887.920	25.39	4.49	29.88	54.00	-24.12	AVG	
2		4895.440	37.26	4.52	41.78	74.00	-32.22	peak	

REMARKS:

- (1) Measurement Value = Reading Level + Correct Factor.
- (2) Margin Level = Measurement Value - Limit Value.

Orthogonal Axis	X
Test Mode:	TX N-40M Mode 2447 MHz

Horizontal

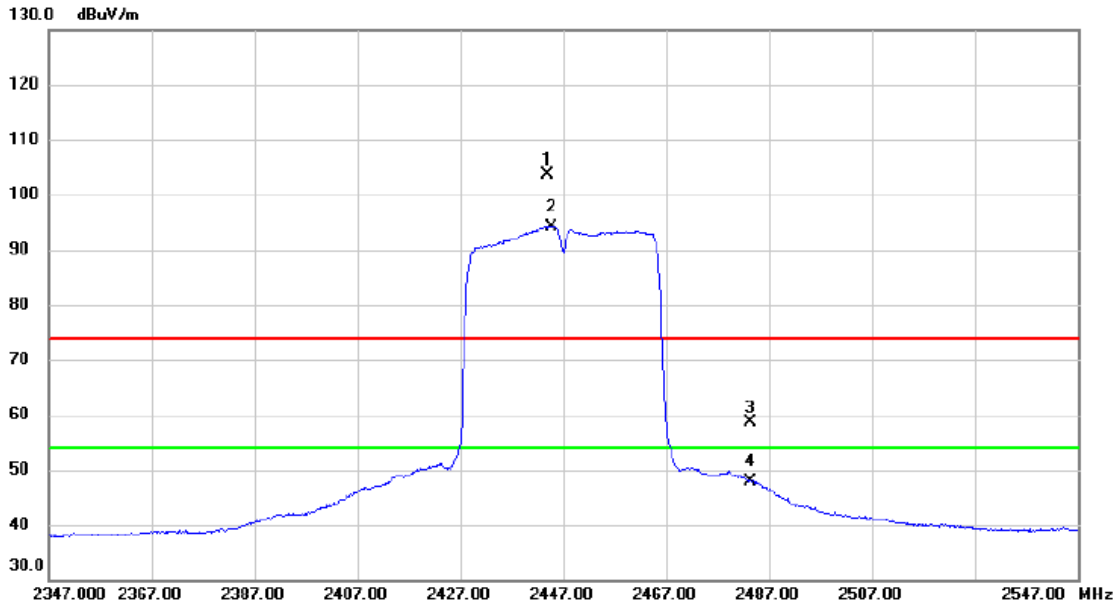

No.	Mk.	Freq. MHz	Reading Level dBuV	Correct Factor dB	Measure- ment dBuV/m	Limit dBuV/m	Margin dB	Detector	Comment
1	X	2443.800	95.85	7.75	103.60	74.00	29.60	peak	No Limit
2	*	2444.700	86.42	7.75	94.17	54.00	40.17	AVG	No Limit
3		2483.500	50.82	7.87	58.69	74.00	-15.31	peak	
4		2483.500	39.92	7.87	47.79	54.00	-6.21	AVG	

REMARKS:

- (1) Measurement Value = Reading Level + Correct Factor.
- (2) Margin Level = Measurement Value - Limit Value.

Orthogonal Axis	X
Test Mode:	TX N-40M Mode 2447 MHz

Horizontal

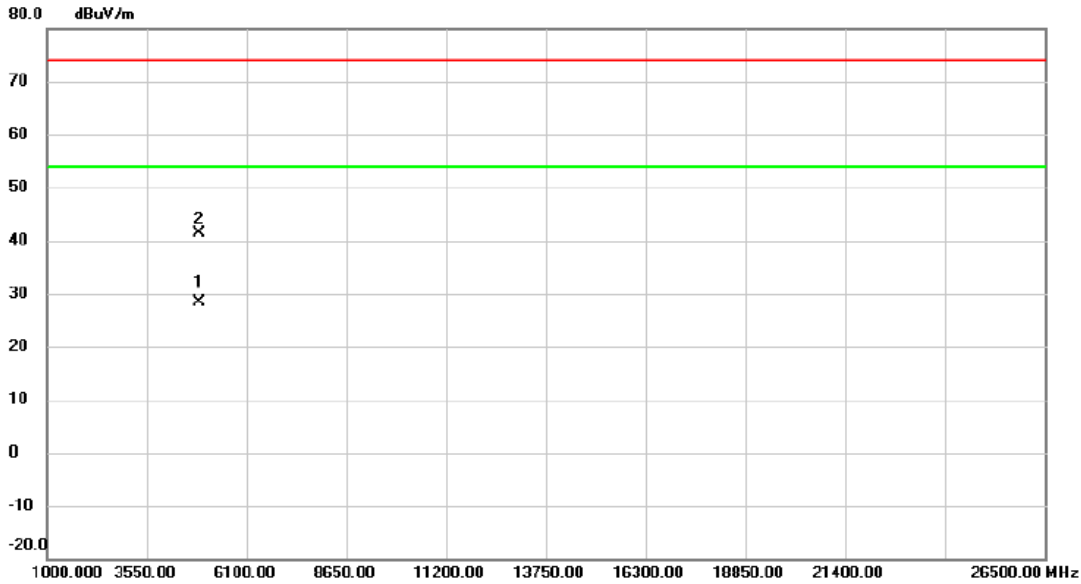

No. Mk.	Freq. MHz	Reading Level dBuV	Correct Factor dB	Measurement dBuV/m	Limit dBuV/m	Margin dB	Detector	Comment
1 *	4887.880	23.96	4.49	28.45	54.00	-25.55	AVG	
2	4897.450	36.90	4.54	41.44	74.00	-32.56	peak	

REMARKS:

- (1) Measurement Value = Reading Level + Correct Factor.
- (2) Margin Level = Measurement Value - Limit Value.

Orthogonal Axis	X
Test Mode:	TX N-40M Mode 2452 MHz

Vertical

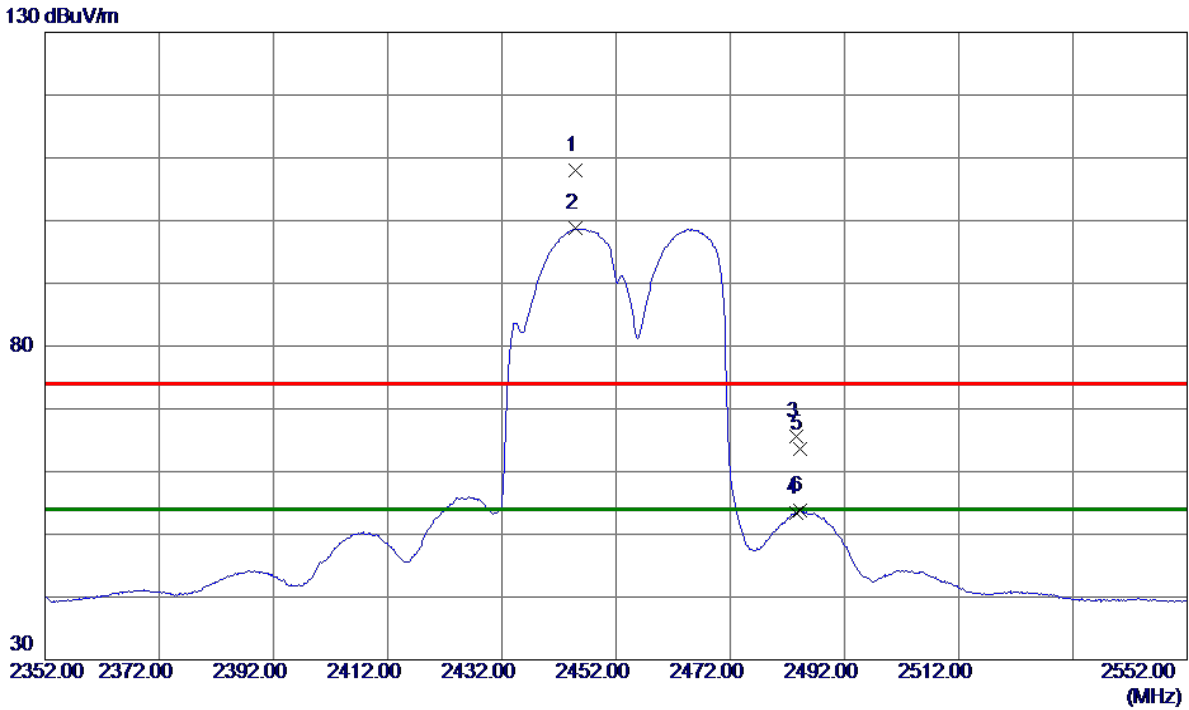

No.	Freq. MHz	Reading Level dBuV/m	Correct Factor dB	Measure ment dBuV/m	Limit dBuV/m	Margin dB	Detector	Comment
1	2444.8000	100.20	7.75	107.95	74.00	33.95	Peak	No Limit
2 *	2444.9000	90.97	7.75	98.72	54.00	44.72	AVG	No Limit
3	2483.5000	57.73	7.88	65.61	74.00	-8.39	Peak	
4	2483.5000	45.45	7.88	53.33	54.00	-0.67	AVG	
5	2484.3000	55.72	7.88	63.60	74.00	-10.40	Peak	
6	2484.3000	45.94	7.88	53.82	54.00	-0.18	AVG	

REMARKS:

- (1) Measurement Value = Reading Level + Correct Factor.
- (2) Margin Level = Measurement Value - Limit Value.

Orthogonal Axis	X
Test Mode:	TX N-40M Mode 2452 MHz

Vertical

80 dBuV/m

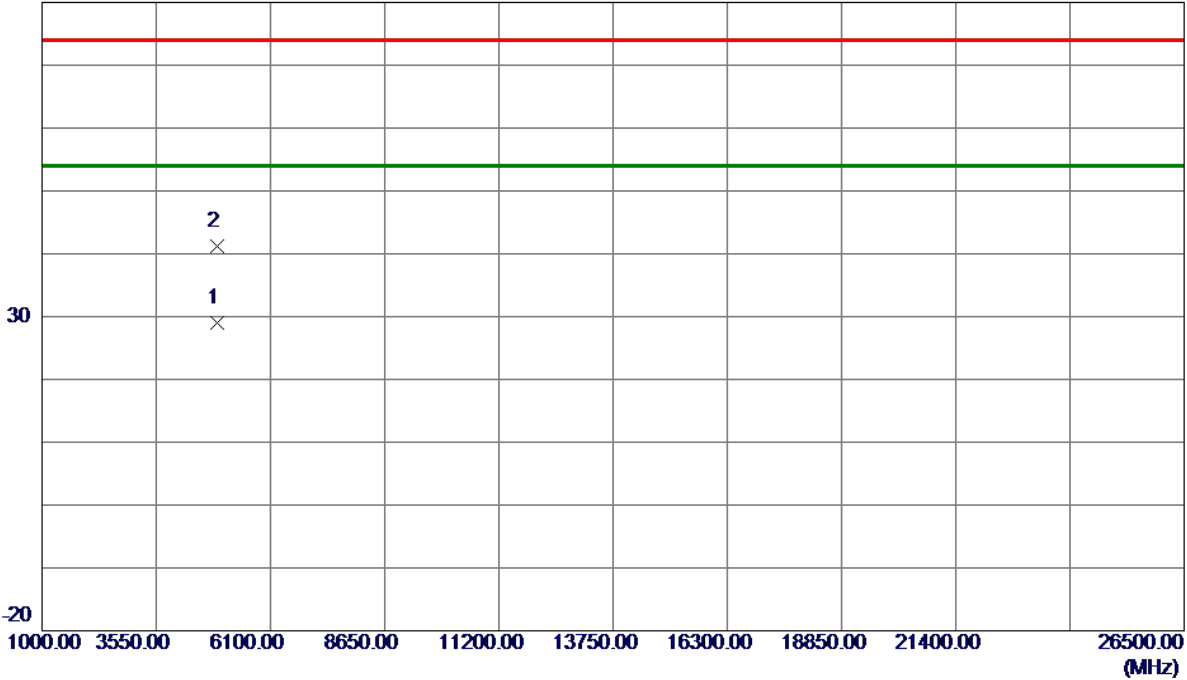

No.	Freq. MHz	Reading Level dBuV/m	Correct Factor dB	Measure ment dBuV/m	Limit dBuV/m	Margin dB	Detector	Comment
1 *	4901.1500	24.48	4.54	29.02	54.00	-24.98	AVG	
2	4908.9200	36.56	4.57	41.13	74.00	-32.87	Peak	

REMARKS:

- (1) Measurement Value = Reading Level + Correct Factor.
- (2) Margin Level = Measurement Value - Limit Value.

Orthogonal Axis	X
Test Mode:	TX N-40M Mode 2452 MHz

Horizontal

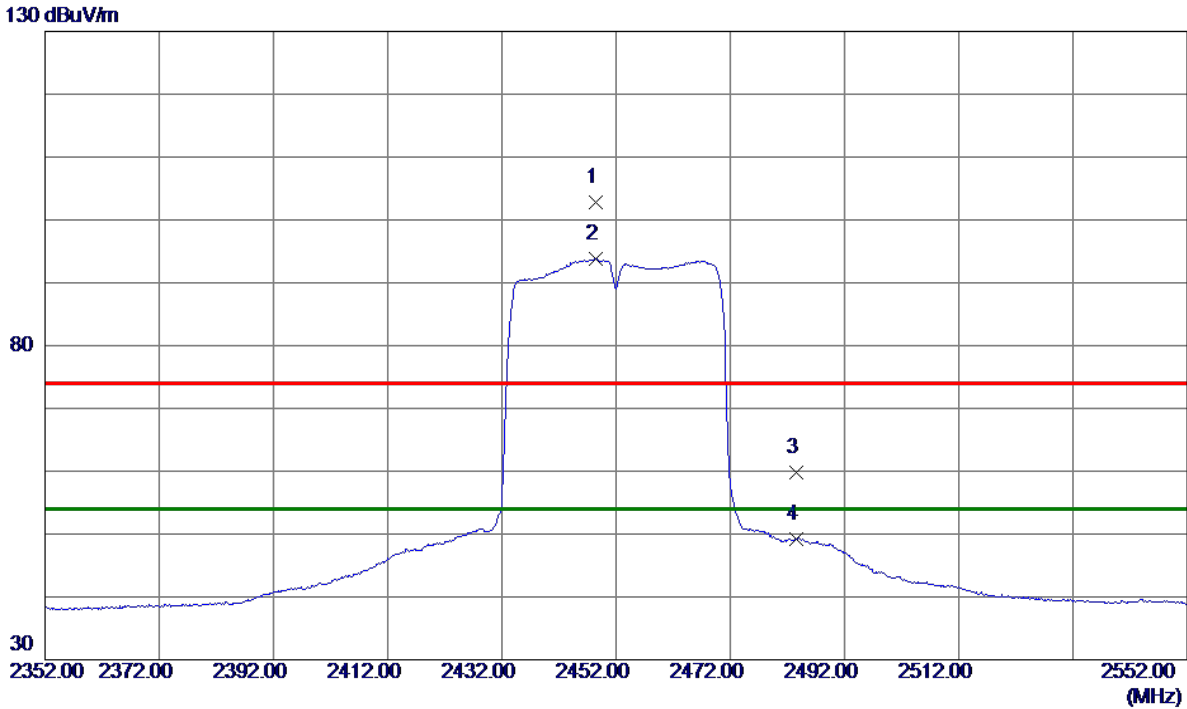

No.	Freq. MHz	Reading Level dBuV/m	Correct Factor dB	Measure ment dBuV/m	Limit dBuV/m	Margin dB	Detector	Comment
1	2448.4000	95.06	7.76	102.82	74.00	28.82	Peak	No Limit
2 *	2448.4000	86.05	7.76	93.81	54.00	39.81	AVG	No Limit
3	2483.5000	51.83	7.88	59.71	74.00	-14.29	Peak	
4	2483.5000	41.39	7.88	49.27	54.00	-4.73	AVG	

REMARKS:

- (1) Measurement Value = Reading Level + Correct Factor.
- (2) Margin Level = Measurement Value - Limit Value.

Orthogonal Axis	X
Test Mode:	TX N-40M Mode 2452 MHz

Horizontal

80 dBuV/m

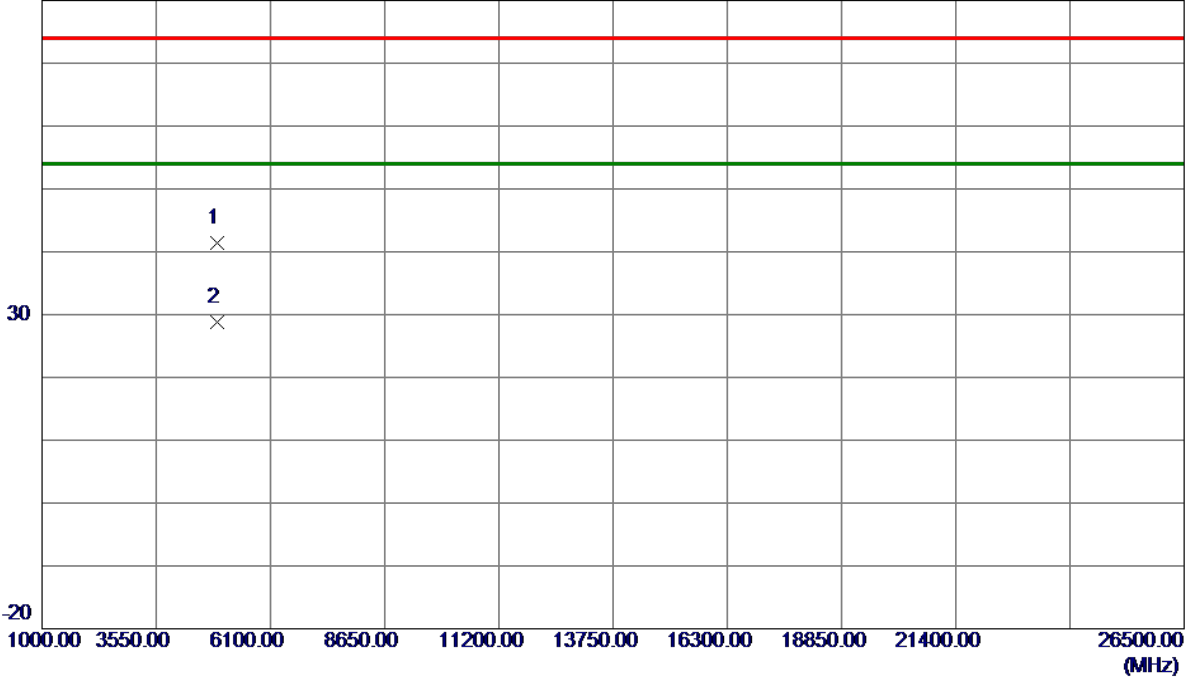

No.	Freq. MHz	Reading Level dBuV/m	Correct Factor dB	Measure ment dBuV/m	Limit dBuV/m	Margin dB	Detector	Comment
1	4902.7000	36.78	4.55	41.33	74.00	-32.67	Peak	
2 *	4903.4000	24.20	4.55	28.75	54.00	-25.25	AVG	

REMARKS:

- (1) Measurement Value = Reading Level + Correct Factor.
- (2) Margin Level = Measurement Value - Limit Value.

Beamforming

Orthogonal Axis	X
Test Mode:	TX N-20M Mode 2412 MHz

Vertical

130 dBuV/m

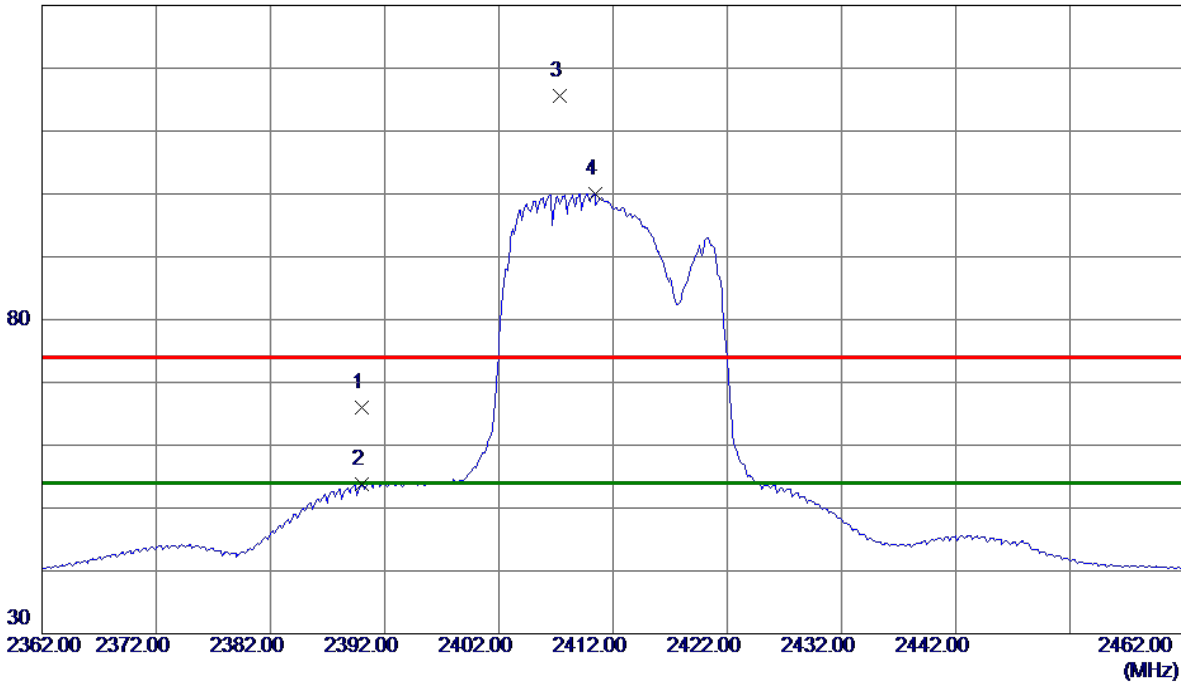

No.	Freq. MHz	Reading Level dBuV/m	Correct Factor dB	Measure ment dBuV/m	Limit dBuV/m	Margin dB	Detector	Comment
1	2390.0000	58.42	7.56	65.98	74.00	-8.02	Peak	
2	2390.0000	46.24	7.56	53.80	54.00	-0.20	AVG	
3	2407.3500	107.90	7.62	115.52	74.00	41.52	Peak	No Limit
4 *	2410.4000	92.31	7.63	99.94	54.00	45.94	AVG	No Limit

REMARKS:

- (1) Measurement Value = Reading Level + Correct Factor.
- (2) Margin Level = Measurement Value - Limit Value.

Orthogonal Axis	X
Test Mode:	TX N-20M Mode 2412 MHz

Vertical

80 dBuV/m

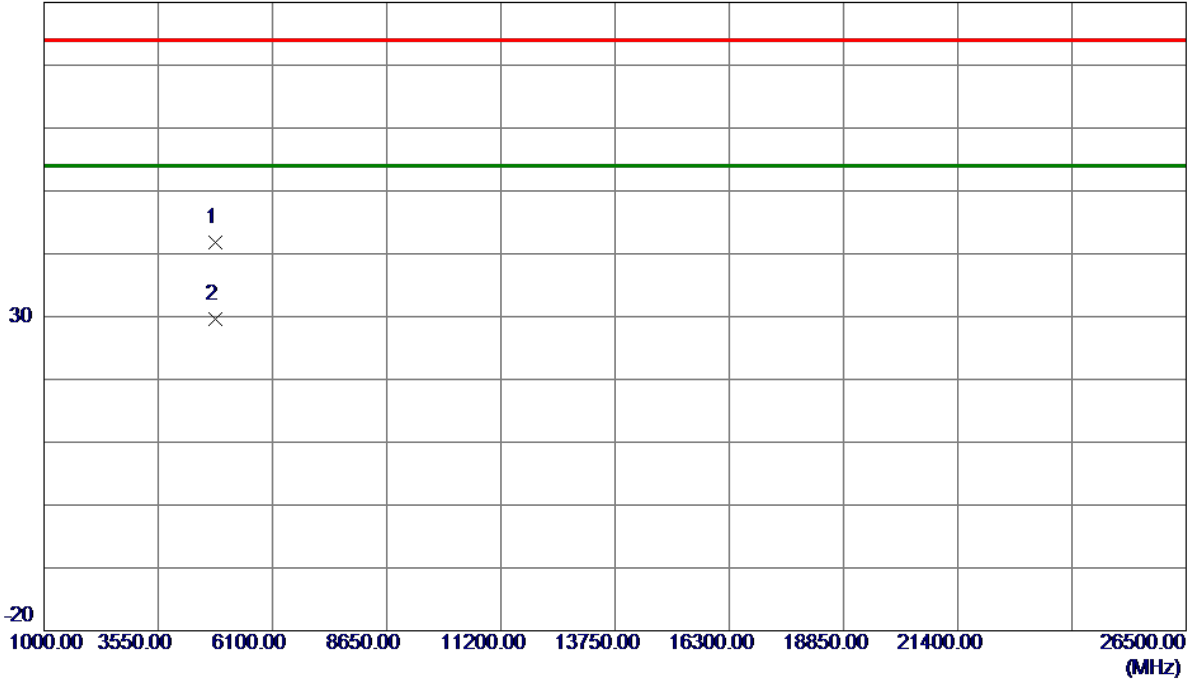

No.	Freq. MHz	Reading Level dBuV/m	Correct Factor dB	Measure ment dBuV/m	Limit dBuV/m	Margin dB	Detector	Comment
1	4823.3560	37.54	4.25	41.79	74.00	-32.21	Peak	
2 *	4823.4320	25.34	4.25	29.59	54.00	-24.41	AVG	

REMARKS:

- (1) Measurement Value = Reading Level + Correct Factor.
- (2) Margin Level = Measurement Value - Limit Value.

Orthogonal Axis	X
Test Mode:	TX N-20M Mode 2412 MHz

Horizontal

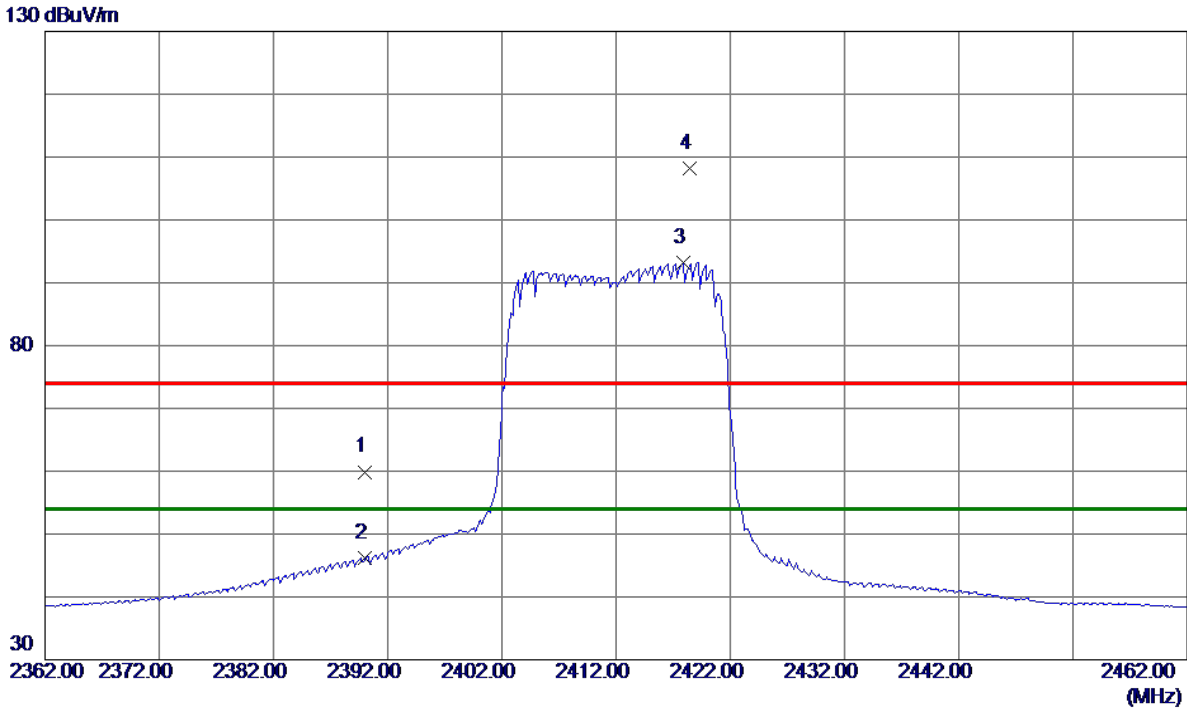

No.	Freq. MHz	Reading Level dBuV/m	Correct Factor dB	Measure ment dBuV/m	Limit dBuV/m	Margin dB	Detector	Comment
1	2390.0000	52.34	7.56	59.90	74.00	-14.10	Peak	
2	2390.0000	38.55	7.56	46.11	54.00	-7.89	AVG	
3 *	2417.8500	85.50	7.66	93.16	54.00	39.16	AVG	No Limit
4	2418.4500	100.52	7.66	108.18	74.00	34.18	Peak	No Limit

REMARKS:

- (1) Measurement Value = Reading Level + Correct Factor.
- (2) Margin Level = Measurement Value - Limit Value.

Orthogonal Axis	X
Test Mode:	TX N-20M Mode 2412 MHz

Horizontal

80 dBuV/m

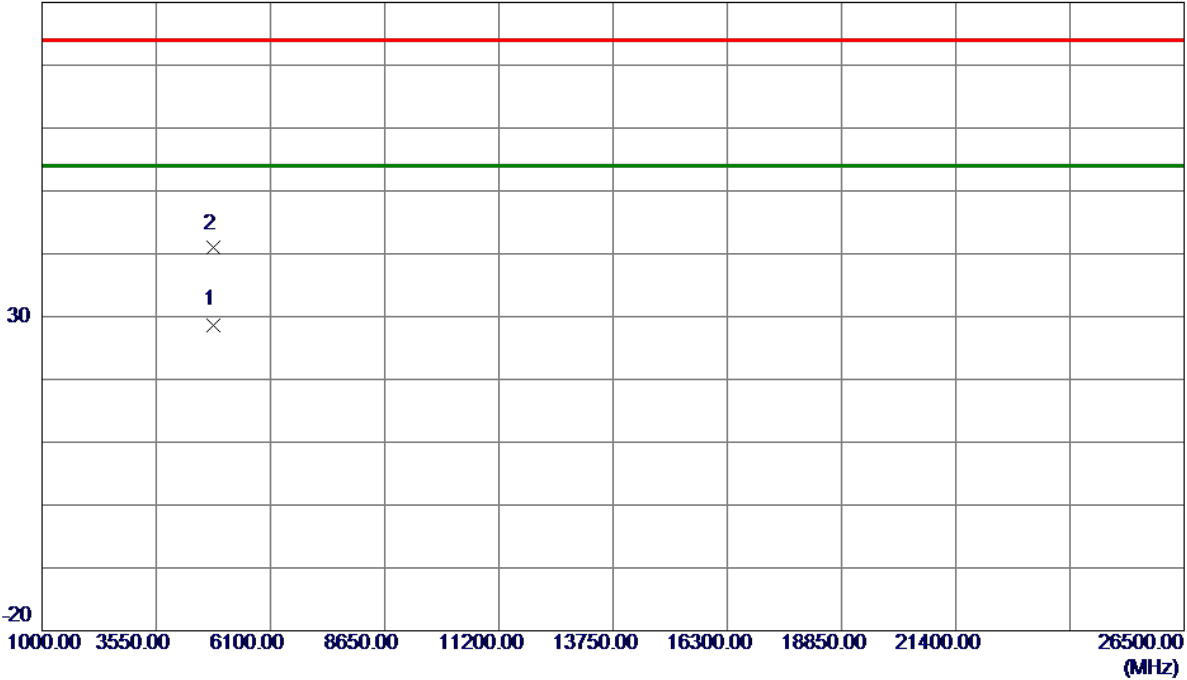

No.	Freq. MHz	Reading Level dBuV/m	Correct Factor dB	Measure ment dBuV/m	Limit dBuV/m	Margin dB	Detector	Comment
1 *	4822.7330	24.45	4.25	28.70	54.00	-25.30	AVG	
2	4823.0200	36.65	4.25	40.90	74.00	-33.10	Peak	

REMARKS:

- (1) Measurement Value = Reading Level + Correct Factor.
- (2) Margin Level = Measurement Value - Limit Value.

Orthogonal Axis	X
Test Mode:	TX N-20M Mode 2417 MHz

Vertical

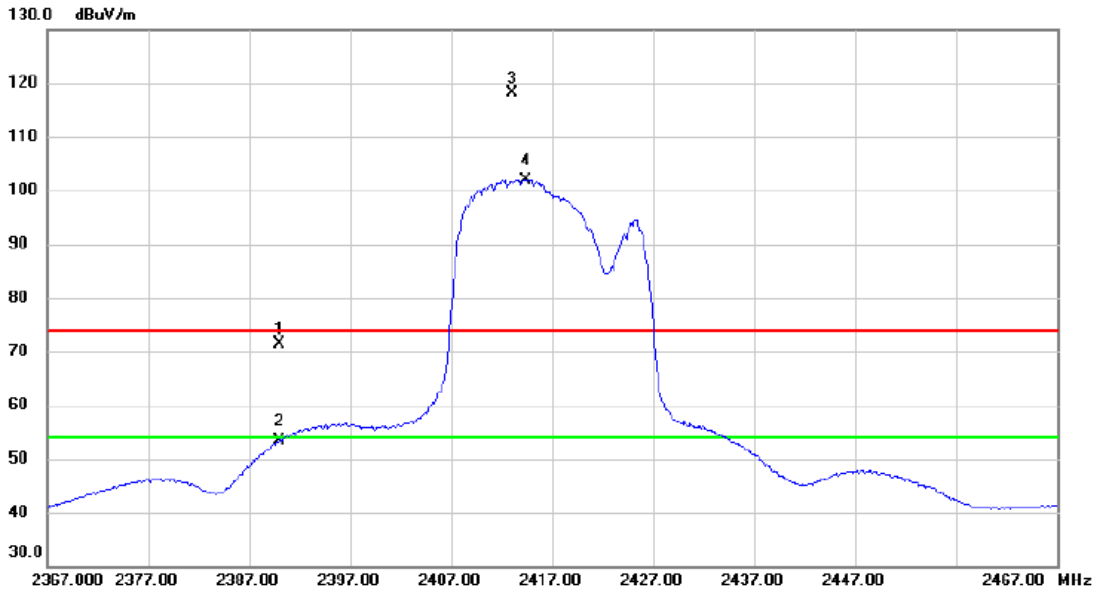

No.	Mk.	Freq. MHz	Reading Level dBuV	Correct Factor dB	Measure- ment dBuV/m	Limit dBuV/m	Margin dB	Detector	Comment
1		2390.000	63.76	7.57	71.33	74.00	-2.67	peak	
2		2390.000	45.93	7.57	53.50	54.00	-0.50	AVG	
3	X	2413.000	110.36	7.65	118.01	74.00	44.01	peak	No Limit
4	*	2414.350	94.21	7.65	101.86	54.00	47.86	AVG	No Limit

REMARKS:

(1) Measurement Value = Reading Level + Correct Factor.

(2) Margin Level = Measurement Value - Limit Value.

Orthogonal Axis	X
Test Mode:	TX N-20M Mode 2417 MHz

Vertical

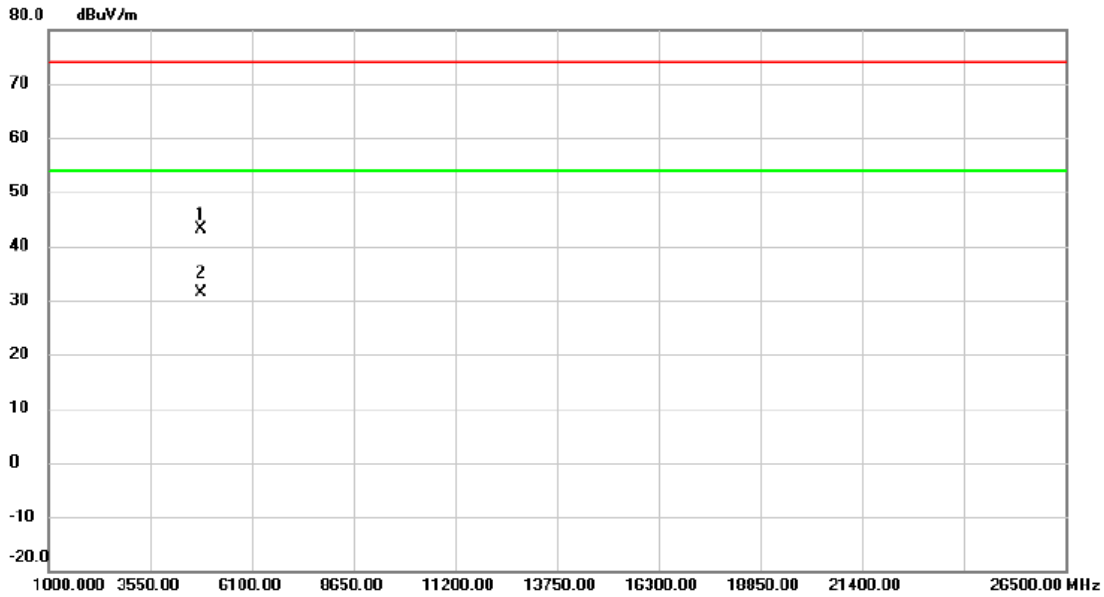

No.	Mk.	Freq. MHz	Reading Level dBuV	Correct Factor dB	Measure- ment dBuV/m	Limit dBuV/m	Margin dB	Detector	Comment
1		4834.420	38.92	4.30	43.22	74.00	-30.78	peak	
2	*	4835.350	27.17	4.30	31.47	54.00	-22.53	AVG	

REMARKS:

- (1) Measurement Value = Reading Level + Correct Factor.
- (2) Margin Level = Measurement Value - Limit Value.

Orthogonal Axis	X
Test Mode:	TX N-20M Mode 2417 MHz

Horizontal

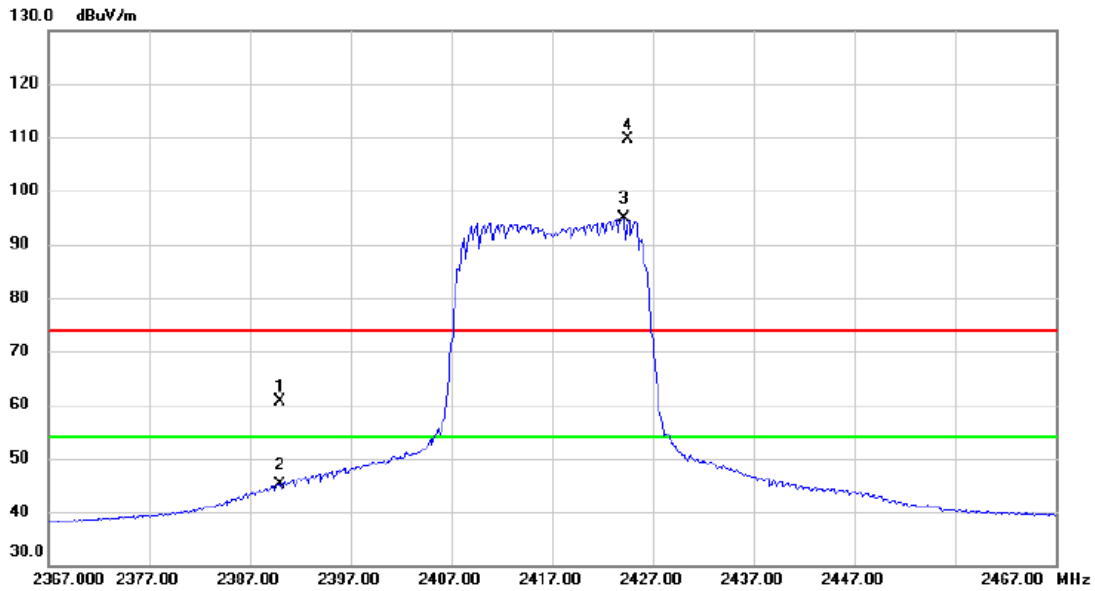

No.	Mk.	Freq. MHz	Reading Level dBuV	Correct Factor dB	Measure- ment dBuV/m	Limit dBuV/m	Margin dB	Detector	Comment
1		2390.000	53.10	7.57	60.67	74.00	-13.33	peak	
2		2390.000	37.62	7.57	45.19	54.00	-8.81	AVG	
3	*	2424.100	87.11	7.68	94.79	54.00	40.79	AVG	No Limit
4	X	2424.600	101.84	7.68	109.52	74.00	35.52	peak	No Limit

REMARKS:

- (1) Measurement Value = Reading Level + Correct Factor.
- (2) Margin Level = Measurement Value - Limit Value.

Orthogonal Axis	X
Test Mode:	TX N-20M Mode 2417 MHz

Horizontal

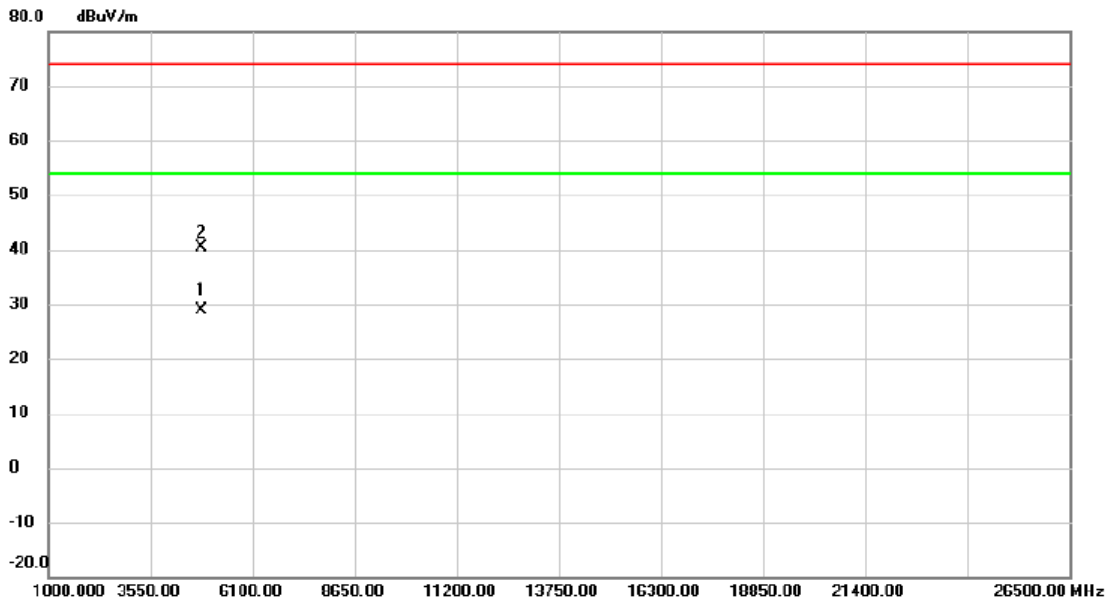

No.	Mk.	Freq. MHz	Reading Level dBuV	Correct Factor dB	Measure- ment dBuV/m	Limit dBuV/m	Margin dB	Detector	Comment
1	*	4823.180	24.50	4.26	28.76	54.00	-25.24	AVG	
2		4825.880	36.19	4.26	40.45	74.00	-33.55	peak	

REMARKS:

- (1) Measurement Value = Reading Level + Correct Factor.
- (2) Margin Level = Measurement Value - Limit Value.

Orthogonal Axis	X
Test Mode:	TX N-20M Mode 2437 MHz

Vertical

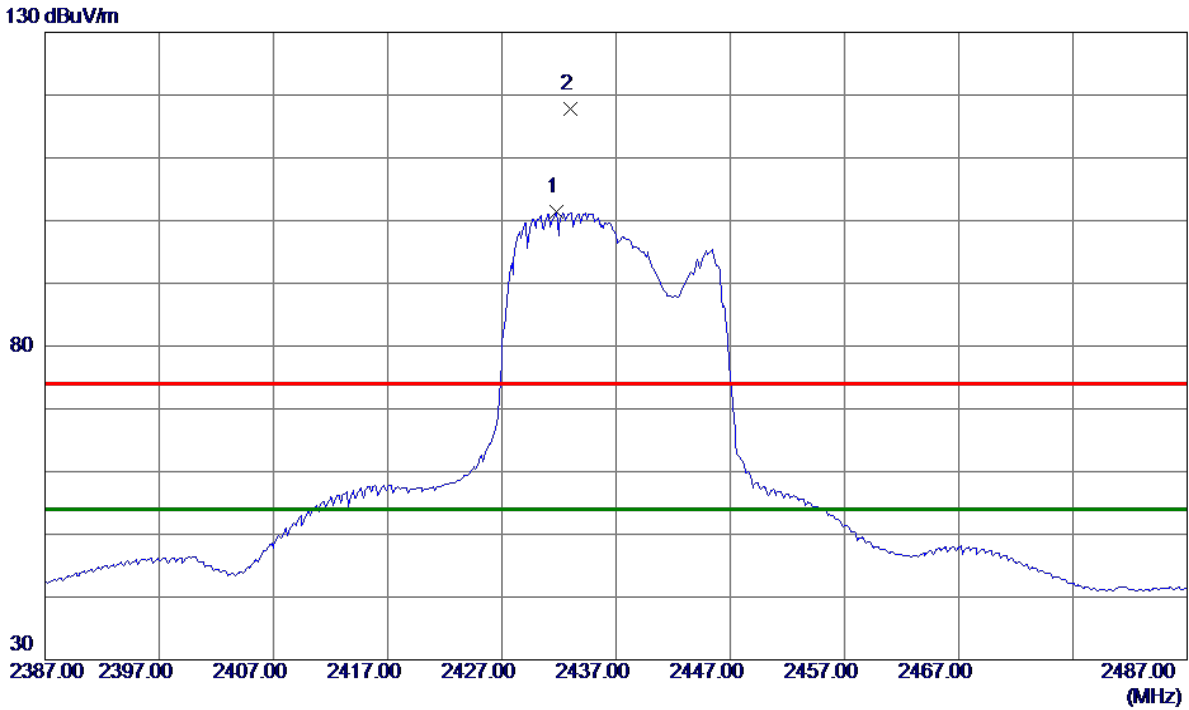

No.	Freq. MHz	Reading Level dBuV/m	Correct Factor dB	Measure ment dBuV/m	Limit dBuV/m	Margin dB	Detector	Comment
1 *	2431.8000	93.61	7.70	101.31	54.00	47.31	AVG	No Limit
2	2432.9500	110.06	7.71	117.77	74.00	43.77	Peak	No Limit

REMARKS:

- (1) Measurement Value = Reading Level + Correct Factor.
- (2) Margin Level = Measurement Value - Limit Value.

Orthogonal Axis	X
Test Mode:	TX N-20M Mode 2437 MHz

Vertical

80 dBuV/m

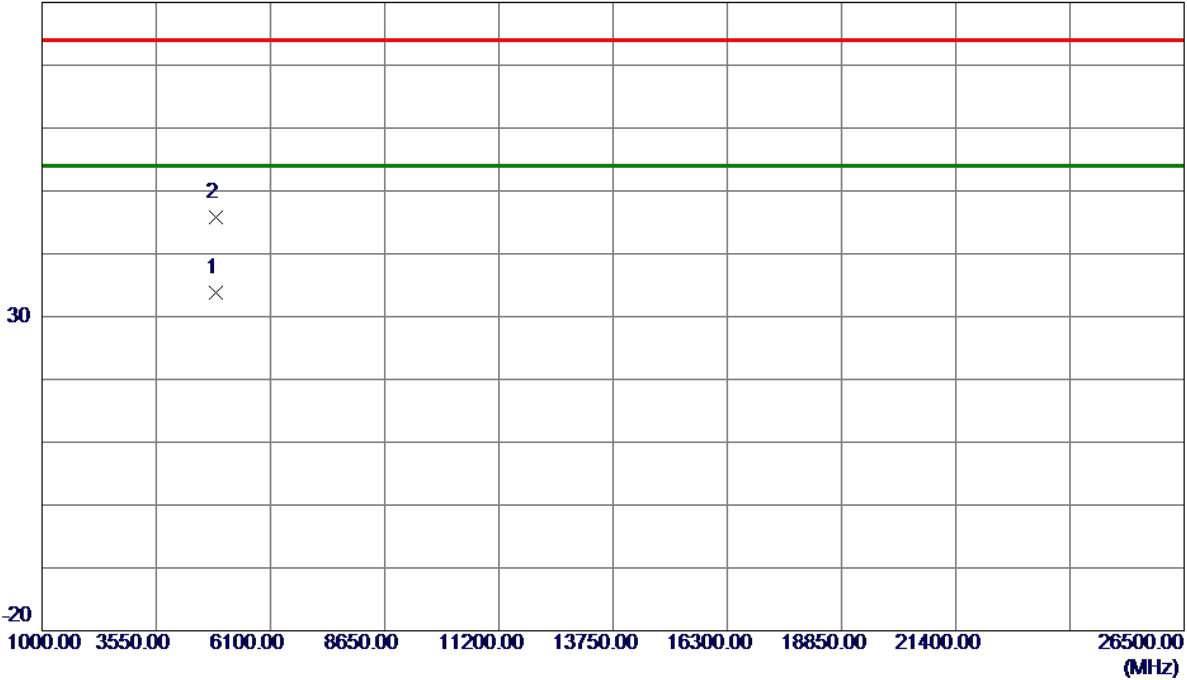

No.	Freq. MHz	Reading Level dBuV/m	Correct Factor dB	Measure ment dBuV/m	Limit dBuV/m	Margin dB	Detector	Comment
1 *	4873.7000	29.44	4.44	33.88	54.00	-20.12	AVG	
2	4874.0500	41.30	4.44	45.74	74.00	-28.26	Peak	

REMARKS:

- (1) Measurement Value = Reading Level + Correct Factor.
- (2) Margin Level = Measurement Value - Limit Value.

Orthogonal Axis	X
Test Mode:	TX N-20M Mode 2437 MHz

Horizontal

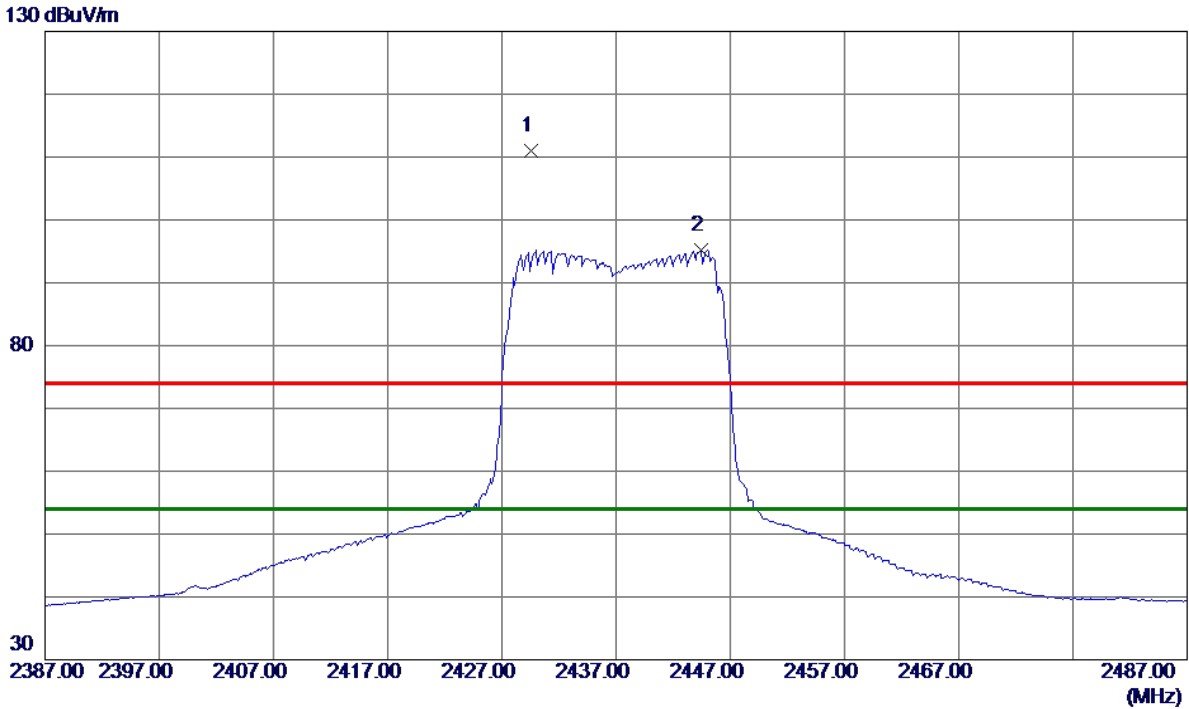

No.	Freq. MHz	Reading Level dBuV/m	Correct Factor dB	Measure ment dBuV/m	Limit dBuV/m	Margin dB	Detector	Comment
1	2429.5500	103.24	7.70	110.94	74.00	36.94	Peak	No Limit
2 *	2444.4500	87.43	7.75	95.18	54.00	41.18	AVG	No Limit

REMARKS:

- (1) Measurement Value = Reading Level + Correct Factor.
- (2) Margin Level = Measurement Value - Limit Value.

Orthogonal Axis	X
Test Mode:	TX N-20M Mode 2437 MHz

Horizontal

80 dBuV/m

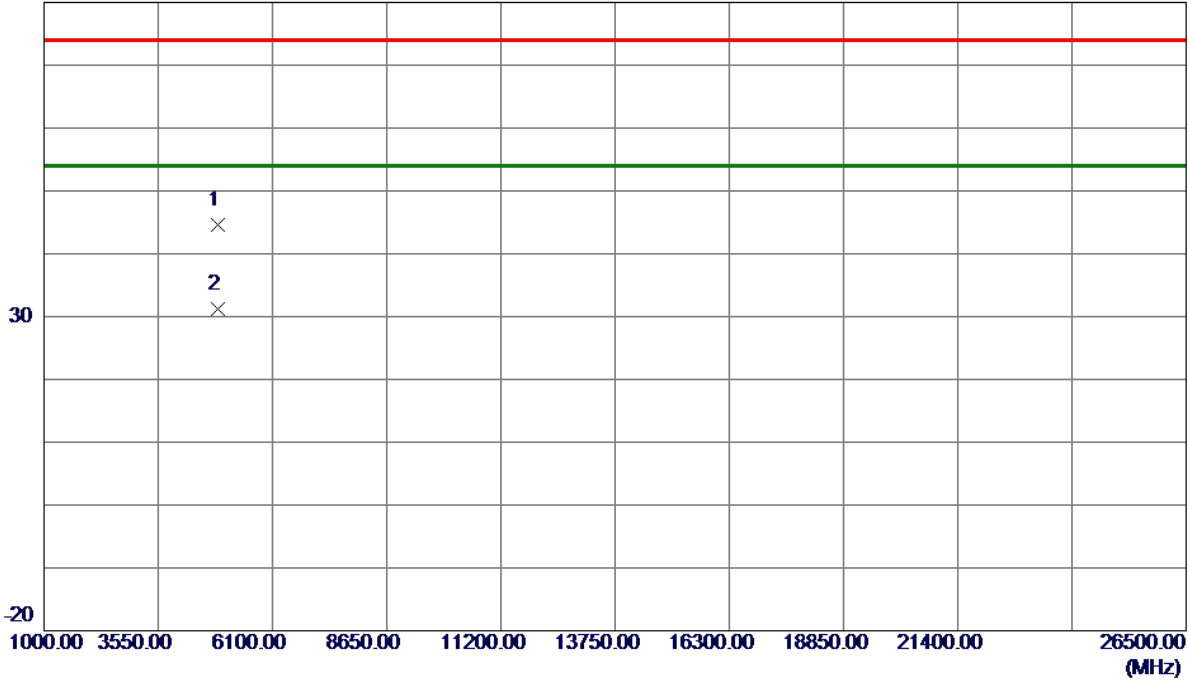

No.	Freq. MHz	Reading Level dBuV/m	Correct Factor dB	Measure ment dBuV/m	Limit dBuV/m	Margin dB	Detector	Comment
1	4873.0540	40.16	4.44	44.60	74.00	-29.40	Peak	
2 *	4874.2000	26.73	4.44	31.17	54.00	-22.83	AVG	

REMARKS:

- (1) Measurement Value = Reading Level + Correct Factor.
- (2) Margin Level = Measurement Value - Limit Value.

Orthogonal Axis	X
Test Mode:	TX N-20M Mode 2457 MHz

Vertical

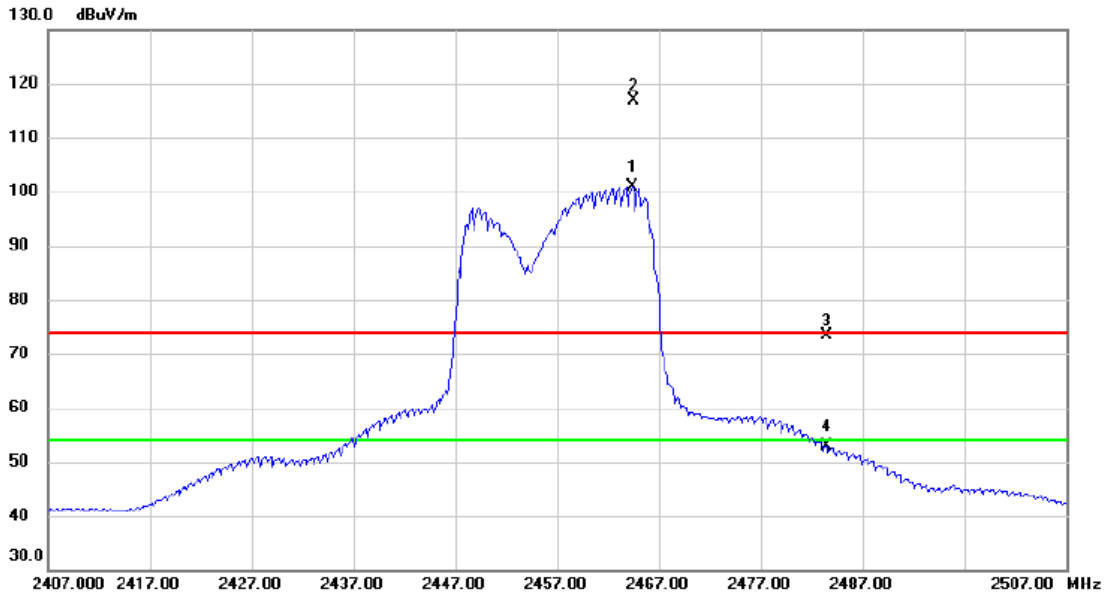

No.	Mk.	Freq. MHz	Reading Level dBuV	Correct Factor dB	Measure- ment dBuV/m	Limit dBuV/m	Margin dB	Detector	Comment
1	*	2464.450	93.15	7.81	100.96	54.00	46.96	AVG	No Limit
2	X	2464.550	109.13	7.81	116.94	74.00	42.94	peak	No Limit
3		2483.500	65.60	7.87	73.47	74.00	-0.53	peak	
4		2483.500	45.12	7.87	52.99	54.00	-1.01	AVG	

REMARKS:

- (1) Measurement Value = Reading Level + Correct Factor.
- (2) Margin Level = Measurement Value - Limit Value.

Orthogonal Axis	X
Test Mode:	TX N-20M Mode 2457 MHz

Vertical

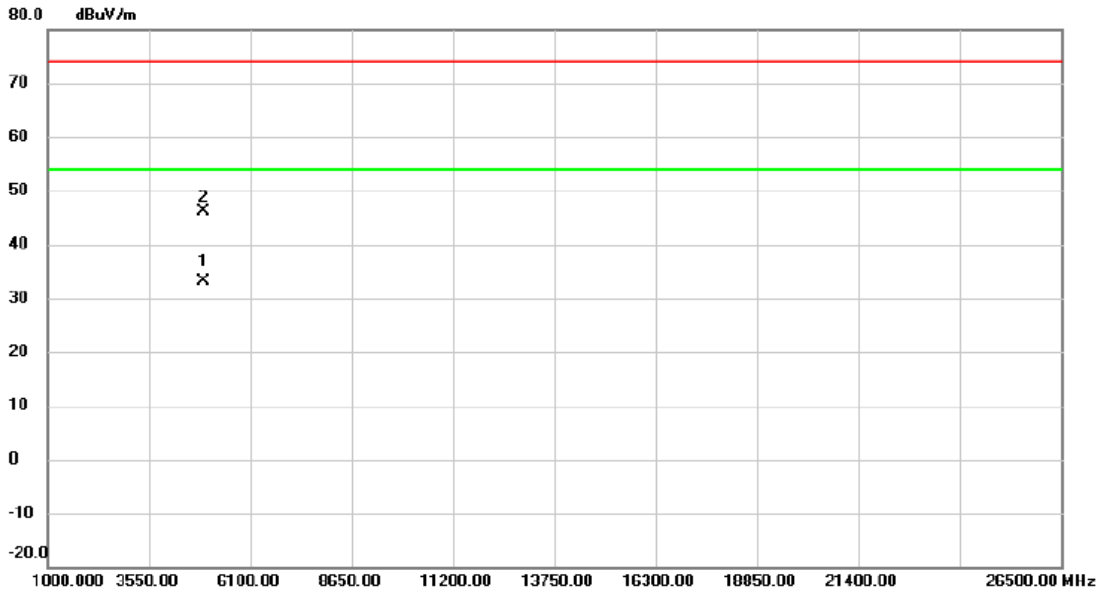

No.	Mk.	Freq. MHz	Reading Level dBuV	Correct Factor dB	Measure- ment dBuV/m	Limit dBuV/m	Margin dB	Detector	Comment
1	*	4913.925	28.55	4.58	33.13	54.00	-20.87	AVG	
2		4914.825	41.56	4.59	46.15	74.00	-27.85	peak	

REMARKS:

- (1) Measurement Value = Reading Level + Correct Factor.
- (2) Margin Level = Measurement Value - Limit Value.

Orthogonal Axis	X
Test Mode:	TX N-20M Mode 2457 MHz

Horizontal

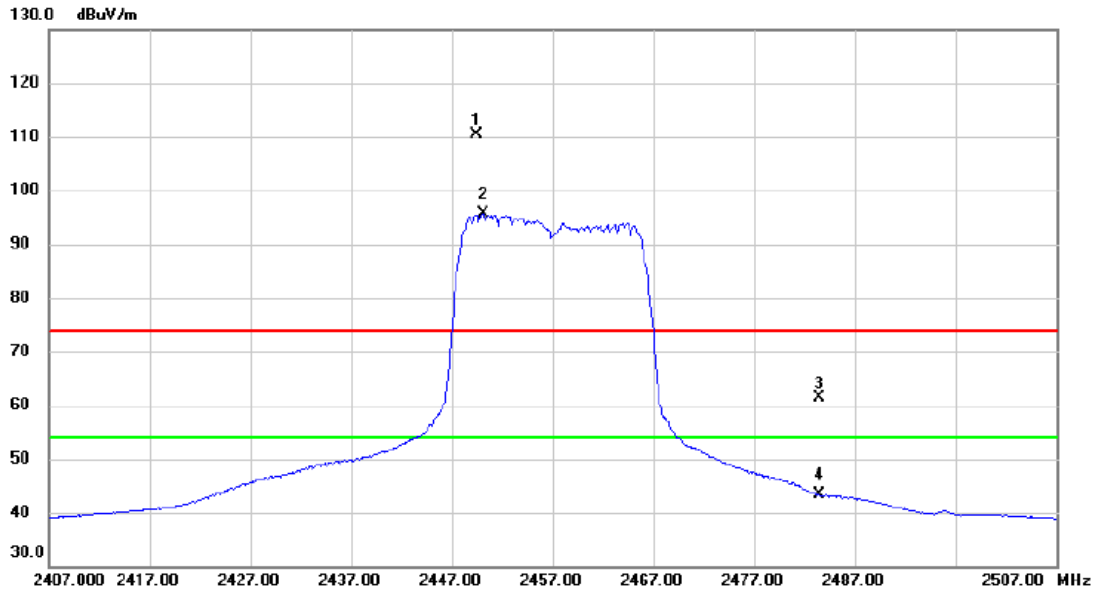

No.	Mk.	Freq. MHz	Reading Level dBuV	Correct Factor dB	Measure- ment dBuV/m	Limit dBuV/m	Margin dB	Detector	Comment
1	X	2449.450	102.54	7.76	110.30	74.00	36.30	peak	No Limit
2	*	2450.100	87.81	7.76	95.57	54.00	41.57	AVG	No Limit
3		2483.500	53.40	7.87	61.27	74.00	-12.73	peak	
4		2483.500	35.45	7.87	43.32	54.00	-10.68	AVG	

REMARKS:

- (1) Measurement Value = Reading Level + Correct Factor.
- (2) Margin Level = Measurement Value - Limit Value.

Orthogonal Axis	X
Test Mode:	TX N-20M Mode 2457 MHz

Horizontal

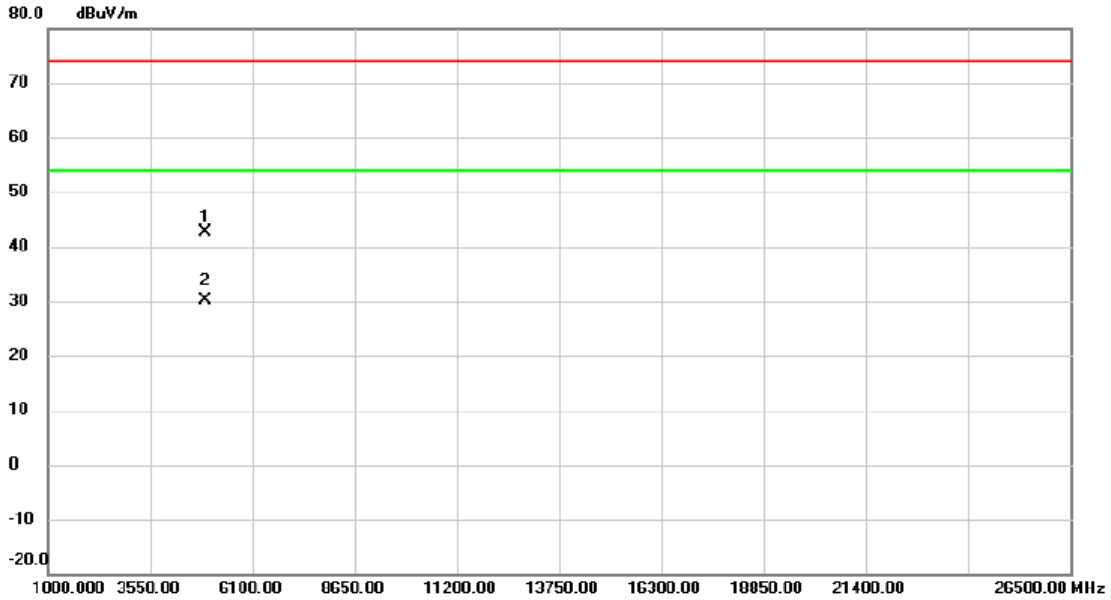

No.	Mk.	Freq. MHz	Reading Level dBuV	Correct Factor dB	Measure- ment dBuV/m	Limit dBuV/m	Margin dB	Detector	Comment
1		4914.475	38.09	4.58	42.67	74.00	-31.33	peak	
2	*	4914.750	25.52	4.59	30.11	54.00	-23.89	AVG	

REMARKS:

- (1) Measurement Value = Reading Level + Correct Factor.
- (2) Margin Level = Measurement Value - Limit Value.

Orthogonal Axis	X
Test Mode:	TX N-20M Mode 2462 MHz

Vertical

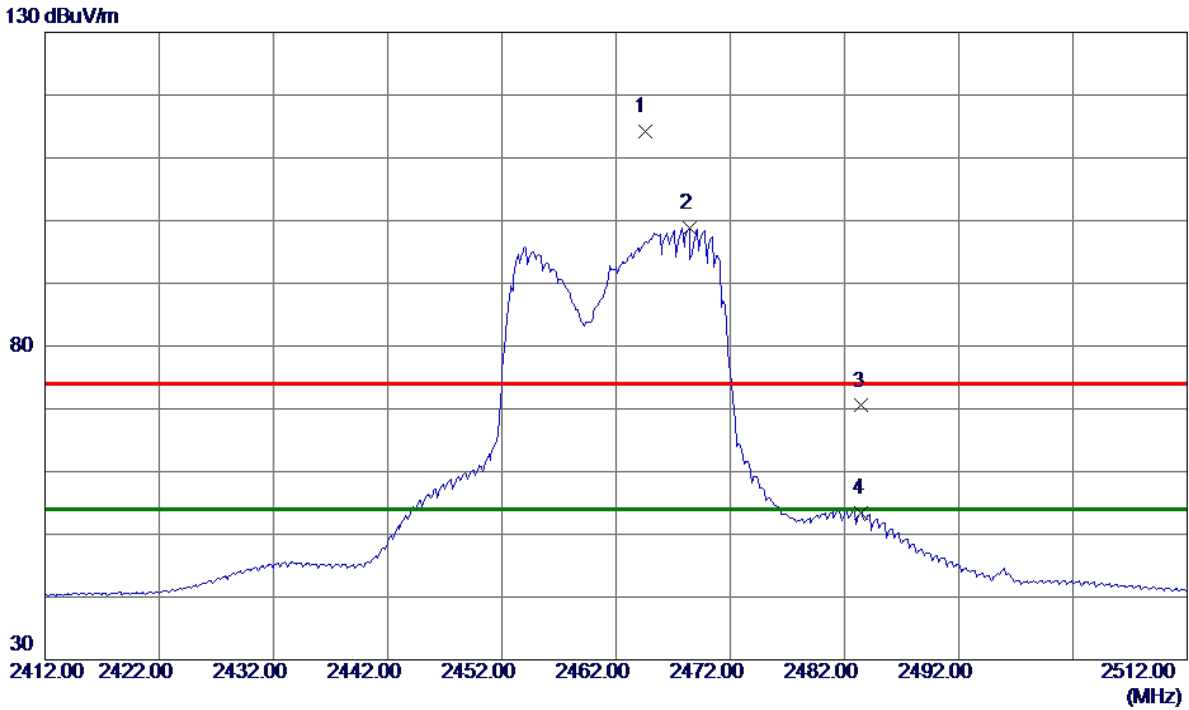

No.	Freq. MHz	Reading Level dBuV/m	Correct Factor dB	Measurement dBuV/m	Limit dBuV/m	Margin dB	Detector	Comment
1	2464.5000	106.36	7.81	114.17	74.00	40.17	Peak	No Limit
2 *	2468.4500	91.01	7.83	98.84	54.00	44.84	AVG	No Limit
3	2483.5000	62.62	7.88	70.50	74.00	-3.50	Peak	
4	2483.5000	45.57	7.88	53.45	54.00	-0.55	AVG	

REMARKS:

- (1) Measurement Value = Reading Level + Correct Factor.
- (2) Margin Level = Measurement Value - Limit Value.

Orthogonal Axis	X
Test Mode:	TX N-20M Mode 2462 MHz

Vertical

80 dBuV/m

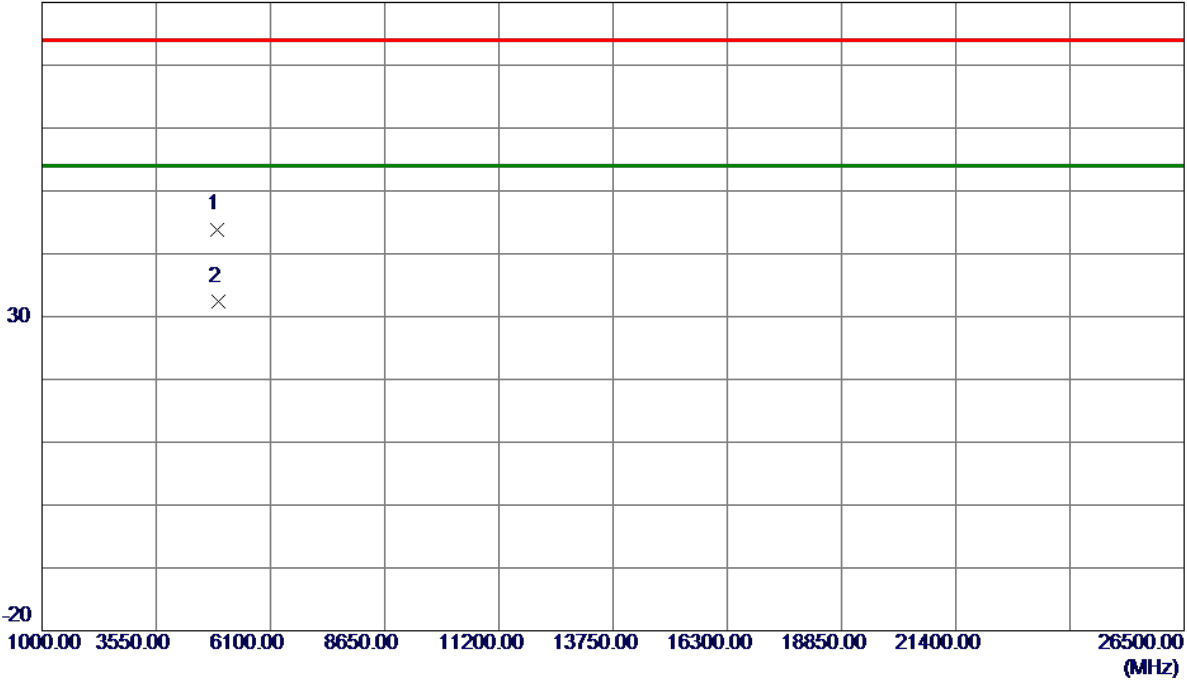

No.	Freq. MHz	Reading Level dBuV/m	Correct Factor dB	Measure ment dBuV/m	Limit dBuV/m	Margin dB	Detector	Comment
1	4923.4440	39.27	4.63	43.90	74.00	-30.10	Peak	
2 *	4924.2050	27.69	4.63	32.32	54.00	-21.68	AVG	

REMARKS:

- (1) Measurement Value = Reading Level + Correct Factor.
- (2) Margin Level = Measurement Value - Limit Value.

Orthogonal Axis	X
Test Mode:	TX N-20M Mode 2462 MHz

Horizontal

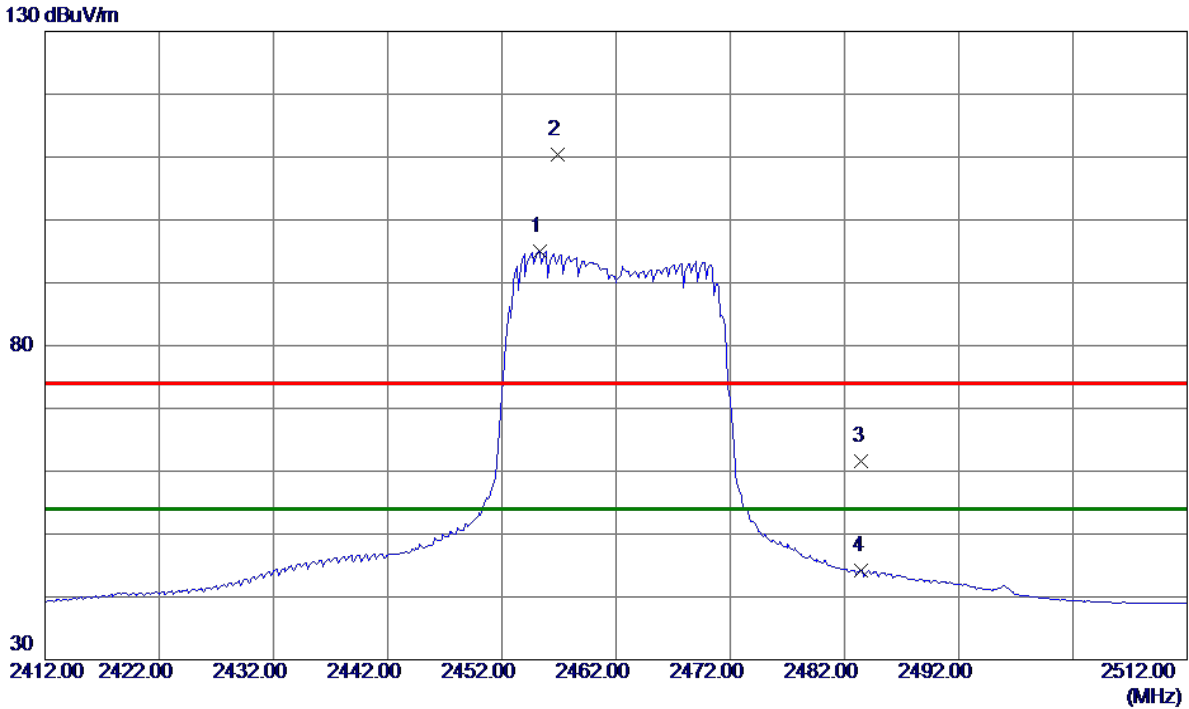

No.	Freq. MHz	Reading Level dBuV/m	Correct Factor dB	Measure ment dBuV/m	Limit dBuV/m	Margin dB	Detector	Comment
1 *	2455.3000	87.28	7.78	95.06	54.00	41.06	AVG	No Limit
2	2456.8500	102.54	7.79	110.33	74.00	36.33	Peak	No Limit
3	2483.5000	53.81	7.88	61.69	74.00	-12.31	Peak	
4	2483.5000	36.35	7.88	44.23	54.00	-9.77	AVG	

REMARKS:

- (1) Measurement Value = Reading Level + Correct Factor.
- (2) Margin Level = Measurement Value - Limit Value.

Orthogonal Axis	X
Test Mode:	TX N-20M Mode 2462 MHz

Horizontal

80 dBuV/m

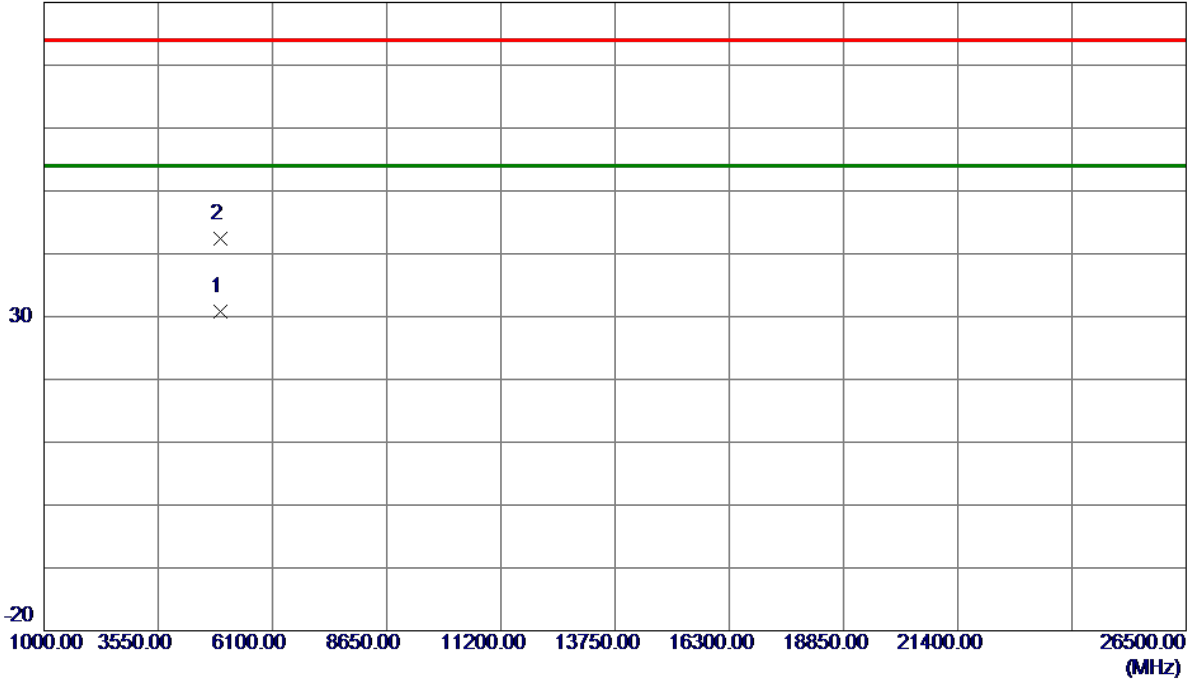

No.	Freq. MHz	Reading Level dBuV/m	Correct Factor dB	Measure ment dBuV/m	Limit dBuV/m	Margin dB	Detector	Comment
1 *	4926.6520	26.20	4.64	30.84	54.00	-23.16	AVG	
2	4928.3340	37.68	4.64	42.32	74.00	-31.68	Peak	

REMARKS:

- (1) Measurement Value = Reading Level + Correct Factor.
- (2) Margin Level = Measurement Value - Limit Value.

Orthogonal Axis	X
Test Mode:	TX N-40M Mode 2422MHz

Vertical

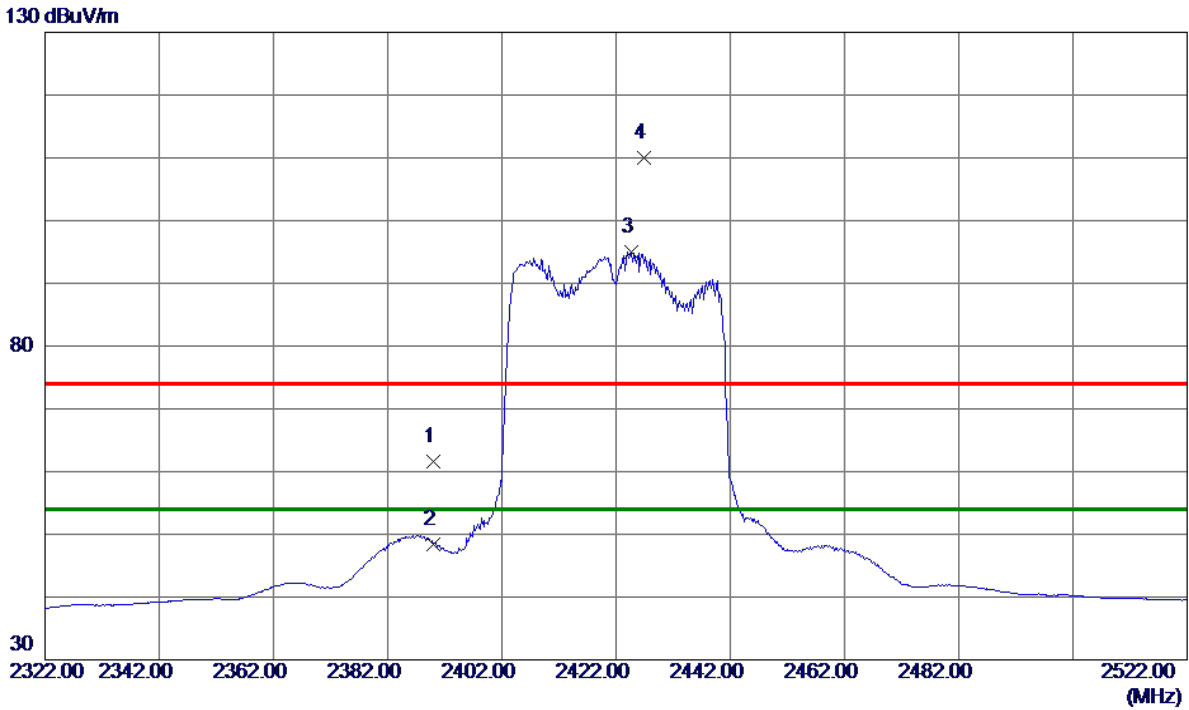

No.	Freq. MHz	Reading Level dBuV/m	Correct Factor dB	Measure ment dBuV/m	Limit dBuV/m	Margin dB	Detector	Comment
1	2390.0000	54.01	7.56	61.57	74.00	-12.43	Peak	
2	2390.0000	40.88	7.56	48.44	54.00	-5.56	AVG	
3 *	2424.6000	87.35	7.68	95.03	54.00	41.03	AVG	No Limit
4	2426.8000	102.35	7.69	110.04	74.00	36.04	Peak	No Limit

REMARKS:

- (1) Measurement Value = Reading Level + Correct Factor.
- (2) Margin Level = Measurement Value - Limit Value.

Orthogonal Axis	X
Test Mode:	TX N-40M Mode 2422MHz

Vertical

80 dBuV/m

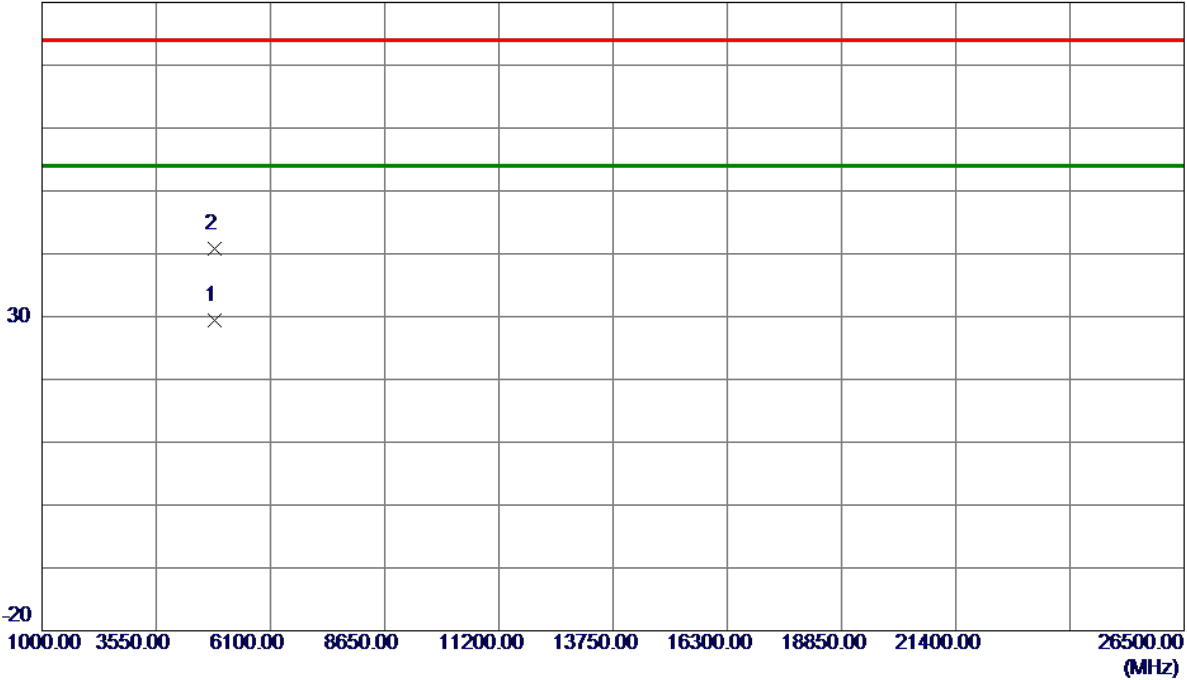

No.	Freq. MHz	Reading Level dBuV/m	Correct Factor dB	Measure ment dBuV/m	Limit dBuV/m	Margin dB	Detector	Comment
1 *	4843.0230	25.02	4.33	29.35	54.00	-24.65	AVG	
2	4844.1269	36.38	4.33	40.71	74.00	-33.29	Peak	

REMARKS:

- (1) Measurement Value = Reading Level + Correct Factor.
- (2) Margin Level = Measurement Value - Limit Value.

Orthogonal Axis	X
Test Mode:	TX N-40M Mode 2422MHz

Horizontal

130 dBuV/m

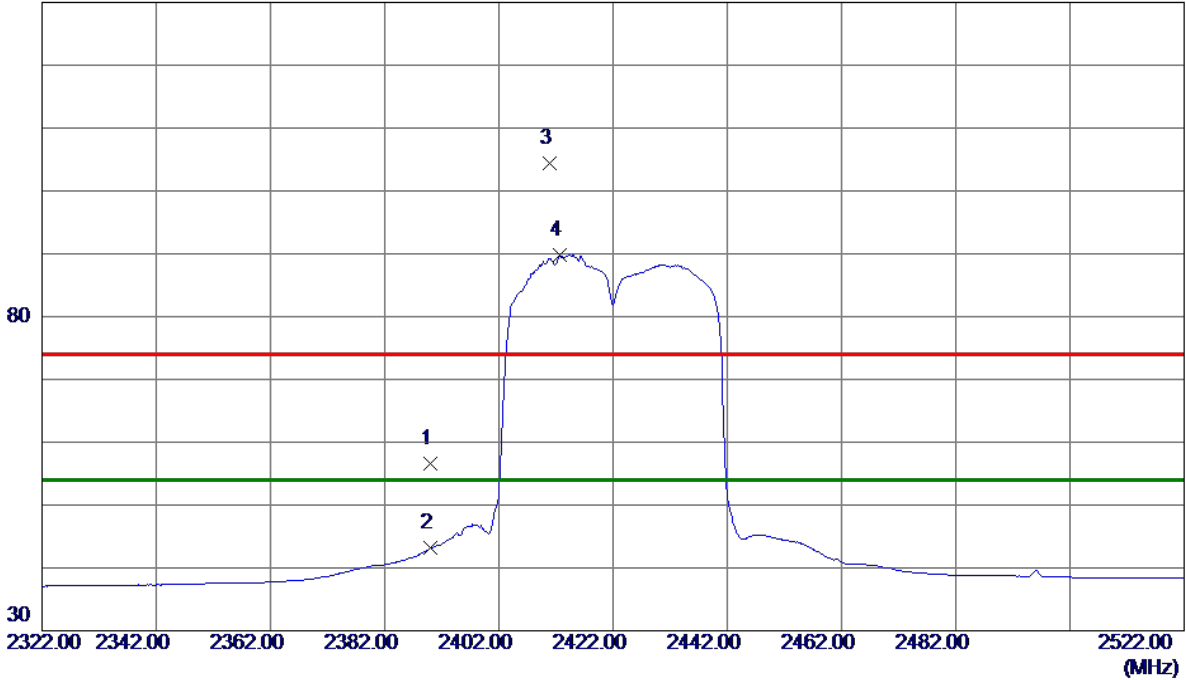

No.	Freq. MHz	Reading Level dBuV/m	Correct Factor dB	Measure ment dBuV/m	Limit dBuV/m	Margin dB	Detector	Comment
1	2390.0000	49.09	7.56	56.65	74.00	-17.35	Peak	
2	2390.0000	35.56	7.56	43.12	54.00	-10.88	AVG	
3	2410.8000	96.79	7.63	104.42	74.00	30.42	Peak	No Limit
4 *	2412.7000	82.18	7.64	89.82	54.00	35.82	AVG	No Limit

REMARKS:

- (1) Measurement Value = Reading Level + Correct Factor.
- (2) Margin Level = Measurement Value - Limit Value.

Orthogonal Axis	X
Test Mode:	TX N-40M Mode 2422MHz

Horizontal

80 dBuV/m

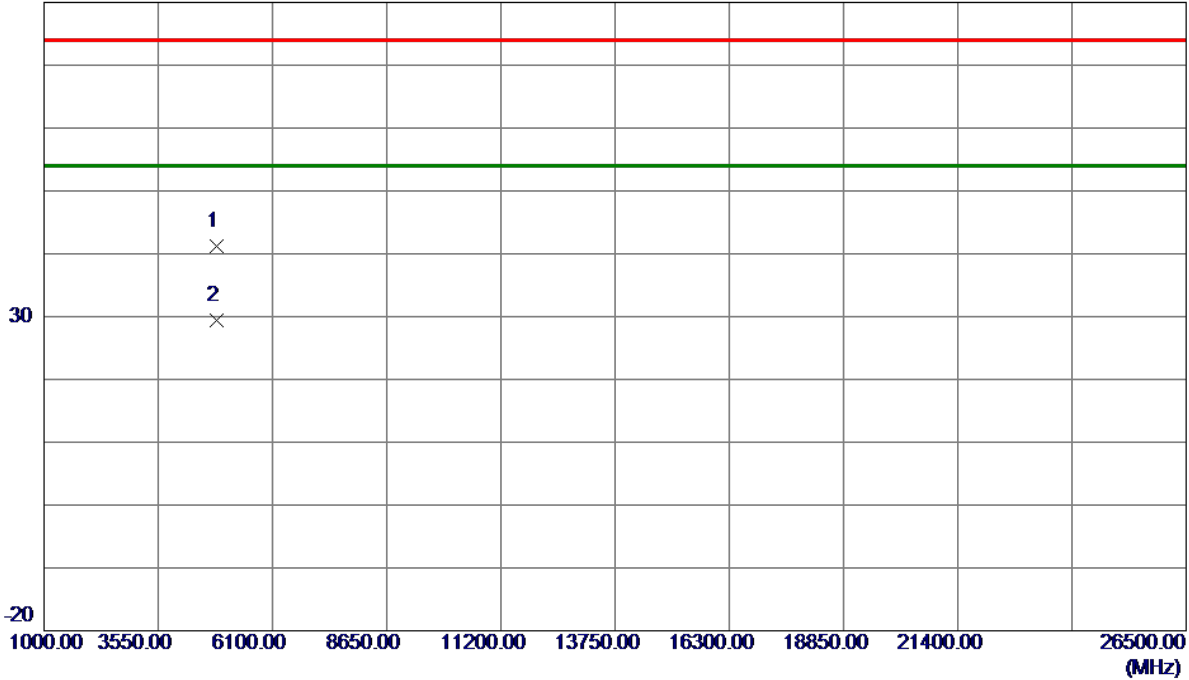

No.	Freq. MHz	Reading Level dBuV/m	Correct Factor dB	Measure ment dBuV/m	Limit dBuV/m	Margin dB	Detector	Comment
1	4849.2799	36.87	4.35	41.22	74.00	-32.78	Peak	
2 *	4850.6340	24.99	4.35	29.34	54.00	-24.66	AVG	

REMARKS:

- (1) Measurement Value = Reading Level + Correct Factor.
- (2) Margin Level = Measurement Value - Limit Value.

Orthogonal Axis	X
Test Mode:	TX N-40M Mode 2427 MHz

Vertical

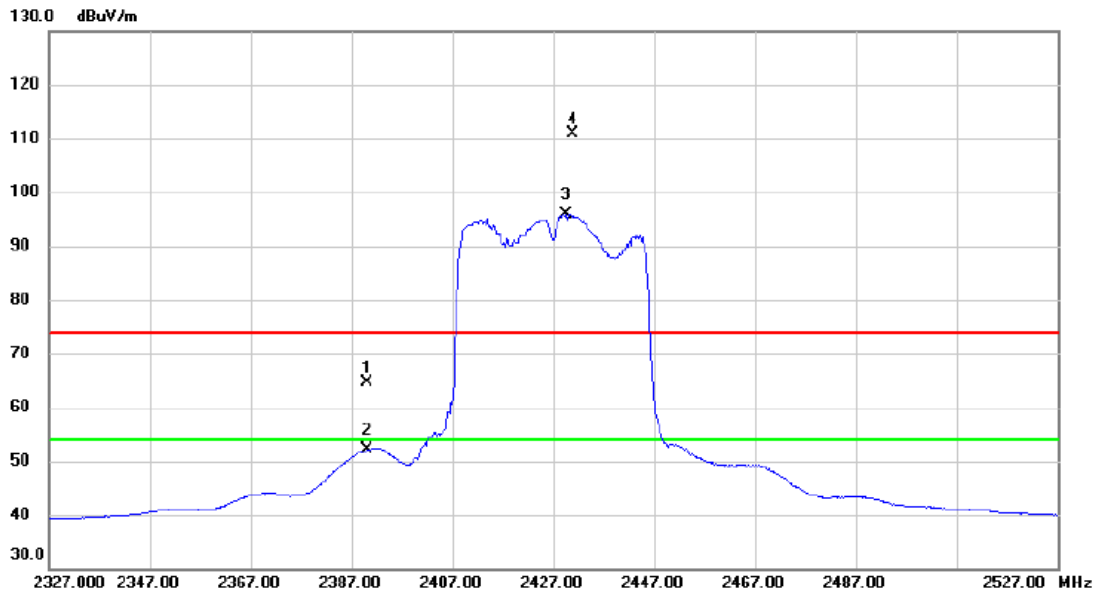

No.	Mk.	Freq. MHz	Reading Level dBuV	Correct Factor dB	Measure- ment dBuV/m	Limit dBuV/m	Margin dB	Detector	Comment
1		2390.000	57.03	7.57	64.60	74.00	-9.40	peak	
2		2390.000	44.53	7.57	52.10	54.00	-1.90	AVG	
3	*	2429.500	88.22	7.69	95.91	54.00	41.91	AVG	No Limit
4	X	2430.800	103.07	7.70	110.77	74.00	36.77	peak	No Limit

REMARKS:

(1) Measurement Value = Reading Level + Correct Factor.

(2) Margin Level = Measurement Value - Limit Value.

Orthogonal Axis	X
Test Mode:	TX N-40M Mode 2427 MHz

Vertical

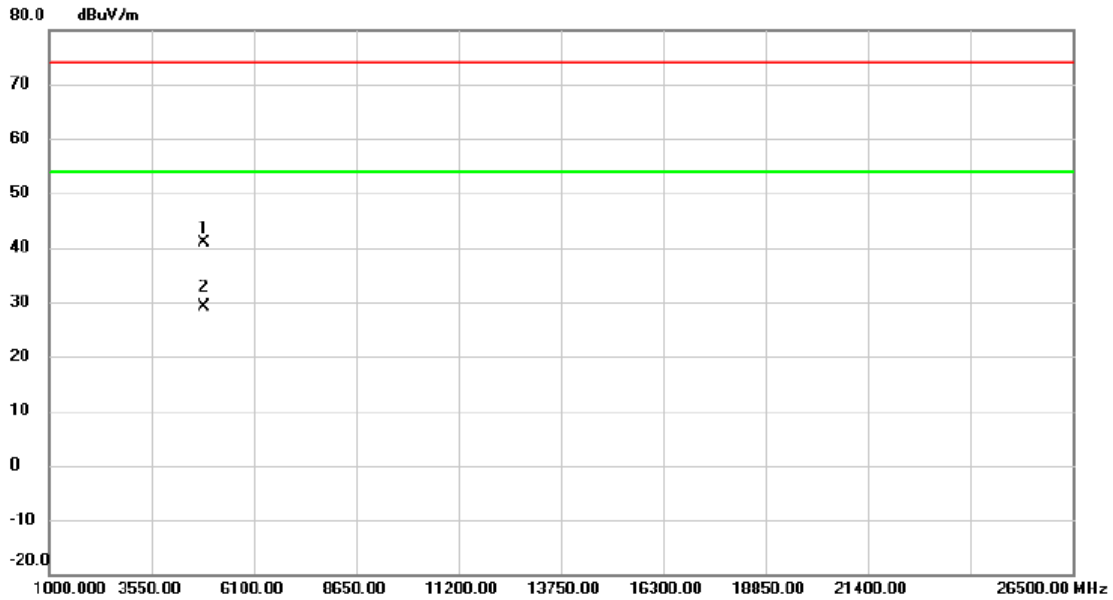

No.	Mk.	Freq. MHz	Reading Level dBuV	Correct Factor dB	Measure- ment dBuV/m	Limit dBuV/m	Margin dB	Detector	Comment
1		4855.000	36.59	4.37	40.96	74.00	-33.04	peak	
2	*	4858.650	24.87	4.38	29.25	54.00	-24.75	AVG	

REMARKS:

- (1) Measurement Value = Reading Level + Correct Factor.
- (2) Margin Level = Measurement Value - Limit Value.

Orthogonal Axis	X
Test Mode:	TX N-40M Mode 2427 MHz

Horizontal

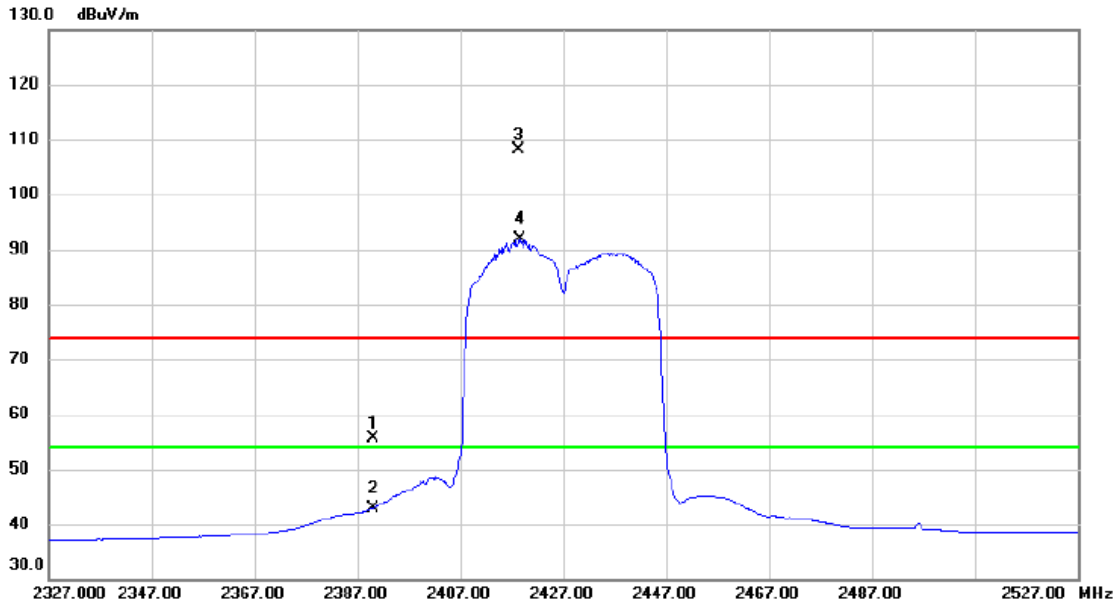

No.	Mk.	Freq. MHz	Reading Level dBuV	Correct Factor dB	Measure- ment dBuV/m	Limit dBuV/m	Margin dB	Detector	Comment
1		2390.000	48.02	7.57	55.59	74.00	-18.41	peak	
2		2390.000	35.43	7.57	43.00	54.00	-11.00	AVG	
3	X	2418.300	100.50	7.66	108.16	74.00	34.16	peak	No Limit
4	*	2418.500	84.18	7.66	91.84	54.00	37.84	AVG	No Limit

REMARKS:

(1) Measurement Value = Reading Level + Correct Factor.

(2) Margin Level = Measurement Value - Limit Value.

Orthogonal Axis	X
Test Mode:	TX N-40M Mode 2427 MHz

Horizontal

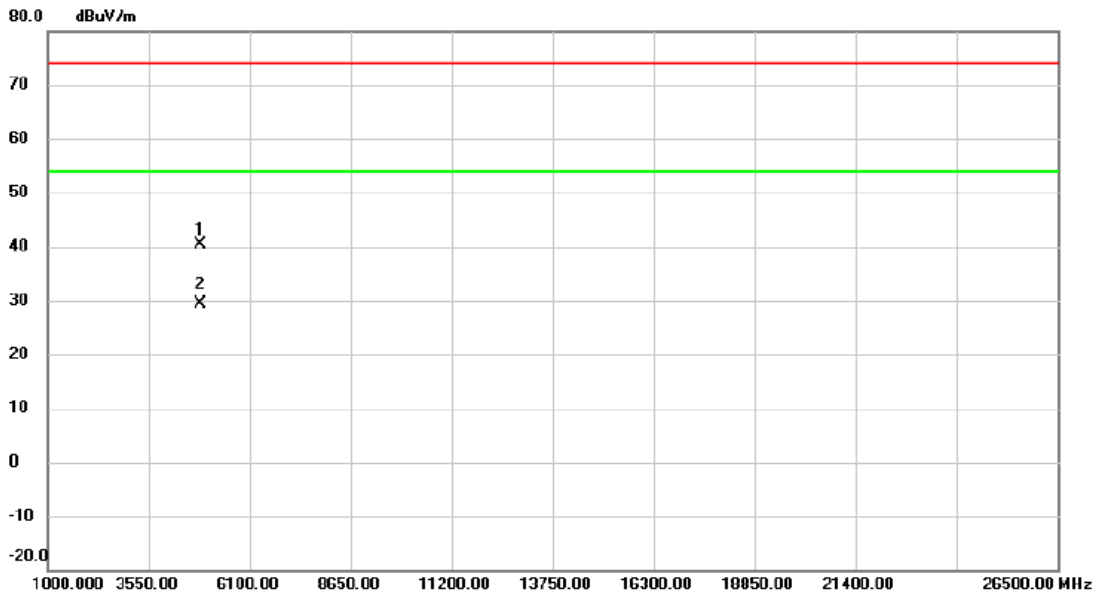

No.	Mk.	Freq. MHz	Reading Level dBuV	Correct Factor dB	Measure- ment dBuV/m	Limit dBuV/m	Margin dB	Detector	Comment
1		4866.514	35.88	4.41	40.29	74.00	-33.71	peak	
2	*	4868.800	24.98	4.42	29.40	54.00	-24.60	AVG	

REMARKS:

- (1) Measurement Value = Reading Level + Correct Factor.
- (2) Margin Level = Measurement Value - Limit Value.

Orthogonal Axis	X
Test Mode:	TX N-40M Mode 2437 MHz

Vertical

130 dBuV/m

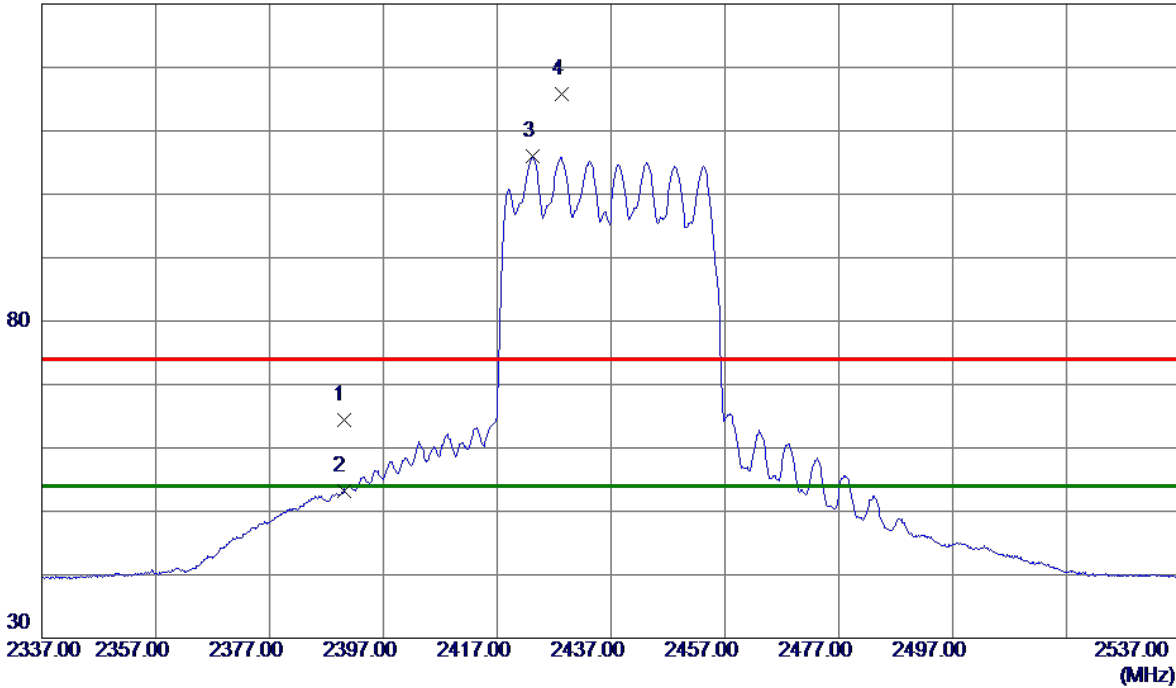

No.	Freq. MHz	Reading Level dBuV/m	Correct Factor dB	Measure ment dBuV/m	Limit dBuV/m	Margin dB	Detector	Comment
1	2390.0000	55.24	9.11	64.35	74.00	-9.65	Peak	
2	2390.0000	44.16	9.11	53.27	54.00	-0.73	AVG	
3 *	2423.2000	96.87	9.19	106.06	54.00	52.06	AVG	No Limit
4	2428.3000	106.56	9.21	115.77	74.00	41.77	Peak	No Limit

REMARKS:

- (1) Measurement Value = Reading Level + Correct Factor.
- (2) Margin Level = Measurement Value - Limit Value.

Orthogonal Axis	X
Test Mode:	TX N-40M Mode 2437 MHz

Vertical

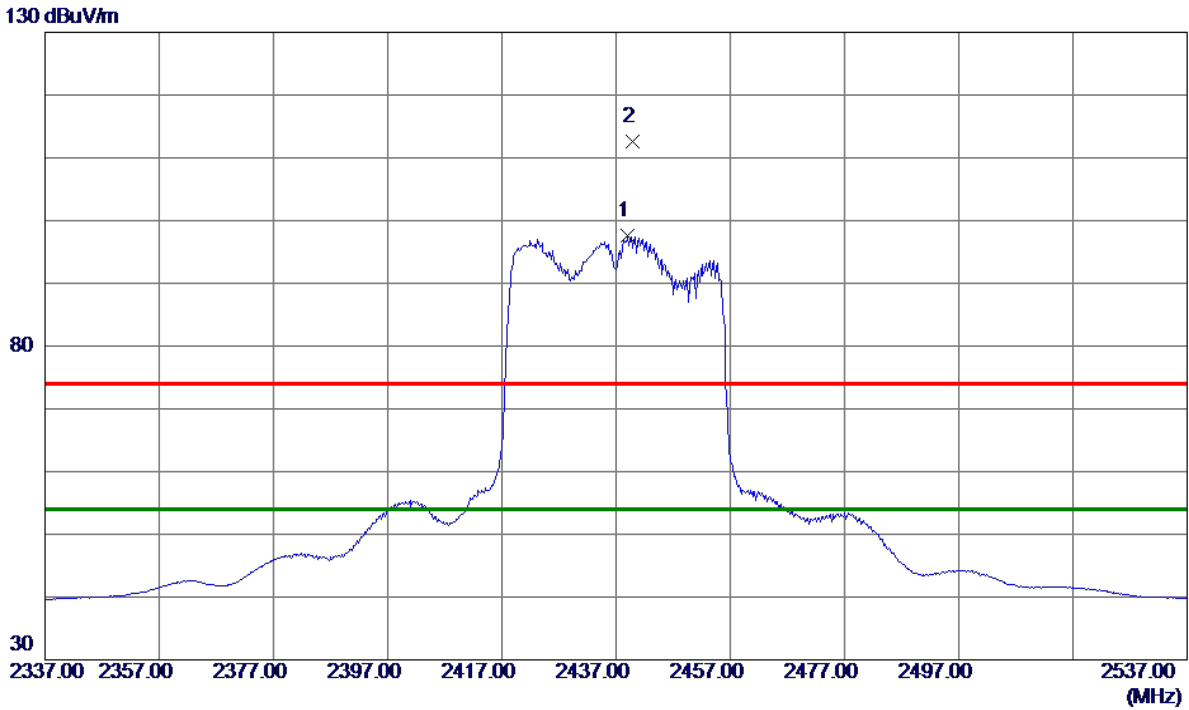

No.	Freq. MHz	Reading Level dBuV/m	Correct Factor dB	Measure ment dBuV/m	Limit dBuV/m	Margin dB	Detector	Comment
1 *	2439.0000	89.81	7.73	97.54	54.00	43.54	AVG	No Limit
2	2439.8000	104.79	7.73	112.52	74.00	38.52	Peak	No Limit

REMARKS:

- (1) Measurement Value = Reading Level + Correct Factor.
- (2) Margin Level = Measurement Value - Limit Value.

Orthogonal Axis	X
Test Mode:	TX N-40M Mode 2437 MHz

Vertical

80 dBuV/m

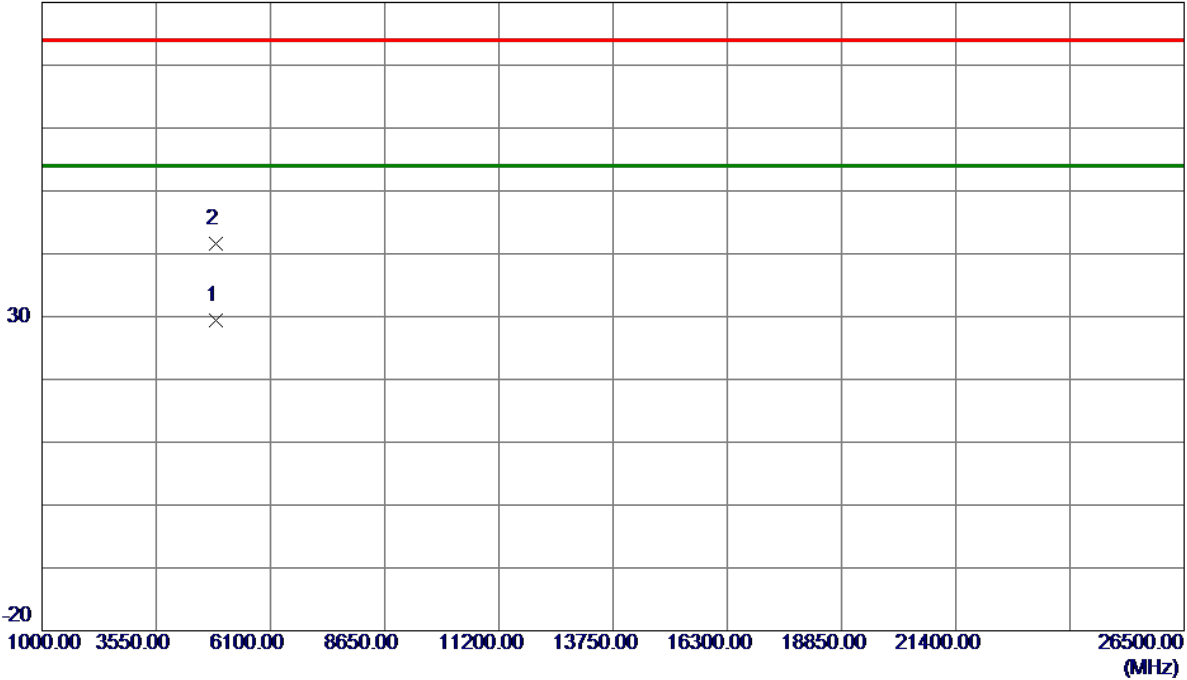

No.	Freq. MHz	Reading Level dBuV/m	Correct Factor dB	Measure ment dBuV/m	Limit dBuV/m	Margin dB	Detector	Comment
1 *	4874.3250	25.00	4.44	29.44	54.00	-24.56	AVG	
2	4875.0320	37.10	4.45	41.55	74.00	-32.45	Peak	

REMARKS:

- (1) Measurement Value = Reading Level + Correct Factor.
- (2) Margin Level = Measurement Value - Limit Value.

Orthogonal Axis	X
Test Mode:	TX N-40M Mode 2437 MHz

Horizontal

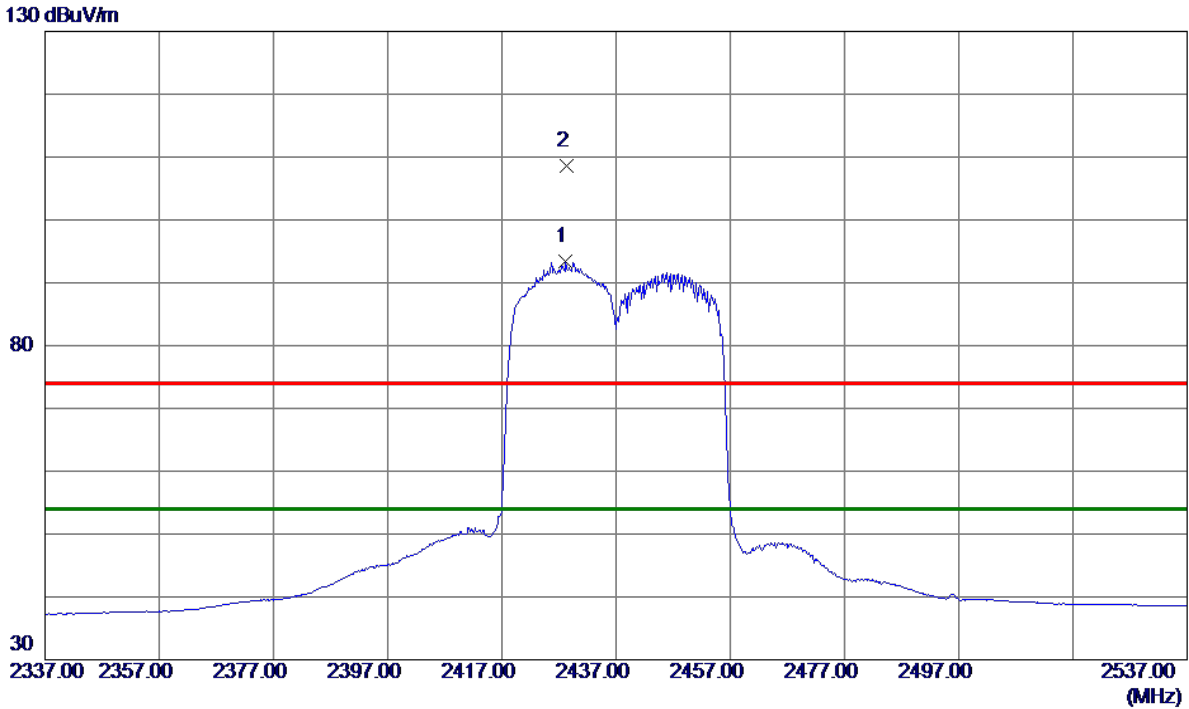

No.	Freq. MHz	Reading Level dBuV/m	Correct Factor dB	Measure ment dBuV/m	Limit dBuV/m	Margin dB	Detector	Comment
1 *	2428.2000	85.64	7.69	93.33	54.00	39.33	AVG	No Limit
2	2428.3000	100.85	7.69	108.54	74.00	34.54	Peak	No Limit

REMARKS:

- (1) Measurement Value = Reading Level + Correct Factor.
- (2) Margin Level = Measurement Value - Limit Value.

Orthogonal Axis	X
Test Mode:	TX N-40M Mode 2437 MHz

Horizontal

80 dBuV/m

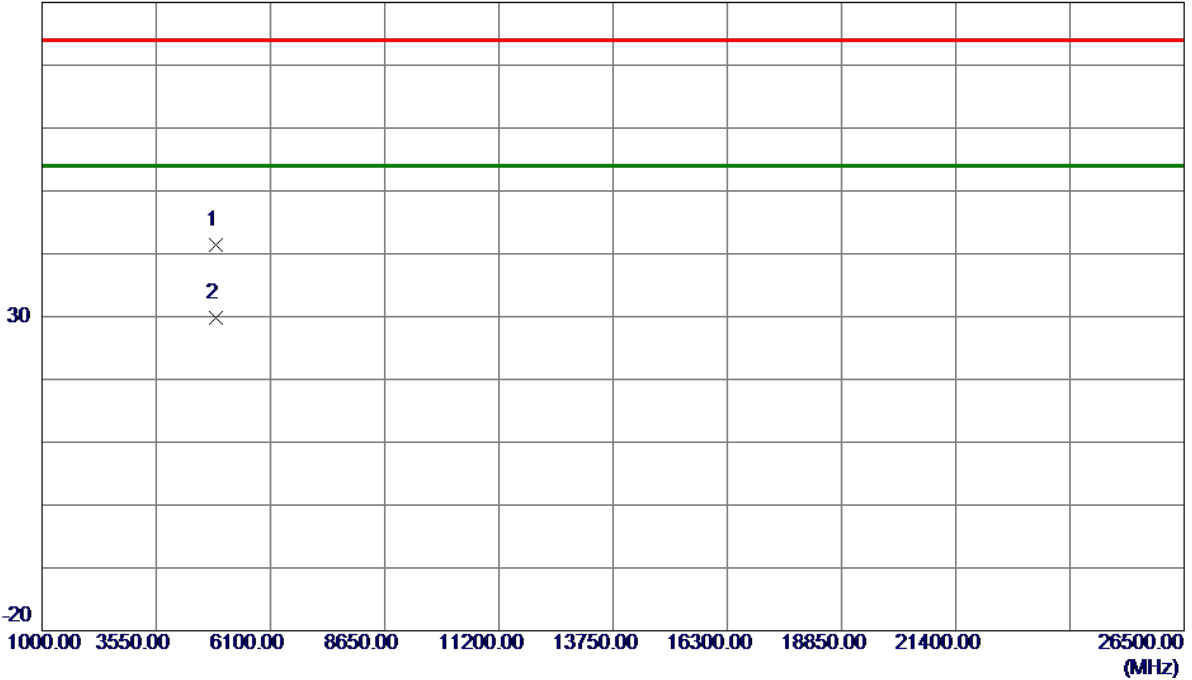

No.	Freq. MHz	Reading Level dBuV/m	Correct Factor dB	Measure ment dBuV/m	Limit dBuV/m	Margin dB	Detector	Comment
1	4872.7410	37.02	4.44	41.46	74.00	-32.54	Peak	
2 *	4873.6500	25.42	4.44	29.86	54.00	-24.14	AVG	

REMARKS:

- (1) Measurement Value = Reading Level + Correct Factor.
- (2) Margin Level = Measurement Value - Limit Value.

Orthogonal Axis	X
Test Mode:	TX N-40M Mode 2447 MHz

Vertical

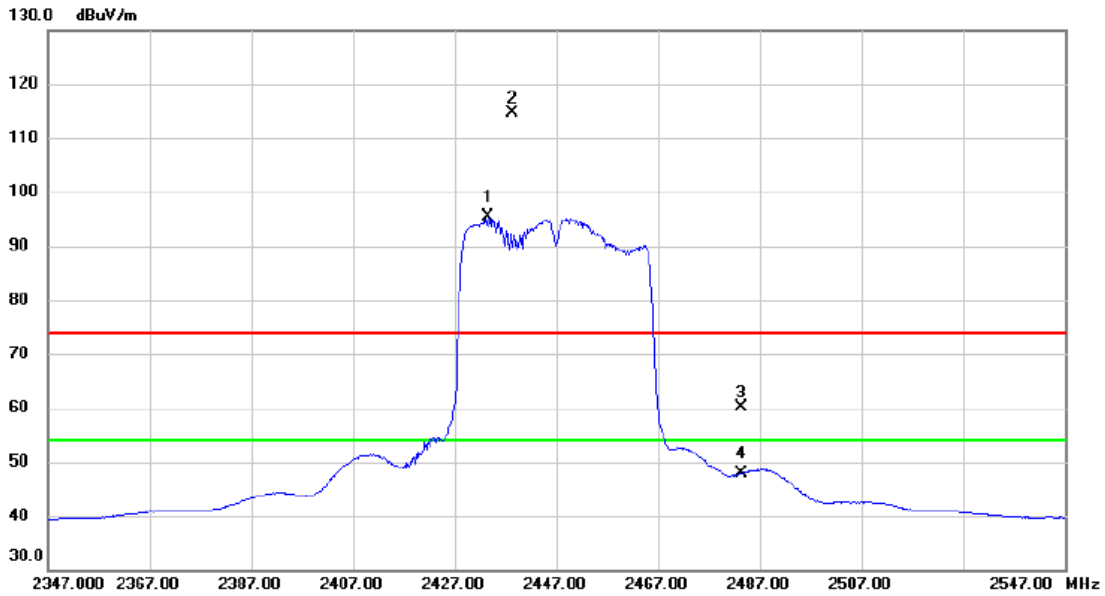

No.	Mk.	Freq. MHz	Reading Level dBuV	Correct Factor dB	Measure- ment dBuV/m	Limit dBuV/m	Margin dB	Detector	Comment
1	*	2433.400	87.58	7.70	95.28	54.00	41.28	AVG	No Limit
2	X	2438.400	106.82	7.73	114.55	74.00	40.55	peak	No Limit
3		2483.500	52.15	7.87	60.02	74.00	-13.98	peak	
4		2483.500	40.08	7.87	47.95	54.00	-6.05	AVG	

REMARKS:

(1) Measurement Value = Reading Level + Correct Factor.

(2) Margin Level = Measurement Value - Limit Value.

Orthogonal Axis	X
Test Mode:	TX N-40M Mode 2447 MHz

Vertical

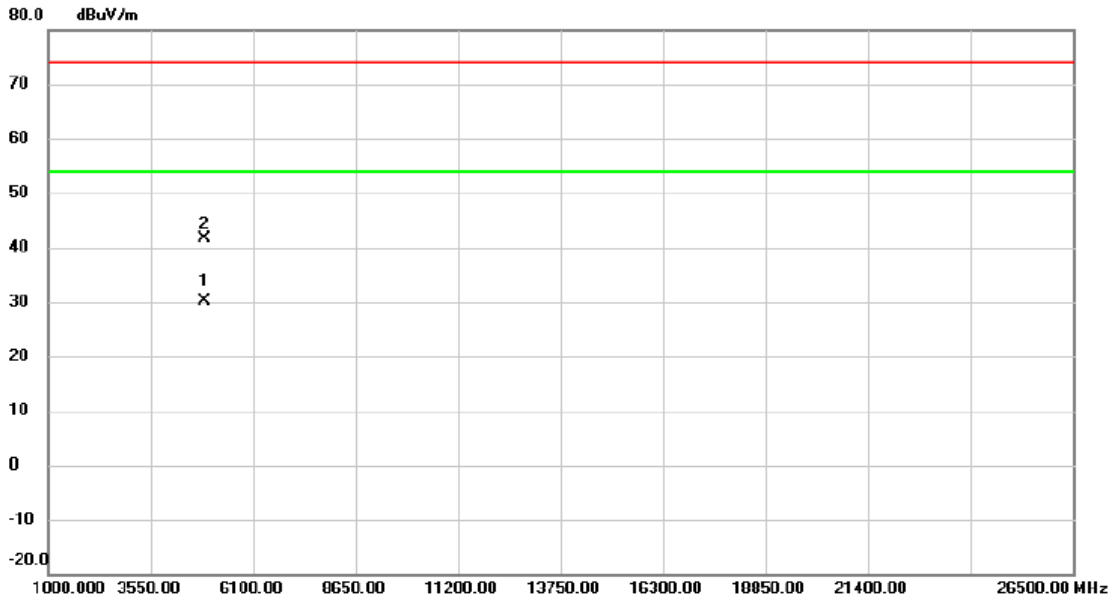

No.	Mk.	Freq. MHz	Reading Level dBuV	Correct Factor dB	Measure- ment dBuV/m	Limit dBuV/m	Margin dB	Detector	Comment
1	*	4889.691	25.68	4.49	30.17	54.00	-23.83	AVG	
2		4892.365	37.05	4.51	41.56	74.00	-32.44	peak	

REMARKS:

- (1) Measurement Value = Reading Level + Correct Factor.
- (2) Margin Level = Measurement Value - Limit Value.

Orthogonal Axis	X
Test Mode:	TX N-40M Mode 2447 MHz

Horizontal

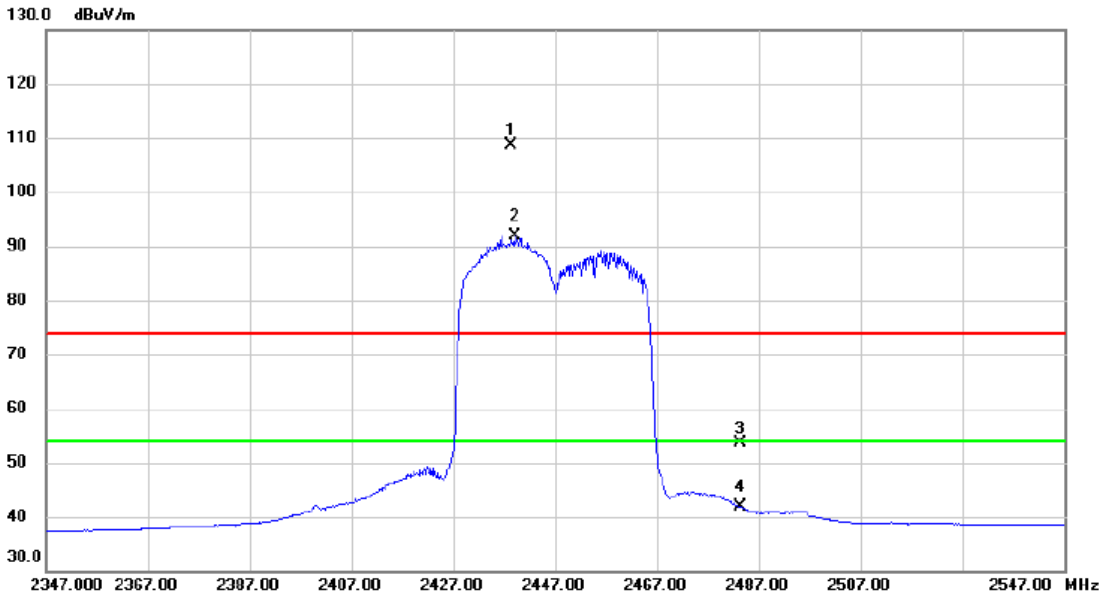

No.	Mk.	Freq. MHz	Reading Level dBuV	Correct Factor dB	Measure- ment dBuV/m	Limit dBuV/m	Margin dB	Detector	Comment
1	X	2438.300	100.89	7.73	108.62	74.00	34.62	peak	No Limit
2	*	2439.000	84.25	7.74	91.99	54.00	37.99	AVG	No Limit
3		2483.500	45.74	7.87	53.61	74.00	-20.39	peak	
4		2483.500	33.97	7.87	41.84	54.00	-12.16	AVG	

REMARKS:

(1) Measurement Value = Reading Level + Correct Factor.

(2) Margin Level = Measurement Value - Limit Value.

Orthogonal Axis	X
Test Mode:	TX N-40M Mode 2447 MHz

Horizontal

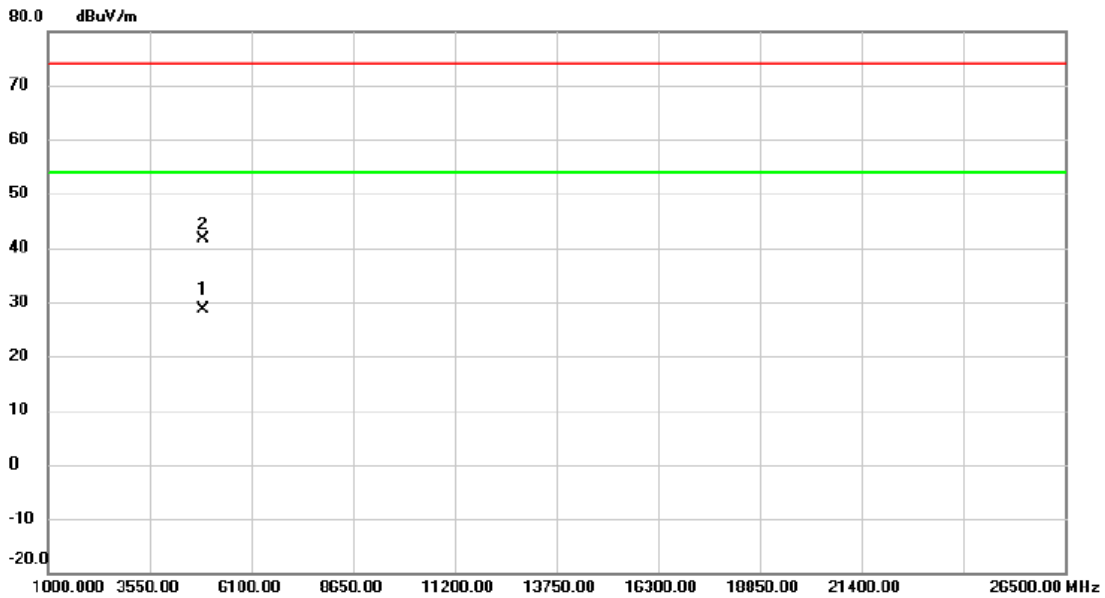

No.	Mk.	Freq. MHz	Reading Level dBuV	Correct Factor dB	Measure- ment dBuV/m	Limit dBuV/m	Margin dB	Detector	Comment
1	*	4890.687	24.06	4.50	28.56	54.00	-25.44	AVG	
2		4895.369	37.11	4.52	41.63	74.00	-32.37	peak	

REMARKS:

- (1) Measurement Value = Reading Level + Correct Factor.
- (2) Margin Level = Measurement Value - Limit Value.

Orthogonal Axis	X
Test Mode:	TX N-40M Mode 2452 MHz

Vertical

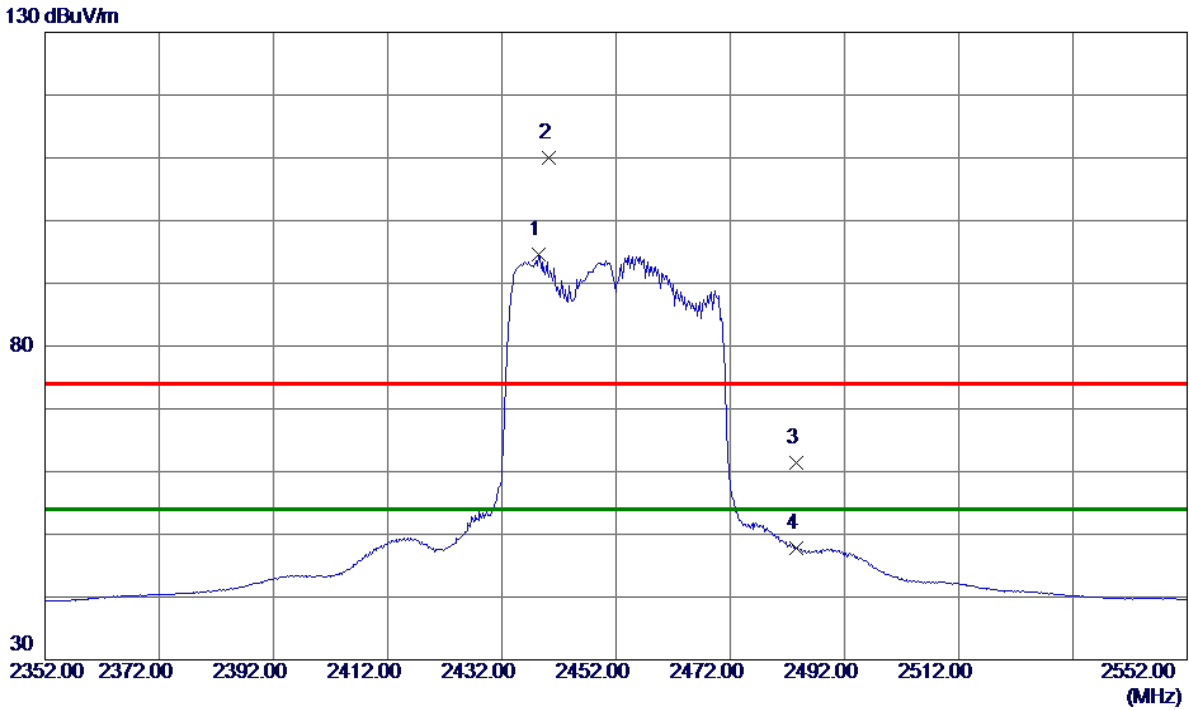

No.	Freq. MHz	Reading Level dBuV/m	Correct Factor dB	Measure ment dBuV/m	Limit dBuV/m	Margin dB	Detector	Comment
1 *	2438.5000	86.81	7.73	94.54	54.00	40.54	AVG	No Limit
2	2440.3000	102.34	7.73	110.07	74.00	36.07	Peak	No Limit
3	2483.5000	53.58	7.88	61.46	74.00	-12.54	Peak	
4	2483.5000	39.92	7.88	47.80	54.00	-6.20	AVG	

REMARKS:

- (1) Measurement Value = Reading Level + Correct Factor.
- (2) Margin Level = Measurement Value - Limit Value.

Orthogonal Axis	X
Test Mode:	TX N-40M Mode 2452 MHz

Vertical

80 dBuV/m

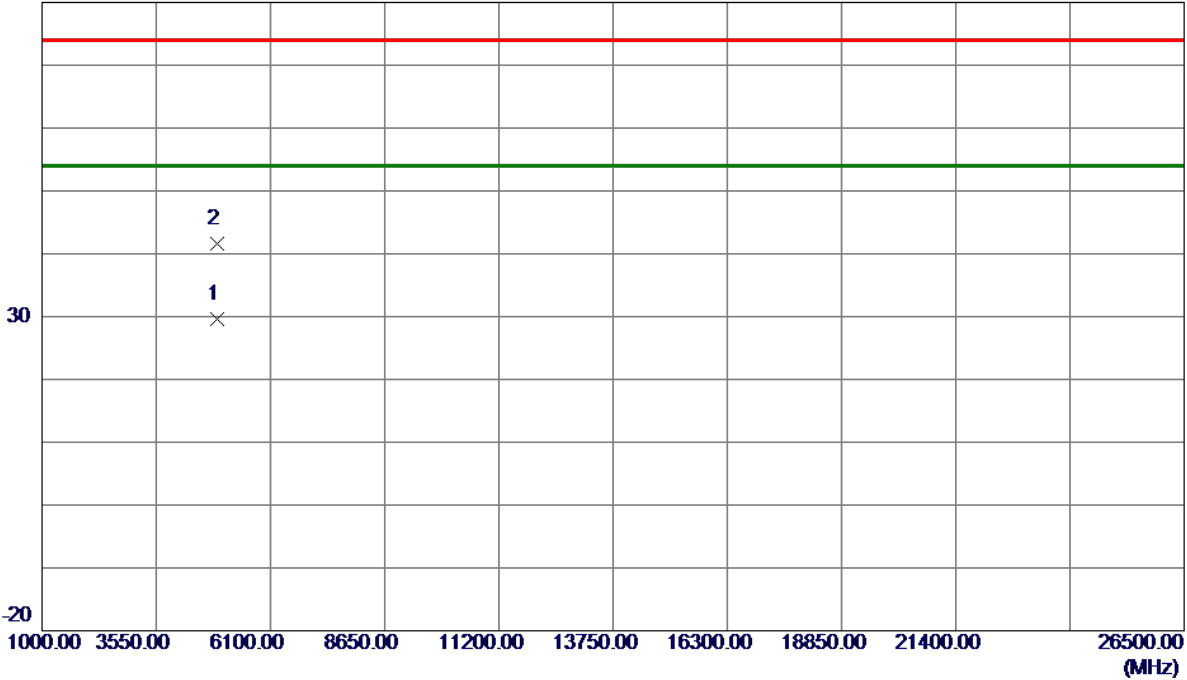

No.	Freq. MHz	Reading Level dBuV/m	Correct Factor dB	Measure ment dBuV/m	Limit dBuV/m	Margin dB	Detector	Comment
1 *	4903.6520	25.03	4.55	29.58	54.00	-24.42	AVG	
2	4903.9900	36.99	4.55	41.54	74.00	-32.46	Peak	

REMARKS:

- (1) Measurement Value = Reading Level + Correct Factor.
- (2) Margin Level = Measurement Value - Limit Value.

Orthogonal Axis	X
Test Mode:	TX N-40M Mode 2452 MHz

Horizontal

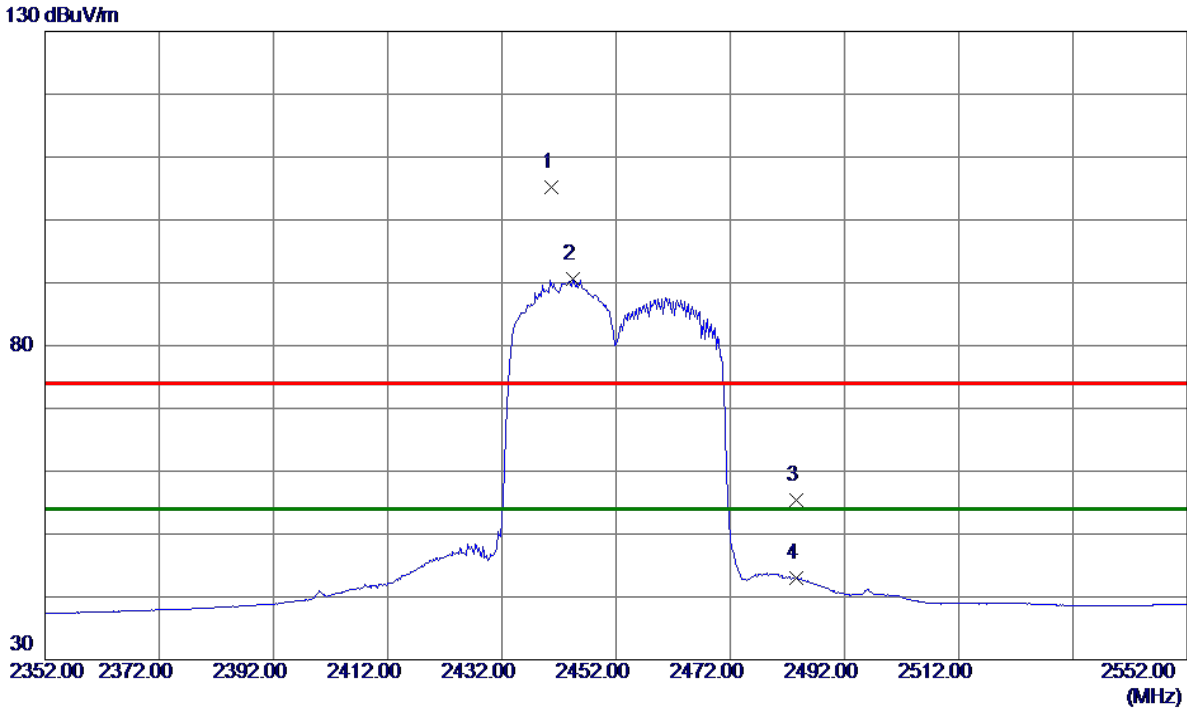

No.	Freq. MHz	Reading Level dBuV/m	Correct Factor dB	Measure ment dBuV/m	Limit dBuV/m	Margin dB	Detector	Comment
1	2440.7000	97.55	7.73	105.28	74.00	31.28	Peak	No Limit
2 *	2444.4000	82.88	7.75	90.63	54.00	36.63	AVG	No Limit
3	2483.5000	47.60	7.88	55.48	74.00	-18.52	Peak	
4	2483.5000	35.06	7.88	42.94	54.00	-11.06	AVG	

REMARKS:

- (1) Measurement Value = Reading Level + Correct Factor.
- (2) Margin Level = Measurement Value - Limit Value.

Orthogonal Axis	X
Test Mode:	TX N-40M Mode 2452 MHz

Horizontal

80 dBuV/m

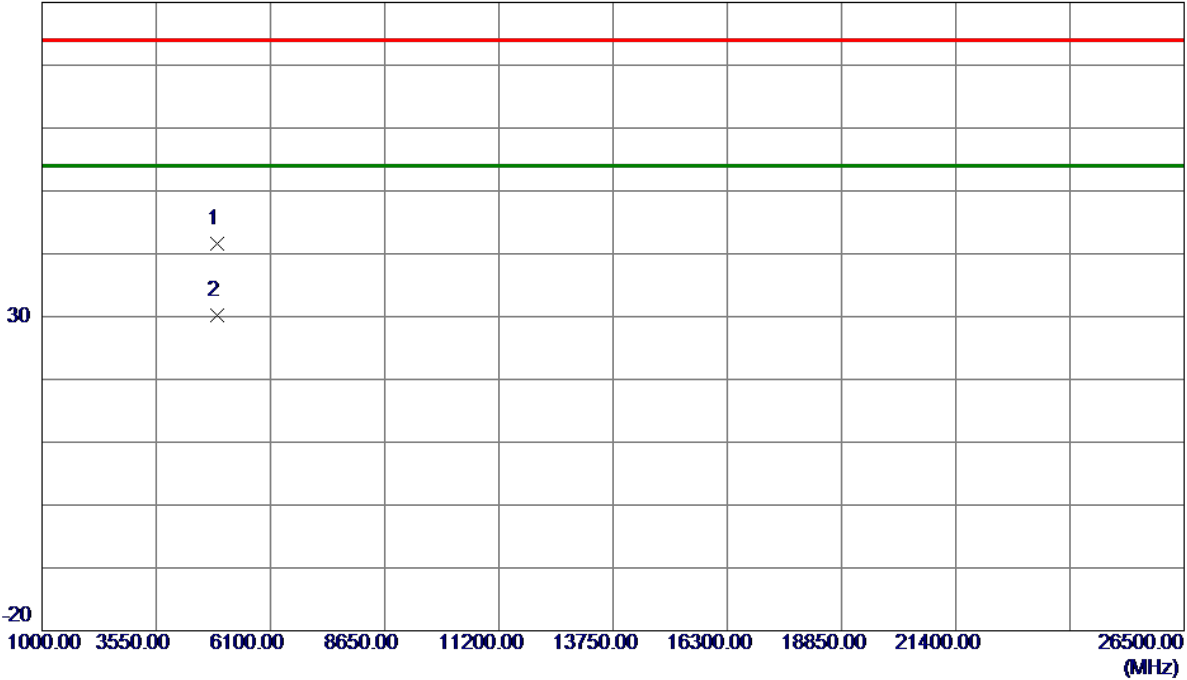

No.	Freq. MHz	Reading Level dBuV/m	Correct Factor dB	Measure ment dBuV/m	Limit dBuV/m	Margin dB	Detector	Comment
1	4905.6850	37.12	4.56	41.68	74.00	-32.32	Peak	
2 *	4906.0210	25.65	4.56	30.21	54.00	-23.79	AVG	

REMARKS:

- (1) Measurement Value = Reading Level + Correct Factor.
- (2) Margin Level = Measurement Value - Limit Value.

APPENDIX E - BANDWIDTH