



FCC 47 CFR PART 15 SUBPART C

RF Test Report

Applicant : TP-Link Technologies Co., Ltd.
Product Type : AC750 Wireless Dual Band Gigabit Router
Trade Name : TP-Link
Model Number : Archer C2
Applicable Standard : FCC 47 CFR PART 15 SUBPART C
ANSI C63.10:2013
Receive Date : Mar. 02, 2017
Test Period : Mar. 17 ~ May 16, 2017
Issue Date : May 17, 2017

Issue by

A Test Lab Techno Corp.
No. 140-1, Changan Street, Bade District,
Taoyuan City 33465, Taiwan (R.O.C)
Tel : +886-3-2710188 / Fax : +886-3-2710190



Taiwan Accreditation Foundation accreditation number: 1330

Note: This report shall not be reproduced except in full, without the written approval of A Test Lab Techno Corp. This document may be altered or revised by A Test Lab Techno Corp. personnel only, and shall be noted in the revision section of the document. The client should not use it to claim product endorsement by TAF, or any government agencies. The test results in the report only apply to the tested sample.



Revision History

Rev.	Issue Date	Revisions	Revised By
00	May 05, 2017	Initial Issue	Janet Chao
01	May 17, 2017	Revised report information.	Janet Chao



Verification of Compliance

Issued Date: May 17, 2017

Applicant : TP-Link Technologies Co., Ltd.
Product Type : AC750 Wireless Dual Band Gigabit Router
Trade Name : TP-Link
Model Number : Archer C2
FCC ID : TE7C2V5
EUT Rated Voltage : DC 12V, 1A
Test Voltage : 120 Vac / 60 Hz
Applicable Standard : FCC 47 CFR PART 15 SUBPART C
ANSI C63.10:2013
Test Result : Complied
Performing Lab. : A Test Lab Techno Corp.

No. 140-1, Changan Street, Bade District,
Taoyuan City 33465, Taiwan (R.O.C)
Tel : +886-3-2710188 / Fax : +886-3-2710190



Taiwan Accreditation Foundation accreditation number: 1330

<http://www.atl-lab.com.tw/e-index.htm>

A Test Lab Techno Corp. tested the above equipment in accordance with the requirements set forth in the above standards. All indications of Pass/Fail in this report are opinions expressed by A Test Lab Techno Corp. based on interpretations and/or observations of test results. Measurement Uncertainties were not taken into account and are published for informational purposes only. The test results show that the equipment tested is capable of demonstrating compliance with the requirements as documented in this report.

Approved By : Fly Lu Reviewed By : Eric Ou Yang
(Manager) (Fly Lu) (Testing Engineer) (Eric Ou Yang)



TABLE OF CONTENTS

1	General Information	6
2	EUT Description.....	7
3	Test Methodology.....	8
	3.1. Mode of Operation.....	8
	3.2. EUT Exercise Software	12
	3.3. Configuration of Test System Details.....	13
	3.4. Test Site Environment.....	14
4	AC Power Line Conducted Emission Measurement.....	15
	4.1. Limit.....	15
	4.2. Test Instruments	15
	4.3. Test Setup	15
	4.4. Test Procedure	16
	4.5. Test Result.....	17
5	Radiated Emission Measurement	19
	5.1. Limit.....	19
	5.2. Test Instruments	19
	5.3. Setup.....	20
	5.4. Test Procedure	22
	5.5. Test Result.....	24
6	Maximum Conducted Output Power Measurement.....	93
	6.1. Limit.....	93
	6.2. Test Setup	93
	6.3. Test Instruments	93
	6.4. Test Procedure	93
	6.5. Test Result.....	94
7	6dB RF Bandwidth Measurement.....	100
	7.1. Limit.....	100
	7.2. Test Setup	100
	7.3. Test Instruments	100
	7.4. Test Procedure	100
	7.5. Test Result.....	101
	7.6. Test Graphs	102



8	Maximum Power Density Measurement	110
8.1.	Limit	110
8.2.	Test Setup	110
8.3.	Test Instruments	110
8.4.	Test Procedure	110
8.5.	Test Result	111
8.6.	Test Graphs	112
9	Out of Band Conducted Emissions Measurement	120
9.1.	Limit	120
9.2.	Test Setup	120
9.3.	Test Instruments	120
9.4.	Test Procedure	120
9.5.	Test Graphs	121
10	Antenna Measurement	145
10.1.	Limit	145
10.2.	Antenna Description	145
10.3.	Directional Gain Calculated	145



1 General Information

1.1 Summary of Test Result

Standard	Item	Result	Remark
15.247			
15.207	AC Power Conducted Emission	PASS	----
Standard	Item	Result	Remark
15.247			
15.247(d)	Transmitter Radiated Emissions	PASS	----
15.247(b)(3)	Max. Output Power	PASS	----
15.247(a)(2)	6dB RF Bandwidth	PASS	----
15.247(e)	Power Spectral Density	PASS	----
15.247(d)	Out of Band Conducted Spurious Emission	PASS	----
15.203	Antenna Requirement	PASS	----

The test results of this report relate only to the tested sample(s) identified in this report. Manufacturer or whom it may concern should recognize the pass or fail of the test result.

1.2 Measurement Uncertainty

Test Item	Frequency Range	Uncertainty (dB)
Conducted Emission	9kHz ~ 150KHz	2.7
	150kHz ~ 30MHz	2.7
Radiated Emission	9kHz ~ 30MHz	1.7
	30MHz ~ 1000MHz	5.7
	1000MHz ~ 18000MHz	5.5
	18000MHz ~ 26500MHz	4.8
	26500MHz ~ 40000MHz	4.8
Conducted Output Power	+0.27 dB / -0.28 dB	
RF Bandwidth	4.96%	
Power Spectral Density	+0.71 dB / -0.77 dB	



2 EUT Description

Applicant	TP-Link Technologies Co., Ltd. Building 24 (floors 1,3,4,5) and 28 (floors1-4), Central Science and Technology Park, Nanshan, Shenzhen, China 518057			
Manufacturer (1)	TP-Link Technologies Co., Ltd. Building 24 (floors 1,3,4,5) and 28 (floors1-4), Central Science and Technology Park, Nanshan, Shenzhen, China 518057			
Product Type	AC750 Wireless Dual Band Gigabit Router			
Trade Name	TP-Link			
Model Number	Archer C2			
FCC ID	TE7C2V5			
Operate Freq. Band	Frequency Range (MHz)	Modulation	Channel Bandwidth	Data Rate 800 GI (ns)
IEEE 802.11b	2412 ~ 2462	DSSS	20MHz	Up to 11Mbps
IEEE 802.11g	2412 ~ 2462	OFDM (64QAM)	20MHz	Up to 54Mbps
IEEE 802.11n 2.4GHz 20MHz	2412 ~ 2462	OFDM (64QAM)	20MHz	Up to 144.4Mbps
IEEE 802.11n 2.4GHz 40MHz	2422 ~ 2452	OFDM (64QAM)	40MHz	Up to 300Mbps
Antenna information	Type		Max. Gain (dBi)	
	Omni-directional Antenna		3dBi	
Antenna Delivery	See section 3.1			

Frequency Band	Max. RF Output Power (W)
IEEE 802.11b	0.324
IEEE 802.11g	0.352
IEEE 802.11n 2.4GHz 20MHz	0.248
IEEE 802.11n 2.4GHz 40MHz	0.062

3 Test Methodology

3.1. Mode of Operation

Decision of Test ATL has verified the construction and function in typical operation. All the test modes were carried out with the EUT in normal operation, which was shown in this test report and defined as:

Test Mode
Mode 1: Continuous TX mode
Mode 2: IEEE 802.11b TX mode
Mode 3: IEEE 802.11g TX mode
Mode 4: IEEE 802.11n 2.4GHz 20MHz TX mode
Mode 5: IEEE 802.11n 2.4GHz 40MHz TX mode

Software used to control the EUT for staying in continuous transmitting mode was programmed.

After verification, all tests were carried out with the worst case test modes as shown below except radiated spurious emission below 1GHz and power line conducted emissions below 30MHz, which worst case was in TX mode only.

By preliminary testing and verifying three axis (X, Y and Z) position of EUT transmitted status, it was found that "X axis" position was the worst, then the final test was executed the worst condition and test data were recorded in this report.

Test Mode	ANT-0	ANT-1	ANT-0+1
Mode 2: IEEE 802.11b TX mode	V	V	V
Mode 3: IEEE 802.11g TX mode	V	V	V
Mode 4: IEEE 802.11n 2.4GHz 20MHz TX mode	V	V	V
Mode 5: IEEE 802.11n 2.4GHz 40MHz TX mode	V	V	V

Test Mode	Antenna Delivery	Test Channel	Data Rate (Mbps)
Mode 2: IEEE 802.11b TX mode	2TX / 2RX (CDD)	1, 6, 11	1
Mode 3: IEEE 802.11g TX mode	2TX / 2RX (CDD)	1, 6, 11	6
Mode 4: IEEE 802.11n 2.4GHz 20MHz TX mode	2TX / 2RX (CDD)	1, 6, 11	13
Mode 5: IEEE 802.11n 2.4GHz 40MHz TX mode	2TX / 2RX (CDD)	3, 6, 9	27

Duty cycle

Test Mode	Frequency (MHz)	on time (ms)	on+off time (ms)	Duty cycle	Duty Factor (dB)	1/T Minimum VBW (kHz)
Mode 2: IEEE 802.11b TX mode	2412.0	8.520	8.640	0.986	0.061	0.010
Mode 3: IEEE 802.11g TX mode	2412.0	1.410	1.595	0.884	0.535	0.709
Mode 4: IEEE 802.11n 2.4GHz 20MHz TX mode	2412.0	1.315	1.505	0.874	0.586	0.760
Mode 5: IEEE 802.11n 2.4GHz 40MHz TX mode	2422.0	0.650	0.830	0.783	1.062	1.538



Duty Cycle Graphs

Mode 2: IEEE 802.11b TX mode

On time

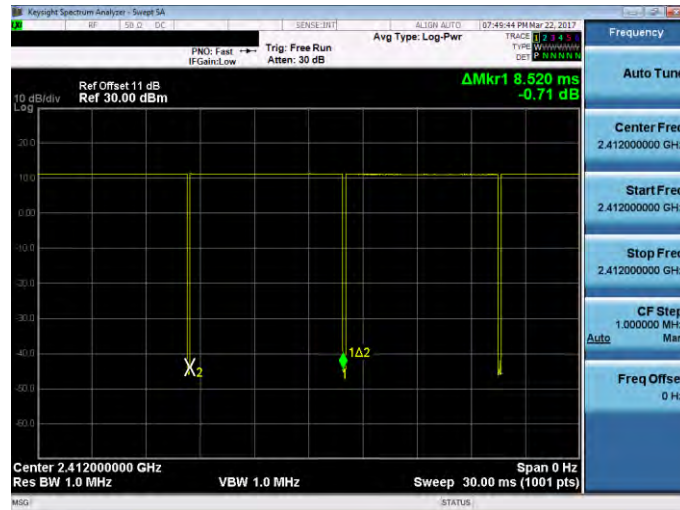

On+off time

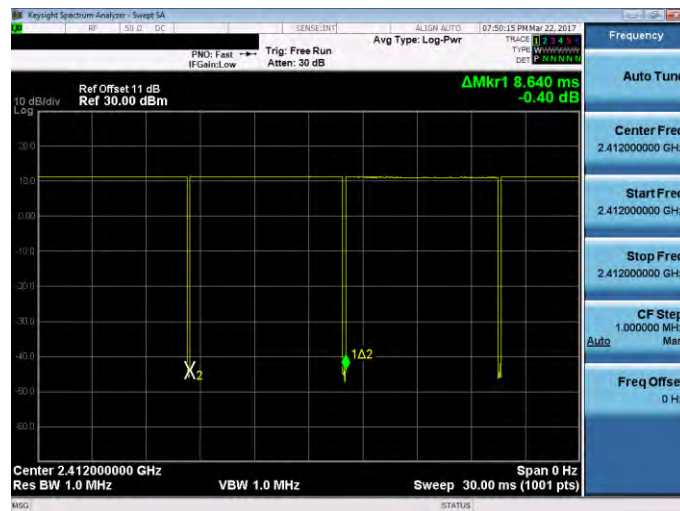

Mode 4: IEEE 802.11n 2.4GHz 20MHz Mode

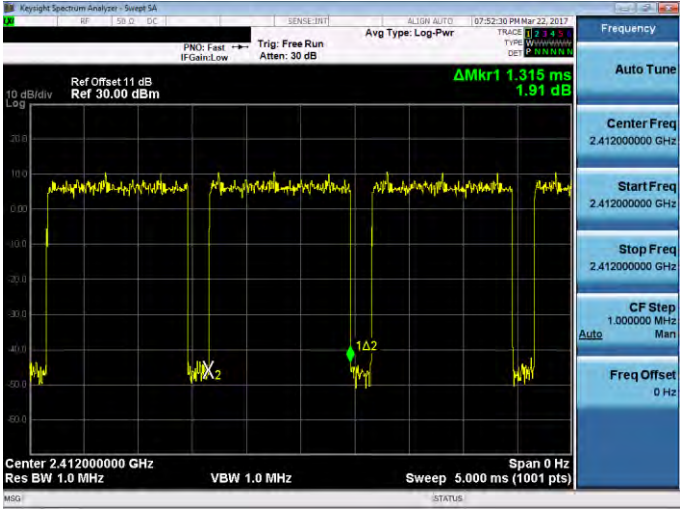
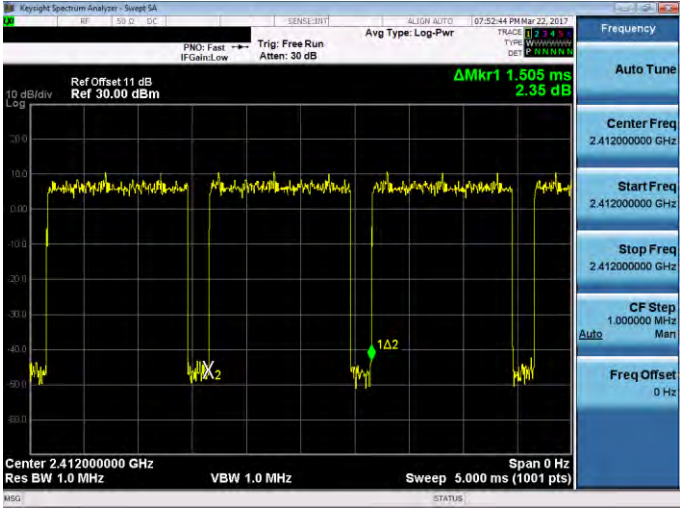
<p>On time</p>	
<p>On+off time</p>	

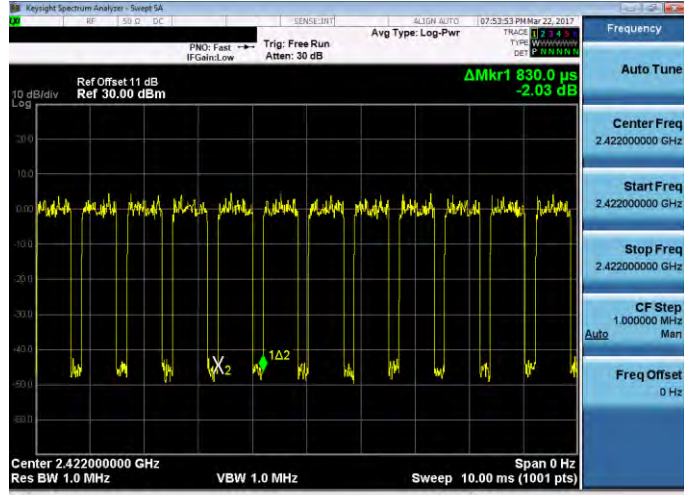
Mode 5: IEEE 802.11n 2.4GHz 40MHz Mode	
On time	
On+off time	

3.2. EUT Exercise Software

1.	Setup the EUT shown on 3.3.
2.	Turn on the power of all equipment.
3.	Turn Wi-Fi function link to Notebook
4.	EUT run test program.

Measurement Software	
1	EZ-EMC Ver. ATL-03A1-1
2	EZ-EMC Ver ATL-ITC-3A1-1

3.3. Configuration of Test System Details

Conducted Emissions

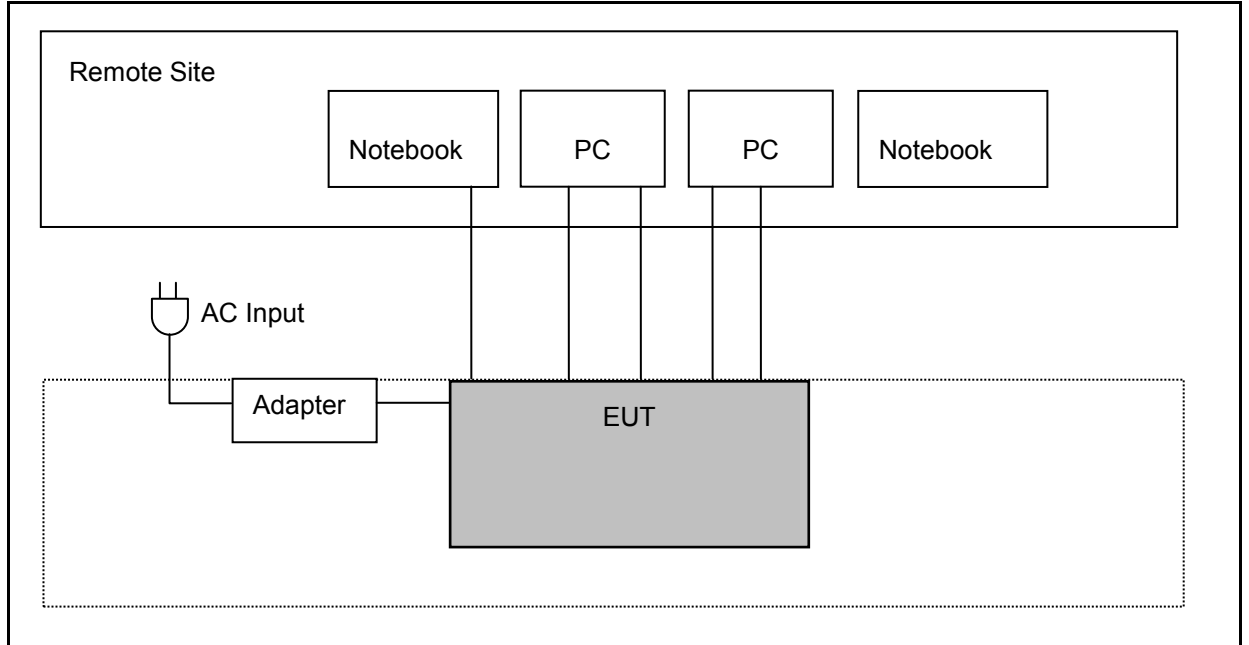

Radiated Emissions

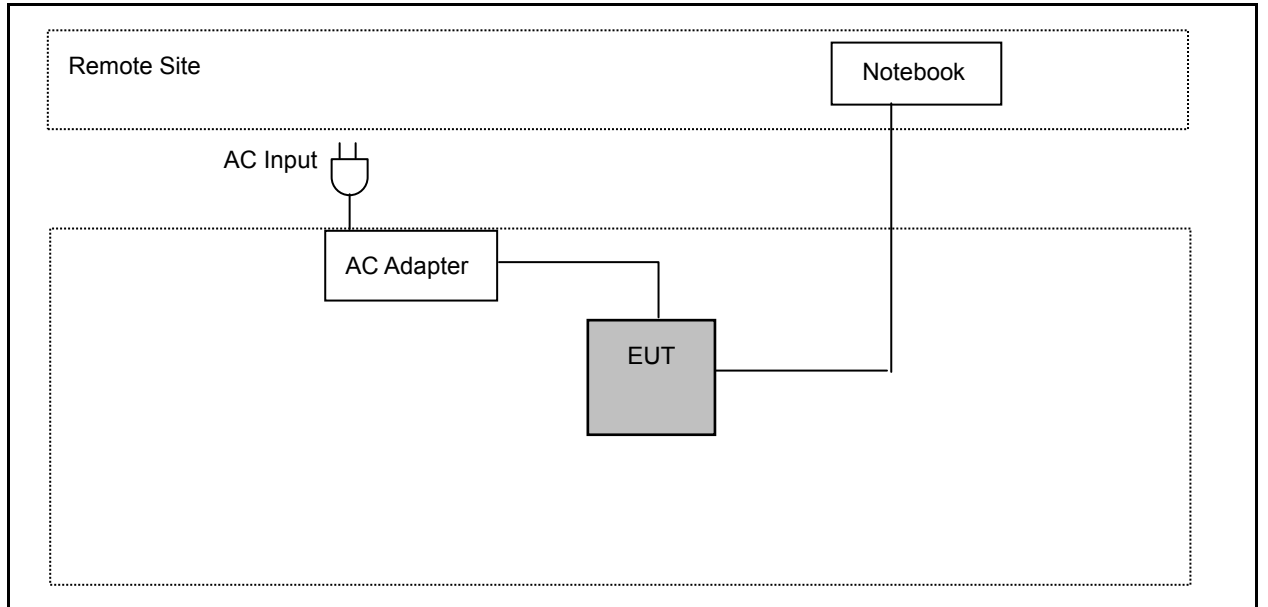



3.4. Test Site Environment

Items	Required (IEC 60068-1)	Actual
Temperature (°C)	15-35	26
Humidity (%RH)	25-75	60
Barometric pressure (mbar)	860-1060	950

4 AC Power Line Conducted Emission Measurement

4.1. Limit

Frequency (MHz)	Quasi-peak	Average
0.15 - 0.5	66 to 56	56 to 46
0.50 - 5.0	56	46
5.0 - 30.0	60	50

4.2. Test Instruments

Describe	Manufacturer	Model Number	Serial Number	Cal. Date	Cal. Period
Test Receiver	R&S	ESCI	100367	05/13/2016	1 year
LISN	R&S	ENV216	101040	04/01/2017	1 year
LISN	R&S	ENV216	101041	03/15/2017	1 year
RF Cable	Woken	00100D1380194M	TE-02-02	05/31/2016	1 year
Test Site	ATL	TE02	TE02	N.C.R.	-----

Note: N.C.R. = No Calibration Request.

4.3. Test Setup

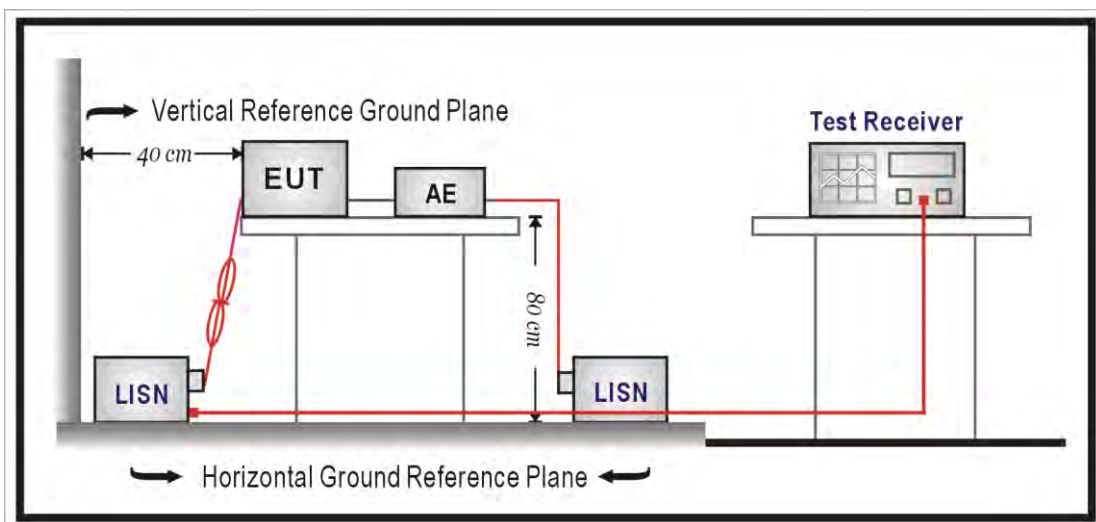

4.4. Test Procedure

The EUT and simulators are connected to the main power through a line impedance stabilization network (L.I.S.N.). This provides a $50\Omega // 50\mu\text{H}$ coupling impedance for the measuring equipment. The peripheral devices are also connected to the main power through a LISN that provides a $50\Omega // 50\mu\text{H}$ coupling impedance with 50ohm termination.

Tabletop device shall be placed on a non-conducting platform, of nominal size 1 m by 1.5 m, raised 80 cm above the reference ground plane. The wall of screened room shall be located 40cm to the rear of the EUT. Other surfaces of tabletop or floor standing EUT shall be at least 80cm from any other ground conducting surface including one or more LISNs. For floor-standing device shall be placed under the EUT with a 12mm insulating material.

Conducted emissions were investigated over the frequency range from 0.15 MHz to 30 MHz using a resolution bandwidth of 9 kHz. The equipment under test (EUT) shall be meet the limits in section 4.1, as applicable, including the average limit and the quasi-peak limit when using respectively, an average detector and quasi-peak detector measured in accordance with the methods described of related standard. When all of peak value were complied with quasi-peak and average limit from 150kHz to 30MHz then quasi-peak and average measurement was unnecessary.

The AMN shall be placed 0,8 m from the boundary of the unit under test and bonded to a ground reference plane for AMNs mounted on top of the ground reference plane. This distance is between the closest points of the AMN and the EUT. All other units of the EUT and associated equipment shall be at least 0,8 m from the AMN. If the mains power cable is longer than 1m then the cable shall be folded back and forth at the centre of the lead to form a bundle no longer than 0.4m. All of interconnecting cables that hang closer than 40cm to the ground plane shall be folded back and forth in the center forming a bundle 30 cm to 40 cm long. All of EUT and AE shall be separate place more than 0.1m. All 50 Ω ports of the LISN shall be resistively terminated into 50 Ω loads when not connected to the measuring instrument.

If the reading of the measuring receiver shows fluctuations close to the limit, the reading shall be observed for at least 15 s at each measurement frequency; the higher reading shall be recorded with the exception of any brief isolated high reading which shall be ignored.

4.5. Test Result

Standard:	FCC Part 15C	Line:	L1
Test item:	Conducted Emission	Power:	AC 120V/60Hz
Test Mode:	Mode 1	Temp.(°C)/Hum.(%RH):	26(°C)/60%RH
		Date:	04/02/2017
Description:			

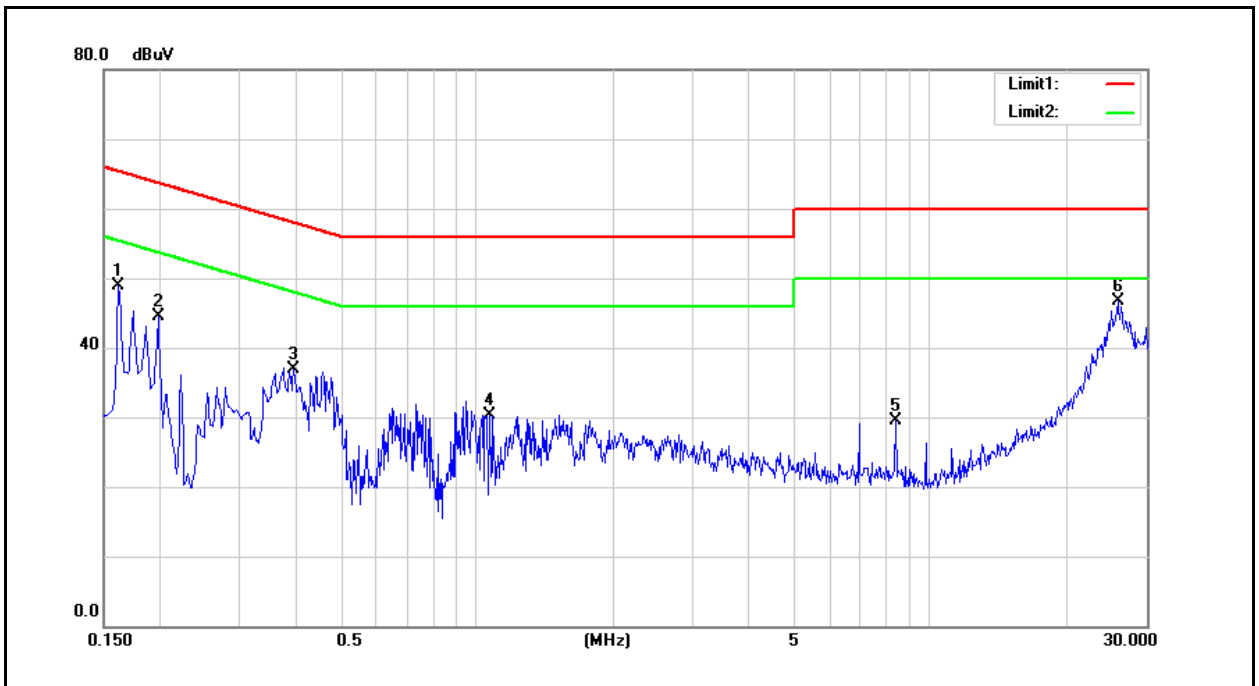

No.	Frequency (MHz)	QP reading (dBuV)	AVG reading (dBuV)	Correction factor (dB)	QP result (dBuV)	AVG result (dBuV)	QP limit (dBuV)	AVG limit (dBuV)	QP margin (dB)	AVG margin (dB)	Remark
1	0.1620	31.69	17.05	9.60	41.29	26.65	65.36	55.36	-24.07	-28.71	Pass
2	0.1980	26.47	14.85	9.59	36.06	24.44	63.69	53.69	-27.63	-29.25	Pass
3	0.3940	24.28	18.00	9.60	33.88	27.60	57.98	47.98	-24.10	-20.38	Pass
4	1.0700	15.01	4.84	9.64	24.65	14.48	56.00	46.00	-31.35	-31.52	Pass
5	8.3780	18.23	14.65	9.86	28.09	24.51	60.00	50.00	-31.91	-25.49	Pass
6	25.9180	29.48	19.50	9.99	39.47	29.49	60.00	50.00	-20.53	-20.51	Pass

Note: 1. Result (dBuV/m) = Correct Factor (dB/m) + Reading(dBuV).

2. Correction factor (dB) = Cable loss (dB) + L.I.S.N. factor (dB).



Standard:	FCC Part 15C	Line:	N
Test item:	Conducted Emission	Power:	AC 120V/60Hz
Test Mode:	Mode 1	Temp.(°C)/Hum.(%RH):	26(°C)/60%RH
		Date:	04/02/2017
Description:			

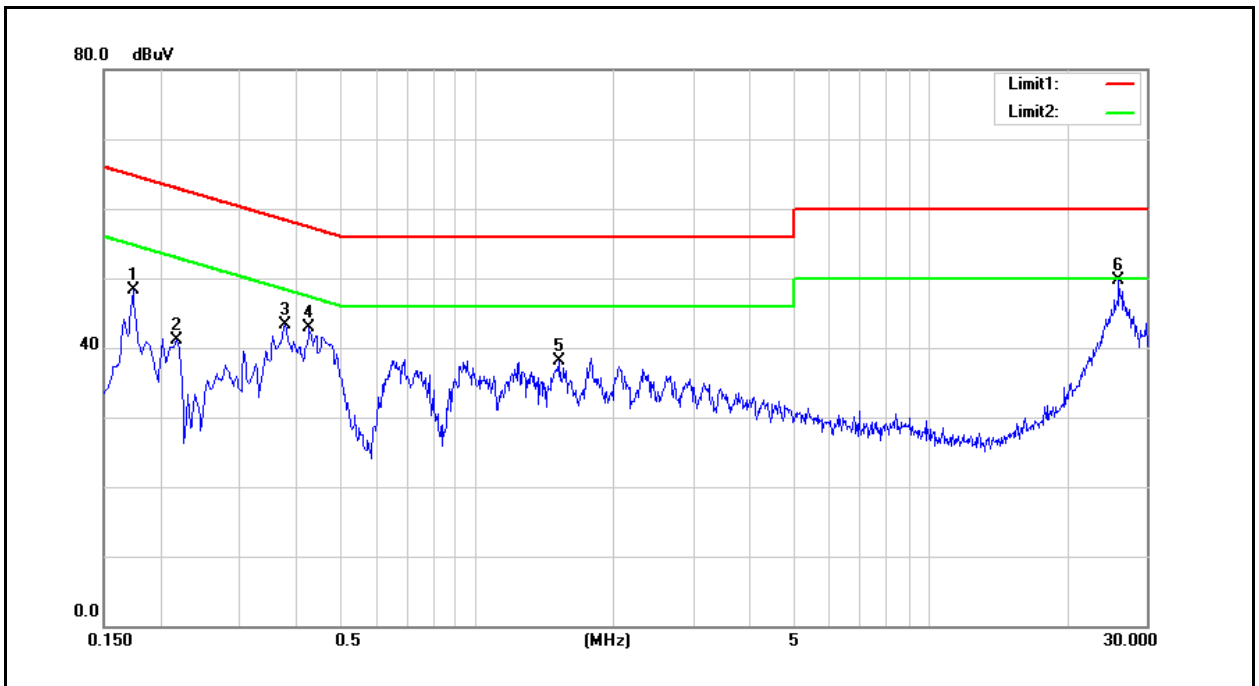

No.	Frequency (MHz)	QP reading (dBuV)	AVG reading (dBuV)	Correction factor (dB)	QP result (dBuV)	AVG result (dBuV)	QP limit (dBuV)	AVG limit (dBuV)	QP margin (dB)	AVG margin (dB)	Remark
1	0.1740	30.23	21.52	9.59	39.82	31.11	64.77	54.77	-24.95	-23.66	Pass
2	0.2180	22.87	8.42	9.58	32.45	18.00	62.89	52.89	-30.44	-34.89	Pass
3	0.3780	29.60	26.04	9.59	39.19	35.63	58.32	48.32	-19.13	-12.69	Pass
4	0.4260	26.62	24.25	9.59	36.21	33.84	57.33	47.33	-21.12	-13.49	Pass
5	1.5260	24.10	17.53	9.66	33.76	27.19	56.00	46.00	-22.24	-18.81	Pass
6	26.0060	30.66	20.21	10.17	40.83	30.38	60.00	50.00	-19.17	-19.62	Pass

Note: 1. Result (dBuV/m) = Correct Factor (dB/m) + Reading(dBuV).
 2. Correction factor (dB) = Cable loss (dB) + L.I.S.N. factor (dB).



5 Radiated Emission Measurement

5.1. Limit

According to §15.209(a), except as provided elsewhere in this subpart, the emissions from an intentional radiator shall not exceed the field strength levels specified in the following table:

Frequency (MHz)	Field Strength ($\mu\text{V}/\text{m}$ at meter)	Measurement Distance (meters)
0.009 – 0.490	2400 / F (kHz)	300
0.490 – 1.705	24000 / F (kHz)	30
1.705 – 30.0	30	30
30 - 88	100**	3
88-216	150**	3
216-960	200**	3
Above 960	500	3

** Except as provided in paragraph (g), fundamental emissions from intentional radiators operating under this Section shall not be located in the frequency bands 54-72 MHz, 76-88 MHz, 174-216 MHz or 470-806 MHz. However, operation within these frequency bands is permitted under other sections of this Part, e.g., Sections 15.231 and 15.241.

5.2. Test Instruments

3 Meter Chamber					
Equipment	Manufacturer	Model Number	Serial Number	Cal. Date	Cal. Period
RF Pre-selector	Agilent	N9039A	MY46520256	03/22/2016	1 year
RF Pre-selector	Agilent	N9039A	MY46520256	04/05/2017	1 year
Spectrum Analyzer	Agilent	E4446A	MY46180578	03/22/2016	1 year
Spectrum Analyzer	Agilent	E4446A	MY46180578	04/05/2017	1 year
Pre Amplifier	Agilent	8449B	3008A02237	10/11/2016	1 year
Pre Amplifier	Agilent	8447D	2944A11119	01/12/2017	1 year
Broadband Antenna	Schwarzbeck	VULB9168	416	10/13/2016	1 year
Horn Antenna (1~18GHz)	SCHWARZBECK MESS-ELEKTRONIK	BBHA9120D	9120D-550	06/06/2016	1 year
Horn Antenna (18~40GHz)	ETS	3116	86467	09/05/2016	1 year
Loop Antenna	COM-POWER CORPORATION	AL-130	121014	01/26/2017	1 year
Microwave Cable	EMCI	EMC102-KM-KM-14000	151001	02/20/2017	1 year
Microwave Cable	EMCI	EMC-104-SM-SM-14000	140202	02/20/2017	1 year
Microwave Cable	EMCI	EMC104-SM-SM-600	140301	02/20/2017	1 year
Test Site	ATL	TE01	888001	08/29/2016	1 year

Note: N.C.R. = No Calibration Request.

5.3. Setup

9kHz ~ 30MHz

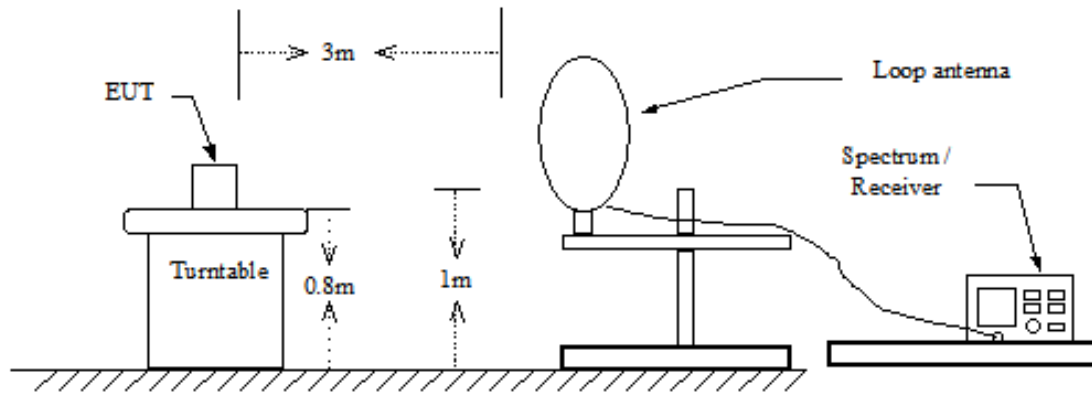

Below 1GHz

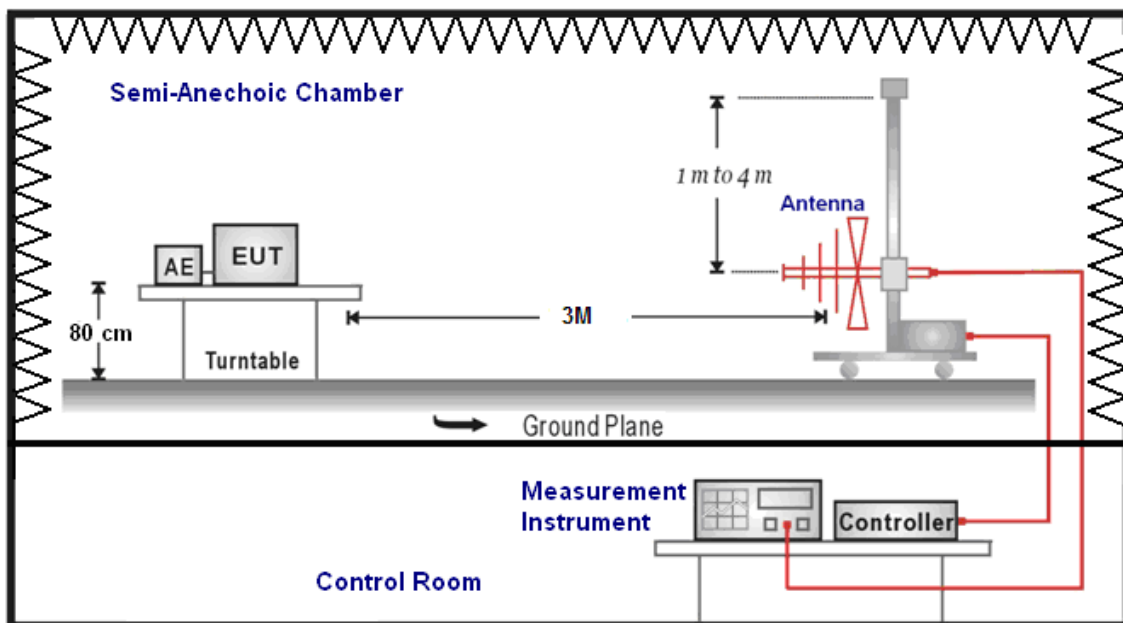

Above 1GHz

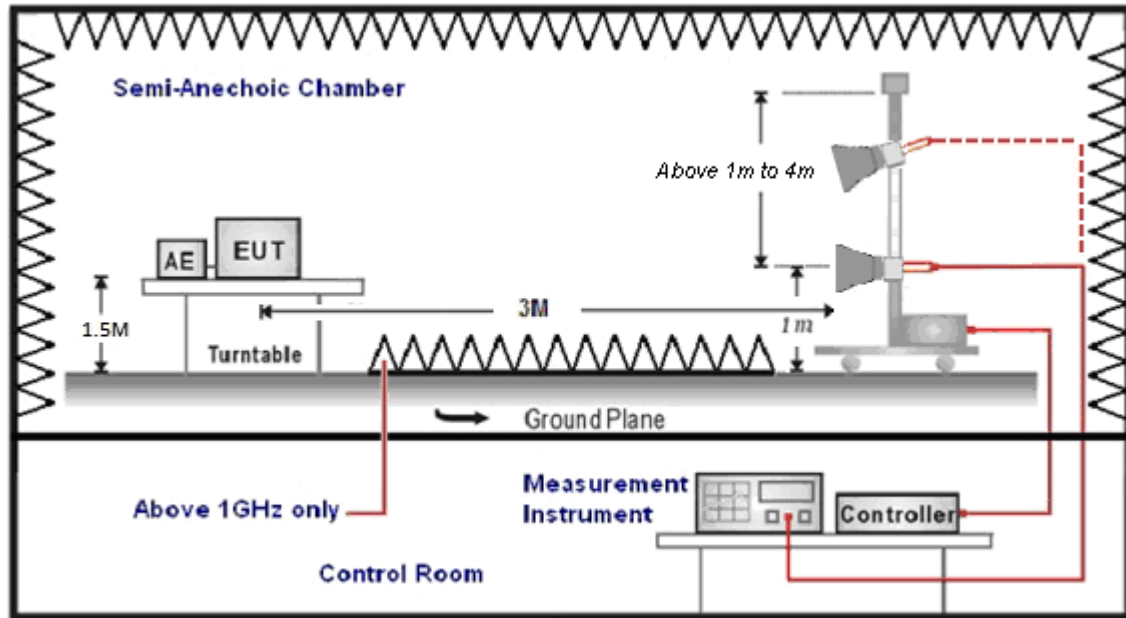



5.4. Test Procedure

Final radiation measurements were made on a three-meter, Semi Anechoic Chamber. The EUT system was placed on a nonconductive turntable which is 0.8 or 1.5 meters height (below 1GHz use 0.8m turntable / above 1GHz use 1.5m turntable), top surface 1.0 x 1.5 meter. The spectrum was examined from 250 MHz to 2.5 GHz in order to cover the whole spectrum below 10th harmonic which could generate from the EUT. During the test, EUT was set to transmit continuously & Measurements spectrum range from 9 kHz to 26.5 GHz is investigated.

For measurements below 1 GHz the resolution bandwidth is set to 100 kHz for peak detection measurements or 120 kHz for quasi-peak detection measurements. Peak detection is used unless otherwise noted as quasi-peak.

For measurements above 1 GHz the resolution bandwidth is set to 1 MHz, and then the video bandwidth is set to 1 MHz for peak measurements and 10 Hz for average measurements when Duty cycle >0.98 / $1/T$ for average measurements when Duty cycle <0.98 . A nonconductive material surrounded the EUT to supporting the EUT for standing on three orthogonal planes. At each condition, the EUT was rotated 360 degrees, and the antenna was raised and lowered from one to four meters to find the maximum emission levels. Measurements were taken using both horizontal and vertical antenna polarization.

SCHWARZBECK MESS-ELEKTRONIK Biconilog Antenna at 3 Meter and the SCHWARZBECK Double Ridged Guide Antenna was used in frequencies 1 –26.5 GHz at a distance of 3 meter. The antenna at an angle toward the source of the emission. All test results were extrapolated to equivalent signal at 3 meters utilizing an inverse linear distance extrapolation Factor (20dB/decade).

For testing above 1GHz, the emission level of the EUT in peak mode was 20dB lower than average limit (that means the emission level in peak mode also complies with the limit in average mode), then testing will be stopped and peak values of EUT will be reported, otherwise, the emissions will be measured in average mode again and reported.

Appropriate preamplifiers were used for improving sensitivity and precautions were taken to avoid overloading or desensitizing the spectrum analyzer. No post – detector video filters were used in the test.

The spectrum analyzer's 6 dB bandwidth was set to 1 MHz, and the analyzer was operated in the peak detection mode, for frequencies both below and up 1 GHz. The average levels were obtained by subtracting the duty cycle correction factor from the peak readings.

The following procedures were used to convert the emission levels measured in decibels referenced to 1 microvolt (dBuV) into field intensity in micro volts pre meter (uV/m).

The actual field intensity in decibels referenced to 1 microvolt in to field intensity in micro volts per meter (dBuV/m).



The actual field intensity in referenced to 1 microvolt per meter (dBuV/m) is determined by algebraically adding the measured reading in dBuV, the antenna factor (dB), and cable loss (dB) and Subtracting the gain of preamplifier (dB) is auto calculate in spectrum analyzer.

(1) $\text{Amplitude (dBuV/m)} = \text{FI (dBuV)} + \text{AF (dBuV)} + \text{CL (dBuV)} - \text{Gain (dB)}$

FI= Reading of the field intensity.

AF= Antenna factor.

CL= Cable loss.

P.S Amplitude is auto calculate in spectrum analyzer.

(2) $\text{Actual Amplitude (dBuV/m)} = \text{Amplitude (dBuV)} - \text{Dis(dB)}$

The FCC specified emission limits were calculated according the EUT operating frequency and by following linear interpolation equations:

(a) For fundamental frequency : Transmitter Output < +30dBm

(b) For spurious frequency : Spurious emission limits = fundamental emission limit /10

Data of measurement within this frequency range without mark in the table above means the reading of emissions are attenuated more than 20dB below the permissible limits or the field strength is too small to be measured.



5.5. Test Result

Below 1GHz

Standard:	FCC Part 15C	Test Distance:	3m
Test item:	Radiated Emission	Power:	AC 120V/60Hz
Test Mode:	Mode 1	Temp.(°C)/Hum.(%RH):	26(°C)/60%RH
		Date:	03/20/2017

Frequency (MHz)	Reading (dBuV)	Correct Factor (dB/m)	Result (dBuV/m)	Limit (dBuV/m)	Margin (dB)	Remark	Ant.Polar. H / V
250.0000	44.84	-5.28	39.56	46.00	-6.44	QP	H
375.0000	43.37	-2.18	41.19	46.00	-4.81	QP	H
500.0000	34.61	0.74	35.35	46.00	-10.65	QP	H
625.0000	33.93	3.41	37.34	46.00	-8.66	QP	H
750.0000	28.22	6.03	34.25	46.00	-11.75	QP	H
875.0000	29.41	8.07	37.48	46.00	-8.52	QP	H
250.0000	39.41	-5.28	34.13	46.00	-11.87	QP	V
375.0000	43.60	-2.18	41.42	46.00	-4.58	QP	V
500.0000	35.83	0.74	36.57	46.00	-9.43	QP	V
625.0000	37.22	3.41	40.63	46.00	-5.37	QP	V
746.0000	27.32	5.92	33.24	46.00	-12.76	QP	V
875.0000	27.47	8.07	35.54	46.00	-10.46	QP	V

Note:1.Result (dBuV/m) = Correct Factor (dB/m) + Reading(dBuV).

2. Correction factor (dB/m) = Antenna Factor (dB/m) + Cable loss (dB) – Pre-Amplifier gain (dB).

3.No emission found between lowest internal used/generated frequencies to 30MHz (9 kHz~30MHz).



Above 1GHz

Standard:	FCC Part 15C	Test Distance:	3m
Test item:	Harmonic	Power:	AC 120V/60Hz
Frequency:	2412MHz	Temp.(°C)/Hum.(%RH):	26(°C)/60%RH
Mode:	Mode 2	Date:	03/20/2017
Ant.Polar.:	Horizontal		

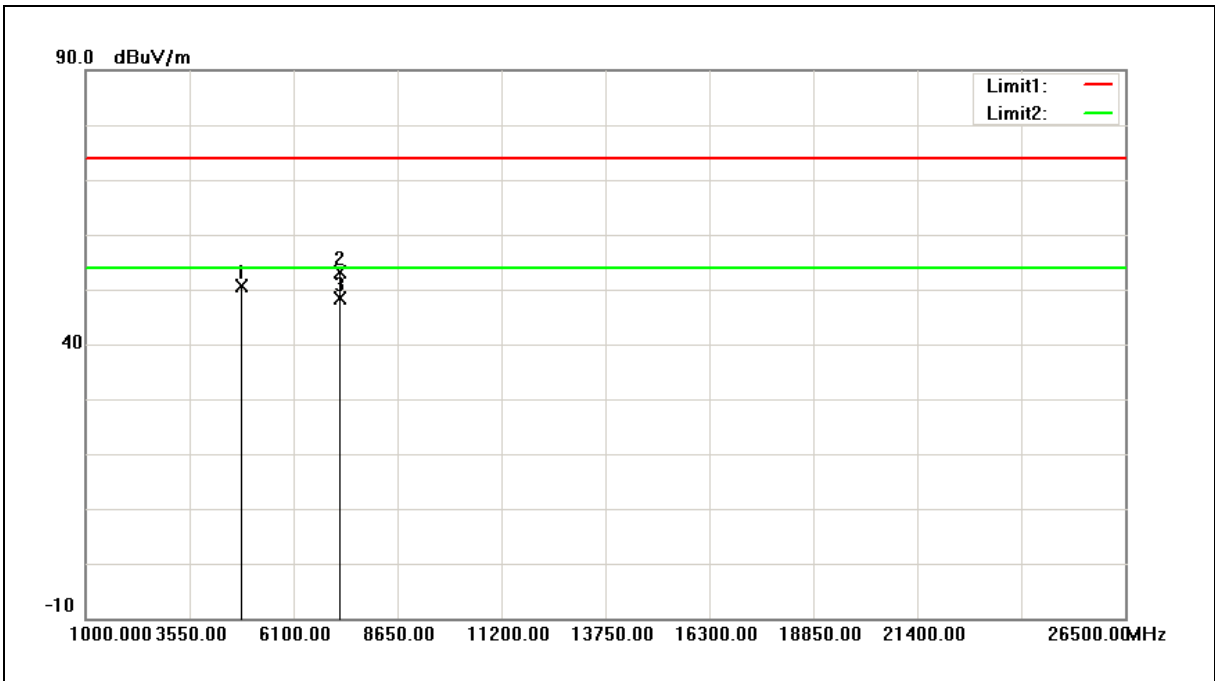

No.	Frequency (MHz)	Reading (dBuV)	Correct Factor (dB/m)	Result (dBuV/m)	Limit (dBuV/m)	Margin (dB)	Remark
1	4824.000	57.73	-7.11	50.62	74.00	-23.38	peak
2	7236.000	53.64	-0.43	53.21	74.00	-20.79	peak
3	7236.000	48.76	-0.43	48.33	54.00	-5.67	AVG

Note:1.Result (dBuV/m) = Correct Factor (dB/m) + Reading(dBuV).

2.Correction factor (dB/m) = Antenna Factor (dB/m) + Cable loss (dB) – Pre-Amplifier gain (dB).

3. When the peak results are less than average limit, so not need to evaluate the average.



Standard:	FCC Part 15C	Test Distance:	3m
Test item:	Harmonic	Power:	AC 120V/60Hz
Frequency:	2412MHz	Temp.(°C)/Hum.(%RH):	26(°C)/60%RH
Mode:	Mode 2	Date:	03/20/2017
Ant.Polar.:	Vertical		

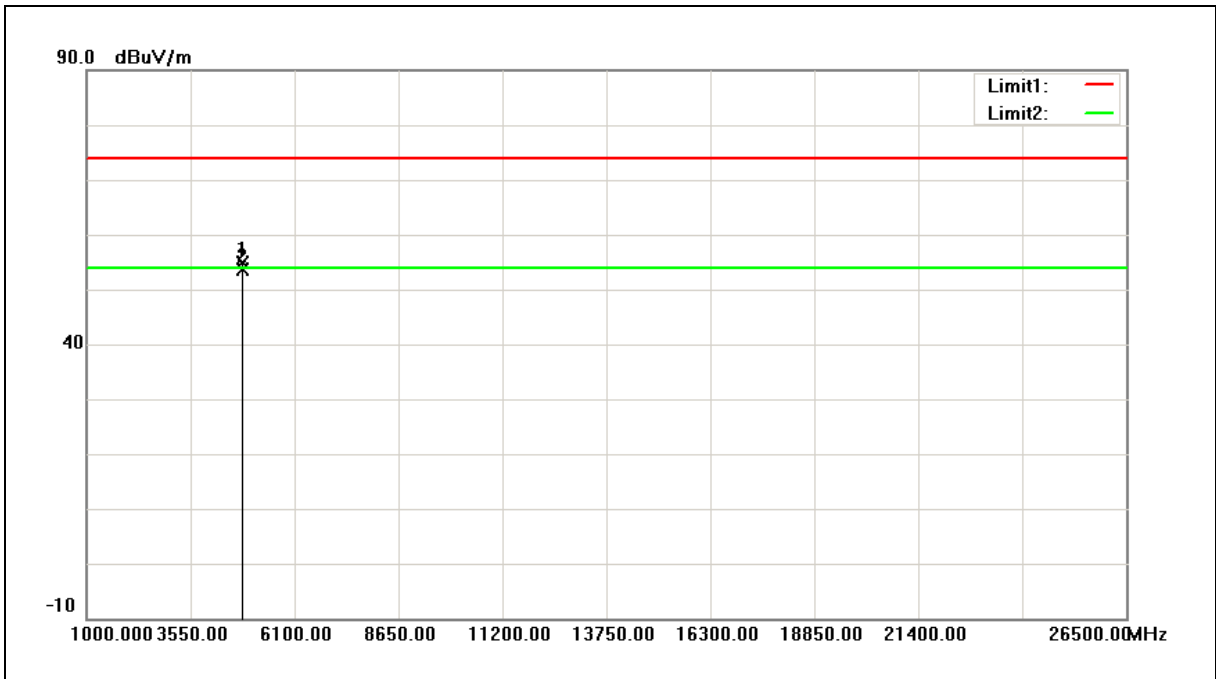

No.	Frequency (MHz)	Reading (dBuV)	Correct Factor (dB/m)	Result (dBuV/m)	Limit (dBuV/m)	Margin (dB)	Remark
1	4824.000	61.96	-7.11	54.85	74.00	-19.15	peak
2	4824.000	60.63	-7.11	53.52	54.00	-0.48	AVG

- Note: 1. Result (dBuV/m) = Correct Factor (dB/m) + Reading(dBuV).
 2. Correction factor (dB/m) = Antenna Factor (dB/m) + Cable loss (dB) – Pre-Amplifier gain (dB).
 3. When the peak results are less than average limit, so not need to evaluate the average.



Standard:	FCC Part 15C	Test Distance:	3m
Test item:	Harmonic	Power:	AC 120V/60Hz
Frequency:	2437MHz	Temp.(°C)/Hum.(%RH):	26(°C)/60%RH
Mode:	Mode 2	Date:	03/20/2017
Ant.Polar.:	Horizontal		

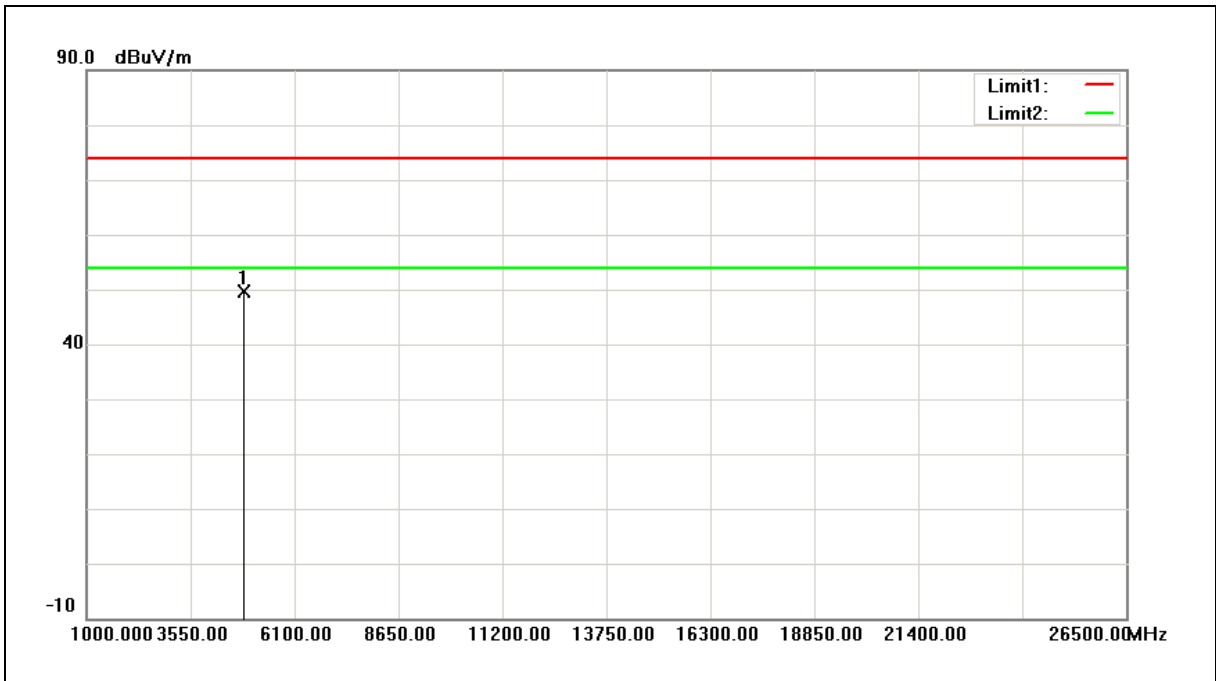

No.	Frequency (MHz)	Reading (dBuV)	Correct Factor (dB/m)	Result (dBuV/m)	Limit (dBuV/m)	Margin (dB)	Remark
1	4874.000	56.51	-6.95	49.56	74.00	-24.44	peak

Note:1.Result (dBuV/m) = Correct Factor (dB/m) + Reading(dBuV).

2.Correction factor (dB/m) = Antenna Factor (dB/m) + Cable loss (dB) – Pre-Amplifier gain (dB).

3. When the peak results are less than average limit, so not need to evaluate the average.



Standard:	FCC Part 15C	Test Distance:	3m
Test item:	Harmonic	Power:	AC 120V/60Hz
Frequency:	2437MHz	Temp.(°C)/Hum.(%RH):	26(°C)/60%RH
Mode:	Mode 2	Date:	03/20/2017
Ant.Polar.:	Vertical		

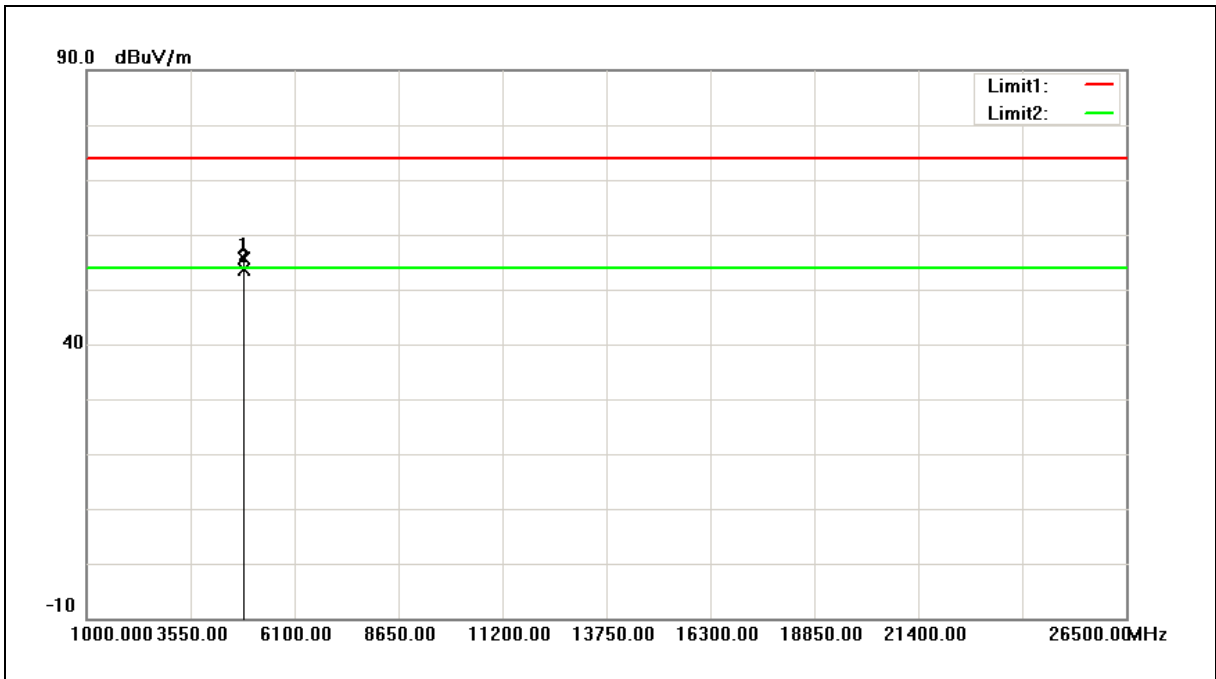

No.	Frequency (MHz)	Reading (dBuV)	Correct Factor (dB/m)	Result (dBuV/m)	Limit (dBuV/m)	Margin (dB)	Remark
1	4874.000	62.57	-6.95	55.62	74.00	-18.38	peak
2	4874.000	60.68	-6.95	53.73	54.00	-0.27	AVG

- Note: 1. Result (dBuV/m) = Correct Factor (dB/m) + Reading(dBuV).
 2. Correction factor (dB/m) = Antenna Factor (dB/m) + Cable loss (dB) – Pre-Amplifier gain (dB).
 3. When the peak results are less than average limit, so not need to evaluate the average.



Standard:	FCC Part 15C	Test Distance:	3m
Test item:	Harmonic	Power:	AC 120V/60Hz
Frequency:	2462MHz	Temp.(°C)/Hum.(%RH):	26(°C)/60%RH
Mode:	Mode 2	Date:	03/21/2017
Ant.Polar.:	Horizontal		

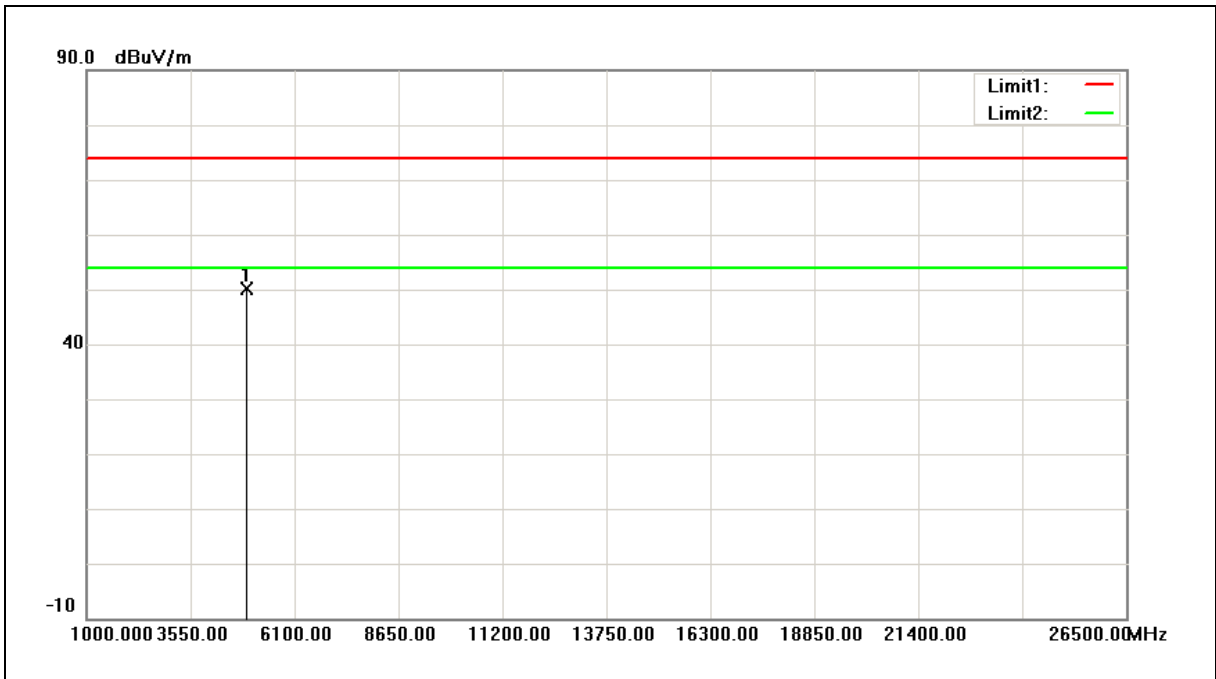

No.	Frequency (MHz)	Reading (dBuV)	Correct Factor (dB/m)	Result (dBuV/m)	Limit (dBuV/m)	Margin (dB)	Remark
1	4924.000	57.01	-6.81	50.20	74.00	-23.80	peak

Note:1.Result (dBuV/m) = Correct Factor (dB/m) + Reading(dBuV).

2.Correction factor (dB/m) = Antenna Factor (dB/m) + Cable loss (dB) – Pre-Amplifier gain (dB).

3. When the peak results are less than average limit, so not need to evaluate the average.



Standard:	FCC Part 15C	Test Distance:	3m
Test item:	Harmonic	Power:	AC 120V/60Hz
Frequency:	2462MHz	Temp.(°C)/Hum.(%RH):	26(°C)/60%RH
Mode:	Mode 2	Date:	03/21/2017
Ant.Polar.:	Vertical		

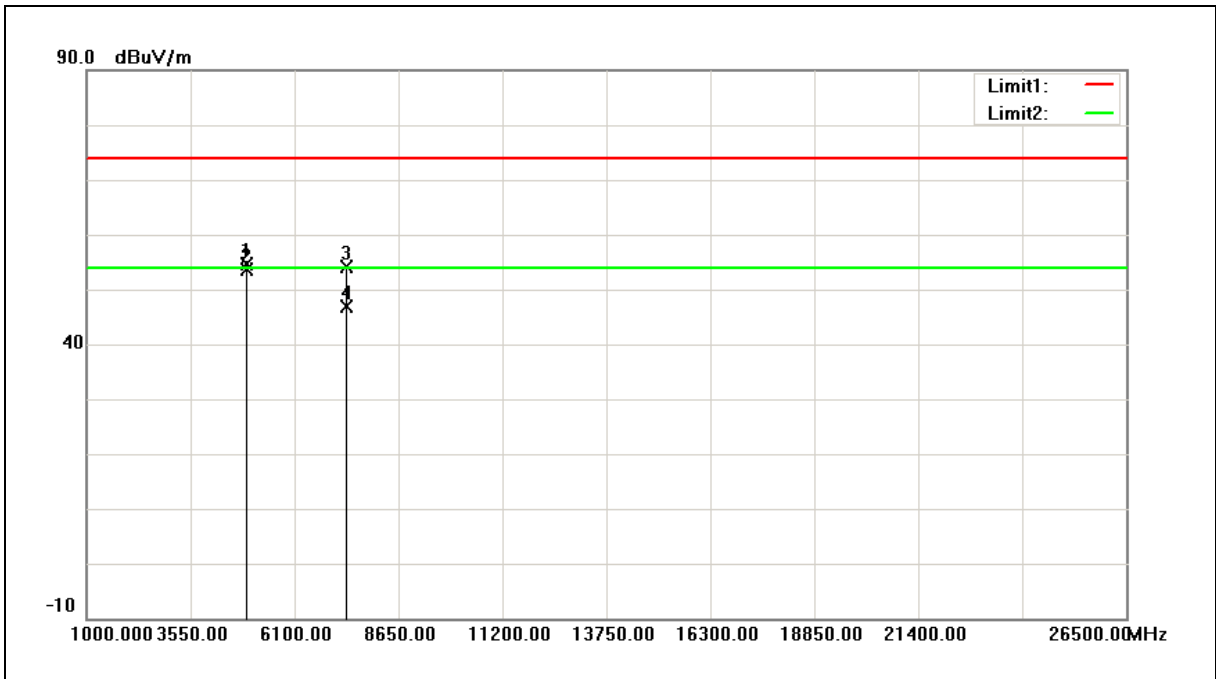

No.	Frequency (MHz)	Reading (dBuV)	Correct Factor (dB/m)	Result (dBuV/m)	Limit (dBuV/m)	Margin (dB)	Remark
1	4924.000	61.50	-6.81	54.69	74.00	-19.31	peak
2	4924.000	60.54	-6.81	53.73	54.00	-0.27	AVG
3	7386.000	53.99	0.11	54.10	74.00	-19.90	peak
4	7386.000	46.89	0.11	47.00	54.00	-7.00	AVG

Note:1.Result (dBuV/m) = Correct Factor (dB/m) + Reading(dBuV).

2.Correction factor (dB/m) = Antenna Factor (dB/m) + Cable loss (dB) – Pre-Amplifier gain (dB).

3. When the peak results are less than average limit, so not need to evaluate the average.



Standard:	FCC Part 15C	Test Distance:	3m
Test item:	Harmonic	Power:	AC 120V/60Hz
Frequency:	2412MHz	Temp.(°C)/Hum.(%RH):	26(°C)/60%RH
Mode:	Mode 3	Date:	03/21/2017
Ant.Polar.:	Horizontal		

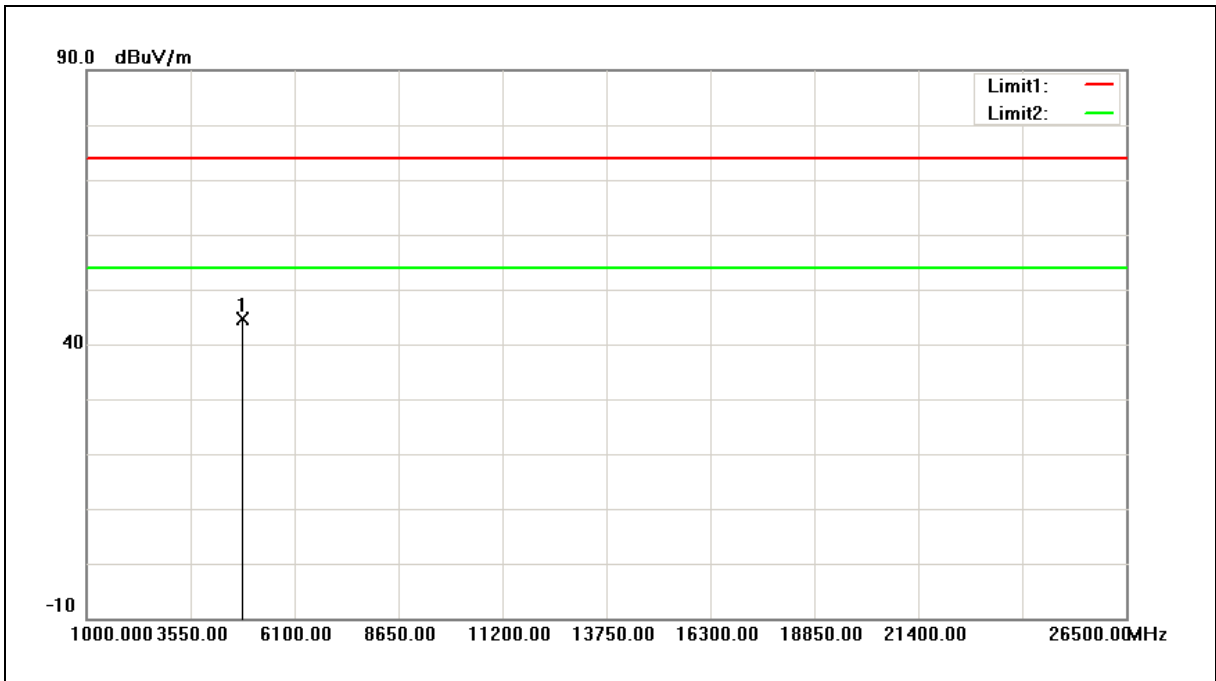

No.	Frequency (MHz)	Reading (dBuV)	Correct Factor (dB/m)	Result (dBuV/m)	Limit (dBuV/m)	Margin (dB)	Remark
1	4824.000	51.63	-7.11	44.52	74.00	-29.48	peak

Note:1.Result (dBuV/m) = Correct Factor (dB/m) + Reading(dBuV).

2.Correction factor (dB/m) = Antenna Factor (dB/m) + Cable loss (dB) – Pre-Amplifier gain (dB).

3. When the peak results are less than average limit, so not need to evaluate the average.



Standard:	FCC Part 15C	Test Distance:	3m
Test item:	Harmonic	Power:	AC 120V/60Hz
Frequency:	2412MHz	Temp.(°C)/Hum.(%RH):	26(°C)/60%RH
Mode:	Mode 3	Date:	03/21/2017
Ant.Polar.:	Vertical		

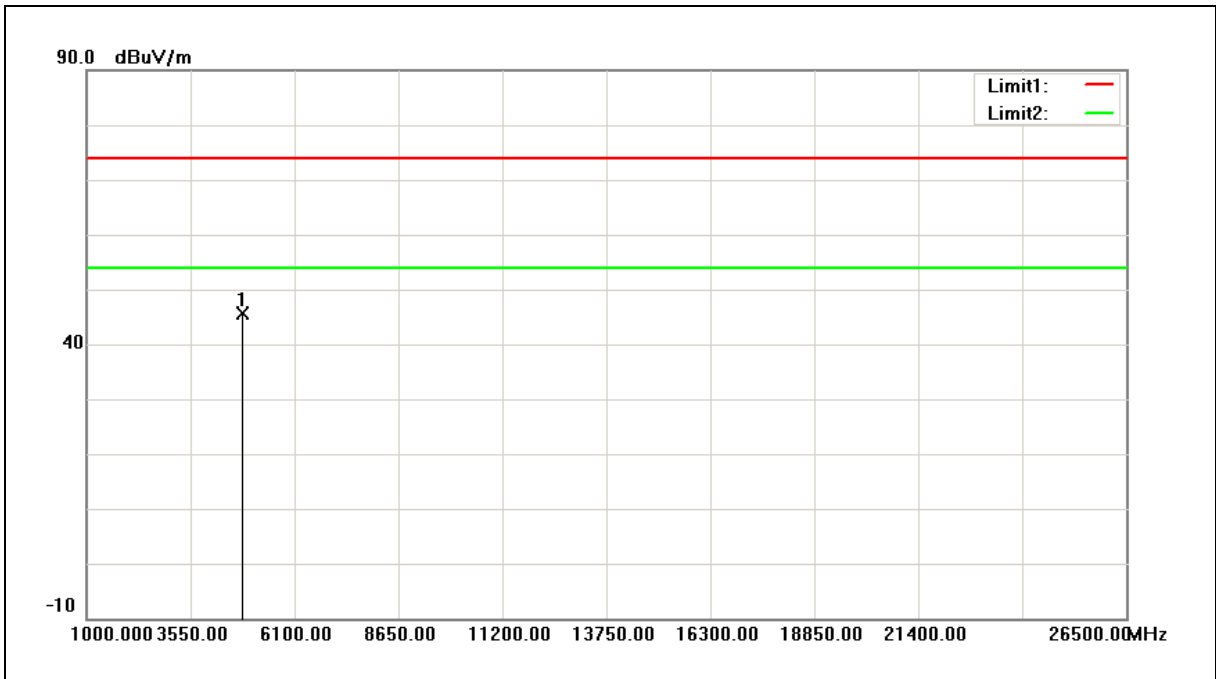

No.	Frequency (MHz)	Reading (dBuV)	Correct Factor (dB/m)	Result (dBuV/m)	Limit (dBuV/m)	Margin (dB)	Remark
1	4824.000	52.78	-7.11	45.67	74.00	-28.33	peak

Note:1.Result (dBuV/m) = Correct Factor (dB/m) + Reading(dBuV).

2.Correction factor (dB/m) = Antenna Factor (dB/m) + Cable loss (dB) – Pre-Amplifier gain (dB).

3. When the peak results are less than average limit, so not need to evaluate the average.



Standard:	FCC Part 15C	Test Distance:	3m
Test item:	Harmonic	Power:	AC 120V/60Hz
Frequency:	2437MHz	Temp.(°C)/Hum.(%RH):	26(°C)/60%RH
Mode:	Mode 3	Date:	03/21/2017
Ant.Polar.:	Horizontal		

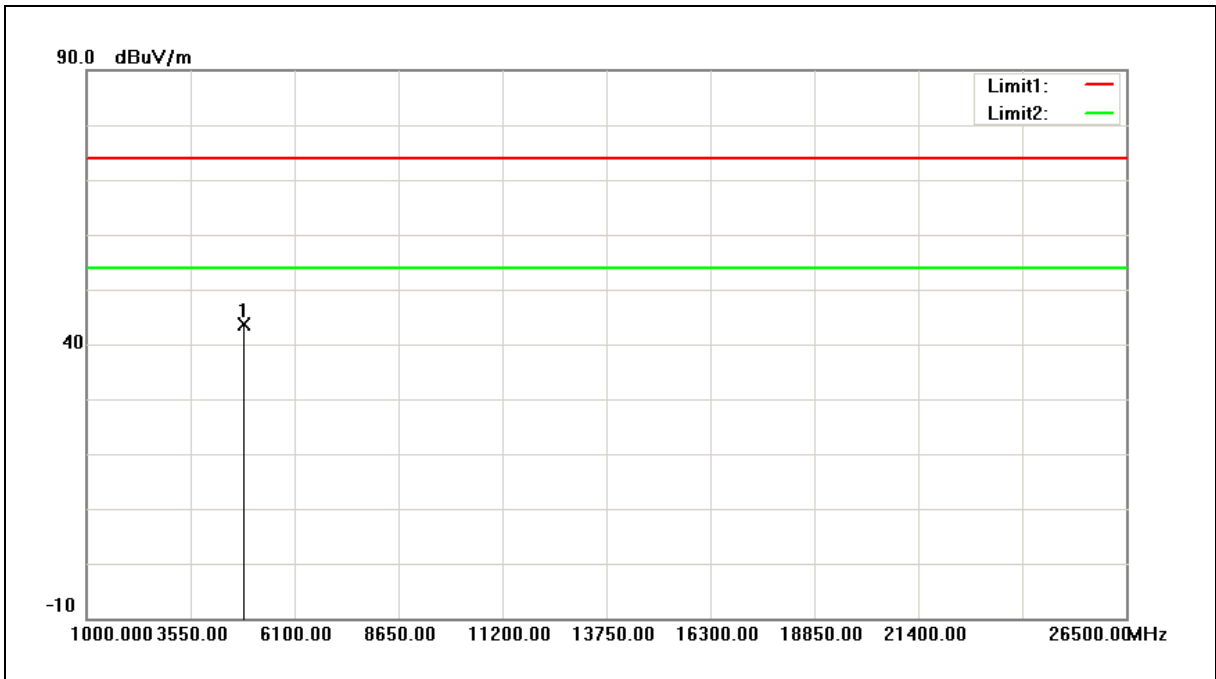

No.	Frequency (MHz)	Reading (dBuV)	Correct Factor (dB/m)	Result (dBuV/m)	Limit (dBuV/m)	Margin (dB)	Remark
1	4874.000	50.62	-6.95	43.67	74.00	-30.33	peak

Note:1.Result (dBuV/m) = Correct Factor (dB/m) + Reading(dBuV).

2.Correction factor (dB/m) = Antenna Factor (dB/m) + Cable loss (dB) – Pre-Amplifier gain (dB).

3. When the peak results are less than average limit, so not need to evaluate the average.



Standard:	FCC Part 15C	Test Distance:	3m
Test item:	Harmonic	Power:	AC 120V/60Hz
Frequency:	2437MHz	Temp.(°C)/Hum.(%RH):	26(°C)/60%RH
Mode:	Mode 3	Date:	03/21/2017
Ant.Polar.:	Vertical		

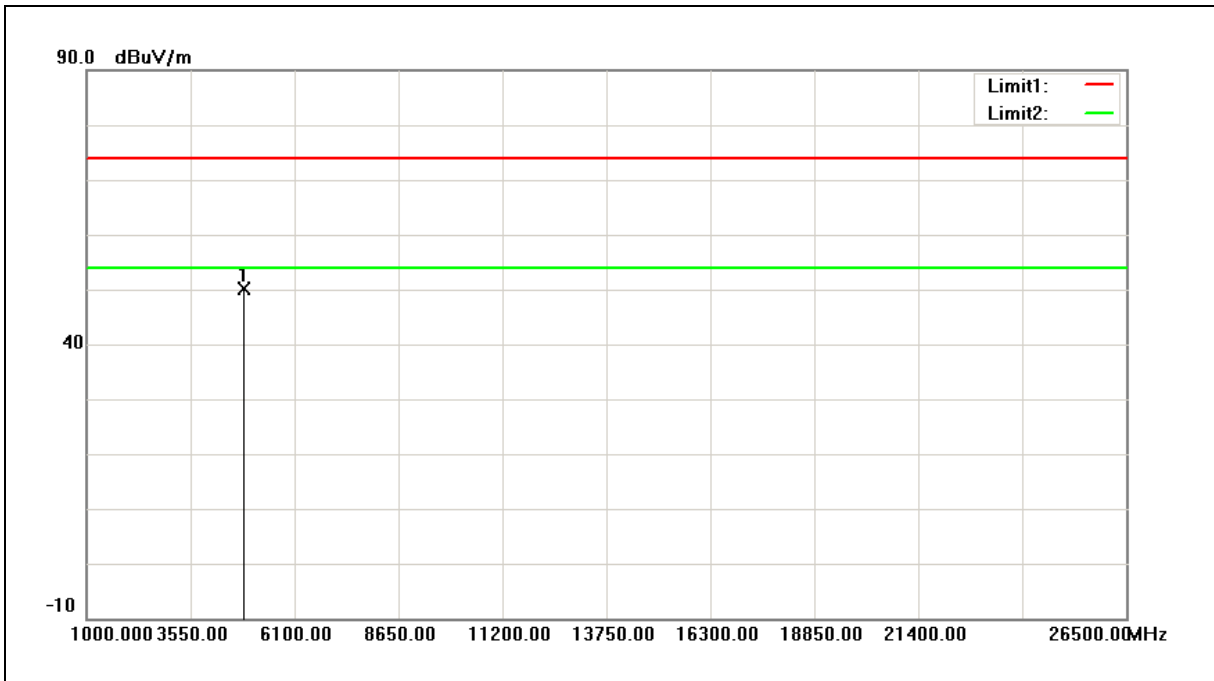

No.	Frequency (MHz)	Reading (dBuV)	Correct Factor (dB/m)	Result (dBuV/m)	Limit (dBuV/m)	Margin (dB)	Remark
1	4874.000	57.06	-6.95	50.11	74.00	-23.89	peak

Note:1.Result (dBuV/m) = Correct Factor (dB/m) + Reading(dBuV).

2.Correction factor (dB/m) = Antenna Factor (dB/m) + Cable loss (dB) – Pre-Amplifier gain (dB).

3. When the peak results are less than average limit, so not need to evaluate the average.



Standard:	FCC Part 15C	Test Distance:	3m
Test item:	Harmonic	Power:	AC 120V/60Hz
Frequency:	2462MHz	Temp.(°C)/Hum.(%RH):	26(°C)/60%RH
Mode:	Mode 3	Date:	03/21/2017
Ant.Polar.:	Horizontal		

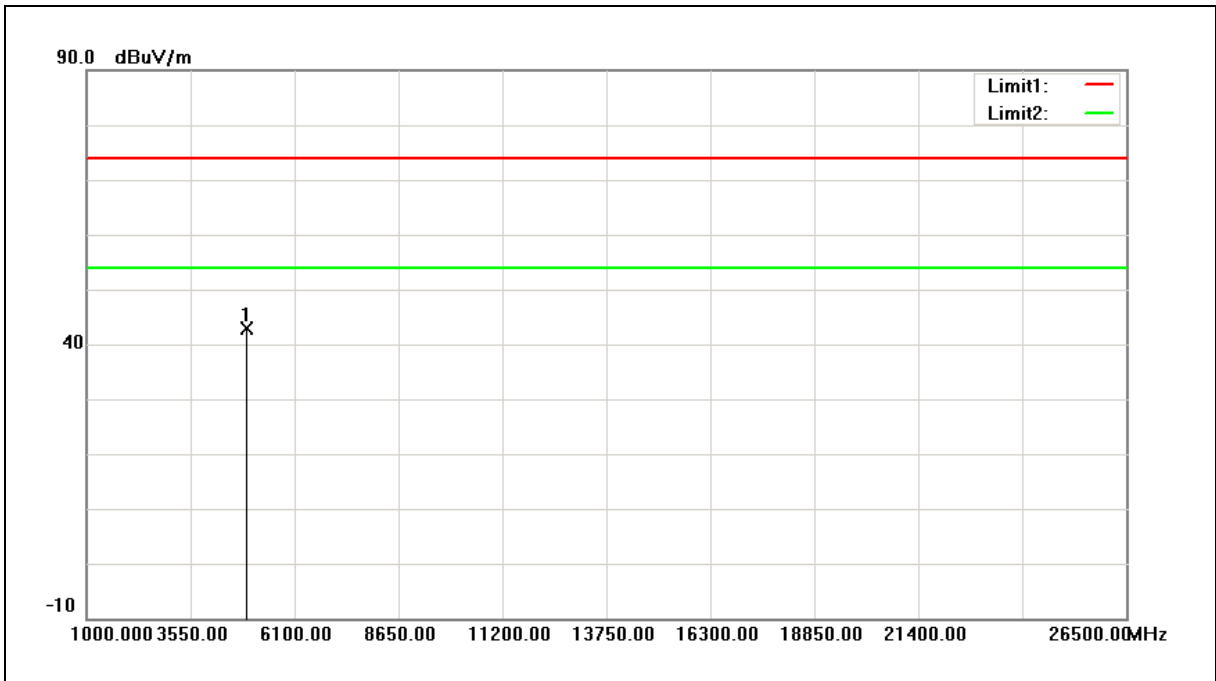

No.	Frequency (MHz)	Reading (dBuV)	Correct Factor (dB/m)	Result (dBuV/m)	Limit (dBuV/m)	Margin (dB)	Remark
1	4924.000	49.79	-6.81	42.98	74.00	-31.02	peak

Note:1.Result (dBuV/m) = Correct Factor (dB/m) + Reading(dBuV).

2.Correction factor (dB/m) = Antenna Factor (dB/m) + Cable loss (dB) – Pre-Amplifier gain (dB).

3. When the peak results are less than average limit, so not need to evaluate the average.



Standard:	FCC Part 15C	Test Distance:	3m
Test item:	Harmonic	Power:	AC 120V/60Hz
Frequency:	2462MHz	Temp.(°C)/Hum. (%RH):	26(°C)/60%RH
Mode:	Mode 3	Date:	03/21/2017
Ant.Polar.:	Vertical		

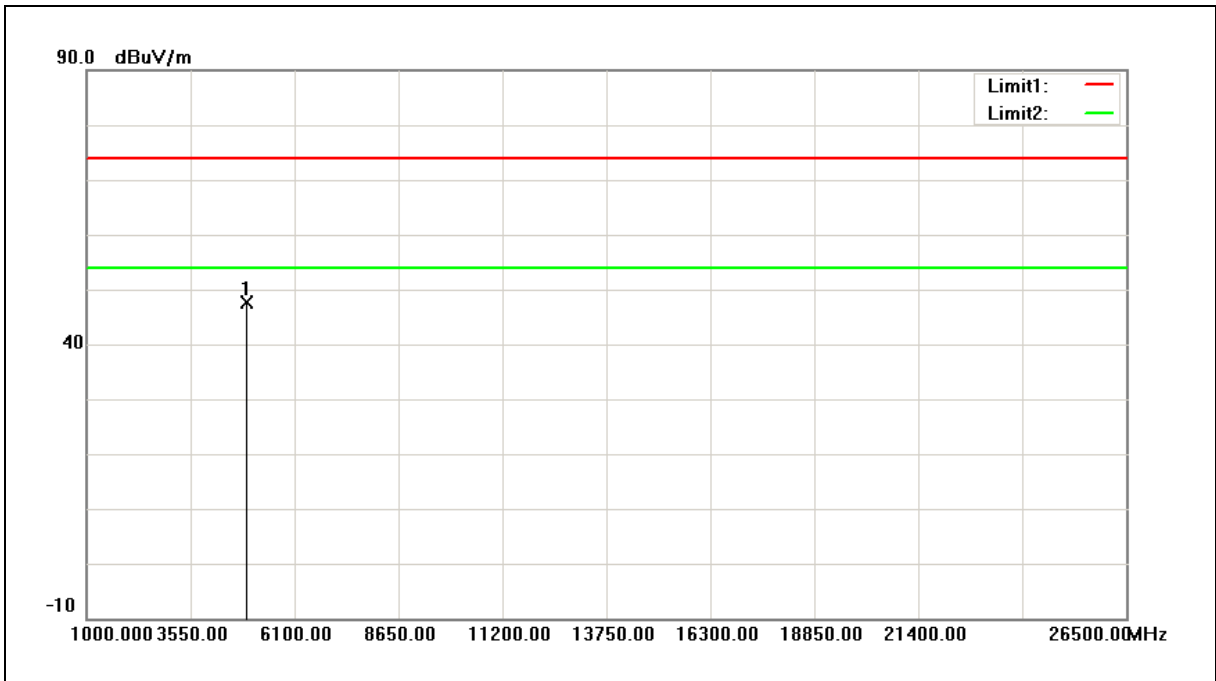

No.	Frequency (MHz)	Reading (dBuV)	Correct Factor (dB/m)	Result (dBuV/m)	Limit (dBuV/m)	Margin (dB)	Remark
1	4924.000	54.41	-6.81	47.60	74.00	-26.40	peak

Note:1.Result (dBuV/m) = Correct Factor (dB/m) + Reading(dBuV).

2.Correction factor (dB/m) = Antenna Factor (dB/m) + Cable loss (dB) – Pre-Amplifier gain (dB).

3. When the peak results are less than average limit, so not need to evaluate the average.



Standard:	FCC Part 15C	Test Distance:	3m
Test item:	Harmonic	Power:	AC 120V/60Hz
Frequency:	2412MHz	Temp.(°C)/Hum.(%RH):	26(°C)/60%RH
Mode:	Mode 4	Date:	03/21/2017
Ant.Polar.:	Horizontal		

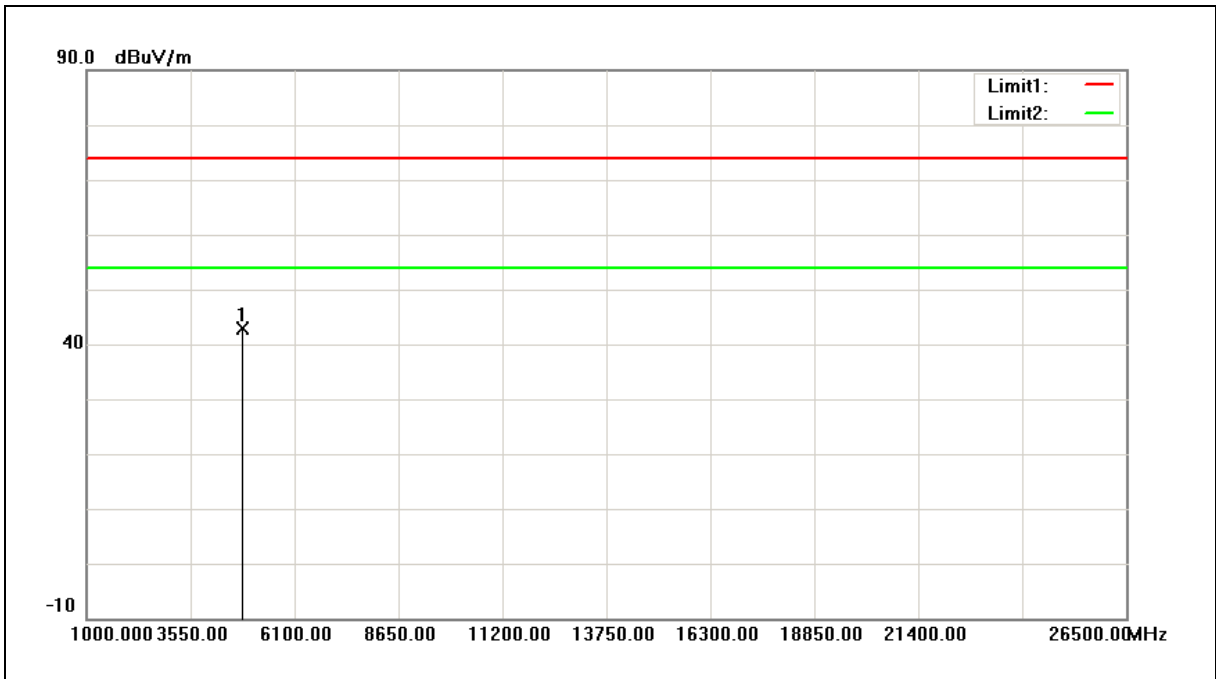

No.	Frequency (MHz)	Reading (dBuV)	Correct Factor (dB/m)	Result (dBuV/m)	Limit (dBuV/m)	Margin (dB)	Remark
1	4824.000	49.97	-7.11	42.86	74.00	-31.14	peak

Note:1.Result (dBuV/m) = Correct Factor (dB/m) + Reading(dBuV).

2.Correction factor (dB/m) = Antenna Factor (dB/m) + Cable loss (dB) – Pre-Amplifier gain (dB).

3. When the peak results are less than average limit, so not need to evaluate the average.



Standard:	FCC Part 15C	Test Distance:	3m
Test item:	Harmonic	Power:	AC 120V/60Hz
Frequency:	2412MHz	Temp.(°C)/Hum.(%RH):	26(°C)/60%RH
Mode:	Mode 4	Date:	03/21/2017
Ant.Polar.:	Vertical		

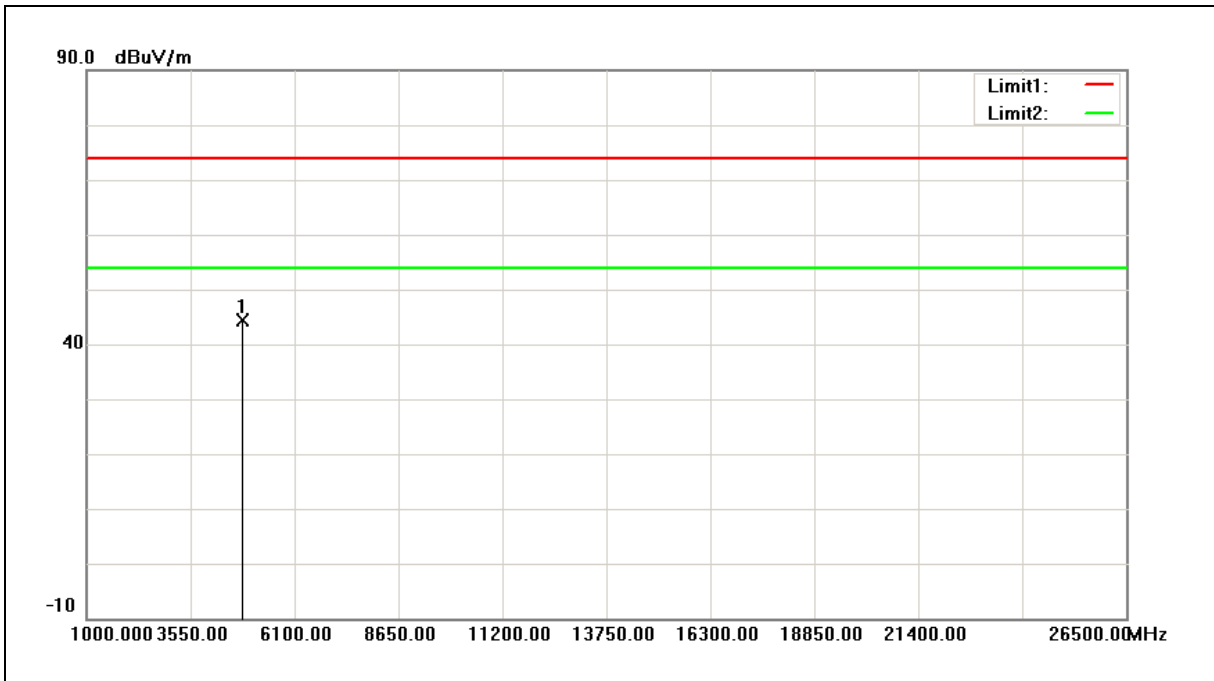

No.	Frequency (MHz)	Reading (dBuV)	Correct Factor (dB/m)	Result (dBuV/m)	Limit (dBuV/m)	Margin (dB)	Remark
1	4824.000	51.57	-7.11	44.46	74.00	-29.54	peak

Note:1.Result (dBuV/m) = Correct Factor (dB/m) + Reading(dBuV).

2.Correction factor (dB/m) = Antenna Factor (dB/m) + Cable loss (dB) – Pre-Amplifier gain (dB).

3. When the peak results are less than average limit, so not need to evaluate the average.



Standard:	FCC Part 15C	Test Distance:	3m
Test item:	Harmonic	Power:	AC 120V/60Hz
Frequency:	2437MHz	Temp.(°C)/Hum.(%RH):	26(°C)/60%RH
Mode:	Mode 4	Date:	03/21/2017
Ant.Polar.:	Horizontal		

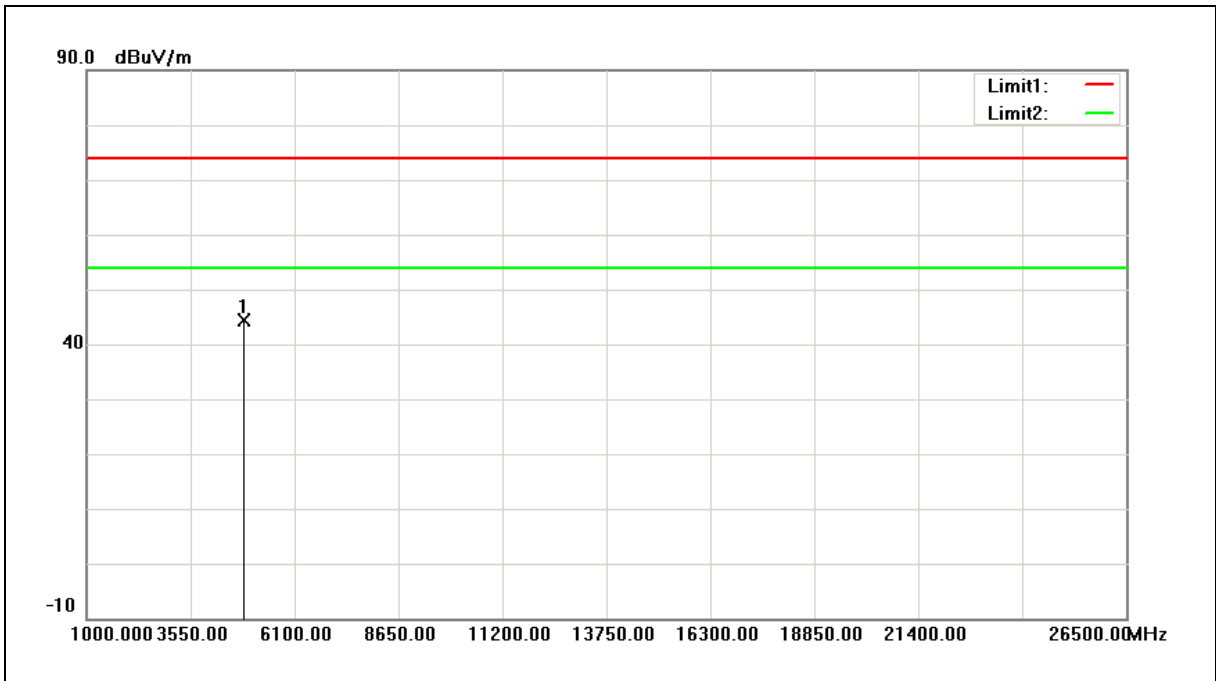

No.	Frequency (MHz)	Reading (dBuV)	Correct Factor (dB/m)	Result (dBuV/m)	Limit (dBuV/m)	Margin (dB)	Remark
1	4874.000	51.28	-6.95	44.33	74.00	-29.67	peak

Note: 1. Result (dBuV/m) = Correct Factor (dB/m) + Reading(dBuV).

2. Correction factor (dB/m) = Antenna Factor (dB/m) + Cable loss (dB) – Pre-Amplifier gain (dB).

3. When the peak results are less than average limit, so not need to evaluate the average.



Standard:	FCC Part 15C	Test Distance:	3m
Test item:	Harmonic	Power:	AC 120V/60Hz
Frequency:	2437MHz	Temp.(°C)/Hum.(%RH):	26(°C)/60%RH
Mode:	Mode 4	Date:	03/21/2017
Ant.Polar.:	Vertical		

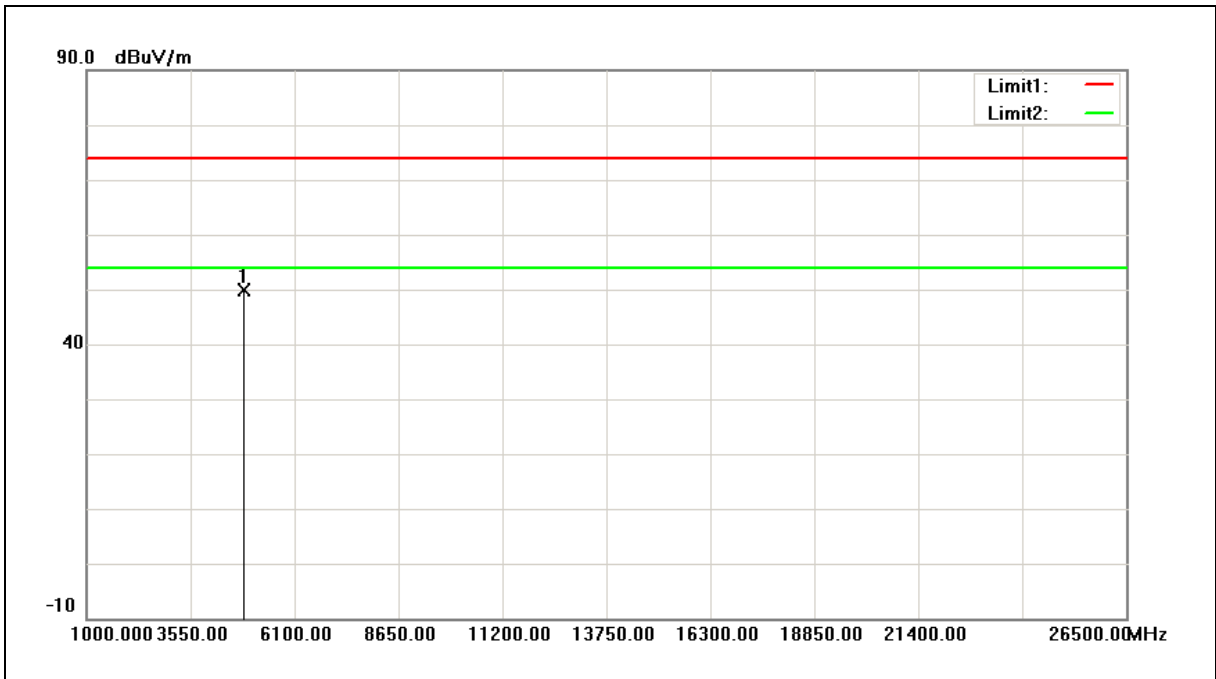

No.	Frequency (MHz)	Reading (dBuV)	Correct Factor (dB/m)	Result (dBuV/m)	Limit (dBuV/m)	Margin (dB)	Remark
1	4874.000	56.84	-6.95	49.89	74.00	-24.11	peak

Note:1.Result (dBuV/m) = Correct Factor (dB/m) + Reading(dBuV).

2.Correction factor (dB/m) = Antenna Factor (dB/m) + Cable loss (dB) – Pre-Amplifier gain (dB).

3. When the peak results are less than average limit, so not need to evaluate the average.



Standard:	FCC Part 15C	Test Distance:	3m
Test item:	Harmonic	Power:	AC 120V/60Hz
Frequency:	2462MHz	Temp.(°C)/Hum.(%RH):	26(°C)/60%RH
Mode:	Mode 4	Date:	03/21/2017
Ant.Polar.:	Horizontal		

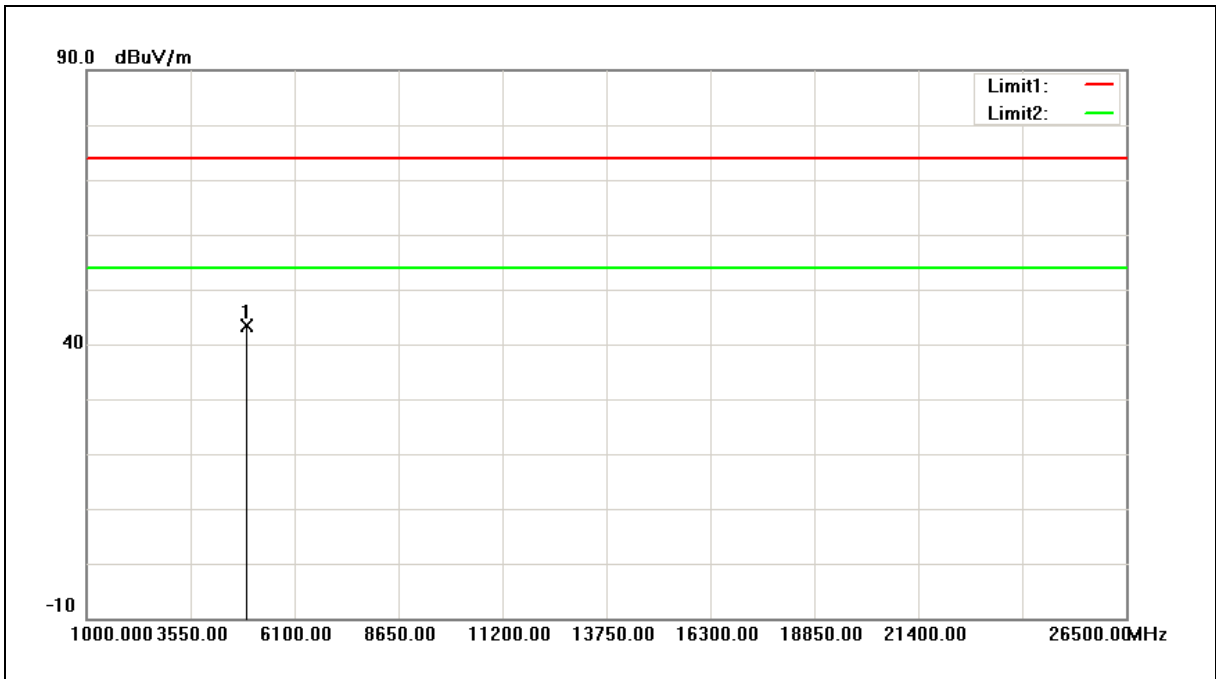

No.	Frequency (MHz)	Reading (dBuV)	Correct Factor (dB/m)	Result (dBuV/m)	Limit (dBuV/m)	Margin (dB)	Remark
1	4924.000	50.30	-6.81	43.49	74.00	-30.51	peak

Note:1.Result (dBuV/m) = Correct Factor (dB/m) + Reading(dBuV).

2.Correction factor (dB/m) = Antenna Factor (dB/m) + Cable loss (dB) – Pre-Amplifier gain (dB).

3. When the peak results are less than average limit, so not need to evaluate the average.



Standard:	FCC Part 15C	Test Distance:	3m
Test item:	Harmonic	Power:	AC 120V/60Hz
Frequency:	2462MHz	Temp.(°C)/Hum.(%RH):	26(°C)/60%RH
Mode:	Mode 4	Date:	03/21/2017
Ant.Polar.:	Vertical		

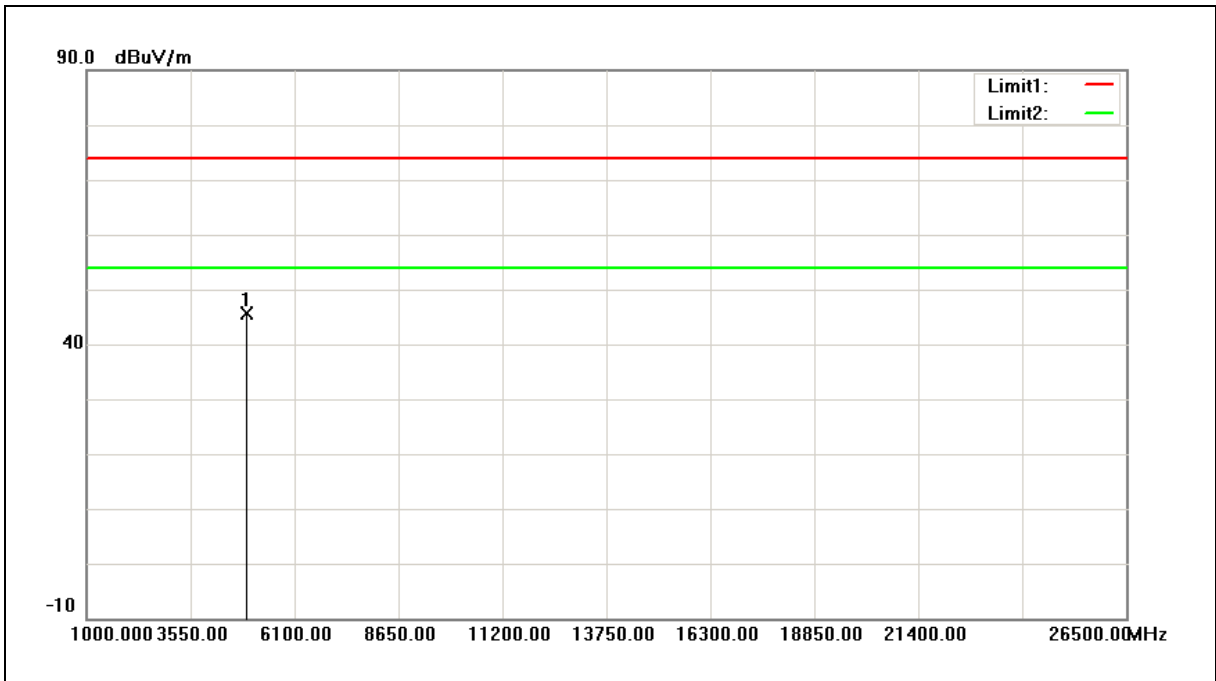

No.	Frequency (MHz)	Reading (dBuV)	Correct Factor (dB/m)	Result (dBuV/m)	Limit (dBuV/m)	Margin (dB)	Remark
1	4924.000	52.42	-6.81	45.61	74.00	-28.39	peak

Note:1.Result (dBuV/m) = Correct Factor (dB/m) + Reading(dBuV).

2.Correction factor (dB/m) = Antenna Factor (dB/m) + Cable loss (dB) – Pre-Amplifier gain (dB).

3. When the peak results are less than average limit, so not need to evaluate the average.



Standard:	FCC Part 15C	Test Distance:	3m
Test item:	Harmonic	Power:	AC 120V/60Hz
Frequency:	2422MHz	Temp.(°C)/Hum.(%RH):	26(°C)/60%RH
Mode:	Mode 5	Date:	03/21/2017
Ant.Polar.:	Horizontal		

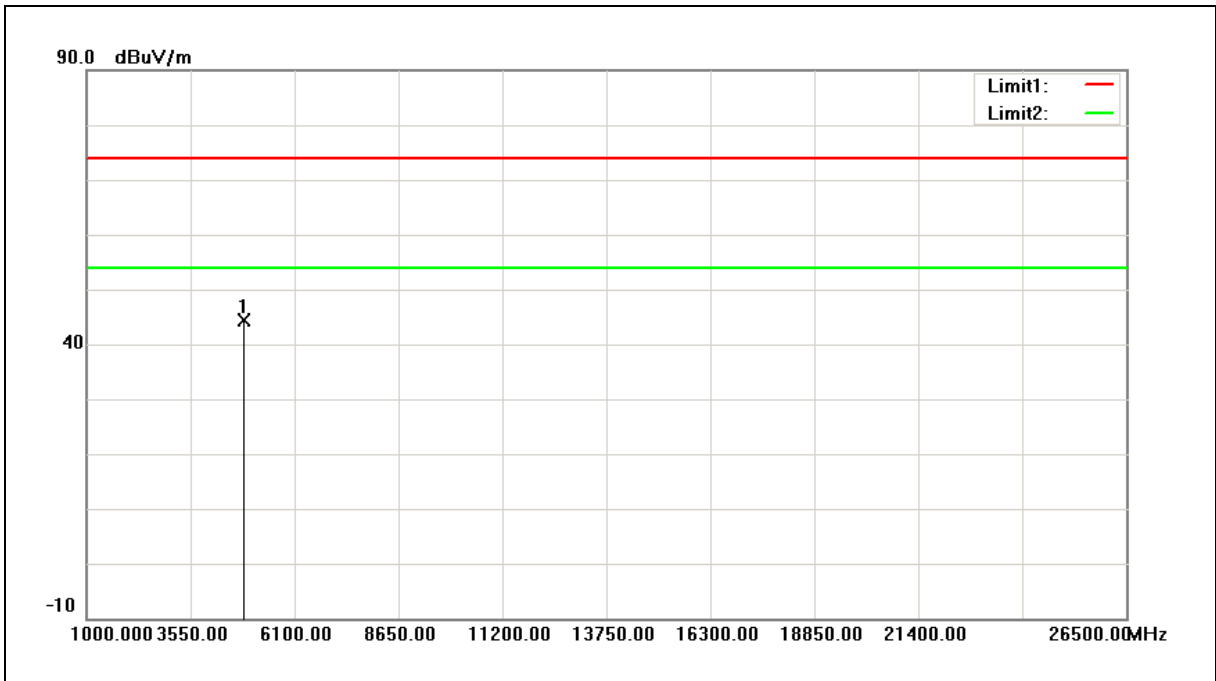

No.	Frequency (MHz)	Reading (dBuV)	Correct Factor (dB/m)	Result (dBuV/m)	Limit (dBuV/m)	Margin (dB)	Remark
1	4844.000	51.41	-7.03	44.38	74.00	-29.62	peak

Note:1.Result (dBuV/m) = Correct Factor (dB/m) + Reading(dBuV).

2.Correction factor (dB/m) = Antenna Factor (dB/m) + Cable loss (dB) – Pre-Amplifier gain (dB).

3. When the peak results are less than average limit, so not need to evaluate the average.



Standard:	FCC Part 15C	Test Distance:	3m
Test item:	Harmonic	Power:	AC 120V/60Hz
Frequency:	2422MHz	Temp.(°C)/Hum. (%RH):	26(°C)/60%RH
Mode:	Mode 5	Date:	03/21/2017
Ant.Polar.:	Vertical		

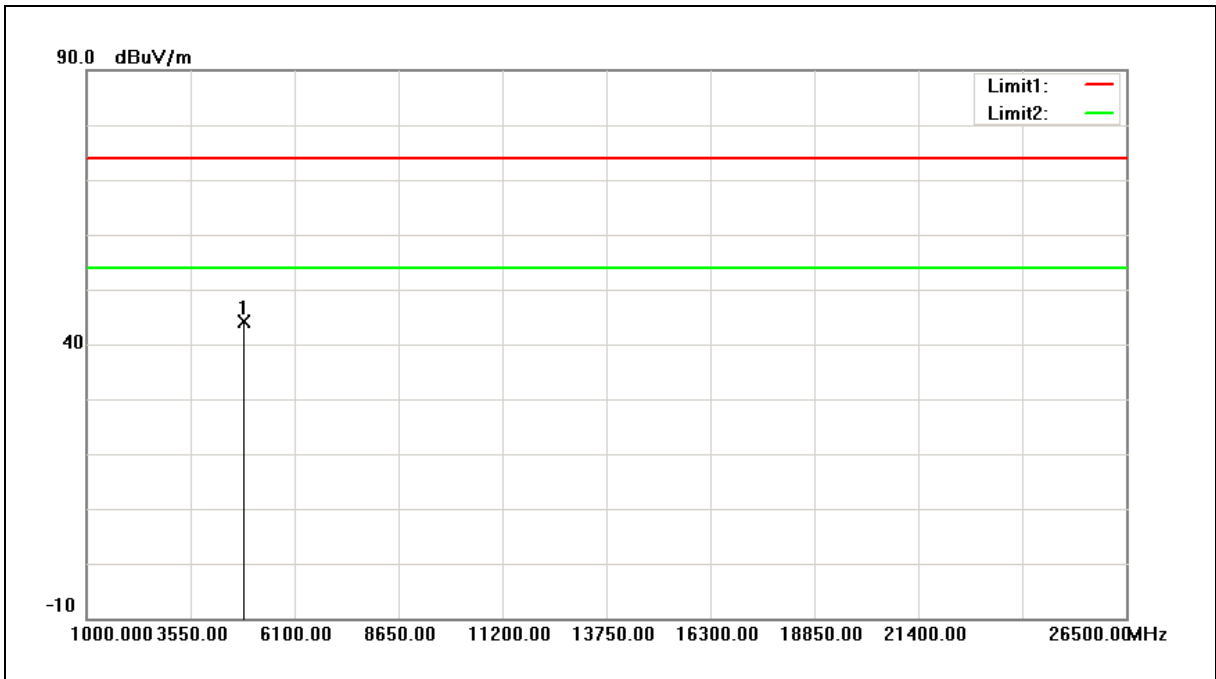

No.	Frequency (MHz)	Reading (dBuV)	Correct Factor (dB/m)	Result (dBuV/m)	Limit (dBuV/m)	Margin (dB)	Remark
1	4844.000	51.04	-7.03	44.01	74.00	-29.99	peak

Note: 1. Result (dBuV/m) = Correct Factor (dB/m) + Reading(dBuV).

2. Correction factor (dB/m) = Antenna Factor (dB/m) + Cable loss (dB) – Pre-Amplifier gain (dB).

3. When the peak results are less than average limit, so not need to evaluate the average.



Standard:	FCC Part 15C	Test Distance:	3m
Test item:	Harmonic	Power:	AC 120V/60Hz
Frequency:	2437MHz	Temp.(°C)/Hum.(%RH):	26(°C)/60%RH
Mode:	Mode 5	Date:	03/21/2017
Ant.Polar.:	Horizontal		

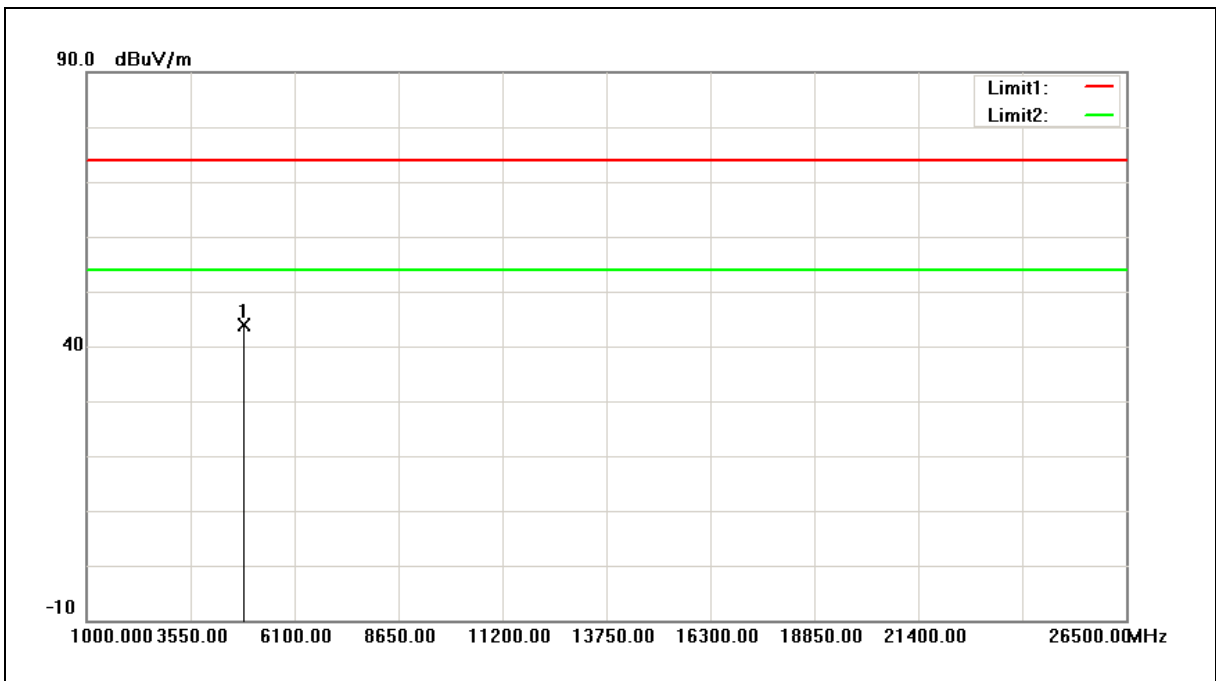

No.	Frequency (MHz)	Reading (dBuV)	Correct Factor (dB/m)	Result (dBuV/m)	Limit (dBuV/m)	Margin (dB)	Remark
1	4874.000	50.93	-6.95	43.98	74.00	-30.02	peak

Note:1.Result (dBuV/m) = Correct Factor (dB/m) + Reading(dBuV).

2.Correction factor (dB/m) = Antenna Factor (dB/m) + Cable loss (dB) – Pre-Amplifier gain (dB).

3. When the peak results are less than average limit, so not need to evaluate the average.



Standard:	FCC Part 15C	Test Distance:	3m
Test item:	Harmonic	Power:	AC 120V/60Hz
Frequency:	2437MHz	Temp.(°C)/Hum.(%RH):	26(°C)/60%RH
Mode:	Mode 5	Date:	03/21/2017
Ant.Polar.:	Vertical		

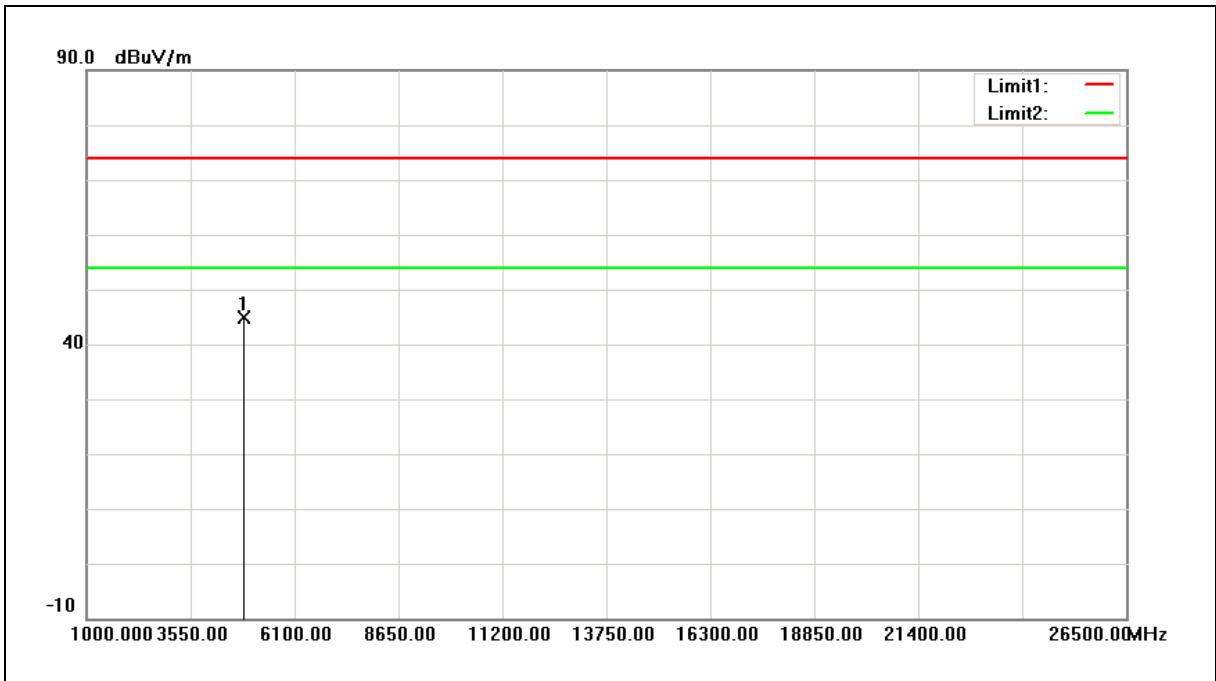

No.	Frequency (MHz)	Reading (dBuV)	Correct Factor (dB/m)	Result (dBuV/m)	Limit (dBuV/m)	Margin (dB)	Remark
1	4874.000	51.86	-6.95	44.91	74.00	-29.09	peak

Note:1.Result (dBuV/m) = Correct Factor (dB/m) + Reading(dBuV).

2.Correction factor (dB/m) = Antenna Factor (dB/m) + Cable loss (dB) – Pre-Amplifier gain (dB).

3. When the peak results are less than average limit, so not need to evaluate the average.



Standard:	FCC Part 15C	Test Distance:	3m
Test item:	Harmonic	Power:	AC 120V/60Hz
Frequency:	2452MHz	Temp.(°C)/Hum.(%RH):	26(°C)/60%RH
Mode:	Mode 5	Date:	03/21/2017
Ant.Polar.:	Horizontal		

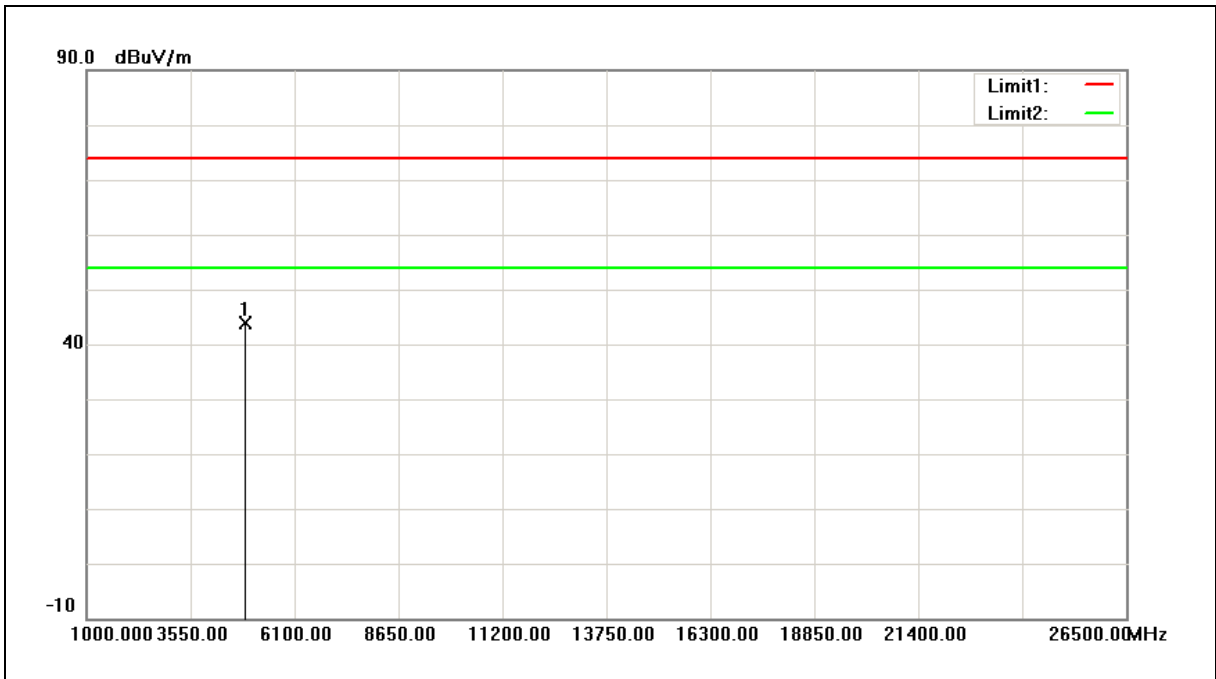

No.	Frequency (MHz)	Reading (dBuV)	Correct Factor (dB/m)	Result (dBuV/m)	Limit (dBuV/m)	Margin (dB)	Remark
1	4904.000	50.73	-6.86	43.87	74.00	-30.13	peak

Note:1.Result (dBuV/m) = Correct Factor (dB/m) + Reading(dBuV).

2.Correction factor (dB/m) = Antenna Factor (dB/m) + Cable loss (dB) – Pre-Amplifier gain (dB).

3. When the peak results are less than average limit, so not need to evaluate the average.



Standard:	FCC Part 15C	Test Distance:	3m
Test item:	Harmonic	Power:	AC 120V/60Hz
Frequency:	2452MHz	Temp.(°C)/Hum.(%RH):	26(°C)/60%RH
Mode:	Mode 5	Date:	03/21/2017
Ant.Polar.:	Vertical		

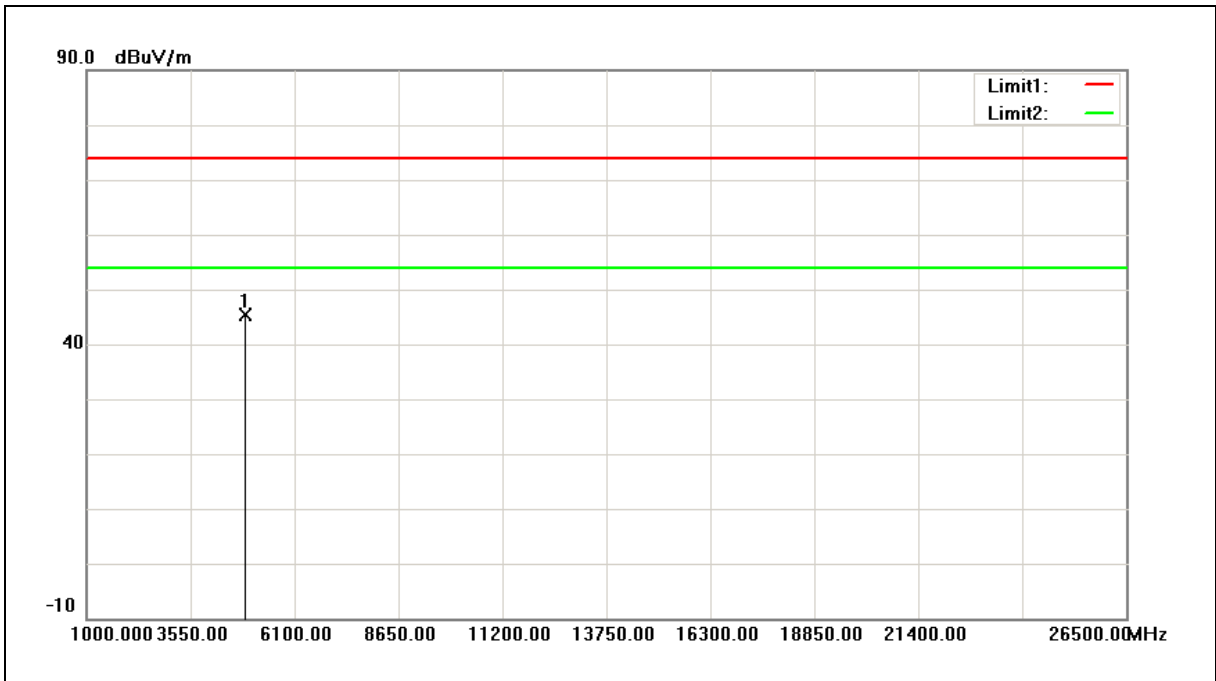

No.	Frequency (MHz)	Reading (dBuV)	Correct Factor (dB/m)	Result (dBuV/m)	Limit (dBuV/m)	Margin (dB)	Remark
1	4904.000	52.13	-6.86	45.27	74.00	-28.73	peak

Note:1.Result (dBuV/m) = Correct Factor (dB/m) + Reading(dBuV).

2.Correction factor (dB/m) = Antenna Factor (dB/m) + Cable loss (dB) – Pre-Amplifier gain (dB).

3. When the peak results are less than average limit, so not need to evaluate the average.



Band Edge

Standard:	FCC Part 15C	Test Distance:	3m
Test item:	Band edge	Power:	AC 120V/60Hz
Frequency:	2412MHz	Temp.(°C)/Hum.(%RH):	26(°C)/60%RH
Mode:	Mode 2	Date:	03/21/2017
Ant.Polar.:	Horizontal		

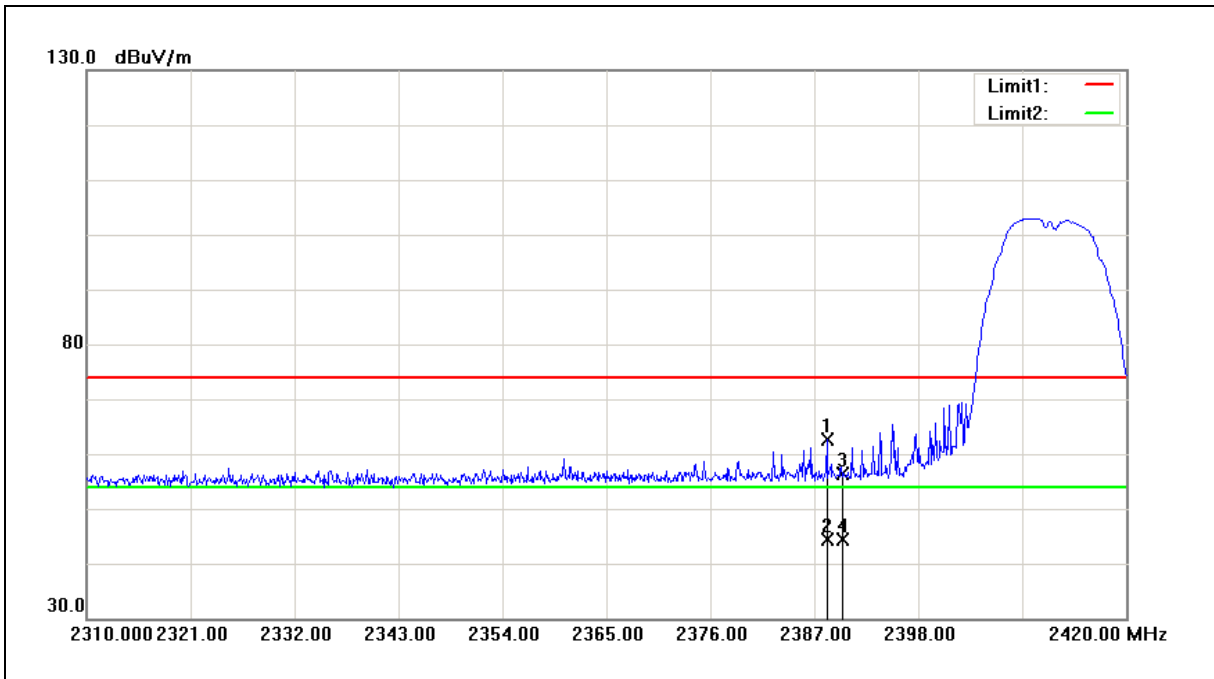

No.	Frequency (MHz)	Reading (dBuV)	Correct Factor (dB/m)	Result (dBuV/m)	Limit (dBuV/m)	Margin (dB)	Remark
1	2388.320	62.85	-0.26	62.59	74.00	-11.41	peak
2	2388.320	44.63	-0.26	44.37	54.00	-9.63	AVG
3	2390.000	56.54	-0.26	56.28	74.00	-17.72	peak
4	2390.000	44.76	-0.26	44.50	54.00	-9.50	AVG

Note:1.Result (dBuV/m) = Correct Factor (dB/m) + Reading(dBuV).

2.Correction factor (dB/m) = Antenna Factor (dB/m) + Cable loss (dB) – Pre-Amplifier gain (dB).

3. When the peak results are less than average limit, so not need to evaluate the average.



Standard:	FCC Part 15C	Test Distance:	3m
Test item:	Band edge	Power:	AC 120V/60Hz
Frequency:	2412MHz	Temp.(°C)/Hum.(%RH):	26(°C)/60%RH
Mode:	Mode 2	Date:	03/21/2017
Ant.Polar.:	Vertical		

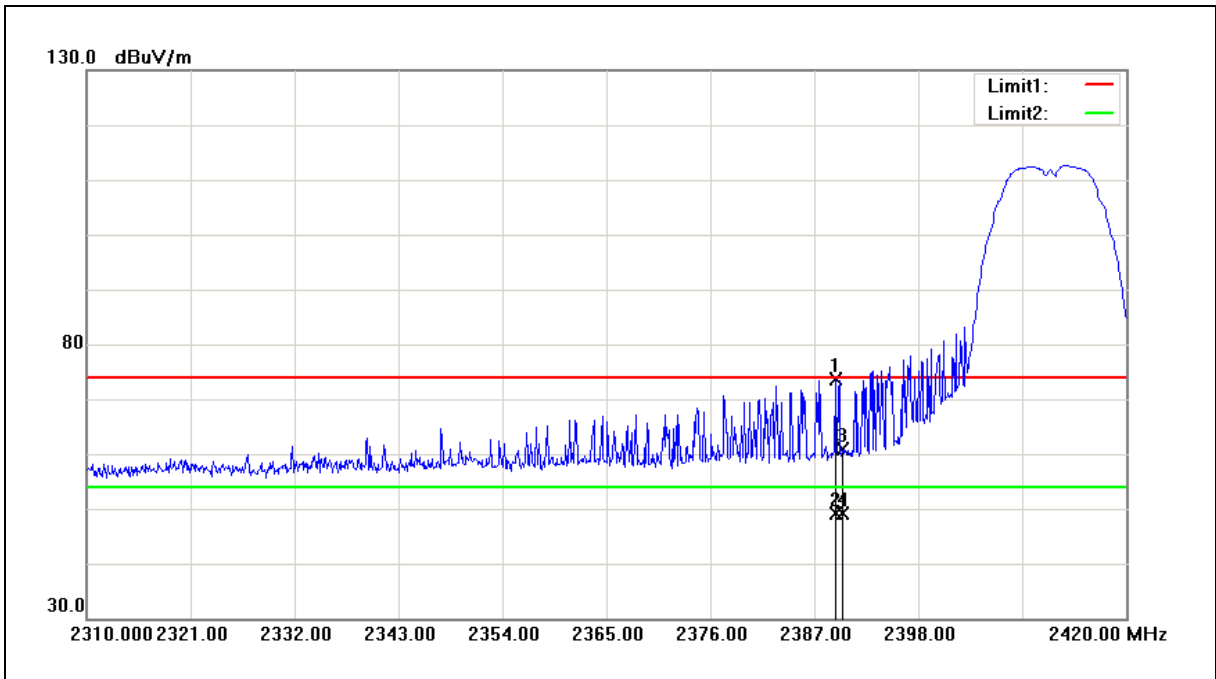

No.	Frequency (MHz)	Reading (dBuV)	Correct Factor (dB/m)	Result (dBuV/m)	Limit (dBuV/m)	Margin (dB)	Remark
1	2389.310	73.98	-0.26	73.72	74.00	-0.28	peak
2	2389.310	49.37	-0.26	49.11	54.00	-4.89	AVG
3	2390.000	61.23	-0.26	60.97	74.00	-13.03	peak
4	2390.000	49.49	-0.26	49.23	54.00	-4.77	AVG

Note: 1.Result (dBuV/m) = Correct Factor (dB/m) + Reading(dBuV).

2. Correction factor (dB/m) = Antenna Factor (dB/m) + Cable loss (dB) – Pre-Amplifier gain (dB).

3. When the peak results are less than average limit, so not need to evaluate the average.



Standard:	FCC Part 15C	Test Distance:	3m
Test item:	Band edge	Power:	AC 120V/60Hz
Frequency:	2422MHz	Temp.(°C)/Hum.(%RH):	26(°C)/60%RH
Mode:	Mode 2	Date:	03/21/2017
Ant.Polar.:	Horizontal		

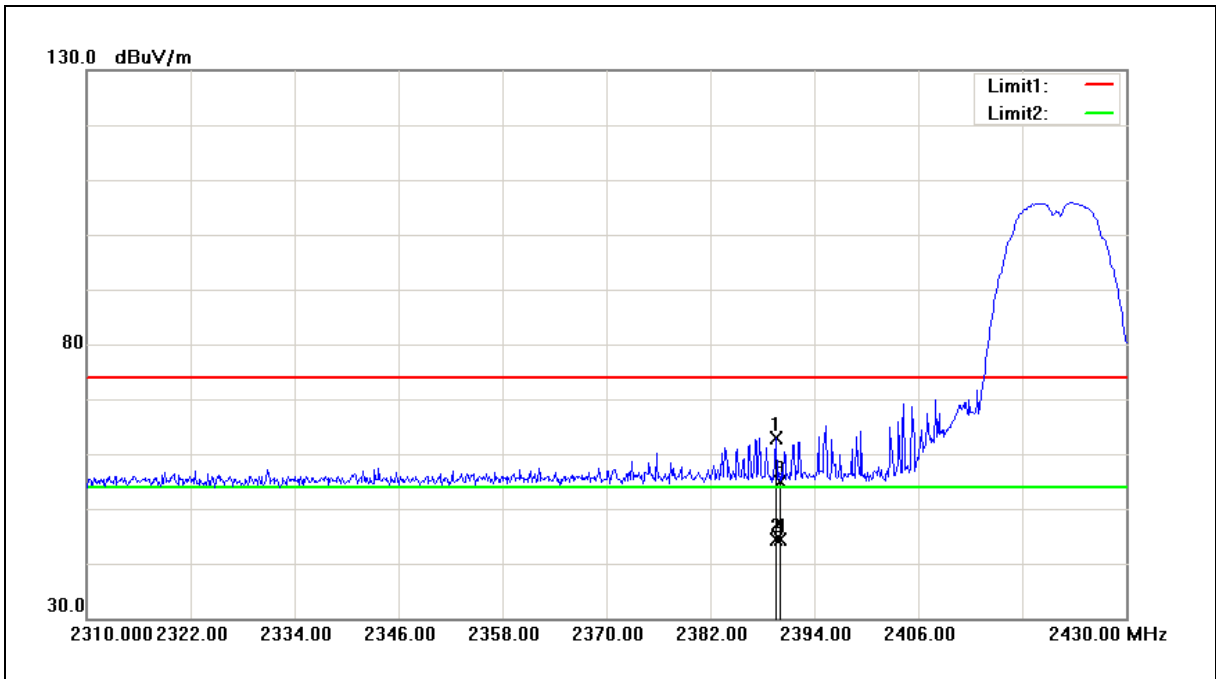

No.	Frequency (MHz)	Reading (dBuV)	Correct Factor (dB/m)	Result (dBuV/m)	Limit (dBuV/m)	Margin (dB)	Remark
1	2389.560	63.18	-0.26	62.92	74.00	-11.08	peak
2	2389.560	44.59	-0.26	44.33	54.00	-9.67	AVG
3	2390.000	55.26	-0.26	55.00	74.00	-19.00	peak
4	2390.000	44.54	-0.26	44.28	54.00	-9.72	AVG

Note:1.Result (dBuV/m) = Correct Factor (dB/m) + Reading(dBuV).

2.Correction factor (dB/m) = Antenna Factor (dB/m) + Cable loss (dB) – Pre-Amplifier gain (dB).

3. When the peak results are less than average limit, so not need to evaluate the average.



Standard:	FCC Part 15C	Test Distance:	3m
Test item:	Band edge	Power:	AC 120V/60Hz
Frequency:	2422MHz	Temp.(°C)/Hum.(%RH):	26(°C)/60%RH
Mode:	Mode 2	Date:	03/21/2017
Ant.Polar.:	Vertical		

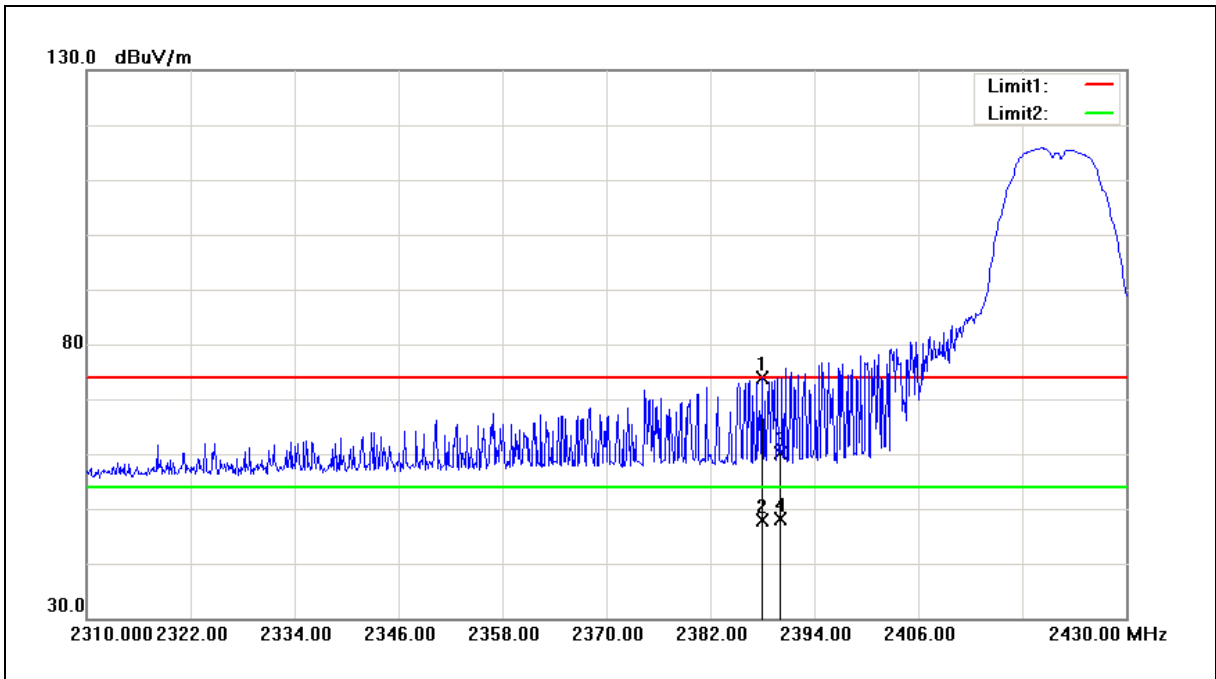

No.	Frequency (MHz)	Reading (dBuV)	Correct Factor (dB/m)	Result (dBuV/m)	Limit (dBuV/m)	Margin (dB)	Remark
1	2388.000	74.21	-0.26	73.95	74.00	-0.05	peak
2	2388.000	48.08	-0.26	47.82	54.00	-6.18	AVG
3	2390.000	60.37	-0.26	60.11	74.00	-13.89	peak
4	2390.000	48.44	-0.26	48.18	54.00	-5.82	AVG

Note: 1. Result (dBuV/m) = Correct Factor (dB/m) + Reading(dBuV).

2. Correction factor (dB/m) = Antenna Factor (dB/m) + Cable loss (dB) – Pre-Amplifier gain (dB).

3. When the peak results are less than average limit, so not need to evaluate the average.



Standard:	FCC Part 15C	Test Distance:	3m
Test item:	Band edge	Power:	AC 120V/60Hz
Frequency:	2427MHz	Temp.(°C)/Hum.(%RH):	26(°C)/60%RH
Mode:	Mode 2	Date:	05/16/2017
Ant.Polar.:	Horizontal		

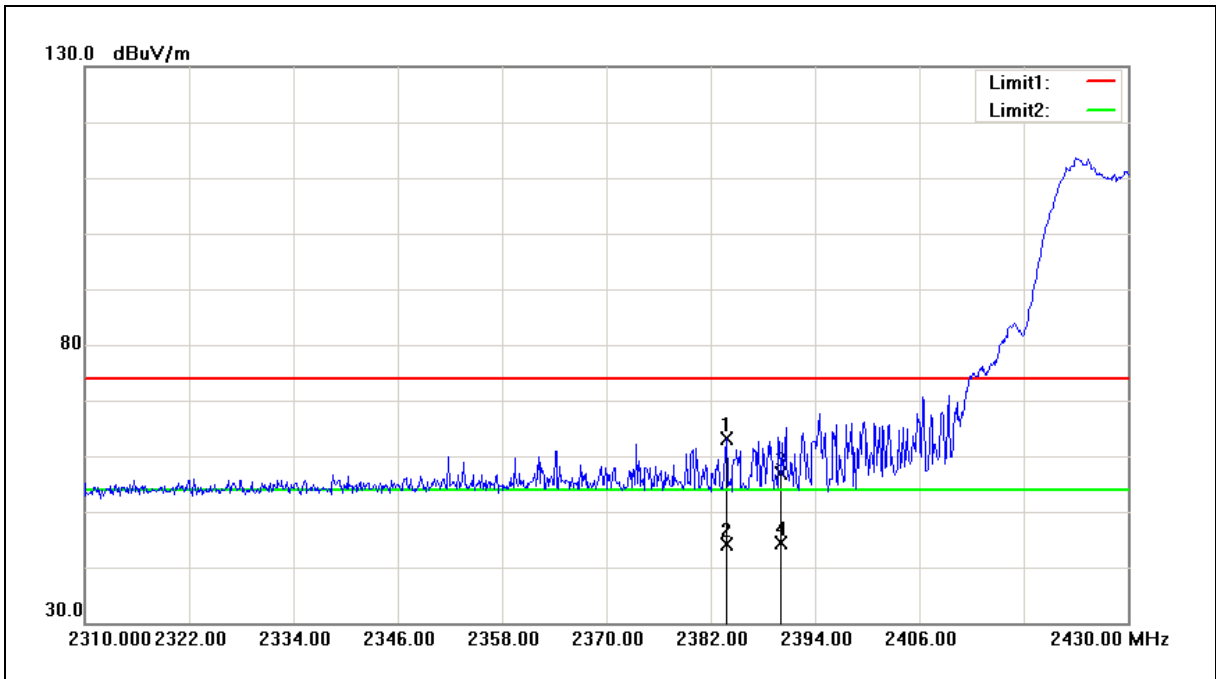

No.	Frequency (MHz)	Reading (dBuV)	Correct Factor (dB/m)	Result (dBuV/m)	Limit (dBuV/m)	Margin (dB)	Remark
1	2383.800	63.51	-0.29	63.22	74.00	-10.78	peak
2	2383.800	44.53	-0.29	44.24	54.00	-9.76	AVG
3	2390.000	57.25	-0.26	56.99	74.00	-17.01	peak
4	2390.000	44.67	-0.26	44.41	54.00	-9.59	AVG

Note:1.Result (dBuV/m) = Correct Factor (dB/m) + Reading(dBuV).

2.Correction factor (dB/m) = Antenna Factor (dB/m) + Cable loss (dB) – Pre-Amplifier gain (dB).

3. When the peak results are less than average limit, so not need to evaluate the average.



Standard:	FCC Part 15C	Test Distance:	3m
Test item:	Band edge	Power:	AC 120V/60Hz
Frequency:	2427MHz	Temp.(°C)/Hum.(%RH):	26(°C)/60%RH
Mode:	Mode 2	Date:	05/16/2017
Ant.Polar.:	Vertical		

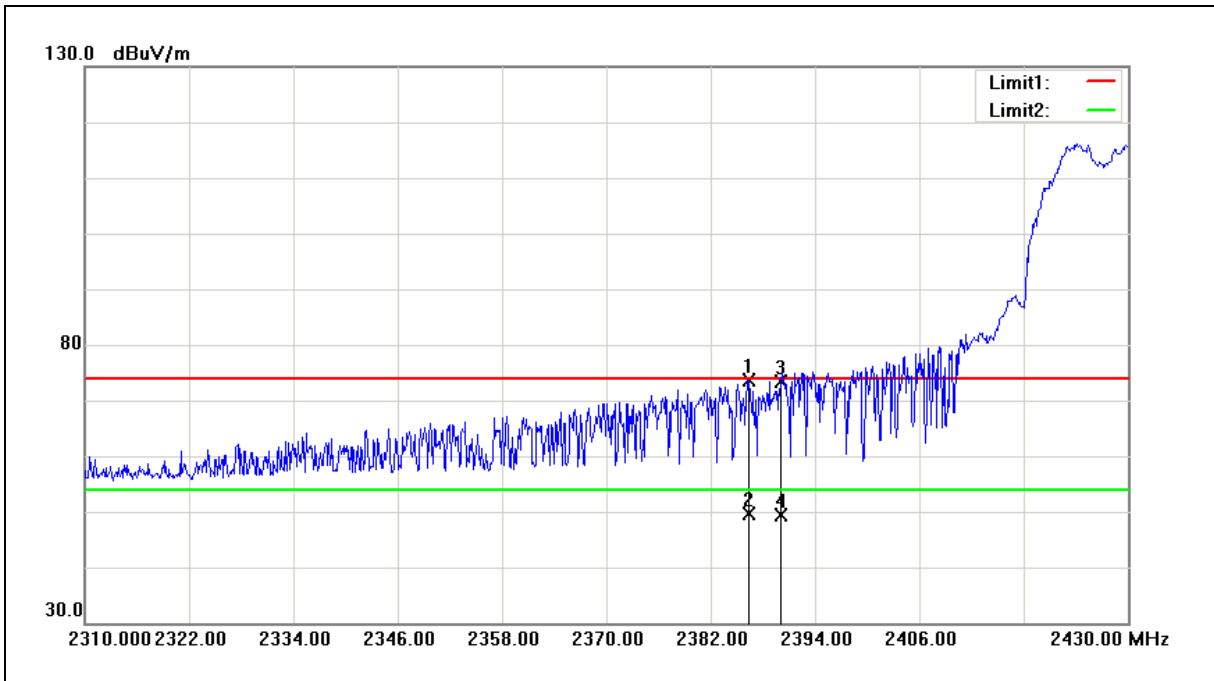

No.	Frequency (MHz)	Reading (dBuV)	Correct Factor (dB/m)	Result (dBuV/m)	Limit (dBuV/m)	Margin (dB)	Remark
1	2386.320	73.96	-0.28	73.68	74.00	-0.32	peak
2	2386.320	49.81	-0.28	49.53	54.00	-4.47	AVG
3	2390.000	73.74	-0.26	73.48	74.00	-0.52	peak
4	2390.000	49.73	-0.26	49.47	54.00	-4.53	AVG

Note:1.Result (dBuV/m) = Correct Factor (dB/m) + Reading(dBuV).

2.Correction factor (dB/m) = Antenna Factor (dB/m) + Cable loss (dB) – Pre-Amplifier gain (dB).

3. When the peak results are less than average limit, so not need to evaluate the average.



Standard:	FCC Part 15C	Test Distance:	3m
Test item:	Band edge	Power:	AC 120V/60Hz
Frequency:	2437MHz	Temp.(°C)/Hum.(%RH):	26(°C)/60%RH
Mode:	Mode 2	Date:	03/21/2017
Ant.Polar.:	Horizontal		

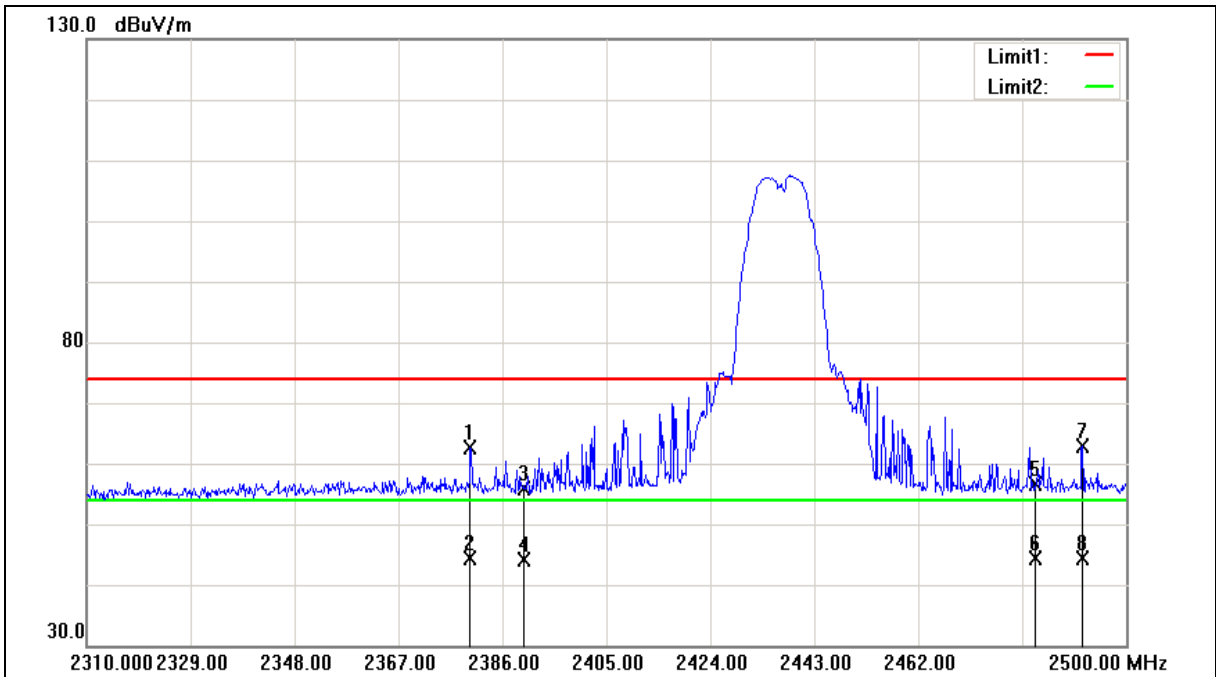

No.	Frequency (MHz)	Reading (dBuV)	Correct Factor (dB/m)	Result (dBuV/m)	Limit (dBuV/m)	Margin (dB)	Remark
1	2380.110	62.98	-0.30	62.68	74.00	-11.32	peak
2	2380.110	44.58	-0.30	44.28	54.00	-9.72	AVG
3	2390.000	56.17	-0.26	55.91	74.00	-18.09	peak
4	2390.000	44.47	-0.26	44.21	54.00	-9.79	AVG
5	2483.500	56.51	0.11	56.62	74.00	-17.38	peak
6	2483.500	44.21	0.11	44.32	54.00	-9.68	AVG
7	2492.020	62.71	0.15	62.86	74.00	-11.14	peak
8	2492.020	44.15	0.15	44.30	54.00	-9.70	AVG

Note:1. Result (dBuV/m) = Correct Factor (dB/m) + Reading(dBuV).

2. Correction factor (dB/m) = Antenna Factor (dB/m) + Cable loss (dB) - Pre-Amplifier gain (dB).

3. When the peak results are less than average limit, so not need to evaluate the average.



Standard:	FCC Part 15C	Test Distance:	3m
Test item:	Band edge	Power:	AC 120V/60Hz
Frequency:	2437MHz	Temp.(°C)/Hum.(%RH):	26(°C)/60%RH
Mode:	Mode 2	Date:	03/21/2017
Ant.Polar.:	Vertical		

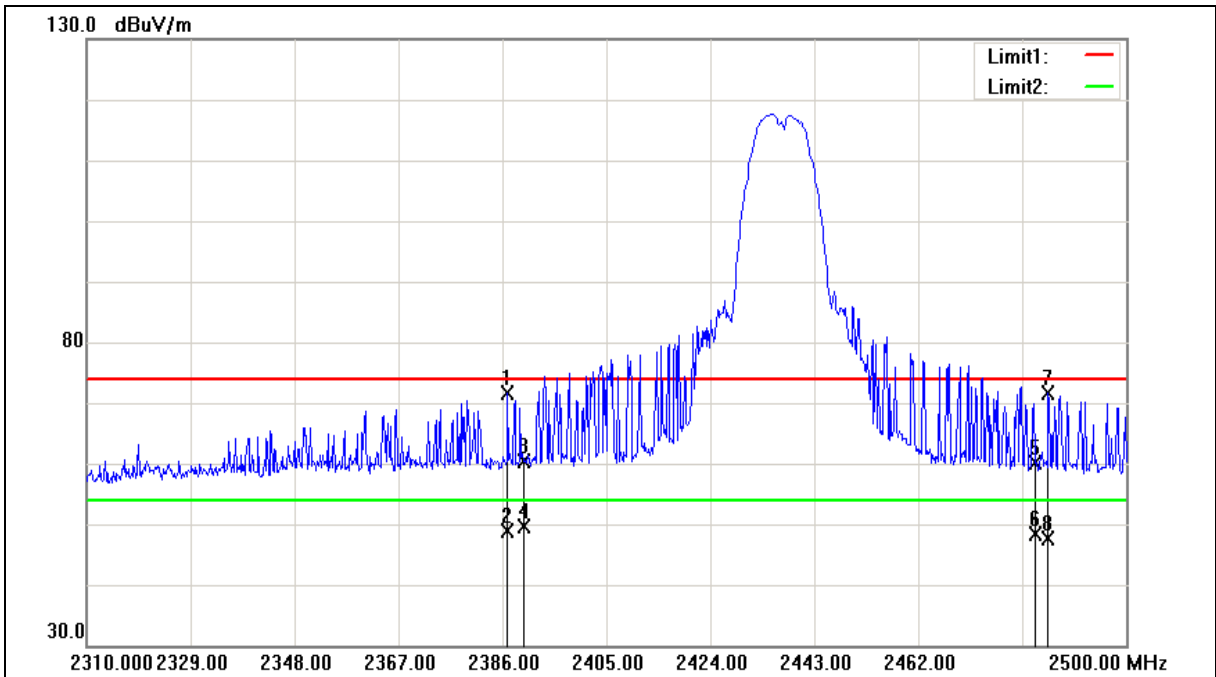

No.	Frequency (MHz)	Reading (dBuV)	Correct Factor (dB/m)	Result (dBuV/m)	Limit (dBuV/m)	Margin (dB)	Remark
1	2386.950	71.79	-0.27	71.52	74.00	-2.48	peak
2	2386.950	49.04	-0.27	48.77	54.00	-5.23	AVG
3	2390.000	60.67	-0.26	60.41	74.00	-13.59	peak
4	2390.000	49.90	-0.26	49.64	54.00	-4.36	AVG
5	2483.500	60.01	0.11	60.12	74.00	-13.88	peak
6	2483.500	48.31	0.11	48.42	54.00	-5.58	AVG
7	2485.750	71.62	0.12	71.74	74.00	-2.26	peak
8	2485.750	47.50	0.12	47.62	54.00	-6.38	AVG

Note:1. Result (dBuV/m) = Correct Factor (dB/m) + Reading(dBuV).

2. Correction factor (dB/m) = Antenna Factor (dB/m) + Cable loss (dB) - Pre-Amplifier gain (dB).

3. When the peak results are less than average limit, so not need to evaluate the average.



Standard:	FCC Part 15C	Test Distance:	3m
Test item:	Band edge	Power:	AC 120V/60Hz
Frequency:	2452MHz	Temp.(°C)/Hum.(%RH):	26(°C)/60%RH
Mode:	Mode 2	Date:	03/21/2017
Ant.Polar.:	Horizontal		

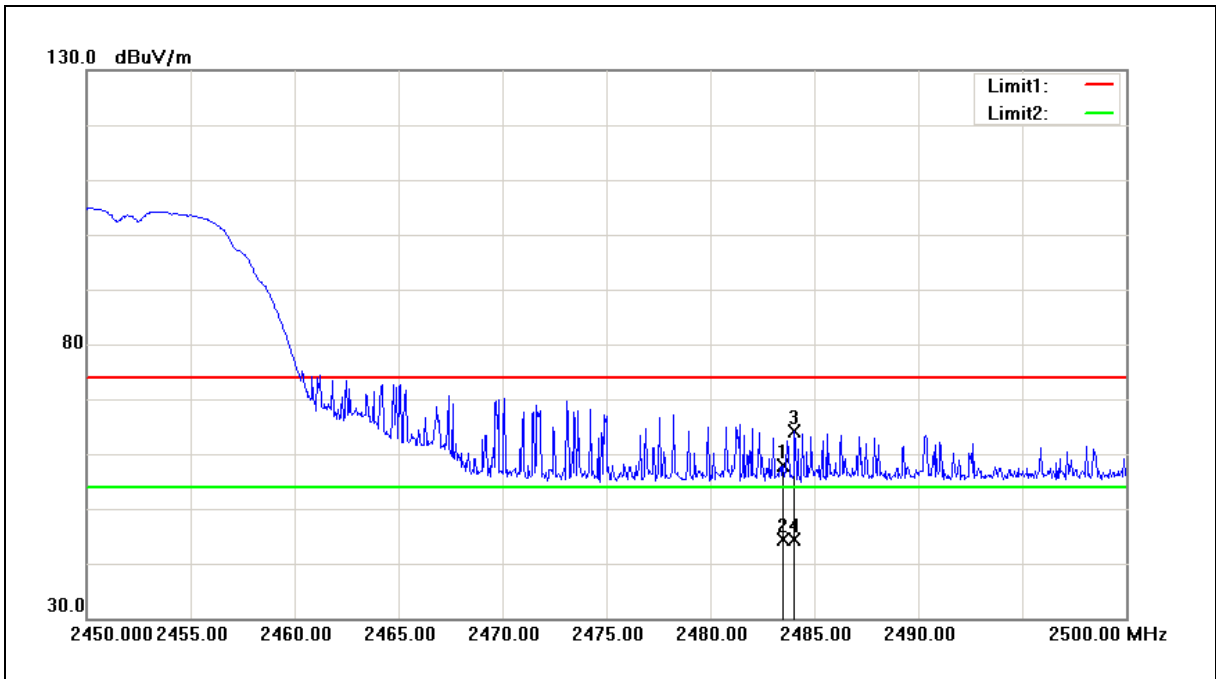

No.	Frequency (MHz)	Reading (dBuV)	Correct Factor (dB/m)	Result (dBuV/m)	Limit (dBuV/m)	Margin (dB)	Remark
1	2483.500	57.87	0.11	57.98	74.00	-16.02	peak
2	2483.500	44.17	0.11	44.28	54.00	-9.72	AVG
3	2484.050	63.90	0.12	64.02	74.00	-9.98	peak
4	2484.050	44.24	0.12	44.36	54.00	-9.64	AVG

Note:1.Result (dBuV/m) = Correct Factor (dB/m) + Reading(dBuV).

2.Correction factor (dB/m) = Antenna Factor (dB/m) + Cable loss (dB) – Pre-Amplifier gain (dB).

3. When the peak results are less than average limit, so not need to evaluate the average.



Standard:	FCC Part 15C	Test Distance:	3m
Test item:	Band edge	Power:	AC 120V/60Hz
Frequency:	2452MHz	Temp.(°C)/Hum.(%RH):	26(°C)/60%RH
Mode:	Mode 2	Date:	03/21/2017
Ant.Polar.:	Vertical		

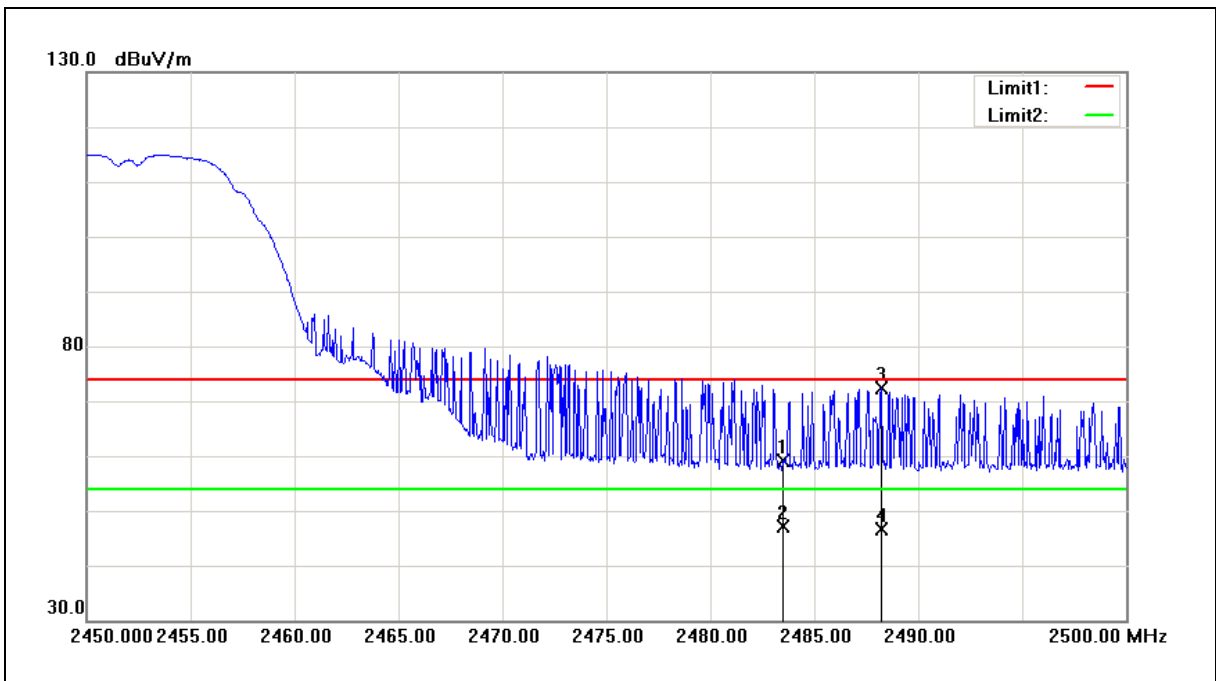

No.	Frequency (MHz)	Reading (dBuV)	Correct Factor (dB/m)	Result (dBuV/m)	Limit (dBuV/m)	Margin (dB)	Remark
1	2483.500	59.04	0.11	59.15	74.00	-14.85	peak
2	2483.500	47.12	0.11	47.23	54.00	-6.77	AVG
3	2488.250	72.36	0.13	72.49	74.00	-1.51	peak
4	2488.250	46.42	0.13	46.55	54.00	-7.45	AVG

Note:1.Result (dBuV/m) = Correct Factor (dB/m) + Reading(dBuV).

2.Correction factor (dB/m) = Antenna Factor (dB/m) + Cable loss (dB) – Pre-Amplifier gain (dB).

3. When the peak results are less than average limit, so not need to evaluate the average.



Standard:	FCC Part 15C	Test Distance:	3m
Test item:	Band edge	Power:	AC 120V/60Hz
Frequency:	2462MHz	Temp.(°C)/Hum.(%RH):	26(°C)/60%RH
Mode:	Mode 2	Date:	03/21/2017
Ant.Polar.:	Horizontal		

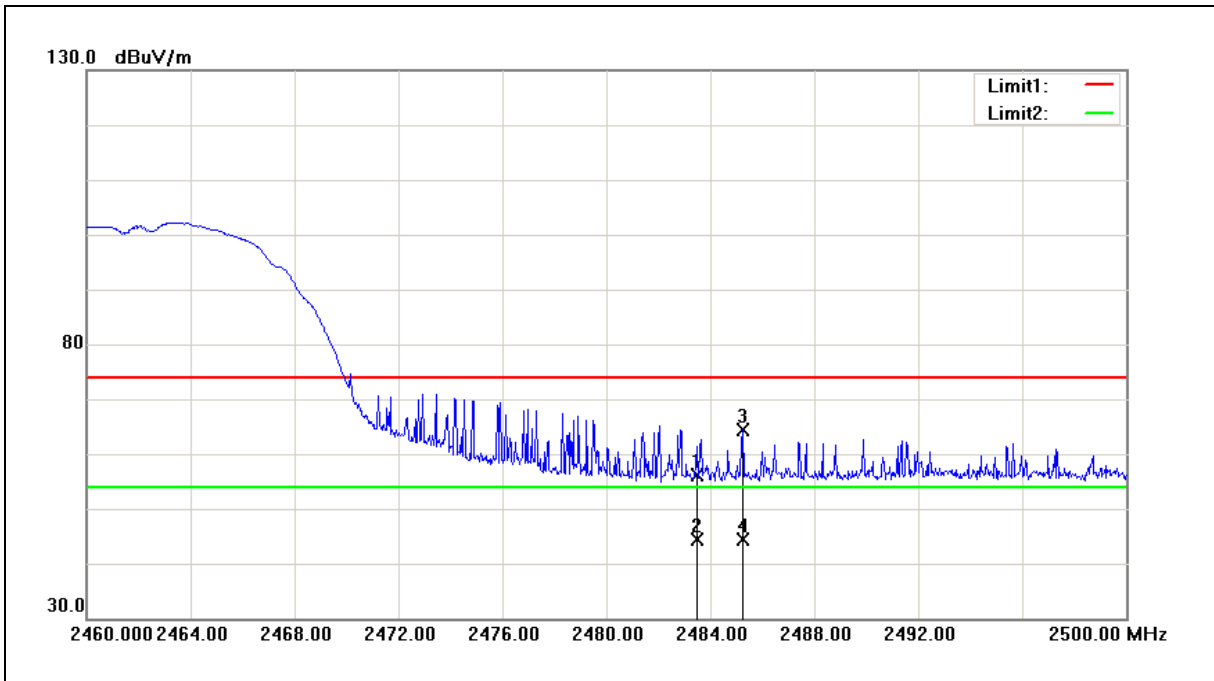

No.	Frequency (MHz)	Reading (dBuV)	Correct Factor (dB/m)	Result (dBuV/m)	Limit (dBuV/m)	Margin (dB)	Remark
1	2483.500	55.92	0.11	56.03	74.00	-17.97	peak
2	2483.500	44.35	0.11	44.46	54.00	-9.54	AVG
3	2485.240	64.19	0.12	64.31	74.00	-9.69	peak
4	2485.240	44.14	0.12	44.26	54.00	-9.74	AVG

Note:1.Result (dBuV/m) = Correct Factor (dB/m) + Reading(dBuV).

2.Correction factor (dB/m) = Antenna Factor (dB/m) + Cable loss (dB) – Pre-Amplifier gain (dB).

3. When the peak results are less than average limit, so not need to evaluate the average.



Standard:	FCC Part 15C	Test Distance:	3m
Test item:	Band edge	Power:	AC 120V/60Hz
Frequency:	2462MHz	Temp.(°C)/Hum.(%RH):	26(°C)/60%RH
Mode:	Mode 2	Date:	03/21/2017
Ant.Polar.:	Vertical		

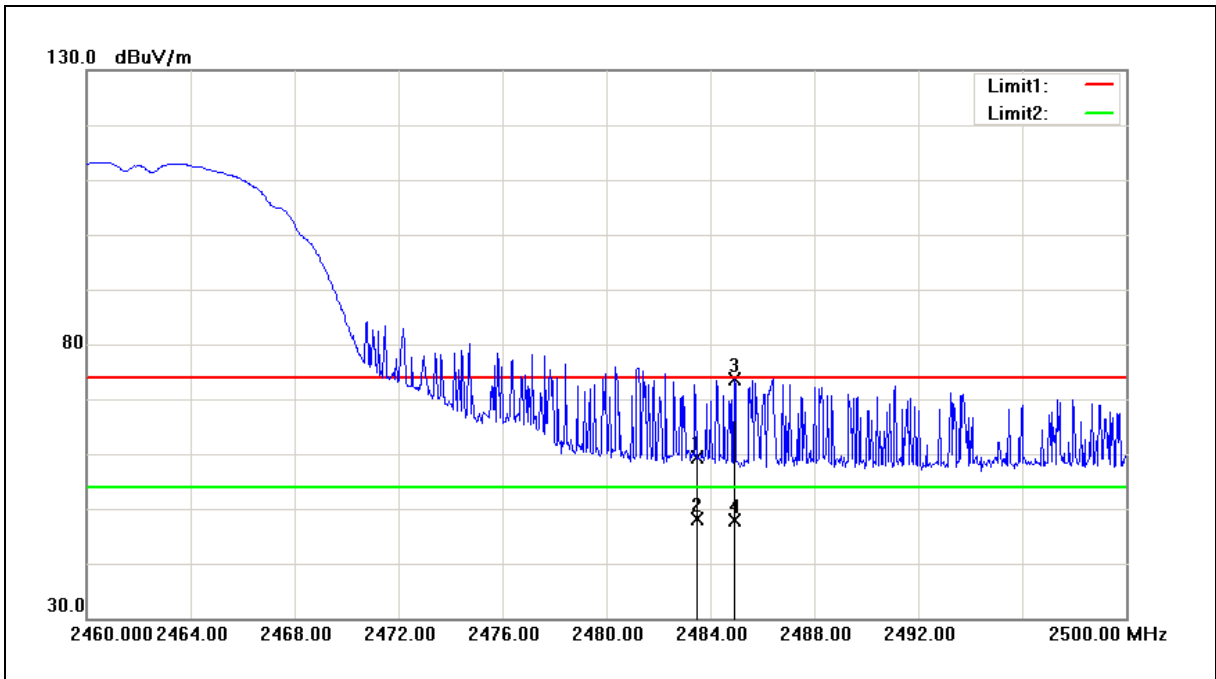

No.	Frequency (MHz)	Reading (dBuV)	Correct Factor (dB/m)	Result (dBuV/m)	Limit (dBuV/m)	Margin (dB)	Remark
1	2483.500	59.27	0.11	59.38	74.00	-14.62	peak
2	2483.500	48.14	0.11	48.25	54.00	-5.75	AVG
3	2484.920	73.59	0.12	73.71	74.00	-0.29	peak
4	2484.920	47.84	0.12	47.96	54.00	-6.04	AVG

Note:1.Result (dBuV/m) = Correct Factor (dB/m) + Reading(dBuV).

2.Correction factor (dB/m) = Antenna Factor (dB/m) + Cable loss (dB) – Pre-Amplifier gain (dB).

3. When the peak results are less than average limit, so not need to evaluate the average.



Standard:	FCC Part 15C	Test Distance:	3m
Test item:	Band edge	Power:	AC 120V/60Hz
Frequency:	2412MHz	Temp.(°C)/Hum.(%RH):	26(°C)/60%RH
Mode:	Mode 3	Date:	03/21/2017
Ant.Polar.:	Horizontal		

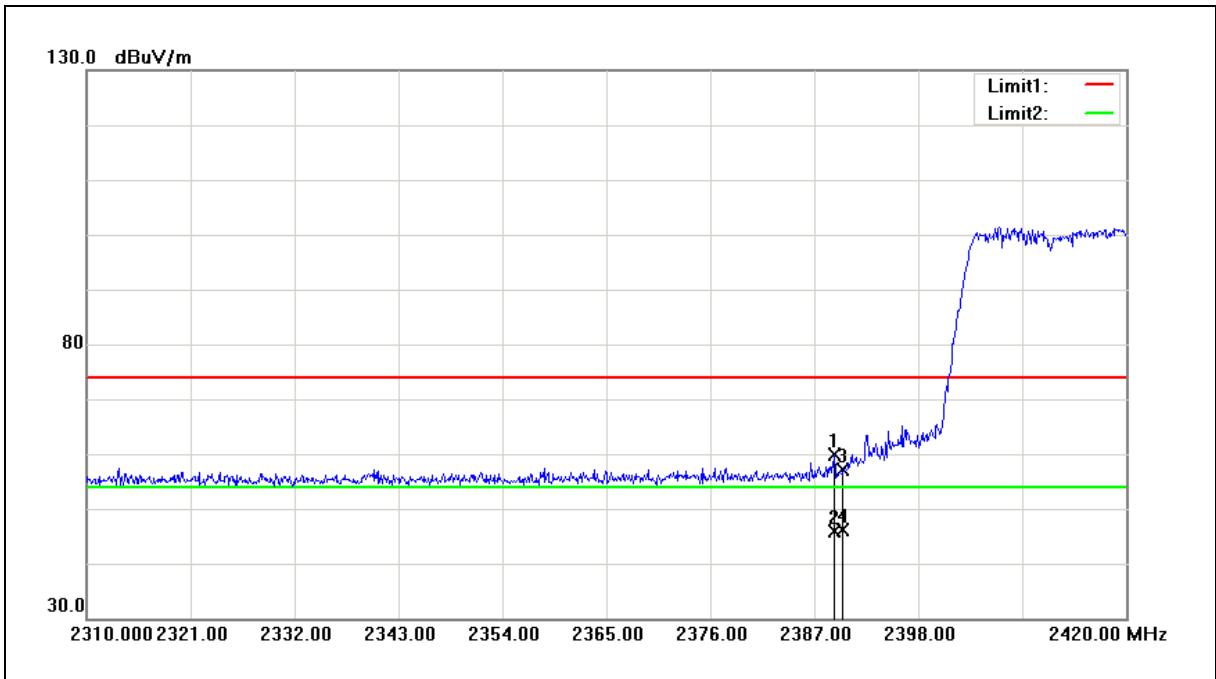

No.	Frequency (MHz)	Reading (dBuV)	Correct Factor (dB/m)	Result (dBuV/m)	Limit (dBuV/m)	Margin (dB)	Remark
1	2389.090	60.16	-0.26	59.90	74.00	-14.10	peak
2	2389.090	46.18	-0.26	45.92	54.00	-8.08	AVG
3	2390.000	57.48	-0.26	57.22	74.00	-16.78	peak
4	2390.000	46.27	-0.26	46.01	54.00	-7.99	AVG

Note:1.Result (dBuV/m) = Correct Factor (dB/m) + Reading(dBuV).

2.Correction factor (dB/m) = Antenna Factor (dB/m) + Cable loss (dB) – Pre-Amplifier gain (dB).

3. When the peak results are less than average limit, so not need to evaluate the average.



Standard:	FCC Part 15C	Test Distance:	3m
Test item:	Band edge	Power:	AC 120V/60Hz
Frequency:	2412MHz	Temp.(°C)/Hum.(%RH):	26(°C)/60%RH
Mode:	Mode 3	Date:	03/21/2017
Ant.Polar.:	Vertical		

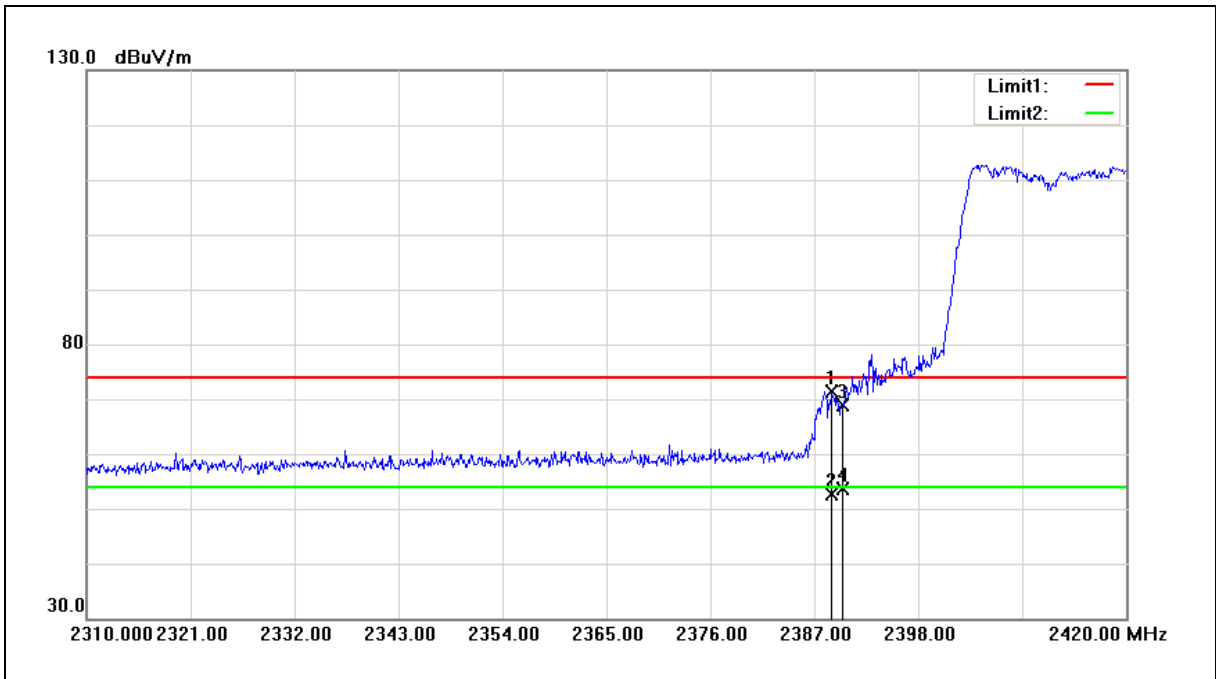

No.	Frequency (MHz)	Reading (dBuV)	Correct Factor (dB/m)	Result (dBuV/m)	Limit (dBuV/m)	Margin (dB)	Remark
1	2388.870	71.72	-0.26	71.46	74.00	-2.54	peak
2	2388.870	52.82	-0.26	52.56	54.00	-1.44	AVG
3	2390.000	69.17	-0.26	68.91	74.00	-5.09	peak
4	2390.000	53.93	-0.26	53.67	54.00	-0.33	AVG

Note: 1. Result (dBuV/m) = Correct Factor (dB/m) + Reading(dBuV).

2. Correction factor (dB/m) = Antenna Factor (dB/m) + Cable loss (dB) – Pre-Amplifier gain (dB).

3. When the peak results are less than average limit, so not need to evaluate the average.



Standard:	FCC Part 15C	Test Distance:	3m
Test item:	Band edge	Power:	AC 120V/60Hz
Frequency:	2422MHz	Temp.(°C)/Hum.(%RH):	26(°C)/60%RH
Mode:	Mode 3	Date:	03/21/2017
Ant.Polar.:	Horizontal		

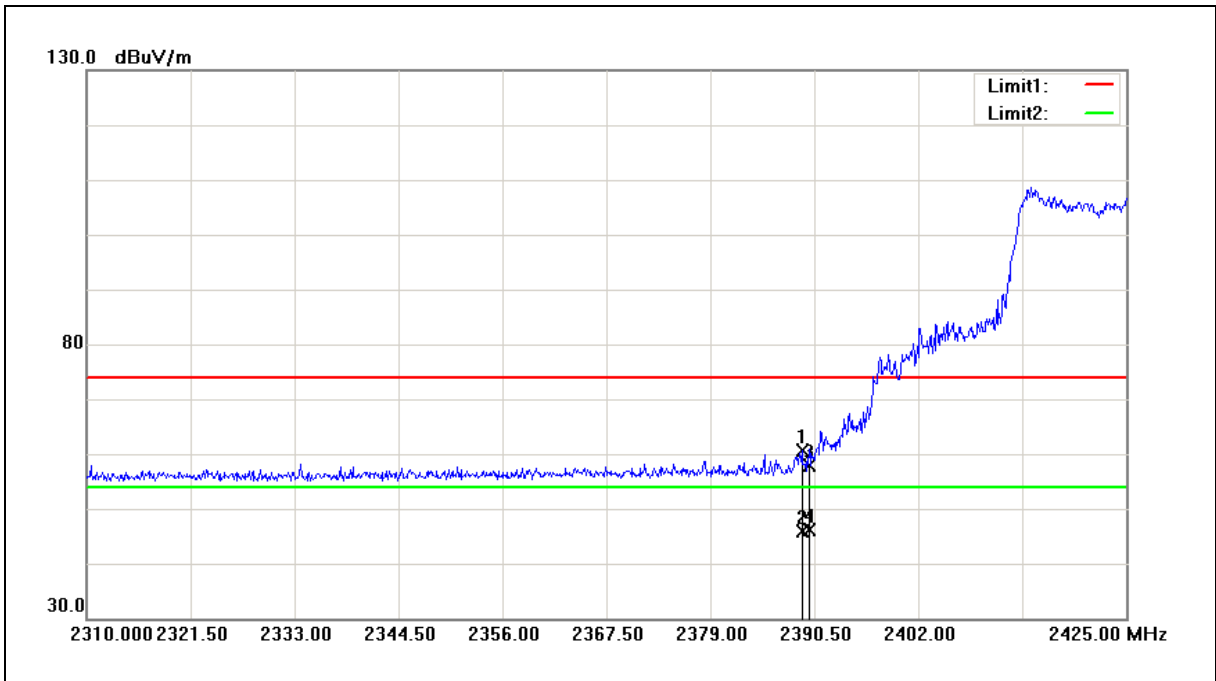

No.	Frequency (MHz)	Reading (dBuV)	Correct Factor (dB/m)	Result (dBuV/m)	Limit (dBuV/m)	Margin (dB)	Remark
1	2389.120	60.82	-0.26	60.56	74.00	-13.44	peak
2	2389.120	46.10	-0.26	45.84	54.00	-8.16	AVG
3	2390.000	58.05	-0.26	57.79	74.00	-16.21	peak
4	2390.000	46.37	-0.26	46.11	54.00	-7.89	AVG

Note:1.Result (dBuV/m) = Correct Factor (dB/m) + Reading(dBuV).

2.Correction factor (dB/m) = Antenna Factor (dB/m) + Cable loss (dB) – Pre-Amplifier gain (dB).

3. When the peak results are less than average limit, so not need to evaluate the average.



Standard:	FCC Part 15C	Test Distance:	3m
Test item:	Band edge	Power:	AC 120V/60Hz
Frequency:	2422MHz	Temp.(°C)/Hum.(%RH):	26(°C)/60%RH
Mode:	Mode 3	Date:	03/21/2017
Ant.Polar.:	Vertical		

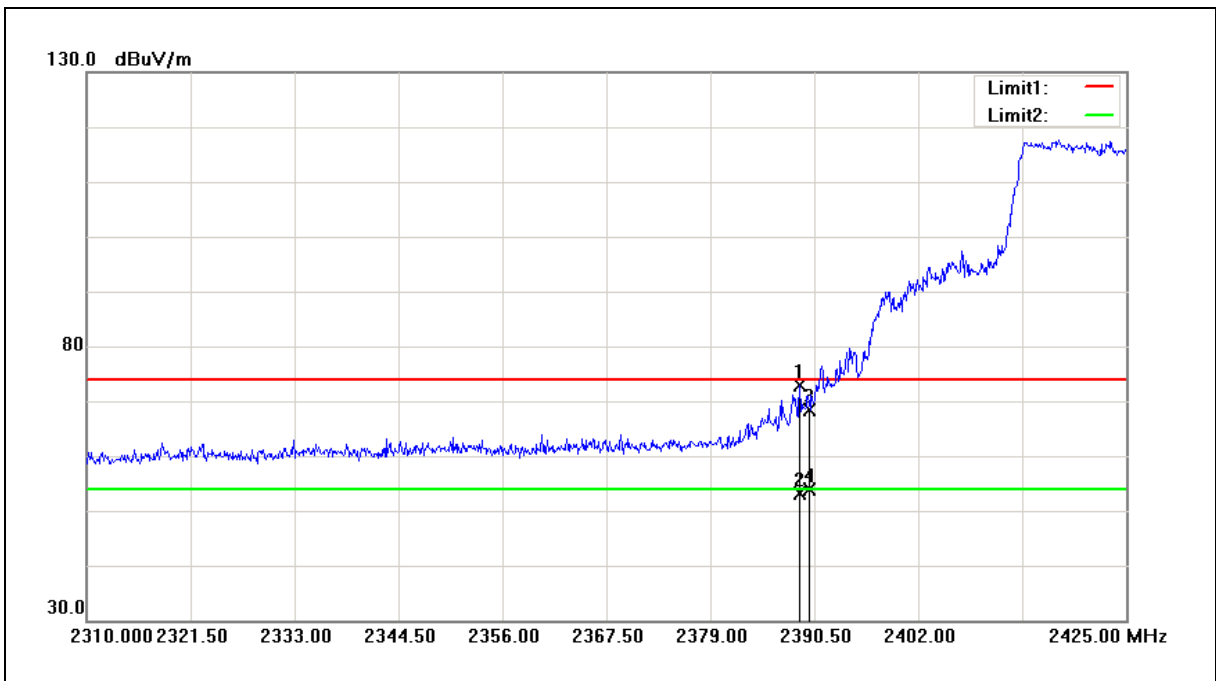

No.	Frequency (MHz)	Reading (dBuV)	Correct Factor (dB/m)	Result (dBuV/m)	Limit (dBuV/m)	Margin (dB)	Remark
1	2388.890	73.04	-0.26	72.78	74.00	-1.22	peak
2	2388.890	53.31	-0.26	53.05	54.00	-0.95	AVG
3	2390.000	68.60	-0.26	68.34	74.00	-5.66	peak
4	2390.000	54.04	-0.26	53.78	54.00	-0.22	AVG

Note: 1.Result (dBuV/m) = Correct Factor (dB/m) + Reading(dBuV).

2. Correction factor (dB/m) = Antenna Factor (dB/m) + Cable loss (dB) – Pre-Amplifier gain (dB).

3. When the peak results are less than average limit, so not need to evaluate the average.



Standard:	FCC Part 15C	Test Distance:	3m
Test item:	Band edge	Power:	AC 120V/60Hz
Frequency:	2437MHz	Temp.(°C)/Hum.(%RH):	26(°C)/60%RH
Mode:	Mode 3	Date:	03/21/2017
Ant.Polar.:	Horizontal		

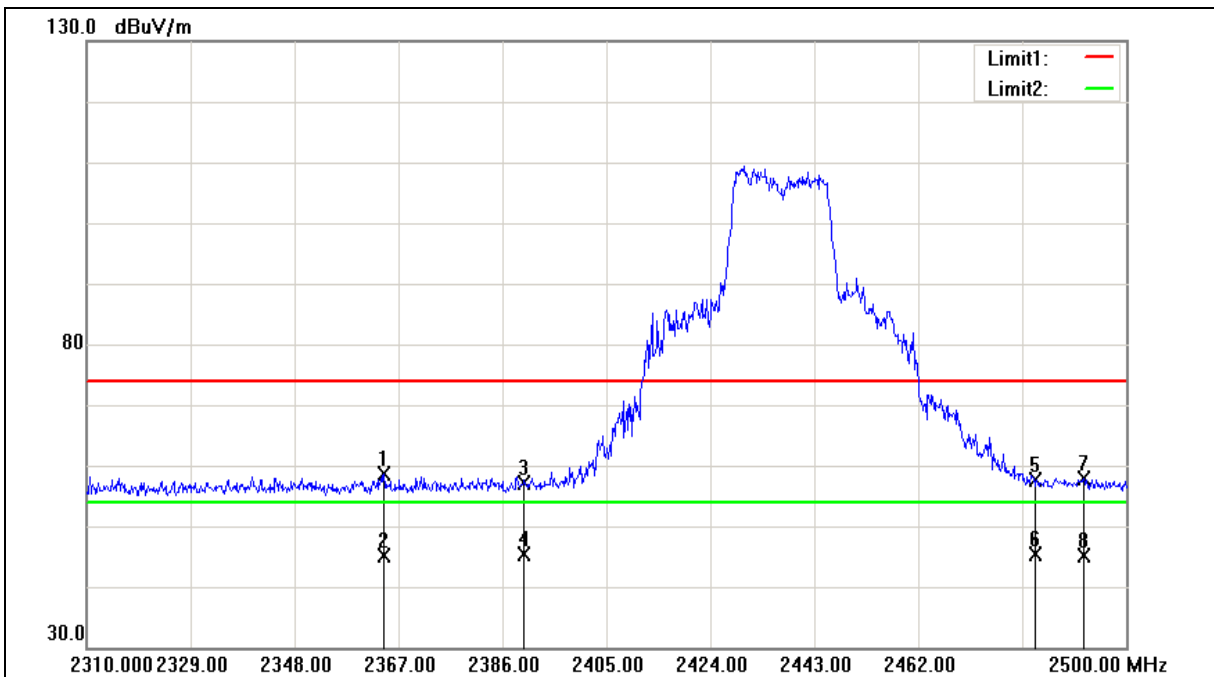

No.	Frequency (MHz)	Reading (dBuV)	Correct Factor (dB/m)	Result (dBuV/m)	Limit (dBuV/m)	Margin (dB)	Remark
1	2364.340	58.89	-0.36	58.53	74.00	-15.47	peak
2	2364.340	45.53	-0.36	45.17	54.00	-8.83	AVG
3	2390.000	57.46	-0.26	57.20	74.00	-16.80	peak
4	2390.000	45.58	-0.26	45.32	54.00	-8.68	AVG
5	2483.500	57.49	0.11	57.60	74.00	-16.40	peak
6	2483.500	45.36	0.11	45.47	54.00	-8.53	AVG
7	2492.210	57.79	0.15	57.94	74.00	-16.06	peak
8	2492.210	45.08	0.15	45.23	54.00	-8.77	AVG

Note:1. Result (dBuV/m) = Correct Factor (dB/m) + Reading(dBuV).

2. Correction factor (dB/m) = Antenna Factor (dB/m) + Cable loss (dB) - Pre-Amplifier gain (dB).

3. When the peak results are less than average limit, so not need to evaluate the average.



Standard:	FCC Part 15C	Test Distance:	3m
Test item:	Band edge	Power:	AC 120V/60Hz
Frequency:	2437MHz	Temp.(°C)/Hum.(%RH):	26(°C)/60%RH
Mode:	Mode 3	Date:	03/21/2017
Ant.Polar.:	Vertical		

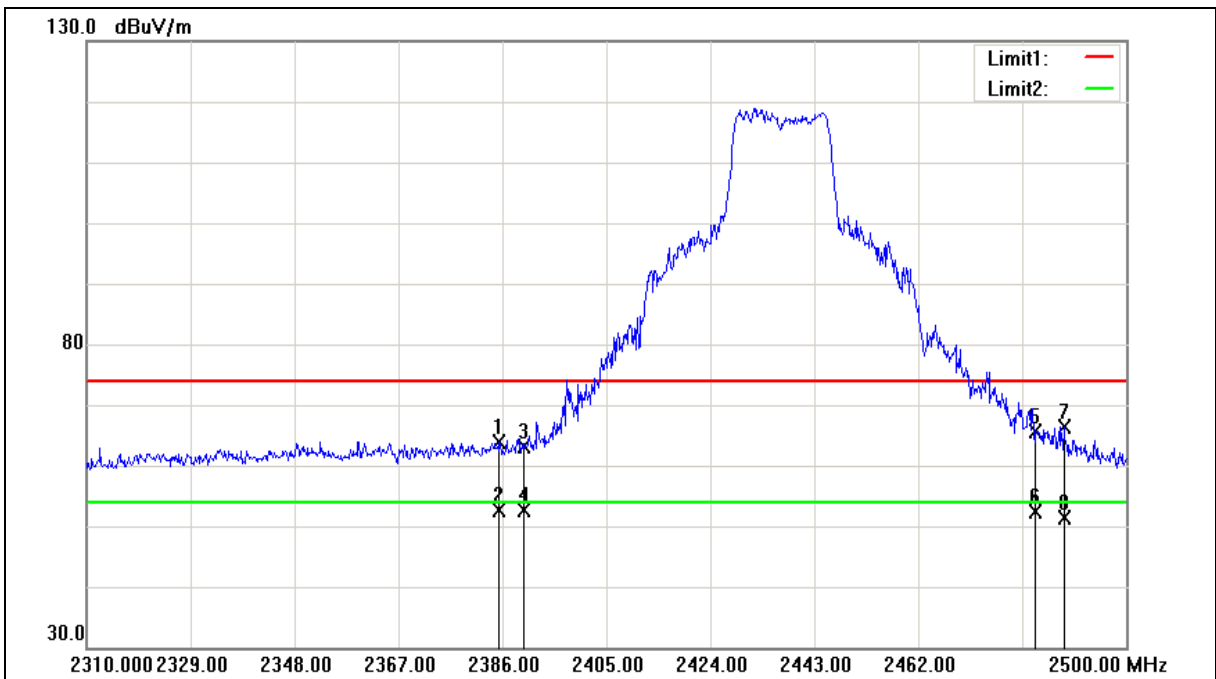

No.	Frequency (MHz)	Reading (dBuV)	Correct Factor (dB/m)	Result (dBuV/m)	Limit (dBuV/m)	Margin (dB)	Remark
1	2385.430	64.15	-0.28	63.87	74.00	-10.13	peak
2	2385.430	52.79	-0.28	52.51	54.00	-1.49	AVG
3	2390.000	63.37	-0.26	63.11	74.00	-10.89	peak
4	2390.000	52.91	-0.26	52.65	54.00	-1.35	AVG
5	2483.500	65.58	0.11	65.69	74.00	-8.31	peak
6	2483.500	52.37	0.11	52.48	54.00	-1.52	AVG
7	2488.600	66.24	0.14	66.38	74.00	-7.62	peak
8	2488.600	51.35	0.14	51.49	54.00	-2.51	AVG

Note:1. Result (dBuV/m) = Correct Factor (dB/m) + Reading(dBuV).

2. Correction factor (dB/m) = Antenna Factor (dB/m) + Cable loss (dB) - Pre-Amplifier gain (dB).

3. When the peak results are less than average limit, so not need to evaluate the average.



Standard:	FCC Part 15C	Test Distance:	3m
Test item:	Band edge	Power:	AC 120V/60Hz
Frequency:	2452MHz	Temp.(°C)/Hum.(%RH):	26(°C)/60%RH
Mode:	Mode 3	Date:	03/21/2017
Ant.Polar.:	Horizontal		

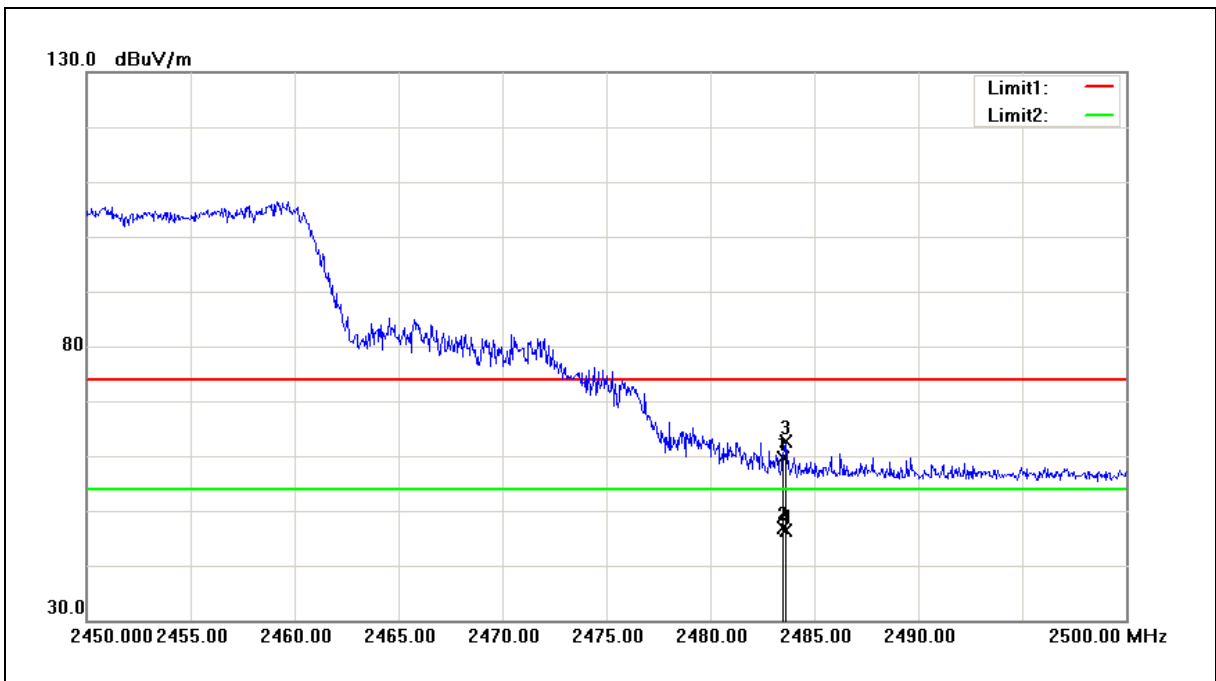

No.	Frequency (MHz)	Reading (dBuV)	Correct Factor (dB/m)	Result (dBuV/m)	Limit (dBuV/m)	Margin (dB)	Remark
1	2483.500	59.62	0.11	59.73	74.00	-14.27	peak
2	2483.500	46.74	0.11	46.85	54.00	-7.15	AVG
3	2483.650	62.57	0.11	62.68	74.00	-11.32	peak
4	2483.650	46.21	0.11	46.32	54.00	-7.68	AVG

Note:1.Result (dBuV/m) = Correct Factor (dB/m) + Reading(dBuV).

2.Correction factor (dB/m) = Antenna Factor (dB/m) + Cable loss (dB) – Pre-Amplifier gain (dB).

3. When the peak results are less than average limit, so not need to evaluate the average.



Standard:	FCC Part 15C	Test Distance:	3m
Test item:	Band edge	Power:	AC 120V/60Hz
Frequency:	2452MHz	Temp.(°C)/Hum.(%RH):	26(°C)/60%RH
Mode:	Mode 3	Date:	03/21/2017
Ant.Polar.:	Vertical		

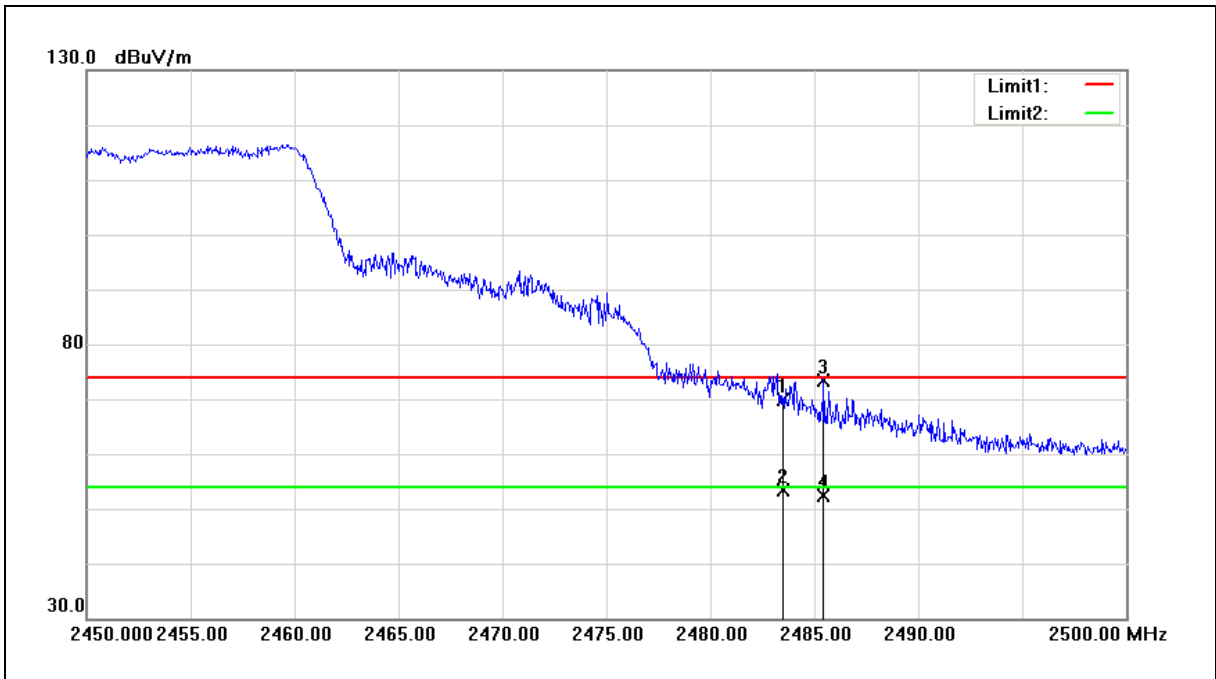

No.	Frequency (MHz)	Reading (dBuV)	Correct Factor (dB/m)	Result (dBuV/m)	Limit (dBuV/m)	Margin (dB)	Remark
1	2483.500	69.79	0.11	69.90	74.00	-4.10	peak
2	2483.500	53.16	0.11	53.27	54.00	-0.73	AVG
3	2485.450	73.38	0.12	73.50	74.00	-0.50	peak
4	2485.450	52.34	0.12	52.46	54.00	-1.54	AVG

Note:1.Result (dBuV/m) = Correct Factor (dB/m) + Reading(dBuV).

2.Correction factor (dB/m) = Antenna Factor (dB/m) + Cable loss (dB) – Pre-Amplifier gain (dB).

3. When the peak results are less than average limit, so not need to evaluate the average.



Standard:	FCC Part 15C	Test Distance:	3m
Test item:	Band edge	Power:	AC 120V/60Hz
Frequency:	2462MHz	Temp.(°C)/Hum.(%RH):	26(°C)/60%RH
Mode:	Mode 3	Date:	03/21/2017
Ant.Polar.:	Horizontal		

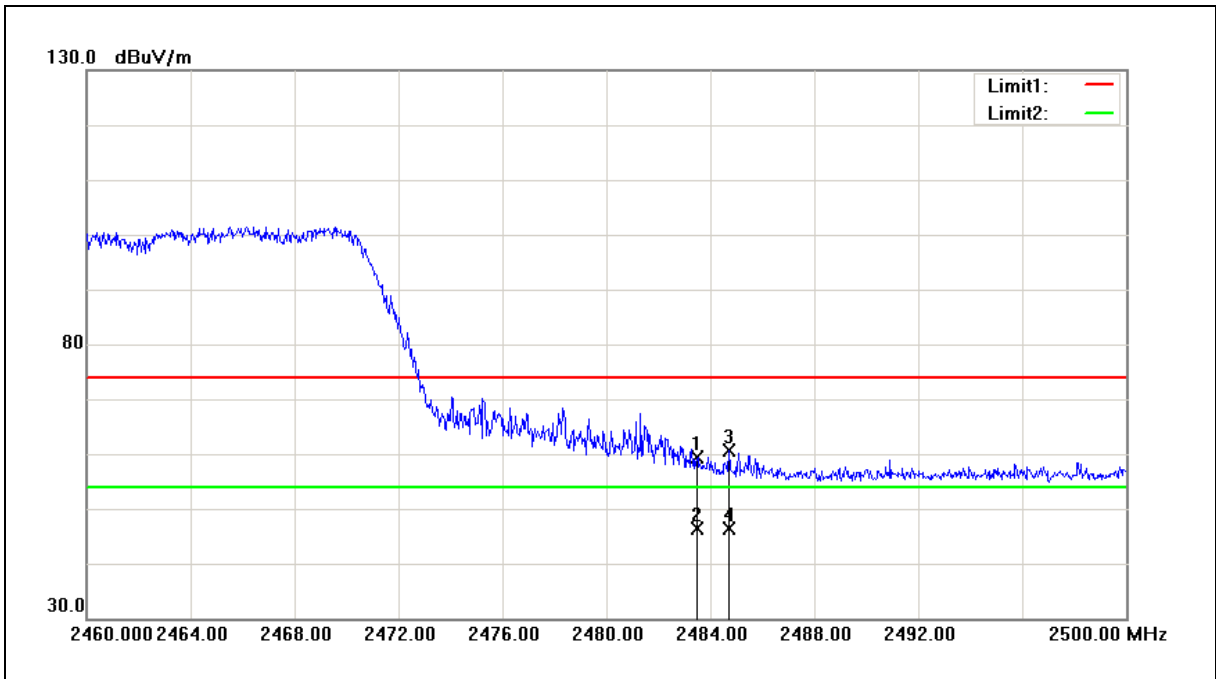

No.	Frequency (MHz)	Reading (dBuV)	Correct Factor (dB/m)	Result (dBuV/m)	Limit (dBuV/m)	Margin (dB)	Remark
1	2483.500	59.32	0.11	59.43	74.00	-14.57	peak
2	2483.500	46.28	0.11	46.39	54.00	-7.61	AVG
3	2484.720	60.43	0.12	60.55	74.00	-13.45	peak
4	2484.720	46.19	0.12	46.31	54.00	-7.69	AVG

Note:1.Result (dBuV/m) = Correct Factor (dB/m) + Reading(dBuV).

2.Correction factor (dB/m) = Antenna Factor (dB/m) + Cable loss (dB) – Pre-Amplifier gain (dB).

3. When the peak results are less than average limit, so not need to evaluate the average.



Standard:	FCC Part 15C	Test Distance:	3m
Test item:	Band edge	Power:	AC 120V/60Hz
Frequency:	2462MHz	Temp.(°C)/Hum.(%RH):	26(°C)/60%RH
Mode:	Mode 3	Date:	03/21/2017
Ant.Polar.:	Vertical		

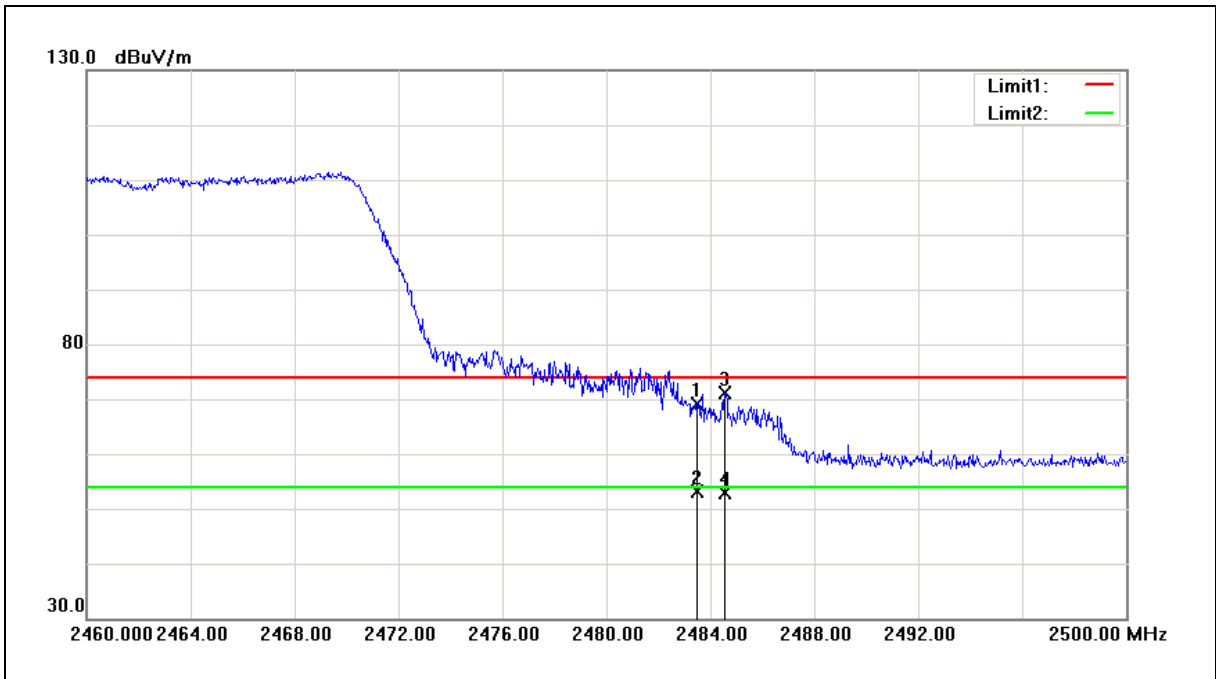

No.	Frequency (MHz)	Reading (dBuV)	Correct Factor (dB/m)	Result (dBuV/m)	Limit (dBuV/m)	Margin (dB)	Remark
1	2483.500	69.04	0.11	69.15	74.00	-4.85	peak
2	2483.500	53.08	0.11	53.19	54.00	-0.81	AVG
3	2484.560	71.03	0.12	71.15	74.00	-2.85	peak
4	2484.560	52.71	0.12	52.83	54.00	-1.17	AVG

Note:1.Result (dBuV/m) = Correct Factor (dB/m) + Reading(dBuV).

2.Correction factor (dB/m) = Antenna Factor (dB/m) + Cable loss (dB) – Pre-Amplifier gain (dB).

3. When the peak results are less than average limit, so not need to evaluate the average.