



Product Service

**Choose certainty.  
Add value.**



# Report On

FCC and IC Testing of the Ericsson KRC 161 688/3 (Radio 2212 B2/B25 (B2)) LTE (1900 MHz) Base Station in accordance with FCC CFR 47 Part 2, FCC CFR 47 Part 24, Industry Canada RSS-GEN and Industry Canada RSS-133

COMMERCIAL-IN-CONFIDENCE

FCC ID: TA8AKRC161688

IC: 287AB-AS161688

PREPARED BY

Natalie Bennett  
Project Manager (RF  
and Telecom)

APPROVED BY

Steve Scarfe  
Authorised Signatory

DATED

15 January 2019

Document 75943170 Report 18 Issue 1

January 2019



## CONTENTS

Section	Page No
<b>1</b>	<b>REPORT INFORMATION ..... 2</b>
1.1	Report Details ..... 3
1.2	Brief Summary of Results ..... 4
1.3	Configuration Description ..... 5
1.4	Declaration of Build Status ..... 6
1.5	Product Information ..... 7
1.6	Test Setup ..... 8
1.7	Test Conditions ..... 9
1.8	Deviation From The Standard ..... 9
1.9	Modification Record ..... 9
1.10	Test Location ..... 9
<b>2</b>	<b>TEST DETAILS ..... 10</b>
2.1	Maximum Peak Output Power and Peak to Average Ratio - Conducted ..... 11
2.2	Occupied Bandwidth ..... 16
2.3	Band Edge ..... 20
2.4	Transmitter Spurious Emissions ..... 24
2.5	Radiated Emissions ..... 38
<b>3</b>	<b>TEST EQUIPMENT USED ..... 52</b>
3.1	Test Equipment Used ..... 53
3.2	Measurement Uncertainty ..... 55
<b>4</b>	<b>ACCREDITATION, DISCLAIMERS AND COPYRIGHT ..... 56</b>
4.1	Accreditation, Disclaimers and Copyright ..... 57
<b>ANNEX A</b>	<b>Module Lists ..... A.2</b>



Product Service

## **SECTION 1**

### **REPORT INFORMATION**



Product Service

## 1.1 REPORT DETAILS

Manufacturer	Ericsson
Address	Torshamnsgatan 23 Kista SE-16480 Stockholm Sweden
Product Name & Product Number	Radio 2212 B2/B25 (B2) - KRC 161 688/3
IC Model Name	AS161688
Serial Number(s)	D826860358
Software Version	CXP9013268/15_ R73AM
Hardware Version	R1B
Non-Tested Variant	Radio 2212 B2/B25 (B2) - KRC 161 688/1
Non-Tested FCC ID	TA8AKRC161688
Non-Tested IC ID	287AB-AS161688
Non-Tested IC Model Name	AS161688
Test Specification/Issue/Date	FCC CFR 47 Part 2: 2017 FCC CFR 47 Part 24: 2017 Industry Canada RSS-GEN: Issue 5: 2018 Industry Canada RSS-133: Issue 6: 2013
Start of Test	01 October 2018
Finish of Test	02 November 2018
Name of Engineer(s)	Neil Rousell and Graeme Lawler
Related Document(s)	KDB 971168 D01 v02r02 KDB 662911 D01 v02r01

---

### ENGINEERING STATEMENT

The measurements shown in this report were made in accordance with the procedures described on test pages. All reported testing was carried out on a sample equipment to demonstrate compliance FCC CFR 47 Part 2, FCC CFR 47 Part 24, Industry Canada RSS-GEN and Industry Canada RSS-133. The sample tested was found to comply with the requirements defined in the applied rules.

Test Engineer(s);

Neil Rousell

Graeme Lawler



Product Service

## 1.2 BRIEF SUMMARY OF RESULTS

A brief summary of results for each configuration, in accordance with FCC CFR 47 Part 2, FCC CFR 47 Part 24, Industry Canada RSS-GEN and Industry Canada RSS-133 is shown below.

Section	Specification Clause				Test Description	Result
	FCC CFR 47 Part 2	FCC CFR 47 Part 24	RSS-GEN	RSS-133		
2.1	2.1046	24.232 (a)	-	6.4	Maximum Peak Output Power and Peak to Average Ratio - Conducted	Pass
2.2	2.1049	24.238 (b)	6.6	-	Occupied Bandwidth	Pass
2.3	2.1051	24.238 (b)	-	6.5	Band Edge	Pass
2.4	2.1051	24.238 (a)	-	6.5	Transmitter Spurious Emissions	Pass
2.5	2.1051	24.238 (a)	-	6.5	Radiated Emissions	Pass

### Measurement Uncertainty Decision Statement

Determination of conformity with the specification limits is based on the results of the compliance measurement and does not take into account measurement instrumentation uncertainty as defined in ANSI C63.26:2015 Clause 1.3.



Product Service

### 1.3 CONFIGURATION DESCRIPTION

Configuration	RAT	No. Of carriers	Carrier Bandwidth	Carrier Frequency Configuration (MHz)		
				Bottom	Middle	Top
A	LTE+NB IoT GB	1	10MHz	1935.0	-	1985.0
A	LTE+NB IoT GB	1	15MHz	1937.5	-	1982.5
A	LTE+NB IoT GB	1	20MHz	1940.0	-	1980.0



## 1.4 DECLARATION OF BUILD STATUS

MAIN EUT	
MANUFACTURING DESCRIPTION	Radio Unit
MANUFACTURER	Ericsson AB
PRODUCT NAME	Radio 2212 B2/B25 (G2)
PART NUMBER	KRC 161 688/1      KRC 161 688/3 <sup>2</sup>
IC Model Name	AS161688
SERIAL NUMBER	-      D826860358
HARDWARE VERSION	-      R1B
SOFTWARE VERSION	-      CXP9013268_15 R73AM
TRANSMITTER OPERATING RANGE	1930 - 1995 MHz
MODULATIONS	WCDMA: QPSK, 16QAM, 64QAM LTE: QPSK, 16QAM, 64QAM, 256QAM
ITU DESIGNATION OF EMISSION	WCDMA: 5M00F9W
	1,4 MHz BW channel: 1M40F9W
	3 MHz BW channel: 3M00F9W
	5 MHz BW channel: 5M00F9W
	10 MHz BW channel <sup>1</sup> : 9M43F9W
	15 MHz BW channel <sup>1</sup> : 14M1F9W
	20 MHz BW channel <sup>1</sup> : 18M5F9W
NB-IoT SA 180 kHz BW channel: 224KW7D	
OUTPUT POWER (RMS) (W or dBm)	2 ports, 80W <sup>1</sup> per port
	NB-IoT SA 1 x 20W (per port)
FCC ID	TA8AKRC161688
IC ID	287AB-AS161688
TECHNICAL DESCRIPTION (a brief description of the intended use and operation)	Base station radio

<sup>1</sup>Including 2 NB-IoT GB carriers.

<sup>2</sup> KRC 161 688/3 is the test object, both variants are electrically equivalent, with only mechanical differences in the enclosure.

Signature

*Audun B Helle*  
Audun Helle

Date

2019-01-10

No responsibility will be accepted by TÜV SÜD Product Service UK Limited as to the accuracy of the information declared in this document by the manufacturer.

## 1.5 PRODUCT INFORMATION

### 1.5.1 Technical Description

The Equipment Under Test (EUT) Radio 2212 B2/B25 (B2) - KRC 161 688/3 is an Ericsson AB Radio Unit working in the public mobile service 1900 MHz band which provides communication connections to 1900 MHz network. The Radio 2212 B2/B25 (B2) - KRC 161 688/3 operates from a -48V DC supply.

The Equipment Under Test (EUT) is shown in the photograph below. A full technical description can be found in the Manufacturer's documentation.

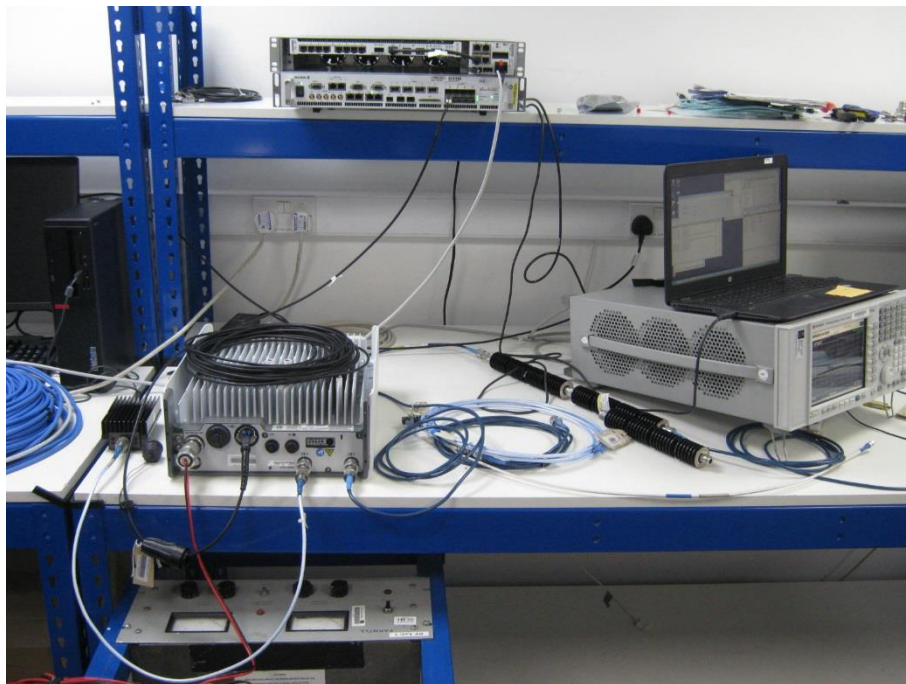

Equipment Under Test





### 1.6 TEST SETUP

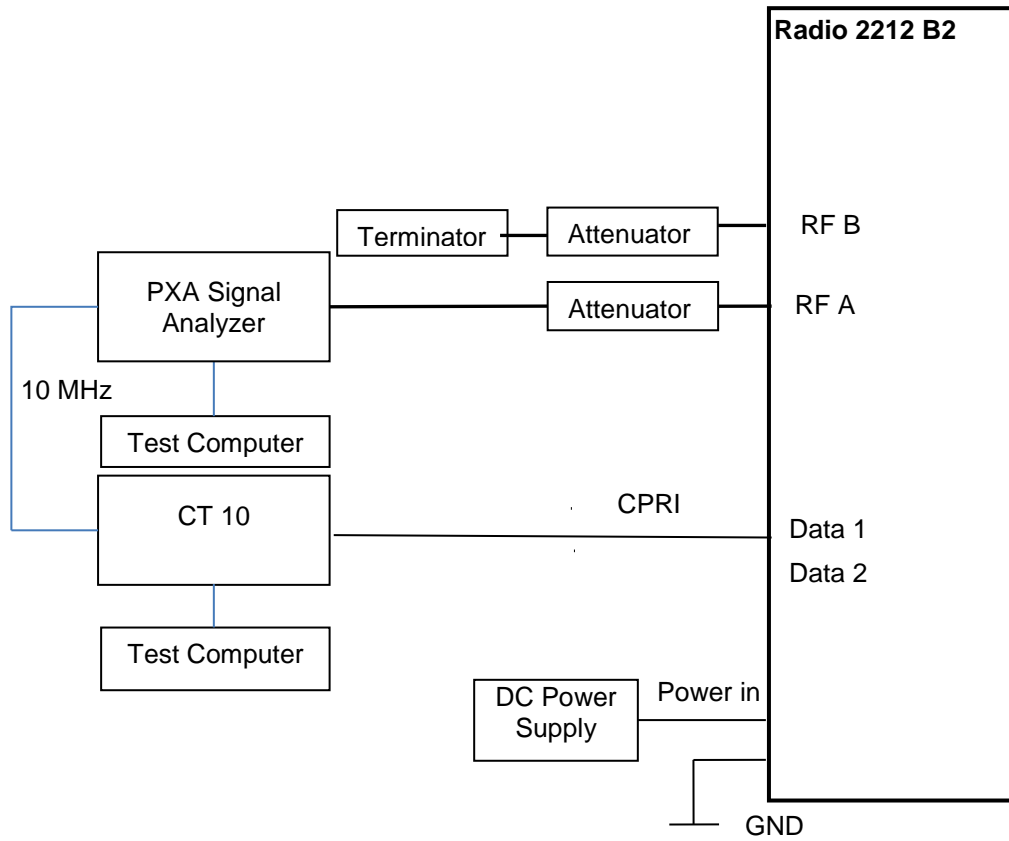



Product Service

## 1.7 TEST CONDITIONS

For all tests the EUT was set up in accordance with the relevant test standard and to represent typical operating conditions. Tests were applied with the EUT situated in a shielded enclosure, test laboratories or a chamber as appropriate.

The EUT was powered from a -48V DC supply.

FCC Measurement Facility Registration Number  
90987 Octagon House, Fareham Test Laboratory

Industry Canada Accreditation  
IC2932B-1 Octagon House, Fareham Test Laboratory

## 1.8 DEVIATION FROM THE STANDARD

No deviations from the applicable test standards or test plan were made during testing.

## 1.9 MODIFICATION RECORD

No modifications were made to the EUT during testing.

## 1.10 TEST LOCATION

TÜV SÜD Product Service conducted the following tests at our Fareham Test Laboratory.

Test Name	Name of Engineer(s)
Maximum Peak Output Power and Peak to Average Ratio - Conducted	Neil Rousell
Occupied Bandwidth	Neil Rousell
Band Edge	Neil Rousell
Transmitter Spurious Emissions	Neil Rousell
Radiated Emissions	Graeme Lawler

Office Address:

Octagon House  
Concorde Way  
Segensworth North  
Fareham  
Hampshire  
PO15 5RL  
United Kingdom



Product Service

## **SECTION 2**

### **TEST DETAILS**



**2.1 MAXIMUM PEAK OUTPUT POWER AND PEAK TO AVERAGE RATIO - CONDUCTED**

**2.1.1 Specification Reference**

FCC CFR 47 Part 2, Clause 2.1046  
FCC CFR 47 Part 24, Clause 24.232 (a)  
Industry Canada RSS-133, Clause 6.4

**2.1.2 Date of Test and Modification State**

02 November 2018 - Modification State 0

**2.1.3 Test Equipment Used**

The major items of test equipment used for the above tests are identified in Section 3.1.

**2.1.4 Environmental Conditions**

Ambient Temperature 22.6°C  
Relative Humidity 35.9%

**2.1.5 Test Method**

All measurements were made in accordance with FCC KDB 971168 D01, clause 5.2.1 and summed in accordance with FCC KDB 662911 D01.

**2.1.6 Test Results**

Configuration A

Maximum Output Power 49 dBm

Antenna	LTE Modulation	LTE Carrier Bandwidth	Peak to Average Ratio (PAR) / Output Power		
			PAR (dB)	Channel Position B	
				Average Power	
			dBm	dBm/MHz	
A	64QAM	10.0 MHz	7.46	49.03	-
A	64QAM	15.0 MHz	7.46	48.98	-
A	64QAM	20.0 MHz	7.54	49.02	-



Product Service

Antenna A - LTE Modulation 64QAM - LTE Carrier Bandwidth 10.0 MHz - Channel Position B

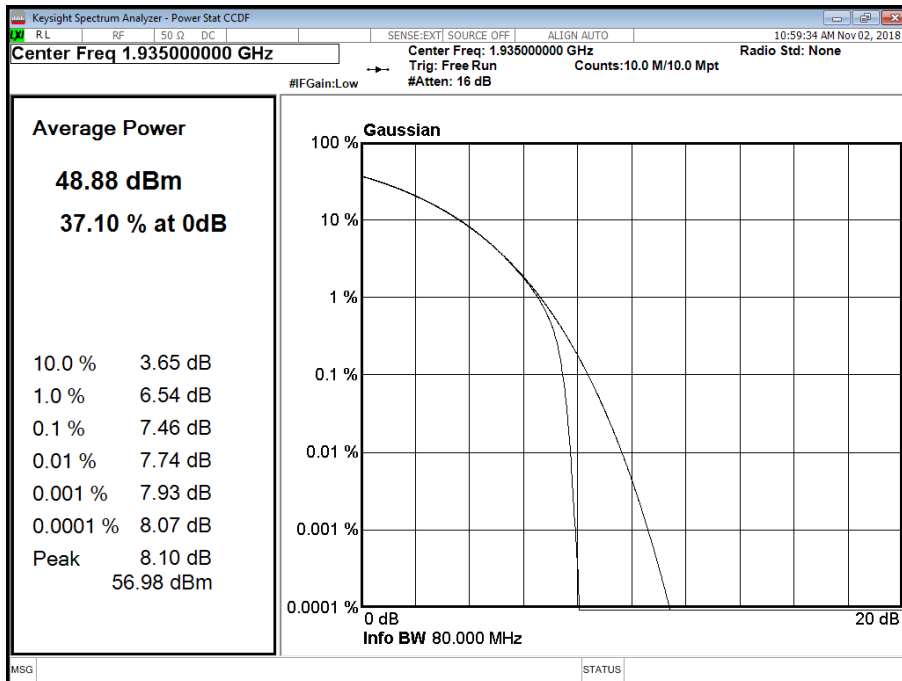

Antenna A - LTE Modulation 64QAM - LTE Carrier Bandwidth 15.0 MHz - Channel Position B

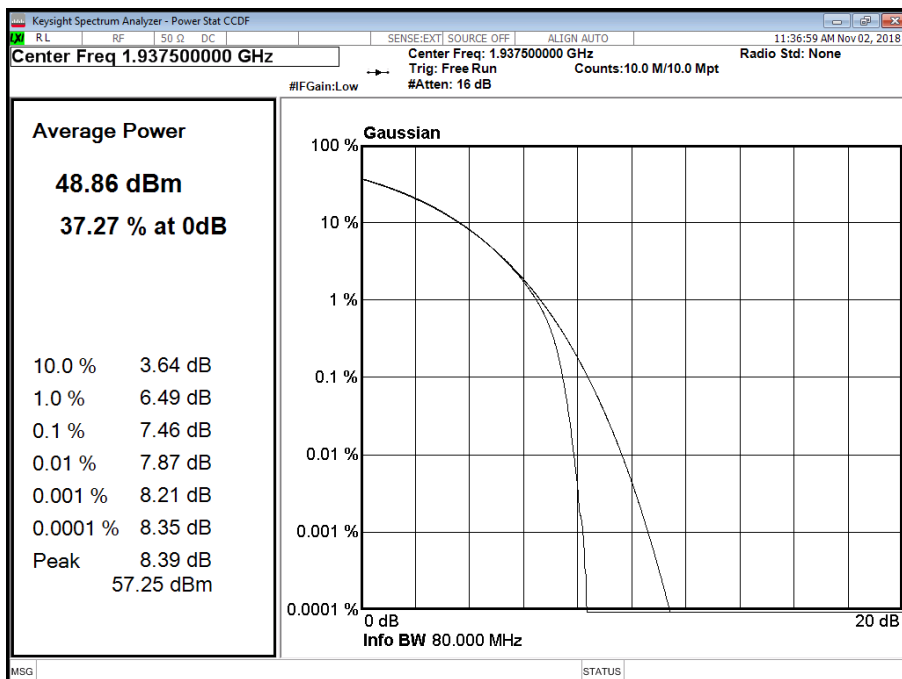



Product Service

Antenna A - LTE Modulation 64QAM - LTE Carrier Bandwidth 20.0 MHz - Channel Position B

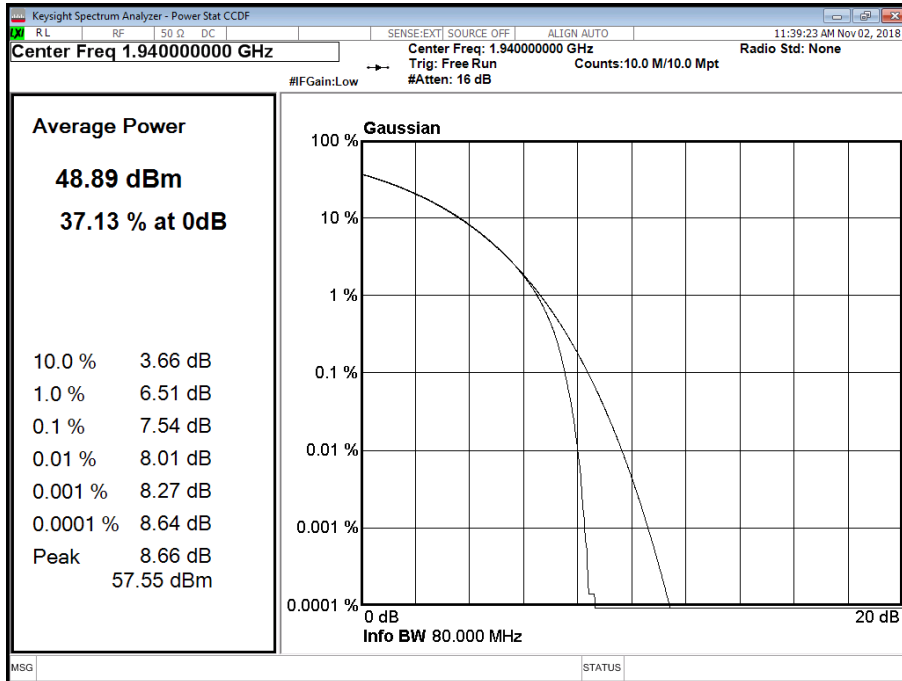



Product Service

Configuration A

Maximum Output Power 49 dBm

Antenna	LTE Modulation	LTE Carrier Bandwidth	Peak to Average Ratio (PAR) / Output Power		
			Channel Position T		
			PAR (dB)	Average Power	
dBm	dBm/MHz				
A	64QAM	10.0 MHz	7.39	49.07	-
A	64QAM	15.0 MHz	7.36	49.17	-
A	64QAM	20.0 MHz	7.38	49.21	-

Antenna A - LTE Modulation 64QAM - LTE Carrier Bandwidth 10.0 MHz - Channel Position T

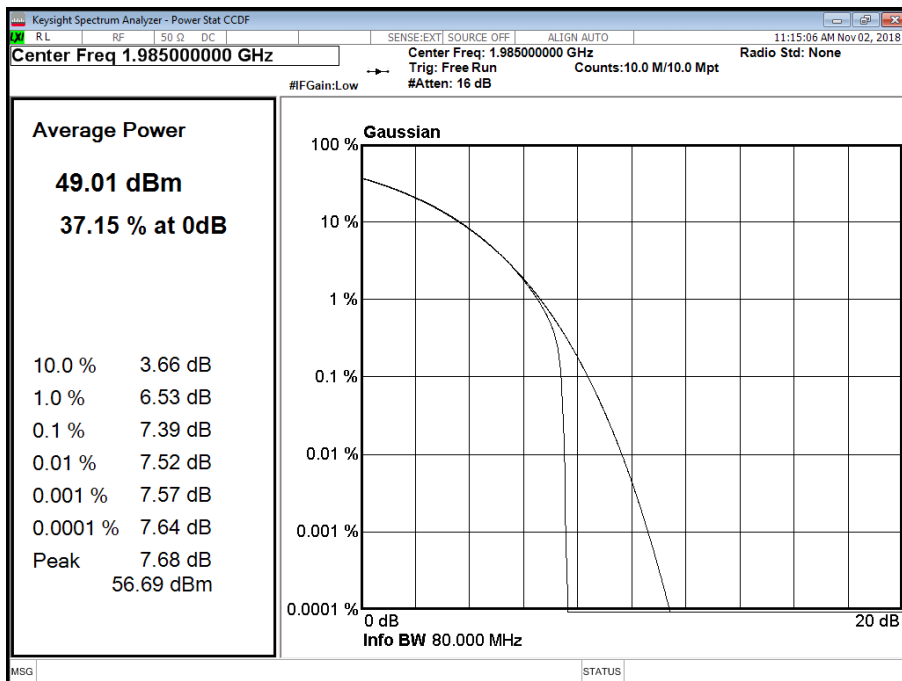



Product Service

Antenna A - LTE Modulation 64QAM - LTE Carrier Bandwidth 15.0 MHz - Channel Position T

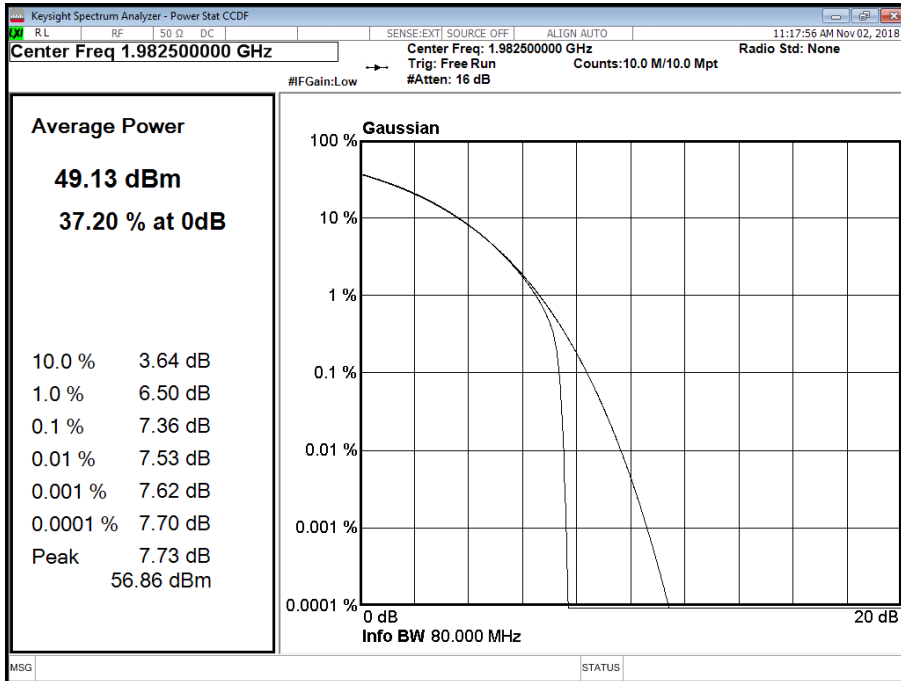

Antenna A - LTE Modulation 64QAM - LTE Carrier Bandwidth 20.0 MHz - Channel Position T

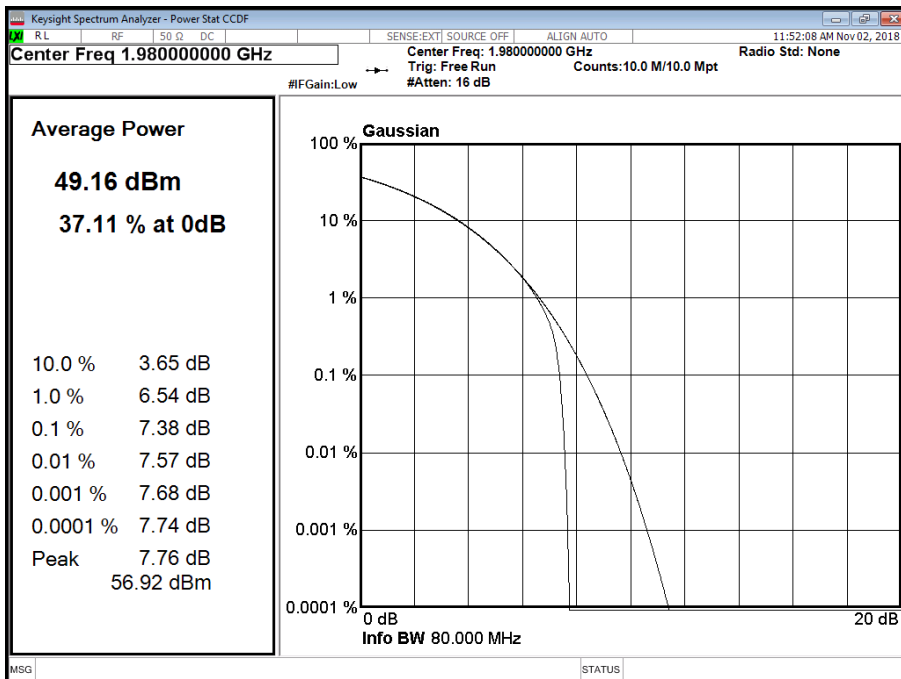

Limit	
Peak Power	≤500 W or ≤+57 dBm
Peak to Average Ratio	13 dB





Product Service

## 2.2 OCCUPIED BANDWIDTH

### 2.2.1 Specification Reference

FCC CFR 47 Part 2, Clause 2.1049  
FCC CFR 47 Part 24, Clause 24.238 (b)  
Industry Canada RSS-GEN, Clause 6.6

### 2.2.2 Date of Test and Modification State

02 November 2018 - Modification State 0

### 2.2.3 Test Equipment Used

The major items of test equipment used for the above tests are identified in Section 3.1.

### 2.2.4 Environmental Conditions

Ambient Temperature 22.6°C  
Relative Humidity 35.9%

### 2.2.5 Test Method

All measurements were made in accordance with FCC KDB 971168 D01.

### 2.2.6 Test Results

Configuration A

Maximum Output Power 49 dBm

Antenna	LTE Modulation	LTE Carrier Bandwidth	Result (KHz)					
			Channel Position B		Channel Position M		Channel Position T	
			Occupied Bandwidth	-26 dB Bandwidth	Occupied Bandwidth	-26 dB Bandwidth	Occupied Bandwidth	-26 dB Bandwidth
A	64QAM	10.0 MHz	9,397.42	9,754.37	-	-	9,418.82	9,757.59
A	64QAM	15.0 MHz	14,019.91	14,552.33	-	-	14,042.43	14,576.10
A	64QAM	20.0 MHz	18,429.59	19,374.47	-	-	18,472.64	19,274.99



Product Service

Antenna A - LTE Modulation 64QAM - LTE Carrier Bandwidth 10.0 MHz - Channel Position B

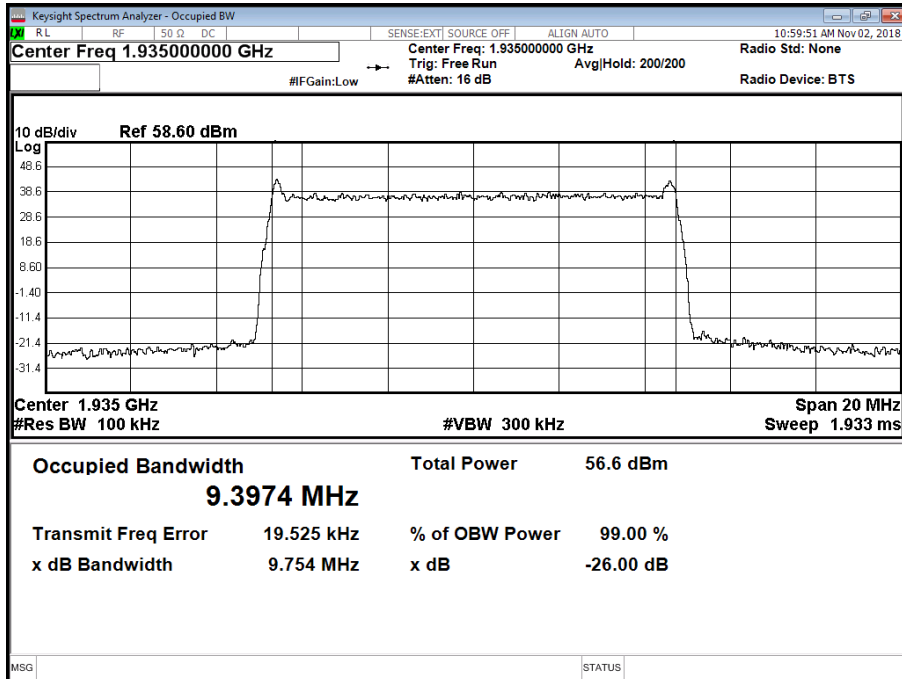

Antenna A - LTE Modulation 64QAM - LTE Carrier Bandwidth 10.0 MHz - Channel Position T

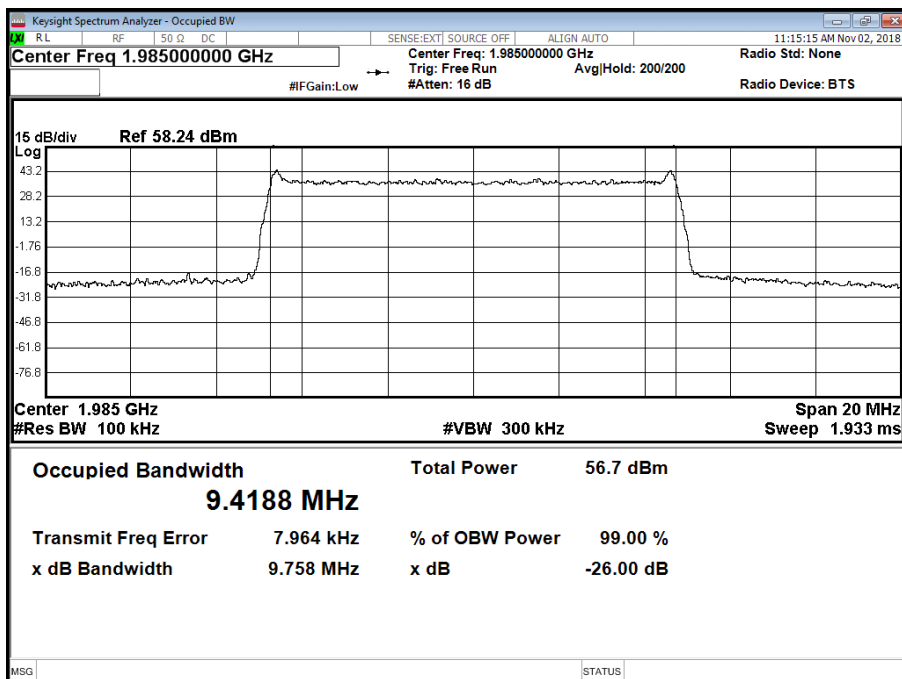



Product Service

Antenna A - LTE Modulation 64QAM - LTE Carrier Bandwidth 15.0 MHz - Channel Position B

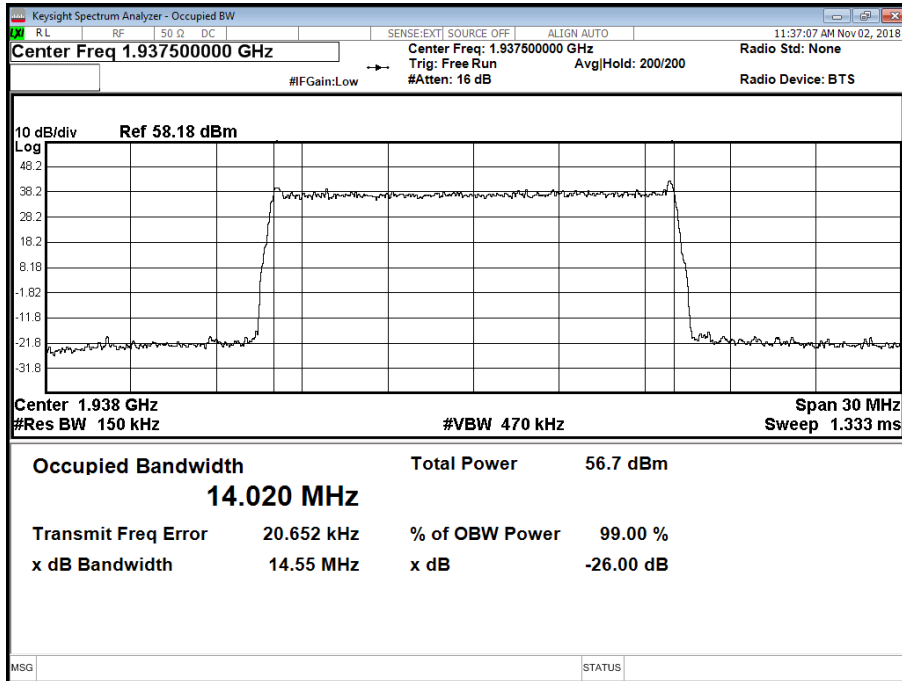

Antenna A - LTE Modulation 64QAM - LTE Carrier Bandwidth 15.0 MHz - Channel Position T

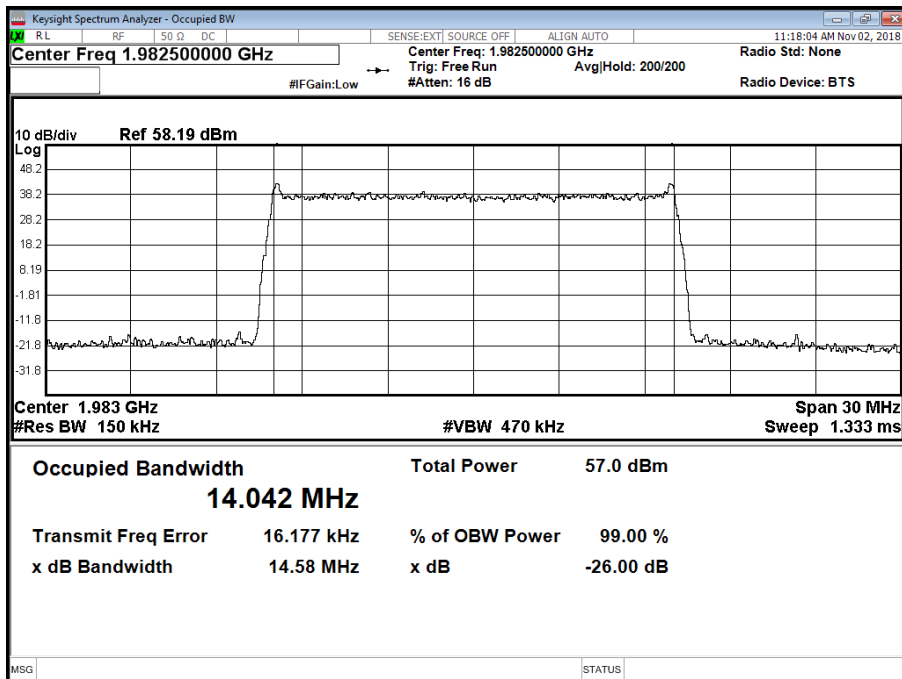



Product Service

Antenna A - LTE Modulation 64QAM - LTE Carrier Bandwidth 20.0 MHz - Channel Position B

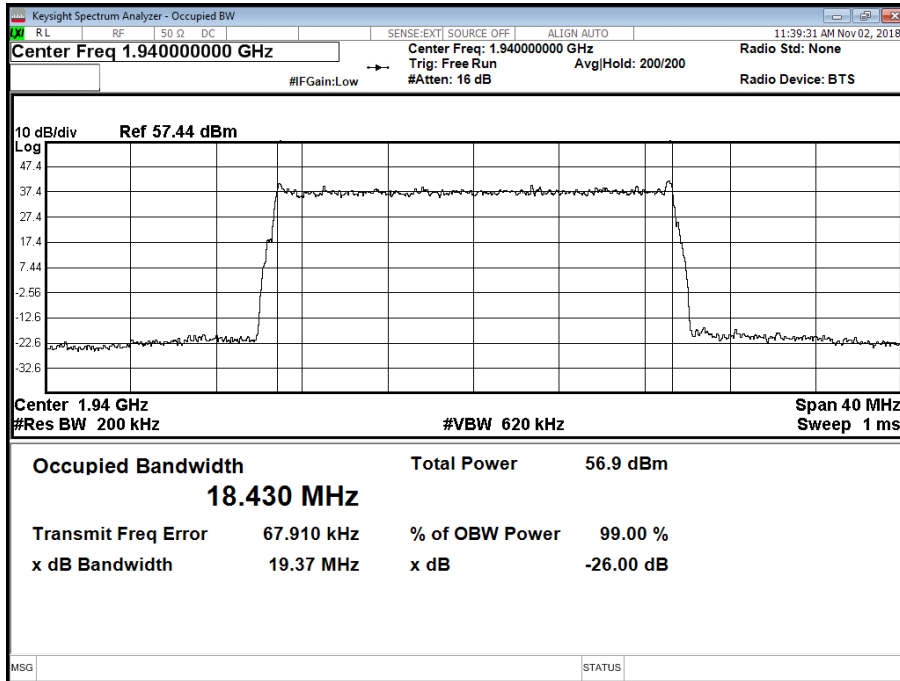

Antenna A - LTE Modulation 64QAM - LTE Carrier Bandwidth 20.0 MHz - Channel Position T

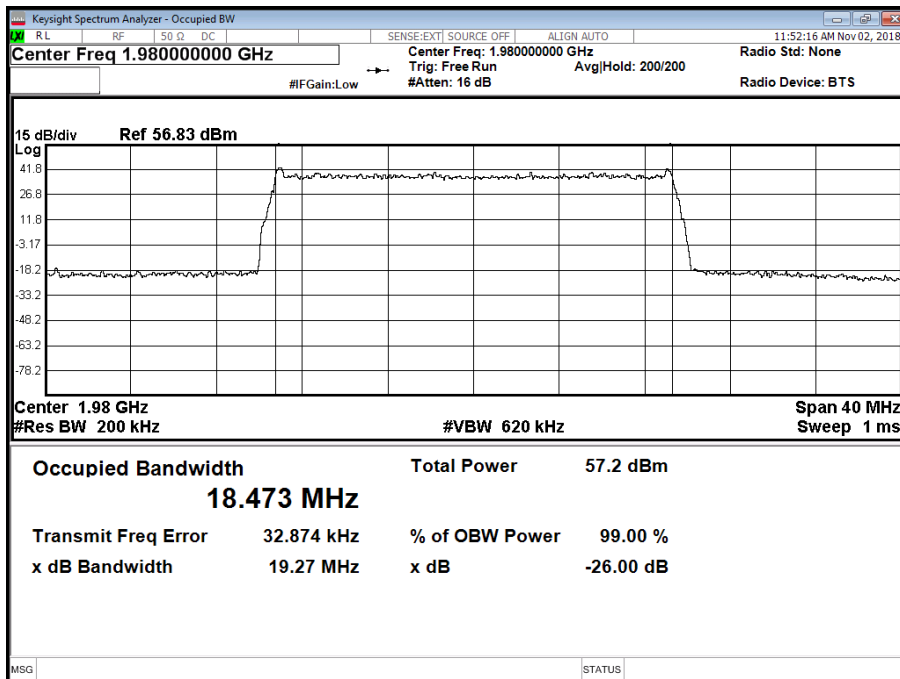



**2.3 BAND EDGE**

**2.3.1 Specification Reference**

FCC CFR 47 Part 2, Clause 2.1051  
FCC CFR 47 Part 24, Clause 24.238 (b)  
Industry Canada RSS-133, Clause 6.5

**2.3.2 Date of Test and Modification State**

02 November 2018 - Modification State 0

**2.3.3 Test Equipment Used**

The major items of test equipment used for the above tests are identified in Section 3.1.

**2.3.4 Environmental Conditions**

Ambient Temperature 22.6°C  
Relative Humidity 35.9%

**2.3.5 Test Method**

All measurements were made in accordance with FCC KDB 971168 D01.

Each antenna port has been declared as being equivalent, therefore measurements were made on one antenna port only. To account for this, the limit was tightened by  $10 * \text{Log}(N)$ , where N is equal to the number of MIMO antenna ports.

For single carrier, the limit was calculated as being  $-13 \text{ dBm} - 10 * \text{Log}(4) = -19 \text{ dBm}$ .

For dual carrier, the limit was calculated as being  $-13 \text{ dBm} - 10 * \text{Log}(2) = -16 \text{ dBm}$ .

**2.3.6 Test Results**

Configuration A

Maximum Output Power 49 dBm

Antenna	LTE Modulation	LTE Carrier Bandwidth	Band Edge (MHz)	
			Channel Position B	Channel Position T
A	64QAM	10.0 MHz	1,935.0	1,985.0
A	64QAM	15.0 MHz	1,937.5	1,982.5
A	64QAM	20.0 MHz	1,940.0	1,980.0



Product Service

Antenna A - LTE Modulation 64QAM - LTE Carrier Bandwidth 10.0 MHz - Channel Position B

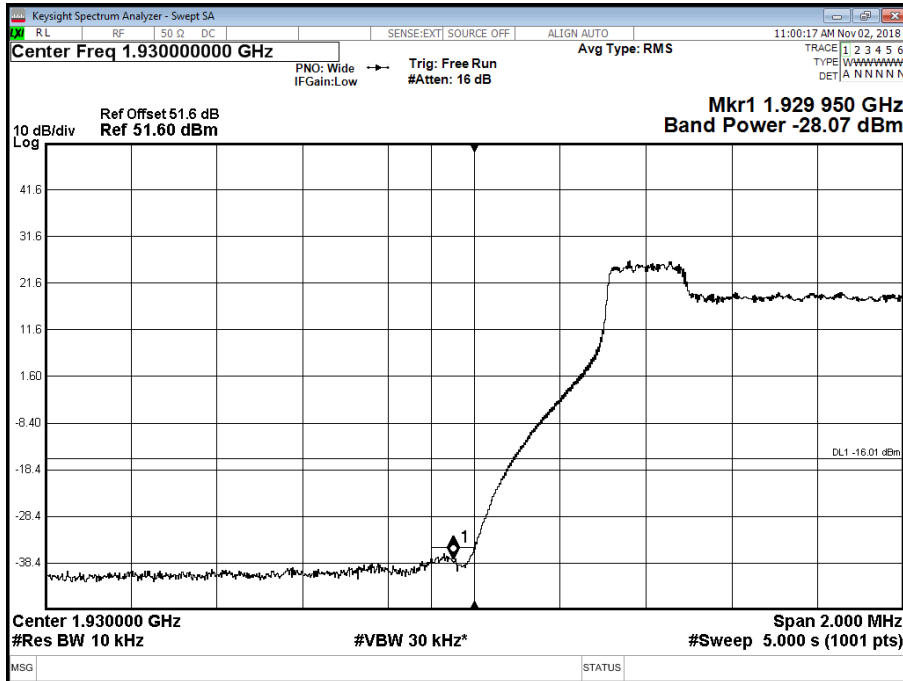

Antenna A - LTE Modulation 64QAM - LTE Carrier Bandwidth 10.0 MHz - Channel Position T

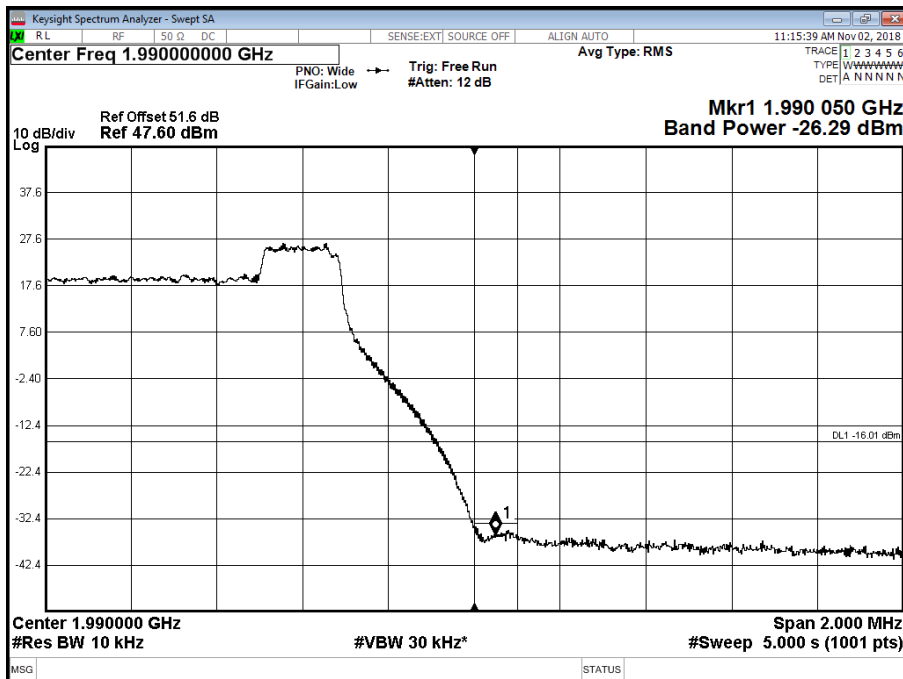



Product Service

Antenna A - LTE Modulation 64QAM - LTE Carrier Bandwidth 15.0 MHz - Channel Position B

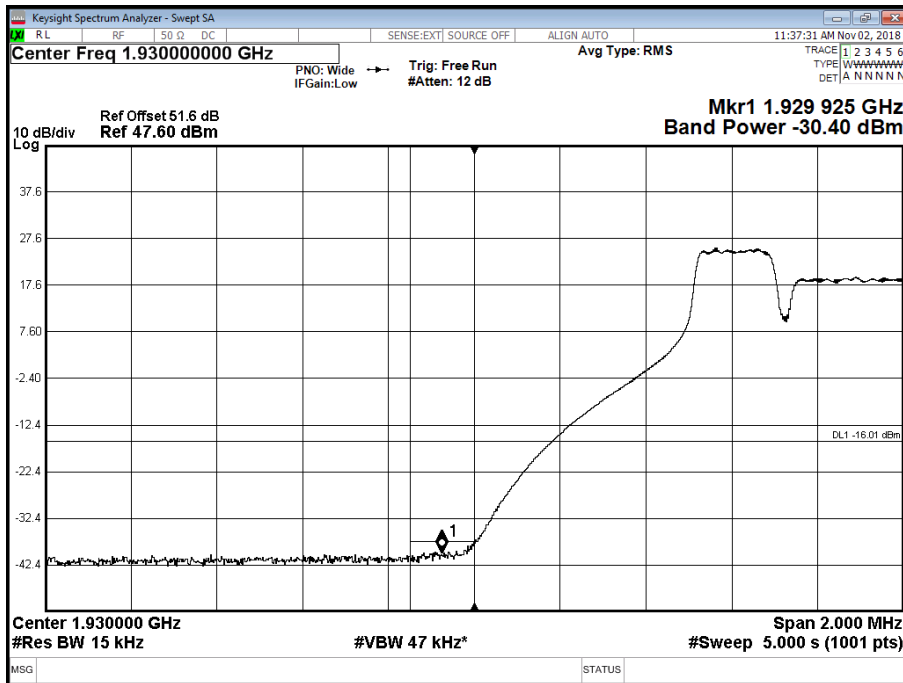

Antenna A - LTE Modulation 64QAM - LTE Carrier Bandwidth 15.0 MHz - Channel Position T

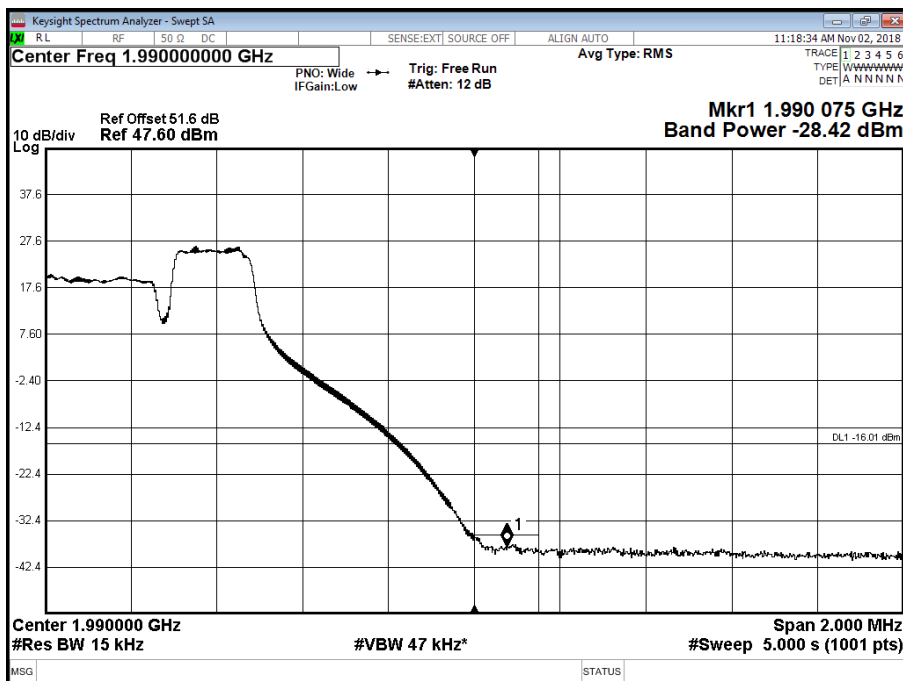



Product Service

Antenna A - LTE Modulation 64QAM - LTE Carrier Bandwidth 20.0 MHz - Channel Position B

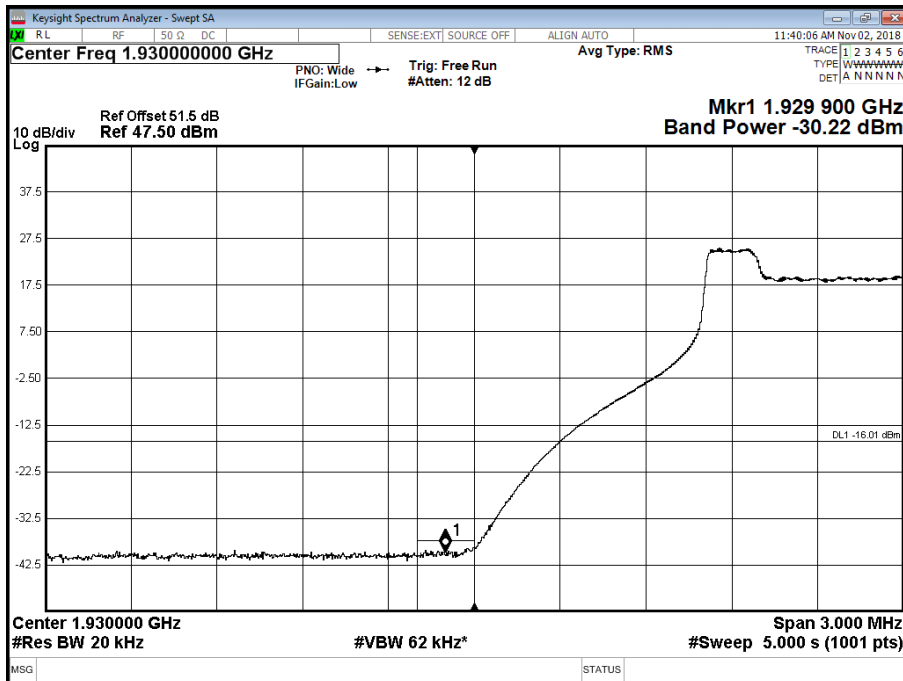

Antenna A - LTE Modulation 64QAM - LTE Carrier Bandwidth 20.0 MHz - Channel Position T

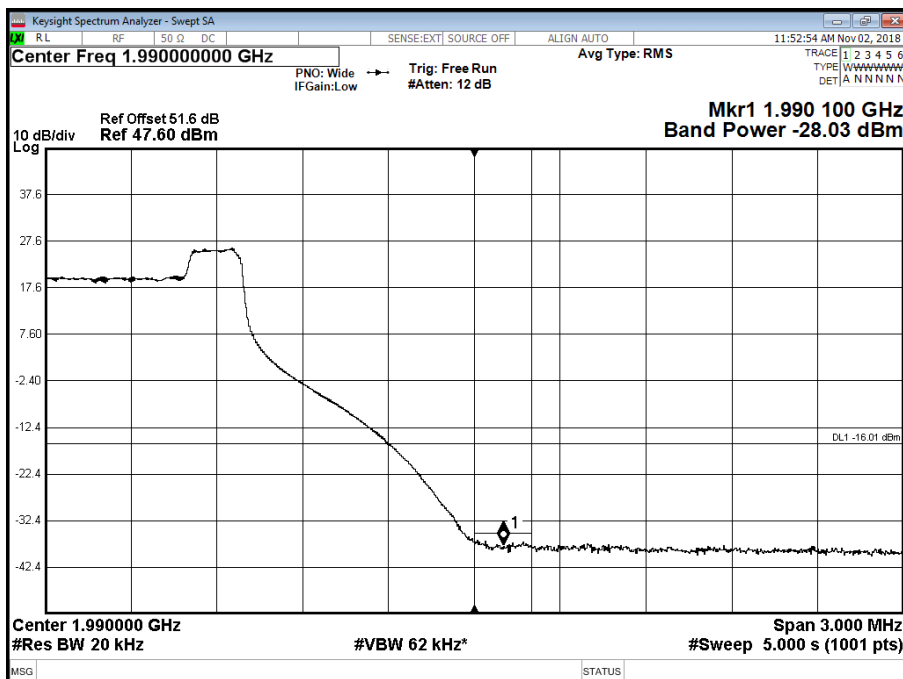

Limit	-16 dBm
-------	---------





Product Service

## **2.4 TRANSMITTER SPURIOUS EMISSIONS**

### **2.4.1 Specification Reference**

FCC CFR 47 Part 2, Clause 2.1051  
FCC CFR 47 Part 24, Clause 24.238 (a)  
Industry Canada RSS-133, Clause 6.5

### **2.4.2 Date of Test and Modification State**

11 February 2018 - Modification State 0

### **2.4.3 Test Equipment Used**

The major items of test equipment used for the above tests are identified in Section 3.1.

### **2.4.4 Environmental Conditions**

Ambient Temperature	22.6°C
Relative Humidity	35.9%

### **2.4.5 Test Method**

All measurements were made in accordance with FCC KDB 971168 D01.

Each antenna port has been declared as being equivalent, therefore measurements were made on one antenna port only. To account for this, the limit was tightened by  $10 * \text{Log}(N)$ , where N is equal to the number of MIMO antenna ports.

For single carrier, the limit was calculated as being  $-13 \text{ dBm} - 10 * \text{Log}(4) = -19 \text{ dBm}$ .

For dual carrier, the limit was calculated as being  $-13 \text{ dBm} - 10 * \text{Log}(2) = -16 \text{ dBm}$ .



Product Service

## 2.4.6 Test Results

Configuration A

Maximum Output Power 49 dBm

Antenna A - LTE Modulation 64QAM - LTE Carrier Bandwidth 10.0 MHz - Channel Position B - Band 1 - Range 0.009 to 3500 MHz

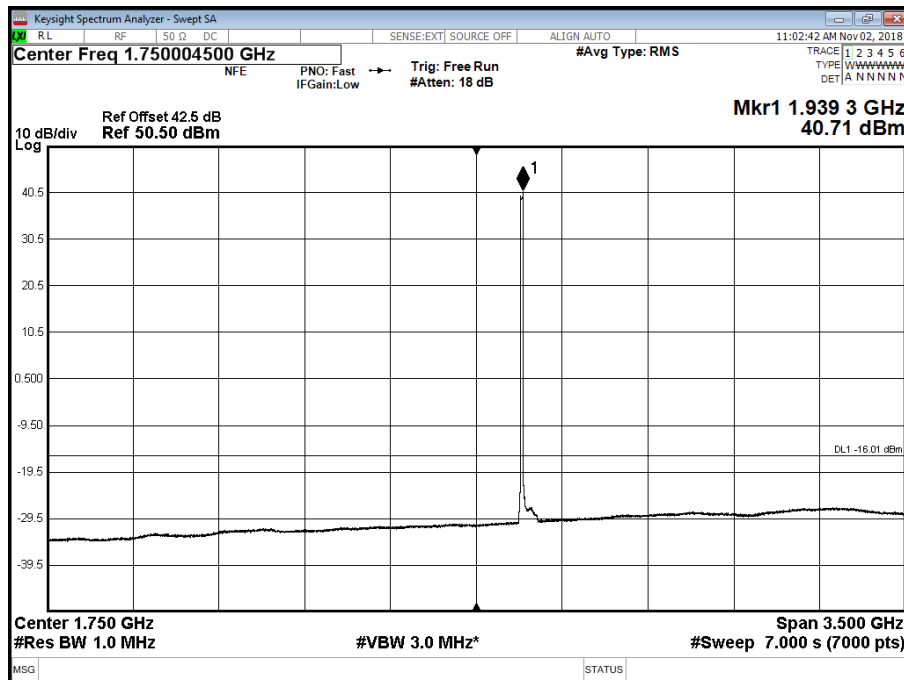



Product Service

Antenna A - LTE Modulation 64QAM - LTE Carrier Bandwidth 10.0 MHz - Channel Position B - Band 2 - Range 3500 to 12000 MHz

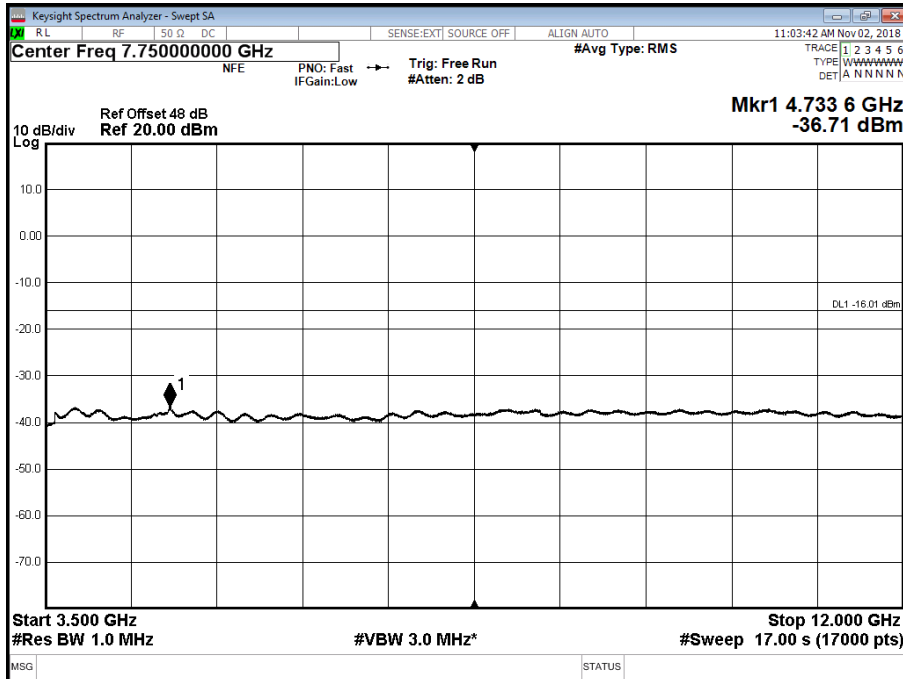

Antenna A - LTE Modulation 64QAM - LTE Carrier Bandwidth 10.0 MHz - Channel Position B - Band 3 - Range 12000 to 18000 MHz

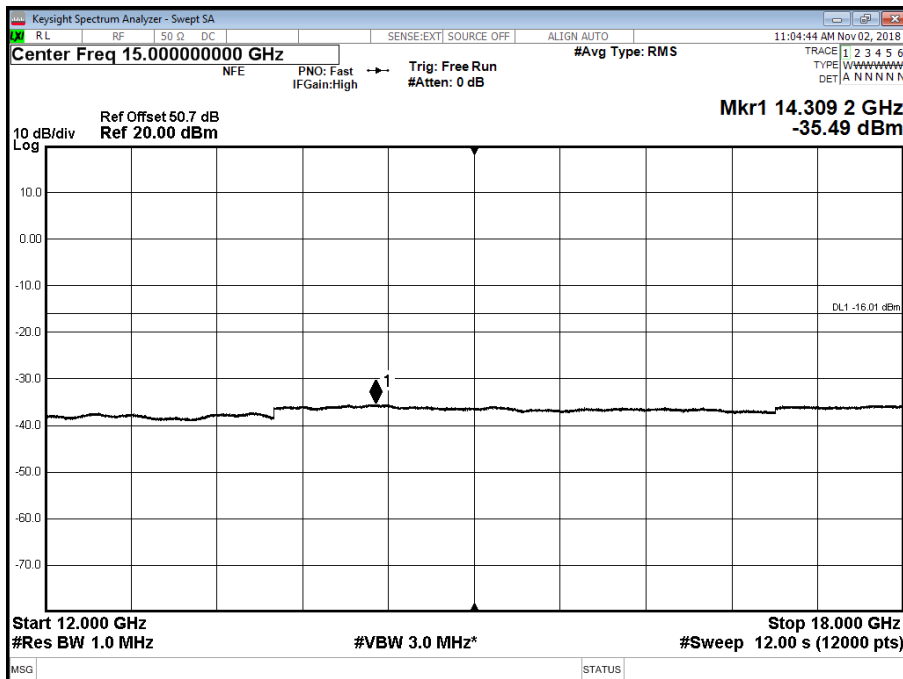



Product Service

Antenna A - LTE Modulation 64QAM - LTE Carrier Bandwidth 10.0 MHz - Channel Position B - Band 4 - Range 18000 to 22000 MHz

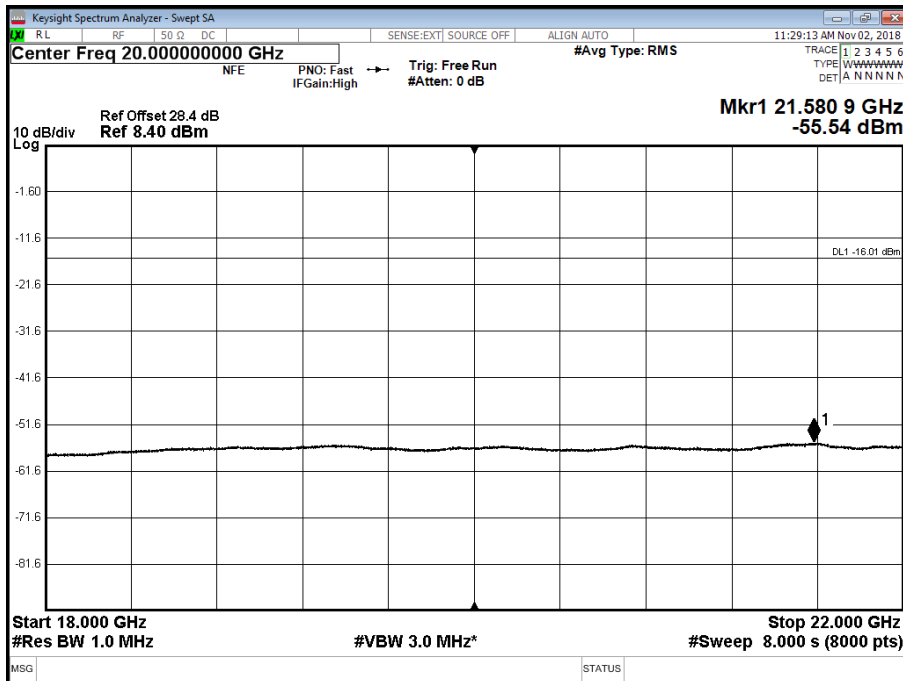

Antenna A - LTE Modulation 64QAM - LTE Carrier Bandwidth 10.0 MHz - Channel Position T - Band 1 - Range 0.009 to 3500 MHz

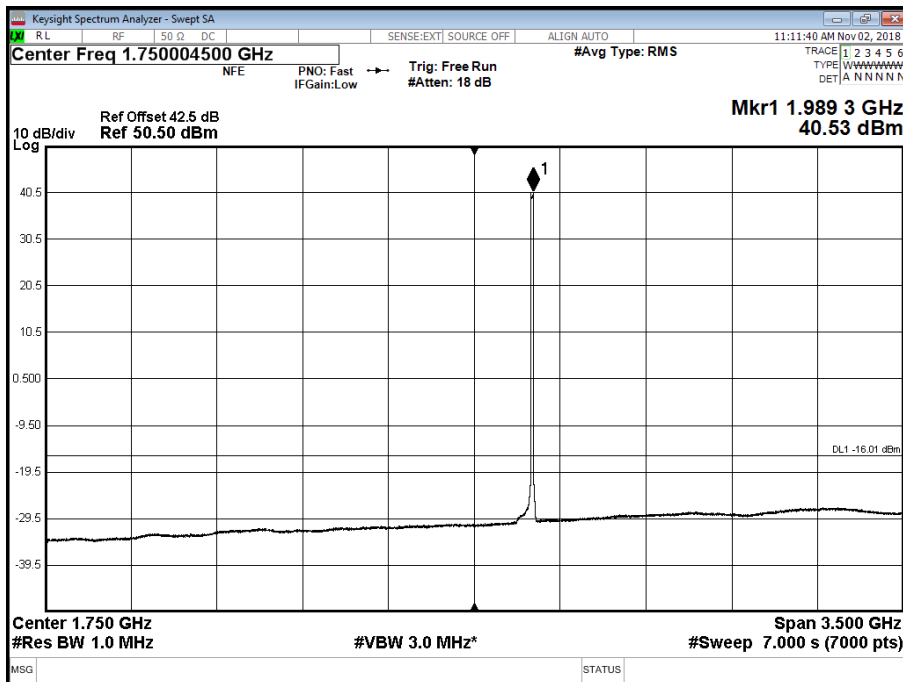



Product Service

Antenna A - LTE Modulation 64QAM - LTE Carrier Bandwidth 10.0 MHz - Channel Position T - Band 2 - Range 3500 to 12000 MHz

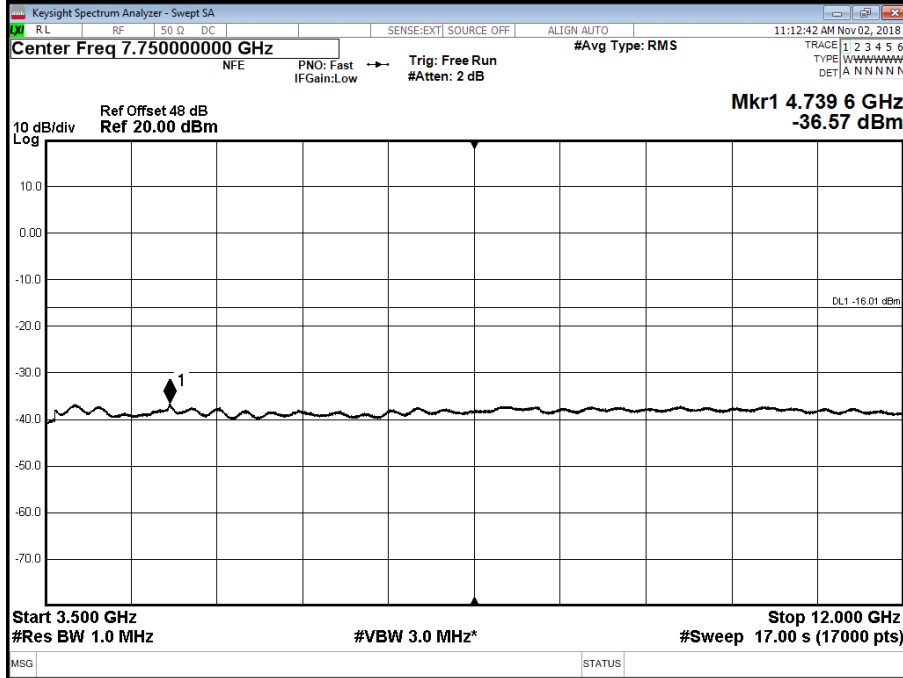

Antenna A - LTE Modulation 64QAM - LTE Carrier Bandwidth 10.0 MHz - Channel Position T - Band 3 - Range 12000 to 18000 MHz

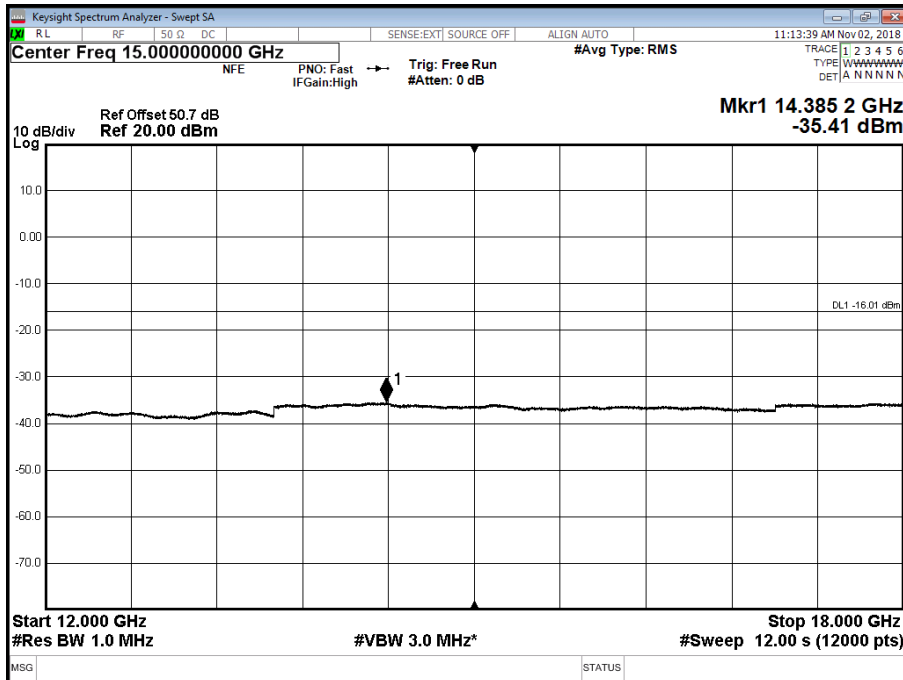



Product Service

Antenna A - LTE Modulation 64QAM - LTE Carrier Bandwidth 10.0 MHz - Channel Position T - Band 4 - Range 18000 to 22000 MHz

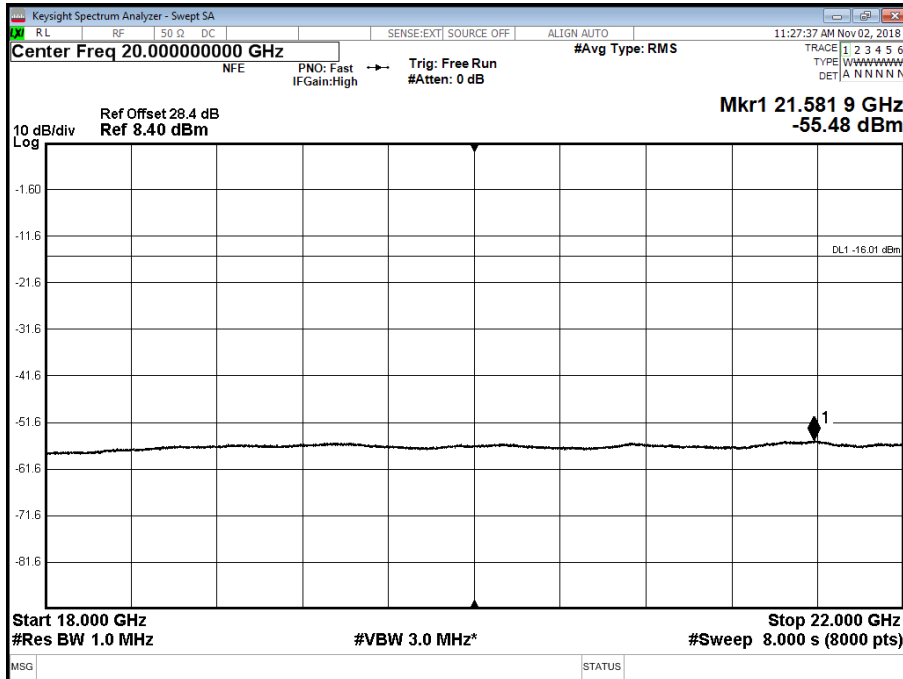

Antenna A - LTE Modulation 64QAM - LTE Carrier Bandwidth 15.0 MHz - Channel Position B - Band 1 - Range 0.009 to 3500 MHz

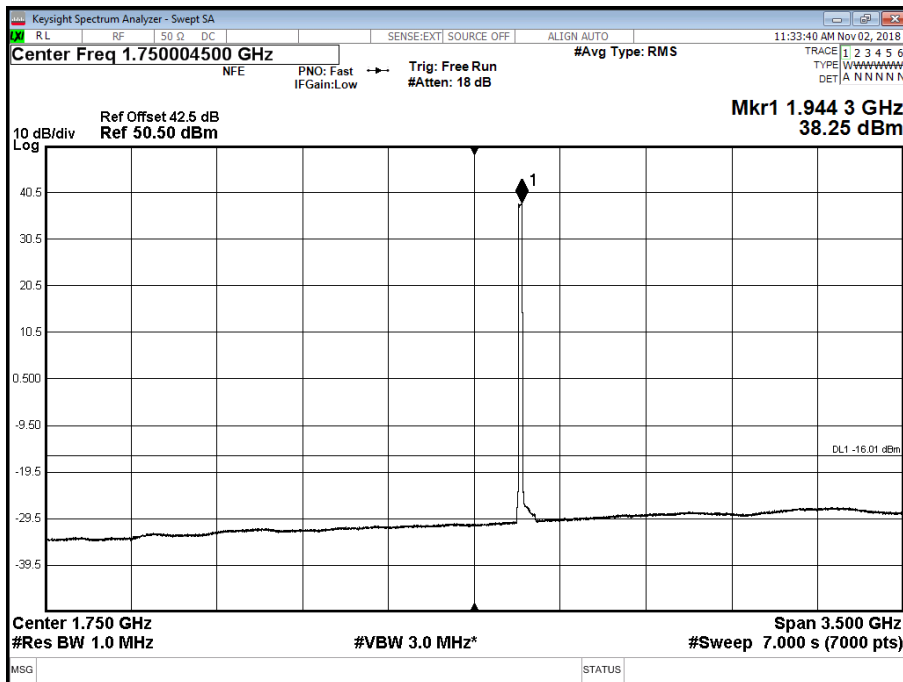



Product Service

Antenna A - LTE Modulation 64QAM - LTE Carrier Bandwidth 15.0 MHz - Channel Position B - Band 2 - Range 3500 to 12000 MHz

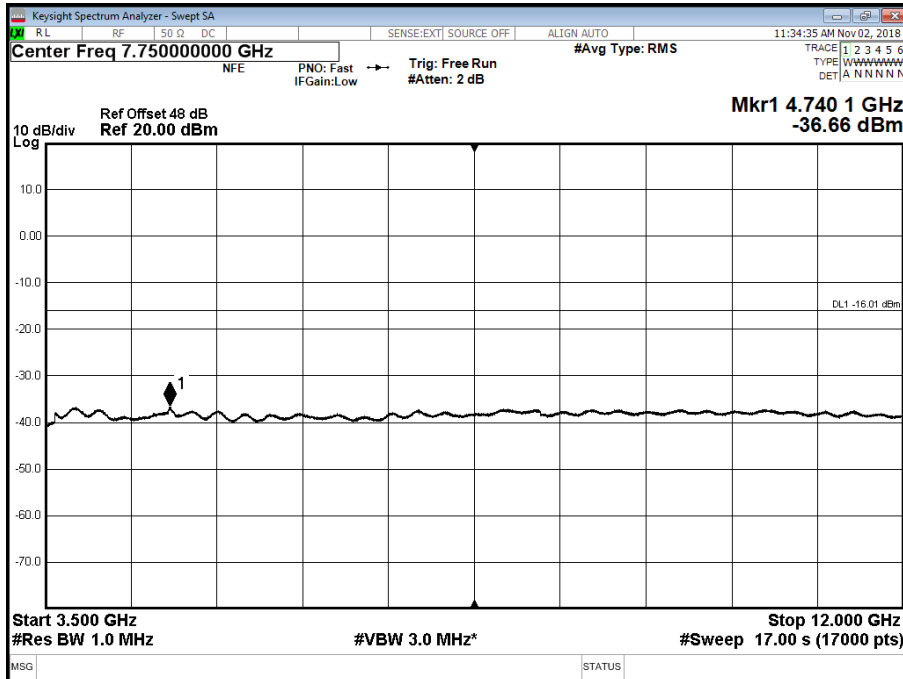

Antenna A - LTE Modulation 64QAM - LTE Carrier Bandwidth 15.0 MHz - Channel Position B - Band 3 - Range 12000 to 18000 MHz

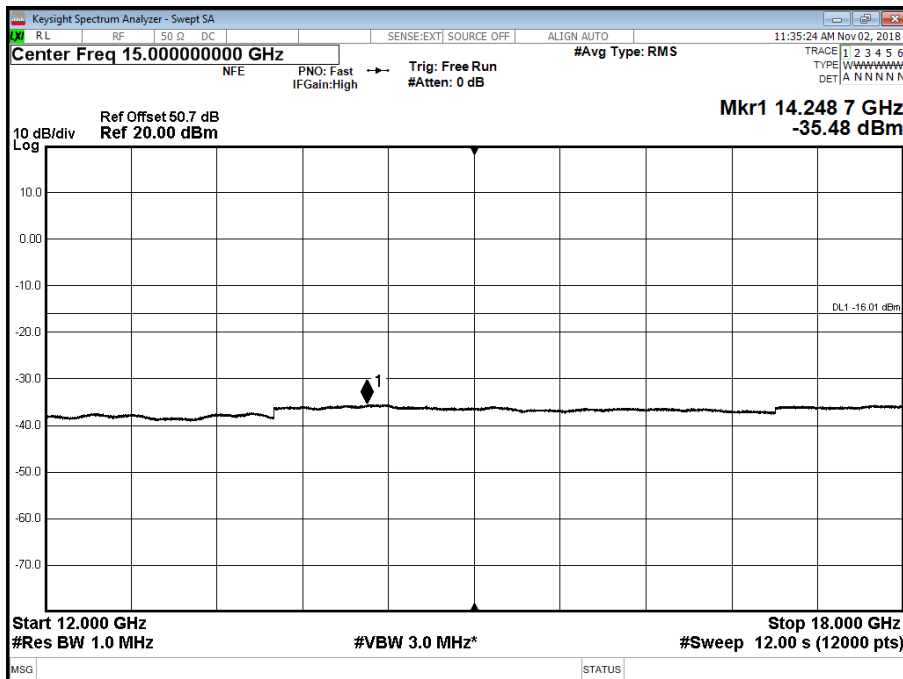



Product Service

Antenna A - LTE Modulation 64QAM - LTE Carrier Bandwidth 15.0 MHz - Channel Position B - Band 4 - Range 18000 to 22000 MHz

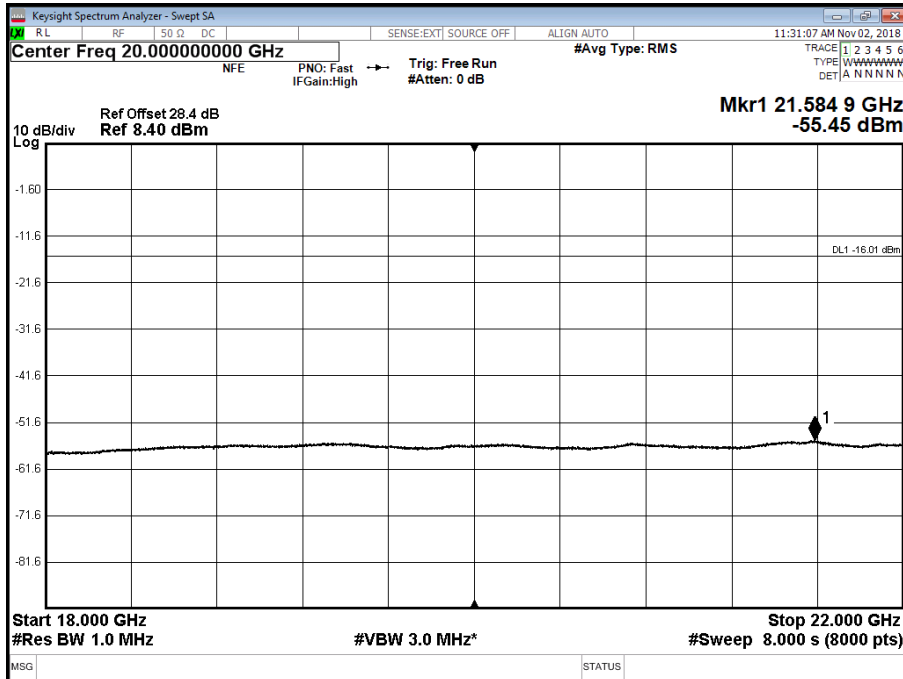

Antenna A - LTE Modulation 64QAM - LTE Carrier Bandwidth 15.0 MHz - Channel Position T - Band 1 - Range 0.009 to 3500 MHz

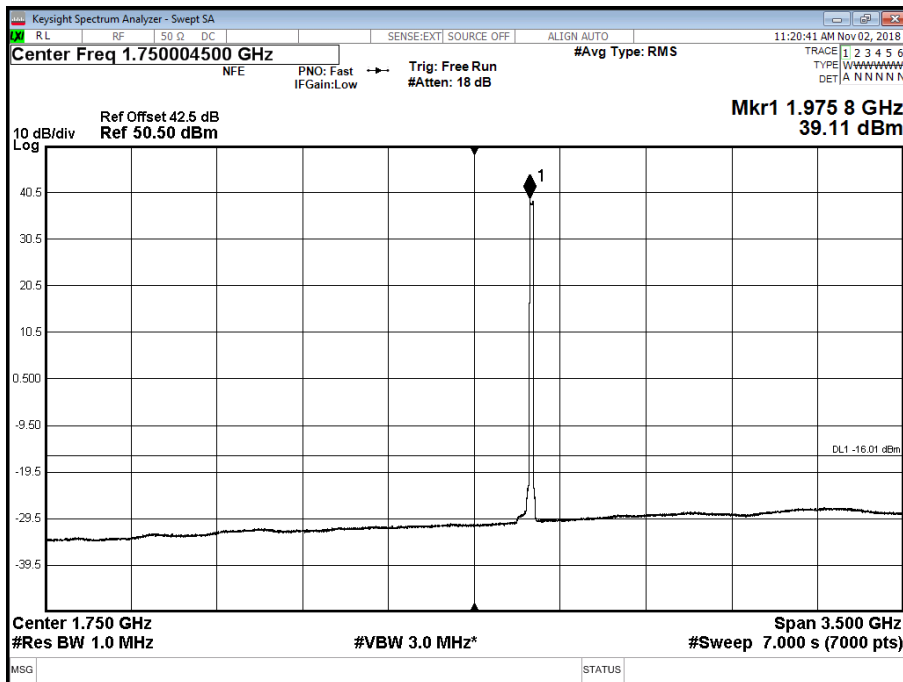





Product Service

Antenna A - LTE Modulation 64QAM - LTE Carrier Bandwidth 15.0 MHz - Channel Position T - Band 2 - Range 3500 to 12000 MHz

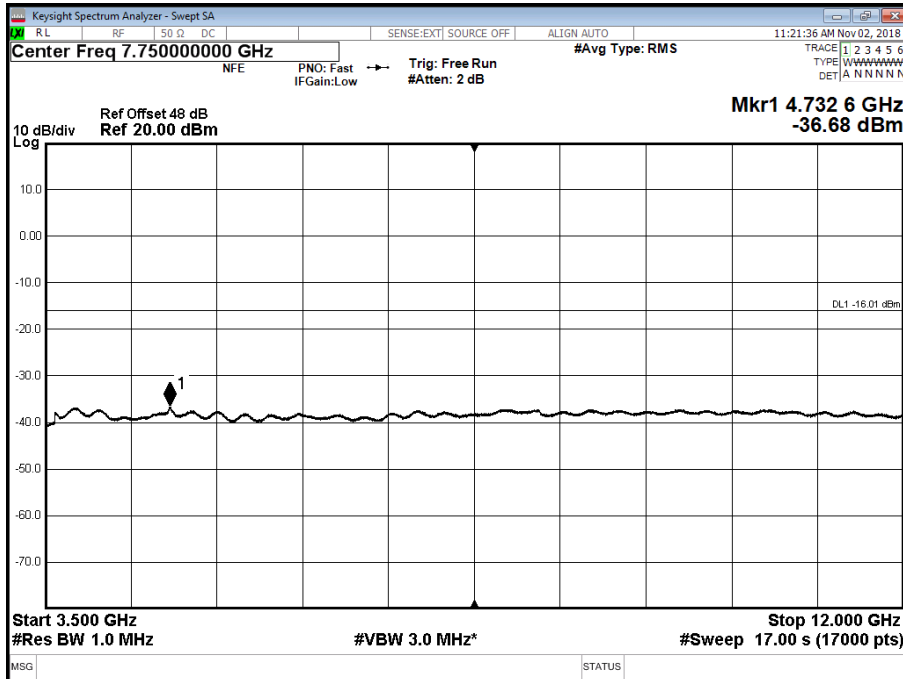

Antenna A - LTE Modulation 64QAM - LTE Carrier Bandwidth 15.0 MHz - Channel Position T - Band 3 - Range 12000 to 18000 MHz

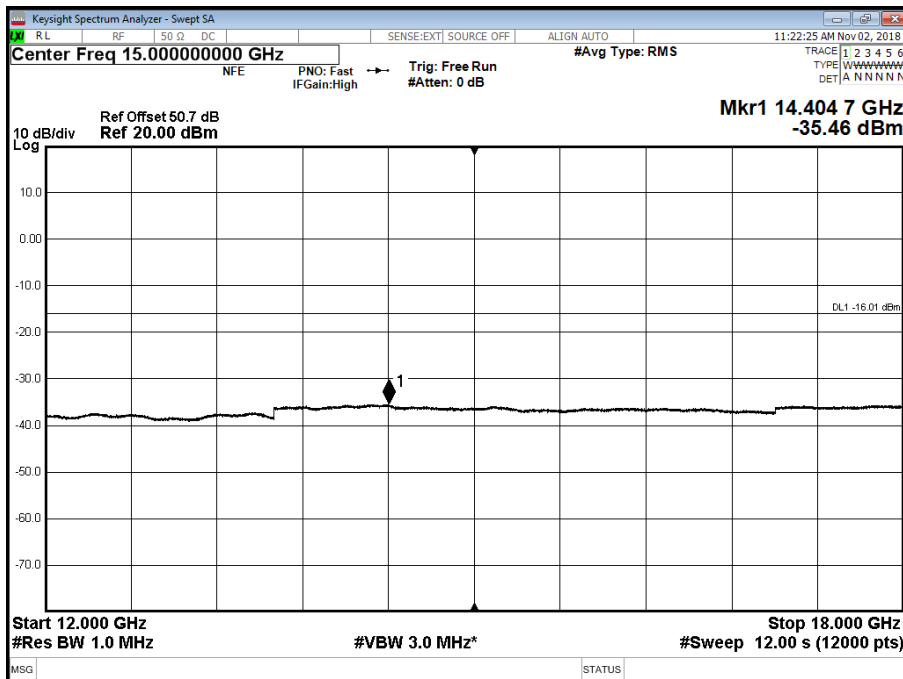



Product Service

Antenna A - LTE Modulation 64QAM - LTE Carrier Bandwidth 15.0 MHz - Channel Position T - Band 4 - Range 18000 to 22000 MHz

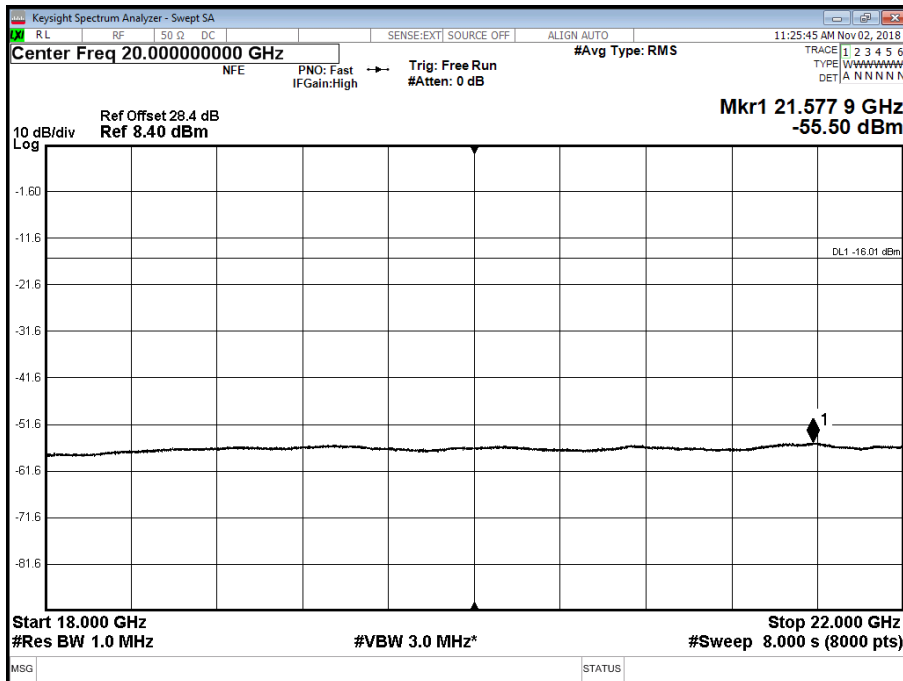

Antenna A - LTE Modulation 64QAM - LTE Carrier Bandwidth 20.0 MHz - Channel Position B - Band 1 - Range 0.009 to 3500 MHz

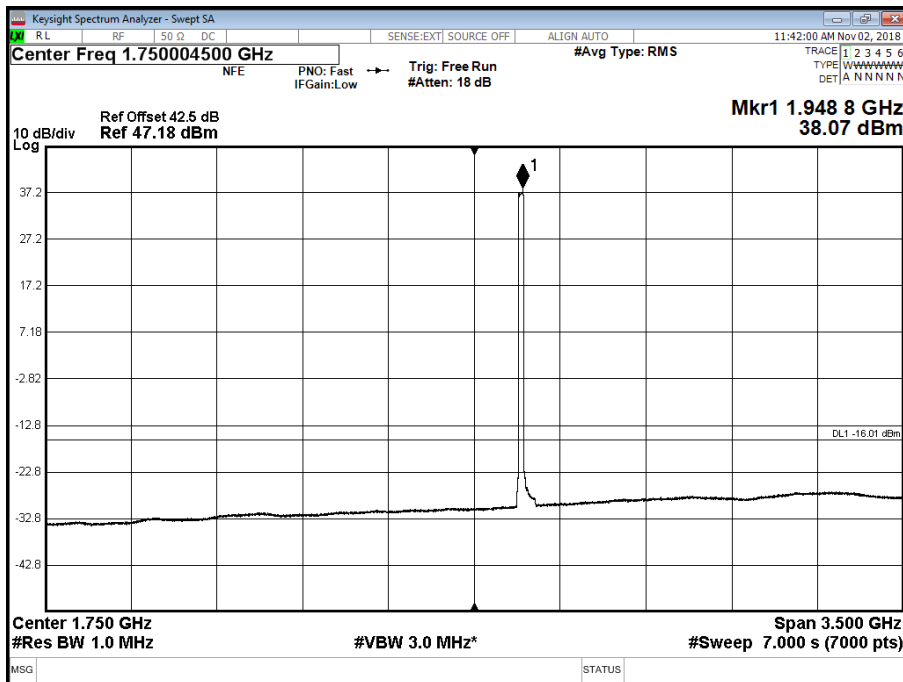



Product Service

Antenna A - LTE Modulation 64QAM - LTE Carrier Bandwidth 20.0 MHz - Channel Position B - Band 2 - Range 3500 to 12000 MHz

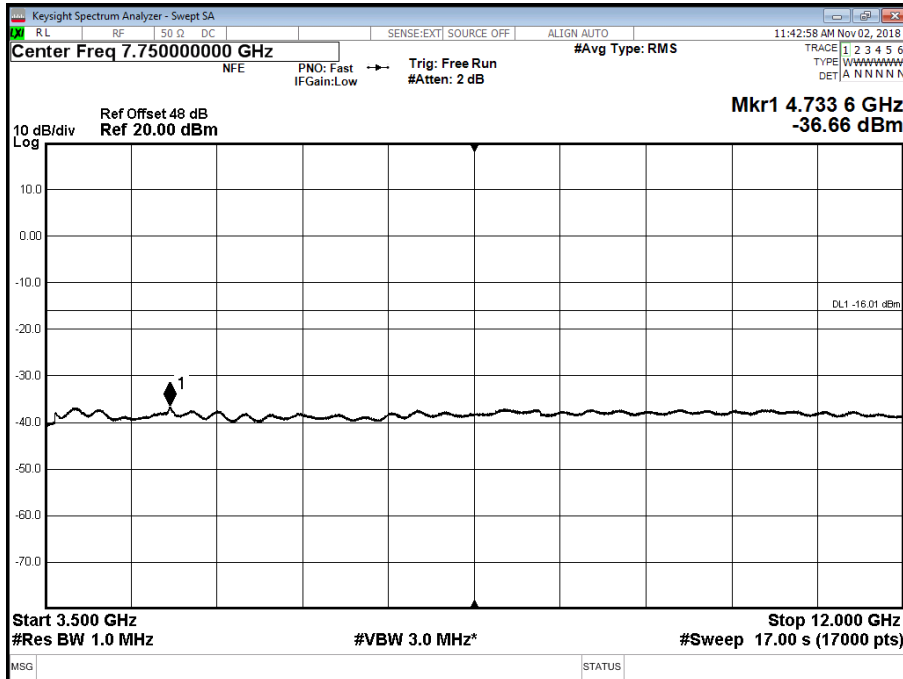

Antenna A - LTE Modulation 64QAM - LTE Carrier Bandwidth 20.0 MHz - Channel Position B - Band 3 - Range 12000 to 18000 MHz

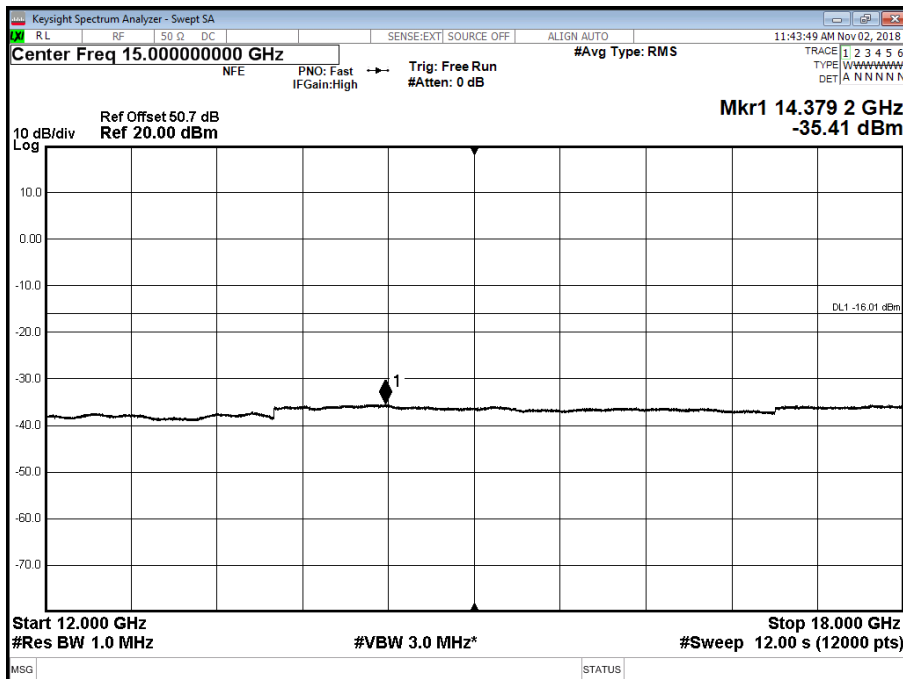



Product Service

Antenna A - LTE Modulation 64QAM - LTE Carrier Bandwidth 20.0 MHz - Channel Position B - Band 4 - Range 18000 to 22000 MHz

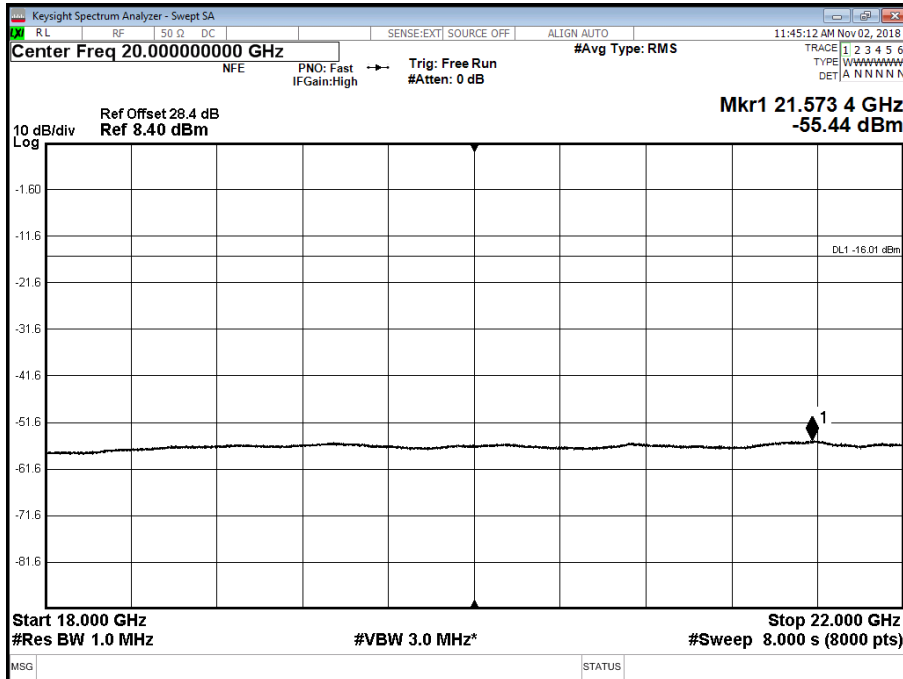

Antenna A - LTE Modulation 64QAM - LTE Carrier Bandwidth 20.0 MHz - Channel Position T - Band 1 - Range 0.009 to 3500 MHz

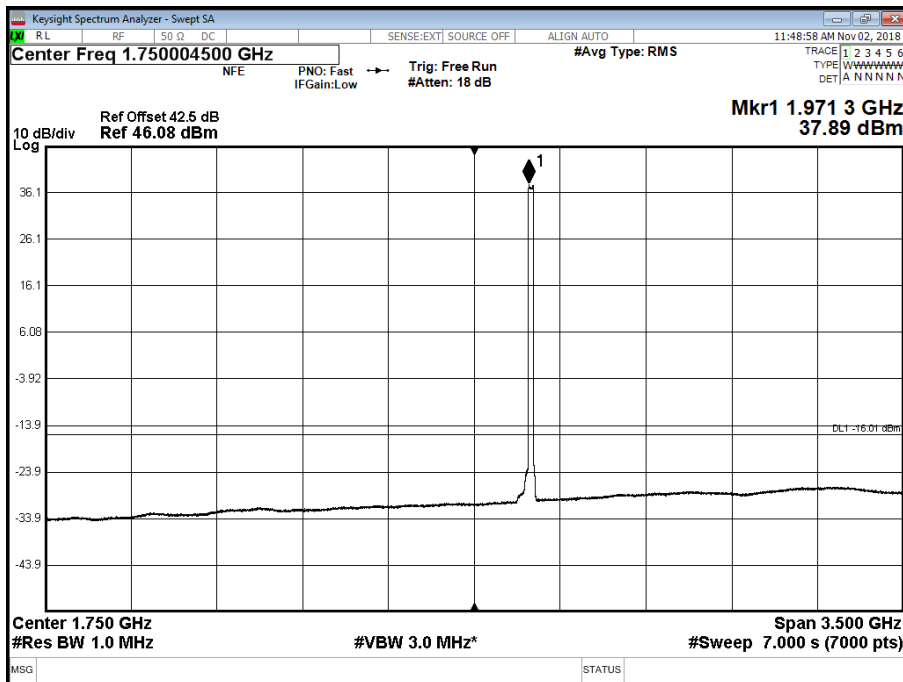



Product Service

Antenna A - LTE Modulation 64QAM - LTE Carrier Bandwidth 20.0 MHz - Channel Position T - Band 2 - Range 3500 to 12000 MHz

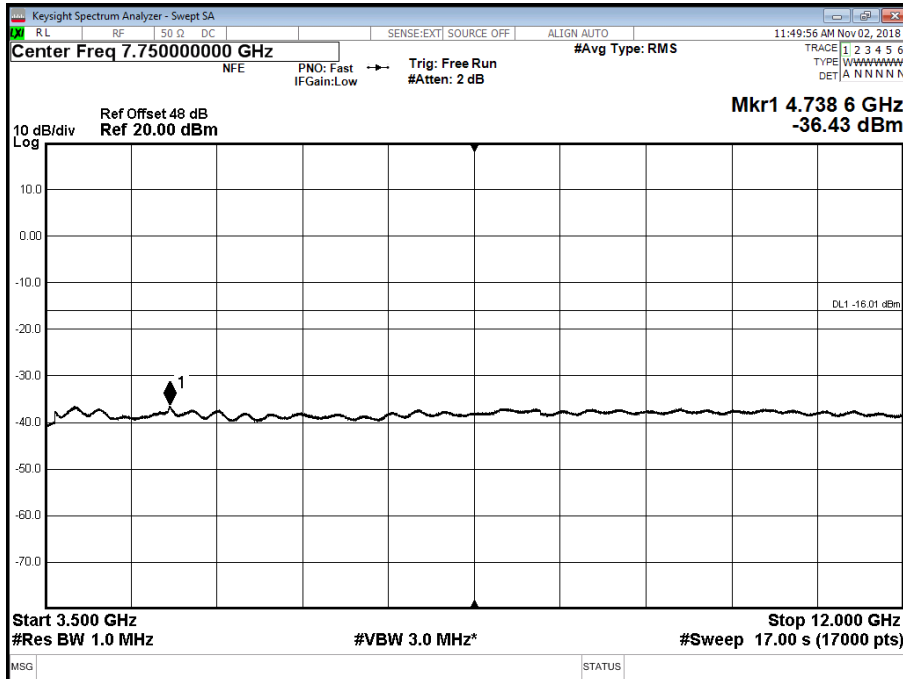

Antenna A - LTE Modulation 64QAM - LTE Carrier Bandwidth 20.0 MHz - Channel Position T - Band 3 - Range 12000 to 18000 MHz

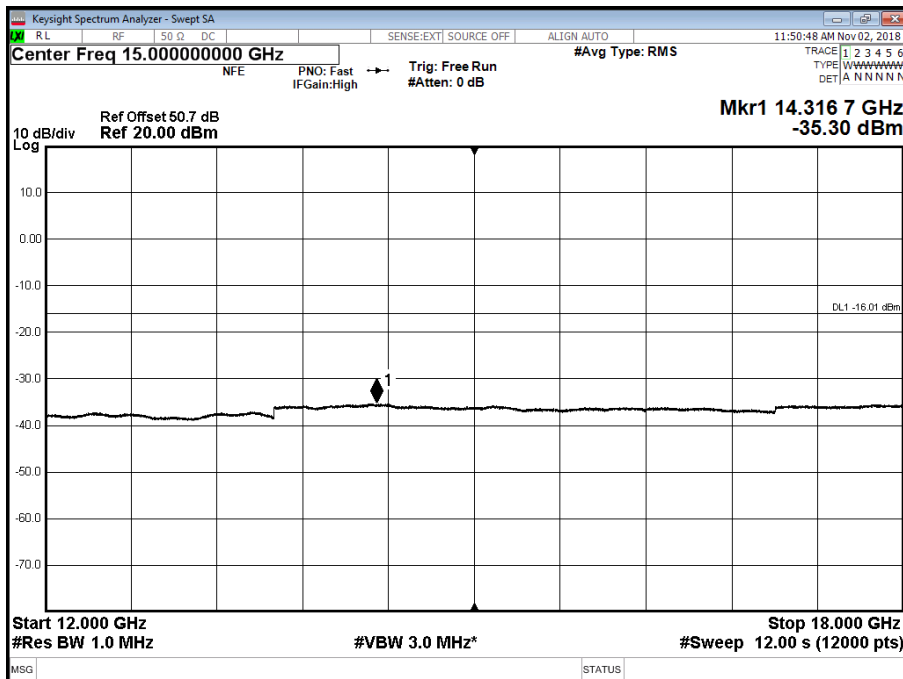



Product Service

Antenna A - LTE Modulation 64QAM - LTE Carrier Bandwidth 20.0 MHz - Channel Position T - Band 4 - Range 18000 to 22000 MHz

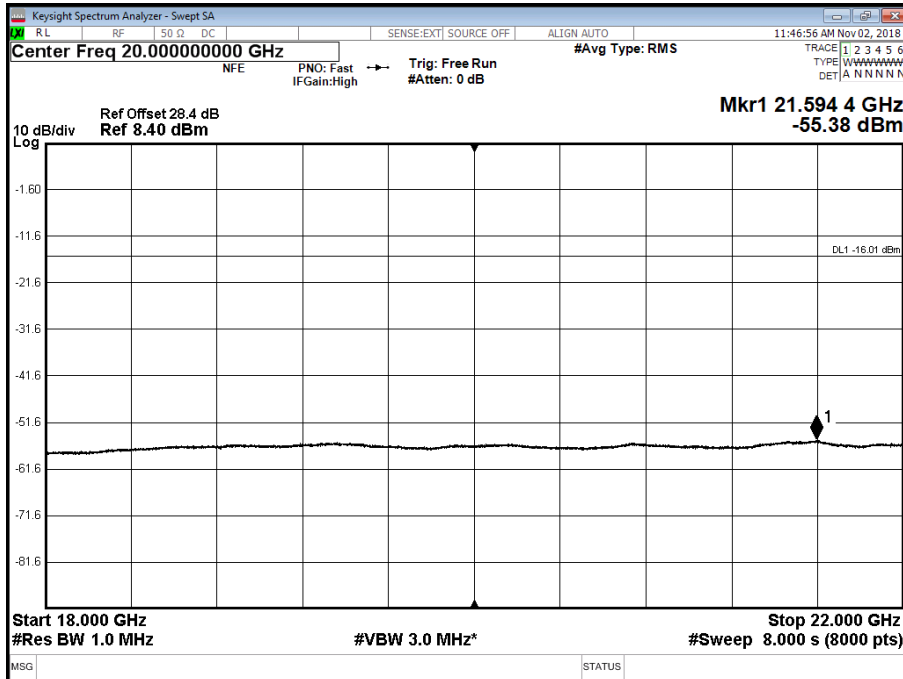

Limit	-16dBm
-------	--------



Product Service

## **2.5 RADIATED EMISSIONS**

### **2.5.1 Specification Reference**

FCC CFR 47 Part 2, Clause 2.1051  
FCC CFR 47 Part 24, Clause 24.238 (a)  
Industry Canada RSS-133, Clause 6.5

### **2.5.2 Date of Test and Modification State**

30 October 2018 - Modification State 0

### **2.5.3 Test Equipment Used**

The major items of test equipment used for the above tests are identified in Section 3.1.

### **2.5.4 Environmental Conditions**

Ambient Temperature	18.7°C
Relative Humidity	36%

### **2.5.5 Test Method**

The test was applied in accordance with test method requirements of ANSI/TIA-603-C-2004.

A preliminary profile of the Spurious Radiated Emissions was obtained by operating the EUT on a remotely controlled turntable within the chamber. Measurements of emissions from the EUT were obtained with the Measurement Antenna in both Horizontal and Vertical Polarisations.

The Applicant declared that the highest internally generated frequency would be up to 2000MHz and so the upper limit for measurement was calculated at 10 times this, which is 20GHz.

Emissions identified within the range 30MHz – 20GHz were then formally measured using a Peak detector as the worst case.

In the frequency Range 30MHz – 1GHz, the measurement was performed with a resolution bandwidth of 100kHz.

In the frequency Range 1GHz – 20GHz, the measurement was performed with a resolution bandwidth of 1MHz.

The measurements were performed at a 3m distance unless otherwise stated.



Product Service

## 2.5.6 Test Results

Configuration A

Maximum Output Power 49 dBm

Antenna A - LTE Modulation 64QAM - LTE Carrier Bandwidth 10.0 MHz - Channel Position B - Band 2 - Range 30 MHz to 1 GHz\_V

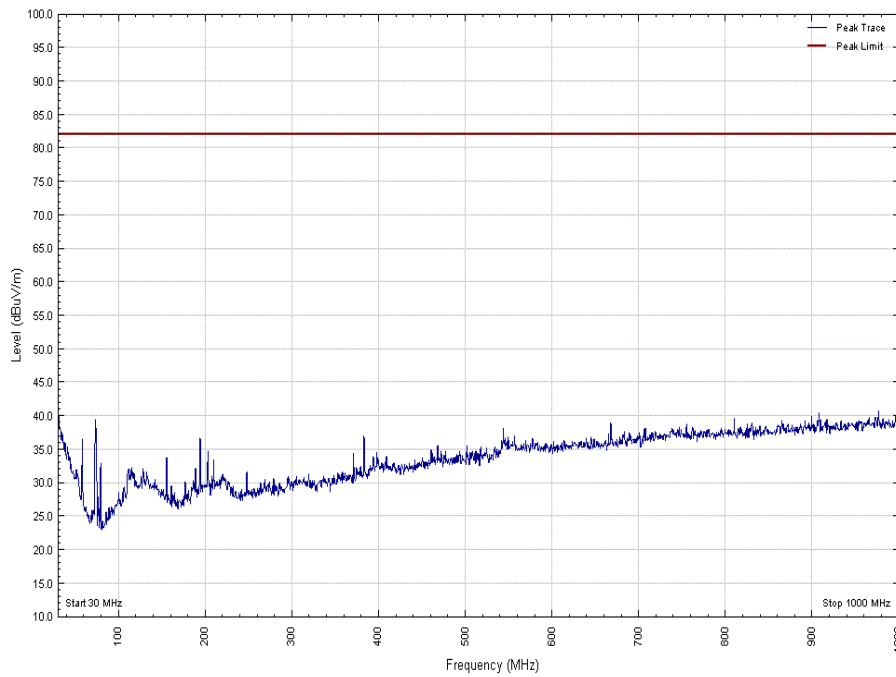





Product Service

Antenna A - LTE Modulation 64QAM - LTE Carrier Bandwidth 10.0 MHz - Channel Position B - Band 2 - Range 30 MHz to 1 GHz\_H

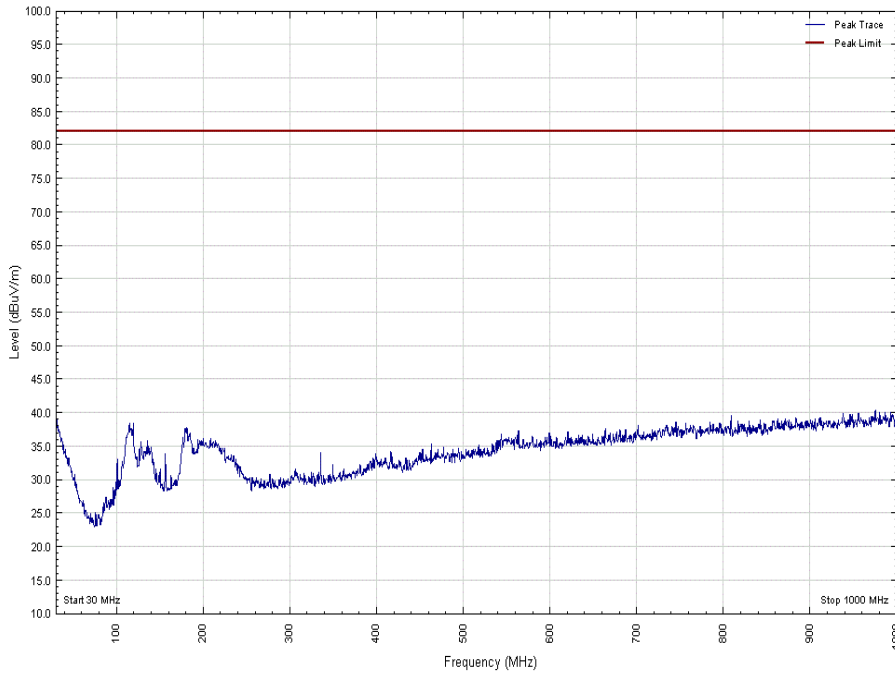

Antenna A - LTE Modulation 64QAM - LTE Carrier Bandwidth 10.0 MHz - Channel Position B - Band 2 - Range 1 GHz to 20 GHz\_V

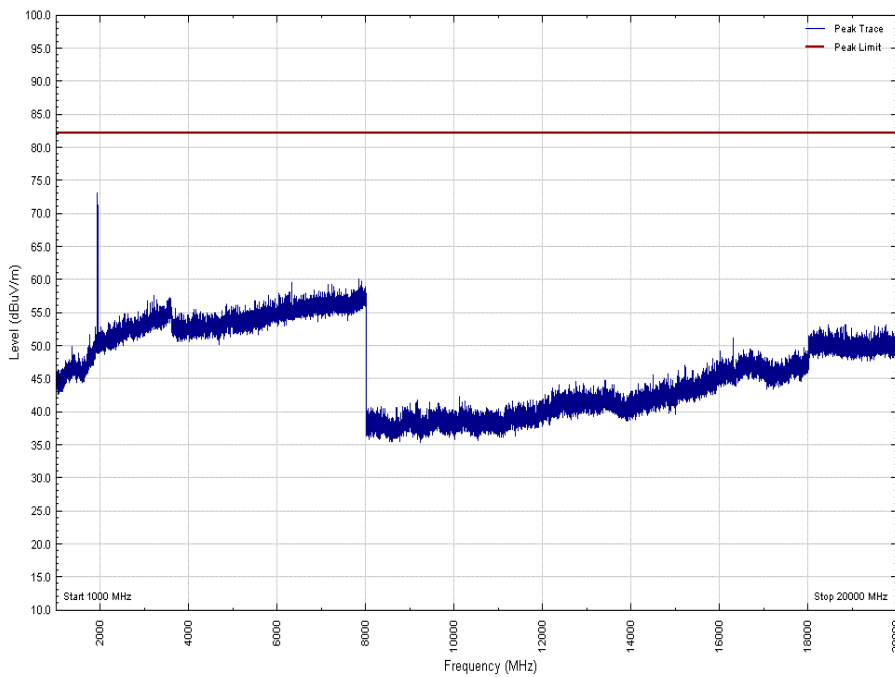



Product Service

Antenna A - LTE Modulation 64QAM - LTE Carrier Bandwidth 10.0 MHz - Channel Position B - Band 2 - Range 1 GHz to 20 GHz\_H

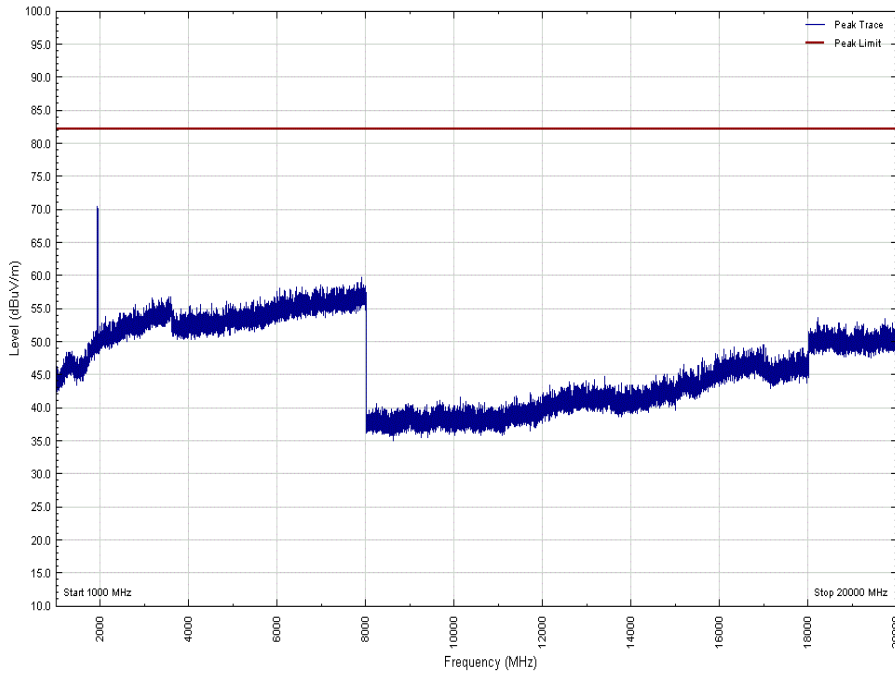

Antenna A - LTE Modulation 64QAM - LTE Carrier Bandwidth 10.0 MHz - Channel Position T - Band 2 - Range 30 MHz to 1 GHz\_V

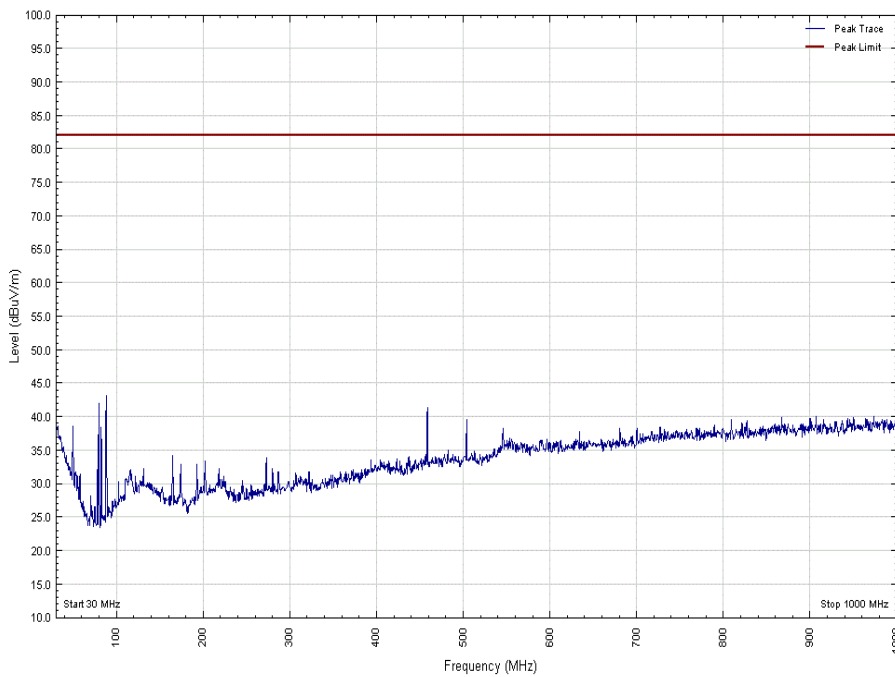



Product Service

Antenna A - LTE Modulation 64QAM - LTE Carrier Bandwidth 10.0 MHz - Channel Position T - Band 2 - Range 30 MHz to 1 GHz\_H

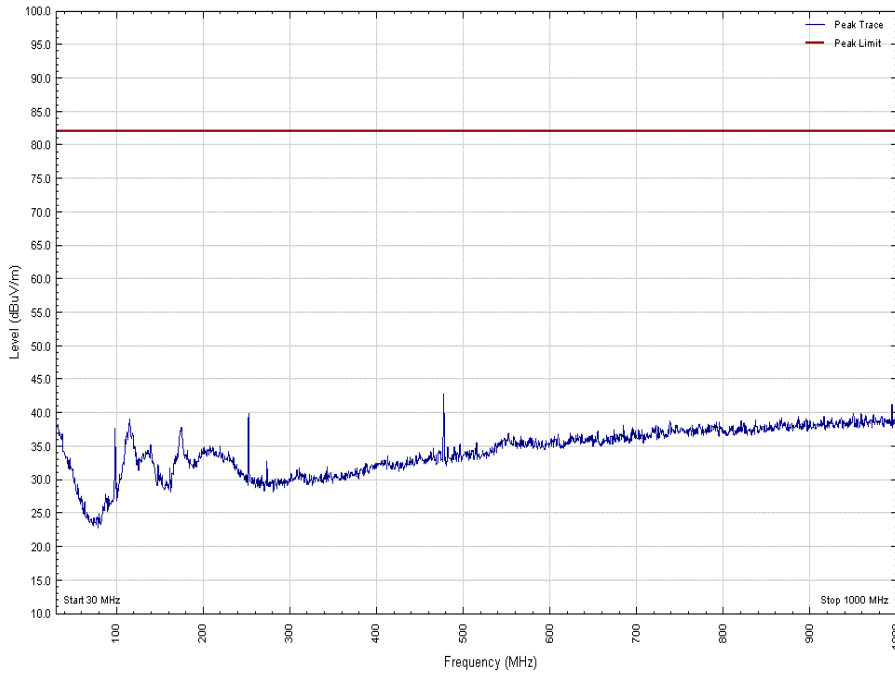

Antenna A - LTE Modulation 64QAM - LTE Carrier Bandwidth 10.0 MHz - Channel Position T - Band 2 - Range 1 GHz to 20 GHz\_V

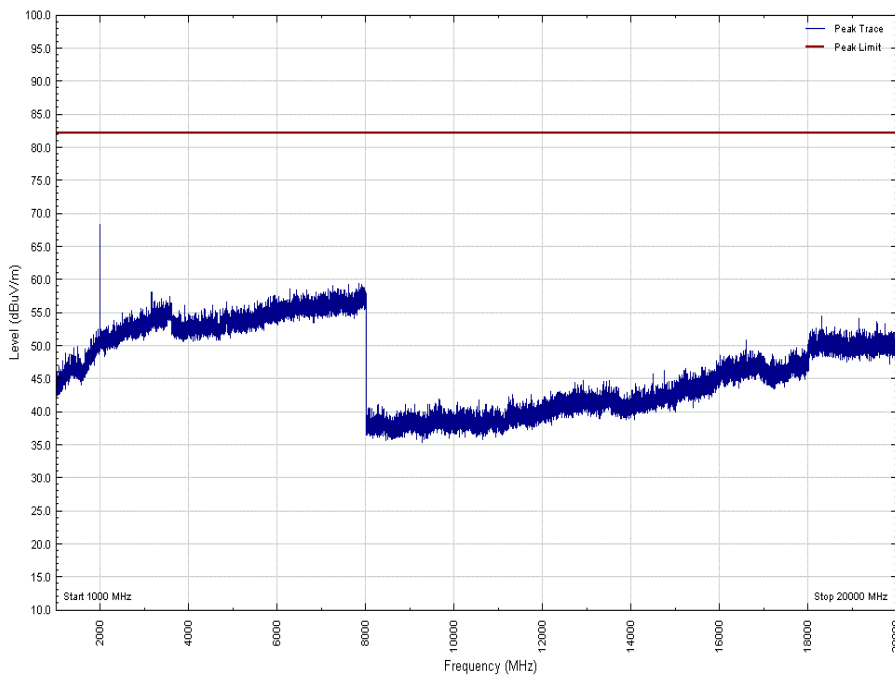



Product Service

Antenna A - LTE Modulation 64QAM - LTE Carrier Bandwidth 10.0 MHz - Channel Position T - Band 2 - Range 1 GHz to 20 GHz\_H

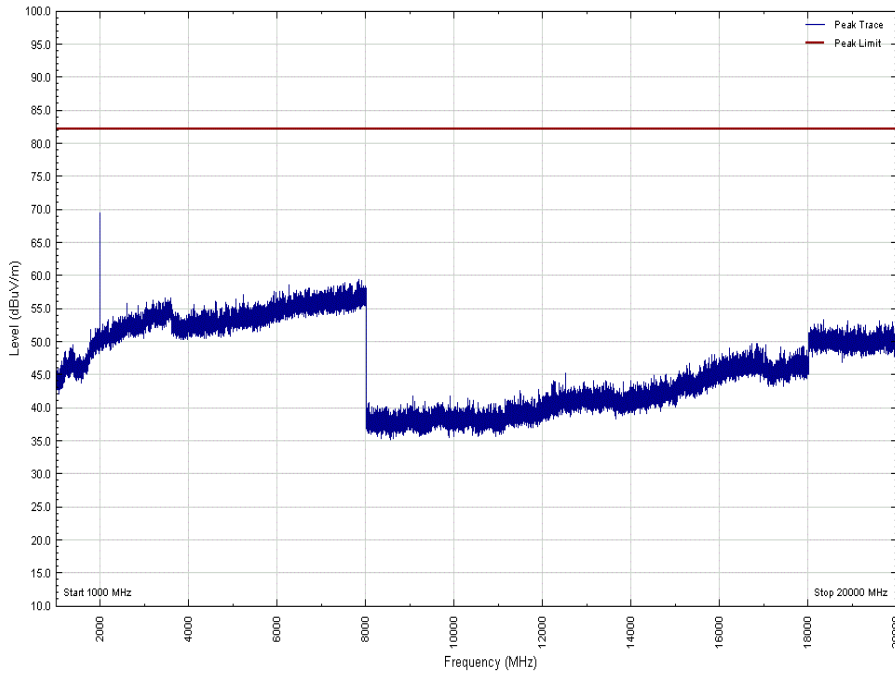

Antenna A - LTE Modulation 64QAM - LTE Carrier Bandwidth 15.0 MHz - Channel Position B - Band 2 - Range 30 MHz to 1 GHz\_V

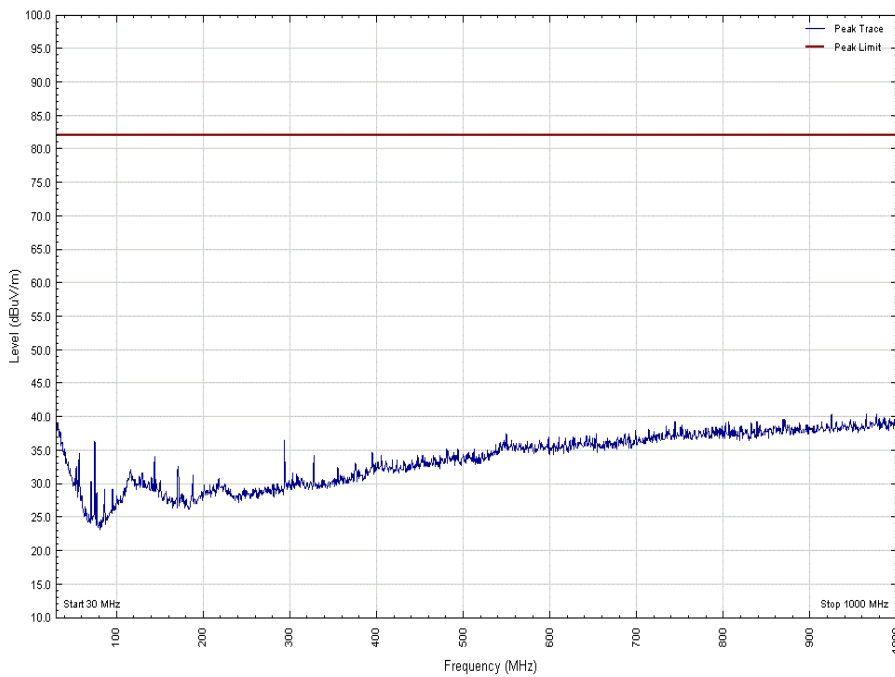



Product Service

Antenna A - LTE Modulation 64QAM - LTE Carrier Bandwidth 15.0 MHz - Channel Position B - Band 2 - Range 30 MHz to 1 GHz\_H

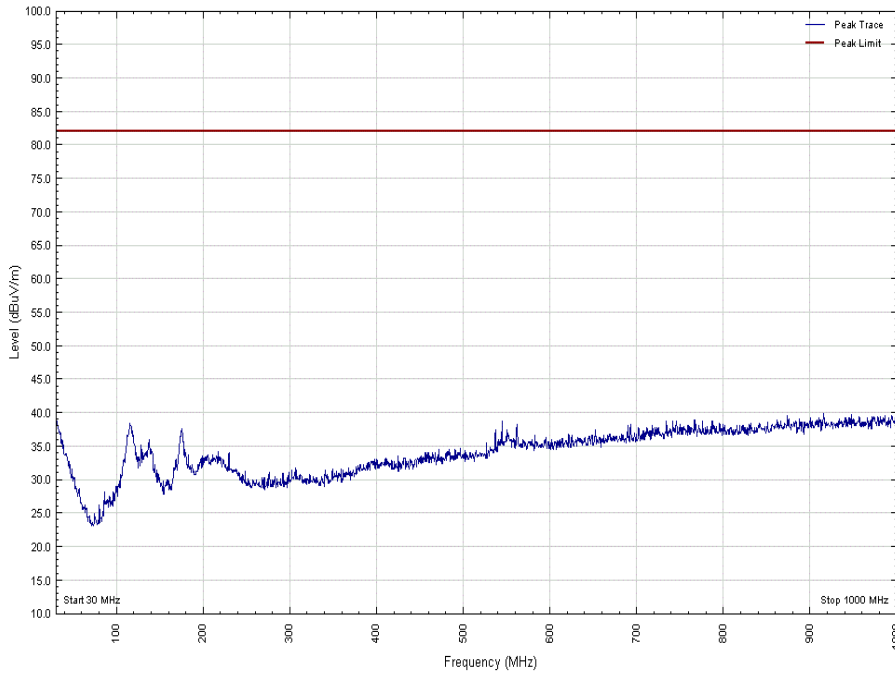

Antenna A - LTE Modulation 64QAM - LTE Carrier Bandwidth 15.0 MHz - Channel Position B - Band 2 - Range 1 GHz to 20 GHz\_V

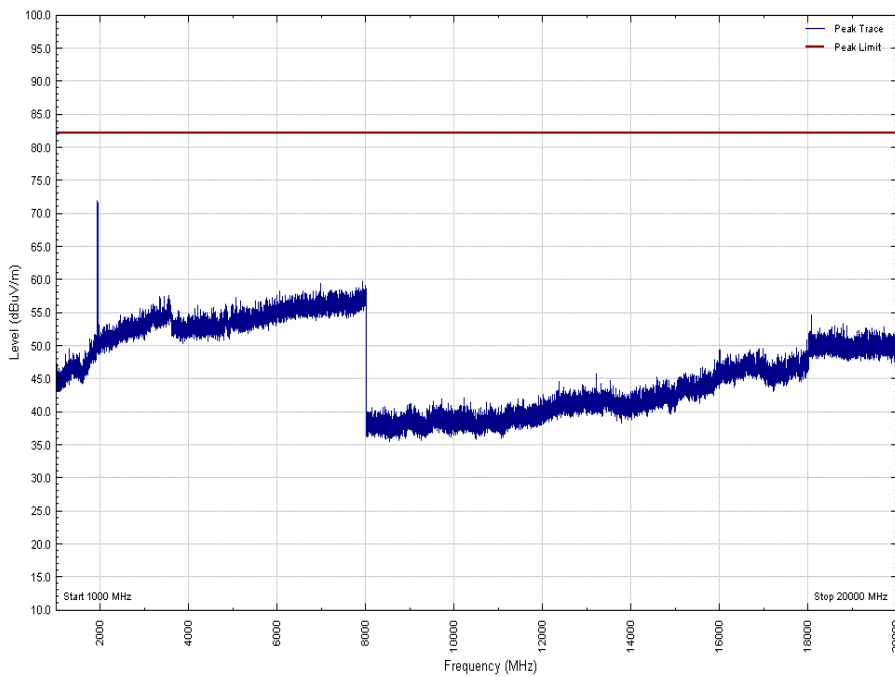



Product Service

Antenna A - LTE Modulation 64QAM - LTE Carrier Bandwidth 15.0 MHz - Channel Position B - Band 2 - Range 1 GHz to 20 GHz\_H

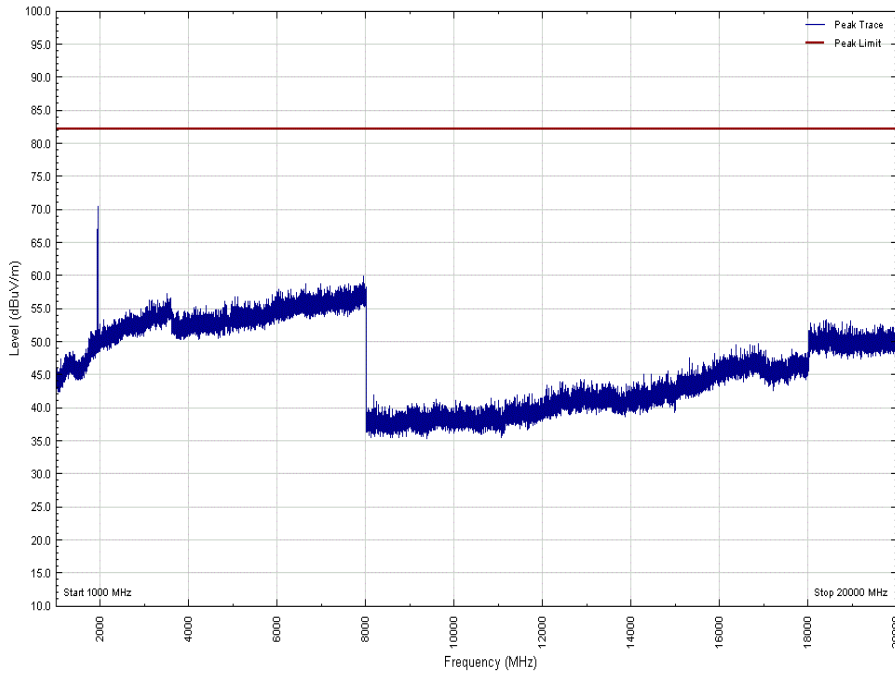

Antenna A - LTE Modulation 64QAM - LTE Carrier Bandwidth 15.0 MHz - Channel Position T - Band 2 - Range 30 MHz to 1 GHz\_V

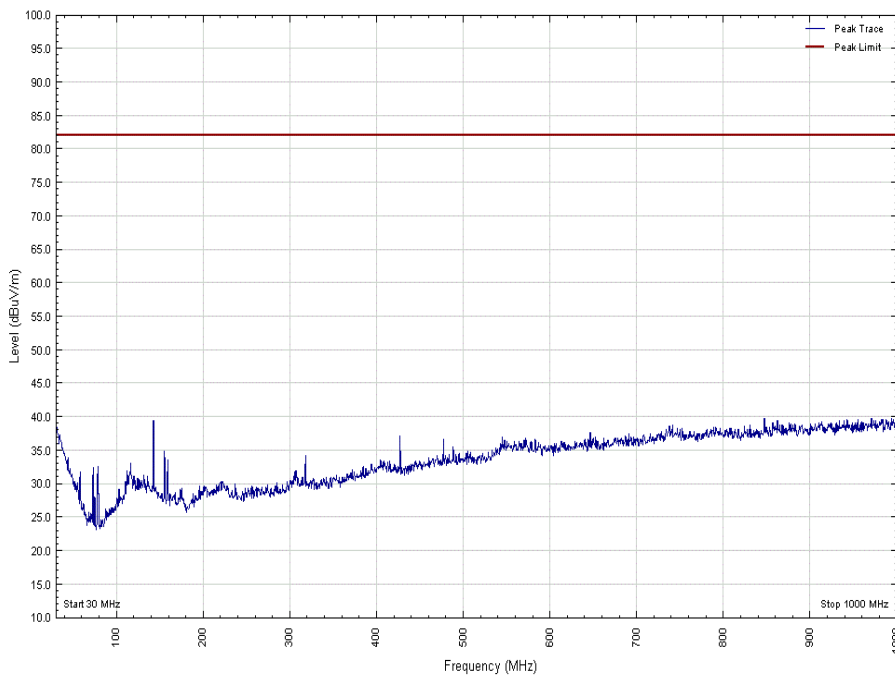



Product Service

Antenna A - LTE Modulation 64QAM - LTE Carrier Bandwidth 15.0 MHz - Channel Position T - Band 2 - Range 30 MHz to 1 GHz\_H

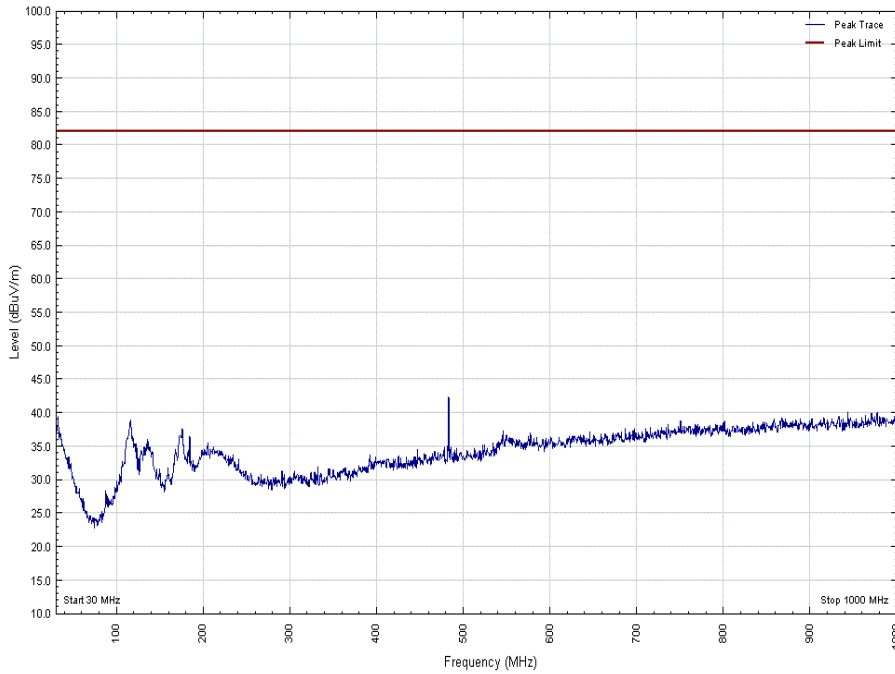

Antenna A - LTE Modulation 64QAM - LTE Carrier Bandwidth 15.0 MHz - Channel Position T - Band 2 - Range 1 GHz to 20 GHz\_V

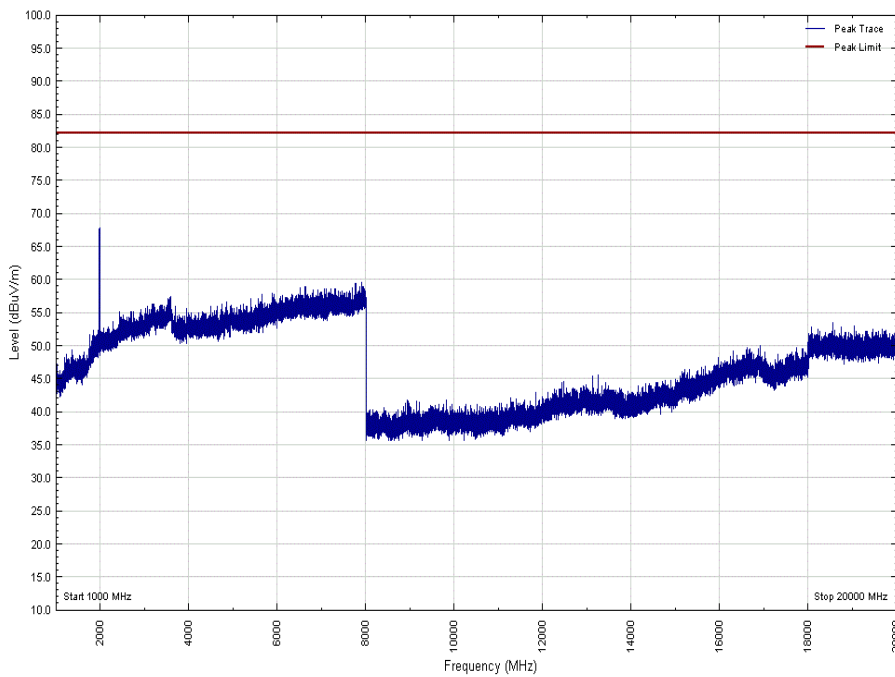



Product Service

Antenna A - LTE Modulation 64QAM - LTE Carrier Bandwidth 15.0 MHz - Channel Position T - Band 2 - Range 1 GHz to 20 GHz\_H

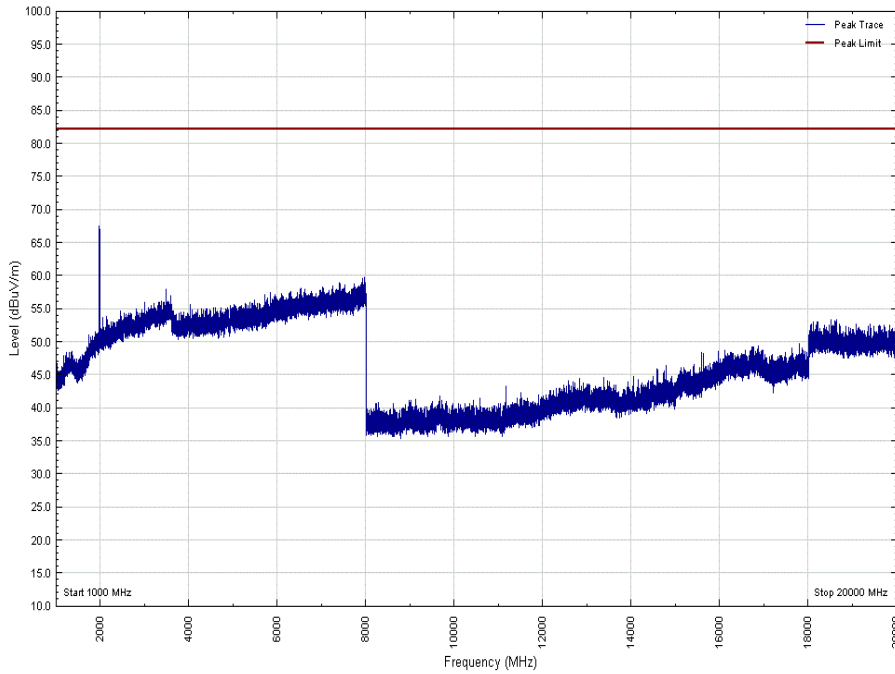

Antenna A - LTE Modulation 64QAM - LTE Carrier Bandwidth 20.0 MHz - Channel Position B - Band 2 - Range 30 MHz to 1 GHz\_V

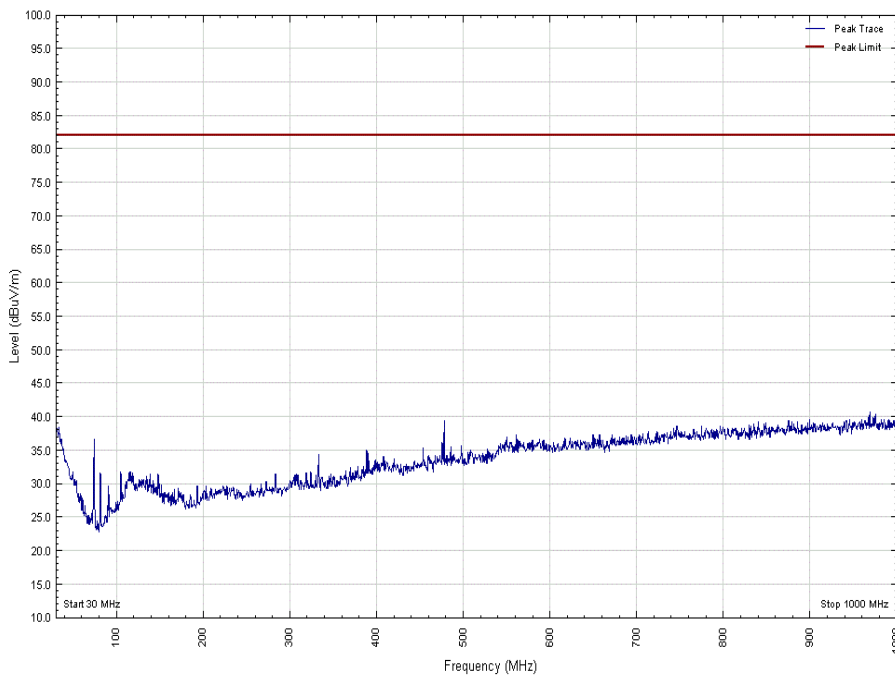





Product Service

Antenna A - LTE Modulation 64QAM - LTE Carrier Bandwidth 20.0 MHz - Channel Position B - Band 2 - Range 30 MHz to 1 GHz\_H

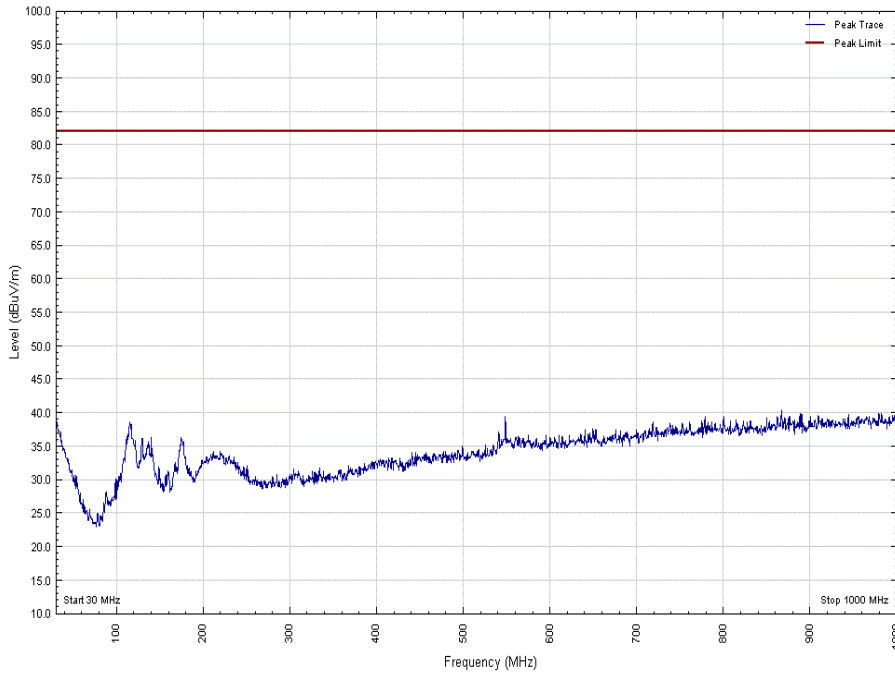

Antenna A - LTE Modulation 64QAM - LTE Carrier Bandwidth 20.0 MHz - Channel Position B - Band 2 - Range 1 GHz to 20 GHz\_V

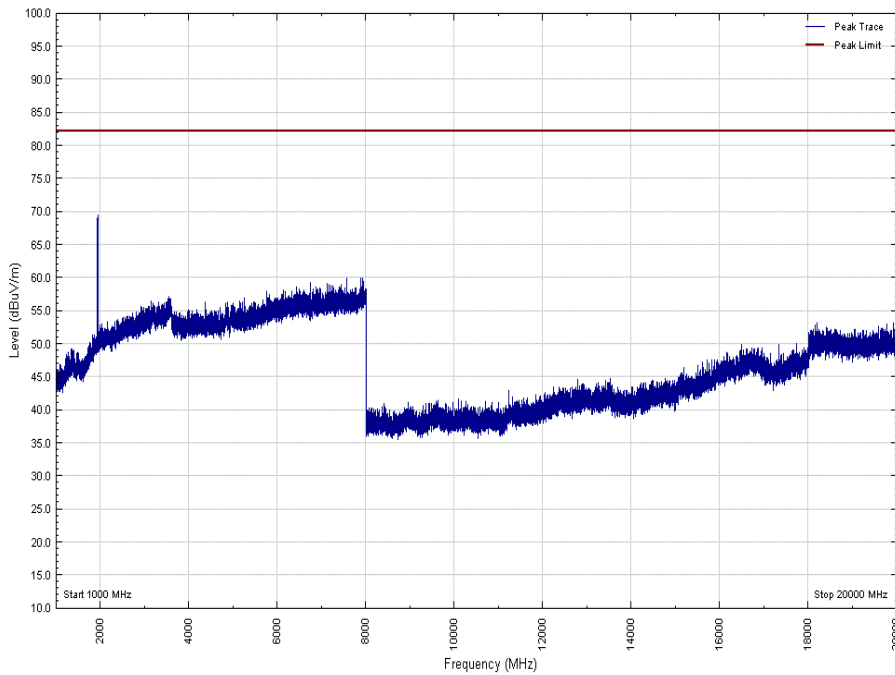



Product Service

Antenna A - LTE Modulation 64QAM - LTE Carrier Bandwidth 20.0 MHz - Channel Position B - Band 2 - Range 1 GHz to 20 GHz\_H

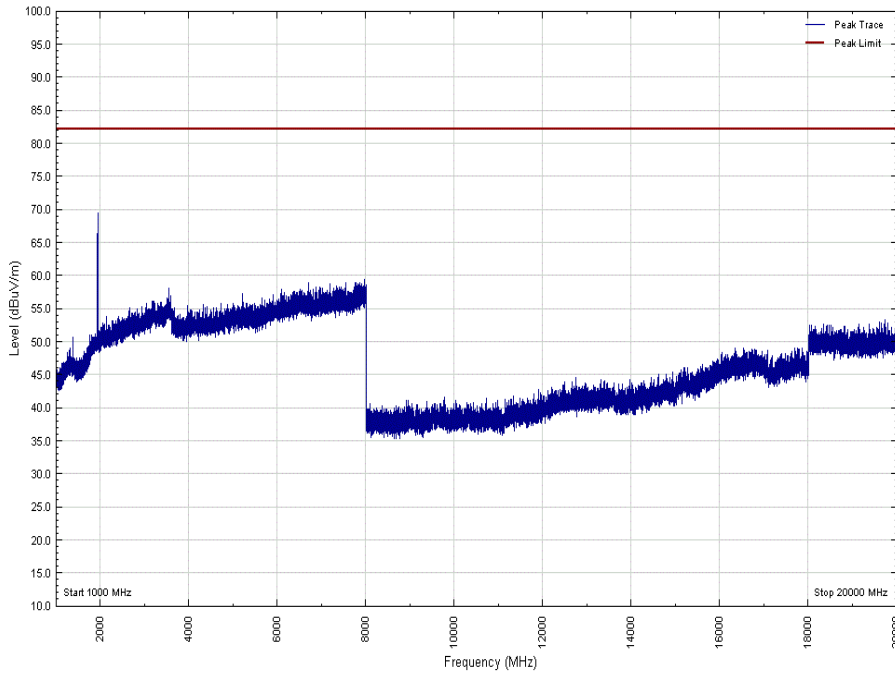

Antenna A - LTE Modulation 64QAM - LTE Carrier Bandwidth 20.0 MHz - Channel Position T - Band 2 - Range 30 MHz to 1 GHz\_V

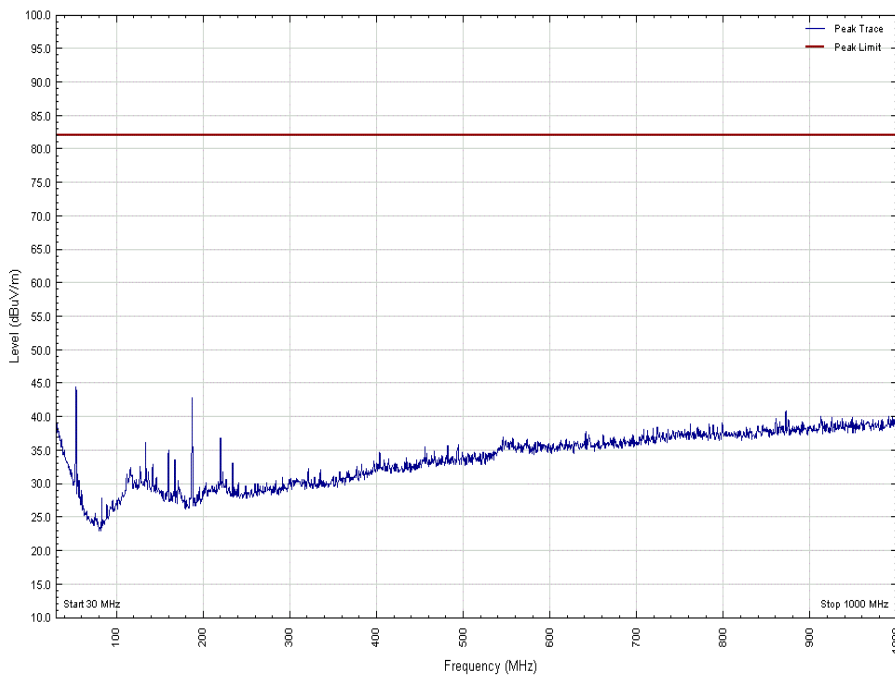



Product Service

Antenna A - LTE Modulation 64QAM - LTE Carrier Bandwidth 20.0 MHz - Channel Position T - Band 2 - Range 30 MHz to 1 GHz\_H

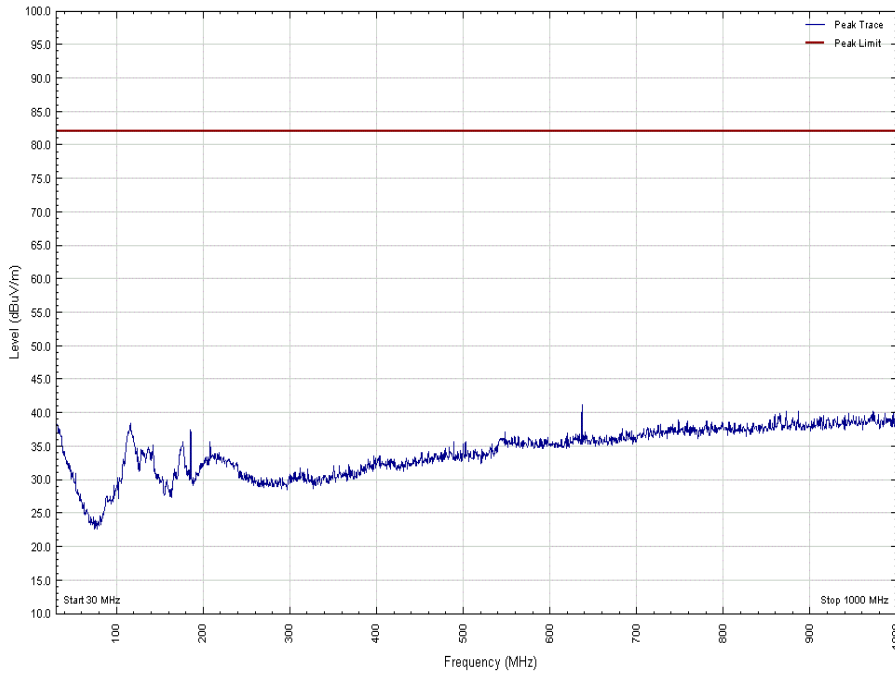

Antenna A - LTE Modulation 64QAM - LTE Carrier Bandwidth 20.0 MHz - Channel Position T - Band 2 - Range 1 GHz to 20 GHz\_V

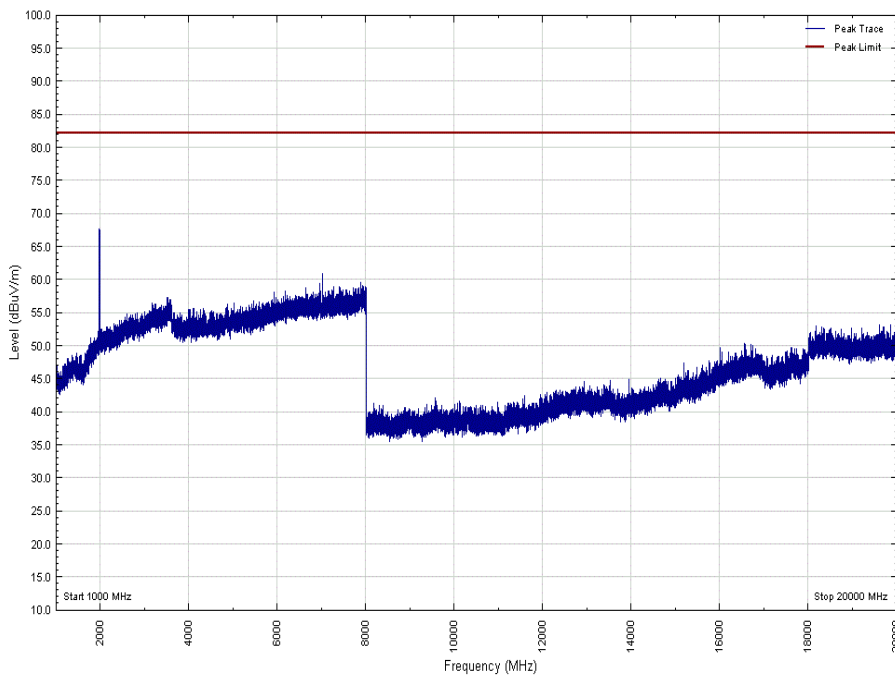



Product Service

Antenna A - LTE Modulation 64QAM - LTE Carrier Bandwidth 20.0 MHz - Channel Position T - Band 2 - Range 1 GHZ to 20 GHz\_H

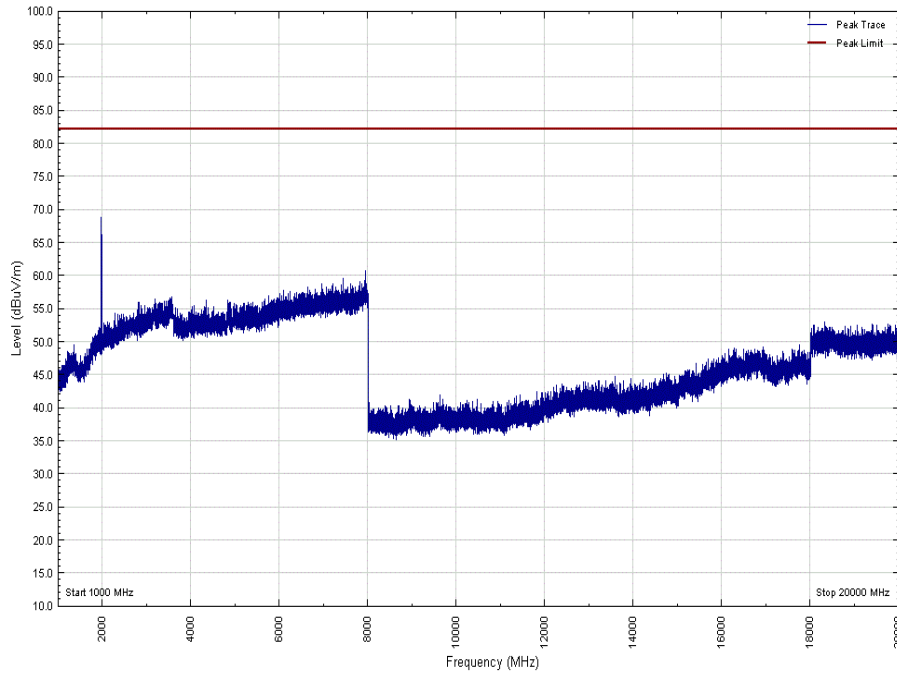

Limit	82.2dBuV/m
-------	------------



Product Service

## **SECTION 3**

### **TEST EQUIPMENT USED**



### 3.1 TEST EQUIPMENT USED

List of absolute measuring and other principal items of test equipment.

Instrument	Manufacturer	Type No.	TE No.	Calibration Period (months)	Calibration Due
<b>Maximum Peak Output Power and Peak to Average Ratio - Conducted</b>					
Hygrometer	Rotronic	A1	2138	12	21-Feb-2019
Signal Analyser	N9030A	Keysight	4653	12	05-Feb-2019
PSU	Farnell	H60/25	1092	-	OP Mon
DMM	Fluke	179	4006	12	13-Dec-2018
Attenuator	Weinschel	48-10-43	4868	12	01-Nov-2018
Attenuator	Weinschel	48-30-43	4871	12	17-Jul-2019
Attenuator	Weinschel	48-10-43	3593	12	16-Jul-2019
Network Analyser	R&S	ZVA 40	*3548	12	02-Oct-2018
Calibration unit	R&S	ZV Z54	4368	12	06-Mar-2019
<b>Occupied Bandwidth</b>					
Hygrometer	Rotronic	A1	2138	12	21-Feb-2019
Signal Analyser	N9030A	Keysight	4653	12	05-Feb-2019
PSU	Farnell	H60/25	1092	-	OP Mon
DMM	Fluke	179	4006	12	13-Dec-2018
Attenuator	Weinschel	48-10-43	4868	12	01-Nov-2018
Attenuator	Weinschel	48-30-43	4871	12	17-Jul-2019
Attenuator	Weinschel	48-10-43	3593	12	16-Jul-2019
Network Analyser	R&S	ZVA 40	*3548	12	02-Oct-2018
Calibration unit	R&S	ZV Z54	4368	12	06-Mar-2019
<b>Band Edge</b>					
Hygrometer	Rotronic	A1	2138	12	21-Feb-2019
Signal Analyser	N9030A	Keysight	4653	12	05-Feb-2019
PSU	Farnell	H60/25	1092	-	OP Mon
DMM	Fluke	179	4006	12	13-Dec-2018
Attenuator	Weinschel	48-10-43	4868	12	01-Nov-2018
Attenuator	Weinschel	48-30-43	4871	12	17-Jul-2019
Attenuator	Weinschel	48-10-43	3593	12	16-Jul-2019
Network Analyser	R&S	ZVA 40	*3548	12	02-Oct-2018
Calibration unit	R&S	ZV Z54	4368	12	06-Mar-2019
<b>Transmitter Spurious Emissions</b>					
Hygrometer	Rotronic	A1	2138	12	21-Feb-2019
Signal Analyser	N9030A	Keysight	4653	12	05-Feb-2019
PSU	Farnell	H60/25	1092	-	OP Mon
DMM	Fluke	179	4006	12	13-Dec-2018
Attenuator	Weinschel	48-10-43	4868	12	01-Nov-2018
Attenuator	Weinschel	48-30-43	4871	12	17-Jul-2019
Attenuator	Weinschel	48-10-43	3593	12	16-Jul-2019
WaveGudde	FMI UK	18-26GHz	-	-	OP Mon
HPF	RLC electronics	F-100-3000-5-R	3349	-	OP Mon



Product Service

Instrument	Manufacturer	Type No.	TE No.	Calibration Period (months)	Calibration Due
Network Analyser	R&S	ZVA 40	*3548	12	02-Oct-2018
Calibration unit	R&S	ZV Z54	4368	12	06-Mar-2019
Radiated Emissions					
Antenna 18-40GHz (Double Ridge Guide)	Link Microtek Ltd	AM180HA-K-TU2	230	24	02-May-2020
Pre-Amplifier	Phase One	PS04-0086	1533	12	12-Jan-2019
18GHz - 40GHz Pre-Amplifier	Phase One	PSO4-0087	1534	12	02-Feb-2019
Screened Room (5)	Rainford	Rainford	1545	36	23-Jan-2021
Turntable Controller	Inn-Co GmbH	CO 1000	1606	-	TU
Multimeter	Iso-tech	IDM101	2419	12	23-Nov-2018
Antenna with permanent attenuator (Bilog)	Chase	CBL6143	2904	24	08-Aug-2019
1501A 4.0M Km Km Cable	Rhophase	KPS-1501A-4000-KPS	4301	12	19-Feb-2019
1 metre K-Type Cable	Florida Labs	KMS-180SP-39.4-KMS	4520	12	13-Feb-2019
EMI Receiver	Keysight Technologies	N9038A MXE	4628	12	04-Jul-2019
Double Ridged Waveguide Horn Antenna	ETS-Lindgren	3117	4722	12	01-Mar-2019
Mast Controller	Maturo GmbH	NCD	4810	-	TU
Tilt Antenna Mast	Maturo GmbH	TAM 4.0-P	4811	-	TU
9m N type RF cable	Rosenberger	2303-0 9.0m PNm PNm	4827	6	04-Jan-2019
4dB Attenuator	Pasternack	PE7047-4	4935	12	28-Nov-2018
Hygrometer	Rotronic	HP21	4989	12	26-Apr-2019
EmX Software	TUV SUD Product Service	EmX V.1.3.21	5125	-	N/A - Software
1.5m 40GHz RF Cable	Scott Cables	KPS-1501-2000-KPS	5126	6	26-Apr-2019

N/A – Not Applicable

O/P Mon – Output Monitored with Calibrated Equipment

TU – Traceability Unscheduled

\* - This Network Analyser was only used to perform Calibrations prior to 02-Oct-2018.



Product Service

### 3.2 MEASUREMENT UNCERTAINTY

For a 95% confidence level, the measurement uncertainties for defined systems are:-

Test Discipline	Frequency / Parameter	MU
Conducted Maximum Peak Output Power	30 MHz to 20 GHz Amplitude	± 0.1 dB
Conducted Emissions	30 MHz to 20 GHz Amplitude	± 2.3 dB
Frequency Stability	30 MHz to 2 GHz	± 5.0 Hz
Occupied Bandwidth	Up to 20 MHz Bandwidth	± 1.1 Hz
Band Edge	30 MHz to 20 GHz Amplitude	± 2.3 dB
Radiated Emissions, Bilog Antenna, AOATS	30MHz to 1GHz Amplitude	5.1dB*
Radiated Emissions, Horn Antenna, AOATS	1GHz to 40GHz Amplitude	6.3dB*
Worst case error for both Time and Frequency measurement 12 parts in 10 <sup>6</sup>		





Product Service

## **SECTION 5**

### **ACCREDITATION, DISCLAIMERS AND COPYRIGHT**



Product Service

#### 4.1 ACCREDITATION, DISCLAIMERS AND COPYRIGHT



This report relates only to the actual item/items tested.

Our UKAS Accreditation does not cover opinions and interpretations and any expressed are outside the scope of our UKAS Accreditation.

Results of tests not covered by our UKAS Accreditation Schedule are marked NUA (Not UKAS Accredited).

© 2019 TÜV SÜD Product Service



Product Service

## **ANNEX A**

### **MODULE LIST**



Product Service

Configuration A			
Product	Product No	R-State	Serial No
Radio 2212 B2 B25	KRC 161 688/3	R1B	D826860358
Software Version:	CXP9013268/15	Revision:	R73AM