

Wi-Jack DUO Installation Guide



DRAFT

Copyright © 2006 Ortronics, Inc. All rights reserved.

Specifications in this manual are subject to change without notice.

Originated in the USA.

Trademarks

Any other trademarks appearing in this manual are owned by their respective companies.

DRAFT

Contents

	Wi-Jack DUO Installation Guide	i
<i>Chapter 1</i>	Introduction	1
	Front View	2
	Overview of Ortronics AP Setup Process	4
<i>Chapter 2</i>	Provisioning Access Points	5
	Discovery Protocol	6
	AP Reprovisioning	7
	AP Provisioning	8
	Manual Provisioning	12
	Connecting the Console Terminal	12
<i>Chapter 3</i>	AP Deployment	13
	Mounting the Ortronics Wi-Jack DUO	13
	Connecting Required Cables	13
	Selecting Horizontal Cable	13
<i>Appendix A</i>	Cables	17
	“To AP” Specifications	17
	“To Network” Specifications	17
<i>Appendix B</i>	Troubleshooting	19
	Accessing the AP Support Prompt	19
	Direct SPOE Connection to Wireless Controller	19
	Direct Terminal Connection	20
	Remote Telnet Connection	21
	AP Support	22
	Access Levels	22
	User Commands	22
	Privileged Commands	22
<i>Appendix C</i>	Product Specifications	23
	Compliance	23
	Certifications	24

Product Features	25
Ethernet Compatibility	25
Radio Characteristics	25
Power over Ethernet	26
Physical Description	26
Package Contents	26
Optional Items	26
Related Documents	30
Text Conventions	31
Contacting Ortronics	32
Notes	51
Notes	52

DRAFT

CHAPTER 1

Introduction

The Ortronics Wi-Jack DUO™ is part of a comprehensive wireless network solution. The device works in conjunction with the Ortronics Wireless Controller and can act as a wireless access point or air monitor.

As a wireless Access Point (AP), the Ortronics Wi-Jack DUO provides transparent, secure, high-speed data communications between wireless network devices (fixed, portable, or mobile computers with IEEE 802.11a and IEEE 802.11b/g wireless adapters) and the wired LAN.

As a wireless Air Monitor (AM), the Ortronics Wi-Jack DUO enhances wireless networks by collecting statistics, monitoring traffic, detecting intrusions, enforcing security policies, balancing wireless traffic load, self-healing coverage gaps, and more.

Front View



FIGURE 1-1 Ortronics Wi-Jack DUO

1. Air Vents

These vents promote proper air circulation for cooling the device. Do not allow these vents to be obstructed by mounting equipment, network cables, or any other material.

2. Designation Labels

3. User Port

This port attaches the Ortronics Wi-Jack DUO to a 10Base-T/100Base-TX (twisted-pair) Ethernet LAN segment. This port supports wired users to gain access to the WLAN.

See Appendix A.

4. Serial Number & MAC Address

5. Backhaul Plug

An Ortronics Keystone Jack is provided for installation/integration of Wi-Jack DUO into the LAN. See Chapter 3 for Details.

6. Internal Antennas for Wireless Communication

Overview of Ortronics AP Setup Process

Setting up an Ortronics AP typically consists of four stages:

- 1 WLAN Planning—The administrator determines how many Ortronics APs will be needed for their wireless network strategy and where they will be deployed. This can be easily accomplished using Ortronics' automated RF Plan site-survey software (available separately as part of the Ortronics Wireless Controller).
- 2 AP Provisioning—Provisioning provides each Ortronics AP with initial settings that allow it to locate the host Ortronics Wireless Controller. Depending on the network topology and services, AP provisioning can be performed manually for each AP or plug-and-play for batches of APs.
AP provisioning is discussed in 5.
- 3 AP Deployment—Once provisioned, the AP can be physically installed at its intended place of operation.
AP deployment is covered in 13.
- 4 AP Configuration—The administrator defines the operational behavior for each Ortronics AP, such as RF characteristics and security features.

For AP configuration information, refer to the *Ortronics Wireless Software User's Guide*.

Provisioning Access Points

Access Points are radio broadcast devices and as such are subject to governmental regulation. Network administrators responsible for the configuration and operation of Access Points must comply with local broadcast regulations. Specifically, Access Points must use channel assignment appropriate to the location in which the Access Point will be used. Ortronics, in compliance with governmental requirements, has designed the Wi-Jack DUO such that only authorized network administrators can change these settings. For more information on Wi-Jack DUO configuration, refer to the *Ortronics Wireless Software User's Guide*.

Provisioning provides the AP with initial network settings that allow it to locate the host Ortronics Wireless Controller. The following provisioning methods (listed in the order of preference recommended by Ortronics) are available:

- **Plug and Play**—Also known as the Discovery Protocol. This is the easiest method for AP provisioning. With plug and play, Ortronics APs can be connected to the network and brought into operation automatically. Although plug and play requires no manual intervention for the APs, this method does require specific services to be configured on your network in advance.
- **AP Provisioning**—Using this AP programming mode, AP configuration parameters are defined on the Wireless Controller (using the CLI or Web interface) and then uploaded to the APs.

This method can be used for adding Ortronics APs to a highly customized network, or greatly simplified for the most common provisioning.

- **Manual Provisioning**—APs can be individually provisioned using a serial console terminal connected to the AP. Although this method is complex and requires considerable care, manual provisioning can be used in almost any scenario, with or without access to the Wireless Controller.

Note Manual provisioning is intended for use when no Ortronics Wireless Controller is available, and is not generally recommended as the primary method of AP provisioning. Plug and play or AP programming mode are the preferred provisioning methods.

Each of these three methods is explained in the following sections. Use these procedures for initial provisioning of APs. To change the configuration for APs that have already been provisioned, go to Maintenance > Program AP > Re-Provision. See the *Ortronics Wireless Software User's Guide* for more information on reprovisioning existing APs.

Discovery Protocol

The Discovery Protocol is a plug and play provisioning tool for Ortronics Wi-Jack DUO. The Discovery Protocol performs two tasks:

- Obtains the IP address of the TFTP server from which it downloads the AP boot image
- It discovers the IP address of the master Ortronics Wireless Controller in the network from which the AP can download its configuration.

The address of the TFTP server that the protocol discovers is the equivalent of the BOOTROM environment variable *serverip*. The IP address of the Ortronics Wireless Controller is the equivalent of the environment variable *master*.

The protocol can discover these values using DHCP or by discovery. In the case of DHCP, the discovery protocol relies on a DHCP server which is configured to return the IP address of the master Controller using the Vendor Specific Options in DHCP. To facilitate the discovery protocol, Ortronics APs include this Vendor Specific Option in the requested Option list, and if the DHCP server is configured to return the IP address of the Master switch, the IP address will be a part of the DHCP response. This is used by the AP to get its image as well as its configuration.

Discovery of the *serverip* and *master* variables is necessary when the DHCP response does not include the Vendor Specific option. The AP attempts to discover an Ortronics Master Wireless Controller by sending multicast packets and broadcast packets on its subnet. To use the discovery method, the ADP discovery mechanism needs to be enabled on the Ortronics Master Wireless Controller (using the **adp discovery enable** command).

If multicast routing is enabled in the IP network between the AP and the Master Wireless Controller (which can be any one or more Ortronics Wireless Controllers in the network), the IGMP-Join option should be enabled on the Ortronics Wireless Controller (using the **adp igmp-join enable** command). If multicast routing is not enabled on the network, the Ortronics Wireless Controllers need to be on the same broadcast domain as the AP or an “IP Helper” must be configured to direct the broadcast discovery protocol packets to the Ortronics Wireless Controller.

Once these discovery prerequisites are met, the switch will respond to APs with the IP address of the Ortronics Master Wireless Protocol. The APs can then obtain their image and configuration.

To enable Discovery Protocol on an Ortronics Wireless Controller, enter:

```
(A5000) (config) #adp discovery enable
```

To enable IGMP-Join on an ADP multicast group on an Ortronics Wireless Controller, enter:

```
(A5000) (config) #adp igmp-join enable
```

Note If you have location-specific configurations for your Access Points, you will need to apply this configuration information using AP Reprovisioning. Refer to the *Ortronics Wireless Software User's Guide* for details on AP Reprovisioning and see the feature description below.

AP Reprovisioning

AP Reprovisioning is the process by which APs are assigned, for example, location codes. Location codes are important for recalibration and triangulation. For details on AP Reprovisioning, see the *Ortronics Wireless Software User's Guide*.

AP Provisioning

AP Provisioning is useful for brand new APs with default configurations. To perform AP Provisioning from the GUI:

- 1 Go to **Maintenance > Program AP**.

On this window, there are two tabs: **Provisioning** and **Reprovisioning**. The Provisioning tab is selected by default.

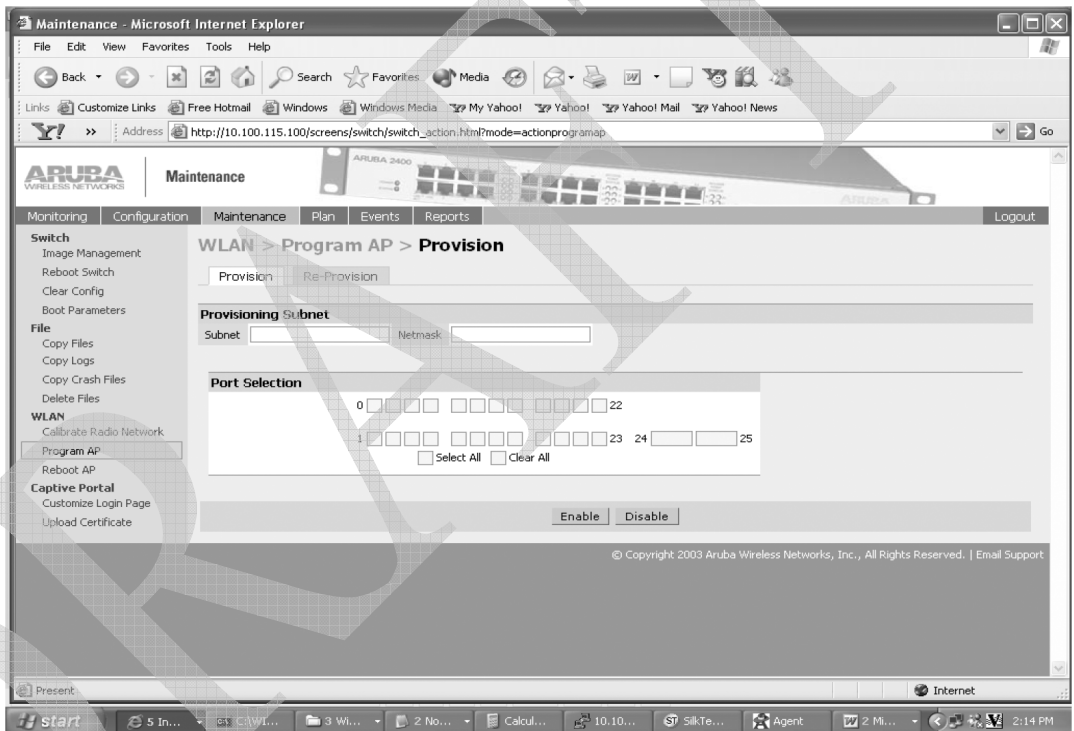

FIGURE 2-1 Provisioning Tab

- 2 Configure the APs IP address on the **Subnet** and the **Netmask**.

This is the subnet from which the AP gets an IP during provisioning.

- 3 Select the **Port** or **Port Range** for provisioning.

To set the Port Range, select the first and the last ports of your range. All the ports in between are automatically selected. (Ports have to be sequentially assigned.)

- 4 Enter the required information and click **Enable**.The Port Range screen displays.

The screenshot shows the Aruba Maintenance web interface in Microsoft Internet Explorer. The browser title is "Maintenance - Microsoft Internet Explorer". The address bar shows "http://10.3.17.75/screens/switch/switch_action.html?mode=actionprogramap". The page title is "Maintenance" and the breadcrumb is "WLAN > Program AP > Provision > Port Range 3/12".

The left sidebar contains navigation menus for:

- Switch: Image Management, Reboot Switch, Clear Config, Boot Parameters
- File: Copy Files, Copy Logs, Copy Crash Files, Delete Files
- WLAN: Calibrate Radio Network
- Program AP: Program AP, Reboot AP
- Captive Portal: Customize Login Page, Upload Certificate

The main content area has sections for:

- AP Parameters**: Location, 5 GHz Antenna Gain, 2 GHz Antenna Gain
- Master Discovery**: Use Aruba Discovery Protocol, Host Switch IP Address, Host Switch Name, Master Switch IP Address
- IP Settings**: Obtain IP Address Using DHCP, Use the following IP Address, IP Address, Subnet Mask, DNS IP Address, Domain Name, Gateway IP Address
- AP List**: A table with columns: Index, Slot/Port, AP MAC/IP, Location, Master IP, Host IP/Name, IP, GW IP/DNS IP/Domain, 5GHz/2GHz Gain. Below the table, it says "No APs are currently connected for provisioning".

At the bottom right, there are "Apply" and "Cancel" buttons. A legend indicates "P = Provisioned U = Unprovisioned".

FIGURE 2-2 Port Range Screen

- 5 Plug the AP into one of the ports configured for provisioning.
If your AP is already plugged into the port, unplug it and plug it in again.
If AP is connected through PoE, enter **poe off** followed by **poe on**.
The AP will come up with an IP from the provisioning subnet
After the AP comes up it should be in the provisioning list. Provisioning list shows the list of APs which are plugged into the provisioning ports.

- 6 Click the **Refresh** link (not the browser Refresh option) to see if the AP entry has displayed. (This might take a moment.)

If you cannot see the entry after 1-2 minutes, click **Refresh** again.

The **Clear Table** button appears after an entry in the list appears.

To erase all the table entries, click **Clear Table**. (You cannot clear selected entries.) If a number of APs are provisioned and you click **Clear Table**, only the entries which come up afterwards can be provisioned.

If the entry does not show up in the AP list, check network connectivity. Go to the AP console and verify if the AP has come up with the IP from the provisioning subnet.

- 7 After the entry shows up on the page, configure the **location**, **Host IP/Name**, **Master IP address**.

If AP is going to be assigned a static IP, click **Use the following IP Address** and enter the **IP address**, **Netmask**, **Gateway IP**.

If the AP is going to obtain an IP address using DHCP, click **Use IP Address Using DHCP**.

- 8 After configuring the required parameters, select the entry from the list (AP to which the configuration has to be applied) and click **Apply**.

The State field changes from **U (Unprovisioned)** to **In Progress**.

- 9 After a few seconds, click the **Refresh** link again and the State will have changed to **P (Provisioned)**.

Note Check that the configured parameters are reflected in the AP list entry.

Note Ortronics recommends that you provision each AP for a unique location as suggested by site-survey planning. Label each AP with this location information and place the AP in its proper location. Failure to place APs in the location for which they were provisioned will reduce the effectiveness of such RF features as triangulation.

- 10 Click **Back** to go into the previous page

We can see that the Subnet is still configured and Port/s are selected.

- 11 When finished provisioning APs, click **Disable** to disable AP Provisioning.

Note Disable AP Provisioning after all the required APs are provisioned. Ports that are enabled for provisioning do not handle traffic. Therefore plugging an already provisioned AP into a port still set to provisioning mode will prevent that AP from functioning.

Now the AP is configured with the Parameters given

12 Reboot the AP so the AP will come up with the new configured parameters.

Use the Re provisioning tab for APs which are already deployed but need to be reconfigured. See the *Ortronics Wireless Software User's Guide* for information on re provisioning.

Manual Provisioning

Connecting the Console Terminal

Manual provisioning requires this procedure. You must use the serial console breakout adapter cable to be able to access the serial console interface to the Ortronics Wi-Jack DUO while allowing the device to be powered by the AC adapter or PoE (from an Ortronics Wireless Controller).



FIGURE 2-3 Wi-Jack AP DUO

AP Deployment

This chapter covers installation of the Ortronics Wi-Jack DUO Access Point.

Mounting the Ortronics Wi-Jack DUO

When provisioning is complete, mount the Ortronics Wi-Jack DUO at its intended service location.

The Ortronics Wi-Jack DUO with internal antennas is intended only for installation in Environment A as defined in IEEE 802.3.af. All interconnected equipment must be contained within the same building, including the interconnected equipment's associated LAN connections.

Select a location as close as possible to the center of the intended coverage area. If necessary, use the Ortronics RF Plan site survey tool to determine the optimum locations for your access points and air monitors.

The service location should be free from obstructions or obvious sources of interference. Normally, the higher you place an access point or air monitor, the better its performance.

The Ortronics Wi-Jack DUO is not suitable for outside use.

Connecting Required Cables

The Ortronics Wi-Jack DUO with internal antennas are intended only for installation in Environment A as defined in IEEE 802.3.af. All interconnected equipment must be contained within the same building, including the interconnected equipment's associated LAN connections.

Selecting Horizontal Cable

The 10/100 Mbps Ethernet (FE) port is used to connect the AP to a 10Base-T/100Base-TX (twisted-pair) Ethernet LAN segment. The appropriate FE jumper cable is supplied. Horizontal cable must be 8-conductor, Category 5e minimum, UTP, straight-through FE cable.

The maximum horizontal run length for FE cable is 100 meters (325 feet).

Install cables in accordance with all applicable local regulations and practices.

For more port and cable details, see Appendix B.

DRAFT

INSTALLATION INSTRUCTIONS

- Terminate horizontal CAT 5e or better cable to the TechChoice Keystone jack provided, in accordance with Ortronics Instruction Sheet OR-71601440, also provided.
- Insert the TechChoice Keystone jack into the wall strap, in the Keystone opening.
- Carefully recoil excess horizontal cable into the wall, and place the strap with jack into the workbox within the wall.
- Insert the DUO access point into the strap.
- Using the two, #6-32 X 1" long screws, secure the strap and DUO access point to the workbox within the wall.
- After marking the DUO access point designation on the designation papers provided, place these papers and clear plastic window covers into the DUO access point faceplate.

Physical installation of the Ortronics DUO access point is now complete. Refer to the user guide for its network configuration.

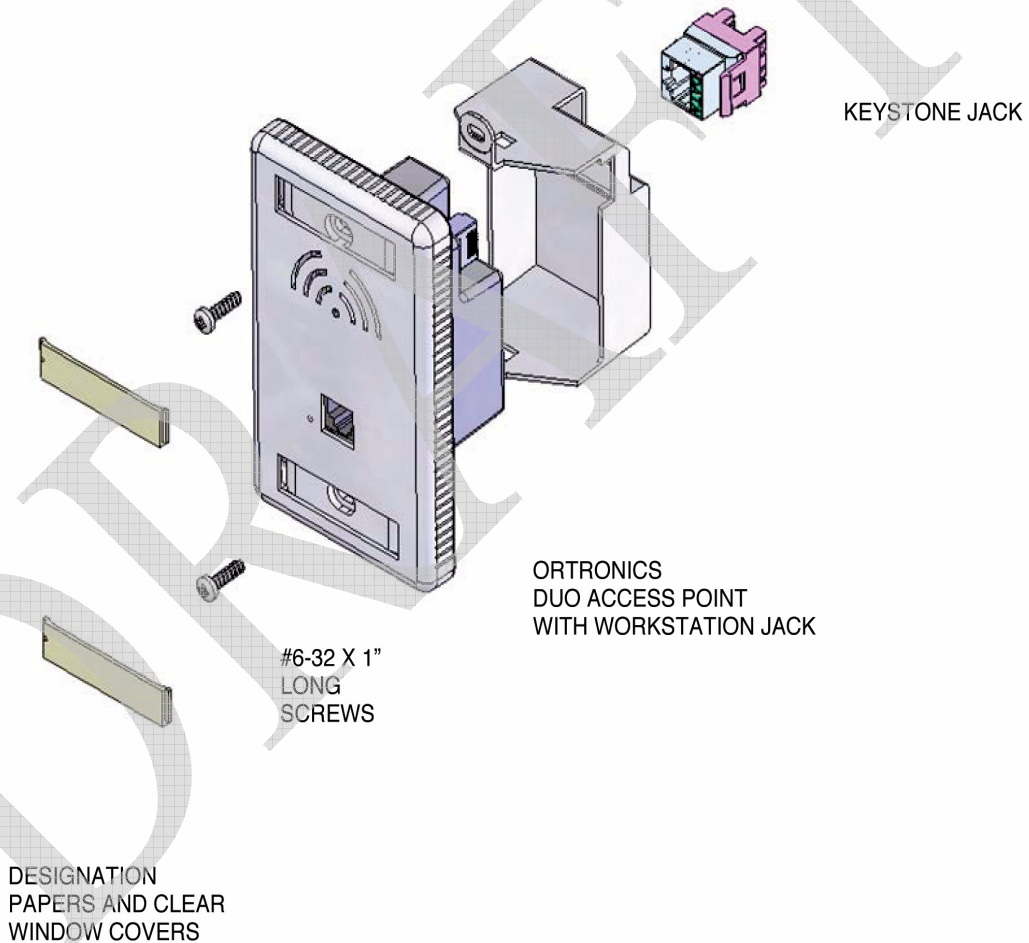

CAUTION: TERMINATE JACKS PER SPECIFIED
WIRING SYSTEM 'T568A' or 'T568B'.

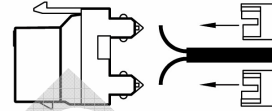
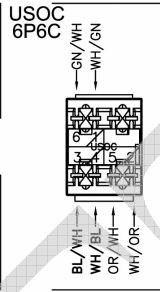
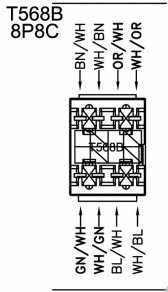
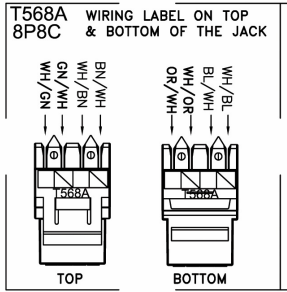

NOTE: When terminating cables to Jacks, lace wires from the center to the outside of the module. Install stuffer caps after terminating cable.

'This device is intended for indoor use on communication loop circuit which have been isolated from the Public Switched Telephone Network'.

WIRING CHART

COLOR CODE LABEL	RJ25 6P6C USOC WIRING	RJ45 8P8C T568A WIRING	RJ45 8P8C T568B WIRING
WHITE/BLUE	4	5	5
BLUE/WHITE	3	4	4
WHITE/ORANGE	2	3	1
ORANGE/WHITE	5	6	2
WHITE/GREEN	1	1	3
GREEN/WHITE	6	2	6
WHITE/BROWN		7	7
BROWN/WHITE		8	8

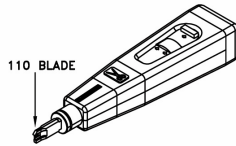

110 BLADE
REQUIRED TERMINATION TOOL
OR-60300005 (TOOL & BLADE)
OR-60300006 (BLADE ONLY)



RECOMMENDED STRIPPING TOOL
OR-60300032 (TOOL)

CAUTION: TERMINATE JACKS PER SPECIFIED
WIRING SYSTEM 'T568A' or 'T568B'.

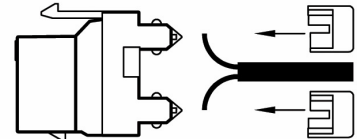
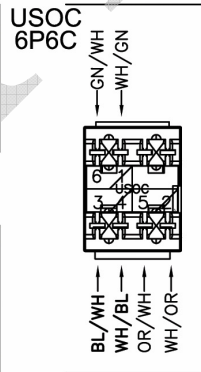
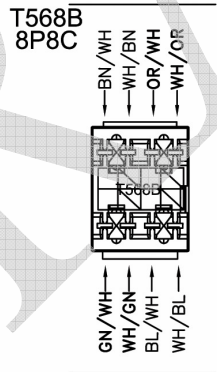
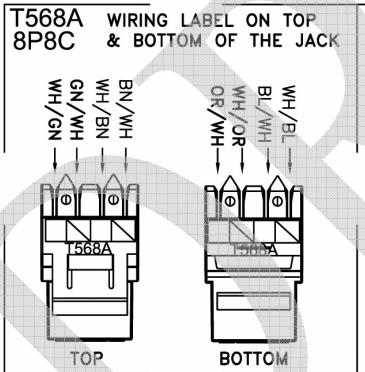

NOTE: When terminating cables to Jacks, lace wires from the center to the outside of the module. Install stuffer caps after terminating cable.

'This device is intended for indoor use on communication loop circuit which have been isolated from the Public Switched Telephone Network'.

WIRING CHART

COLOR CODE LABEL	RJ25 6P6C USOC WIRING	RJ45 8P8C T568A WIRING	RJ45 8P8C T568B WIRING
WHITE/BLUE	4	5	5
BLUE/WHITE	3	4	4
WHITE/ORANGE	2	3	1
ORANGE/WHITE	5	6	2
WHITE/GREEN	1	1	3
GREEN/WHITE	6	2	6
WHITE/BROWN		7	7
BROWN/WHITE		8	8

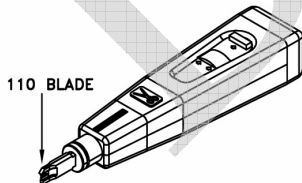

110 BLADE
REQUIRED TERMINATION TOOL
OR-60300005 (TOOL & BLADE)
OR-60300006 (BLADE ONLY)



RECOMMENDED STRIPPING TOOL
OR-60300032 (TOOL)

Cables

“To AP” Specifications

The RJ-45 connector labeled “To AP” attaches to the Ortronics Wi-Jack DUO User port either directly (if the AP is physically available) or indirectly (if the AP is already deployed).

When connecting indirectly, use a straight-through FE coupler to attach the “To AP” connector to the FE cable leading directly to the AP’s User port with no intervening hubs, routers, or other network equipment. The cable must be 8-conductor, Category 5e or 6, straight-through FE cable with a maximum length of 100 meters (325 feet).

Install cables in accordance with all applicable local regulations and practices.

“To Network” Specifications

The RJ-45 connector labeled “To Network” attaches to an FE LAN segment. This connection is optional unless IEEE 802.11af Power over Ethernet (PoE) is used to power the AP during manual provisioning.

A straight-through FE coupler may be used to attach the “To Network” connector to a LAN FE cable. The appropriate cable depends on the level of connectivity required of the User port:

- If the connecting device supports IEEE 802.3af Power over Ethernet (PoE), use an 8-conductor, Category 5e or 6, straight-through FE cable with male RJ45 connectors. The Ortronics WCU-5, WCU-16 and WCU-48 support SPOE.
- Otherwise, use an 8-conductor, Category 5e or 6, FE cable with male RJ45 connectors. The port detects MDI/MDX and automatically adjusts for straight-through or crossover cables.

Note Only IEEE 802.3af Power over Ethernet is supported for manual provisioning. “Inline” or “midspan” PoE devices will not work with the Ortronics serial breakout adapter.

The maximum horizontal cable run length for FE cables is 100 meters (325 feet).

Install cables in accordance with all applicable local regulations and practices.

DRAFT

Troubleshooting

After provisioning and deployment, the Ortronics Wi-Jack DUO can be configured and managed through the Ortronics Wireless Controller. However, the Ortronics Wi-Jack DUO includes built-in troubleshooting features for situations where the controller commands are unable to diagnose AP problems.

This appendix describes using the built-in AP support prompt for troubleshooting.

Accessing the AP Support Prompt

Depending on your network topology, the built-in AP Support prompt can be accessed using the AP serial console port or through the Wireless Controller using the Serial Over Ethernet (SoE) interface or using Telnet from a remote management station.

Direct SPOE Connection to Wireless Controller

This method requires that the Ortronics Wi-Jack DUO is connected directly to an SPOE-compatible network port on the Ortronics Wireless Controller (see “Connecting Required Cables” on page 13).

1 Telnet to the Ortronics Wireless Controller Serial-Over-Ethernet (SoE) interface.

Use a Telnet client on your management workstation to connect to the Ortronics Wireless Controller IP address using logical port 2300. The connection command may vary depending on the specific software used, but commonly appears as follows:

```
> telnet <Wireless Controller IP address> 2300
```

2 When prompted, log in to the Ortronics Wireless Controller as the administrator:

```
user: admin  
password: <administrator password (not displayed)>
```

This will present you with the Ortronics Wireless Controller SoE console prompt:

```
Available commands:  
  baud [9600|19200|38400|57600|115200]  
  connect <slot/port>  
  exit (no args)  
soe>
```

3 Connect to the port to which the Ortronics Wi-Jack DUO is physically attached:

```
soe> connect <slot number> / <port number>
```

where *slot number* is the physical slot of the line card in the Wireless Controller, and *port number* is the physical port.

If the AP has not finished booting, allow the Autoboot timer to expire. When the device has booted, the AP support prompt (#) will appear.

Direct Terminal Connection

This method requires that the Ortronics Wi-Jack DUO is connected to a compatible serial console using the Ortronics serial breakout adapter OR-AP-SPOE (see “Connecting the Console Terminal” on page 12).

1 Set up your local terminal.

This procedure requires a terminal or computer running terminal emulation software with the following settings:

Table B-1 Console Terminal Settings

Baud Rate	Data Bits	Parity	Stop Bits	Flow Control
9600	8	None	1	None

2 Establish console communication.

Press <Enter> a few times to establish communication between the Ortronics Wi-Jack DUO and terminal.

If the AP has not finished booting, allow the Autoboot timer to expire. When the device has booted, the AP Support prompt (#) will appear.

Remote Telnet Connection

If properly set up, the AP support prompt can be accessed remotely using Telnet. By default, this feature is turned off for security purposes and cannot be turned on using the AP interface.

Setting Telnet Access

Telnet access can only be changed from the Wireless Controller management interface. Log in to the Wireless Controller CLI using the admin account, access the configuration (config) prompt, and issue the following commands:

```
(Aruba 5000) (config) # ap location <building>.<floor>.<device>  
(Aruba 5000) (sap-config location b.f.d) # telnet  
{enable|disable}
```

Using Telnet to Connect

Use a Telnet client on your management workstation to connect to the Ortronics Wi-Jack DUO's individual IP address. The connection command may vary depending on the specific software used, but commonly appears as follows:

```
> telnet <Ortronics Access Point IP address>
```

When the connection is established, the AP support prompt (#) will be displayed.

AP Support

Access Levels

- User Access

User access is a low security level, featuring only the most basic commands. It is available without any additional login after the AP has booted.

- Privileged Access

Privileged-level access requires the privileged password (the same privileged password used on the controller) to be entered using the user level `enable` command. The privileged access level is available only after the AP has successfully booted and synchronized with Wireless Controller.

User Commands

- **ping** *<host|IP address>*

Verify IP connectivity between the AP and the host address.

- **route**

Display the contents of the AP route table.

- **ifconfig**

Display the AP's IP address settings.

- **enable** *<privileged password>*

Access the AP Support privileged mode.

Privileged Commands

In addition to the user commands, the following commands are available upon successfully entering the privileged mode:

- **ps**
- **show** *[config|stats|version]*

Note— These commands should be used only as directed by Ortronics Customer Support.

Product Specifications

Compliance

FCC - Class A

This equipment has been tested and found to comply with the limits for a Class A digital device, pursuant to Part 15 of the FCC Rules. These limits are designed to provide reasonable protection against harmful interference when the equipment is operated in a commercial environment. This equipment generates, uses, and can radiate radio frequency energy and, if not installed and used in accordance with the instruction manual, may cause harmful interference to radio communications. Operation of this equipment in a residential area is likely to cause harmful interference in which case the user will be required to correct the interference at their own expense.

Any changes or modifications not expressly approved by the party responsible for compliance could void the user's authority to operate this equipment.

This product complies with Part 15 of the FCC Rules. Operation is subject to the following two conditions: (1) this device may not cause harmful interference, and (2) this device must accept any interference received, including interference that may cause undesired operation.

CAUTION STATEMENT: FCC RF Radiation Exposure Statement

This equipment complies with FCC RF radiation exposure limits set forth for an uncontrolled environment. This equipment should be installed and operated with a minimum distance of 20 centimeters (8 inches) between the radiator and your body. This transmitter must not be co-located or operating in conjunction with any other antenna or transmitter.

Radio Frequency Interference Requirements

This device is restricted to indoor use due to its operation in the 5.15 to 5.25 GHz frequency range. The FCC requires this product to be used indoors to reduce the potential for harmful interference to co-channel Mobile Satellite systems. High power radars are allocated as primary users of the 5.25 to 5.35 GHz and 5.65 to 5.85 GHz bands. These radar stations can cause interference with and/or damage this device.

Industry Canada - Class A

This digital apparatus does not exceed the Class A limits for radio noise emissions from digital apparatus as set out in the interference-causing equipment standard entitled "Digital Apparatus," ICES-003 of the Department of Communications.

Cet appareil numérique respecte les limites de bruits radioélectriques applicables aux appareils numériques de Classe A prescrites dans la norme sur le matériel brouilleur: "Appareils Numériques," NMB-003 édictée par le ministère des Communications.

CE - Class A

Warning—This is a Class A product. In a domestic environment, this product may cause radio interference in which case the user may be required to take adequate measures.

EU - Class A

This product complies with EN5022 Class A and EN5024 standards.

Certifications

Item	Measurement
Electromagnetic Compatibility	FCC Part 15 Class A, FCC Part 15 Class C 15.207/15.247, FCC Part 15 Class E 15.407 ICES-003 Class A, RSS 210 (CAN)
Safety	UL Listed (UL60950) UL Listed (CAN/CSA 22.2 No. 60950)

Product Features

- Wireless dual-band transceiver
- Protocol-independent networking functionality
- Supports IEEE 802.11a and IEEE 802.11b/g operation as an AP
- Supports IEEE 802.11a and IEEE 802.11b/g operation as an AM
- Compatible with IEEE 802.3af Power over Ethernet (PoE)
- Seamless connectivity to wired LANs augment existing networks quickly and easily
- Can be centrally managed, configured, and upgraded through the Ortronics Wireless Controller to take advantage of network changes and security improvements

Ethernet Compatibility

The Ortronics Access Point attaches to 10/100 Mbps Ethernet (FE) LAN segments that utilize 10Base-T/100Base-TX (twisted-pair) wiring. The device appears as an Ethernet node and performs a routing function by moving packets between the wired LAN and remote workstations on the wireless infrastructure.

Radio Characteristics

The Ortronics Access Point can be configured to support IEEE 802.11a and IEEE 802.11b/g operation as an AP, and supports both IEEE 802.11a and IEEE 802.11b/g operation as an AM:

- 802.11a provides a high data rate and reliable wireless connectivity.
802.11a operation uses a radio modulation technique known as Orthogonal Frequency Division Multiplexing (OFDM), and a shared collision domain (CSMA/CA). It operates in the 5GHz Unlicensed National Information Infrastructure (UNII) band. Data is transmitted over a half-duplex radio channel operating at up to 54 Megabits per second (Mbps).
- 802.11b provides compatibility with a large user base.
802.11b operation uses the IEEE 802.11 High-Rate Direct Sequence (HRDS) specification, and a shared collision domain (CSMA/CA). It operates in the 2.4 GHz Industrial/Scientific/Medical (ISM) band. The ISM band is available worldwide for unlicensed use. Data is transmitted at speeds of up to 11 Mbps.
- 802.11g provides a high data rate and is backwards compatible with 802.11b.
802.11g operation uses OFDM and a shared collision domain (CSMA/CA). It operates in the 2.4 GHz Industrial/Scientific/Medical (ISM) band. The ISM band is available worldwide for unlicensed use. Data is transmitted at speeds of up to 54 Mbps.

Power over Ethernet

The Ortronics Access Point supports the IEEE 802.3af standard for Power over Ethernet (PoE). With this feature, the Ortronics Access Point can accept electrical power from a compatible PoE-capable device (such as the Ortronics OR-WCU-5, OR-WCU-16 and OR-WCU-48) directly over the FE cable. PoE eliminates the need to provide separate power outlets in environments that are difficult or undesirable to wire for electricity.

The Ortronics Access Point also supports “inline” and “midspan” PoE devices for normal operation.

Physical Description

Package Contents

The Ortronics Wi-Jack DUO Access Point package includes:

- One Ortronics Wi-Jack DUO
- Assorted documentation
- Keystone Jack
- Mounting hardware and Keystone Jack designation label

Inform your distributor if there are any incorrect, missing or damaged parts. If possible, retain the carton, including the original packing materials. Use them to repack the product in case there is a need to return it.

Optional Items

The following optional items can also be ordered for the Ortronics Access Point:

- OR-AP-SPOE Ortronics Serial Break Out Adapter

Check with your Ortronics distributor for the availability of optional items.

TABLE C-1 Wi-Jack DUO Specifications

Description	802.11a	802.11b	802.11g
Antenna	Dual, diversity internal tri-band 802.11a/b/g antennas		
Frequency Band	<ul style="list-style-type: none"> ● 5.250 ~ 5.350 Ghz (middle band) 4 channels ● 5.725 ~ 5.825 Ghz (higher band) 4 channels 	<ul style="list-style-type: none"> ● 2.4 ~ 2.483 Ghz (US, Canada & ETSI) ● 2.4 ~ 2.497 Ghz (Japan) 	<ul style="list-style-type: none"> ● 2.412 ~ 2.462 Ghz (US, Canada) ● 2.412 ~ 2.472 Ghz (ETSI) ● 2.412 ~ 2.484 Ghz (Japan)
Radio Technology	Orthogonal Frequency Division Multiplexing (OFDM)	Direct Sequence Spread Spectrum (DSSS)	Orthogonal Frequency Division Multiplexing (OFDM)
Modulation Type	BPSK, QPSK, 16-QAM, 64-QAM	CCK, BPSK, QPSK	CCK, BPSK, QPSK, 16-QAM, 64-QAM
Transmit Power	Configurable by system administrator/professional installer	Configurable by system administrator/professional installer	Configurable by system administrator
Media Access Control	CSMA/CA with ACK	CSMA/CA with ACK	CSMA/CA with ACK
Operating Channels	<ul style="list-style-type: none"> ● US & Canada: 8 ● ETSI: 13 ● Japan: 5 	<ul style="list-style-type: none"> ● US & Canada: 11 ● ETSI: 13 ● Japan: 13 	<ul style="list-style-type: none"> ● US & Canada: 11 ● ETSI: 13 ● Japan: 13
Data Rates	6, 9, 12, 18, 24, 36, 48, 54 Mbps per channel	1, 2, 5.5, 11 Mbps per channel	6, 9, 12, 18, 24, 36, 48, 54 Mbps per channel

TABLE C-2 Wi-Jack DUO (Continued)

Description	
Maximum Clients	64
Multi-mode Radio Band	Selectable via software
Manageability:	<ul style="list-style-type: none"> ● Management of all 802.11 parameters ● Network Wide AP Management via: <ul style="list-style-type: none"> CLI WEB GUI SNMPv3 ● Access Point Profiles, Management by: <ul style="list-style-type: none"> Geographical Location BSSID Radio Type
Encryption Support (AP and Switch)	40bit / 64bit / 128bit / 152bit WEP, TKIP, AES
Physical: (H/W/D)	<ul style="list-style-type: none"> ● Wi-Jack DUO ● 4.7" x 2.75" x 2"
Interfaces (Electrical):	<ul style="list-style-type: none"> ● 1 x 10/100 Base Tx User Port ● Autosensing MDI/MDIX ● Secure-Jack wired port
Internal Indicators (LEDs)	<ul style="list-style-type: none"> ● Ready power On/Off green ● RF activity 802.11a AP blue ● RF activity 802.11b/g AP blue
Power	<ul style="list-style-type: none"> ● Access Point Input— 48 VDC, 200 mA (PoE)

TABLE C-2 Wi-Jack DUO (Continued)

Description	
Power Requirements	<ul style="list-style-type: none"> ● 48V DC / 200mA Power over Ethernet (802.3af compliant)
Output Power	100 mW maximum (or lower as configured on the Ortronics Wireless Controller to comply with local regulatory requirements)
Environmental	Humidity 5% to 95% (non-condensing)
Operating Ambient	Maximum 40C
Standards Compliance	<ul style="list-style-type: none"> ● Ethernet IEEE 802.3 / IEEE 802.3u ● Power over Ethernet IEEE 802.3af * Note ● Wireless IEEE 802.11a/b/g
Electromagnetic Compliance	<ul style="list-style-type: none"> ● FCC Part 15 Class A, FCC Part 15 Class C 15.207/15.247 ● FCC Part 15 Class E 15.407 ● ICES-003 Class A, ● RSS 210 (CAN) ● VCCI Class A ● EN 61000-3, EN 61000-4-2, EN 61000-4-3, EN 61000-4-4, ● EN 61000-4-5, EN 61000-4-6, EN 61000-4-8, EN 61000-4-11 ● EN 55022, EN55024 (89/336/EEC), ● ETS 300 328 (89/336/EEC), ETS 301 489 (89/336/EEC) ● ETS 301 893
Safety Compliance	<ul style="list-style-type: none"> ● CSA/NTRL (CSA 22.2 No. 950 & UL 1950) ● EN60950 (TÜV/GS), IEC60950 (CB)

Related Documents

The following items are part of the complete documentation for the Ortronics Wireless Solution:

- *Ortronics Wi-Jack DUO Installation Guide* (this document)
- *Ortronics Wireless Controller Installation Guide*
- *Ortronics RF Plan User's Guide*
- *Ortronics Wireless Software User's Guide*

For the current versions of these manuals, or to obtain the latest product release notes, visit the support section of our Web site (see page 32).

Note: Wireless Access Points with or without external antenna ports are only intended for installation in Environment A as defined in IEEE 802.3.af. All interconnected equipment must be contained within the same building including the interconnected equipment's associated LAN connections.”

Text Conventions

The following conventions are used throughout this manual to emphasize important concepts:

TABLE 3-1 Text Conventions

Type Style	Description
<i>Italics</i>	This style is used to emphasize important terms and to mark the titles of books.
System items	This fixed-width font depicts the following: <ul style="list-style-type: none">● Sample screen output● System prompts● Filenames, software devices, and certain commands when mentioned in the text.
Commands	In the command examples, this bold font depicts text that the user must type exactly as shown.
< <i>Arguments</i> >	In the command examples, italicized text within angle brackets represents items that the user should replace with information appropriate to their specific situation. For example: <pre># send <text message></pre> <p>In this example, the user would type “send” at the system prompt exactly as shown, followed by the text of the message they wish to send. Do not type the angle brackets.</p>
[Optional]	In the command examples, items enclosed in brackets are optional. Do not type the brackets.
{ Item A Item B }	In the command examples, items within curled braces and separated by a vertical bar represent the available choices. Enter only one choice. Do not type the braces or bars.

Contacting Ortronics

- Main US 877-599-5393 - Toll-free
- Main 860-445-3800
- Fax 888-282-0043 - Toll-free
- Fax 860-405-2970
- Email connect@ortronics.com
- Web Site <http://www.ortronics.com>

Notes

.....

.....

.....

.....

.....

.....

.....

.....

.....

.....

.....

.....

.....

.....

.....

.....

.....

.....

.....

.....

.....

.....

.....

.....

.....

.....

.....

DRAFT

Notes

A series of horizontal dashed lines for writing notes.

DRAFT