



FCC TEST REPORT

47 CFR FCC Part 15 Subpart B

FCC ID.....: **T37PL9667-B3**

Report Reference No......: **WE10110011**

Compiled by

(position+printed name+signature)..: File administrators Wenliang Li

Supervised by

(position+printed name+signature)..: Test Engineer Eric Zhang

Approved by

(position+printed name+signature)..: Manager Jimmy Li

Date of issue.....: Dec 02, 2010

Testing Laboratory Name.....: **Shenzhen Huatongwei International Inspection Co., Ltd**

Address.....: Keji Nan No.12 Road, Hi-tech Park, Shenzhen, China

Applicant's name.....: **ASOKA USA Corporation**

Address.....: 2344-A Walsh Avenue, Santa Clara City, CA 95051

Test specification:

Standard.....: **47 CFR FCC Part 15 Subpart B - Unintentional Radiators**
ANSI C63.4: 2009

TRF Originator.....: Shenzhen Huatongwei International Inspection CO., Ltd

Master TRF.....: Dated 2006-06

Shenzhen Huatongwei International Inspection Co., Ltd. All rights reserved.

This publication may be reproduced in whole or in part for non-commercial purposes as long as the Shenzhen Huatongwei International Inspection Co., Ltd is acknowledged as copyright owner and source of the material. Shenzhen Huatongwei International Inspection Co., Ltd takes no responsibility for and will not assume liability for damages resulting from the reader's interpretation of the reproduced material due to its placement and context.

Test item description.....: PlugLink HD AV Pass-Through Adapter

Trade Mark.....: /

Model/Type reference.....: PL9667-B3

Listed Models.....: /

Result.....: **Positive**

TEST REPORT

Test Report No. :	WE10110011	Dec 02,2010
		Date of issue

Equipment under Test : PlugLink HD AV Pass-Through Adapter

Model /Type : PL9667-B3

Listed Models : /

Applicant : ASOKA USA Corporation

Address : 2344-A Walsh Avenue, Santa Clara City, CA 95051

Manufacturer : Asoka USA Corporation

Address : 2344-A Walsh Avenue Santa Clara City, CA 95051

Test Result according to the standards on page 4:	Positive
--	-----------------

The test report merely corresponds to the test sample.
It is not permitted to copy extracts of these test result without the written permission of the test laboratory.

Contents

- 1. TEST STANDARDS 4**

- 2. SUMMARY 5**
 - 2.1. General Remarks 5
 - 2.2. Equipment Under Test 5
 - 2.3. Short description of the Equipment under Test (EUT) 5
 - 2.4. EUT operation mode 5
 - 2.5. Related Submittal(s) / Grant (s) 5
 - 2.6. Modifications 5
 - 2.7. Configuration of Tested System 6

- 3. TEST ENVIRONMENT 7**
 - 3.1. Address of the test laboratory 7
 - 3.2. Test Facility 7
 - 3.3. Environmental conditions 8
 - 3.4. Statement of the measurement uncertainty 8
 - 3.5. Equipments Used during the Test 9

- 4. TEST CONDITIONS AND RESULTS 10**
 - 4.1. Conducted Emissions Test 10
 - 4.2. Radiated Emission Test 14

- 5. TEST SETUP PHOTOS OF THE EUT 20**

- 6. EXTERNAL AND INTERNAL PHOTOS OF THE EUT 22**

1. TEST STANDARDS

The tests were performed according to following standards:

[47 CFR FCC Part 15 Subpart B](#) - Unintentional Radiators

[ANSI C63.4: 2009](#) – American National Standard for Methods of Measurement of Radio-Noise Emissions from Low-Voltage Electrical and Electronic Equipment in the Range of 9 kHz to 40GHz

2. SUMMARY

2.1. General Remarks

Date of receipt of test sample : Nov 23, 2010

Testing commenced on : Nov 23, 2010

Testing concluded on : Dec 26, 2010

2.2. Equipment Under Test

Power supply system utilised

Power supply voltage : 120V / 60 Hz 115V / 60Hz
 12 V DC 24 V DC
 Other (specified in blank below)

/

2.3. Short description of the Equipment under Test (EUT)

The EUT PlugLink HD AV Pass-Through Adapter is an In-House BPL device.

For more details, refer to the user's manual of the EUT.

Sample Type: Prototype

2.4. EUT operation mode

The EUT has been tested under typical operating condition.

2.5. Related Submittal(s) / Grant (s)

This submittal(s) (test report) is intended for FCC ID: **T37PL9667-B3** filing to comply with the FCC Part 15, Subpart B Rules.

2.6. Modifications

No modifications were implemented to meet testing criteria.

2.7. Configuration of Tested System

Configuration of Tested System

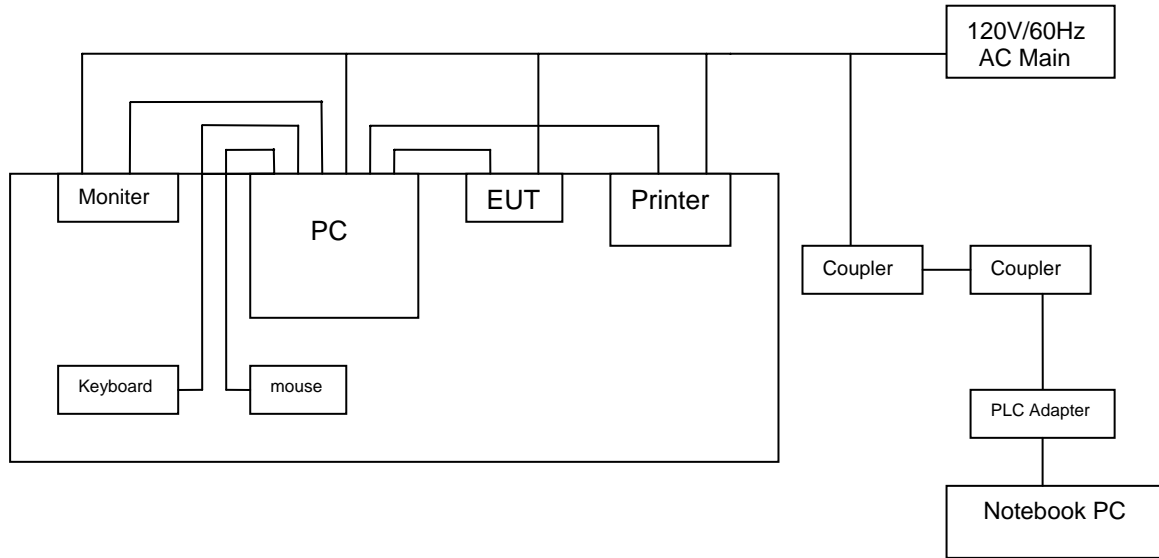

Equipment Used in Tested System

No.	Equipment	Manufacturer	Model No.	Serial No.	Notes
1	PC	HP	Compaq dx2310MT	CNG8390Q6X	(1)
2	Monitor	DELL	1707FPt	CN-OFC237-71618-65G-AAKC	(1)
3	Notebook PC	DELL	PP01L	2F485A00	(1)
4	Printer	HP	Laserjet 6L C3990A	JPZP024664	(1)
5	Keyboard	DELL	L100	CNRH65665890726009L	(1)
6	Mouse	DELL	MO56UOA	G0E02SY7	(1)
7	PlugLink AV 9560 Wireless Adapter	ASOKA	PL9560-WAP	/	(2)
8	Coupler	ASOKA	/	/	(2)

Note: (1) - supplied by test lab.

(2) - supplied by manufacturer.

3. TEST ENVIRONMENT

3.1. Address of the test laboratory

Shenzhen Huatongwei International Inspection Co., Ltd
Keji Nan No.12 Road, Hi-tech Park, Shenzhen, China
Phone: 86-755-26715686 Fax: 86-755-26748089

The sites are constructed in conformance with the requirements of ANSI C63.7, ANSI C63.4 (2003) and CISPR Publication 22.

3.2. Test Facility

The test facility is recognized, certified, or accredited by the following organizations:

CNAS-Lab Code: L1225

Shenzhen Huatongwei International Inspection Co., Ltd has been assessed and proved to be in compliance with CNAS-CL01 Accreditation Criteria for Testing and Calibration Laboratories (identical to ISO/IEC 17025: 2005 General Requirements) for the Competence of Testing and Calibration Laboratories, Date of Registration: Mar 30, 2009. Valid time is until Mar 29, 2012.

A2LA-Lab Cert. No. 2243.01

Shenzhen Huatongwei International Inspection Co., Ltd, EMC Laboratory has been accredited by A2LA for technical competence in the field of electrical testing, and proved to be in compliance with ISO/IEC 17025: 2005 General Requirements for the Competence of Testing and Calibration Laboratories and any additional program requirements in the identified field of testing. Valid time is until Sept 30, 2011.

FCC-Registration No.: 662850

Shenzhen Huatongwei International Inspection Co., Ltd, EMC Laboratory has been registered and fully described in a report filed with the FCC (Federal Communications Commission). The acceptance letter from the FCC is maintained in our files. Registration 662850, Renewal date Jun 01, 2009.

IC-Registration No.: 5377

The 3m Alternate Test Site of Shenzhen Huatongwei International Inspection Co., Ltd has been registered by Certification and Engineering Bureau of Industry Canada for the performance of radiated measurements with Registration No. 5377 on November Feb 13, 2009. Valid time is until Feb 13, 2011.

ACA

Shenzhen Huatongwei International Inspection Co., Ltd, EMC Laboratory can also perform testing for the Australian C-Tick mark as a result of our A2LA accreditation.

NEMKO-Aut. No.: ELA125

Shenzhen Huatongwei International Inspection Co., Ltd has been assessed the quality assurance system, the testing facilities, qualifications and testing practices of the relevant parts of the organization. The quality assurance system of the Laboratory has been validated against ISO/IEC 17025:2005 or equivalent. The laboratory also fulfils the conditions described in Nemko Document NLA-10, the Authorization is valid through July 07, 2011.

VCCI

The 3m Semi-anechoic chamber (12.2m×7.95m×6.7m) and Shielded Room (8m×4m×3m) of Shenzhen Huatongwei International Inspection Co., Ltd has been registered in accordance with the Regulations for Voluntary Control Measures with Registration No.: R-2484. Date of Registration: December 20, 2006. Valid time is until December 20, 2012.

Main Ports Conducted Interference Measurement of Shenzhen Huatongwei International Inspection Co., Ltd has been registered in accordance with the Regulations for Voluntary Control Measures with Registration No.: C-2726. Date of Registration: December 20, 2006. Valid time is until December 19, 2012.

DNV

Shenzhen Huatongwei International Inspection Co Ltd has been found to comply with the requirements of DNV towards subcontractor of EMC and safety testing services in conjunction with the EMC and Low voltage Directives and in the voluntary field. The acceptance is based on a formal quality Audit and follow-ups according to relevant parts of ISO/IEC Guide 17025(2005), in accordance with the requirements of the DNV Laboratory Quality Manual towards subcontractors. Valid time is until Aug 24, 2013.

3.3. Environmental conditions

During the measurement the environmental conditions were within the listed ranges:

Temperature:	<u>15-35 ° C</u>
Humidity:	<u>30-60 %</u>
Atmospheric pressure:	<u>950-1050mbar</u>

3.4. Statement of the measurement uncertainty

The data and results referenced in this document are true and accurate. The reader is cautioned that there may be errors within the calibration limits of the equipment and facilities. The measurement uncertainty was calculated for all measurements listed in this test report acc. to CISPR 16 - 4 „Specification for radio disturbance and immunity measuring apparatus and methods – Part 4: Uncertainty in EMC Measurements“ and is documented in the Shenzhen Huatongwei International Inspection Co., Ltd quality system acc. to DIN EN ISO/IEC 17025. Furthermore, component and process variability of devices similar to that tested may result in additional deviation. The manufacturer has the sole responsibility of continued compliance of the device.

Hereafter the best measurement capability for Shenzhen Huatongwei laboratory is reported:

Test	Range	Measurement Uncertainty	Notes
Radiated Emission	30~1000MHz	4.24 dB	(1)
Radiated Emission	1~18GHz	5.16 dB	(1)
Radiated Emission	18-40GHz	5.54 dB	(1)
Conducted Disturbance	0.15~30MHz	3.39 dB	(1)

- (1) This uncertainty represents an expanded uncertainty expressed at approximately the 95% confidence level using a coverage factor of k=2.

3.5. Equipments Used during the Test

Conducted Emission					
Item	Test Equipment	Manufacturer	Model No.	Serial No.	Last Cal.
1	EMI TEST RECEIVER	ROHDE & SCHWARZ	ESCI	100106	2010/10/24
2	ARTIFICIAL MAINS	ROHDE & SCHWARZ	ESH2-Z5	100028	2010/10/24
3	PULSE LIMITER	ROHDE & SCHWARZ	ESHSZ2	100044	2010/10/24
4	EMI TEST SOFTWARE	ROHDE & SCHWARZ	ES-K1	N/A	2010/10/24
5	TWO-LINE V-NETWORK	ROHDE & SCHWARZ	ESH3-Z5	100049	2010/10/24

Radiated Emission					
Item	Test Equipment	Manufacturer	Model No.	Serial No.	Last Cal.
1	ULTRA-BROADBAND ANTENNA	ROHDE & SCHWARZ	HL562	100015	2010/05/30
2	EMI TEST RECEIVER	ROHDE & SCHWARZ	ESI 26	100009	2010/10/24
3	RF TEST PANEL	ROHDE & SCHWARZ	TS / RSP	335015/ 0017	2010/10/24
4	TURNTABLE	ETS	2088	2149	2010/10/24
5	ANTENNA MAST	ETS	2075	2346	2010/10/24
6	EMI TEST SOFTWARE	ROHDE & SCHWARZ	ESK1	N/A	2010/10/24
7	HORN ANTENNA	ROHDE & SCHWARZ	HF906	100039	2010/11/01
8	Amplifer	Sonoma	310N	E009-13	2010/10/24
9	JS amplifer	ROHDE & SCHWARZ	JS4-00101800-28-5A	F201504	2010/11/01
10	High pass filter	Compliance Direction systems	BSU-6	34202	2010/03/28

4. TEST CONDITIONS AND RESULTS

4.1. Conducted Emissions Test

TEST CONFIGURATION

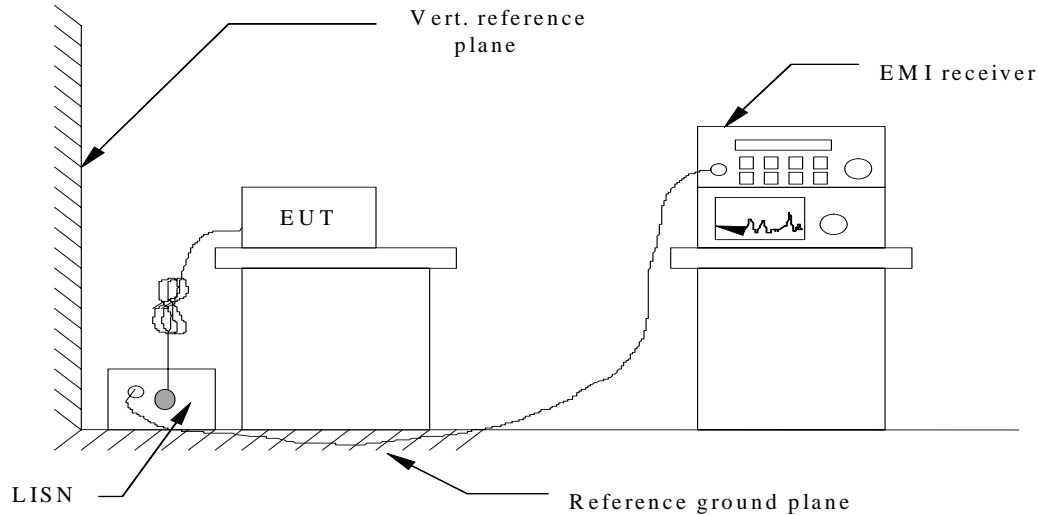

TEST PROCEDURE

- 1 The equipment was set up as per the test configuration to simulate typical actual usage per the user's manual. The EUT is a tabletop system, a wooden table with a height of 0.8 meters is used and is placed on the ground plane as per ANSI C63.4-2009.
- 2 Support equipment, if needed, was placed as per ANSI C63.4-2009.
- 3 All I/O cables were positioned to simulate typical actual usage as per ANSI C63.4-2009.
- 4 The EUT received AC120V/60Hz power through a Line Impedance Stabilization Network (LISN) which supplied power source and was grounded to the ground plane.
- 5 All support equipments received AC power from a second LISN, if any.
- 6 The EUT test program was started. Emissions were measured on each current carrying line of the EUT using a spectrum Analyzer / Receiver connected to the LISN powering the EUT. The LISN has two monitoring points: Line 1 (Hot Side) and Line 2 (Neutral Side). Two scans were taken: one with Line 1 connected to Analyzer / Receiver and Line 2 connected to a 50 ohm load; the second scan had Line 1 connected to a 50 ohm load and Line 2 connected to the Analyzer / Receiver.
- 7 Analyzer / Receiver scanned from 150 KHz to 30MHz for emissions in each of the test modes.
- 8 During the above scans, the emissions were maximized by cable manipulation.

CONDUCTED POWER LINE EMISSION LIMIT

For unintentional device, according to § 15.107(a) Line Conducted Emission Limits is as following :

Frequency (MHz)	Maximum RF Line Voltage (dB μ V)			
	CLASS A		CLASS B	
	Q.P.	Ave.	Q.P.	Ave.
0.15 - 0.50	79	66	66-56*	56-46*
0.50 - 5.00	73	60	56	46
5.00 - 30.0	73	60	60	50

For unintentional device, according to § 15.107(c) Line Conducted Emission Limits is as following :

Frequency (KHz)	Maximum RF Line Voltage	
535-1705	1000 μ V	60dB μ V

For In-House BPL devices operating as unintentional radiators below 30 MHz, the conducted emissions shall be measured in the 535 – 1705 kHz band as specified in Section 15.107(c). For In- House BPL devices operating as unintentional radiators above 30 MHz, the conducted emissions shall be measured as specified in Section 15.107(a).

TEST CONDITION

The data rate was set at the maximum rate used by the EUT, and the operating frequency of the EUT as unintentional radiator was blow 30MHz .

TEST RESULTS

Operating frequency blow 30MHz

SCAN TABLE: "Voltage (9K-30M)FIN"

Short Description: 150K-30M Voltage

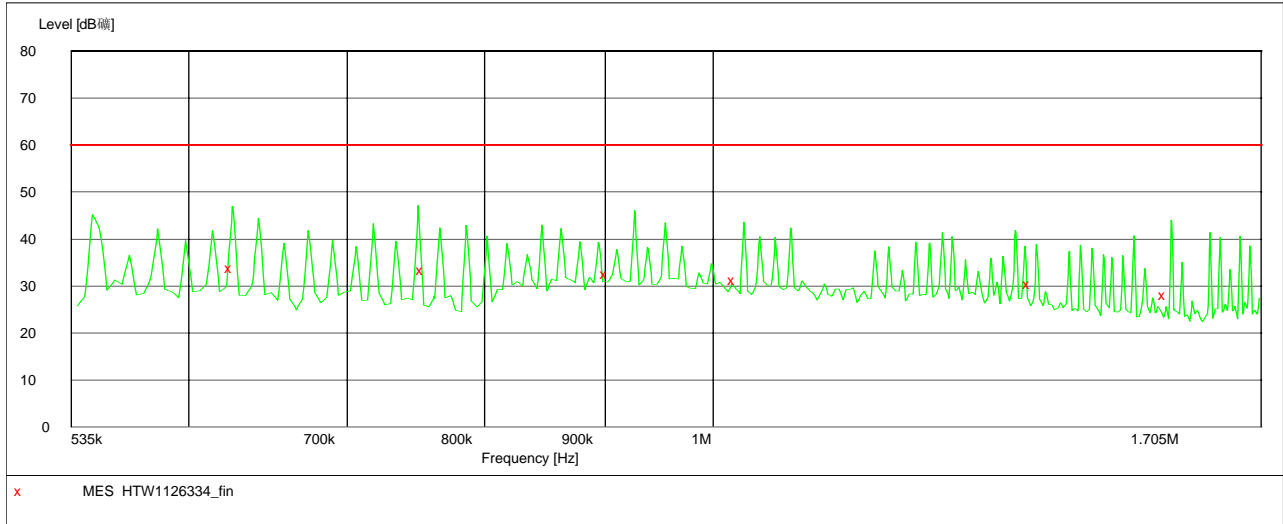

MEASUREMENT RESULT: "HTW1126334_fin"

11/26/2010 3:10PM

Frequency MHz	Level dBμV	Transd dB	Limit dBμV	Margin dB	Detector	Line	PE
0.626000	33.90	10.2	60	26.1	QP	L1	GND
0.754000	33.40	10.2	60	26.6	QP	L1	GND
0.902000	32.60	10.3	60	27.4	QP	L1	GND
1.022000	31.30	10.4	60	28.7	QP	L1	GND
1.362000	30.40	10.4	60	29.6	QP	L1	GND
1.554000	28.10	10.4	60	31.9	QP	L1	GND

Remark:

- (1) Measuring frequencies from 0.535 MHz to the 1.705 MHz.
- (2) Data of measurement within this frequency range shown "---" in the table above means the reading of emissions are attenuated more than 20dB below the permissible limits or the field strength is too small to be measured.
- (3) The IF bandwidth of EMI Test Receiver was 9KHz for measuring from 0.535 MHz to 1.705 MHz

SCAN TABLE: "Voltage (9K-30M)FIN"

Short Description: 150K-30M Voltage

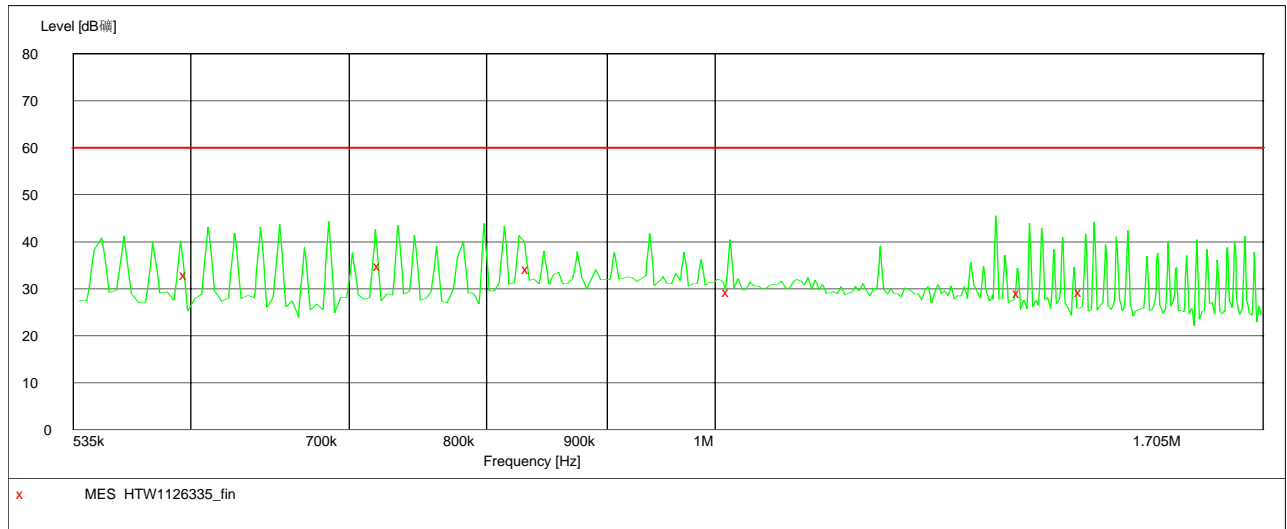

MEASUREMENT RESULT: "HTW1126335_fin"

11/26/2010 3:13PM

Frequency MHz	Level dBμV	Transd dB	Limit dBμV	Margin dB	Detector	Line	PE
0.598000	33.00	10.2	60	27.0	QP	N	GND
0.722000	34.90	10.2	60	25.1	QP	N	GND
0.834000	34.20	10.2	60	25.8	QP	N	GND
1.014000	29.40	10.4	60	30.6	QP	N	GND
1.346000	29.10	10.4	60	30.9	QP	N	GND
1.430000	29.30	10.4	60	30.7	QP	N	GND

Remark:

- (1) Measuring frequencies from 0.535 MHz to the 1.705 MHz.
- (2) Data of measurement within this frequency range shown "---" in the table above means the reading of emissions are attenuated more than 20dB below the permissible limits or the field strength is too small to be measured.
- (3) The IF bandwidth of EMI Test Receiver was 9KHz for measuring from 0.535 MHz to 1.705 MHz

4.2. Radiated Emission Test

TEST CONFIGURATION

- a) Radiated Emission Test Set-Up, Frequency below 1000MHz

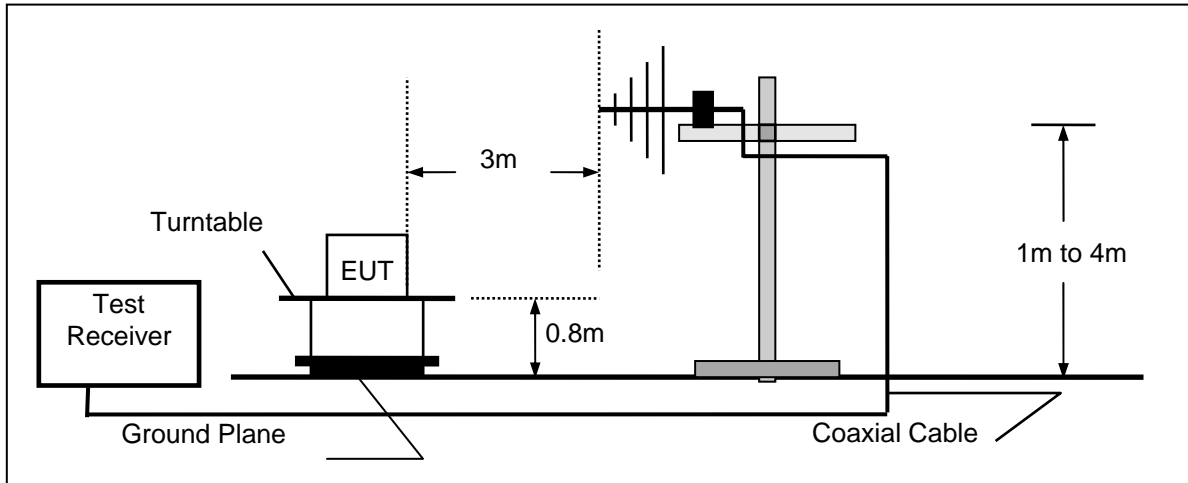

- b) Radiated Emission Test Set-Up, Frequency above 1000MHz

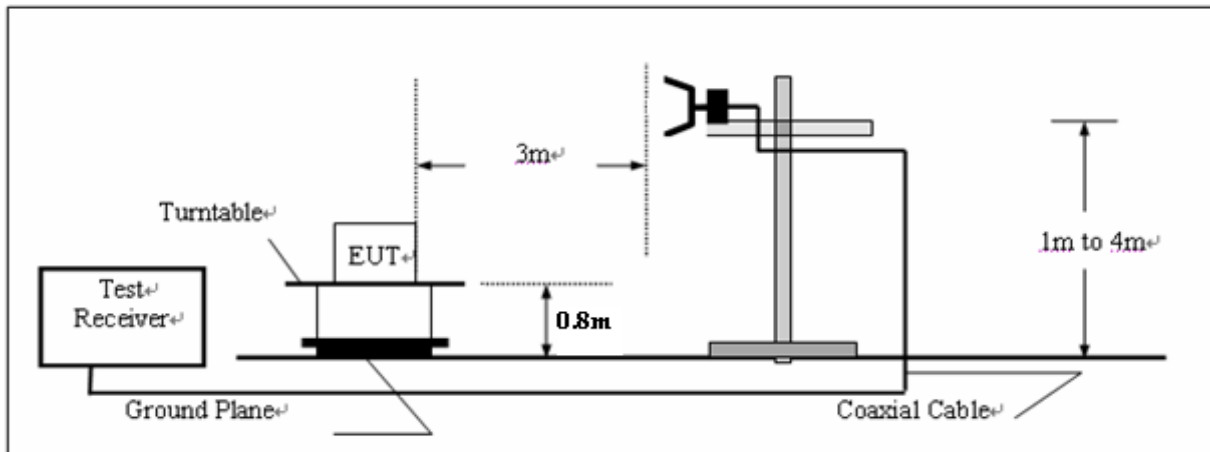

TEST PROCEDURE

1. The EUT is placed on a turntable, which is 0.8m above ground plane.
2. The turntable shall be rotated for 360 degrees to determine the position of maximum emission level.
3. EUT is set 3m away from the receiving antenna, which is varied from 1m to 4m to find out the highest emissions.
4. Maximum procedure was performed on the six highest emissions to ensure EUT compliance.
5. And also, each emission was to be maximized by changing the polarization of receiving antenna both horizontal and vertical.
6. Repeat above procedures until the measurements for all frequencies are complete.

FIELD STRENGTH CALCULATION

The field strength is calculated by adding the Antenna Factor and Cable Factor and subtracting the Amplifier Gain and Duty Cycle Correction Factor (if any) from the measured reading. The basic equation with a sample calculation is as follows:

$$FS = RA + AF + CL - AG$$

Where FS = Field Strength	CL = Cable Attenuation Factor (Cable Loss)
RA = Reading Amplitude	AG = Amplifier Gain
AF = Antenna Factor	

RADIATION LIMIT

For unintentional device, according to § 15.109(a), except for Class A digital devices, the field strength of radiated emissions from unintentional radiators at a distance of 3 meters shall not exceed the following values:

Frequency (MHz)	Distance (Meters)	Radiated (dBµV/m)	Radiated (µV/m)
30-88	3	40.0	100
88-216	3	43.5	150
216-960	3	46.0	200
Above 960	3	54.0	500

For intentional device, according to § 15.209(a), the general requirement of field strength of radiated emissions from intentional radiators at a distance of 3 meters shall not exceed the above table.

TEST CONDITION

The data rate was set at the maximum rate used by the EUT.

The highest fundamental frequency of the EUT is 150MHz, according to § 15.33(a), the radiated emission test was performed within the frequency band 30 – 2000MHz.

TEST RESULTS

Operation Mode: Maximum data rate Temperature: 20 °C Humidity: 70 % RH Polarity: Ver. / Hor.

SCAN TABLE: "test Field(30M-1G)QP"

Short Description: Field Strength(30M-1G)
 Start Stop Step Detector Meas. IF Transducer
 Frequency Frequency Width Time Bandw.
 30.0 MHz 1.0 GHz 60.0 kHz QuasiPeak 1.0 s 120 kHz HL562 10

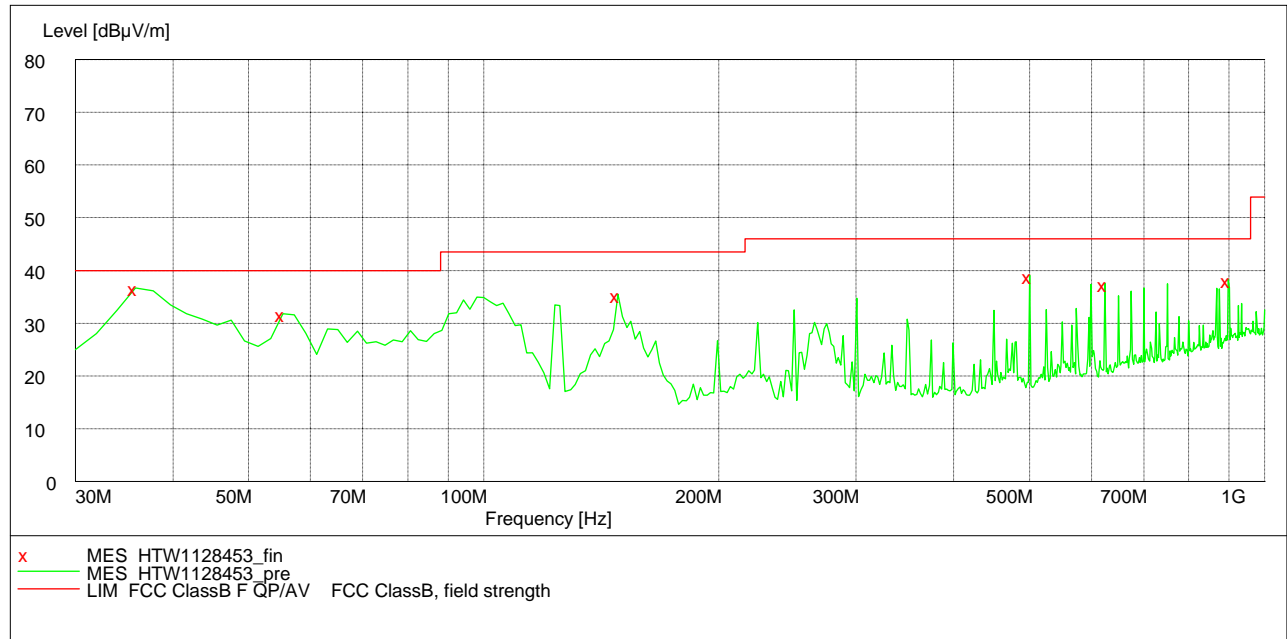

MEASUREMENT RESULT: "HTW1128453_fin"

11/29/2010 9:23AM

Frequency MHz	Level dBµV/m	Transd dB	Limit dBµV/m	Margin dB	Det.	Height cm	Azimuth deg	Polarization
35.831663	36.70	-13.1	40.0	3.3	QP	100.0	107.00	VERTICAL
55.270541	31.80	-23.6	40.0	8.2	QP	100.0	45.00	VERTICAL
148.577154	35.50	-22.1	43.5	8.0	QP	100.0	293.00	VERTICAL
500.420842	39.10	-14.3	46.0	6.9	QP	100.0	173.00	VERTICAL
624.829659	37.50	-12.1	46.0	8.5	QP	100.0	196.00	VERTICAL
898.917836	38.30	-6.6	46.0	7.7	QP	100.0	348.00	VERTICAL

Remark:

- (1) Measuring frequencies from 30 MHz to the 1 GHz.
- (2) Data of measurement within this frequency range shown "---" in the table above means the reading of emissions are attenuated more than 20dB below the permissible limits or the field strength is too small to be measured.
- (3) The IF bandwidth of EMI Test Receiver was 120KHz for measuring from 30 MHz to 1 GHz and 1 MHz for measuring above 1 GHz
- (4) The pre-test have done for the EUT in three axes and found the worst emission at position shown in test setup photos. The worst case data is recorded in the report.

SCAN TABLE: "test Field(30M-1G)QP"

Short Description:		Field Strength(30M-1G)					
Start	Stop	Step	Detector	Meas.	IF	Transducer	
Frequency	Frequency	Width		Time	Bandw.		
30.0 MHz	1.0 GHz	60.0 kHz	QuasiPeak	1.0 s	120 kHz	HL562 10	

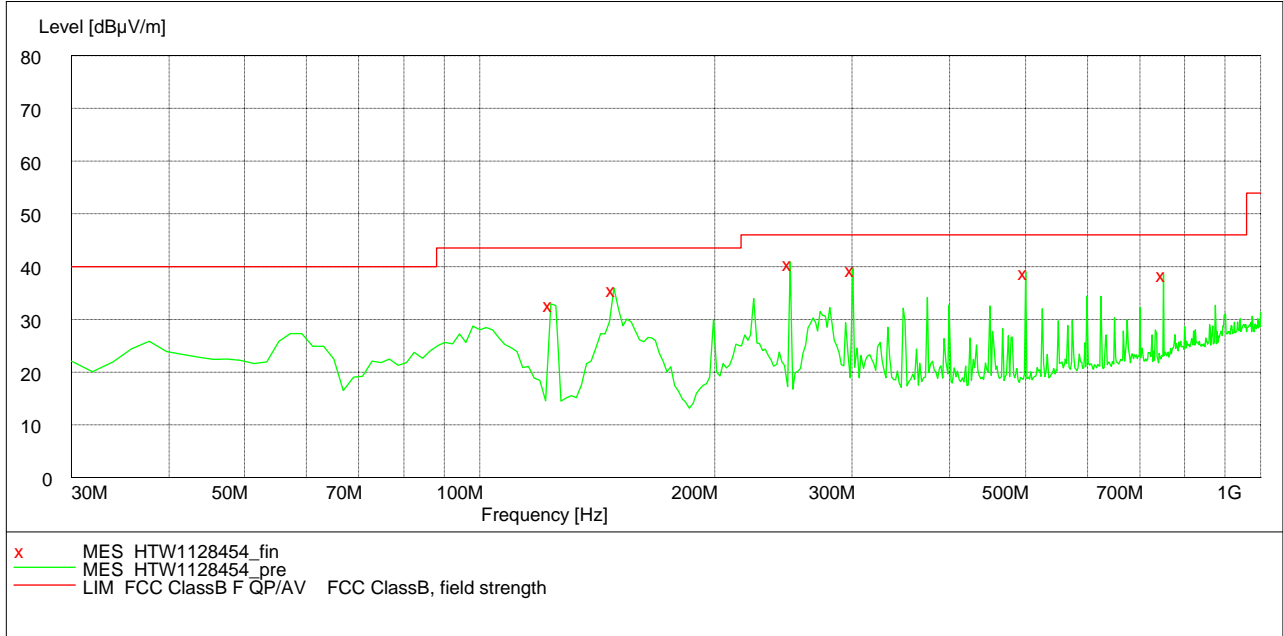

MEASUREMENT RESULT: "HTW1128454_fin"

11/29/2010 9:26AM

Frequency MHz	Level dBµV/m	Transd dB	Limit dBµV/m	Margin dB	Det.	Height cm	Azimuth deg	Polarization
123.306613	32.90	-18.4	43.5	10.6	QP	300.0	255.00	HORIZONTAL
148.577154	35.90	-22.1	43.5	7.6	QP	100.0	73.00	HORIZONTAL
249.659319	40.80	-20.0	46.0	5.2	QP	100.0	182.00	HORIZONTAL
300.200401	39.70	-18.1	46.0	6.3	QP	100.0	187.00	HORIZONTAL
500.420842	39.10	-14.3	46.0	6.9	QP	100.0	172.00	HORIZONTAL
751.182365	38.70	-10.0	46.0	7.3	QP	100.0	172.00	HORIZONTAL

Remark:

- (1) Measuring frequencies from 30 MHz to the 1 GHz.
- (2) Data of measurement within this frequency range shown "---" in the table above means the reading of emissions are attenuated more than 20dB below the permissible limits or the field strength is too small to be measured.
- (3) The IF bandwidth of EMI Test Receiver was 120KHz for measuring from 30 MHz to 1 GHz and 1 MHz for measuring above 1 GHz
- (4) The pre-test have done for the EUT in three axes and found the worst emission at position shown in test setup photos. The worst case data is recorded in the report.

SWEEP TABLE: "test (1G-18G) P"

Short Description: Field Strength(above 1G)
 Start Stop Detector Meas. IF Transducer
 Frequency Frequency Time Bandw.
 1.0 GHz 18.0 GHz MaxPeak Coupled 1 MHz HF906-10

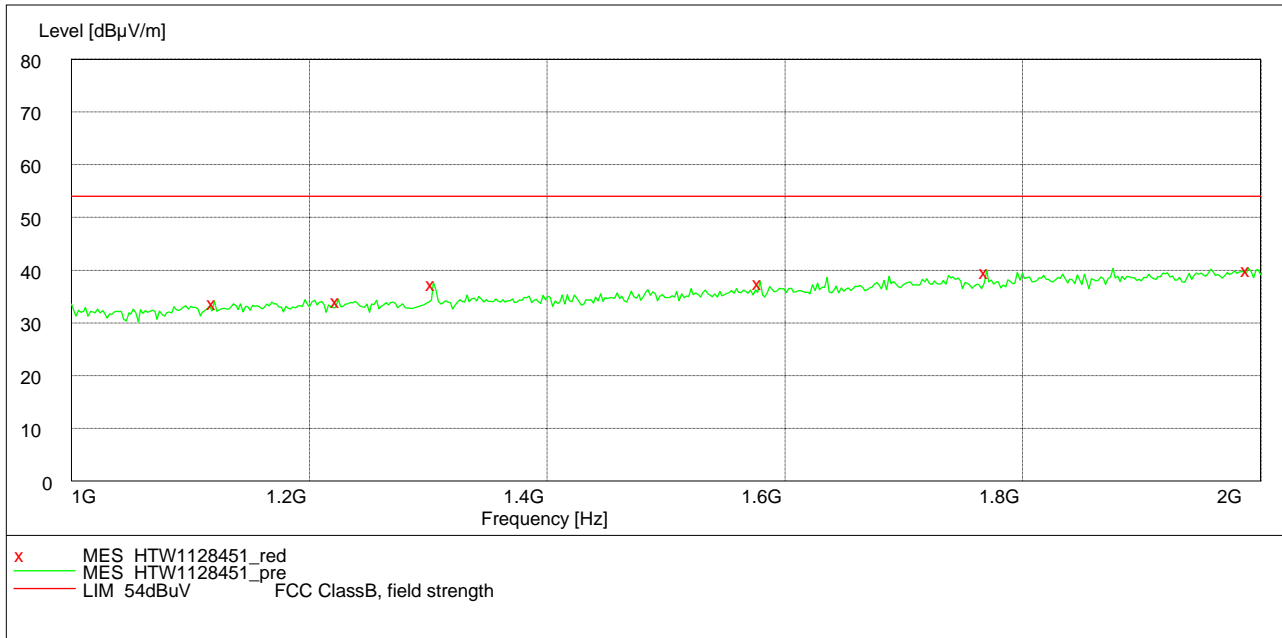

MEASUREMENT RESULT: "HTW1128451_red"

11/29/2010 9:00AM

Frequency MHz	Level dBµV/m	Transd dB	Limit dBµV/m	Margin dB	Det.	Height cm	Azimuth deg	Polarization
1120.240481	34.10	-8.7	54.0	19.9	PK	100.0	255.00	HORIZONTAL
1224.448898	34.50	-7.9	54.0	19.5	PK	100.0	161.00	HORIZONTAL
1304.609218	37.70	-7.3	54.0	16.3	PK	100.0	299.00	HORIZONTAL
1579.158317	37.90	-5.2	54.0	16.1	PK	300.0	292.00	HORIZONTAL
1769.539078	40.00	-3.3	54.0	14.0	PK	100.0	255.00	HORIZONTAL
1989.979960	40.30	-1.5	54.0	13.7	PK	300.0	81.00	HORIZONTAL

Remark:

- (1) Measuring frequencies from 1 GHz to the 2 GHz.
- (2) Data of measurement within this frequency range shown "----" in the table above means the reading of emissions are attenuated more than 20dB below the permissible limits or the field strength is too small to be measured.
- (3) The RBW of EMI Test Receiver was 1MHz and the VBW was 3MHz for measuring from 1 GHz to 2 GHz.
- (4) The average measurement was not performed when the peak measured data under the limit of average detection.
- (5) The pre-test have done for the EUT in three axes and found the worst emission at position shown in test setup photos. The worst case data is recorded in the report.

SWEEP TABLE: "test (1G-18G) P"

Short Description:		Field Strength(above 1G)			
Start	Stop	Detector	Meas.	IF	Transducer
Frequency	Frequency		Time	Bandw.	
1.0 GHz	18.0 GHz	MaxPeak	Coupled	1 MHz	HF906-10

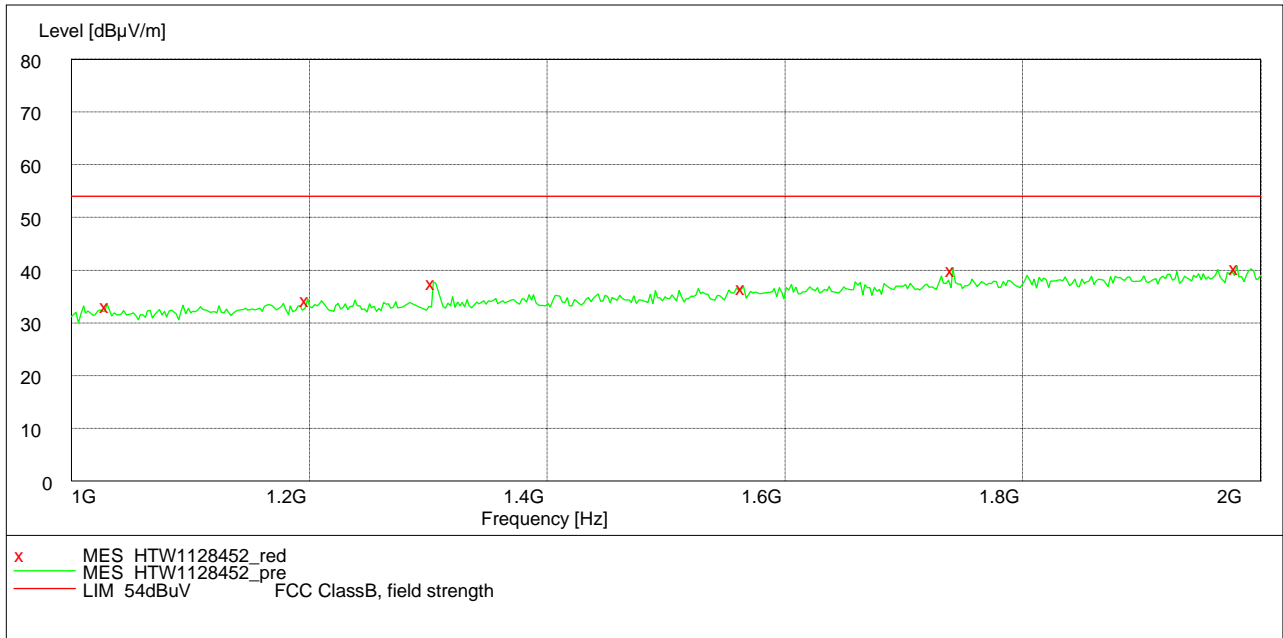

MEASUREMENT RESULT: "HTW1128452_red"

11/29/2010 9:02AM

Frequency MHz	Level dBµV/m	Transd dB	Limit dBµV/m	Margin dB	Det.	Height cm	Azimuth deg	Polarization
1030.060120	33.50	-9.5	54.0	20.5	PK	100.0	337.00	VERTICAL
1198.396794	34.60	-8.1	54.0	19.4	PK	100.0	65.00	VERTICAL
1304.609218	37.80	-7.3	54.0	16.2	PK	100.0	255.00	VERTICAL
1565.130261	36.90	-5.3	54.0	17.1	PK	100.0	45.00	VERTICAL
1741.482966	40.40	-3.6	54.0	13.6	PK	100.0	255.00	VERTICAL
1979.959920	40.80	-1.6	54.0	13.2	PK	100.0	166.00	VERTICAL

Remark:

- (1) Measuring frequencies from 1 GHz to the 2 GHz.
- (2) Data of measurement within this frequency range shown "---" in the table above means the reading of emissions are attenuated more than 20dB below the permissible limits or the field strength is too small to be measured.
- (3) The RBW of EMI Test Receiver was 1MHz and the VBW was 3MHz for measuring from 1 GHz to 2 GHz.
- (4) The average measurement was not performed when the peak measured data under the limit of average detection.
- (5) The pre-test have done for the EUT in three axes and found the worst emission at position shown in test setup photos. The worst case data is recorded in the report.

5. Test Setup Photos of the EUT

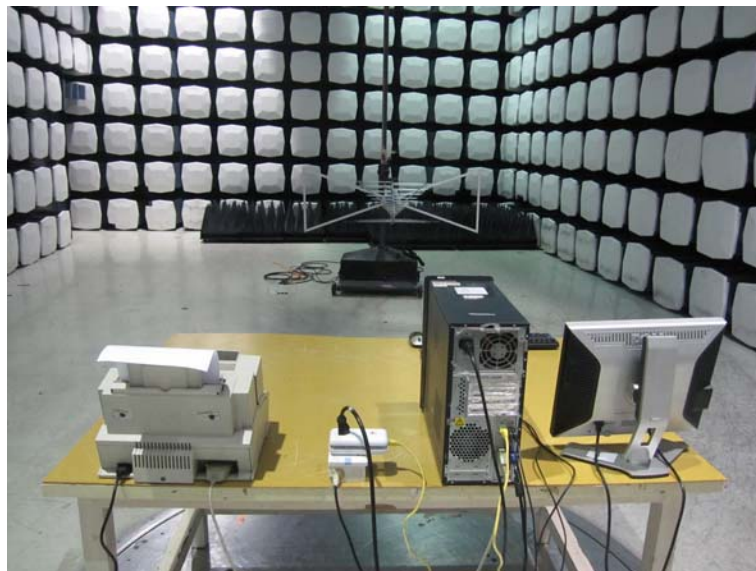

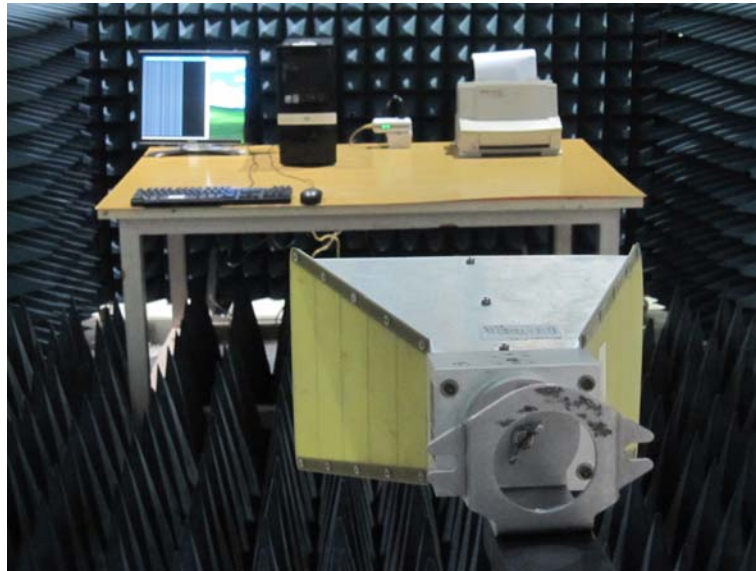

6. External and Internal Photos of the EUT

External Photos



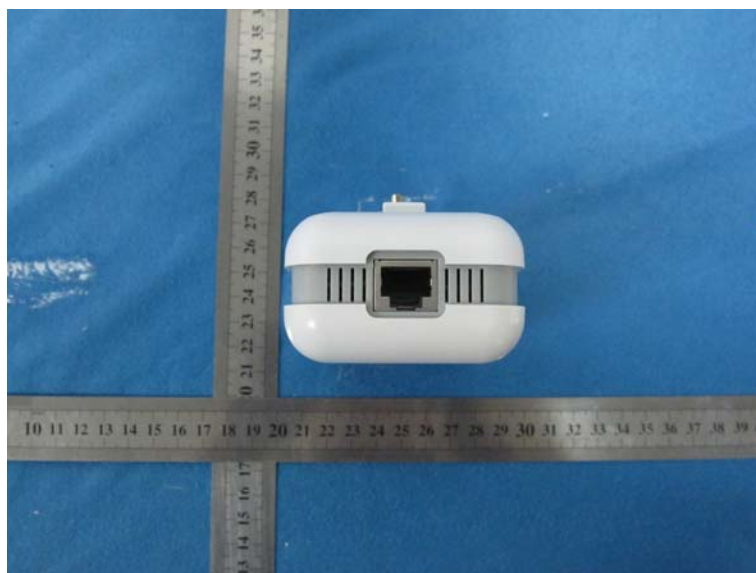

Internal Photos

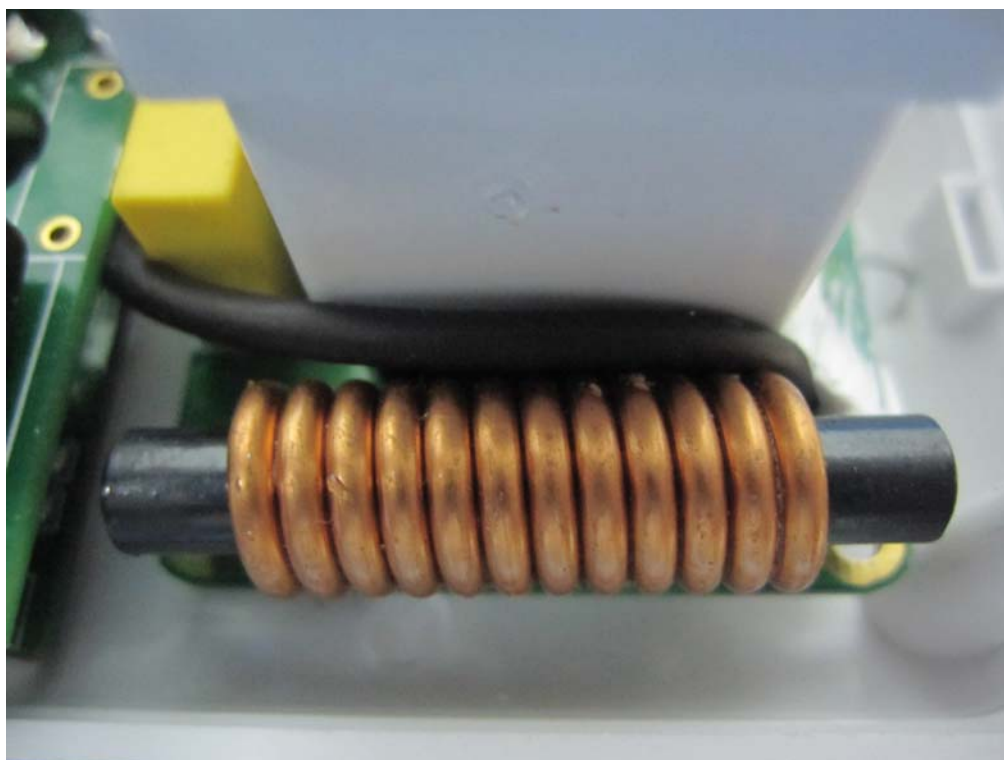

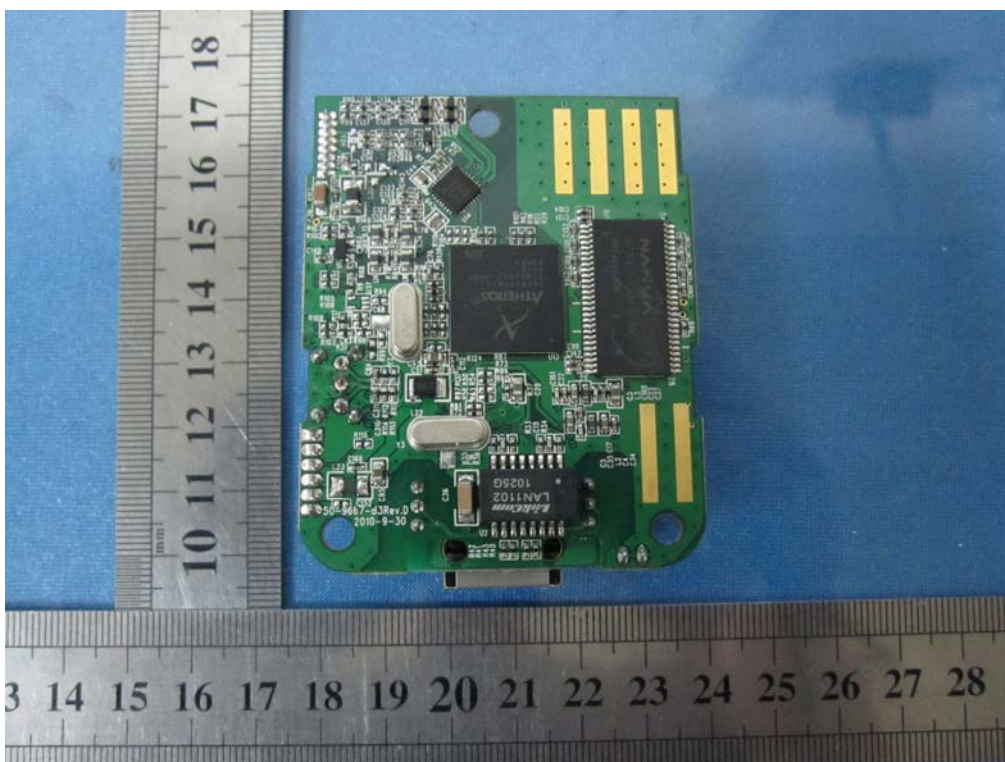

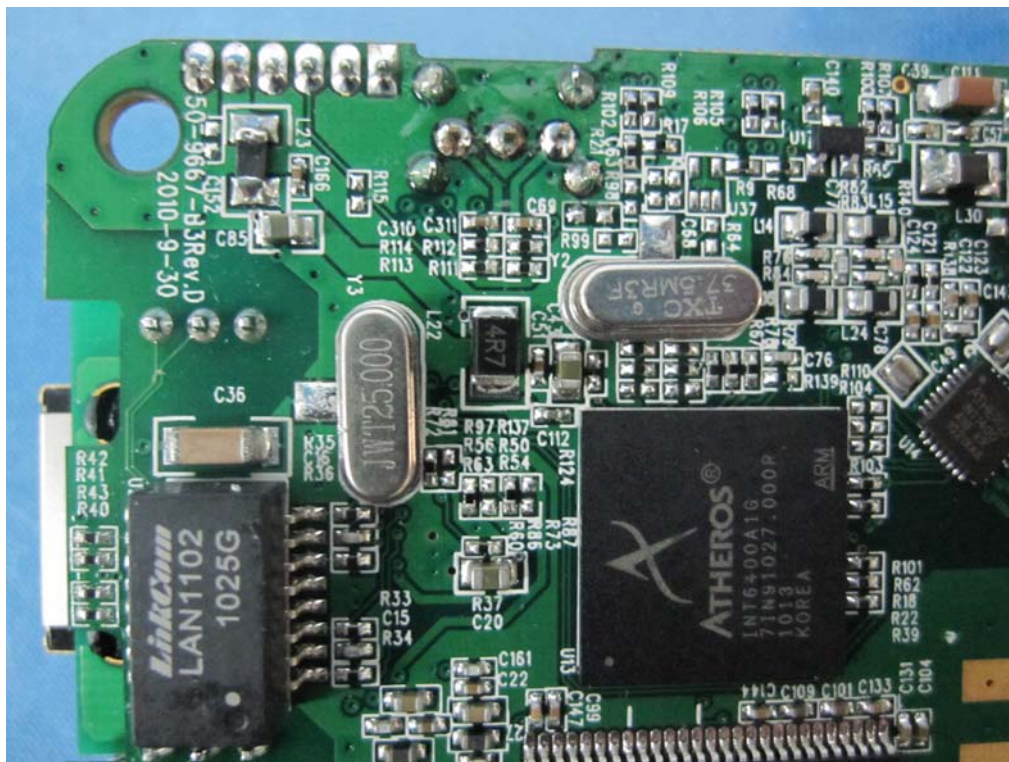
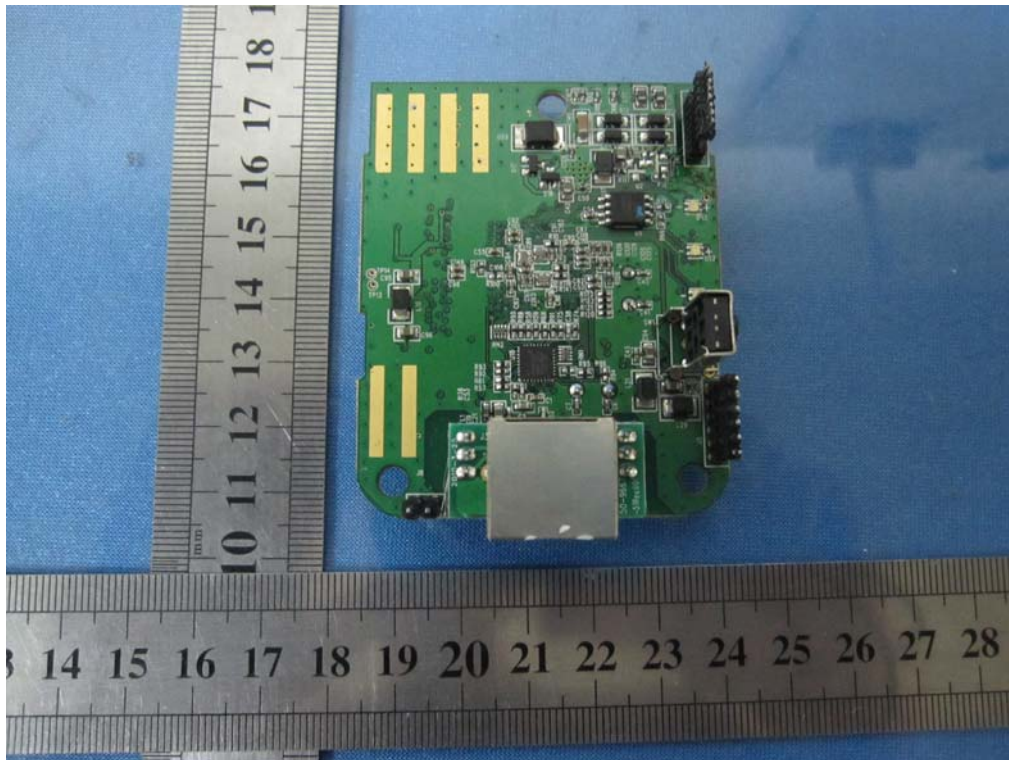

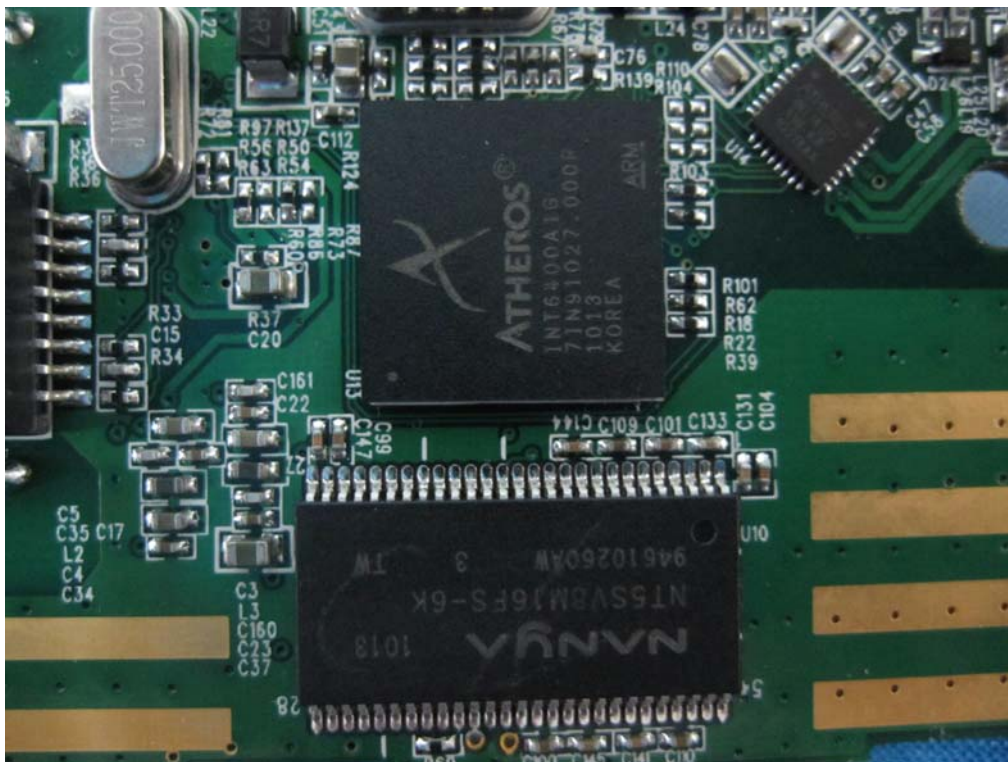
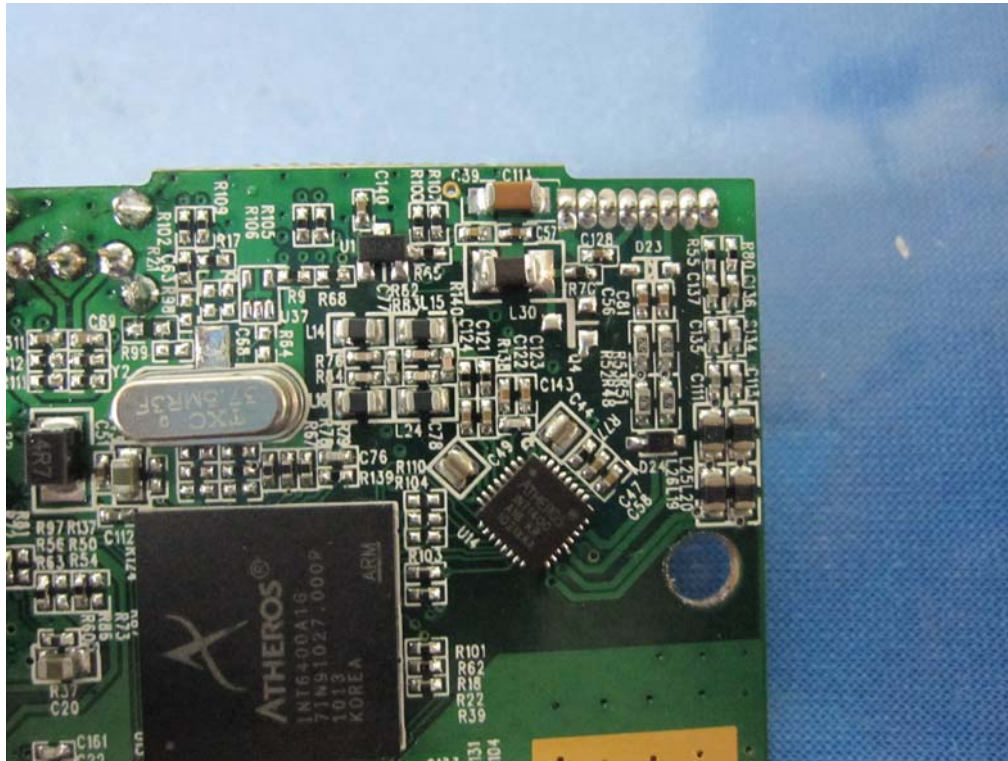

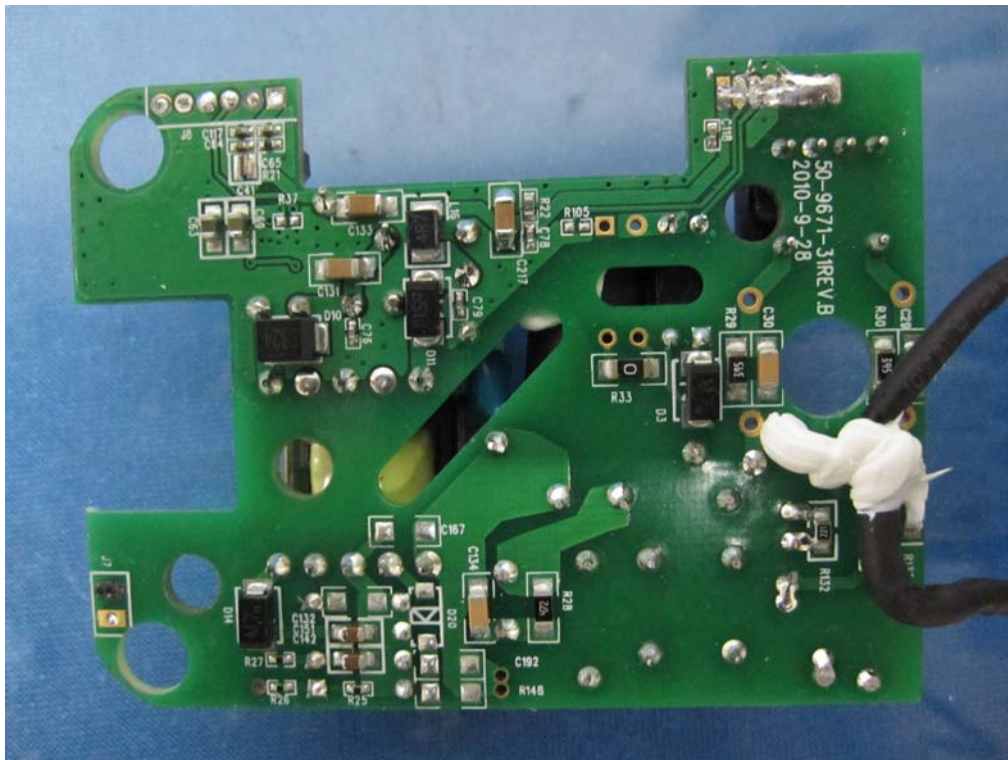
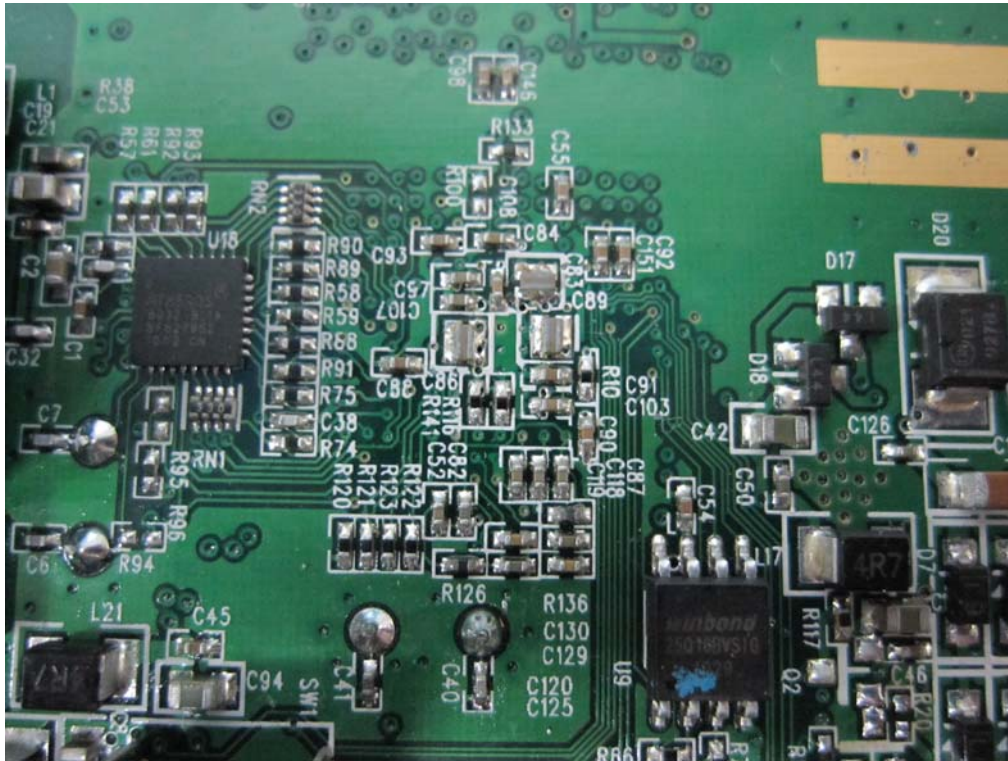

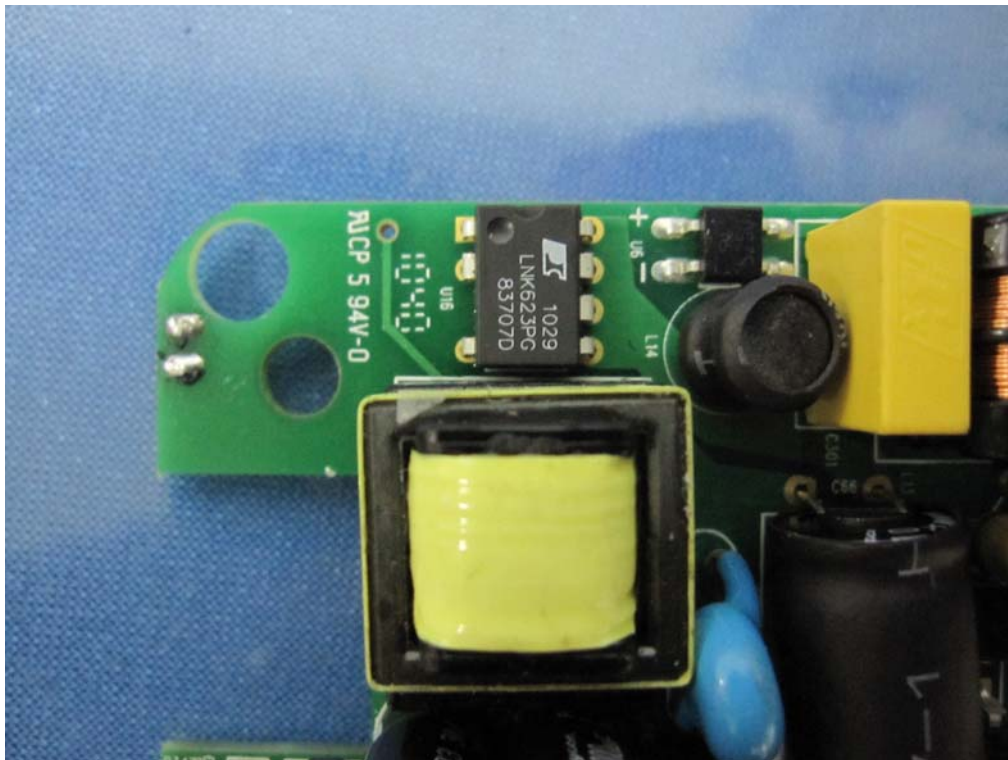
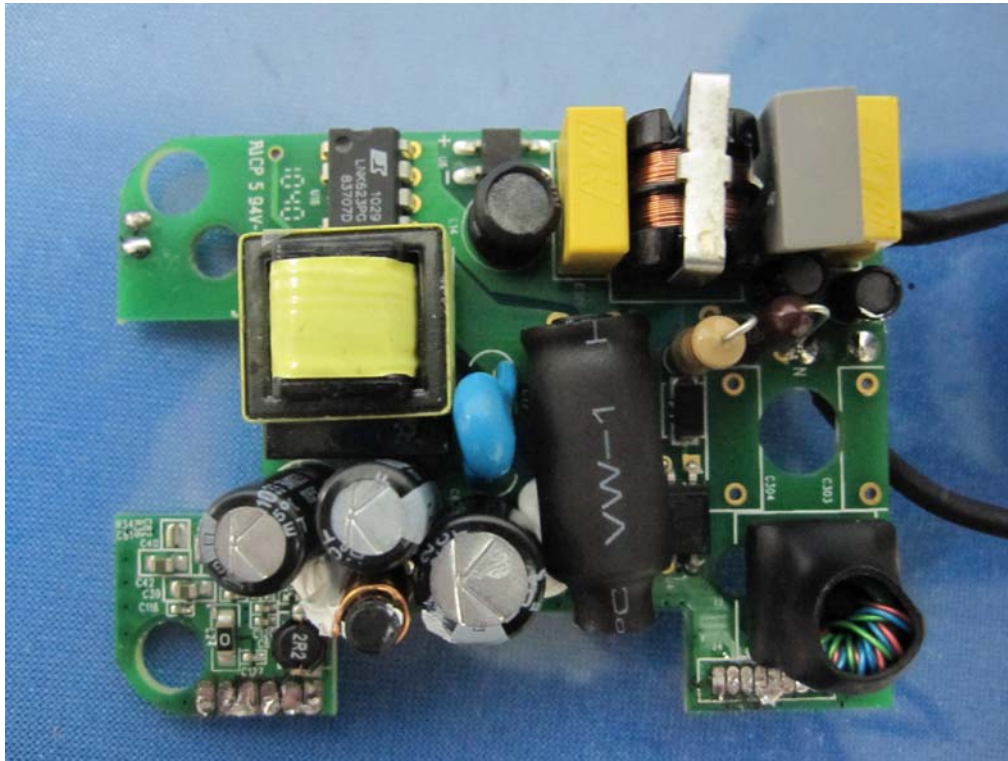

.....End of Report.....