

### Channel 06 (2437MHz)

#### 100kHz PSD Reference Level

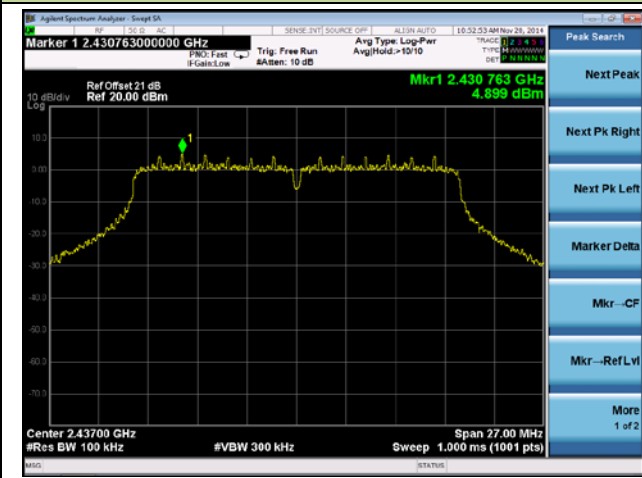

#### Spurious Emission

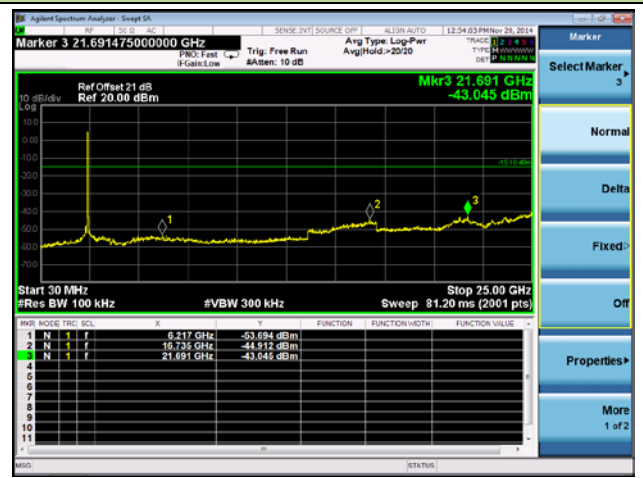

### Channel 11 (2462MHz)

#### 100kHz PSD Reference Level

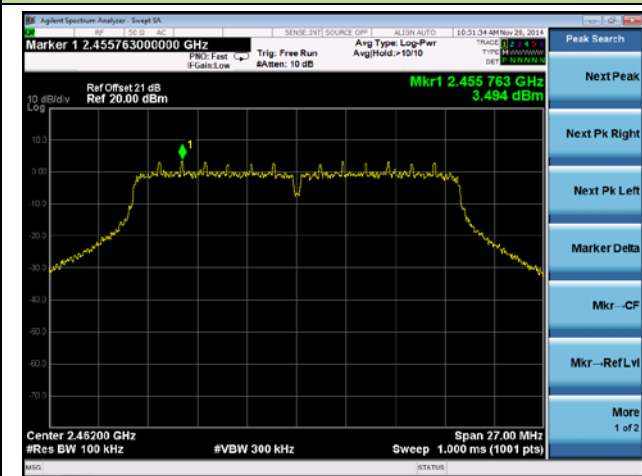

#### High Band Edge

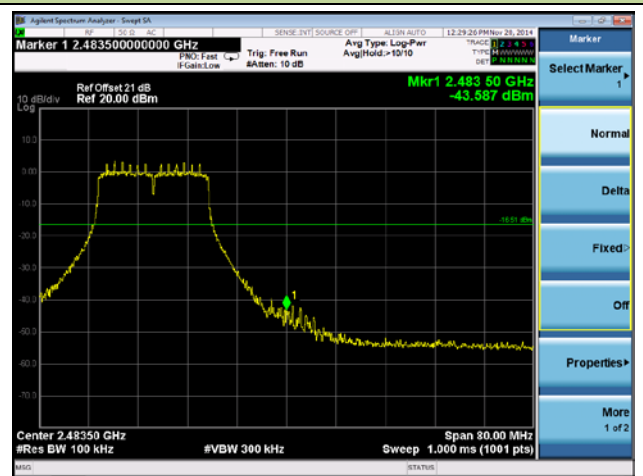

#### Spurious Emission

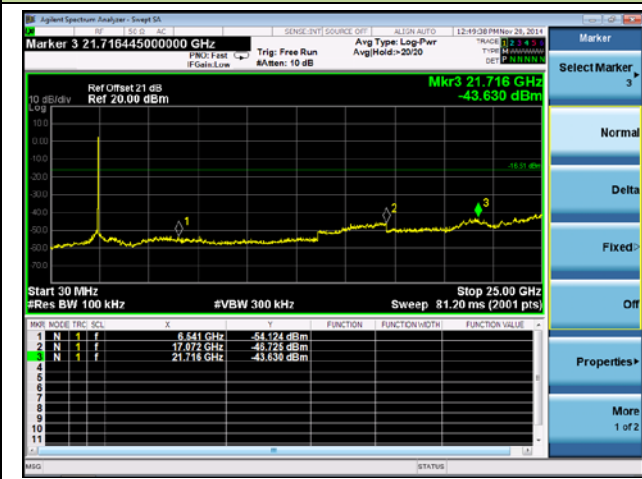

## 802.11n-HT40 Out-of-Band Emissions - Ant 0 / Ant 0 + 1

### Channel 03 (2422MHz)

#### 100kHz PSD Reference Level

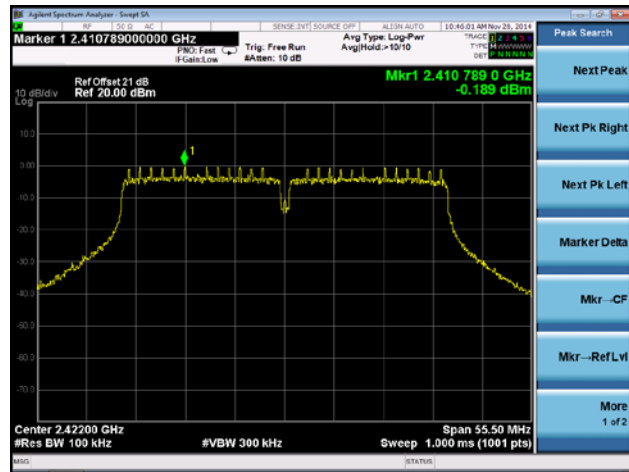

#### Low Band Edge

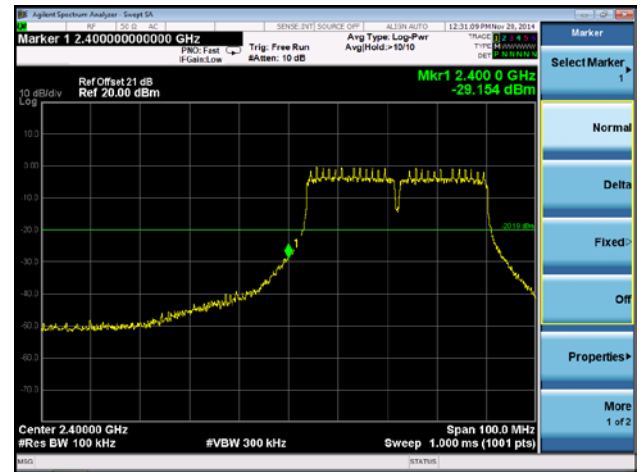

#### Spurious Emission

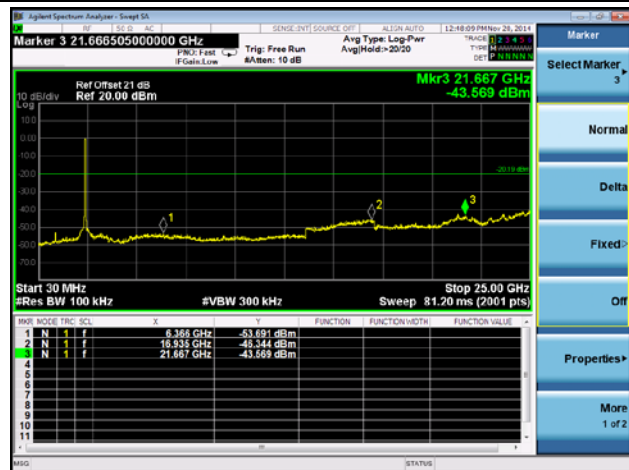

### Channel 06 (2437MHz)

#### 100kHz PSD Reference Level

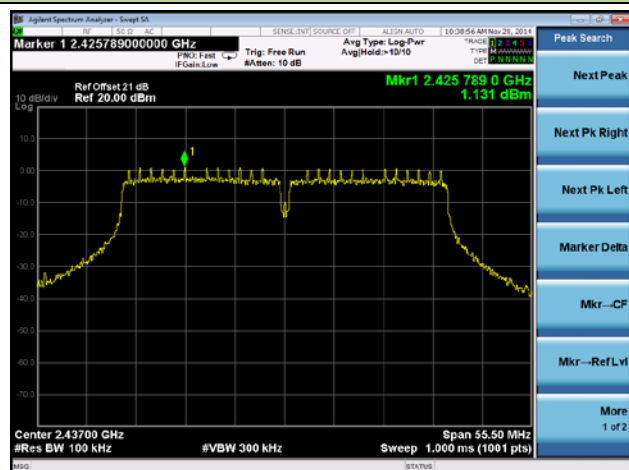

#### Spurious Emission

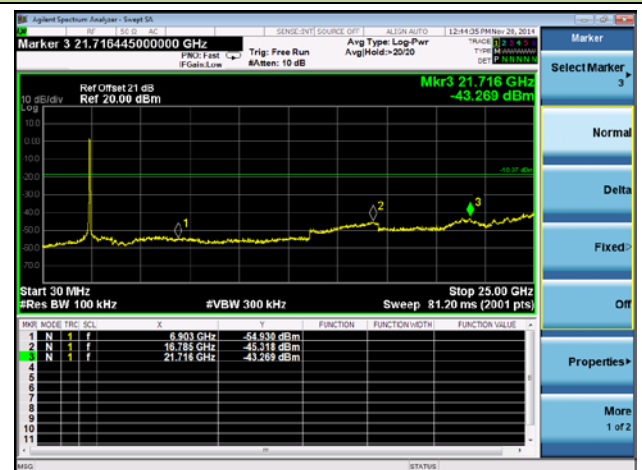

### Channel 09 (2452MHz)

#### 100kHz PSD Reference Level

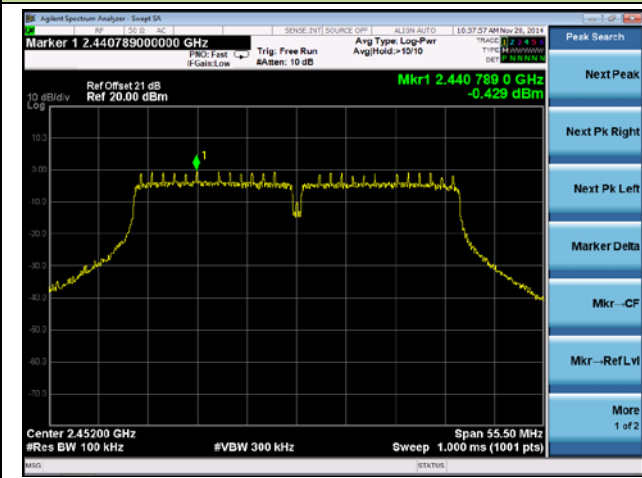

#### High Band Edge

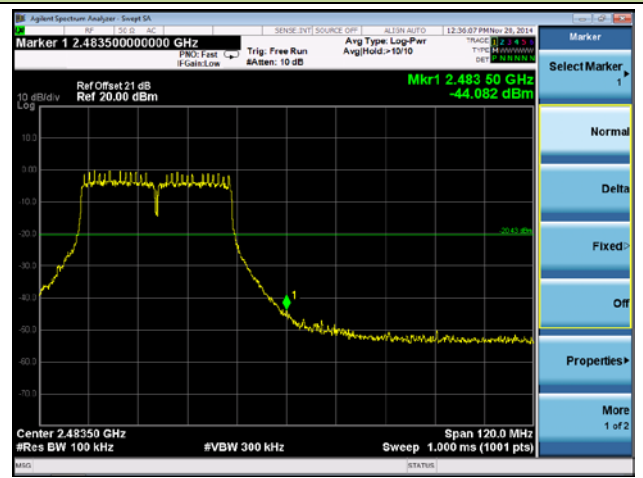

#### Spurious Emission

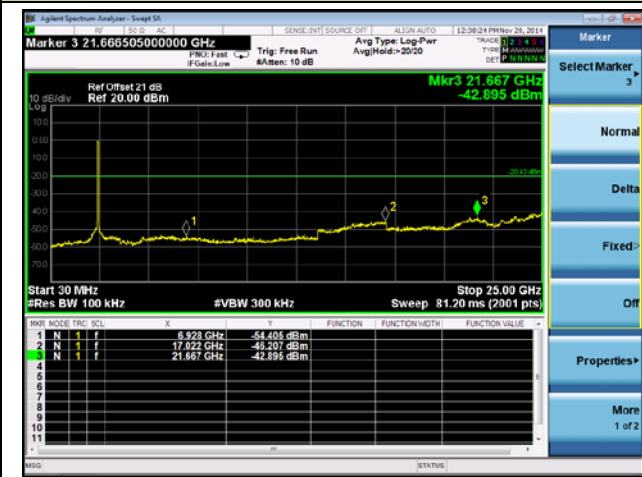

## 802.11b Out-of-Band Emissions - Ant 1 / Ant 0 + 1

### Channel 01 (2412MHz)

#### 100kHz PSD Reference Level



#### Low Band Edge

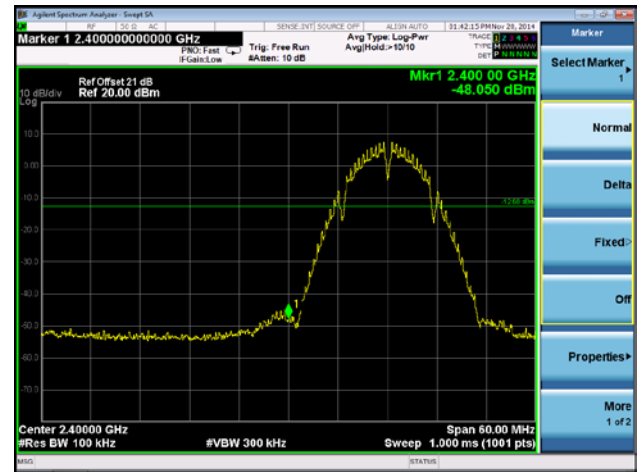

#### Spurious Emission

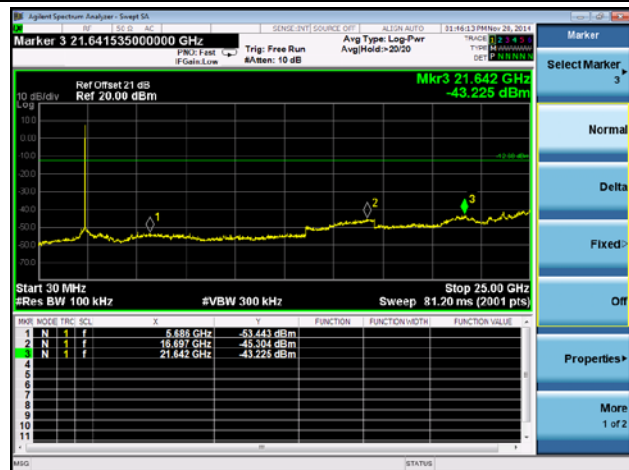

### Channel 06 (2437MHz)

#### 100kHz PSD Reference Level

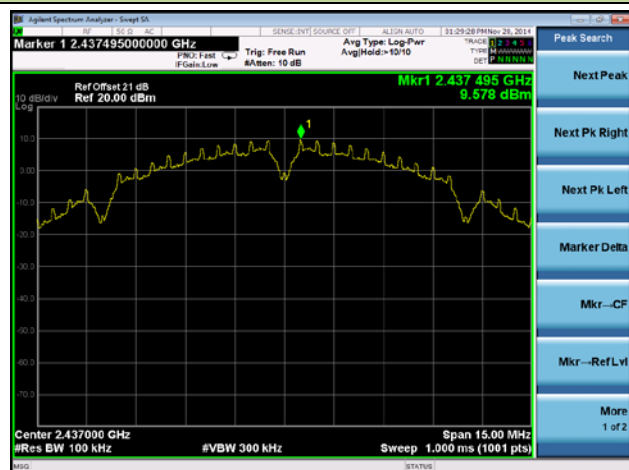

#### Spurious Emission

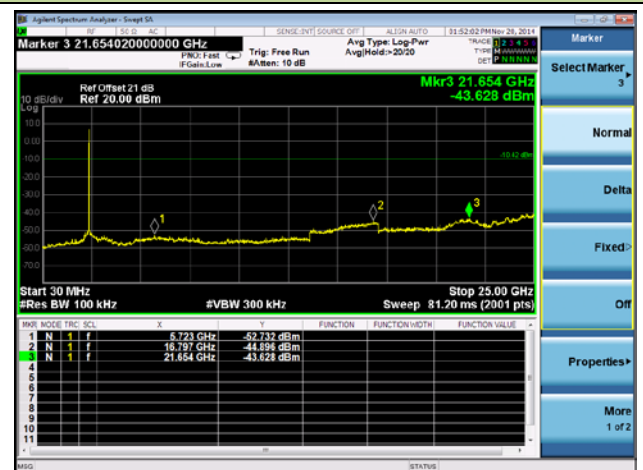

### Channel 11 (2462MHz)

#### 100kHz PSD Reference Level



#### High Band Edge

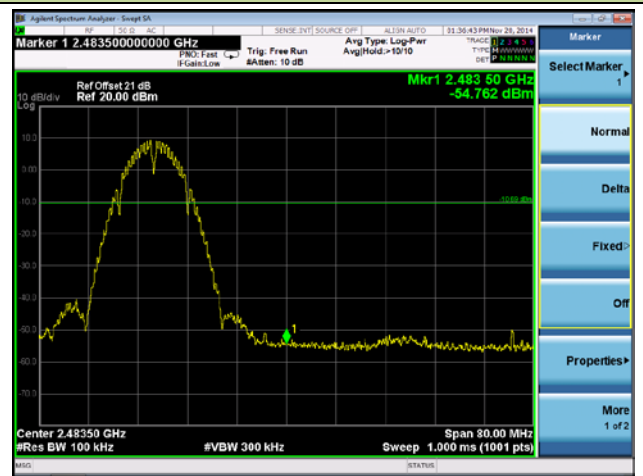

#### Spurious Emission

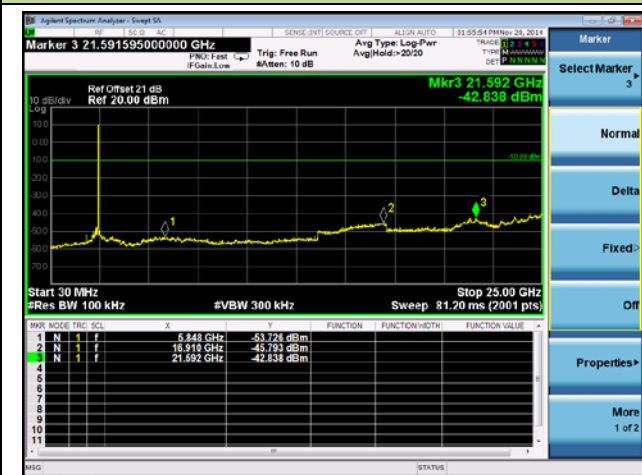

### 802.11g Out-of-Band Emissions - Ant 1 / Ant 0 + 1

### Channel 01 (2412MHz)

#### 100kHz PSD Reference Level

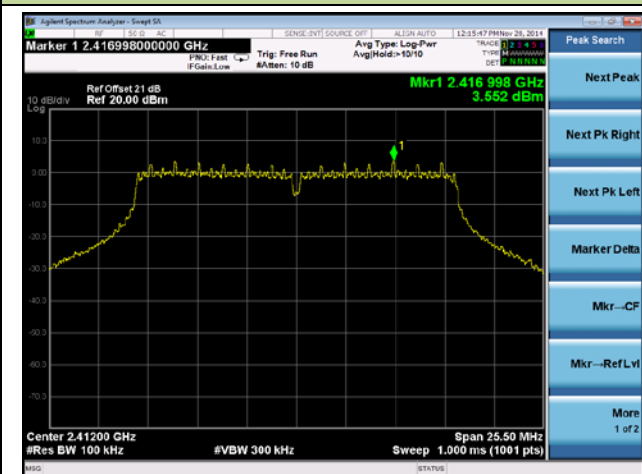

#### Low Band Edge

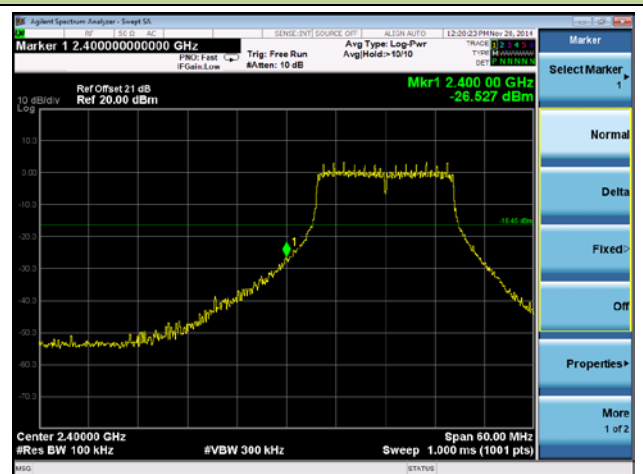

### Spurious Emission

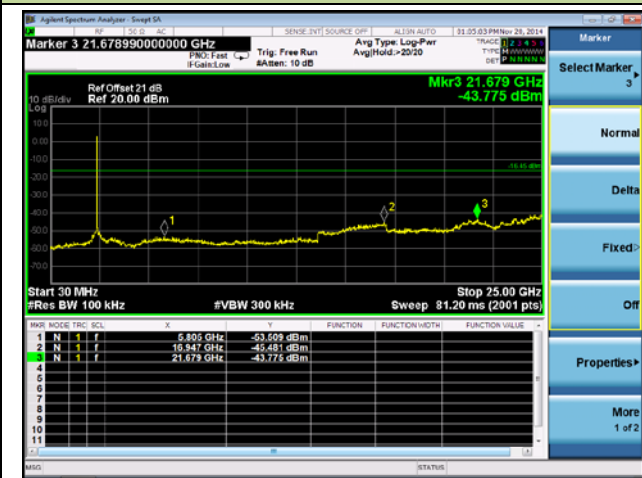

### Channel 06 (2437MHz)

#### 100kHz PSD Reference Level

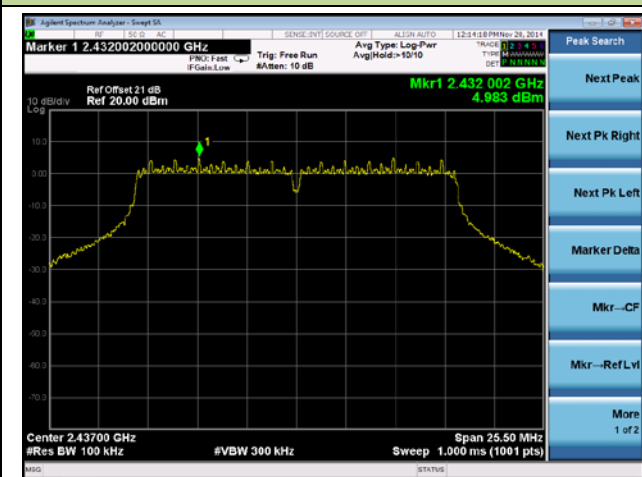

#### Spurious Emission

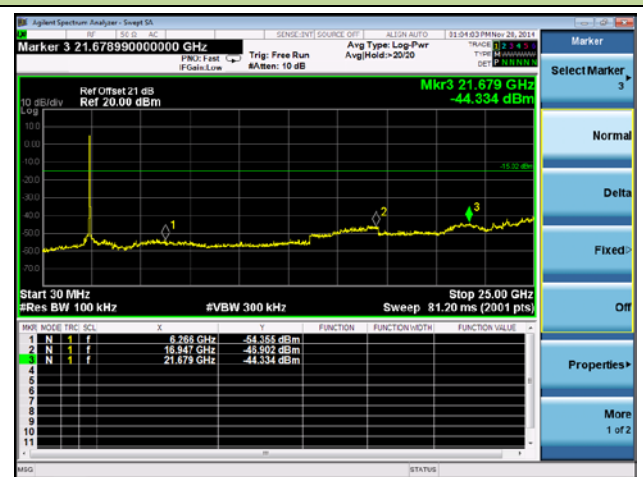

### Channel 11 (2462MHz)

#### 100kHz PSD Reference Level

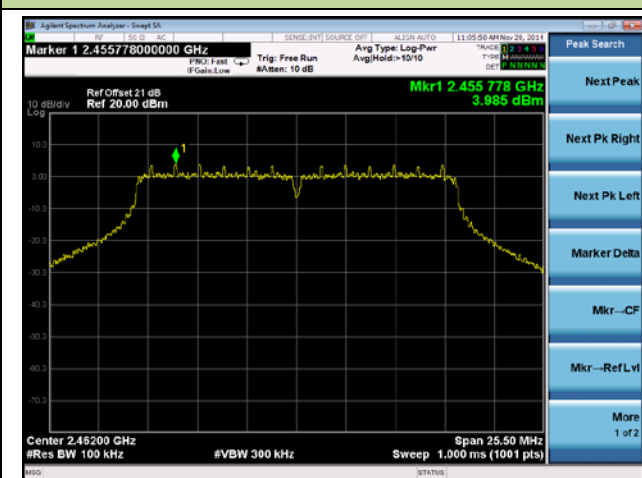

#### High Band Edge

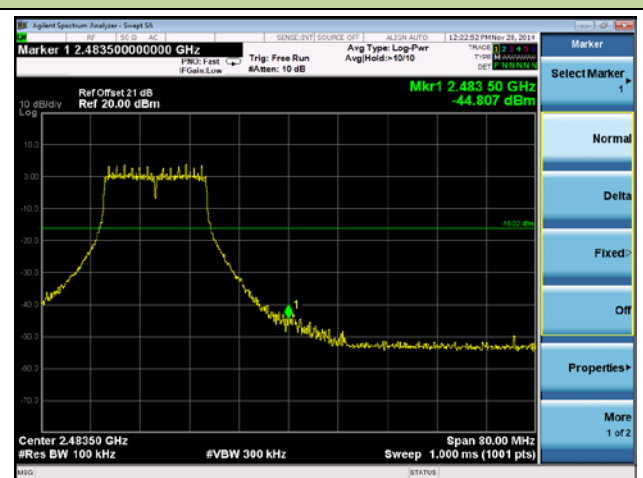

### Spurious Emission

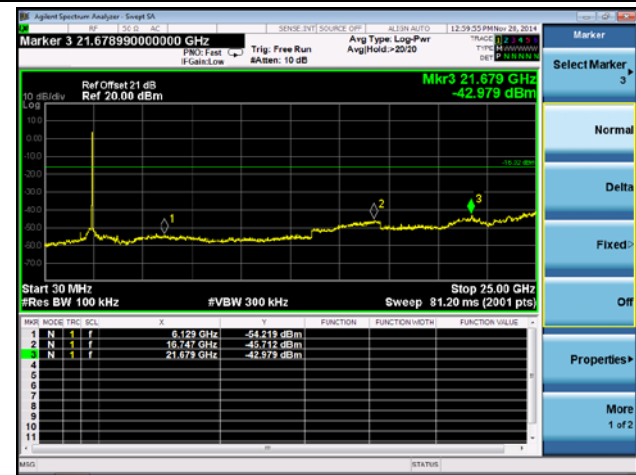

### 802.11n-HT20 Out-of-Band Emissions - Ant 1 / Ant 0 + 1

#### Channel 01 (2412MHz)

#### 100kHz PSD Reference Level

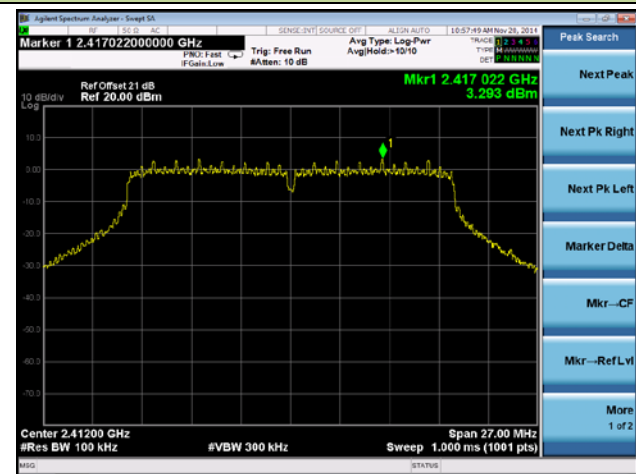

#### Low Band Edge

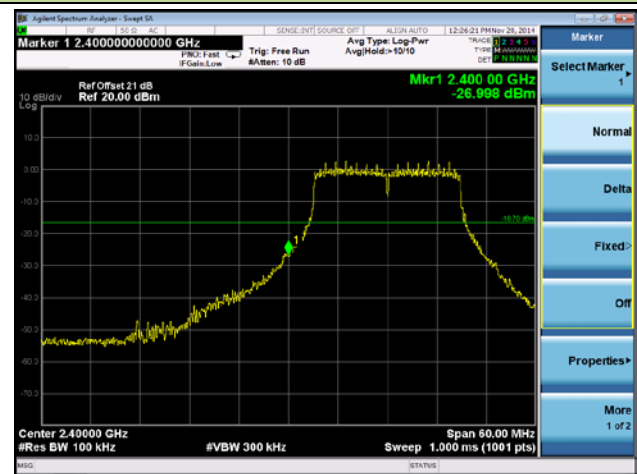

### Spurious Emission

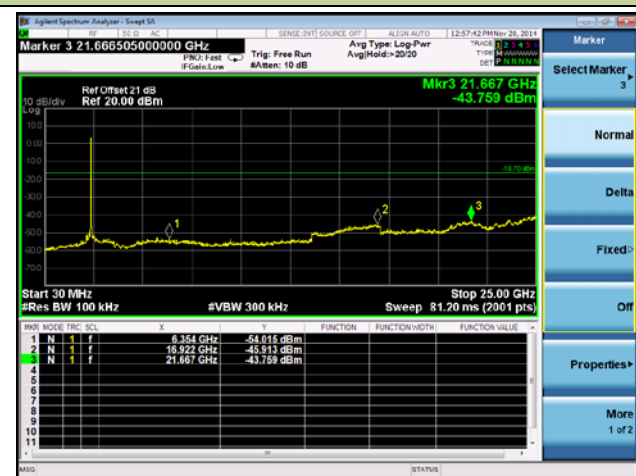

### Channel 06 (2437MHz)

#### 100kHz PSD Reference Level

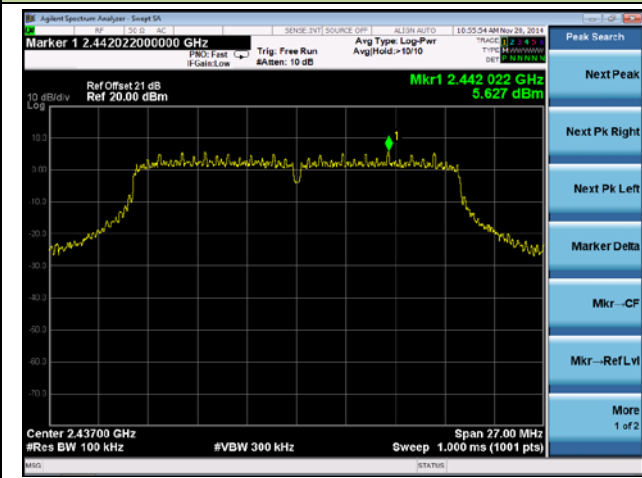

#### Spurious Emission

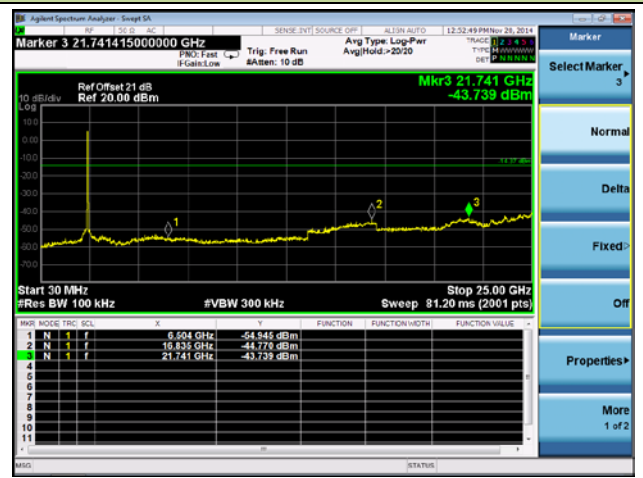

### Channel 11 (2462MHz)

#### 100kHz PSD Reference Level

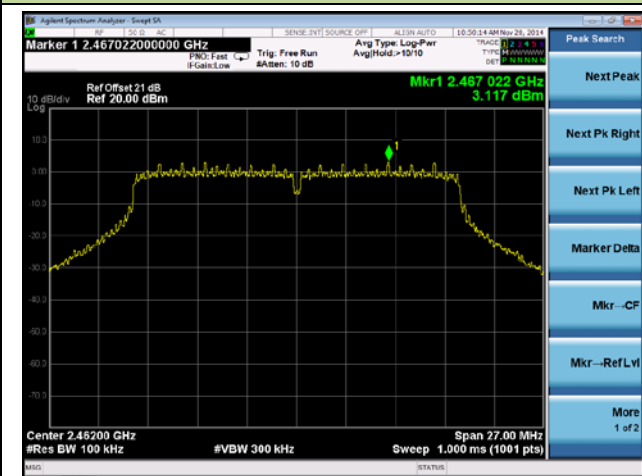

#### High Band Edge

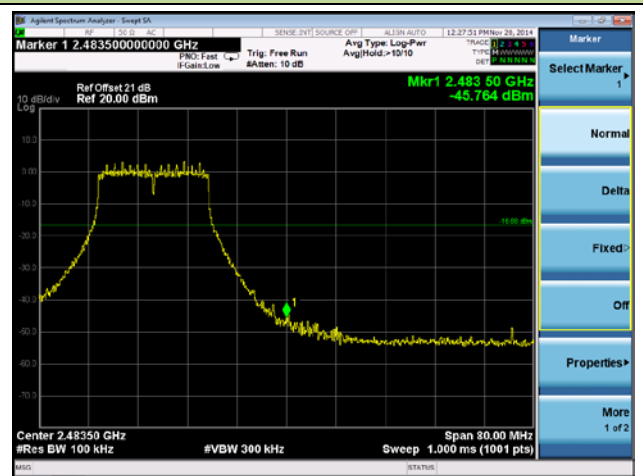

#### Spurious Emission

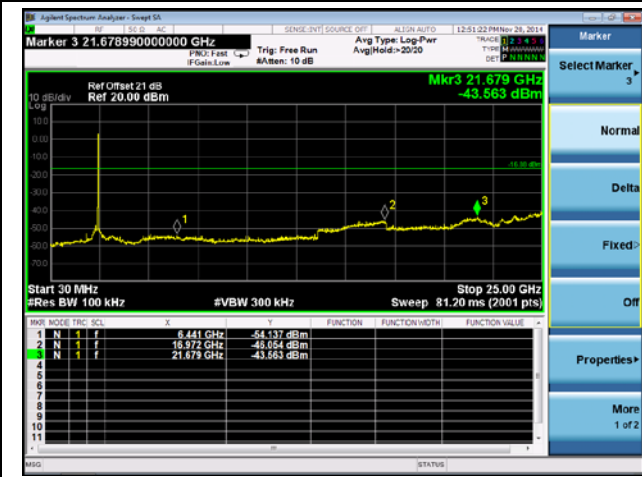



## 802.11n-HT40 Out-of-Band Emissions - Ant 1 / Ant 0 + 1

### Channel 03 (2422MHz)

#### 100kHz PSD Reference Level

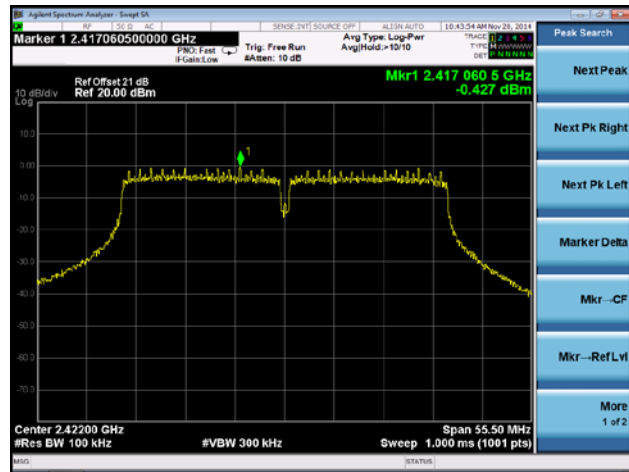

#### Low Band Edge

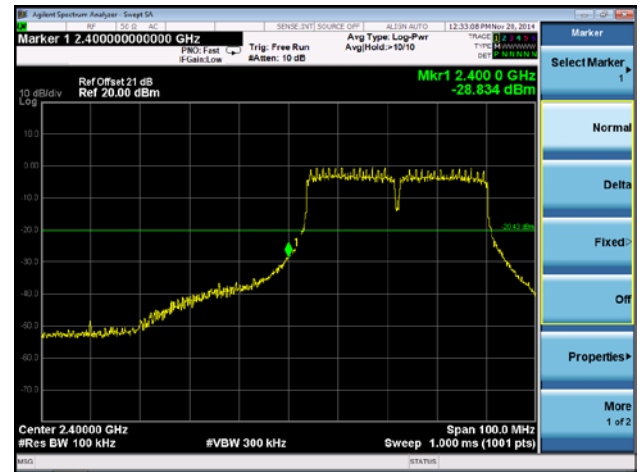

#### Spurious Emission

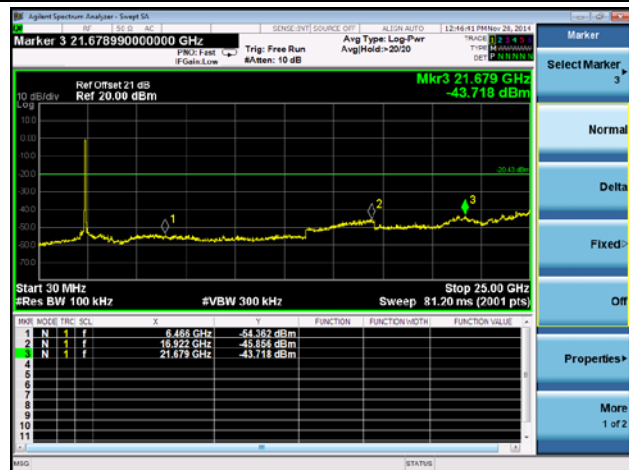

### Channel 06 (2437MHz)

#### 100kHz PSD Reference Level

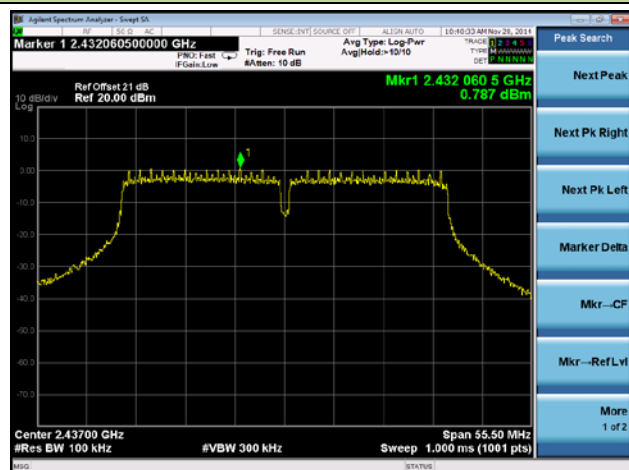

#### Spurious Emission



### Channel 09 (2452MHz)

#### 100kHz PSD Reference Level

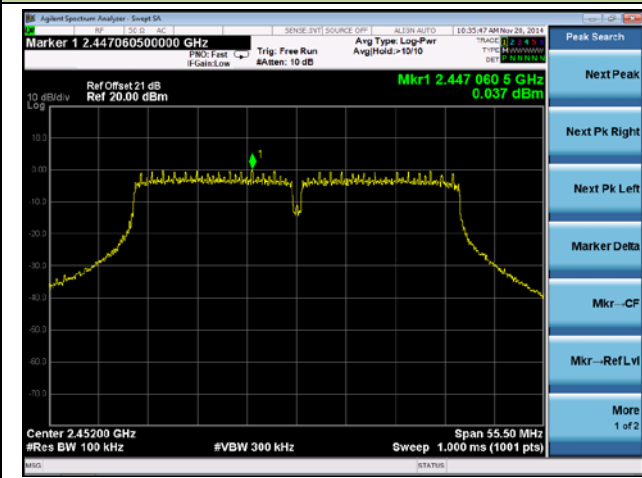

#### High Band Edge

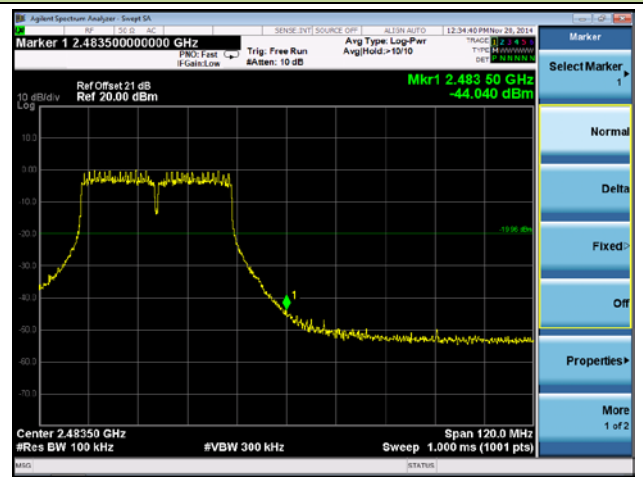

#### Spurious Emission

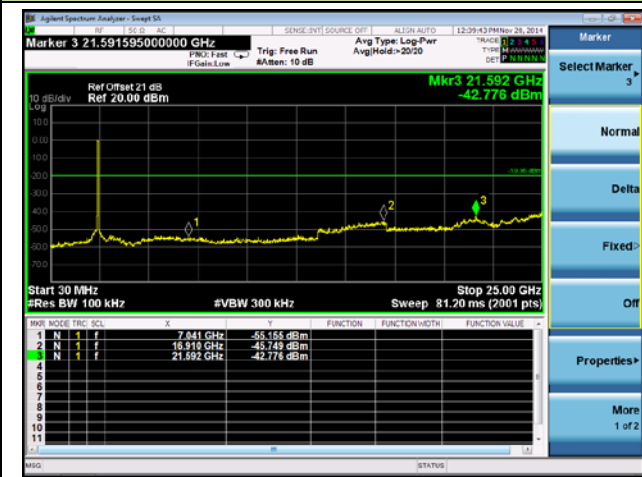

## 7.6. Radiated Spurious Emission Measurement

### 7.6.1. Test Limit

All out of band emissions appearing in a restricted band as specified in Section 15.205 of the Title 47 CFR must not exceed the limits shown in Table per Section 15.209.

FCC Part 15 Subpart C Paragraph 15.209		
Frequency [MHz]	Field Strength [V/m]	Measured Distance [Meters]
0.009 - 0.490	2400/F (kHz)	300
0.490 - 1.705	24000/F (kHz)	30
1.705 - 30	30	30
30 - 88	100	3
88 - 216	150	3
216 - 960	200	3
Above 960	500	3

### 7.6.2. Test Procedure Used

KDB 558074 D01v03r02 - Section 12.2.3 (quasi-peak measurements)

KDB 558074 D01v03r02 - Section 12.2.4 (peak power measurements)

KDB 558074 D01v03r02 - Section 12.2.5 (average power measurements)

### 7.6.3. Test Setting

#### Peak Field Strength Measurements per Section 12.2.4 of KDB 558074 D01v03r02

1. Analyzer center frequency was set to the frequency of the radiated spurious emission of interest
2. RBW = as specified in Table 1
3. VBW = 3MHz
4. Detector = peak
5. Sweep time = auto couple

6. Trace mode = max hold
7. Trace was allowed to stabilize

**Table 1 - RBW as a function of frequency**

Frequency	RBW
9 ~ 150 kHz	200 ~ 300 Hz
0.15 ~ 30 MHz	9 ~ 10 kHz
30 ~ 1000 MHz	100 ~ 120 kHz
> 1000 MHz	1 MHz

**Average Field Strength Measurements per Section 12.2.5.3 of KDB 558074 D01v03r02**

1. Analyzer center frequency was set to the frequency of the radiated spurious emission of interest
2. RBW = 1MHz
3. VBW  $\geq$  1/T
4. De As an alternative, the instrument may be set to linear detector mode. Ensure that video filtering is applied in linear voltage domain (rather than in a log or dB domain). Some instruments require linear display mode in order to accomplish this. Others have a setting for Average-VBW Type, which can be set to "Voltage" regardless of the display mode
5. Detector = Peak
6. Sweep time = auto
7. Trace mode = max hold
8. Allow max hold to run for at least 50 times (1/duty cycle) traces

### 7.6.4. Test Setup

#### 9kHz ~ 30MHz Test Setup:

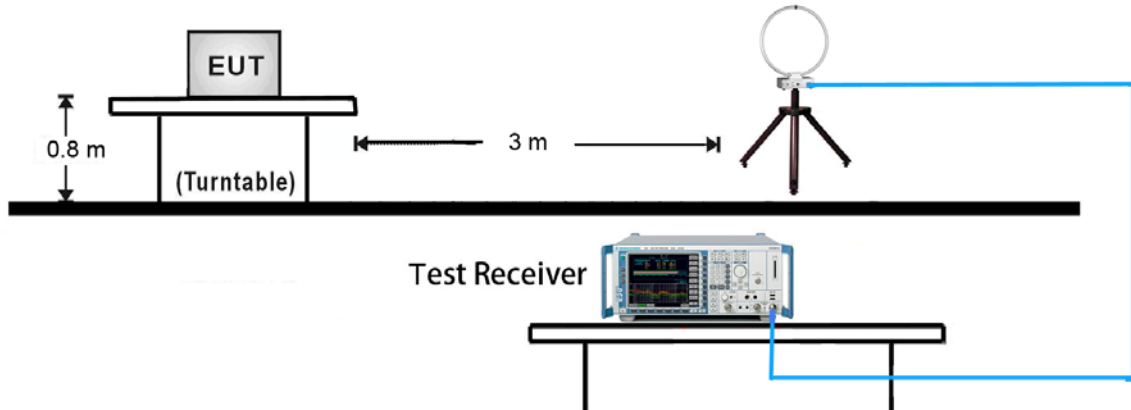

#### 30MHz ~ 1GHz Test Setup:

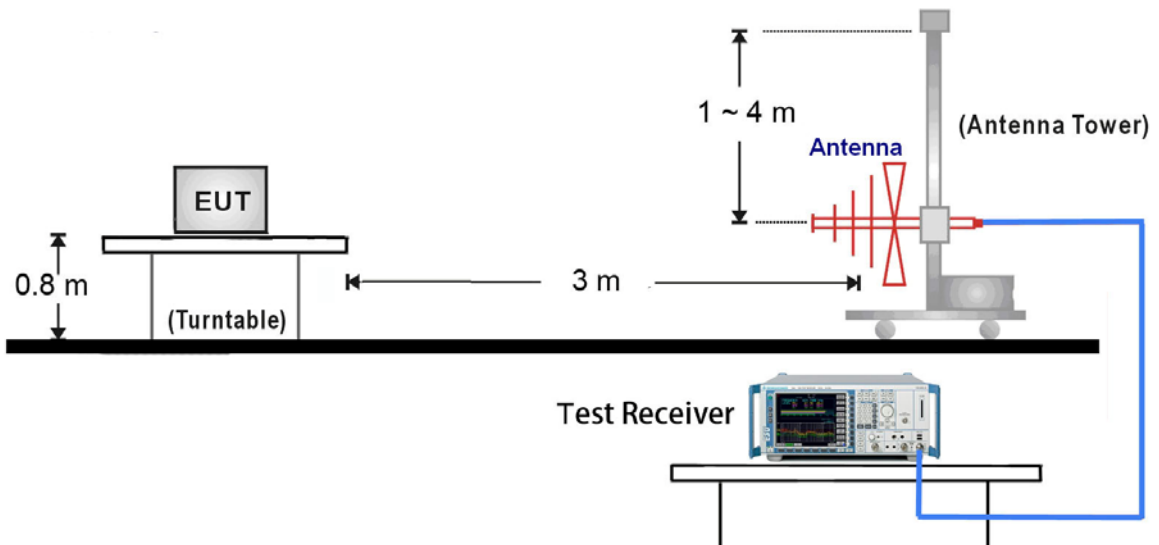

1GHz ~ 18GHz Test Setup:

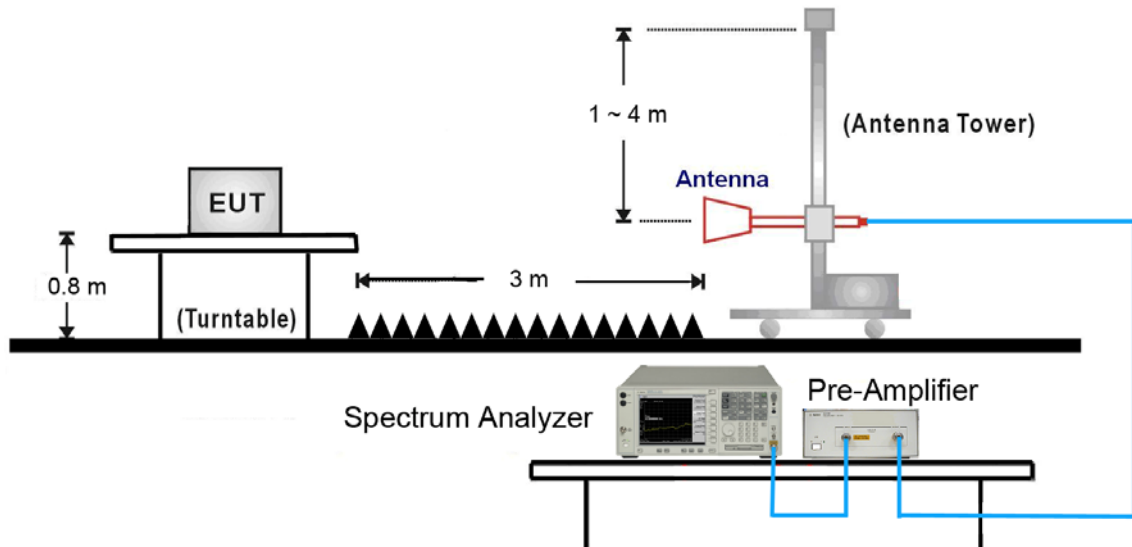

18GHz ~25GHz Test Setup:

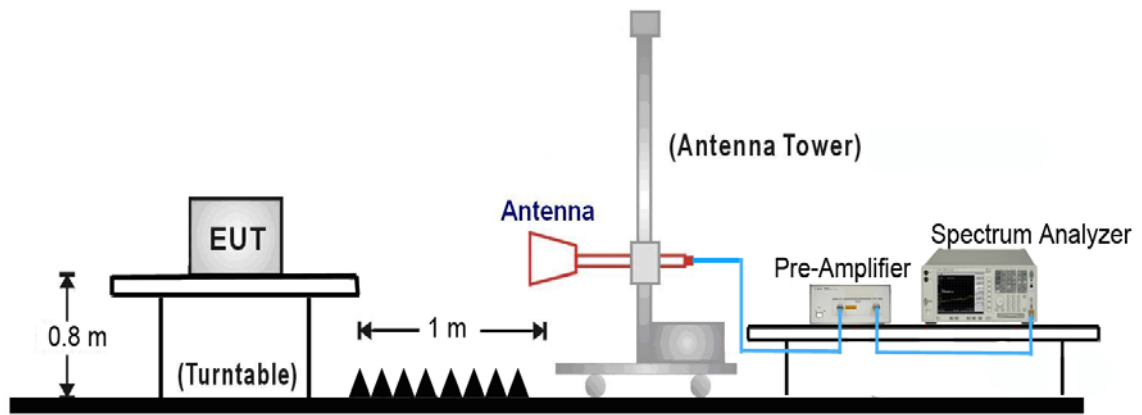

### 7.6.5. Test Result

Test Mode:	802.11b	Test Site:	AC1
Test Channel:	01	Test Engineer:	Roy Cheng
Remark:	1. Average measurement was not performed if peak level lower than average limit. 2. Other frequency was 20dB below limit line within 1-18GHz, there is not show in the report.		

Mark	Frequency (MHz)	Reading Level (dB $\mu$ V)	Factor (dB)	Measure Level (dB $\mu$ V/m)	Limit (dB $\mu$ V/m)	Margin (dB)	Detector	Polarization
	3774.7	38.4	4.2	42.6	74.0	-31.4	Peak	Horizontal
	4824.0	45.4	6.4	51.8	74.0	-22.2	Peak	Horizontal
*	7146.7	35.2	13.5	48.7	92.0	-43.3	Peak	Horizontal
*	8658.0	34.8	14.8	49.6	92.0	-42.4	Peak	Horizontal
	3743.7	38.0	4.1	42.1	74.0	-31.9	Peak	Horizontal
	4825.0	44.5	6.4	50.9	74.0	-23.1	Peak	Vertical
*	7156.7	34.8	13.6	48.3	92.0	-43.7	Peak	Vertical
*	8524.7	35.9	14.6	50.5	92.0	-41.5	Peak	Vertical

Note 1: "\*" is not in restricted band, its limit is 20dBc of the fundamental emission level (112.0dB $\mu$ V/m).

Note 2: Measure Level (dB $\mu$ V/m) = Reading Level (dB $\mu$ V) + Factor (dB)

Factor (dB) = Cable Loss (dB) + Antenna Factor (dB/m) - Pre\_Amplifier Gain (dB)

Test Mode:	802.11b	Test Site:	AC1
Test Channel:	06	Test Engineer:	Roy Cheng
Remark:	1. Average measurement was not performed if peak level lower than average limit. 2. Other frequency was 20dB below limit line within 1-18GHz, there is not show in the report.		

Mark	Frequency (MHz)	Reading Level (dB $\mu$ V)	Factor (dB)	Measure Level (dB $\mu$ V/m)	Limit (dB $\mu$ V/m)	Margin (dB)	Detector	Polarization
	3715.7	38.3	4.1	42.4	74.0	-31.6	Peak	Horizontal
	4833.5	46.3	6.4	52.7	74.0	-21.3	Peak	Horizontal
*	7815.3	32.9	15.0	47.9	92.8	-44.9	Peak	Horizontal
*	9653.0	38.7	15.5	54.2	92.8	-38.6	Peak	Horizontal
	3745.7	37.7	4.1	41.8	74.0	-32.2	Peak	Horizontal
	4825.0	45.9	6.4	52.3	74.0	-21.7	Peak	Vertical
*	7842.4	33.6	15.1	48.7	92.8	-44.1	Peak	Vertical
*	9644.5	41.5	15.5	57.0	92.8	-35.8	Peak	Vertical

Note 1: "\*" is not in restricted band, its limit is 20dBc of the fundamental emission level (112.8dB $\mu$ V/m).

Note 2: Measure Level (dB $\mu$ V/m) = Reading Level (dB $\mu$ V) + Factor (dB)

Factor (dB) = Cable Loss (dB) + Antenna Factor (dB/m) - Pre\_Amplifier Gain (dB)



Test Mode:	802.11b	Test Site:	AC1
Test Channel:	11	Test Engineer:	Roy Cheng
Remark:	1. Average measurement was not performed if peak level lower than average limit. 2. Other frequency was 20dB below limit line within 1-18GHz, there is not show in the report.		

Mark	Frequency (MHz)	Reading Level (dB $\mu$ V)	Factor (dB)	Measure Level (dB $\mu$ V/m)	Limit (dB $\mu$ V/m)	Margin (dB)	Detector	Polarization
	4918.5	49.9	6.7	56.6	74.0	-17.4	Peak	Horizontal
	4924.7	33.1	6.7	39.8	54.0	-14.2	Average	Horizontal
	7383.5	38.7	14.1	52.8	74.0	-21.2	Peak	Horizontal
*	9215.6	35.4	15.2	50.6	93.4	-42.8	Peak	Horizontal
*	9857.0	40.7	16.4	57.1	93.4	-36.3	Peak	Horizontal
	4918.5	46.2	6.7	52.9	74.0	-21.1	Peak	Vertical
	5421.5	37.7	7.0	44.7	74.0	-29.3	Peak	Vertical
*	9173.7	35.2	15.3	50.5	93.4	-42.9	Peak	Vertical
*	9840.0	41.5	16.5	58.0	93.4	-35.4	Peak	Vertical

Note 1: "\*" is not in restricted band, its limit is 20dBc of the fundamental emission level (113.4dB $\mu$ V/m).

Note 2: Measure Level (dB $\mu$ V/m) = Reading Level (dB $\mu$ V) + Factor (dB)

Factor (dB) = Cable Loss (dB) + Antenna Factor (dB/m) - Pre\_Amplifier Gain (dB)

Test Mode:	802.11g	Test Site:	AC1
Test Channel:	01	Test Engineer:	Roy Cheng
Remark:	1. Average measurement was not performed if peak level lower than average limit. 2. Other frequency was 20dB below limit line within 1-18GHz, there is not show in the report.		

Mark	Frequency (MHz)	Reading Level (dB $\mu$ V)	Factor (dB)	Measure Level (dB $\mu$ V/m)	Limit (dB $\mu$ V/m)	Margin (dB)	Detector	Polarization
	3782.7	38.1	4.2	42.3	74.0	-31.7	Peak	Horizontal
	4833.5	45.9	6.4	52.3	74.0	-21.7	Peak	Horizontal
*	6523.5	36.8	10.9	47.7	92.3	-44.6	Peak	Horizontal
*	8954.8	35.7	14.3	50.0	92.3	-42.3	Peak	Horizontal
	3748.7	37.9	4.1	42.0	74.0	-32.0	Peak	Vertical
	4816.5	45.9	6.4	52.3	74.0	-21.7	Peak	Vertical
*	7972.5	33.7	15.0	48.7	92.3	-43.6	Peak	Vertical
*	9644.5	42.0	15.5	57.5	92.3	-34.8	Peak	Vertical

Note 1: "\*" is not in restricted band, its limit is 20dBc of the fundamental emission level (112.3dB $\mu$ V/m).

Note 2: Measure Level (dB $\mu$ V/m) = Reading Level (dB $\mu$ V) + Factor (dB)

Factor (dB) = Cable Loss (dB) + Antenna Factor (dB/m) - Pre\_Amplifier Gain (dB)

Test Mode:	802.11g	Test Site:	AC1
Test Channel:	06	Test Engineer:	Roy Cheng
Remark:	1. Average measurement was not performed if peak level lower than average limit. 2. Other frequency was 20dB below limit line within 1-18GHz, there is not show in the report.		

Mark	Frequency (MHz)	Reading Level (dB $\mu$ V)	Factor (dB)	Measure Level (dB $\mu$ V/m)	Limit (dB $\mu$ V/m)	Margin (dB)	Detector	Polarization
	3745.7	38.0	4.1	42.1	74.0	-31.9	Peak	Horizontal
	4867.5	48.2	6.6	54.8	74.0	-19.2	Peak	Horizontal
	4874.7	30.3	6.6	36.9	54.0	-17.1	Average	Horizontal
*	6143.7	36.6	8.8	45.4	92.1	-46.7	Peak	Horizontal
*	9142.7	36.1	15.2	51.3	92.1	-40.8	Peak	Horizontal
	3785.0	38.4	4.2	42.6	74.0	-31.4	Peak	Vertical
	4876.0	46.6	6.6	53.2	74.0	-20.8	Peak	Vertical
*	8654.6	35.0	14.8	49.8	92.1	-42.3	Peak	Vertical
*	9746.5	42.1	16.2	58.3	92.1	-33.8	Peak	Vertical

Note 1: "\*" is not in restricted band, its limit is 20dBc of the fundamental emission level (112.1dB $\mu$ V/m).

Note 2: Measure Level (dB $\mu$ V/m) = Reading Level (dB $\mu$ V) + Factor (dB)

Factor (dB) = Cable Loss (dB) + Antenna Factor (dB/m) - Pre\_Amplifier Gain (dB)

Test Mode:	802.11g	Test Site:	AC1
Test Channel:	11	Test Engineer:	Roy Cheng
Remark:	1. Average measurement was not performed if peak level lower than average limit. 2. Other frequency was 20dB below limit line within 1-18GHz, there is not show in the report.		

Mark	Frequency (MHz)	Reading Level (dB $\mu$ V)	Factor (dB)	Measure Level (dB $\mu$ V/m)	Limit (dB $\mu$ V/m)	Margin (dB)	Detector	Polarization
	3749.0	38.3	4.1	42.4	74.0	-31.6	Peak	Horizontal
	4918.5	44.4	6.7	51.1	74.0	-22.9	Peak	Horizontal
*	6826.5	36.4	11.5	47.9	91.8	-43.9	Peak	Horizontal
*	9625.4	35.7	15.4	51.1	91.8	-40.7	Peak	Horizontal
	3748.7	38.2	4.1	42.3	74.0	-31.7	Peak	Vertical
	4927.0	41.9	6.7	48.6	74.0	-25.4	Peak	Vertical
*	9246.6	36.2	15.5	51.7	91.8	-40.1	Peak	Vertical
*	9840.0	40.5	16.5	57.0	91.8	-34.8	Peak	Vertical

Note 1: "\*" is not in restricted band, its limit is 20dBc of the fundamental emission level (111.8dB $\mu$ V/m).

Note 2: Measure Level (dB $\mu$ V/m) = Reading Level (dB $\mu$ V) + Factor (dB)

Factor (dB) = Cable Loss (dB) + Antenna Factor (dB/m) - Pre\_Amplifier Gain (dB)

Test Mode:	802.11n-HT20	Test Site:	AC1
Test Channel:	01	Test Engineer:	Roy Cheng
Remark:	1. Average measurement was not performed if peak level lower than average limit. 2. Other frequency was 20dB below limit line within 1-18GHz, there is not show in the report.		

Mark	Frequency (MHz)	Reading Level (dB $\mu$ V)	Factor (dB)	Measure Level (dB $\mu$ V/m)	Limit (dB $\mu$ V/m)	Margin (dB)	Detector	Polarization
	3748.9	39.1	4.1	43.2	74.0	-30.8	Peak	Horizontal
	4816.5	43.9	6.4	50.3	74.0	-23.7	Peak	Horizontal
*	6478.6	36.4	10.7	47.1	89.9	-42.8	Peak	Horizontal
*	9275.7	35.9	15.4	51.3	89.9	-38.6	Peak	Horizontal
	3784.6	38.0	4.2	42.2	74.0	-31.8	Peak	Vertical
	4825.0	42.9	6.4	49.3	74.0	-24.7	Peak	Vertical
*	6815.0	35.5	11.5	47.0	89.9	-42.9	Peak	Vertical
*	9205.7	35.8	15.2	51.0	89.9	-38.9	Peak	Vertical

Note 1: "\*" is not in restricted band, its limit is 20dBc of the fundamental emission level (109.9dB $\mu$ V/m).

Note 2: Measure Level (dB $\mu$ V/m) = Reading Level (dB $\mu$ V) + Factor (dB)

Factor (dB) = Cable Loss (dB) + Antenna Factor (dB/m) - Pre\_Amplifier Gain (dB)

Test Mode:	802.11n-HT20	Test Site:	AC1
Test Channel:	06	Test Engineer:	Roy Cheng
Remark:	1. Average measurement was not performed if peak level lower than average limit. 2. Other frequency was 20dB below limit line within 1-18GHz, there is not show in the report.		

Mark	Frequency (MHz)	Reading Level (dB $\mu$ V)	Factor (dB)	Measure Level (dB $\mu$ V/m)	Limit (dB $\mu$ V/m)	Margin (dB)	Detector	Polarization
	3748.7	38.9	4.1	43.0	74.0	-31.0	Peak	Horizontal
	4867.5	46.2	6.6	52.8	74.0	-21.2	Peak	Horizontal
*	6426.5	37.5	10.4	47.9	90.2	-42.3	Peak	Horizontal
*	8759.8	34.5	14.6	49.1	90.2	-41.1	Peak	Horizontal
	3784.4	38.3	4.2	42.5	74.0	-31.5	Peak	Vertical
	4867.5	47.0	6.6	53.6	74.0	-20.4	Peak	Vertical
*	6522.6	36.4	10.9	47.3	90.2	-42.9	Peak	Vertical
*	9738.0	39.3	16.1	55.4	90.2	-34.8	Peak	Vertical

Note 1: "\*" is not in restricted band, its limit is 20dBc of the fundamental emission level (110.2dB $\mu$ V/m).

Note 2: Measure Level (dB $\mu$ V/m) = Reading Level (dB $\mu$ V) + Factor (dB)

Factor (dB) = Cable Loss (dB) + Antenna Factor (dB/m) - Pre\_Amplifier Gain (dB)

Test Mode:	802.11n-HT20	Test Site:	AC1
Test Channel:	11	Test Engineer:	Roy Cheng
Remark:	1. Average measurement was not performed if peak level lower than average limit. 2. Other frequency was 20dB below limit line within 1-18GHz, there is not show in the report.		

Mark	Frequency (MHz)	Reading Level (dB $\mu$ V)	Factor (dB)	Measure Level (dB $\mu$ V/m)	Limit (dB $\mu$ V/m)	Margin (dB)	Detector	Polarization
	3785.7	38.4	4.2	42.6	74.0	-31.4	Peak	Horizontal
	4927.0	42.7	6.7	49.4	74.0	-24.6	Peak	Horizontal
*	6254.6	36.3	9.5	45.8	90.3	-44.5	Peak	Horizontal
*	9248.5	36.1	15.5	51.6	90.3	-38.7	Peak	Horizontal
	3784.4	38.4	4.2	42.6	74.0	-31.4	Peak	Vertical
	4918.5	41.3	6.7	48.0	74.0	-26.0	Peak	Vertical
*	6545.6	35.8	10.9	46.7	90.3	-43.6	Peak	Vertical
*	9205.4	35.6	15.2	50.8	90.3	-39.5	Peak	Vertical

Note 1: "\*" is not in restricted band, its limit is 20dBc of the fundamental emission level (120.3dB $\mu$ V/m).

Note 2: Measure Level (dB $\mu$ V/m) = Reading Level (dB $\mu$ V) + Factor (dB)

Factor (dB) = Cable Loss (dB) + Antenna Factor (dB/m) - Pre\_Amplifier Gain (dB)

Test Mode:	802.11n-HT40	Test Site:	AC1
Test Channel:	03	Test Engineer:	Roy Cheng
Remark:	1. Average measurement was not performed if peak level lower than average limit. 2. Other frequency was 20dB below limit line within 1-18GHz, there is not show in the report.		

Mark	Frequency (MHz)	Reading Level (dB $\mu$ V)	Factor (dB)	Measure Level (dB $\mu$ V/m)	Limit (dB $\mu$ V/m)	Margin (dB)	Detector	Polarization
	3784.7	37.9	4.2	42.1	74.0	-31.9	Peak	Horizontal
	4825.0	40.4	6.4	46.8	74.0	-27.2	Peak	Horizontal
*	6589.4	36.5	10.8	47.3	88.2	-40.9	Peak	Horizontal
*	9245.7	36.0	15.5	51.5	88.2	-36.7	Peak	Horizontal
	3745.7	38.8	4.1	42.9	74.0	-31.1	Peak	Vertical
	4833.5	40.0	6.4	46.4	74.0	-27.6	Peak	Vertical
*	6852.7	35.9	11.7	47.6	88.2	-40.6	Peak	Vertical
*	9253.7	36.5	15.5	52.0	88.2	-36.2	Peak	Vertical

Note 1: "\*" is not in restricted band, its limit is 20dBc of the fundamental emission level (108.2dB $\mu$ V/m).

Note 2: Measure Level (dB $\mu$ V/m) = Reading Level (dB $\mu$ V) + Factor (dB)

Factor (dB) = Cable Loss (dB) + Antenna Factor (dB/m) - Pre\_Amplifier Gain (dB)



Test Mode:	802.11n-HT40	Test Site:	AC1
Test Channel:	06	Test Engineer:	Roy Cheng
Remark:	1. Average measurement was not performed if peak level lower than average limit. 2. Other frequency was 20dB below limit line within 1-18GHz, there is not show in the report.		

Mark	Frequency (MHz)	Reading Level (dB $\mu$ V)	Factor (dB)	Measure Level (dB $\mu$ V/m)	Limit (dB $\mu$ V/m)	Margin (dB)	Detector	Polarization
	3726.6	38.2	4.1	42.3	74.0	-31.7	Peak	Horizontal
	4867.5	40.2	6.6	46.8	74.0	-27.2	Peak	Horizontal
*	6536.5	37.0	10.9	47.9	88.4	-40.5	Peak	Horizontal
*	9215.7	35.6	15.2	50.8	88.4	-37.6	Peak	Horizontal
	3745.4	38.5	4.1	42.6	74.0	-31.4	Peak	Vertical
	4876.0	39.8	6.6	46.4	74.0	-27.6	Peak	Vertical
*	6823.9	35.3	11.5	46.8	88.4	-41.6	Peak	Vertical
*	9243.7	36.4	15.5	51.9	88.4	-36.5	Peak	Vertical

Note 1: "\*" is not in restricted band, its limit is 20dBc of the fundamental emission level (108.4dB $\mu$ V/m).

Note 2: Measure Level (dB $\mu$ V/m) = Reading Level (dB $\mu$ V) + Factor (dB)

Factor (dB) = Cable Loss (dB) + Antenna Factor (dB/m) - Pre\_Amplifier Gain (dB)

Test Mode:	802.11n-HT40	Test Site:	AC1
Test Channel:	09	Test Engineer:	Roy Cheng
Remark:	1. Average measurement was not performed if peak level lower than average limit. 2. Other frequency was 20dB below limit line within 1-18GHz, there is not show in the report.		

Mark	Frequency (MHz)	Reading Level (dB $\mu$ V)	Factor (dB)	Measure Level (dB $\mu$ V/m)	Limit (dB $\mu$ V/m)	Margin (dB)	Detector	Polarization
	3748.7	38.2	4.1	42.3	74.0	-31.7	Peak	Horizontal
	4918.5	41.0	6.7	47.7	74.0	-26.3	Peak	Horizontal
*	6872.7	35.9	11.8	47.7	87.1	-39.4	Peak	Horizontal
*	8795.1	35.1	14.4	49.5	87.1	-37.6	Peak	Horizontal
	3748.7	39.2	4.1	43.3	74.0	-30.7	Peak	Vertical
	4895.7	38.2	6.7	44.9	74.0	-29.1	Peak	Vertical
*	5263.5	37.3	6.6	43.9	87.1	-43.2	Peak	Vertical
*	8752.7	34.6	14.6	49.2	87.1	-37.9	Peak	Vertical

Note 1: "\*" is not in restricted band, its limit is 20dBc of the fundamental emission level (107.1dB $\mu$ V/m).

Note 2: Measure Level (dB $\mu$ V/m) = Reading Level (dB $\mu$ V) + Factor (dB)

Factor (dB) = Cable Loss (dB) + Antenna Factor (dB/m) - Pre\_Amplifier Gain (dB)

**The worst case of Radiated Emission below 1GHz:**

Site: AC1	Time: 2014/11/23 - 20:24
Limit: FCC_Part15.209_RE(3m)	Engineer: Roy Cheng
Probe: VULB9162_0.03-8GHz	Polarity: Horizontal
EUT: 2x2 dual band 802.11ac indoor AP	Power: AC 120V/60Hz
Test Mode : Transmit at channel 2412MHz by 802.11b	

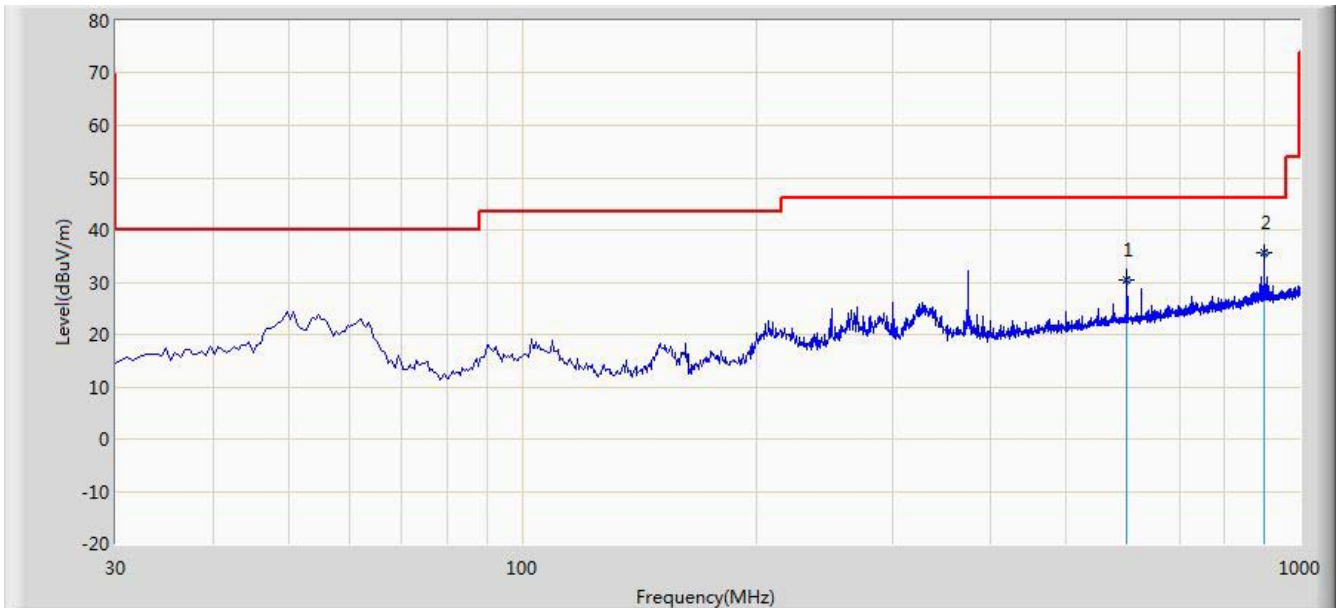

No	Flag	Mark	Frequency (MHz)	Measure Level (dBuV/m)	Reading Level (dBuV)	Over Limit (dB)	Limit (dBuV/m)	Factor (dB)	Type
1			599.890	30.463	11.024	-15.537	46.000	19.439	QP
2		*	900.010	35.674	12.355	-10.326	46.000	23.319	QP

Note: Measure Level (dB $\mu$ V/m) = Reading Level (dB $\mu$ V) + Factor (dB)

Factor (dB) = Cable Loss (dB) + Antenna Factor (dB/m)

Site: AC1	Time: 2014/11/23 - 20:27
Limit: FCC_Part15.209_RE(3m)	Engineer: Roy Cheng
Probe: VULB9162_0.03-8GHz	Polarity: Vertical
EUT: 2x2 dual band 802.11ac indoor AP	Power: AC 120V/60Hz
Test Mode : Transmit at channel 2412MHz by 802.11b	

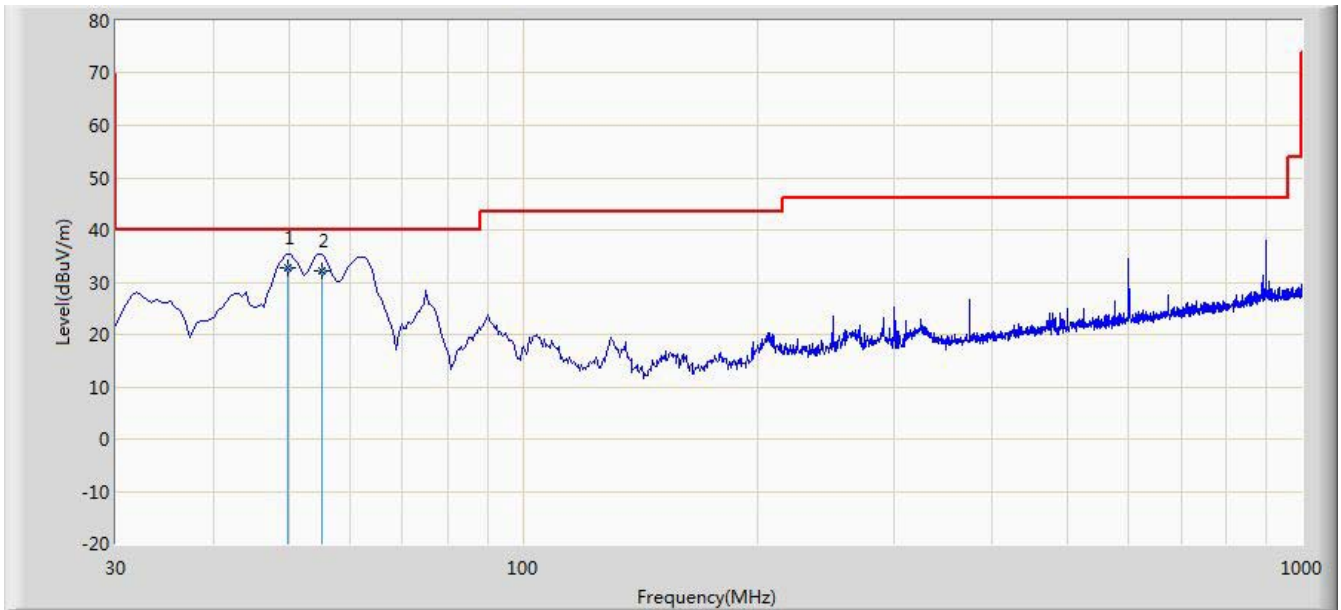

No	Flag	Mark	Frequency (MHz)	Measure Level (dBuV/m)	Reading Level (dBuV)	Over Limit (dB)	Limit (dBuV/m)	Factor (dB)	Type
1		*	49.885	32.782	18.024	-7.218	40.000	14.759	QP
2			55.220	32.186	17.719	-7.814	40.000	14.467	QP

Note: Measure Level (dBμV/m) = Reading Level (dBμV) + Factor (dB)

Factor (dB) = Cable Loss (dB) + Antenna Factor (dB/m)

Engineer: Roy Cheng	
Site: AC1	Time: 2014/10/26 - 18:12
Limit: FCC_Part15.209_RE(3m)	Margin: 0
Probe: FMZB1519_0.009-30MHz	Polarity: Face on
EUT: 2x2 dual band 802.11ac indoor AP	Power: AC 120V/60Hz
<b>Note: There is the ambient noise within frequency range 9kHz~30MHz.</b>	

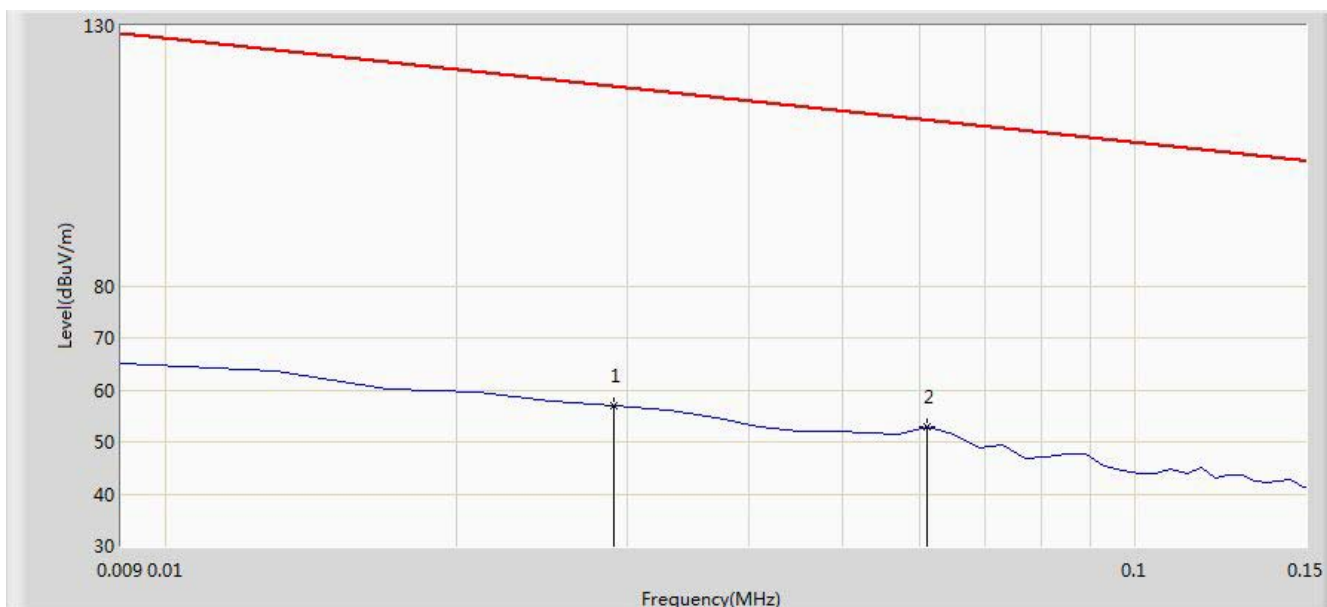

No	Flag	Mark	Frequency (MHz)	Measure Level (dBuV/m)	Reading Level (dBuV)	Over Limit (dB)	Limit (dBuV/m)	Factor (dB)	Type
1			0.029	56.893	35.844	-61.449	118.342	21.049	QP
2		*	0.061	52.853	32.542	-59.034	111.887	20.311	QP

Note: Measure Level (dB $\mu$ V/m) = Reading Level (dB $\mu$ V) + Factor (dB)

Factor (dB) = Cable Loss (dB) + Antenna Factor (dB/m)

Engineer: Roy Cheng	
Site: AC1	Time: 2014/10/26 - 18:16
Limit: FCC_Part15.209_RE(3m)	Margin: 0
Probe: FMZB1519_0.009-30MHz	Polarity: Face on
EUT: 2x2 dual band 802.11ac indoor AP	Power: AC 120V/60Hz
<b>Note: There is the ambient noise within frequency range 9kHz~30MHz.</b>	

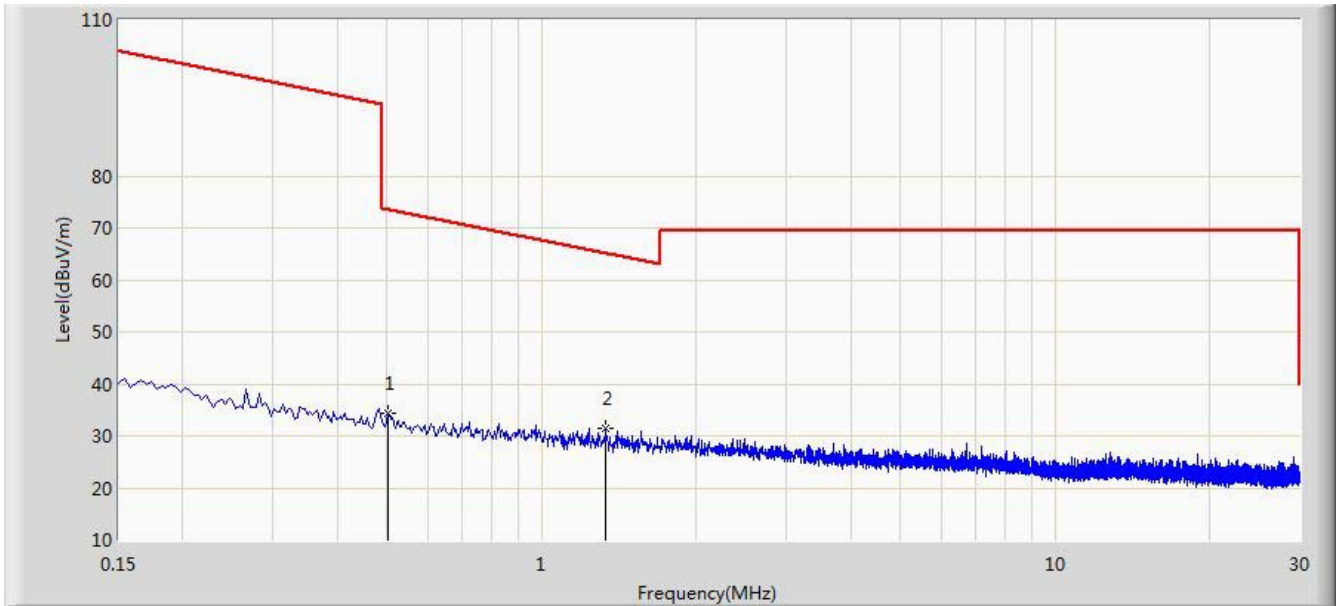

No	Flag	Mark	Frequency (MHz)	Measure Level (dBuV/m)	Reading Level (dBuV)	Over Limit (dB)	Limit (dBuV/m)	Factor (dB)	Type
1			0.502	34.370	13.947	-39.220	73.590	20.423	QP
2		*	1.334	31.595	11.104	-33.530	65.125	20.491	QP

Note: Measure Level (dBμV/m) = Reading Level (dBμV) + Factor (dB)

Factor (dB) = Cable Loss (dB) + Antenna Factor (dB/m)

Engineer: Roy Cheng	
Site: AC1	Time: 2014/10/26 - 21:20
Limit: FCC_Part15.209_RE(1m)	Margin: 0
Probe: BBHA9170_18-40GHz	Polarity: Horizontal
EUT: 2x2 dual band 802.11ac indoor AP	Power: AC 120V/60Hz
<b>Note: There is the ambient noise within frequency range 18GHz~25GHz.</b>	

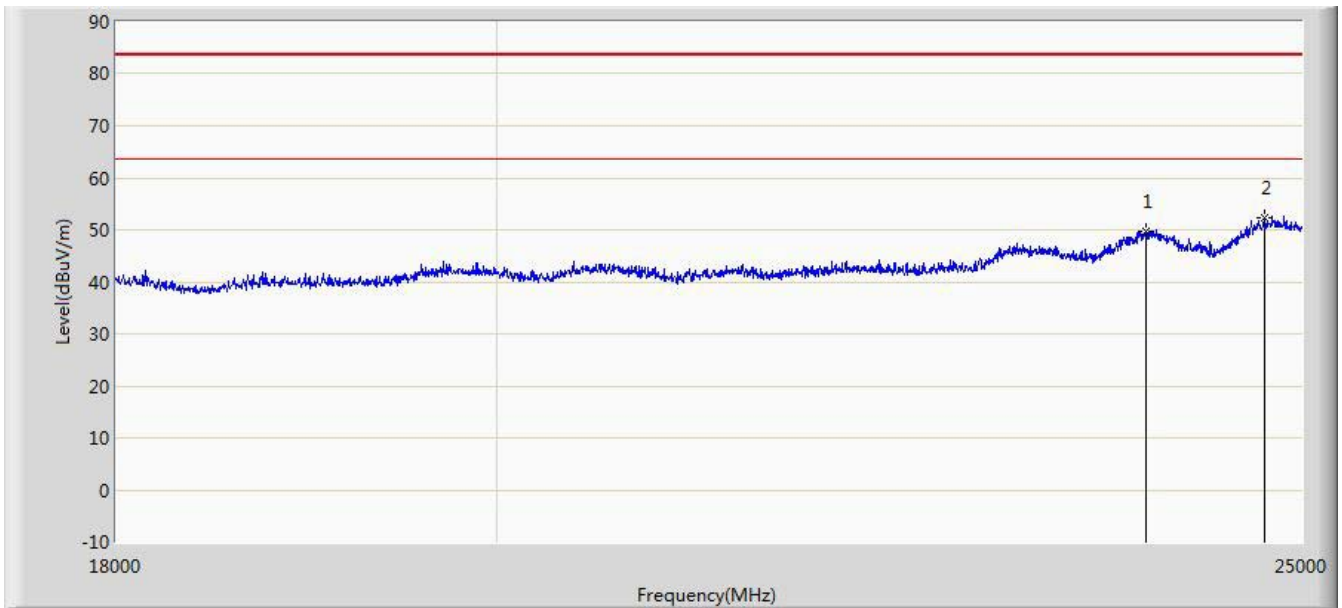

No	Flag	Mark	Frequency (MHz)	Measure Level (dBuV/m)	Reading Level (dBuV)	Over Limit (dB)	Limit (dBuV/m)	Factor (dB)	Type
1			23943.000	49.776	35.866	-33.724	83.500	13.910	PK
2		*	24741.000	52.375	37.681	-31.125	83.500	14.694	PK

Note: Measure Level (dBμV/m) = Reading Level (dBμV) + Factor (dB)

Factor (dB) = Cable Loss (dB) + Antenna Factor (dB/m) - Pre\_Amplifier Gain (dB)

Engineer: Roy Cheng	
Site: AC1	Time: 2014/10/26 - 21:32
Limit: FCC_Part15.209_RE(1m)	Margin: 0
Probe: BBHA9170_18-40GHz	Polarity: Vertical
EUT: 2x2 dual band 802.11ac indoor AP	Power: AC 120V/60Hz
<b>Note: There is the ambient noise within frequency range 18GHz~25GHz.</b>	

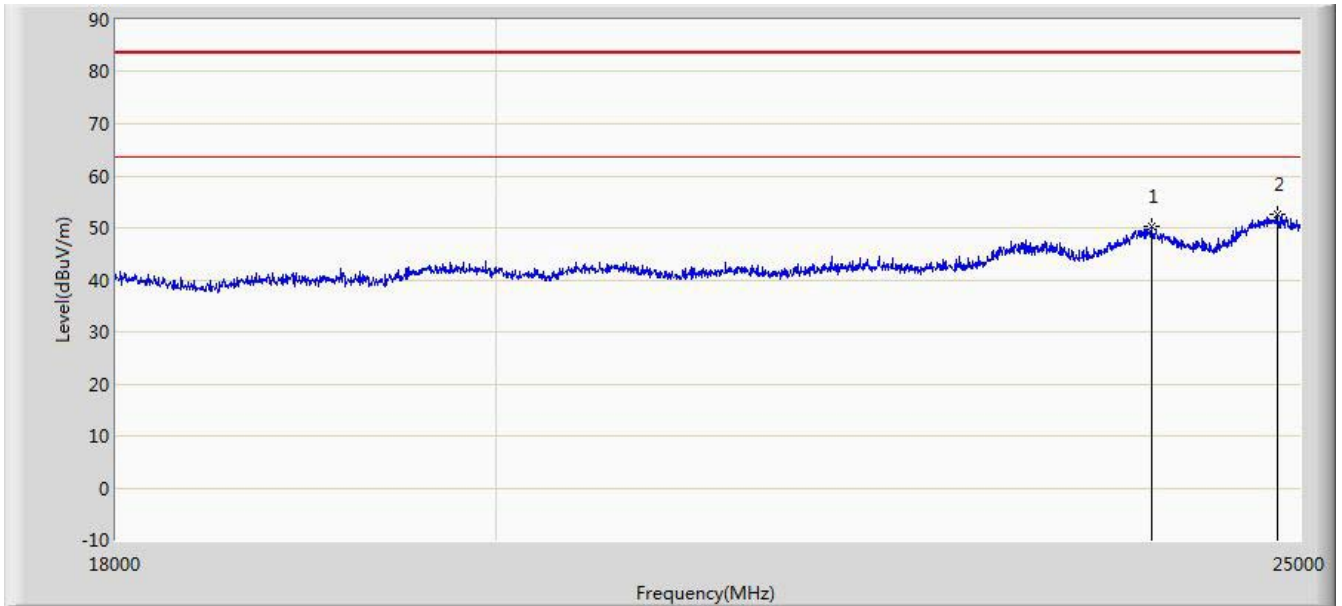

No	Flag	Mark	Frequency (MHz)	Measure Level (dBuV/m)	Reading Level (dBuV)	Over Limit (dB)	Limit (dBuV/m)	Factor (dB)	Type
1			23999.000	50.379	36.435	-33.121	83.500	13.944	PK
2		*	24846.000	52.503	37.735	-30.997	83.500	14.768	PK

Note: Measure Level (dBμV/m) = Reading Level (dBμV) + Factor (dB)

Factor (dB) = Cable Loss (dB) + Antenna Factor (dB/m) - Pre\_Amplifier Gain (dB)



## 7.7. Radiated Restricted Band Edge Measurement

### 7.7.1. Test Result

Site: AC1	Time: 2014/10/29 - 19:29
Limit: FCC_Part15.209_RE(3m)	Engineer: Roy Cheng
Probe: BBHA9120D_1-18GHz	Polarity: Horizontal
EUT: 2x2 dual band 802.11ac indoor AP	Power: AC 120V/60Hz
Test Mode: Transmit at channel 2412MHz by 802.11b Ant 0+1	

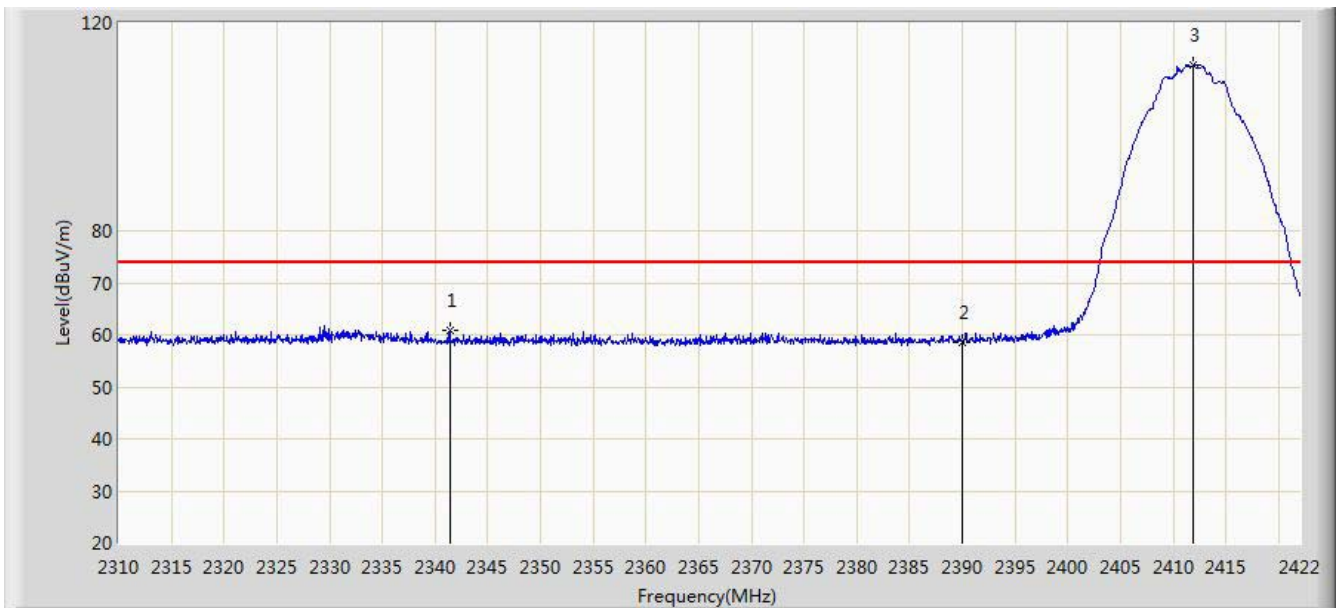

No	Mark	Frequency (MHz)	Measure Level (dBuV/m)	Reading Level (dBuV)	Over Limit (dB)	Limit (dBuV/m)	Factor (dB)	Type
1		2341.416	60.881	30.065	-13.119	74.000	30.816	PK
2		2390.000	58.596	27.912	-15.404	74.000	30.684	PK
3	*	2411.920	112.027	81.382	N/A	N/A	30.645	PK

Note: Measure Level (dB $\mu$ V/m) = Reading Level (dB $\mu$ V) + Factor (dB)

Factor (dB) = Cable Loss (dB) + Antenna Factor (dB/m).

Site: AC1	Time: 2014/10/29 - 19:49
Limit: FCC_Part15.209_RE(3m)	Engineer: Roy Cheng
Probe: BBHA9120D_1-18GHz	Polarity: Horizontal
EUT: 2x2 dual band 802.11ac indoor AP	Power: AC 120V/60Hz
Test Mode: Transmit at channel 2412MHz by 802.11b Ant 0+1	

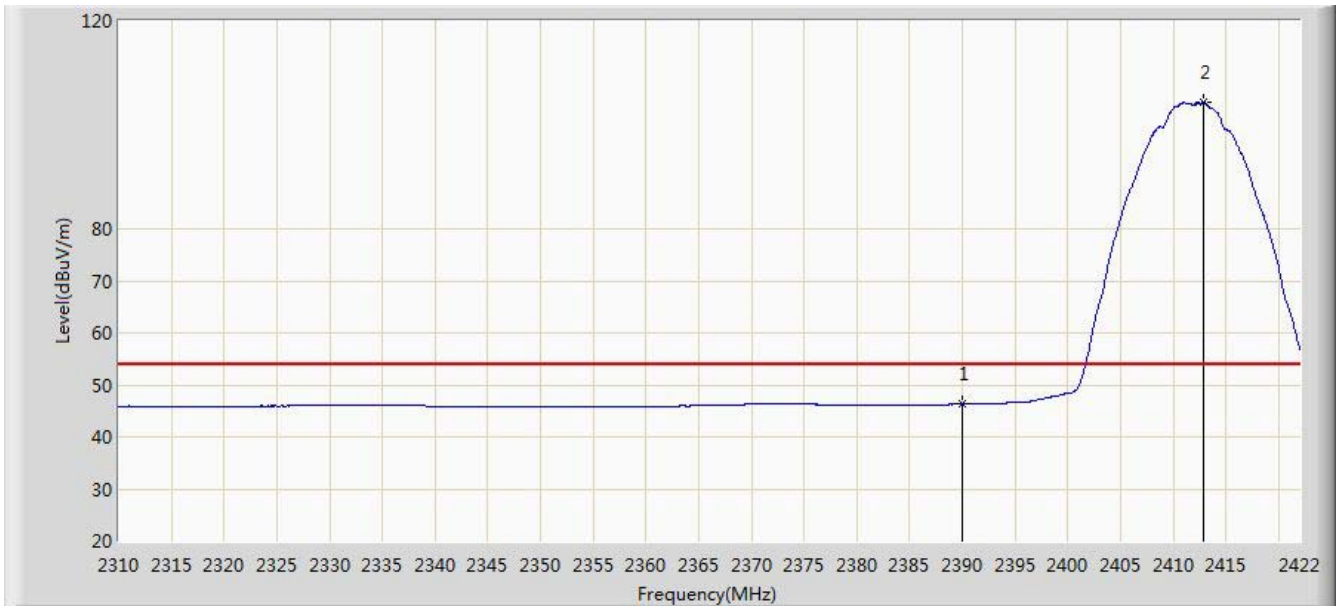

No	Mark	Frequency (MHz)	Measure Level (dBuV/m)	Reading Level (dBuV)	Over Limit (dB)	Limit (dBuV/m)	Factor (dB)	Type
1		2390.000	46.334	15.650	-7.666	54.000	30.684	AV
2	*	2412.872	104.263	73.620	N/A	N/A	30.644	AV

Note: Measure Level (dB $\mu$ V/m) = Reading Level (dB $\mu$ V) + Factor (dB)

Factor (dB) = Cable Loss (dB) + Antenna Factor (dB/m).

Site: AC1	Time: 2014/10/29 - 19:50
Limit: FCC_Part15.209_RE(3m)	Engineer: Roy Cheng
Probe: BBHA9120D_1-18GHz	Polarity: Vertical
EUT: 2x2 dual band 802.11ac indoor AP	Power: AC 120V/60Hz
Test Mode: Transmit at channel 2412MHz by 802.11b Ant 0+1	

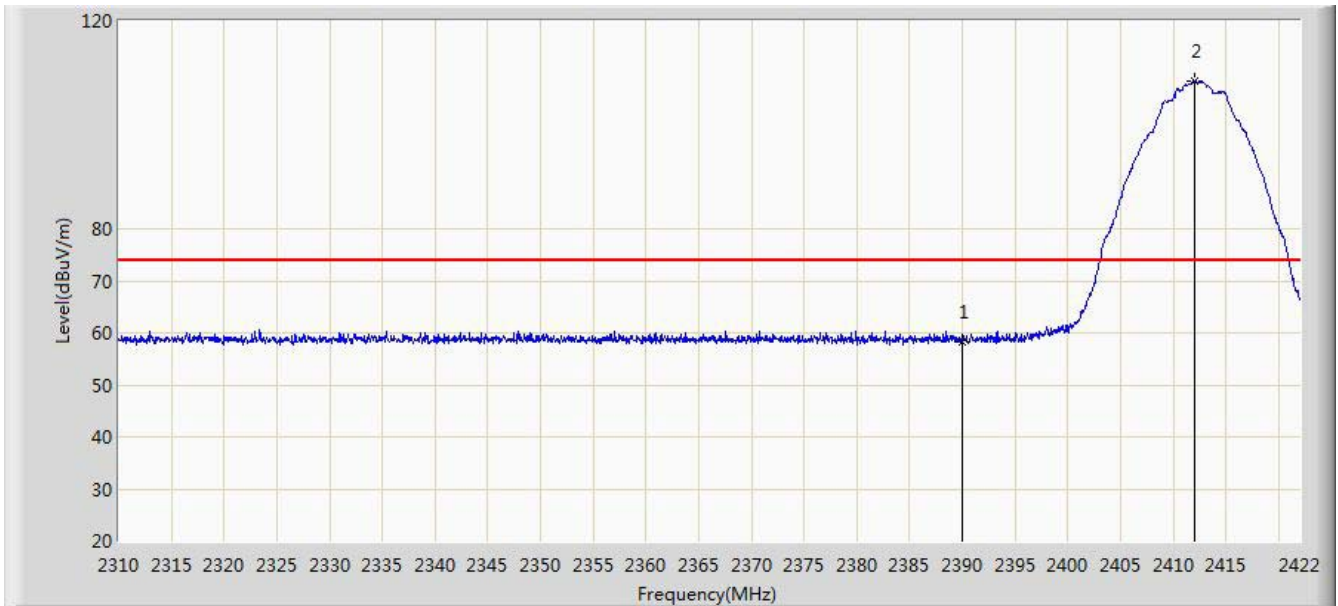

No	Mark	Frequency (MHz)	Measure Level (dBuV/m)	Reading Level (dBuV)	Over Limit (dB)	Limit (dBuV/m)	Factor (dB)	Type
1		2390.000	58.227	27.543	-15.773	74.000	30.684	PK
2	*	2412.032	108.369	77.724	N/A	N/A	30.645	PK

Note: Measure Level (dBuV/m) = Reading Level (dBuV) + Factor (dB)

Factor (dB) = Cable Loss (dB) + Antenna Factor (dB/m).

Site: AC1	Time: 2014/10/29 - 19:51
Limit: FCC_Part15.209_RE(3m)	Engineer: Roy Cheng
Probe: BBHA9120D_1-18GHz	Polarity: Vertical
EUT: 2x2 dual band 802.11ac indoor AP	Power: AC 120V/60Hz
Test Mode: Transmit at channel 2412MHz by 802.11b Ant 0+1	

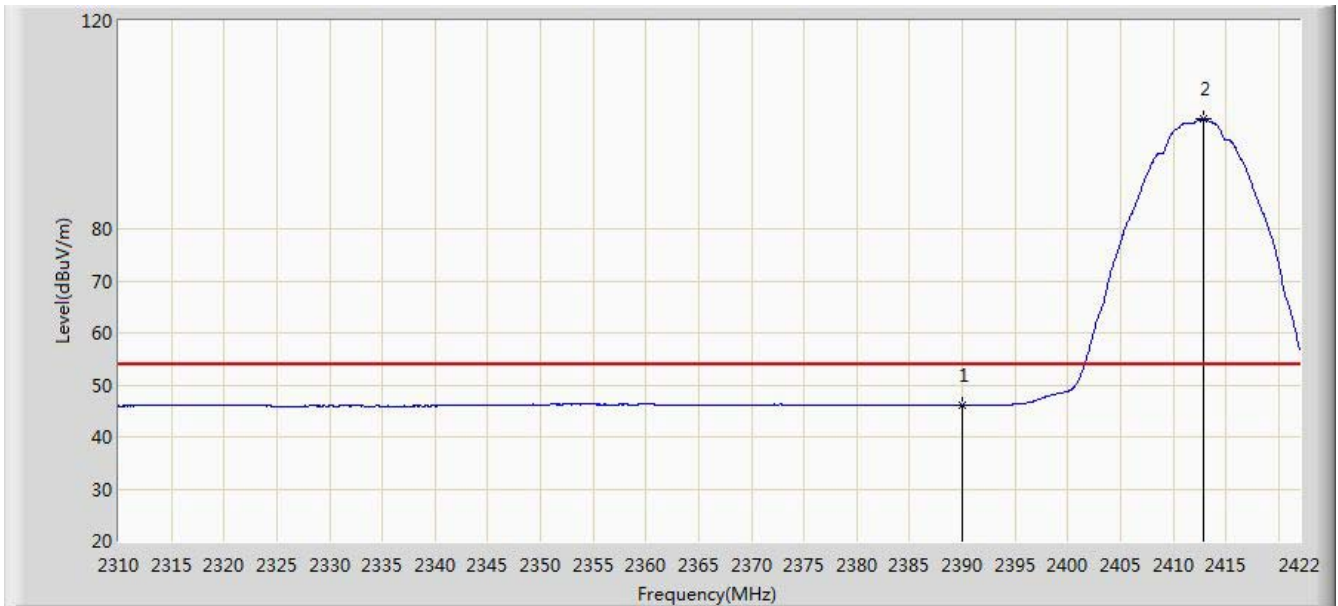

No	Mark	Frequency (MHz)	Measure Level (dBuV/m)	Reading Level (dBuV)	Over Limit (dB)	Limit (dBuV/m)	Factor (dB)	Type
1		2390.000	46.094	15.410	-7.906	54.000	30.684	AV
2	*	2412.816	101.211	70.568	N/A	N/A	30.643	AV

Note: Measure Level (dB $\mu$ V/m) = Reading Level (dB $\mu$ V) + Factor (dB)

Factor (dB) = Cable Loss (dB) + Antenna Factor (dB/m).

Site: AC1	Time: 2014/10/29 - 19:52
Limit: FCC_Part15.209_RE(3m)	Engineer: Roy Cheng
Probe: BBHA9120D_1-18GHz	Polarity: Horizontal
EUT: 2x2 dual band 802.11ac indoor AP	Power: AC 120V/60Hz
Test Mode: Transmit at channel 2462MHz by 802.11b Ant 0+1	

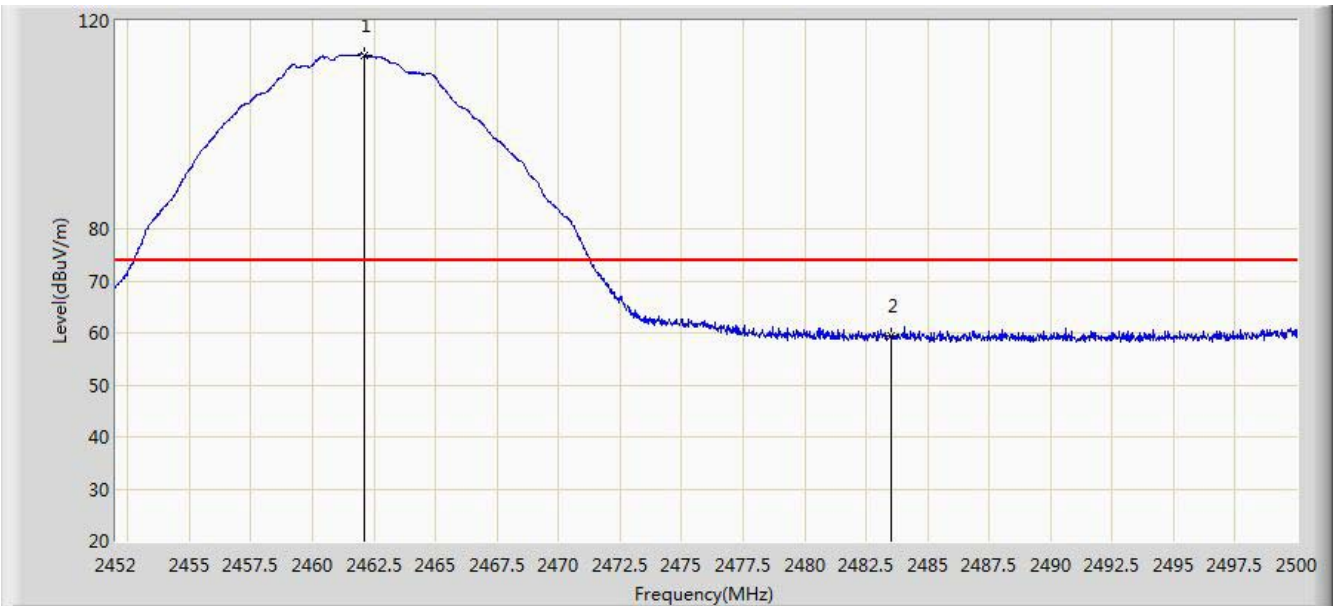

No	Mark	Frequency (MHz)	Measure Level (dBuV/m)	Reading Level (dBuV)	Over Limit (dB)	Limit (dBuV/m)	Factor (dB)	Type
1	*	2462.128	113.391	82.779	N/A	N/A	30.611	PK
2		2483.500	59.291	28.618	-14.709	74.000	30.673	PK

Note: Measure Level (dB $\mu$ V/m) = Reading Level (dB $\mu$ V) + Factor (dB)

Factor (dB) = Cable Loss (dB) + Antenna Factor (dB/m).

Site: AC1	Time: 2014/10/29 - 19:57
Limit: FCC_Part15.209_RE(3m)	Engineer: Roy Cheng
Probe: BBHA9120D_1-18GHz	Polarity: Horizontal
EUT: 2x2 dual band 802.11ac indoor AP	Power: AC 120V/60Hz
Test Mode: Transmit at channel 2462MHz by 802.11b Ant 0+1	



No	Mark	Frequency (MHz)	Measure Level (dBuV/m)	Reading Level (dBuV)	Over Limit (dB)	Limit (dBuV/m)	Factor (dB)	Type
1	*	2462.656	105.667	75.054	N/A	N/A	30.613	AV
2		2483.500	46.676	16.003	-7.324	54.000	30.673	AV

Note: Measure Level (dB $\mu$ V/m) = Reading Level (dB $\mu$ V) + Factor (dB)

Factor (dB) = Cable Loss (dB) + Antenna Factor (dB/m).

Site: AC1	Time: 2014/10/29 - 19:58
Limit: FCC_Part15.209_RE(3m)	Engineer: Roy Cheng
Probe: BBHA9120D_1-18GHz	Polarity: Vertical
EUT: 2x2 dual band 802.11ac indoor AP	Power: AC 120V/60Hz
Test Mode: Transmit at channel 2462MHz by 802.11b Ant 0+1	

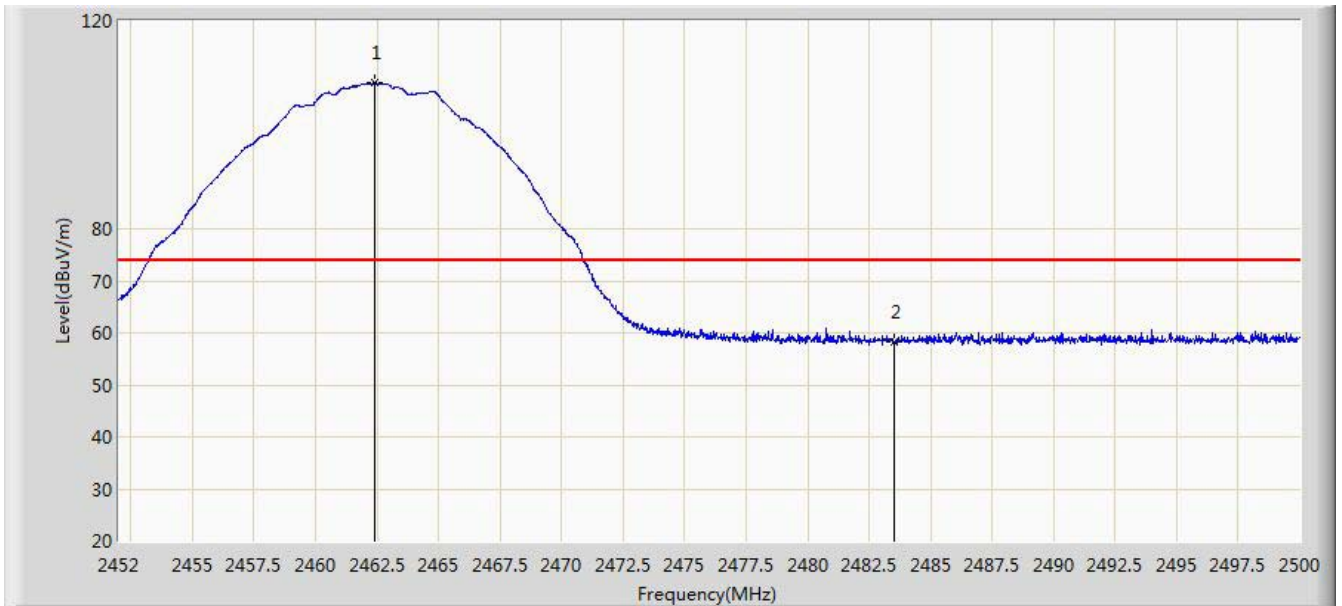

No	Mark	Frequency (MHz)	Measure Level (dBuV/m)	Reading Level (dBuV)	Over Limit (dB)	Limit (dBuV/m)	Factor (dB)	Type
1	*	2462.416	108.058	77.446	N/A	N/A	30.612	PK
2		2483.500	58.356	27.683	-15.644	74.000	30.673	PK

Note: Measure Level (dBuV/m) = Reading Level (dBuV) + Factor (dB)

Factor (dB) = Cable Loss (dB) + Antenna Factor (dB/m).

Site: AC1	Time: 2014/10/29 - 20:00
Limit: FCC_Part15.209_RE(3m)	Engineer: Roy Cheng
Probe: BBHA9120D_1-18GHz	Polarity: Vertical
EUT: 2x2 dual band 802.11ac indoor AP	Power: AC 120V/60Hz
Test Mode: Transmit at channel 2462MHz by 802.11b Ant 0+1	

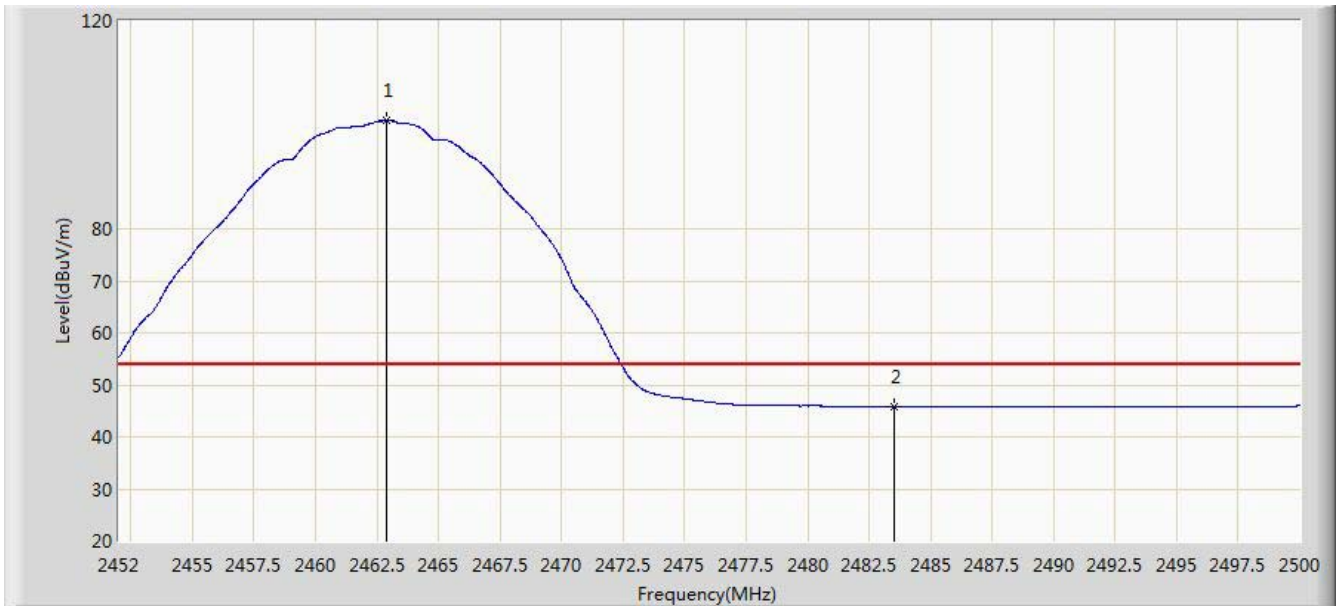

No	Mark	Frequency (MHz)	Measure Level (dBuV/m)	Reading Level (dBuV)	Over Limit (dB)	Limit (dBuV/m)	Factor (dB)	Type
1	*	2462.872	100.871	70.258	N/A	N/A	30.613	AV
2		2483.500	45.830	15.157	-8.170	54.000	30.673	AV

Note: Measure Level (dBuV/m) = Reading Level (dBuV) + Factor (dB)

Factor (dB) = Cable Loss (dB) + Antenna Factor (dB/m).



Site: AC1	Time: 2014/10/29 - 20:00
Limit: FCC_Part15.209_RE(3m)	Engineer: Roy Cheng
Probe: BBHA9120D_1-18GHz	Polarity: Horizontal
EUT: 2x2 dual band 802.11ac indoor AP	Power: AC 120V/60Hz
Test Mode: Transmit at channel 2412MHz by 802.11g Ant 0+1	

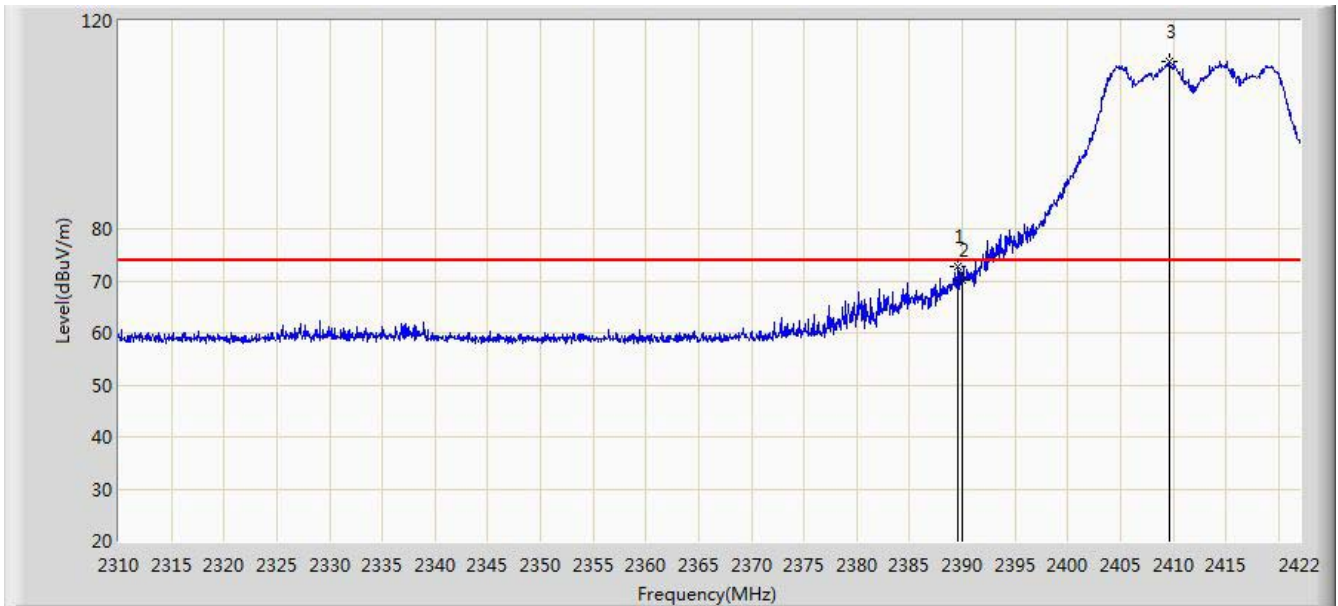

No	Mark	Frequency (MHz)	Measure Level (dBuV/m)	Reading Level (dBuV)	Over Limit (dB)	Limit (dBuV/m)	Factor (dB)	Type
1		2389.632	72.776	42.092	-1.224	74.000	30.685	PK
2		2390.000	70.168	39.484	-3.832	74.000	30.684	PK
3	*	2409.624	112.310	81.661	N/A	N/A	30.649	PK

Note: Measure Level (dBμV/m) = Reading Level (dBμV) + Factor (dB)

Factor (dB) = Cable Loss (dB) + Antenna Factor (dB/m).

Site: AC1	Time: 2014/10/29 - 20:02
Limit: FCC_Part15.209_RE(3m)	Engineer: Roy Cheng
Probe: BBHA9120D_1-18GHz	Polarity: Horizontal
EUT: 2x2 dual band 802.11ac indoor AP	Power: AC 120V/60Hz
Test Mode: Transmit at channel 2412MHz by 802.11g Ant 0+1	

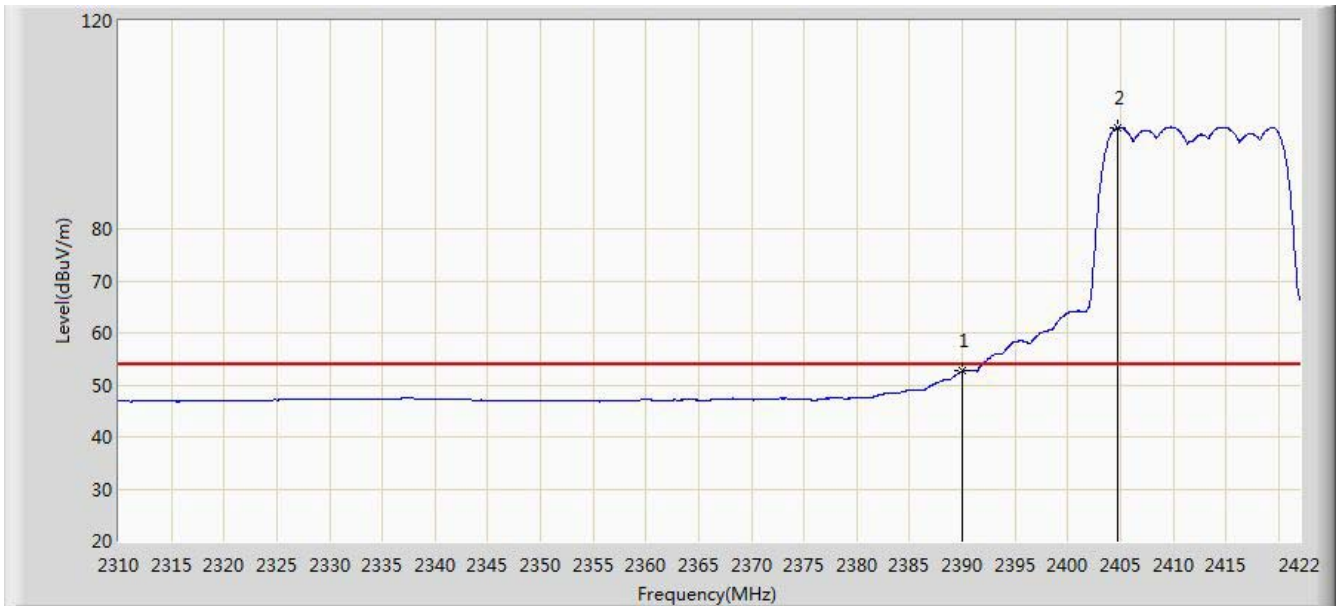

No	Flag	Mark	Frequency (MHz)	Measure Level (dBuV/m)	Reading Level (dBuV)	Over Limit (dB)	Limit (dBuV/m)	Factor (dB)	Type
1			2390.000	52.657	21.973	-1.343	54.000	30.684	AV
2		*	2404.696	99.390	68.733	N/A	N/A	30.657	AV

Note: Measure Level (dB $\mu$ V/m) = Reading Level (dB $\mu$ V) + Factor (dB)

Factor (dB) = Cable Loss (dB) + Antenna Factor (dB/m).

Site: AC1	Time: 2014/10/29 - 20:04
Limit: FCC_Part15.209_RE(3m)	Engineer: Roy Cheng
Probe: BBHA9120D_1-18GHz	Polarity: Vertical
EUT: 2x2 dual band 802.11ac indoor AP	Power: AC 120V/60Hz
Test Mode: Transmit at channel 2412MHz by 802.11g Ant 0+1	

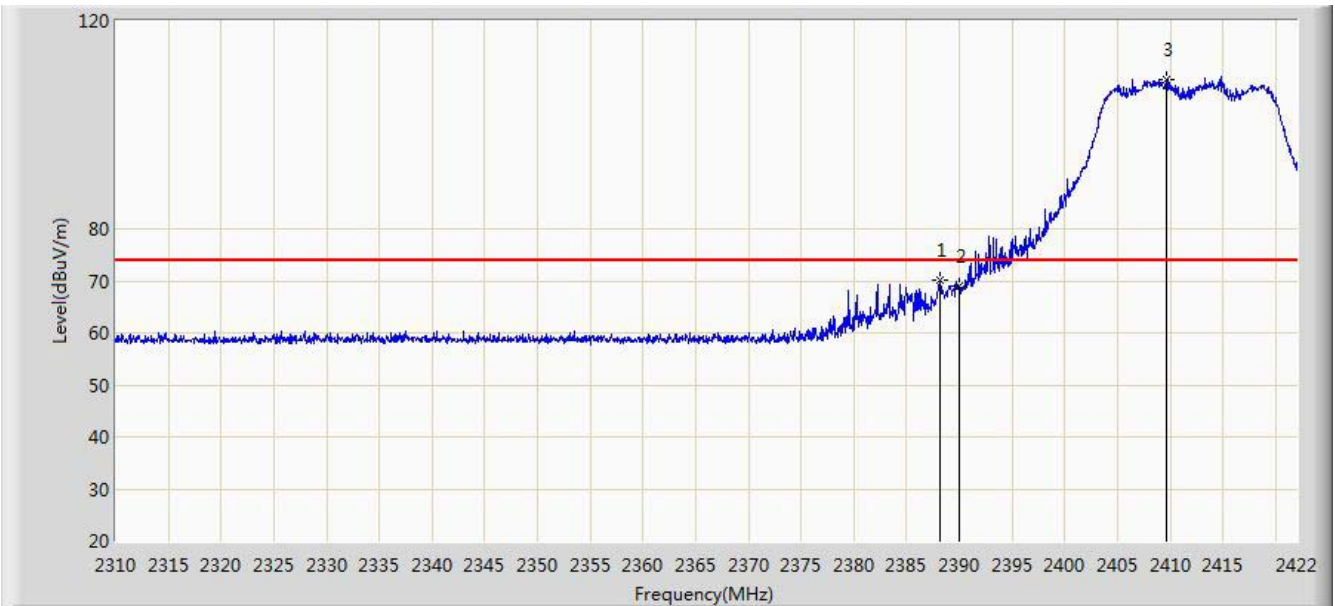

No	Mark	Frequency (MHz)	Measure Level (dBuV/m)	Reading Level (dBuV)	Over Limit (dB)	Limit (dBuV/m)	Factor (dB)	Type
1		2388.232	70.041	39.353	-3.959	74.000	30.687	PK
2		2390.000	68.908	38.224	-5.092	74.000	30.684	PK
3	*	2409.680	108.741	78.093	N/A	N/A	30.649	PK

Note: Measure Level (dBμV/m) = Reading Level (dBμV) + Factor (dB)

Factor (dB) = Cable Loss (dB) + Antenna Factor (dB/m).

Site: AC1	Time: 2014/10/29 - 20:06
Limit: FCC_Part15.209_RE(3m)	Engineer: Roy Cheng
Probe: BBHA9120D_1-18GHz	Polarity: Vertical
EUT: 2x2 dual band 802.11ac indoor AP	Power: AC 120V/60Hz
Test Mode: Transmit at channel 2412MHz by 802.11g Ant 0+1	

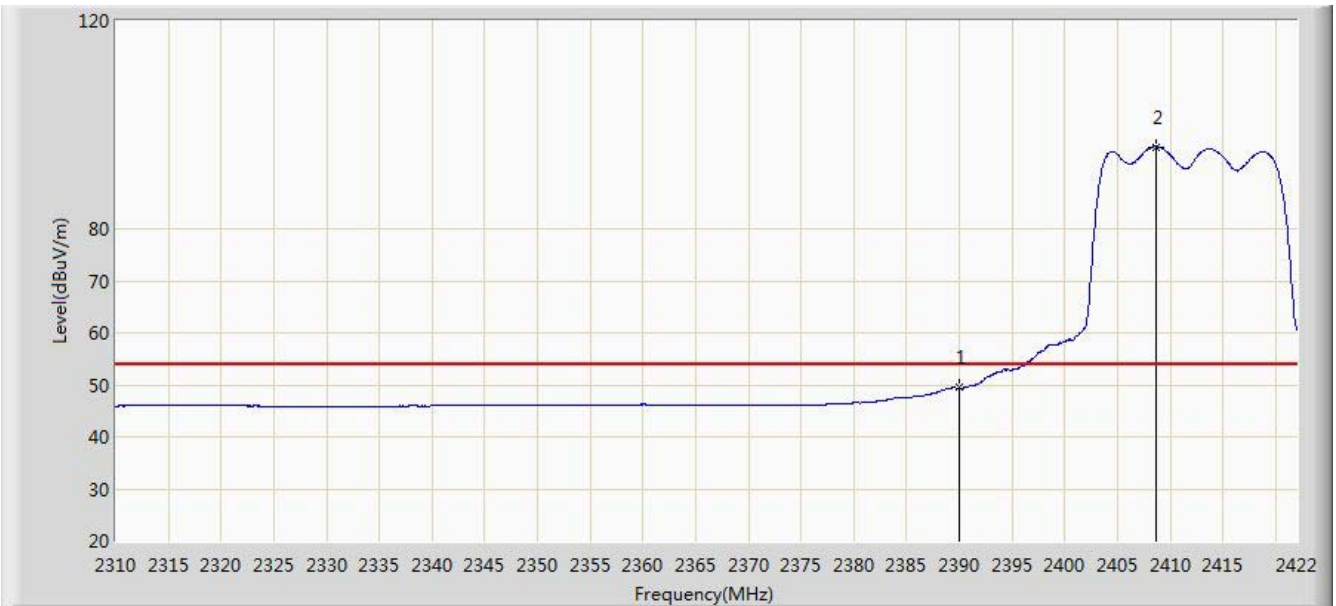

No	Mark	Frequency (MHz)	Measure Level (dBuV/m)	Reading Level (dBuV)	Over Limit (dB)	Limit (dBuV/m)	Factor (dB)	Type
1		2390.000	49.432	18.748	-4.568	54.000	30.684	AV
2	*	2408.728	95.774	65.124	N/A	N/A	30.650	AV

Note: Measure Level (dB $\mu$ V/m) = Reading Level (dB $\mu$ V) + Factor (dB)

Factor (dB) = Cable Loss (dB) + Antenna Factor (dB/m).

Site: AC1	Time: 2014/10/29 - 20:15
Limit: FCC_Part15.209_RE(3m)	Engineer: Roy Cheng
Probe: BBHA9120D_1-18GHz	Polarity: Horizontal
EUT: 2x2 dual band 802.11ac indoor AP	Power: AC 120V/60Hz
Test Mode: Transmit at channel 2462MHz by 802.11g Ant 0+1	

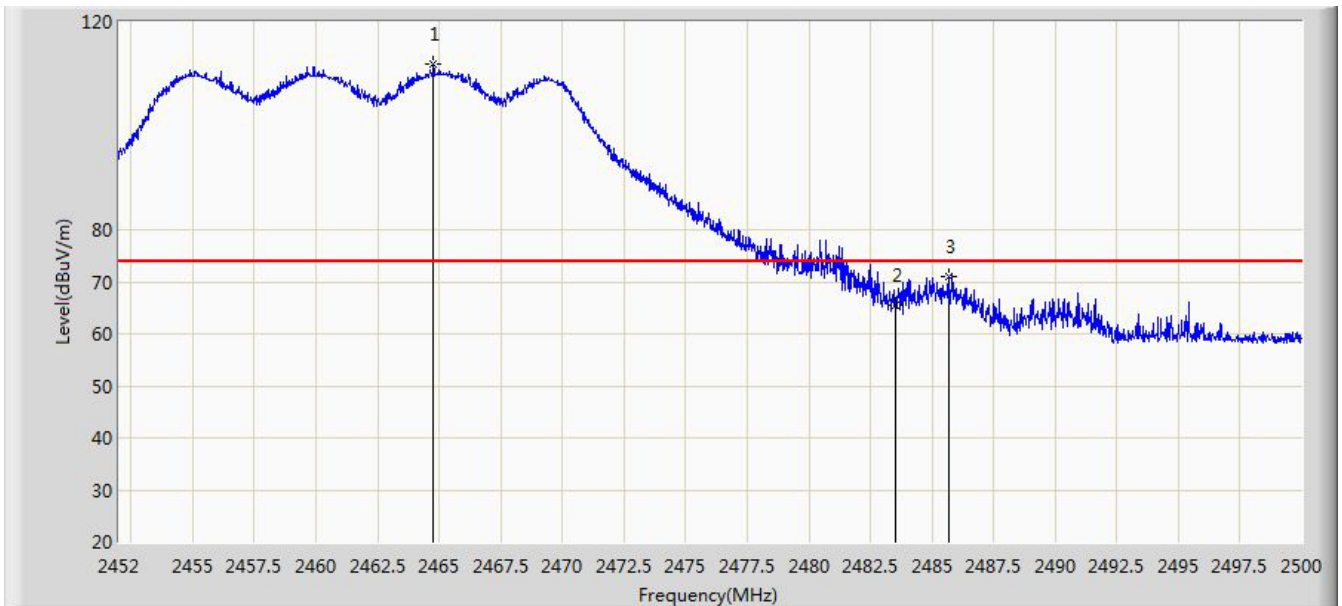

No	Mark	Frequency (MHz)	Measure Level (dBuV/m)	Reading Level (dBuV)	Over Limit (dB)	Limit (dBuV/m)	Factor (dB)	Type
1	*	2464.768	111.778	81.160	N/A	N/A	30.618	PK
2		2483.500	65.466	34.793	-8.534	74.000	30.673	PK
3		2485.672	71.120	40.441	-2.880	74.000	30.679	PK

Note: Measure Level (dB $\mu$ V/m) = Reading Level (dB $\mu$ V) + Factor (dB)

Factor (dB) = Cable Loss (dB) + Antenna Factor (dB/m).

Site: AC1	Time: 2014/10/29 - 20:17
Limit: FCC_Part15.209_RE(3m)	Engineer: Roy Cheng
Probe: BBHA9120D_1-18GHz	Polarity: Horizontal
EUT: 2x2 dual band 802.11ac indoor AP	Power: AC 120V/60Hz
Test Mode: Transmit at channel 2462MHz by 802.11g Ant 0+1	

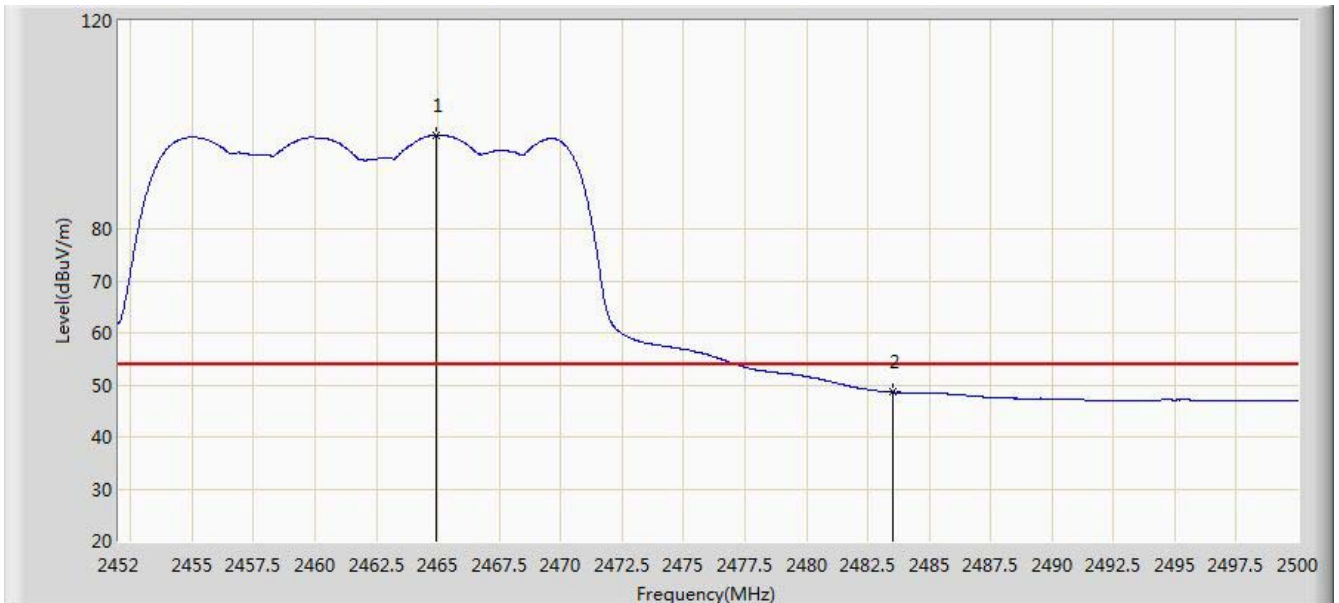

No	Mark	Frequency (MHz)	Measure Level (dBuV/m)	Reading Level (dBuV)	Over Limit (dB)	Limit (dBuV/m)	Factor (dB)	Type
1	*	2464.960	98.043	67.425	N/A	N/A	30.618	AV
2		2483.500	48.596	17.923	-5.404	54.000	30.673	AV

Note: Measure Level (dB $\mu$ V/m) = Reading Level (dB $\mu$ V) + Factor (dB)

Factor (dB) = Cable Loss (dB) + Antenna Factor (dB/m).

Site: AC1	Time: 2014/10/29 - 20:18
Limit: FCC_Part15.209_RE(3m)	Engineer: Roy Cheng
Probe: BBHA9120D_1-18GHz	Polarity: Vertical
EUT: 2x2 dual band 802.11ac indoor AP	Power: AC 120V/60Hz
Test Mode: Transmit at channel 2462MHz by 802.11g Ant 0+1	

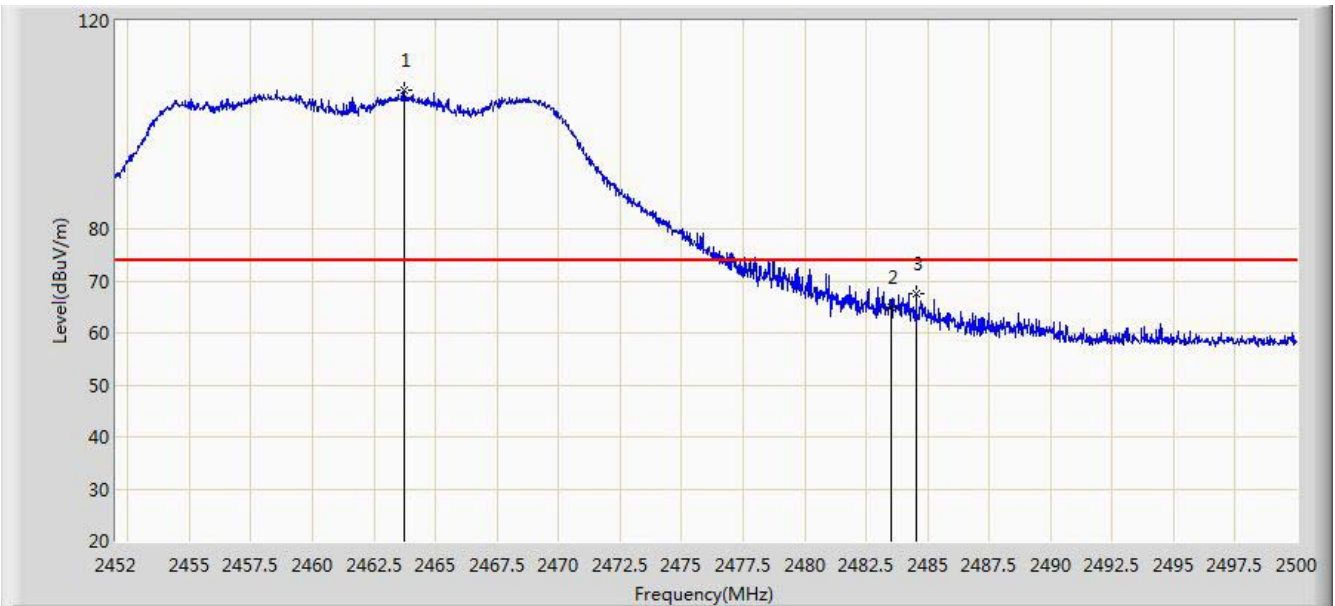

No	Mark	Frequency (MHz)	Measure Level (dBuV/m)	Reading Level (dBuV)	Over Limit (dB)	Limit (dBuV/m)	Factor (dB)	Type
1	*	2463.736	106.680	76.065	N/A	N/A	30.615	PK
2		2483.500	65.020	34.347	-8.980	74.000	30.673	PK
3		2484.544	67.634	36.958	-6.366	74.000	30.676	PK

Note: Measure Level (dBμV/m) = Reading Level (dBμV) + Factor (dB)

Factor (dB) = Cable Loss (dB) + Antenna Factor (dB/m).

Site: AC1	Time: 2014/10/29 - 20:19
Limit: FCC_Part15.209_RE(3m)	Engineer: Roy Cheng
Probe: BBHA9120D_1-18GHz	Polarity: Vertical
EUT: 2x2 dual band 802.11ac indoor AP	Power: AC 120V/60Hz
Test Mode: Transmit at channel 2462MHz by 802.11g Ant 0+1	

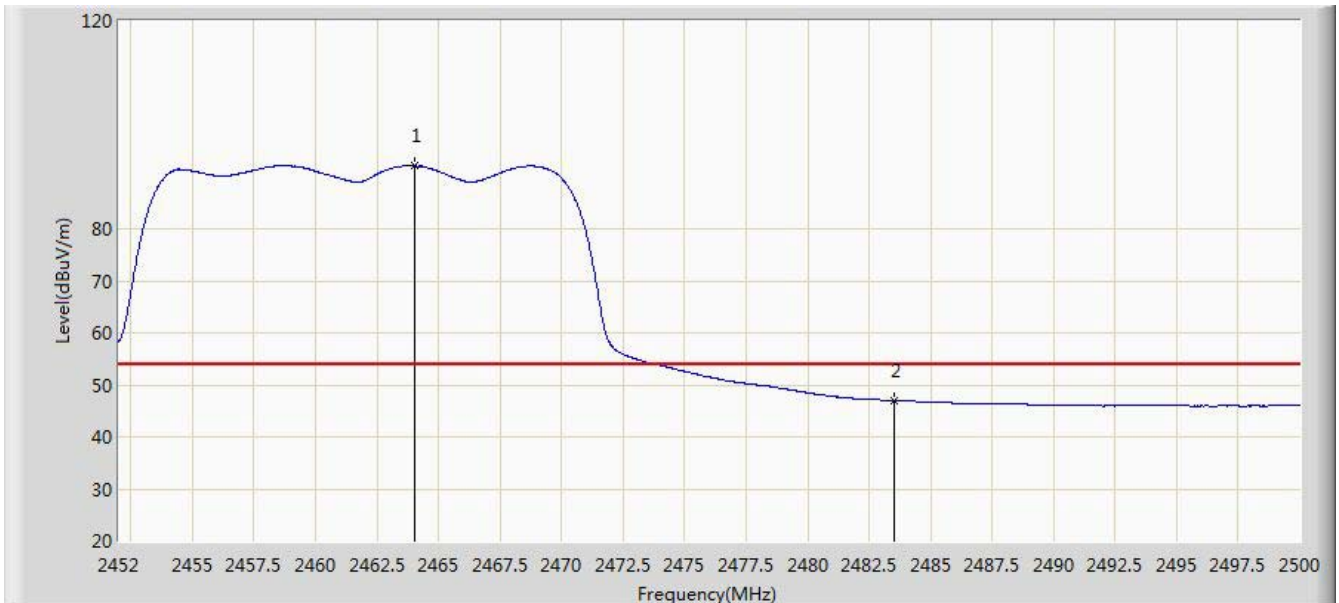

No	Mark	Frequency (MHz)	Measure Level (dBuV/m)	Reading Level (dBuV)	Over Limit (dB)	Limit (dBuV/m)	Factor (dB)	Type
1	*	2464.000	92.041	61.425	N/A	N/A	30.615	AV
2		2483.500	46.999	16.326	-7.001	54.000	30.673	AV

Note: Measure Level (dB $\mu$ V/m) = Reading Level (dB $\mu$ V) + Factor (dB)

Factor (dB) = Cable Loss (dB) + Antenna Factor (dB/m).



Site: AC1	Time: 2014/10/29 - 20:26
Limit: FCC_Part15.209_RE(3m)	Engineer: Roy Cheng
Probe: BBHA9120D_1-18GHz	Polarity: Horizontal
EUT: 2x2 dual band 802.11ac indoor AP	Power: AC 120V/60Hz
Test Mode: Transmit at channel 2412MHz by 802.11n20 Ant 0+1	

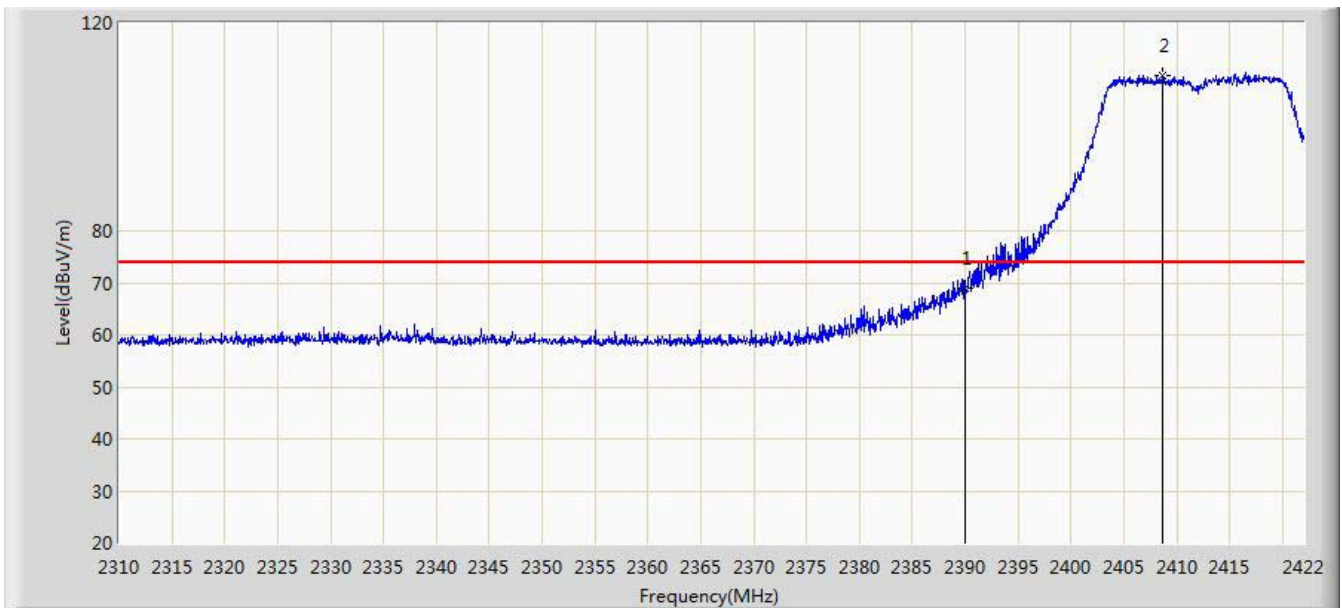

No	Mark	Frequency (MHz)	Measure Level (dBuV/m)	Reading Level (dBuV)	Over Limit (dB)	Limit (dBuV/m)	Factor (dB)	Type
1		2390.000	69.114	38.430	-4.886	74.000	30.684	PK
2	*	2408.728	109.924	79.274	N/A	N/A	30.650	PK

Note: Measure Level (dB $\mu$ V/m) = Reading Level (dB $\mu$ V) + Factor (dB)

Factor (dB) = Cable Loss (dB) + Antenna Factor (dB/m).

Site: AC1	Time: 2014/10/29 - 20:23
Limit: FCC_Part15.209_RE(3m)	Engineer: Roy Cheng
Probe: BBHA9120D_1-18GHz	Polarity: Horizontal
EUT: 2x2 dual band 802.11ac indoor AP	Power: AC 120V/60Hz
Test Mode: Transmit at channel 2412MHz by 802.11n20 Ant 0+1	

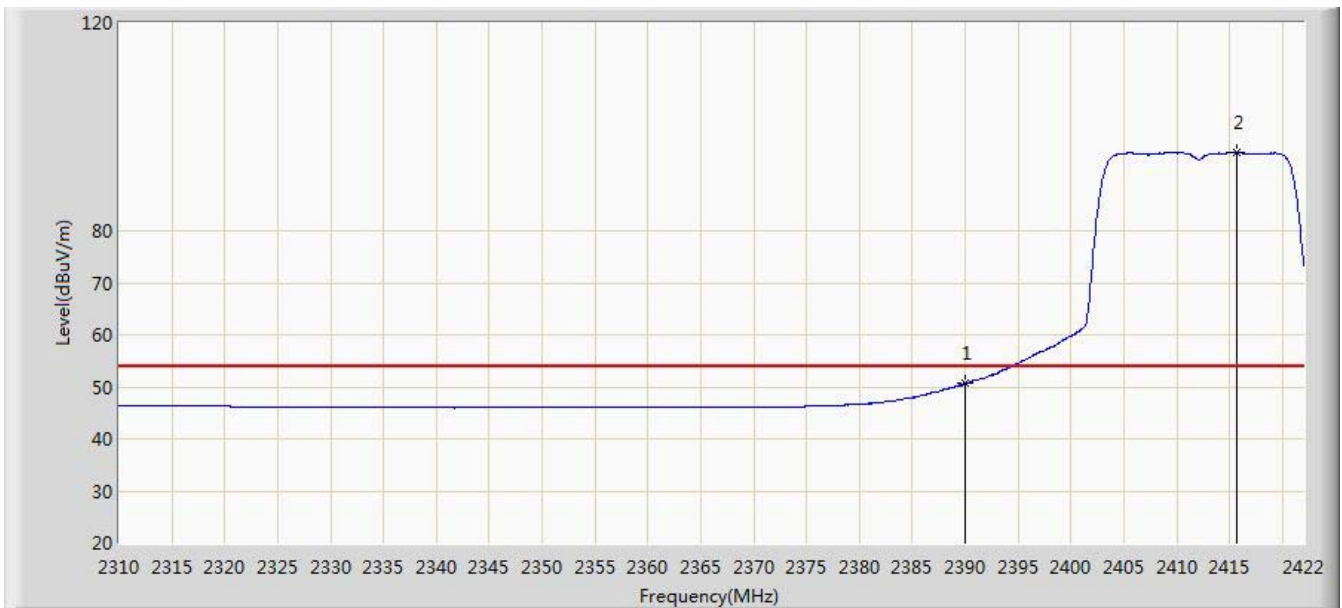

No	Mark	Frequency (MHz)	Measure Level (dBuV/m)	Reading Level (dBuV)	Over Limit (dB)	Limit (dBuV/m)	Factor (dB)	Type
1		2390.000	50.714	20.030	-3.286	54.000	30.684	AV
2	*	2415.728	95.015	64.376	N/A	N/A	30.639	AV

Note: Measure Level (dBuV/m) = Reading Level (dBuV) + Factor (dB)

Factor (dB) = Cable Loss (dB) + Antenna Factor (dB/m).

Site: AC1	Time: 2014/10/29 - 20:28
Limit: FCC_Part15.209_RE(3m)	Engineer: Roy Cheng
Probe: BBHA9120D_1-18GHz	Polarity: Vertical
EUT: 2x2 dual band 802.11ac indoor AP	Power: AC 120V/60Hz
Test Mode: Transmit at channel 2412MHz by 802.11n20 Ant 0+1	

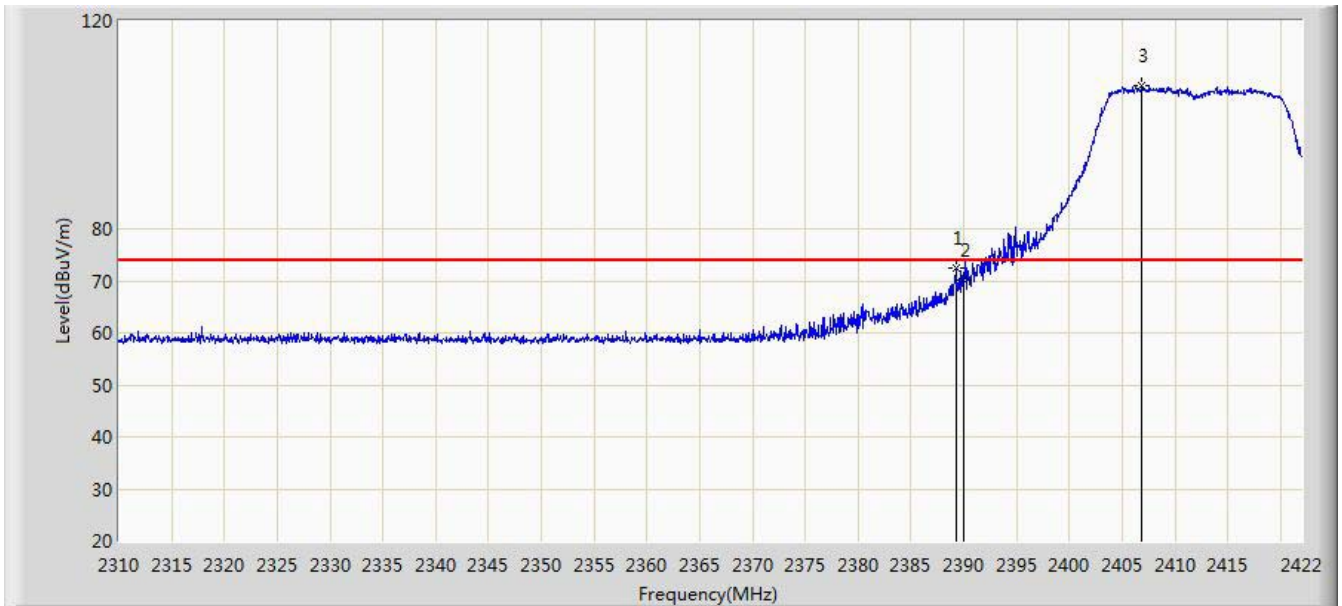

No	Mark	Frequency (MHz)	Measure Level (dBuV/m)	Reading Level (dBuV)	Over Limit (dB)	Limit (dBuV/m)	Factor (dB)	Type
1		2389.296	72.443	41.758	-1.557	74.000	30.686	PK
2		2390.000	70.039	39.355	-3.961	74.000	30.684	PK
3	*	2406.880	107.487	76.834	N/A	N/A	30.653	PK

Note: Measure Level (dBμV/m) = Reading Level (dBμV) + Factor (dB)

Factor (dB) = Cable Loss (dB) + Antenna Factor (dB/m).

Site: AC1	Time: 2014/10/29 - 20:30
Limit: FCC_Part15.209_RE(3m)	Engineer: Roy Cheng
Probe: BBHA9120D_1-18GHz	Polarity: Vertical
EUT: 2x2 dual band 802.11ac indoor AP	Power: AC 120V/60Hz
Test Mode: Transmit at channel 2412MHz by 802.11n20 Ant 0+1	

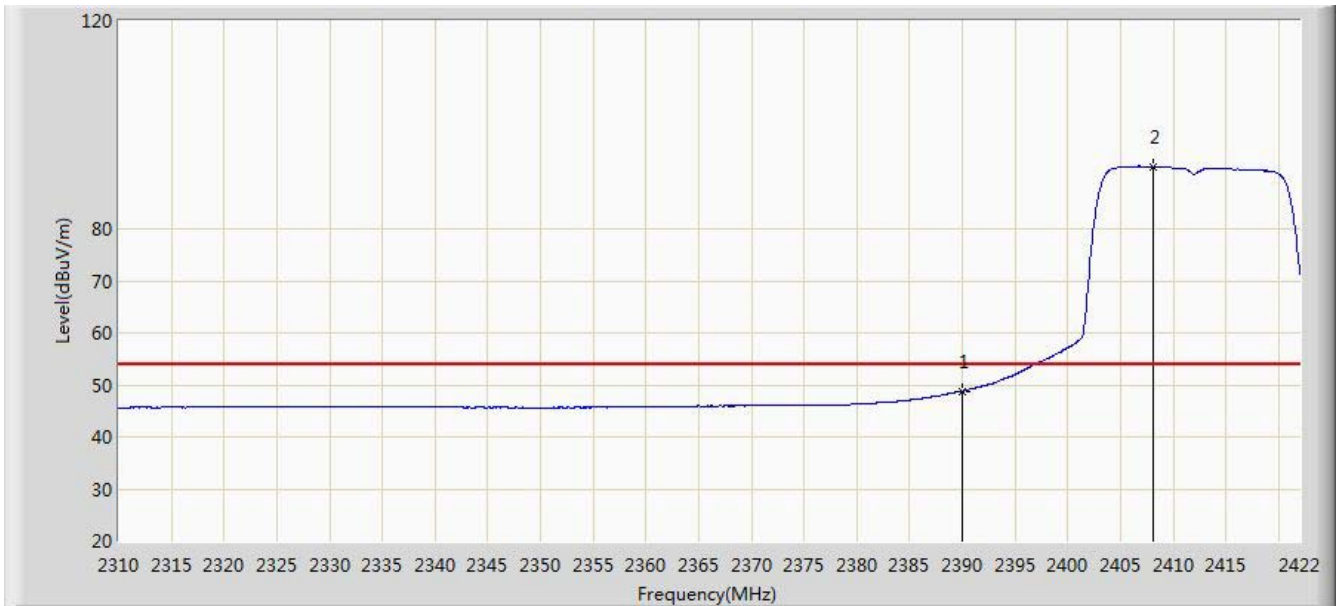

No	Mark	Frequency (MHz)	Measure Level (dBuV/m)	Reading Level (dBuV)	Over Limit (dB)	Limit (dBuV/m)	Factor (dB)	Type
1		2390.000	48.758	18.074	-5.242	54.000	30.684	AV
2	*	2408.168	92.010	61.359	N/A	N/A	30.651	AV

Note: Measure Level (dB $\mu$ V/m) = Reading Level (dB $\mu$ V) + Factor (dB)

Factor (dB) = Cable Loss (dB) + Antenna Factor (dB/m).

Site: AC1	Time: 2014/10/29 - 20:35
Limit: FCC_Part15.209_RE(3m)	Engineer: Roy Cheng
Probe: BBHA9120D_1-18GHz	Polarity: Horizontal
EUT: 2x2 dual band 802.11ac indoor AP	Power: AC 120V/60Hz
Test Mode: Transmit at channel 2462MHz by 802.11n20 Ant 0+1	

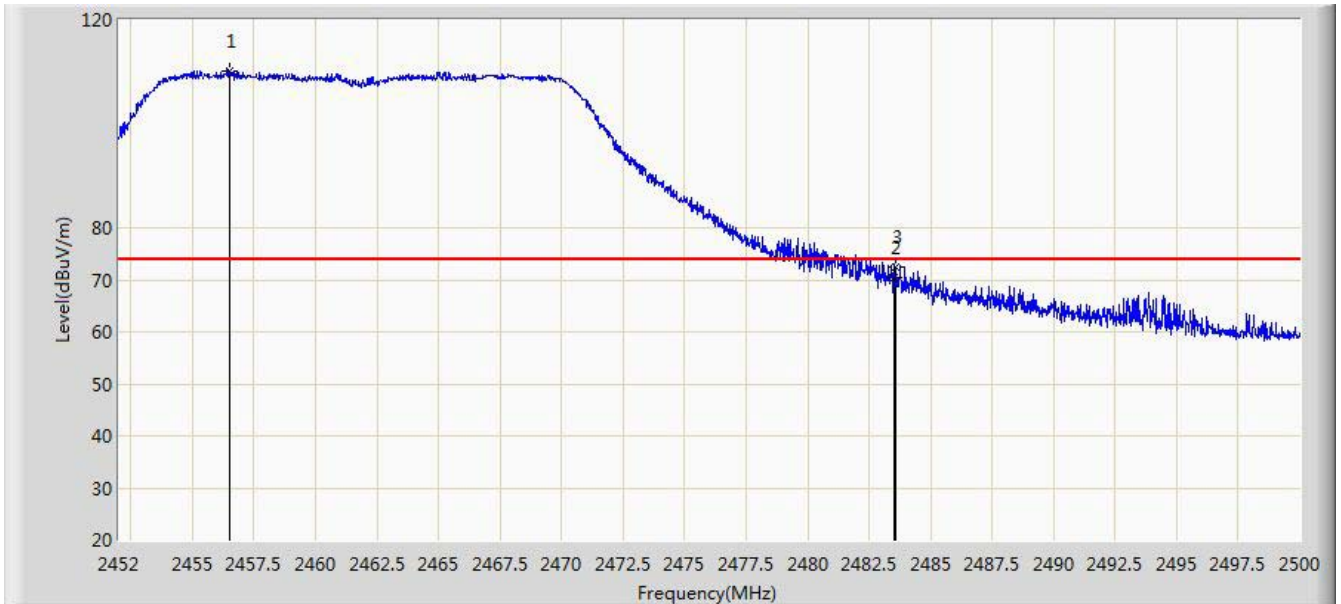

No	Mark	Frequency (MHz)	Measure Level (dBuV/m)	Reading Level (dBuV)	Over Limit (dB)	Limit (dBuV/m)	Factor (dB)	Type
1	*	2456.512	110.284	79.681	N/A	N/A	30.603	PK
2		2483.500	70.414	39.741	-3.586	74.000	30.673	PK
3		2483.560	72.337	41.664	-1.663	74.000	30.673	PK

Note: Measure Level (dBuV/m) = Reading Level (dBuV) + Factor (dB)

Factor (dB) = Cable Loss (dB) + Antenna Factor (dB/m).

Site: AC1	Time: 2014/10/29 - 20:36
Limit: FCC_Part15.209_RE(3m)	Engineer: Roy Cheng
Probe: BBHA9120D_1-18GHz	Polarity: Horizontal
EUT: 2x2 dual band 802.11ac indoor AP	Power: AC 120V/60Hz
Test Mode: Transmit at channel 2462MHz by 802.11n20 Ant 0+1	

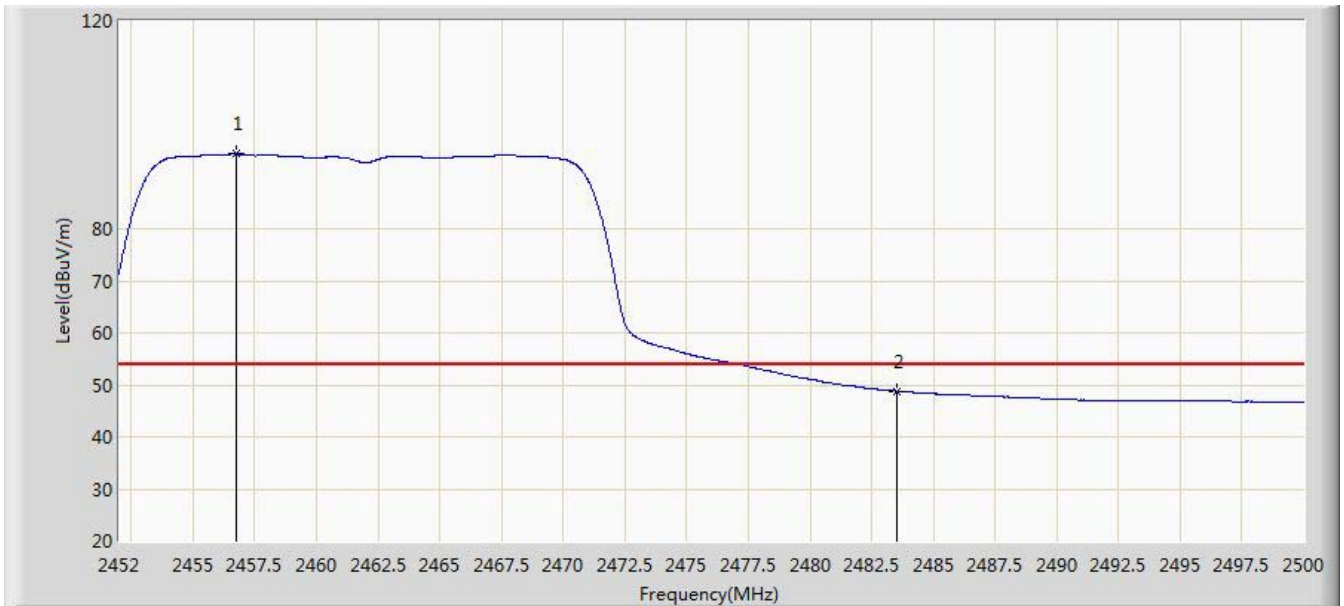

No	Mark	Frequency (MHz)	Measure Level (dBuV/m)	Reading Level (dBuV)	Over Limit (dB)	Limit (dBuV/m)	Factor (dB)	Type
1	*	2456.752	94.382	63.778	N/A	N/A	30.604	AV
2		2483.500	48.788	18.115	-5.212	54.000	30.673	AV

Note: Measure Level (dB $\mu$ V/m) = Reading Level (dB $\mu$ V) + Factor (dB)

Factor (dB) = Cable Loss (dB) + Antenna Factor (dB/m).

Site: AC1	Time: 2014/10/29 - 20:37
Limit: FCC_Part15.209_RE(3m)	Engineer: Roy Cheng
Probe: BBHA9120D_1-18GHz	Polarity: Vertical
EUT: 2x2 dual band 802.11ac indoor AP	Power: AC 120V/60Hz
Test Mode: Transmit at channel 2462MHz by 802.11n20 Ant 0+1	

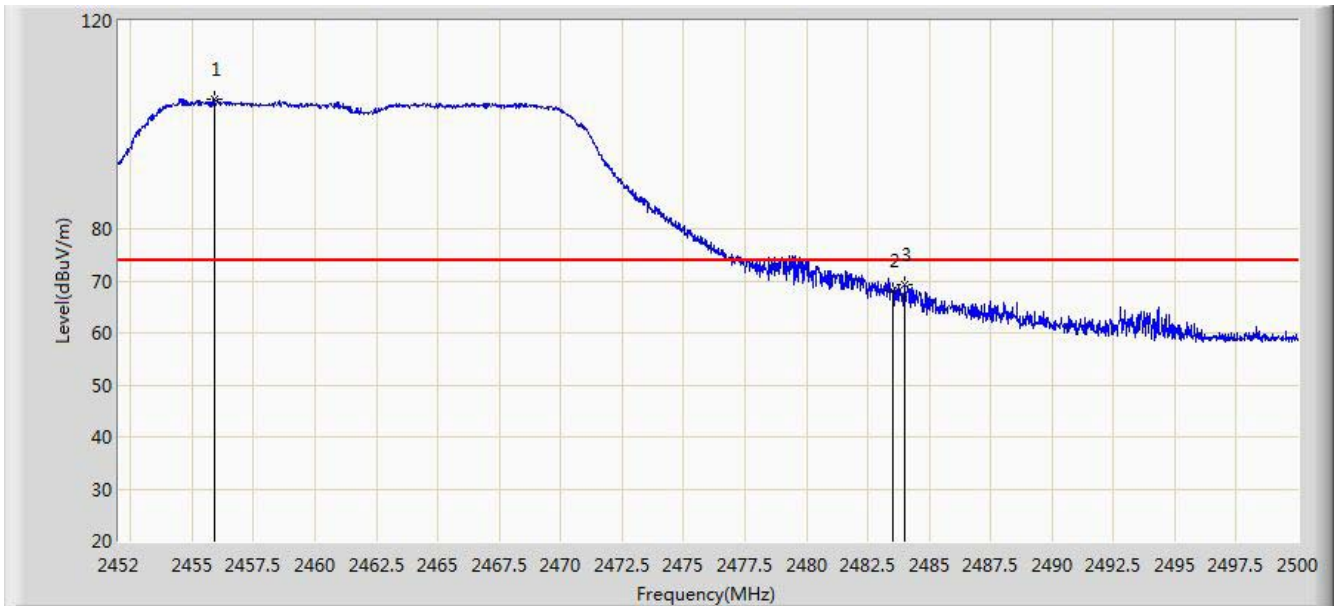

No	Mark	Frequency (MHz)	Measure Level (dBuV/m)	Reading Level (dBuV)	Over Limit (dB)	Limit (dBuV/m)	Factor (dB)	Type
1	*	2455.936	104.985	74.383	N/A	N/A	30.602	PK
2		2483.500	68.045	37.372	-5.955	74.000	30.673	PK
3		2483.992	69.219	38.545	-4.781	74.000	30.675	PK

Note: Measure Level (dBμV/m) = Reading Level (dBμV) + Factor (dB)

Factor (dB) = Cable Loss (dB) + Antenna Factor (dB/m).

Site: AC1	Time: 2014/10/29 - 20:39
Limit: FCC_Part15.209_RE(3m)	Engineer: Roy Cheng
Probe: BBHA9120D_1-18GHz	Polarity: Vertical
EUT: 2x2 dual band 802.11ac indoor AP	Power: AC 120V/60Hz
Test Mode: Transmit at channel 2462MHz by 802.11n20 Ant 0+1	

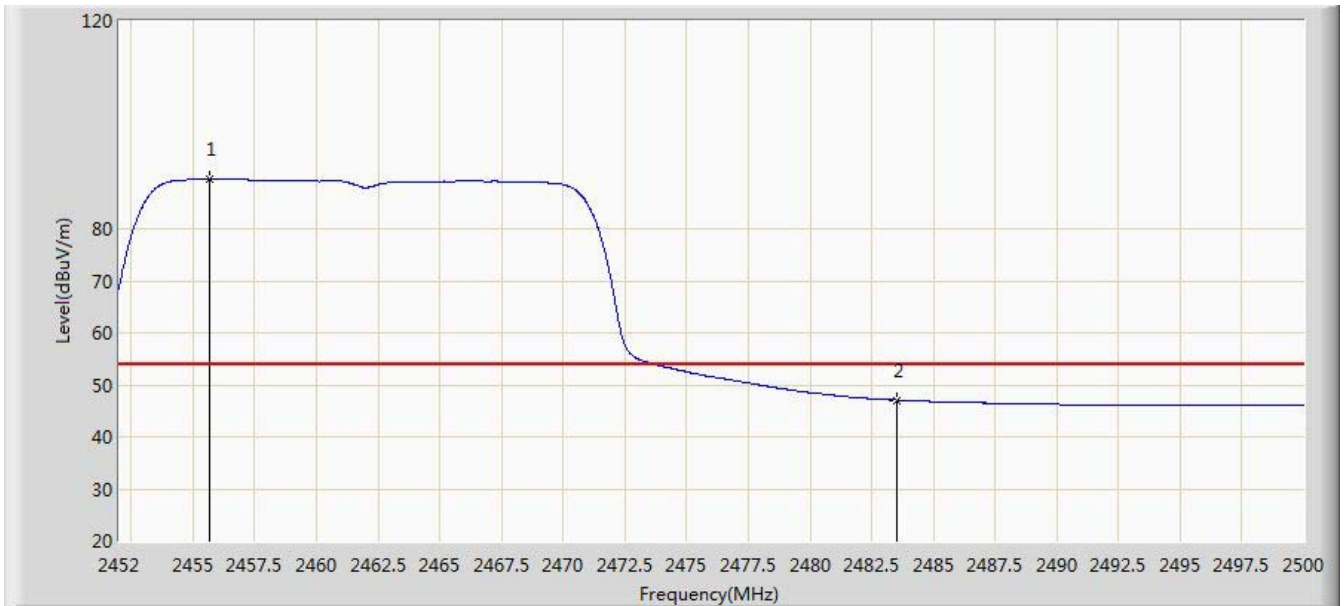

No	Mark	Frequency (MHz)	Measure Level (dBuV/m)	Reading Level (dBuV)	Over Limit (dB)	Limit (dBuV/m)	Factor (dB)	Type
1	*	2455.696	89.604	59.002	N/A	N/A	30.602	AV
2		2483.500	47.095	16.422	-6.905	54.000	30.673	AV

Note: Measure Level (dB $\mu$ V/m) = Reading Level (dB $\mu$ V) + Factor (dB)

Factor (dB) = Cable Loss (dB) + Antenna Factor (dB/m).



Site: AC1	Time: 2014/10/29 - 20:47
Limit: FCC_Part15.209_RE(3m)	Engineer: Roy Cheng
Probe: BBHA9120D_1-18GHz	Polarity: Horizontal
EUT: 2x2 dual band 802.11ac indoor AP	Power: AC 120V/60Hz
Test Mode: Transmit at channel 2422MHz by 802.11n40 Ant 0+1	

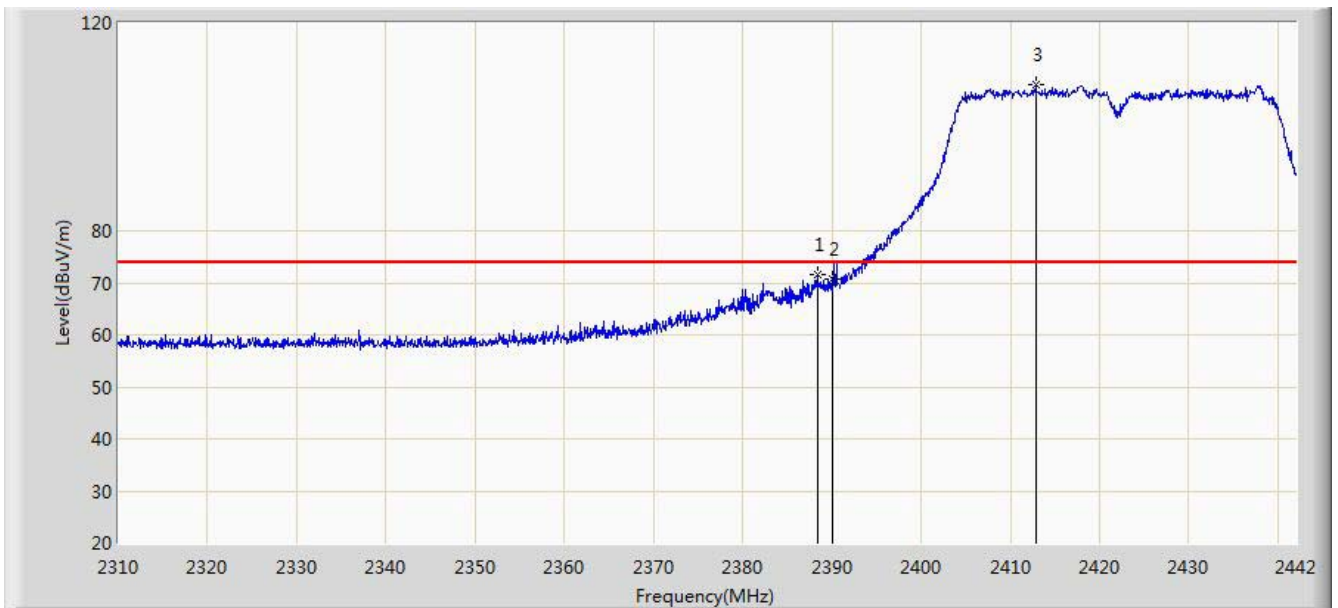

No	Mark	Frequency (MHz)	Measure Level (dBuV/m)	Reading Level (dBuV)	Over Limit (dB)	Limit (dBuV/m)	Factor (dB)	Type
1		2388.342	71.637	40.950	-2.363	74.000	30.687	PK
2		2390.000	70.584	39.900	-3.416	74.000	30.684	PK
3	*	2412.894	108.247	77.604	N/A	N/A	30.644	PK

Note: Measure Level (dB $\mu$ V/m) = Reading Level (dB $\mu$ V) + Factor (dB)

Factor (dB) = Cable Loss (dB) + Antenna Factor (dB/m).

Site: AC1	Time: 2014/10/29 - 20:46
Limit: FCC_Part15.209_RE(3m)	Engineer: Roy Cheng
Probe: BBHA9120D_1-18GHz	Polarity: Horizontal
EUT: 2x2 dual band 802.11ac indoor AP	Power: AC 120V/60Hz
Test Mode: Transmit at channel 2422MHz by 802.11n40 Ant 0+1	

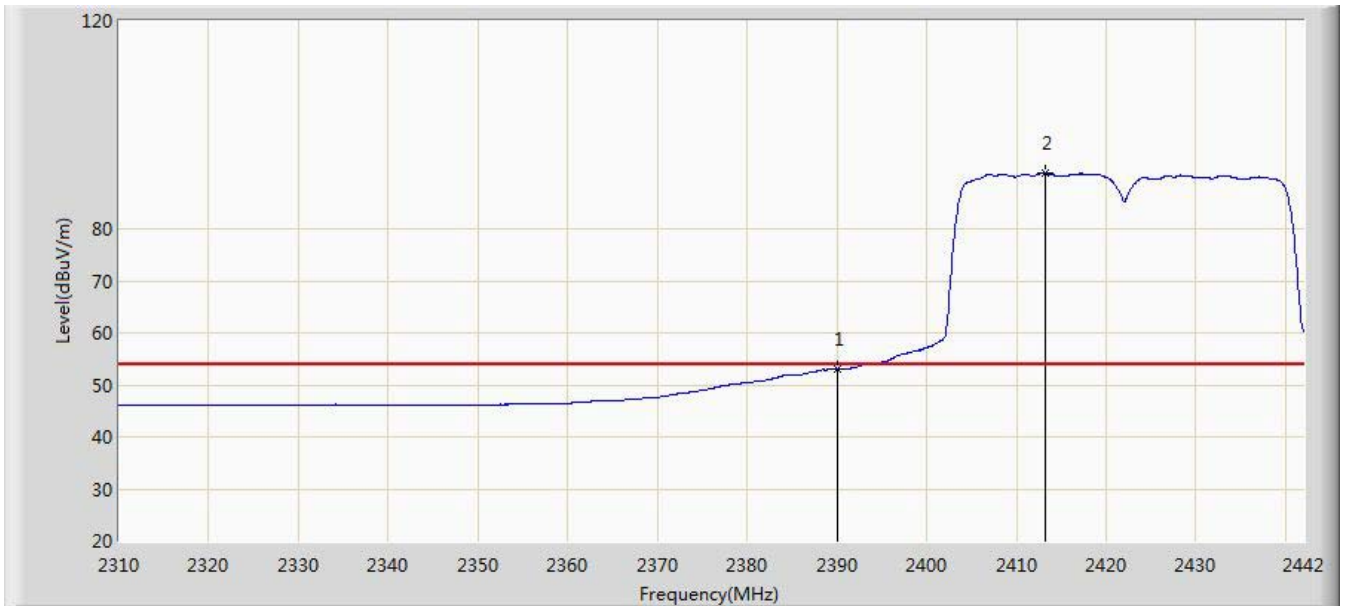

No	Mark	Frequency (MHz)	Measure Level (dBuV/m)	Reading Level (dBuV)	Over Limit (dB)	Limit (dBuV/m)	Factor (dB)	Type
1		2390.000	52.920	22.236	-1.080	54.000	30.684	AV
2	*	2413.158	90.683	60.040	N/A	N/A	30.643	AV

Note: Measure Level (dBμV/m) = Reading Level (dBμV) + Factor (dB)

Factor (dB) = Cable Loss (dB) + Antenna Factor (dB/m).

Site: AC1	Time: 2014/10/29 - 20:49
Limit: FCC_Part15.209_RE(3m)	Engineer: Roy Cheng
Probe: BBHA9120D_1-18GHz	Polarity: Vertical
EUT: 2x2 dual band 802.11ac indoor AP	Power: AC 120V/60Hz
Test Mode: Transmit at channel 2422MHz by 802.11n40 Ant 0+1	

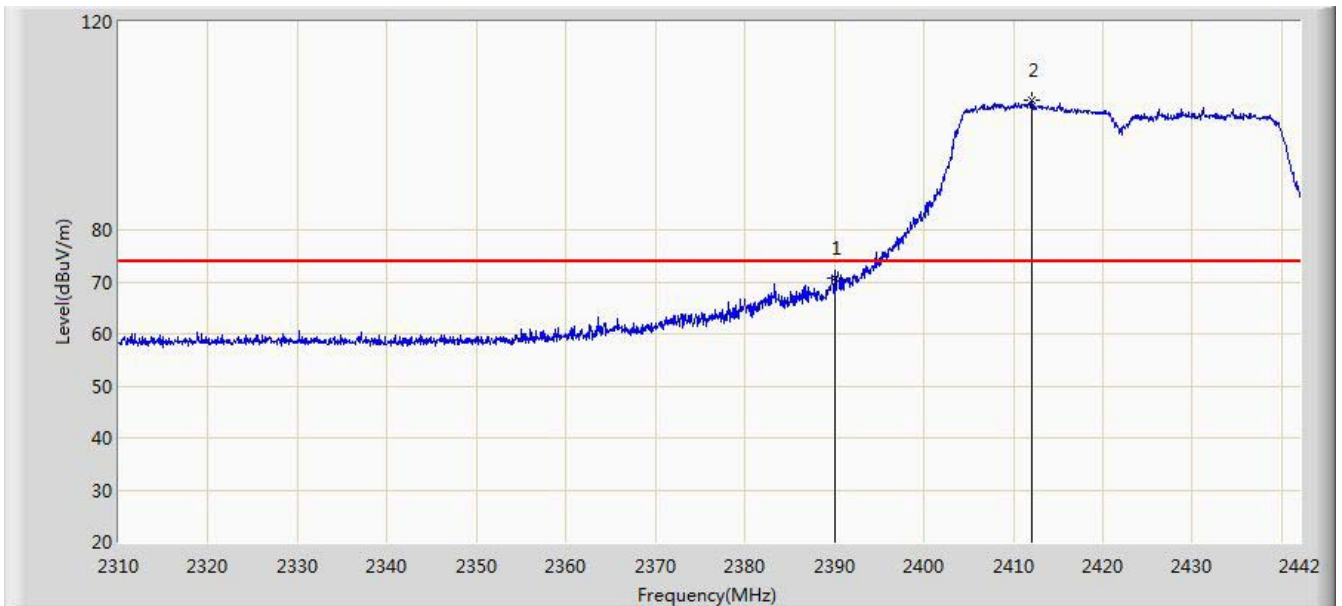

No	Mark	Frequency (MHz)	Measure Level (dBuV/m)	Reading Level (dBuV)	Over Limit (dB)	Limit (dBuV/m)	Factor (dB)	Type
1		2390.000	70.813	40.129	-3.187	74.000	30.684	PK
2	*	2412.102	104.839	74.194	N/A	N/A	30.645	PK

Note: Measure Level (dB $\mu$ V/m) = Reading Level (dB $\mu$ V) + Factor (dB)

Factor (dB) = Cable Loss (dB) + Antenna Factor (dB/m).

Site: AC1	Time: 2014/10/29 - 20:50
Limit: FCC_Part15.209_RE(3m)	Engineer: Roy Cheng
Probe: BBHA9120D_1-18GHz	Polarity: Vertical
EUT: 2x2 dual band 802.11ac indoor AP	Power: AC 120V/60Hz
Test Mode: Transmit at channel 2422MHz by 802.11n40 Ant 0+1	

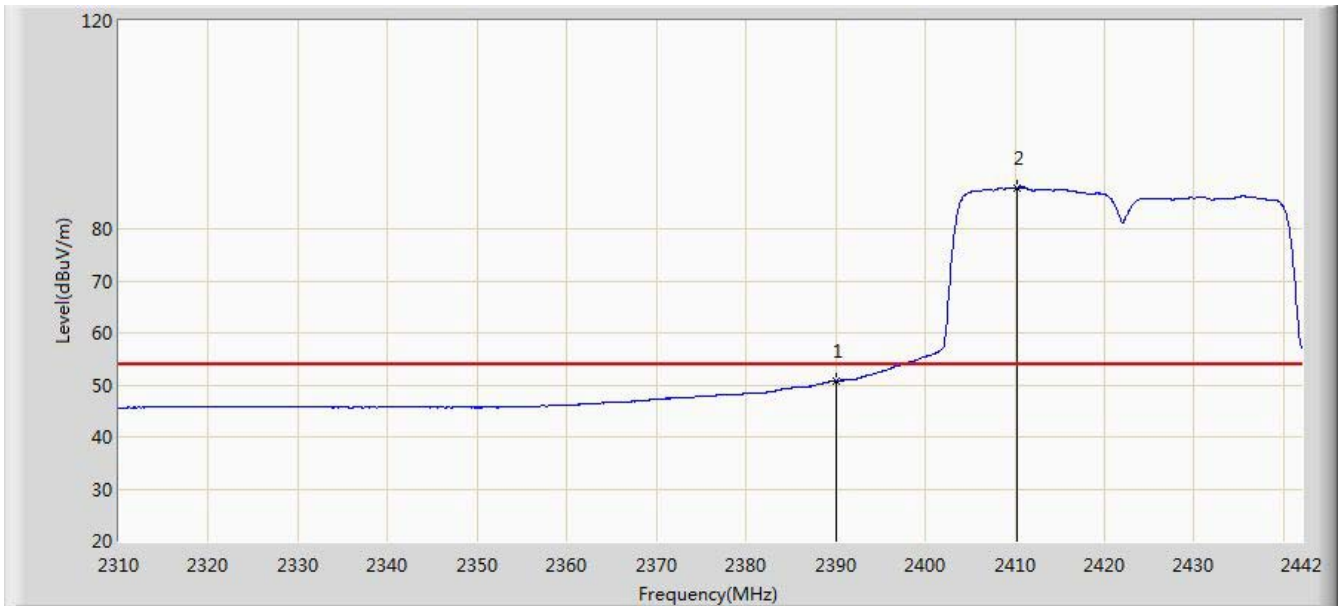

No	Mark	Frequency (MHz)	Measure Level (dBuV/m)	Reading Level (dBuV)	Over Limit (dB)	Limit (dBuV/m)	Factor (dB)	Type
1		2390.000	50.617	19.933	-3.383	54.000	30.684	AV
2	*	2410.320	87.891	57.244	N/A	N/A	30.647	AV

Note: Measure Level (dBuV/m) = Reading Level (dBuV) + Factor (dB)

Factor (dB) = Cable Loss (dB) + Antenna Factor (dB/m).

Site: AC1	Time: 2014/10/29 - 20:56
Limit: FCC_Part15.209_RE(3m)	Engineer: Roy Cheng
Probe: BBHA9120D_1-18GHz	Polarity: Horizontal
EUT: 2x2 dual band 802.11ac indoor AP	Power: AC 120V/60Hz
Test Mode: Transmit at channel 2452MHz by 802.11n40 Ant 0+1	

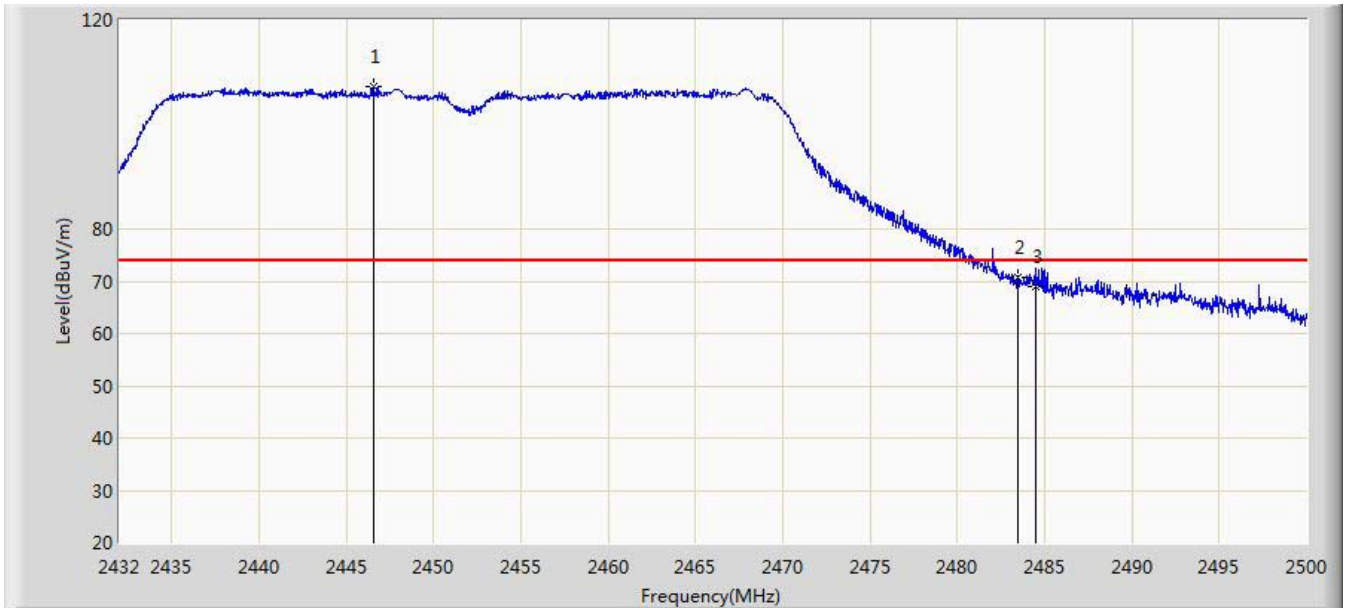

No	Mark	Frequency (MHz)	Measure Level (dBuV/m)	Reading Level (dBuV)	Over Limit (dB)	Limit (dBuV/m)	Factor (dB)	Type
1	*	2446.552	107.140	76.552	N/A	N/A	30.588	PK
2		2483.500	70.855	40.182	-3.145	74.000	30.673	PK
3		2484.462	72.923	42.248	-1.077	74.000	30.675	PK

Note: Measure Level (dBuV/m) = Reading Level (dBuV) + Factor (dB)

Factor (dB) = Cable Loss (dB) + Antenna Factor (dB/m).

Site: AC1	Time: 2014/10/29 - 20:57
Limit: FCC_Part15.209_RE(3m)	Engineer: Roy Cheng
Probe: BBHA9120D_1-18GHz	Polarity: Horizontal
EUT: 2x2 dual band 802.11ac indoor AP	Power: AC 120V/60Hz
Test Mode: Transmit at channel 2452MHz by 802.11n40 Ant 0+1	

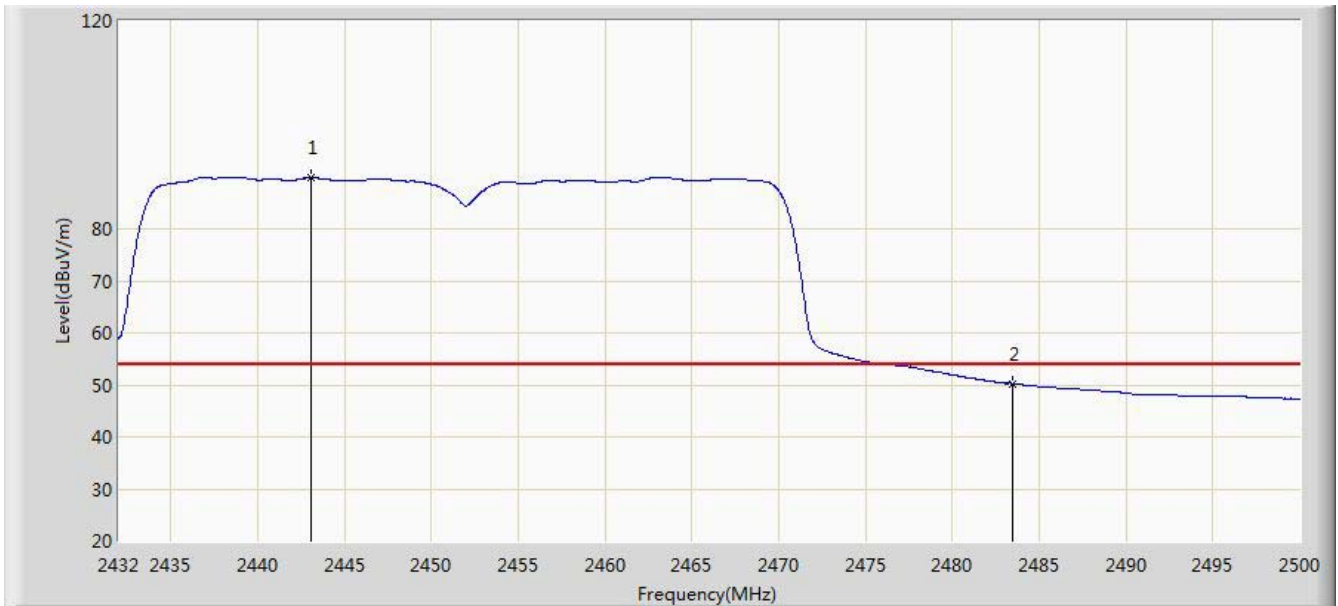

No	Mark	Frequency (MHz)	Measure Level (dBuV/m)	Reading Level (dBuV)	Over Limit (dB)	Limit (dBuV/m)	Factor (dB)	Type
1	*	2443.084	89.742	59.149	N/A	N/A	30.593	AV
2		2483.500	50.251	19.578	-3.749	54.000	30.673	AV

Note: Measure Level (dB $\mu$ V/m) = Reading Level (dB $\mu$ V) + Factor (dB)

Factor (dB) = Cable Loss (dB) + Antenna Factor (dB/m).

Site: AC1	Time: 2014/10/29 - 20:58
Limit: FCC_Part15.209_RE(3m)	Engineer: Roy Cheng
Probe: BBHA9120D_1-18GHz	Polarity: Vertical
EUT: 2x2 dual band 802.11ac indoor AP	Power: AC 120V/60Hz
Test Mode: Transmit at channel 2452MHz by 802.11n40 Ant 0+1	

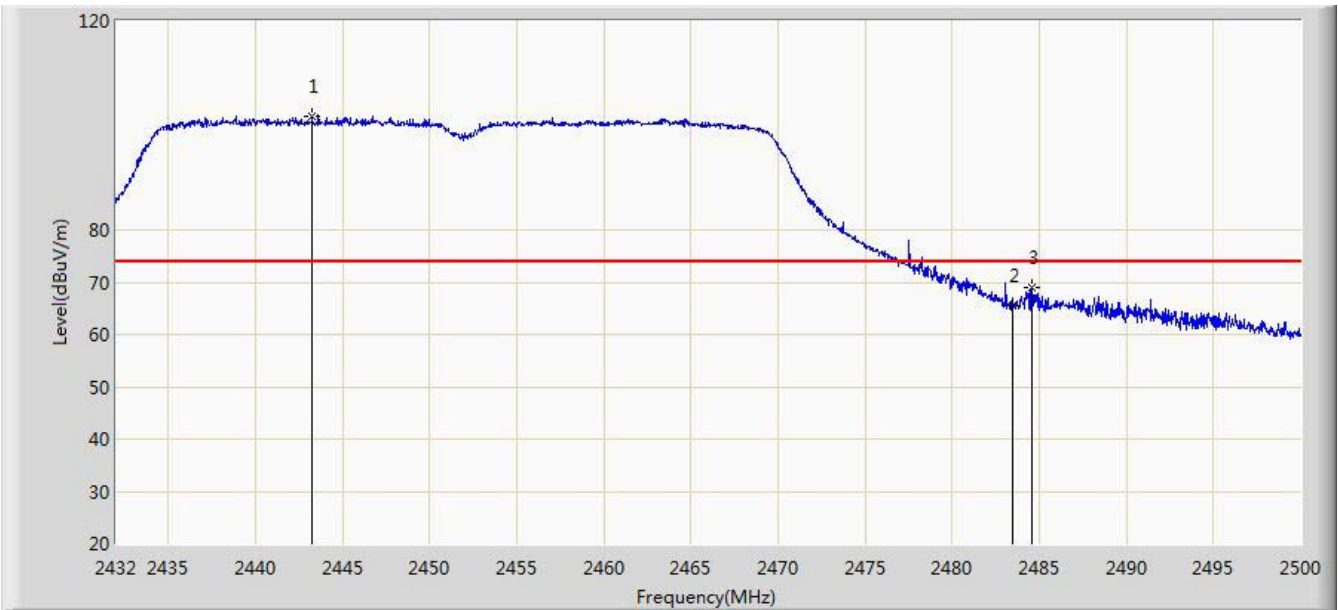

No	Mark	Frequency (MHz)	Measure Level (dBuV/m)	Reading Level (dBuV)	Over Limit (dB)	Limit (dBuV/m)	Factor (dB)	Type
1	*	2443.254	101.870	71.277	N/A	N/A	30.593	PK
2		2483.500	65.496	34.823	-8.504	74.000	30.673	PK
3		2484.564	68.871	38.195	-5.129	74.000	30.676	PK

Note: Measure Level (dBμV/m) = Reading Level (dBμV) + Factor (dB)

Factor (dB) = Cable Loss (dB) + Antenna Factor (dB/m).

Site: AC1	Time: 2014/10/29 - 21:01
Limit: FCC_Part15.209_RE(3m)	Engineer: Roy Cheng
Probe: BBHA9120D_1-18GHz	Polarity: Vertical
EUT: 2x2 dual band 802.11ac indoor AP	Power: AC 120V/60Hz
Test Mode: Transmit at channel 2452MHz by 802.11n40 Ant 0+1	

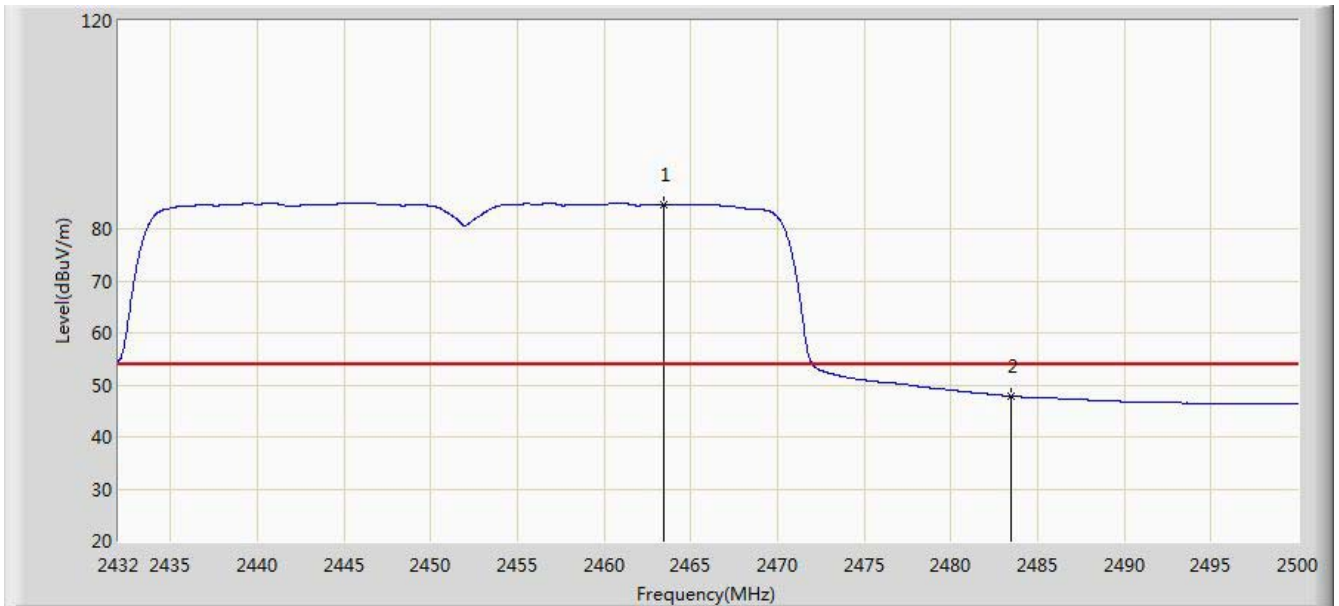

No	Mark	Frequency (MHz)	Measure Level (dBuV/m)	Reading Level (dBuV)	Over Limit (dB)	Limit (dBuV/m)	Factor (dB)	Type
1	*	2463.484	84.769	54.155	N/A	N/A	30.615	AV
2		2483.500	47.833	17.160	-6.167	54.000	30.673	AV

Note: Measure Level (dB $\mu$ V/m) = Reading Level (dB $\mu$ V) + Factor (dB)

Factor (dB) = Cable Loss (dB) + Antenna Factor (dB/m).



## 7.8. AC Conducted Emissions Measurement

### 7.8.1. Test Limit

FCC Part 15 Subpart C Paragraph 15.207 Limits		
Frequency (MHz)	QP (dBuV)	AV (dBuV)
0.15 - 0.50	66 - 56	56 - 46
0.50 - 5.0	56	46
5.0 - 30	60	50

Note 1: The lower limit shall apply at the transition frequencies.

Note 2: The limit decreases linearly with the logarithm of the frequency in the range 0.15MHz to 0.5MHz.

### 7.8.2. Test Setup

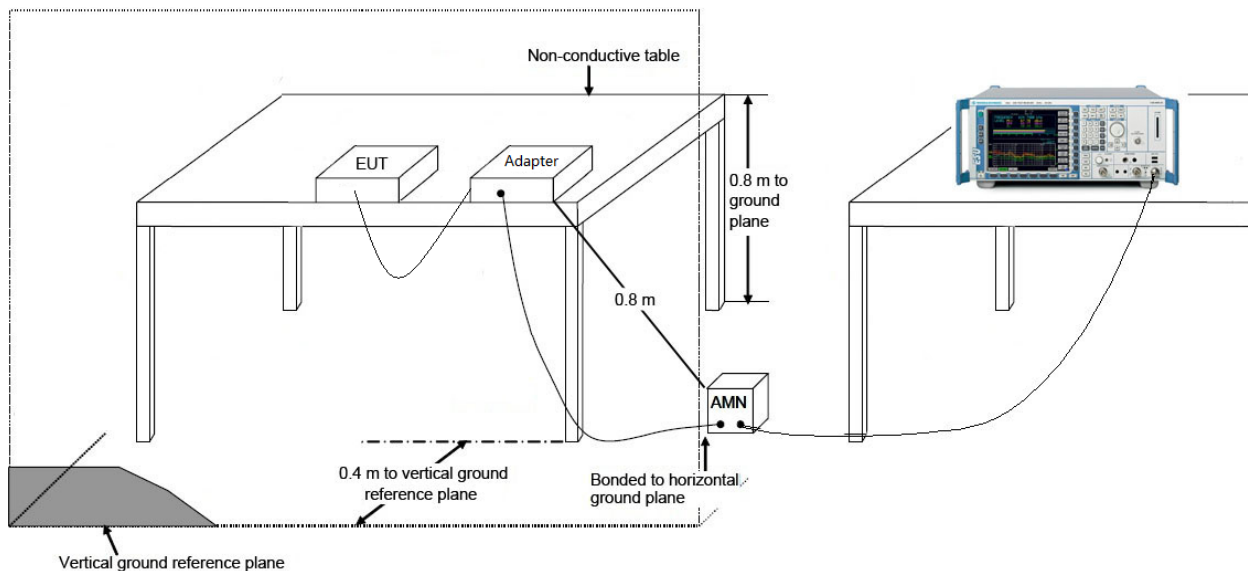

### 7.8.3. Test Result

Site: SR2	Time: 2014/11/21 - 18:38
Limit: FCC_Part15.207_CE_AC Power	Engineer: Milo Li
Probe: ENV216_101683_Filter On	Polarity: Line
EUT: 2x2 dual band 802.11ac indoor AP	Power: AC 120V/60Hz
Note: Normal Operation	

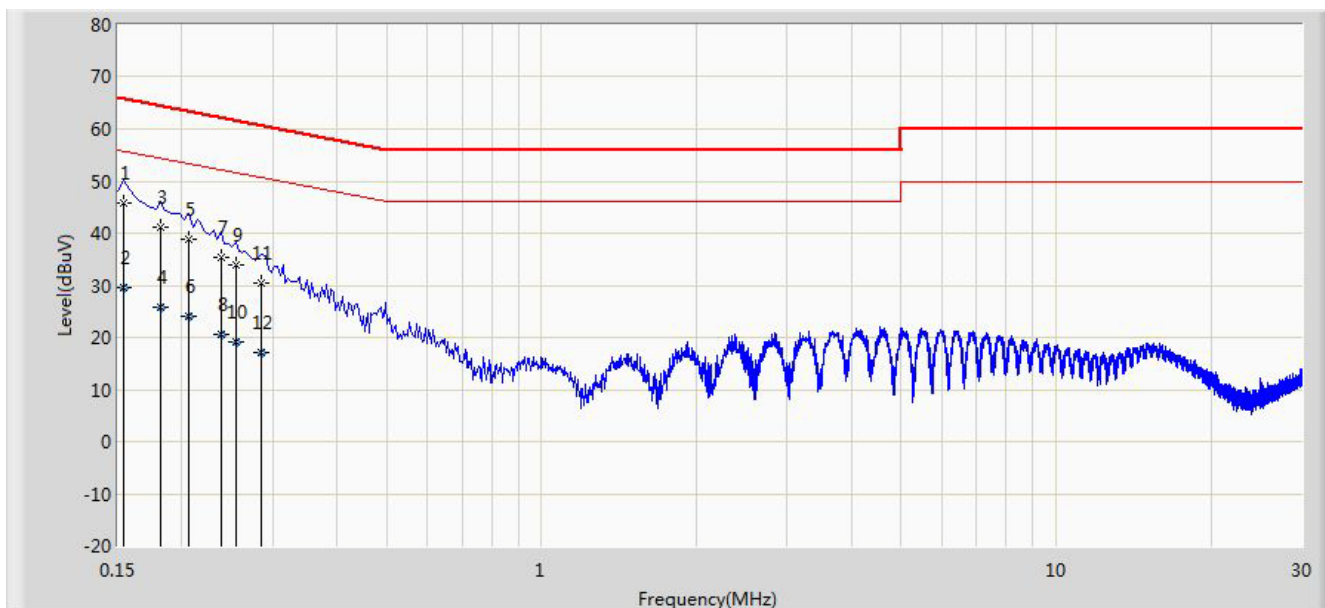

No	Flag	Mark	Frequency (MHz)	Measure Level (dBuV)	Reading Level (dBuV)	Over Limit (dB)	Limit (dBuV)	Factor (dB)	Type
1		*	0.154	45.832	35.092	-19.950	65.781	10.740	QP
2			0.154	29.509	18.770	-26.272	55.781	10.740	AV
3			0.182	41.179	31.130	-23.215	64.394	10.048	QP
4			0.182	25.860	15.811	-28.534	54.394	10.048	AV
5			0.206	38.807	28.826	-24.558	63.365	9.981	QP
6			0.206	23.956	13.975	-29.409	53.365	9.981	AV
7			0.238	35.394	25.439	-26.772	62.166	9.954	QP
8			0.238	20.435	10.481	-31.731	52.166	9.954	AV
9			0.254	33.880	23.913	-27.745	61.625	9.967	QP
10			0.254	19.203	9.236	-32.422	51.625	9.967	AV
11			0.286	30.521	20.529	-30.118	60.640	9.993	QP
12			0.286	17.034	7.041	-33.606	50.640	9.993	AV

Note: Measure Level (dBμV) = Reading Level (dBμV) + Factor (dB)

Factor (dB) = Cable Loss (dB) + LISN Factor (dB)

Site: SR2	Time: 2014/11/21 - 18:42
Limit: FCC_Part15.207_CE_AC Power	Engineer: Milo Li
Probe: ENV216_101683_Filter On	Polarity: Neutral
EUT: 2x2 dual band 802.11ac indoor AP	Power: AC 120V/60Hz
Note: Normal Operation	

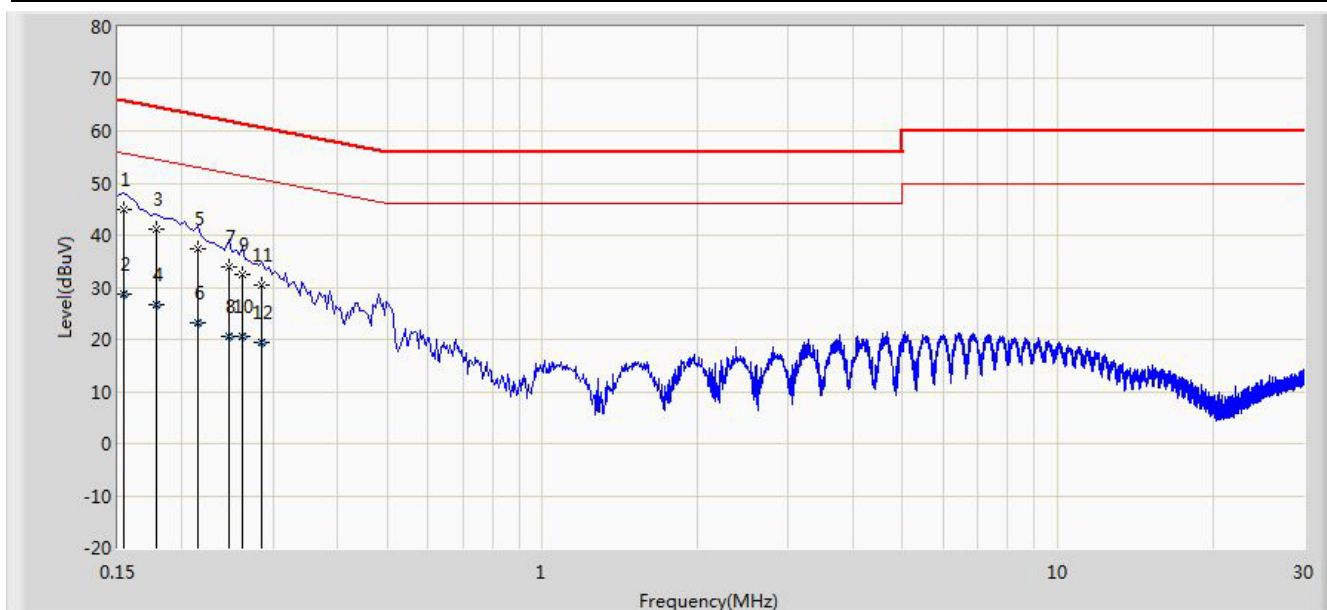

No	Flag	Mark	Frequency (MHz)	Measure Level (dBuV)	Reading Level (dBuV)	Over Limit (dB)	Limit (dBuV)	Factor (dB)	Type
1		*	0.154	45.034	34.318	-20.748	65.781	10.716	QP
2			0.154	28.836	18.120	-26.945	55.781	10.716	AV
3			0.178	41.187	31.137	-23.392	64.578	10.049	QP
4			0.178	26.725	16.675	-27.853	54.578	10.049	AV
5			0.214	37.248	27.260	-25.800	63.049	9.988	QP
6			0.214	23.138	13.150	-29.911	53.049	9.988	AV
7			0.246	33.948	23.950	-27.943	61.891	9.998	QP
8			0.246	20.559	10.561	-31.332	51.891	9.998	AV
9			0.262	32.431	22.421	-28.937	61.368	10.010	QP
10			0.262	20.595	10.585	-30.773	51.368	10.010	AV
11			0.286	30.319	20.291	-30.321	60.640	10.027	QP
12			0.286	19.306	9.279	-31.333	50.640	10.027	AV

Note: Measure Level (dBμV) = Reading Level (dBμV) + Factor (dB)

Factor (dB) = Cable Loss (dB) + LISN Factor (dB)

## 8. CONCLUSION

The data collected relate only the item(s) tested and show that the **2x2 dual band 802.11ac indoor AP FCC ID: SFK-WF180** is in compliance with Part 15C of the FCC Rules.

---

The End