



2009000597E

检测报告编号: 2010J10-30-106044

Test report series No.

SHANGHAI INSTITUTE OF MEASUREMENT AND TESTING TECHNOLOGY
NATIONAL CENTER OF MEASUREMENT AND TEST FOR EAST CHINA
NATIONAL CENTER OF TESTING TECHNOLOGY, SHANGHAI

TEST REPORT

上海市计量测试技术研究院
华东国家计量测试中心
中国上海测试中心

检测报告

委托者
Customer

SGS-CSTC Standards Technical Services (Shanghai) Co., Ltd.

委托者地址
Address of customer

No. 588 West Jindu Road, Songjiang District, Shanghai, China 201612

样品名称
Name of sample

CDMA & GSM dual mode phone

制造厂
Manufacturer

Hisense Communication Co., Ltd

型号/规格
Model/Specification

EG59

样品编号
No. of sample

1#

批准人 / 职务
Approved by / Functions

 主任

(机构检测专用章)

核 验 员
Checked by



检 测 员
Tested by



检测日期 2010 年 06 月 12 日
Date for test Year Month Day

投诉电话: 021-50798262

地址: 上海市张衡路 1500 号(总部)
Address No.1500 Zhangheng Road, Shanghai(headquarters)

电话: 021-38839800

传真: 021-50798390

邮编: 201203

Tel. For complaint

上海市宜山路 716 号(分部)
No. 716 Yishan Road, Shanghai(branch)

电话: 021-64701390

传真: 021-64701810

邮编: 200233

Post Code

未经本院批准, 部分采用本报告内容无效。
Partly using this report will not be admitted unless allowed by SIMT.

第 1 页 共 59 页
Page of total pages

国家法定计量检定机构计量授权证书号（中心/院）：（国）法计（2007）01039号/（2007）01019号
The number of the Certificate of Metrological Authorization to The Legal Metrological Verification Institution is No. (2007) 01039 / No. (2007) 01019

中国合格评定国家认可委员会实验室认可证书号：No. CNAS L0134
The number of the certificate accredited by CNAS is No.L0134

中国国家认证认可监督管理委员会资质认定计量认证证书（CMA）号：2009000597E
The number of the metrology accreditation certificate by CNCA is No. 2009000597E

本次检测所依据的技术规范（代号、名称）：
Reference documents for the test (code、name)

IEEE 1528: 2003 IEEE Recommended Practice for Determining the Peak Spatial-Average Specific Absorption Rate (SAR) in the Human Head from Wireless Communications Devices: Measurement Techniques
FCC OET Bulletin 65 Supplement C: 2001 Evaluating Compliance with FCC Guidelines for Human Exposure to Radiofrequency Electromagnetic Fields

本次检测所使用的主要测量仪器：
Main measuring instruments used in this test

Refer to Attachment 1

检测地点及环境条件：
Location and environmental condition for the test

地点： No. 716 Yishan Road
Location

温度： (21.1-21.6) °C； 湿度： (62-64) %RH； 其它： /
Ambient temperature Relative humidity Others

检测结果/说明：
Results of test and additional explanation

The testing results are in compliance with IEEE 1528: 2003, FCC OET Bulletin 65 Supplement C: 2001 (see the continued pages)
(Test date: 2010.06.09-2010.06.12)

本报告提供的结果仅对本次被测的样品有效。
The data are valid only for the sample(s).

检测结果/说明 (续页):

Results of test and additional explanation (continued page)

1. Specific Absorption Rate Test

1.1 EUT Description

Product Name	CDMA & GSM dual mode phone
Model No.	EG59
FCC ID	SARHISENSEEG59
Antenna Type	Soldered on PCB
GPRS Class	/
GPRS Timeslots of Test	/
Modulation Mode	OQPSK
Tx Frequency range	824.70 MHz~848.31 MHz
Rx Frequency range	869.00MHz~894.00MHz
Maximum RF Conducted Power	CDMA 800: 28.98 dBm

1.2 Test Environment during SAR test

Temperature	Min. =19°C, Max. =23°C
Relative humidity	Min. =30%, Max. =70%
Ground system resistance	<0.5Ω
Ambient noise is checked and found very low and in compliance with requirement of standards. Reflection of surrounding objects is minimized and in compliance with requirement of standards.	

检测结果/说明（续页）：

Results of test and additional explanation (continued page)

1.3 Tissue Simulating Liquid

1.3.1 The composition of the tissue simulating liquid

The parameters of the simulating solution strongly influence the SAR values. The different normalization organizations have defined adapted solutions for the each mobile system.

GSM liquid	is made of 1-2 Propylene Glycol, de-ionized water and NaCl, reconstituting the electric properties of human tissues at 850 MHz/900 MHz;
DCS/PCS Liquid	is made of de-ionized water, DGBE, Triton X 100 and NaCl, reconstituting the electric properties of human tissues at 1800 MHz/1900 MHz;
UMTS Liquid	is made of de-ionized water, DGBE, Triton X 100 and NaCl, reconstituting the electric properties of human tissues at 2000 MHz;
Bluetooth Liquid	is made of de-ionized water, DGBE, Triton X 100 and NaCl, reconstituting the electric properties of human tissues at 2450 MHz;

1.3.2 Tissue Calibration Result

The dielectric parameters of the liquids were verified prior to the SAR evaluation using the Calibration Kits and R&S® ZVB8 Vector Network Analyzers.

Head Tissue simulating Measurement				
Frequency [MHz]	Description	Dielectric Parameters		Tissue Temp.(°C)
		ϵ_r	σ (S/m)	
836 MHz	Reference result +/-5%	41.50	0.90	N/A
	2010-06-09	41.67	0.94	21.3

Body Tissue simulating Measurement				
Frequency [MHz]	Description	Dielectric Parameters		Tissue Temp.(°C)
		ϵ_r	σ (S/m)	
836 MHz	Reference result +/-5%	55.20	0.97	N/A
	2010-06-09	55.59	1.01	21.2

检测结果/说明 (续页):

Results of test and additional explanation (continued page)

1.4 SAR Measurement System

This SAR Measurement System uses a Computer-controlled 3-D stepper motor system (SAR Handset Assessment Systems from Antennessa). An E-field probe is used to determine the internal electric fields. The SAR can be obtained from the equation $SAR = \sigma (|E_i|^2) / \rho$ where σ and ρ are the conductivity and mass density of the tissue simulating liquid.

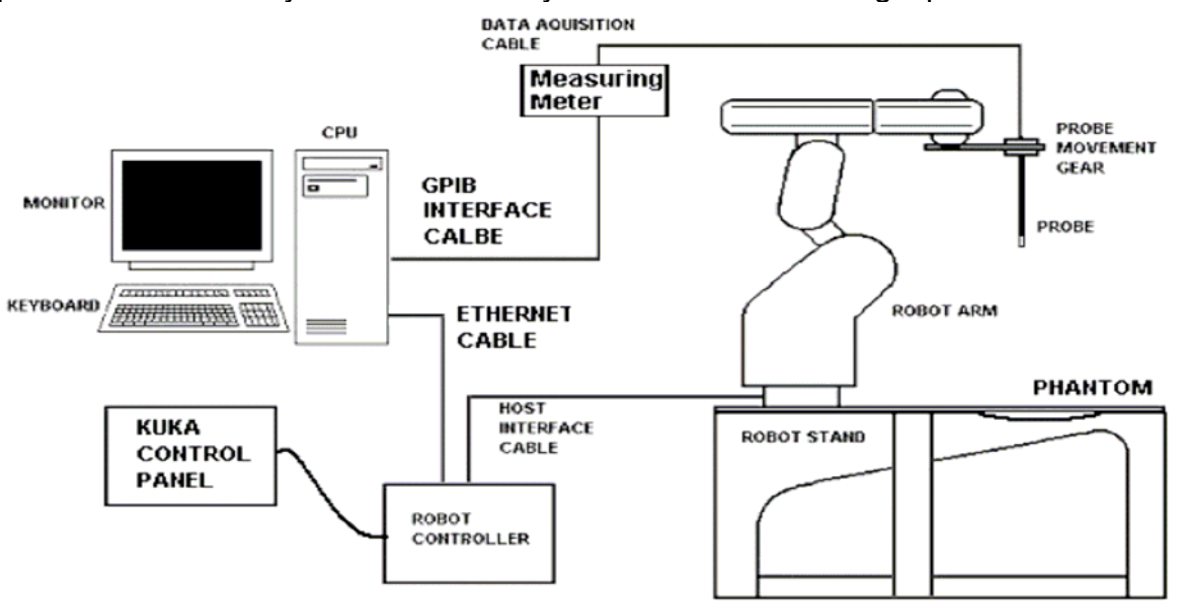

During SAR test, EUT is in Traffic Mode (Channel Allocated) at Normal Voltage Condition. A communication link is set up with a System Simulator (SS) by air link, and a call is established. The TCH is allocated to 975, 38 and 124 respectively in the case of GSM 900 MHz, or to 512, 698 and 885 respectively in the case of DCS 1800 MHz. The EUT is commanded to operate at maximum transmitting power. The EUT shall use its internal transmitter. The antenna(s), battery and accessories shall be those specified by the manufacturer. The EUT battery must be fully charged and checked periodically during the test to ascertain uniform power output. If a wireless link is used, the antenna connected to the output of the base station simulator shall be placed at least 50 cm away from the handset. The signal transmitted by the simulator to the antenna feeding point shall be lower than the output power level of the handset by at least 35 dB.

检测结果/说明（续页）：

Results of test and additional explanation (continued page)

1.4.1 SAM phantom



Figure 1: SAM phantom

The SAM phantom (Antennessa SN: SN_36_05_SAM25) is used to measure the SAR relative to persons exposure to electro-magnetic field radiated by mobile phones. For thickness control purpose, the phantom has several integrated thickness control points (see crosses on the picture below)

Shell thickness	2 mm+/-0.2 mm
Filling volume	27 liters
Dimensions	1000 mm (length), 500mm (width), 200 mm (height)
5 molded plastic points for high precision reference Delivered with 4 nylon screws	
EN 62209-1 or IEEE 1528-200X versions	

检测结果/说明（续页）：

Results of test and additional explanation (continued page)

1.4.2 Probe Specification

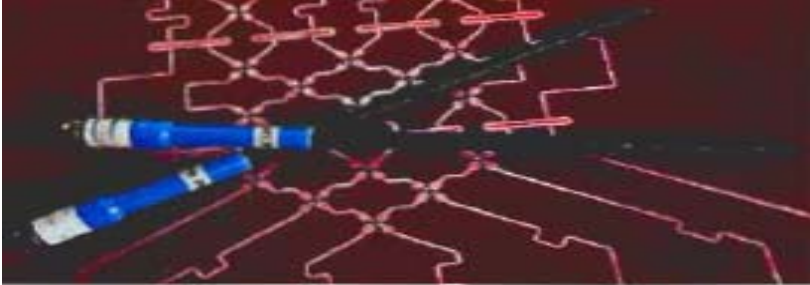

Figure 2: Antenna probe

E-field probes are constructed with a triangular section bar in alumina. On each face, a dipole and a resistive line are printed. A Schottky diode is placed in the center of each dipole. This probe is designed to fulfill CENELEC and IEEE recommendations for the measurement of electromagnetic fields radiated by mobile phones and base stations. The E-field detection probe is composed of three orthogonal dipoles linked to special Schottky diodes with low detection thresholds. The probe allows the measurement of electric fields in liquids such as the one defined in the IEEE and CENELEC standard. These uncoupled dipoles perform the isotropic and wide-band measurements necessary to assess mobile phones SAR. Figure 3 shows E-field probe relevant features.

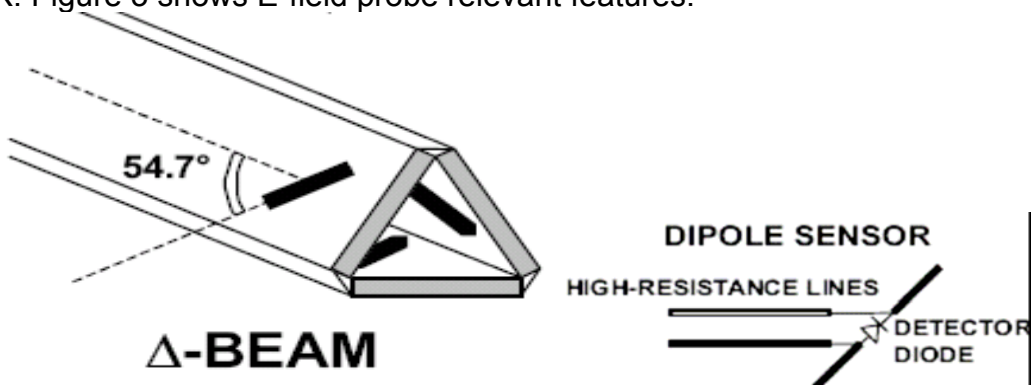

Figure 3: Typical E-field probe construction

The characteristics of the probes	
Frequency range	100 MHz-30 GHz
Maximum external diameter	8 mm
Probe tip external diameter	5 mm
Distance between dipoles and the probe tip	<2.7 mm
Dipole resistance(in the connector plane)	1 M to 2 M
Axial isotropy in human-equivalent liquids	+/-0.25 dB
Hemispherical Isotropy in human-equivalent liquids	+/-0.5 dB
Linearity	+/-0.5 dB
Maximum operating SAR	100 Watts/Kg
Low SAR detection threshold	0.0015 Watts/Kg
Connectors	6 male wires (Hirose SR30)

检测结果/说明（续页）：

Results of test and additional explanation (continued page)

1.4.3 Axis Articulated Robot



This KR3 robot is used in the SAR testing which provides a powerful combination of high-speed flexible automation, high reliability and ease of use. This is due to its brushless DC servomotors, absolute encoders and high-stiffness harmonic drives, which make it one of the fastest and most durable robots in its class.

Figure 4:KR3 robot

Robot/Controller Manufacture	KUKA
Number of axis	6
Position Repeatability	+/- 0.05 mm
Controller	KR C3
Work envelope volume	0.679 m3
Communication	LAN

检测结果/说明 (续页):

Results of test and additional explanation (continued page)

1.4.4 Device and Dipole Holder

The SAR value is approximately inversely proportional to the square of the distance between the source and the internal phantom surface. For a source at 5 mm distance, a positioning uncertainty of +/-0.5 mm would produce a SAR uncertainty of +/-20%. An accurate device positioning is therefore essential for accurate and repeatable measurements

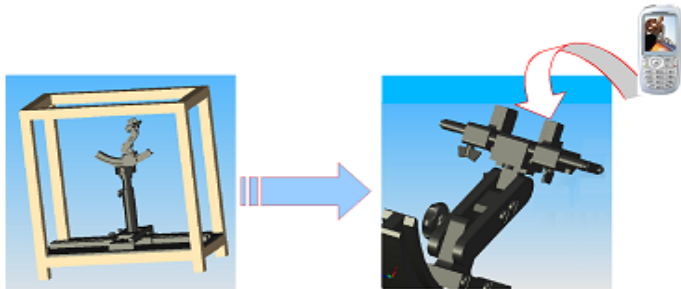

Figure 5: device holder

	<p>Totally metal-free design</p> <p>Rotation point on ear opening</p> <p>Translation to lock the device under test under the flat part or under the left or right ear</p> <p>High repeatability with rotation point external adjustment</p> <p>Easy and accurate position according to all standards</p> <p>Compliance with mobile phone, PMR or PDA dimensions</p>
--	---

This positioning system allows the translation of the mobile phone along the X, Y and Z axis, as well as the required rotation around the phantom ear, for the 2 positions defined by standards (0° “cheek” position and 15° “tilt” position).

检测结果/说明（续页）：

Results of test and additional explanation (continued page)

1.4.5 Dipoles

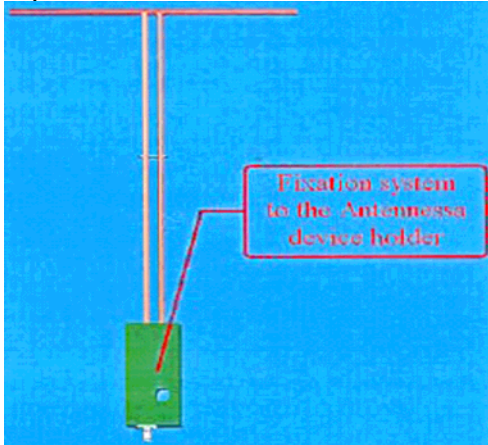

Figure 6:validation dipole

The antennas are developed with a $\lambda/4$ balun, so that all calibration dipoles are totally symmetrical. Each validation dipole is used to check the whole SAR measurement chain in its frequency band. They are especially developed to make SAR measurements near a flat SAM phantom filled with human-equivalent liquid, according to CENELEC and IEEE standards.

Frequencies	Antenna has a full range of dipoles corresponding to the frequencies defines by standards: 835,900,1800,1900,2450,3000MHz,etc.	
Adaptation	S11<-20dB in specified validation position	
Maximum input Power	100W	
Connectors	SMA	
Dimensions	Height: between 200 mm and 300 mm Length: between 25 mm and 83 mm	}depends on the dipole frequency

检测结果/说明（续页）：

Results of test and additional explanation (continued page)

1.5 SAR Measurement Procedure

1.5.1 General Requirements

The test shall be performed in a laboratory with an environment which avoids influence on SAR measurements by ambient EM sources and reflection from the environment itself. The ambient temperature shall be in the range of 18°C to 25°C during the test

1.5.2 SAR System Validation

Prior to assessment, the system is verified to the ±10% of the specifications. The SAR value is measured with the dipole which is mounted with the spacer to position its feed point exactly below the center marking of the flat phantom section, with the arms oriented parallel to the body axis, The standard measuring distance was 15mm (below 1GHz) and 10mm (above 1GHz) from dipole center to the simulating liquid surface. During measurement, 1W antenna input power is required and the flat phantom is filled the liquid whose parameters are calibrated relative to different frequency.

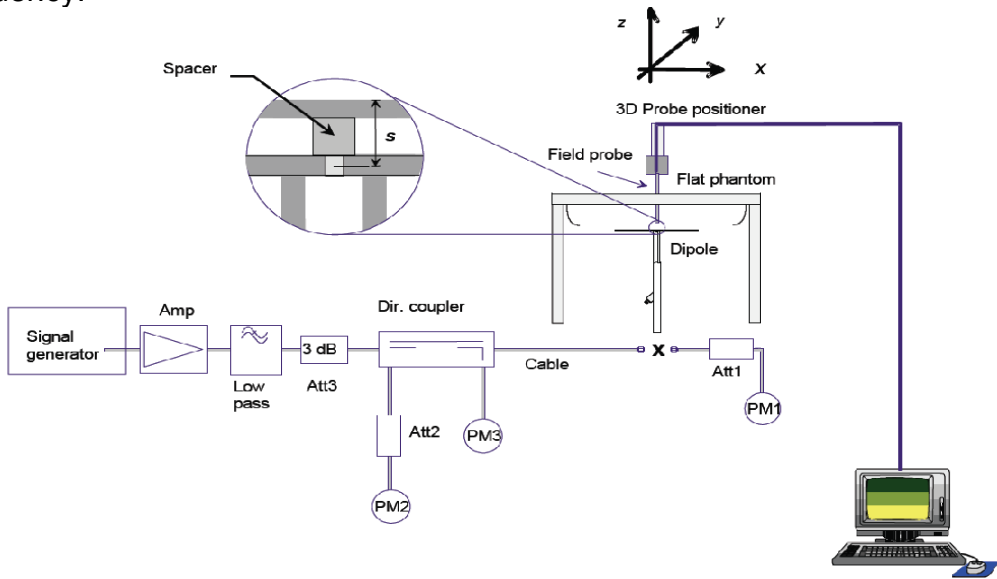

SAR System Validation setup

System Validation result:

Frequency	Liquid	Date	Target value (W/kg)		Test value (W/kg)	
			1g	10g	1g	10g
836 MHz	Head	2010.06.09	9.62	6.34	9.34	6.30
836 MHz	Body	2010.06.09	9.89	6.58	9.69	6.61

检测结果/说明 (续页):

Results of test and additional explanation (continued page)

1.5.3 Test Positions

As it cannot be expected that the user will hold the mobile phone exactly in one well defined position, different operational conditions shall be tested. The IEEE standard requires two test positions. For an exact description helpful geometrical definitions are introduced and shown in Fig. 7-8.

There are two imaginary lines on the mobile, the vertical centerline and the horizontal line. The vertical centerline passes through two points on the front side of the handset: the midpoint of the width w_t of the handset at the level of the acoustic output (point A on Fig.7), and the midpoint of the width w_b of the bottom of the handset (point B). The horizontal line is perpendicular to the vertical centerline and passes through the center of the acoustic output (see Fig.7). The two lines intersect at point A.

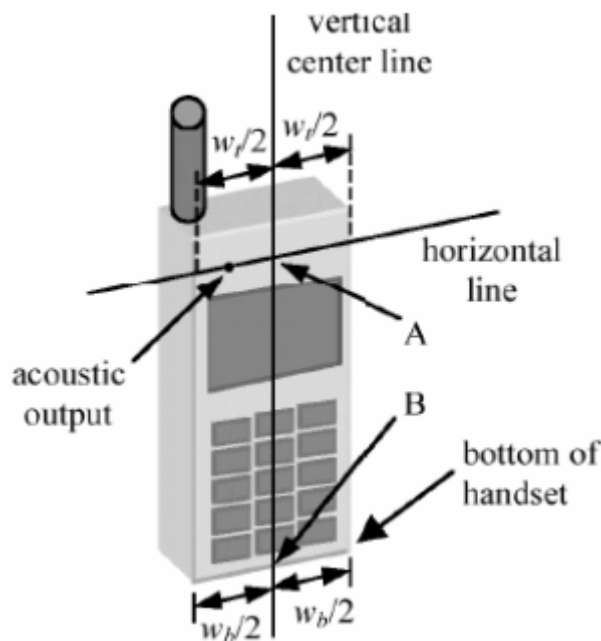

Figure 7: Handset vertical and horizontal reference lines

According to Fig.8 the human head position is given by means of the following three reference points: auditory canal opening of both ears (RE and LE) and the center of the closed mouth (M). The ear reference points are 15-17mm above the entrance to the ear canal along the BM line (back-mouth), as shown in Fig.8. The plane passing through the two ear canals and M is defined as the reference plane. The line NF (Neck-Front) perpendicular to the reference plane and passing through the RE (or LE) is called the reference pivoting line. Line BM is perpendicular to the NF line. With this definitions the test positions are given by

检测结果/说明 (续页):

Results of test and additional explanation (continued page)

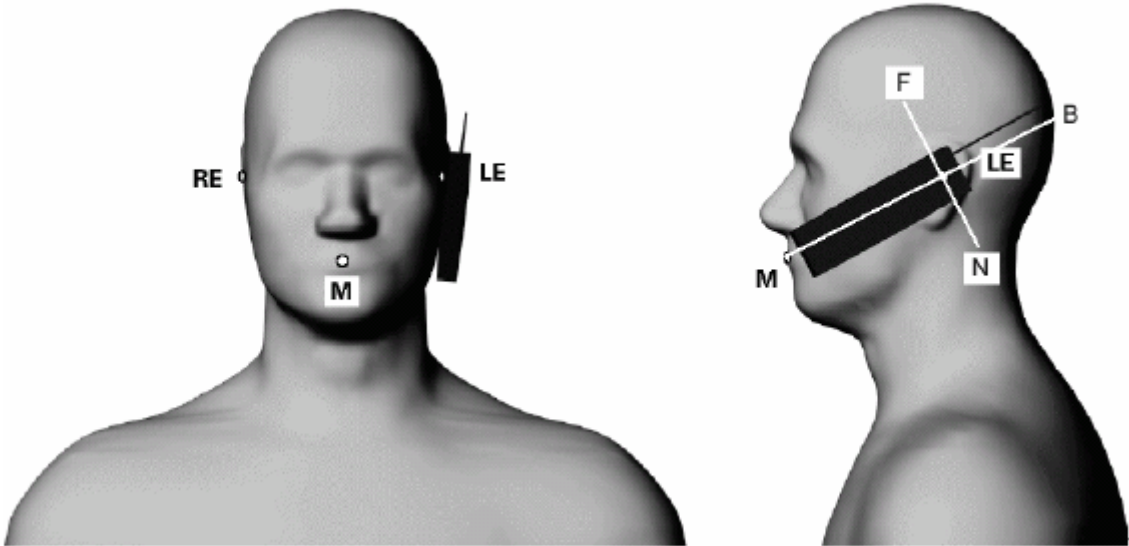

Figure 8: Phantom reference points

1.5.3.1 Cheek Position

Position the handset close to the surface of the phantom such that point A is on the (virtual) extension of the line passing through points RE and LE on the phantom (see Fig.8). such that the plane defined by the vertical center line and the horizontal line of the phone is approximately parallel to the sagittal plane of the phantom. Translate the handset towards the phantom along the line passing through RE and LE until the handset touches the ear. While maintaining the handset in this plane, rotate it around the LE-RE line until the vertical centerline is in the plane normal to MB-NF including the line MB (called the reference plane). Rotate the phone around the vertical centerline until the phone (horizontal line) is symmetrical with respect to the line NF. While maintaining the vertical centerline in the reference plane, keeping point A on the line passing through RE and LE, and maintaining the phone contact with the ear, rotate the handset about the line NF until any point on the handset is in contact with a phantom point below the ear.

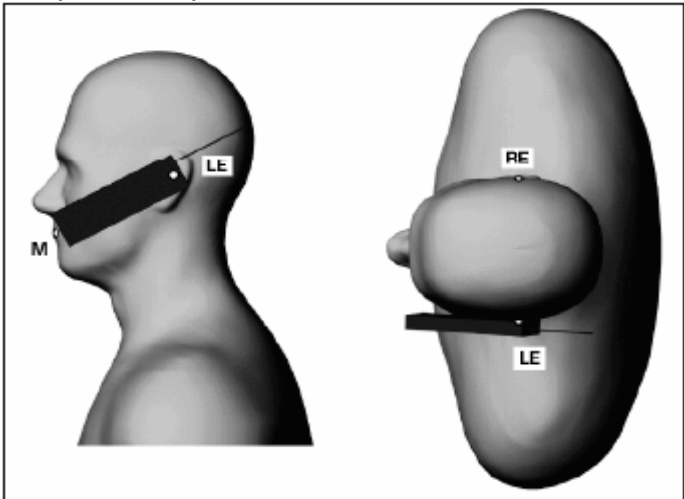

Figure 9: The cheek position

检测结果/说明（续页）：

Results of test and additional explanation (continued page)

1.5.3.2 Tilted Position

While maintaining the orientation of the phone retract the phone parallel to the reference plane far enough to enable a rotation of the phone by 15°. Rotate the phone around the horizontal line by 15°. While maintaining the orientation of the phone, move the phone parallel to the reference plane until any part of the phone touches the head. In the position, point A will be located on the line RE-LE.

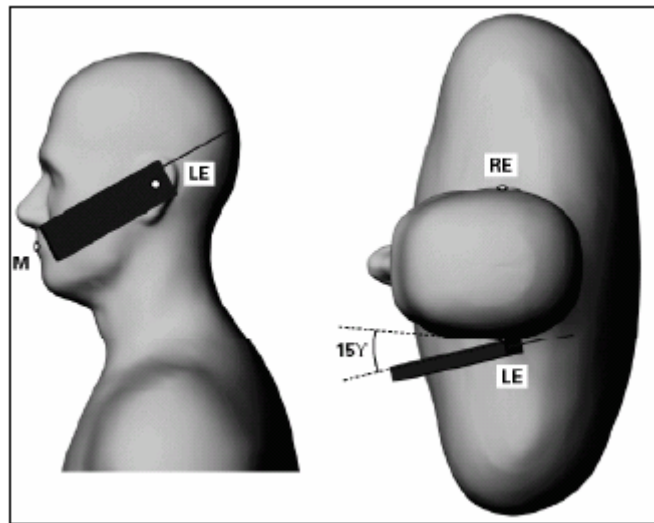

Figure10: The tilted position

1.5.3.3 Body-Worn and Other Configurations

Body-worn operating configurations should be tested with the belt-clips and holsters attached to the device and positioned against a flat phantom in normal use configurations in FCC OET 65.A separation distance of 1.5 cm between the back of the device and a flat phantom is recommended for testing body-worn SAR compliance under such circumstances. Other separation distance may be use, but not exceed 2.5 cm.

检测结果/说明（续页）：

Results of test and additional explanation (continued page)

1.5.4 Test to be Performed

1.5.4.1 Operation mode

The device shall be measured for all modes operating when the device is next to the ear, even if the different modes operate in the same frequency band. First the SAR test shall be performed using the center frequency of each available operating band and mode with the maximum peak power level. At the device position with highest SAR (cheek or tilted, left or right), the test is repeated at the lowest and highest frequency. In addition, for all other device positions respectively configurations where the spatial peak SAR value is within 3dB of the SAR limit, the lowest and highest frequencies should be tested.

1.5.4.2 Test configuration

The SAR test shall be performed with both phone positions described above, on the left and right side of the phantom or positioned against a flat phantom. For devices with retractable antenna all of the tests described above shall be performed with the antenna fully extended and fully retracted. Other factors that may affect the exposure should also be tested. For example, optional antennas or optional battery packs which may significantly change the volume, lengths, flip open/closed, etc. of the device, or any other accessories which might have the potential to considerably increase the peak spatial-average SAR value.

1.5.4.3 SAR Measurement Conditions for CDMA2000 1x

These procedures were followed according to FCC "SAR Measurement Procedures for 3G Devices", May 2006.

1.5.4.3.1 Output Power Verification

See 3GPP2 C.S0011/TIA-98-E as recommended by "SAR Measurement Procedures for 3G Devices", May 2006. Maximum output power is verified on the High, Middle and Low channels according to procedures defined in section 4.4.5.2 of 3GPP2 C.S0011/TIA-98-E.

1. If the mobile station supports Reverse TCH RC 1 and Forward TCH RC 1, set up a call using Fundamental Channel Test Mode 1 with 9600 bps data rate only.
2. If the mobile station supports Reverse FCH RC3 and demodulation of Radio Configuration 3, 4, or 5, set up a call using Fundamental Channel Test Mode 3 with 9600 bps data rate only.
3. The power should be measured using SO55 with power control bits in "All Up" condition.

检测结果/说明（续页）：

Results of test and additional explanation (continued page)

C.S0011 Table 4.4.5.2-1 parameters were applied.

Parameter	Units	Value
\hat{I}_{or}	dBm/1.23 MHz	-104
$\frac{\text{Pilot } E_c}{I_{or}}$	dB	-7
$\frac{\text{Traffic } E_c}{I_{or}}$	dB	-7.4

- If the MS supports the RC 3 Reverse FCH, RC3 Reverse SCH0 and demodulation of RC 3, 4, or 5, set up a call using Supplemental Channel Test Mode 3 (RC 3/3) with 9600 bps Fundamental Channel and 9600 bps SCH0 data rate Channel and 9600 bps SCH0 data rate.
- Power should be measured using TDSO / SO32 with power control bits in the “Bits Hold” condition (i.e. alternative Up/Down Bits), C.S0011 Table 4.4.5.2-2 was applied.

Parameter	Units	Value
\hat{I}_{or}	dBm/1.23 MHz	-86
$\frac{\text{Pilot } E_c}{I_{or}}$	dB	-7
$\frac{\text{Traffic } E_c}{I_{or}}$	dB	-7.4

1.5.4.3.2 Head SAR Measurement

SAR for head exposure configurations is measured in RC3 with the DUT configured to transmit at full rate using Loopback Service Option SO55. SAR for RC1 is not required when the maximum average output of each channel is less than ¼ dB higher than that measured in RC3. Otherwise, SAR is measured on the maximum output channel in RC1 using the exposure configuration that results in the highest SAR for that channel in RC3.

1.5.4.3.3 Body SAR Measurement

SAR for body exposure configurations is measured in RC3 with the DUT configured to transmit at full rate on FCH with all other code channels disabled using TDSO / SO32. SAR for multiple code channels (FCH + SCHn) is not required when the maximum average output of each RF channel is less than ¼ dB higher than that measured with FCH only. Otherwise, SAR is measured on the maximum output channel (FCH + SCHn) with FCH at full rate and SCH0 enabled at 9600 bps using the exposure configuration that results in the highest SAR for that channel with FCH only. When multiple code channels are enabled, the DUT output may shift by more than 0.5 dB and lead to higher SAR drifts and SCH dropouts. Body SAR in RC1 is not required when the maximum average output of each channel is less

检测结果/说明（续页）：

Results of test and additional explanation (continued page)

than ¼ dB higher than that measured in RC3. Otherwise, SAR is measured on the maximum output channel in RC1; with Loopback Service Option SO55, at full rate, using the body exposure configuration that results in the highest SAR for that channel in RC3.

1.5.4.4 The following steps are used for each test position

Establish a call with the maximum output power with a base station simulator. The connection between the mobile phone and the base station simulator is established via air interface.

Measurement of the local E-field distribution is done with a grid of 8 mm*8mm and a constant distance 4mm to the inner surface of the phantom. Since the sensors cannot directly measure at the inner phantom surface, the values between the sensors and the inner phantom surface are extrapolated. With these values the area of the maximum SAR is calculated by an interpolating scheme.

Around this point, a cube of 30*30*30mm or 32*32*30mm is assessed by measuring 5*5*5mm or 8*8*5 mm. With these data, the peak spatial-average SAR value can be calculated.

检测结果/说明（续页）：

Results of test and additional explanation (continued page)

1.5.5 Description of Interpolation/Extrapolation Scheme

The local SAR inside the phantom is measured using small dipole sensing elements inside a probe body. The probe tip must not be in contact with the phantom surface in order to minimize measurements errors, but the highest local SAR will occur at the surface of the phantom.

An extrapolation is using to determinate this highest local SAR values. The extrapolation is base on a fourth-order least square polynomial fit of measured data. The local SAR value is then extrapolated from the liquid surface with a 1mm step.

The measurements have to be performed over a limited (due to the duration of the battery) so the step of measurement is high. It could vary between 5 and 8mm. to obtain an accurate assessment of the maximum SAR averaged over 10 grams and 1gram requires a very fine resolution in the three-dimensional scanned data array.

1.5.6 SAR Exposure Limits

SAR assessments have been made in line with the requirements of IEEE-1528, FCC Supplement C, and comply with ANSI/IEEE C95.1-1992 “Uncontrolled Environments” limits. These limits apply to a location which is deemed as “Uncontrolled Environments” which can be described as a situation where the general public may be exposed to an RF source with no prior knowledge or control over their exposure.

Type Exposure	Uncontrolled Environment Limit
Spatial Peak SAR (1g cube tissue for brain or body)	1.6W/Kg (U.S.A)
Spatial Peak SAR (10g cube tissue for brain or body)	2.0 W/Kg (EURO)

检测结果/说明（续页）：

Results of test and additional explanation (continued page)

1.6 Summary of Measurement Results

Peak Spatial-Average Specific Absorption Rate (SAR) of this portable wireless device has been measured in all configurations.

Table 1: SAR Values (CDMA 800), Measured against the head (Duty Cycle: 1:1).

Temperature: 21.1~21.6°C, Relative Humidity: 62~64%.		
Limit of SAR (W/kg)	1 g Average	
	1.6	
Test Configuration	SAR (W/kg)	Before/after Power (dBm)
Right head, Touch cheek, Low Channel	/	/
Right head, Touch cheek, Middle Channel	85.16×10^{-2}	28.60/28.65
Right head, Touch cheek, High Channel	/	/
Right head, Tilt 15, Low Channel	/	/
Right head, Tilt 15, Middle Channel	56.75×10^{-2}	28.64/28.63
Right head, Tilt 15, High Channel	/	/
Left head, Touch cheek, Low Channel	97.60×10^{-2}	28.85/28.89
Left head, Touch cheek, Middle Channel	95.23×10^{-2}	28.64/28.69
Left head, Touch cheek, High Channel	75.14×10^{-2}	28.90/28.96
Left head, Tilt 15, Low Channel	/	/
Left head, Tilt 15, Middle Channel	63.38×10^{-2}	28.65/28.70
Left head, Tilt 15, High Channel	/	/
Body, Low Channel (back face to phantom)	66.71×10^{-2}	28.85/28.86
Body, Middle Channel (back face to phantom)	65.16×10^{-2}	28.64/28.68
Body, Middle Channel (back face to phantom with headset)	57.69×10^{-2}	28.67/28.66
Body, Middle Channel (front face to phantom)	38.52×10^{-2}	28.63/28.64
Body, Middle Channel (front face to phantom with headset)	36.09×10^{-2}	28.65/28.67
Body, High Channel (back face to phantom)	40.99×10^{-2}	28.96/28.94

检测结果/说明（续页）：

Results of test and additional explanation (continued page)

1.7 Test Results

1.7.1 Right Head

1.7.1.1 Cheek, Middle channel (Channel 384)

Experimental conditions	
Phantom	Right head
Device Position	Cheek
Band	CDMA 800
Channels	Middle
Signal	CDMA
before/after Power Level:	28.60dBm /28.65dBm
Liquid Temperature:	21.3°C
Duty Cycle:	1:1
Test Date	2010.06.09
Frequency (MHz)	836.520020
Relative permittivity (real part)	41.671001
Relative permittivity (imaginary part)	20.227200
Conductivity (S/m)	0.940025
Variation (%)	0.280000

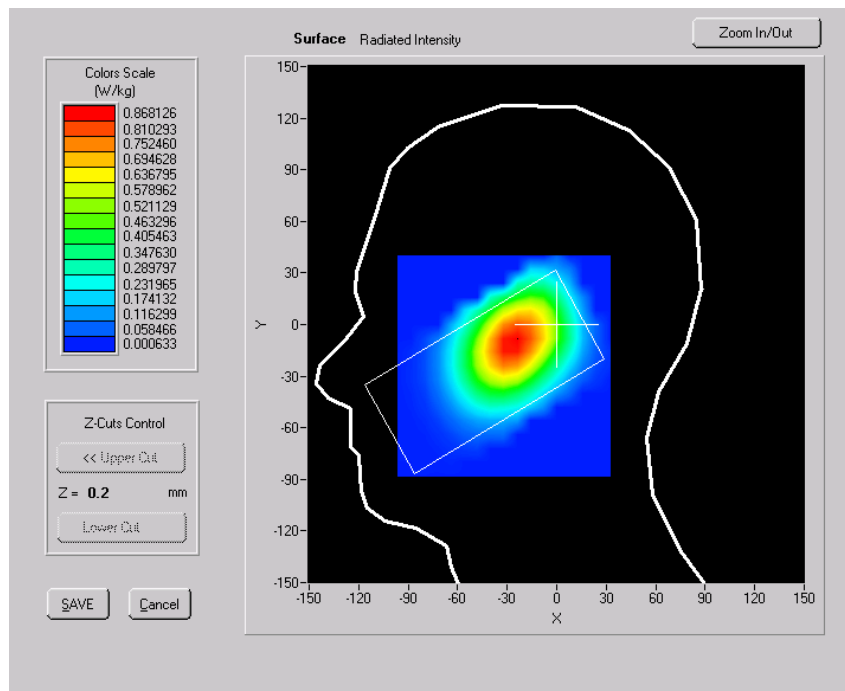

SURFACE SAR

检测结果/说明 (续页):

Results of test and additional explanation (continued page)

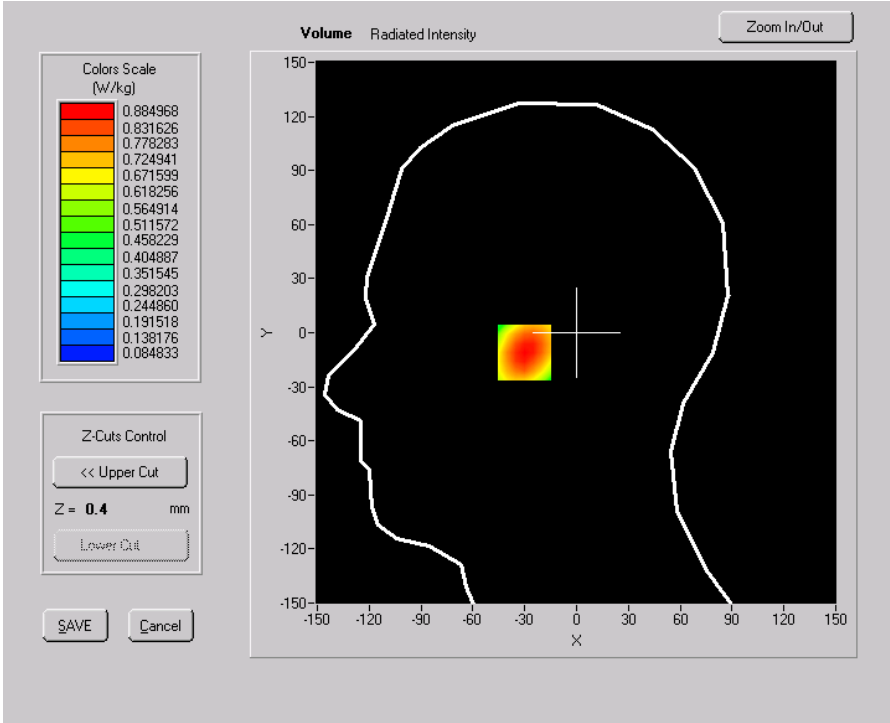

VOLUME SAR

Maximum location: X=-27.00, Y=-11.00

SAR 10g (W/Kg)	0.598709
SAR 1g (W/Kg)	0.851591

SAR, Z Axis Scan (X = -27, Y = -11)

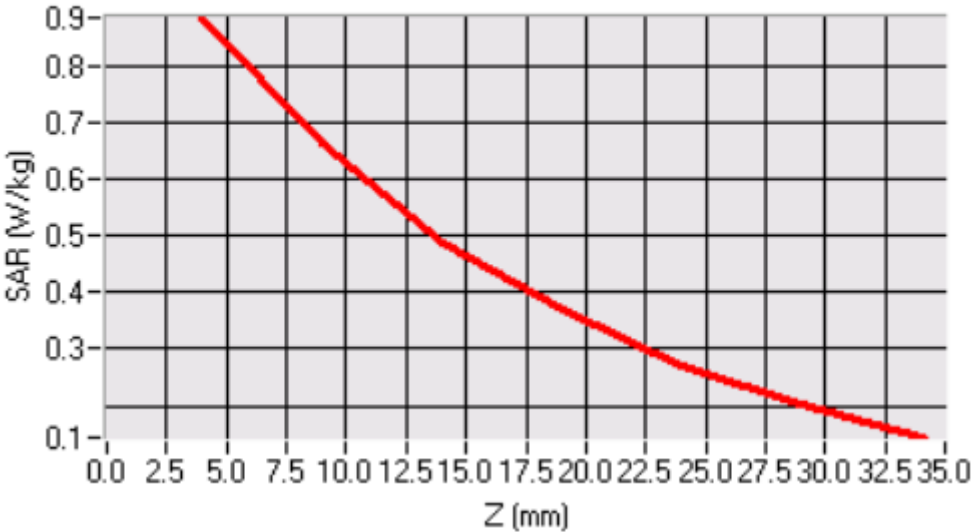

检测结果/说明 (续页):

Results of test and additional explanation (continued page)

1.7.1.2 Tilt, Middle channel (Channel 384)

Experimental conditions	
Phantom	Right head
Device Position	Tilt
Band	CDMA 800
Channels	Middle
Signal	CDMA
before/after Power Level:	28.64 dBm/28.63 dBm
Liquid Temperature:	21.3°C
Duty Cycle:	1:1
Test Date	2010.06.09

Frequency (MHz)	836.520020
Relative permittivity (real part)	41.671001
Relative permittivity (imaginary part)	20.227200
Conductivity (S/m)	0.940025
Variation (%)	0.520000

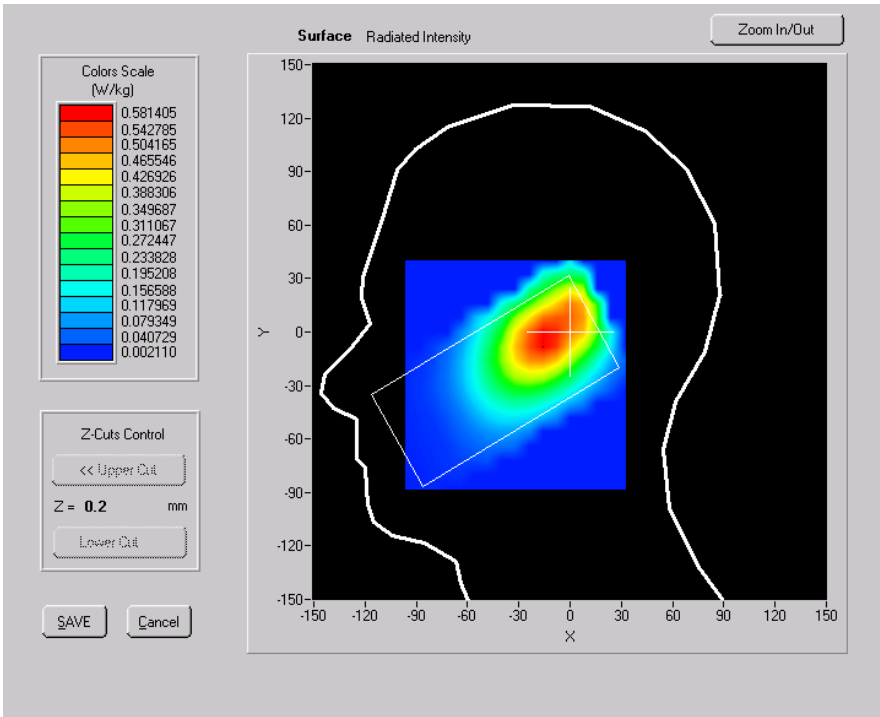

SURFACE SAR

检测结果/说明 (续页):

Results of test and additional explanation (continued page)

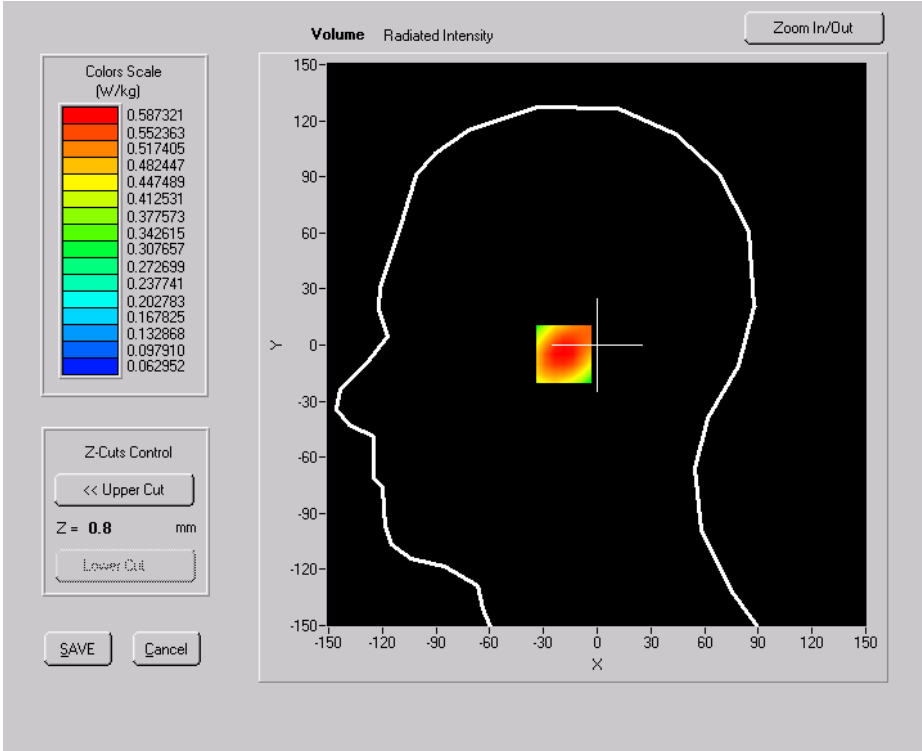

VOLUME SAR

Maximum location: X=-15.00, Y=-5.00

SAR 10g (W/Kg)	0.403442
SAR 1g (W/Kg)	0.567541

SAR, Z Axis Scan (X = -15, Y = -5)

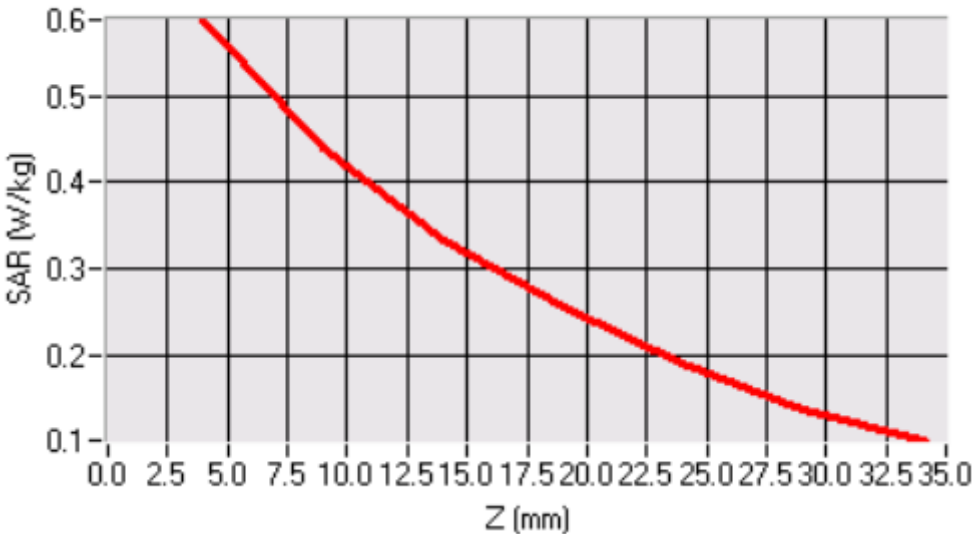

检测结果/说明（续页）：

Results of test and additional explanation (continued page)

1.7.2 Left Head

1.7.2.1 Cheek, Low channel (Channel 1013)

Experimental conditions	
Phantom	Left head
Device Position	Cheek
Band	CDMA 800
Channels	Low
Signal	CDMA
before/after Power Level:	28.85dBm /28.89dBm
Liquid Temperature:	21.4°C
Duty Cycle:	1:1
Test Date	2010.06.09
Frequency (MHz)	824.700012
Relative permittivity (real part)	41.823002
Relative permittivity (imaginary part)	20.171551
Conductivity (S/m)	0.924193
Variation (%)	0.070000

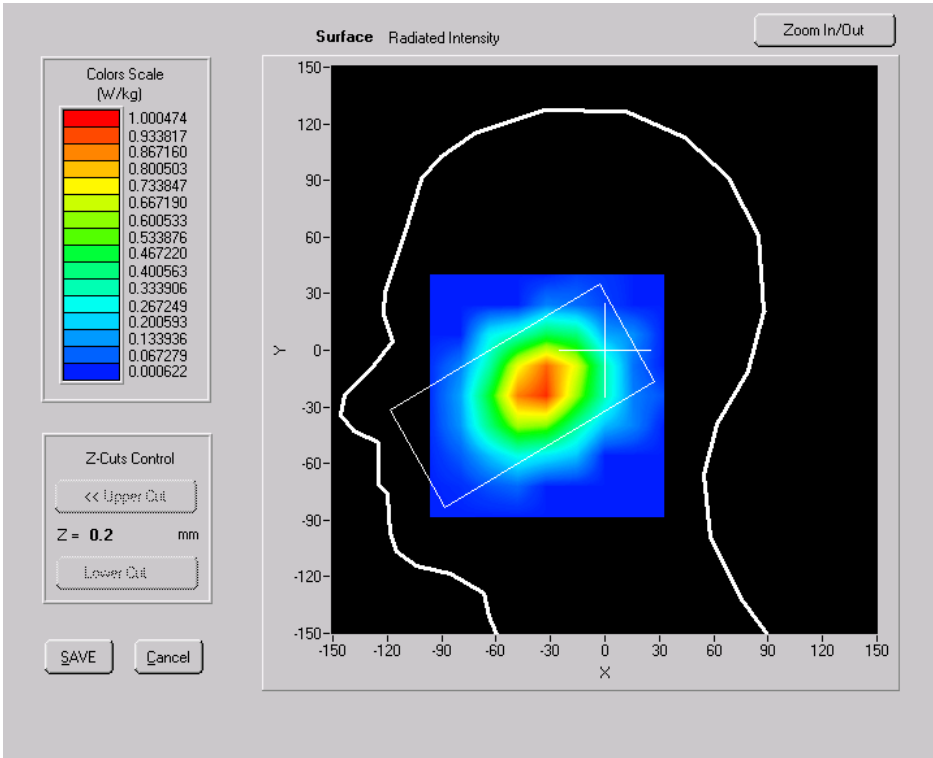

SURFACE SAR

检测结果/说明 (续页):

Results of test and additional explanation (continued page)

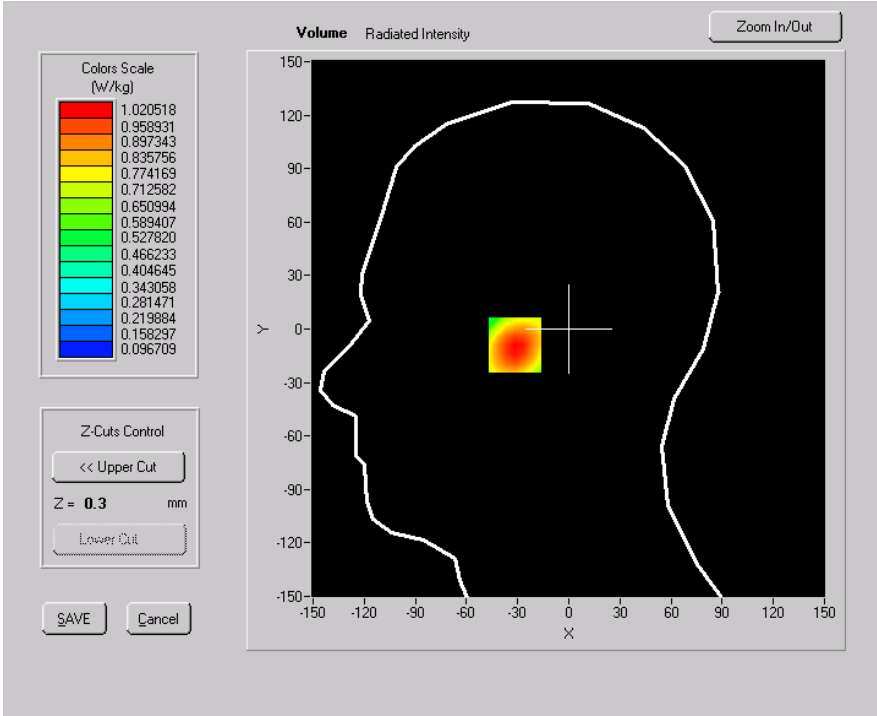

VOLUME SAR

Maximum location: X=-29.00, Y=-9.00

SAR 10g (W/Kg)	0.684346
SAR 1g (W/Kg)	0.975985

SAR, Z Axis Scan (X = -29, Y = -9)

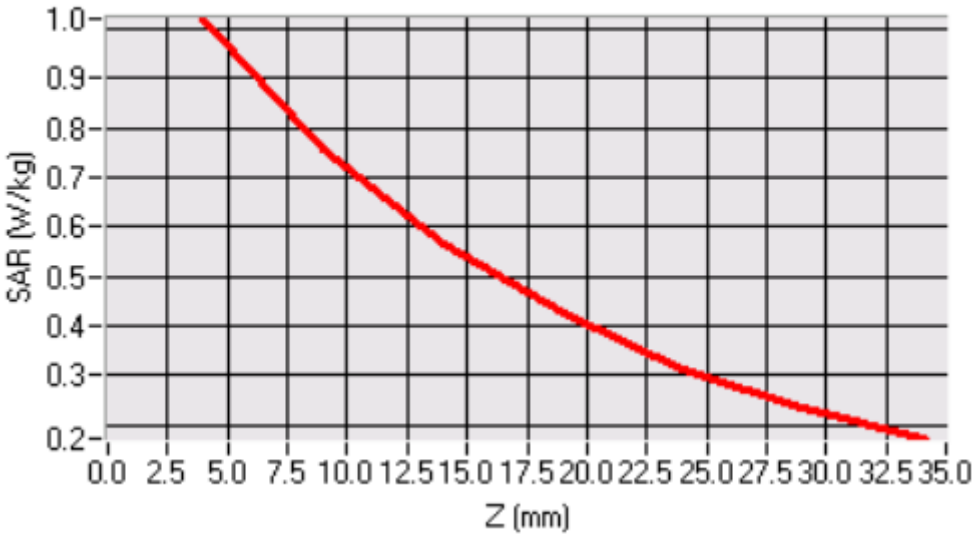

检测结果/说明（续页）：

Results of test and additional explanation (continued page)

1.7.2.2 Cheek, Middle channel (Channel 384)

Experimental conditions	
Phantom	Left head
Device Position	Cheek
Band	CDMA 800
Channels	Middle
Signal	CDMA
before/after Power Level:	28.64dBm / 28.69dBm
Liquid Temperature:	21.3°C
Duty Cycle:	1:1
Test Date	2010.06.09

Frequency (MHz)	836.520020
Relative permittivity (real part)	41.671001
Relative permittivity (imaginary part)	20.227200
Conductivity (S/m)	0.940025
Variation (%)	0.280000

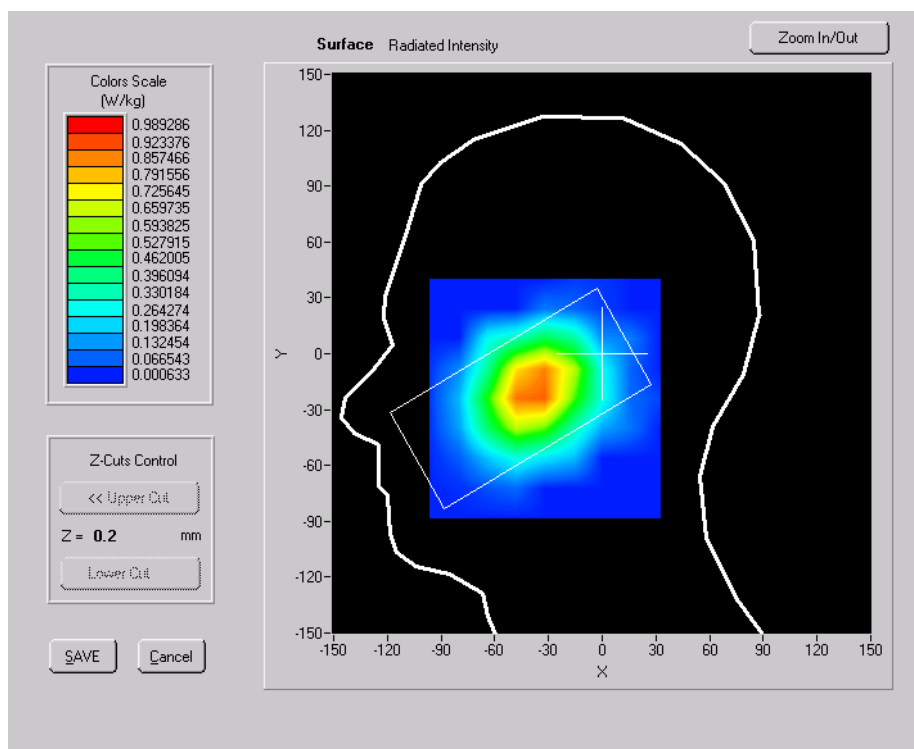

SURFACE SAR

检测结果/说明 (续页):

Results of test and additional explanation (continued page)

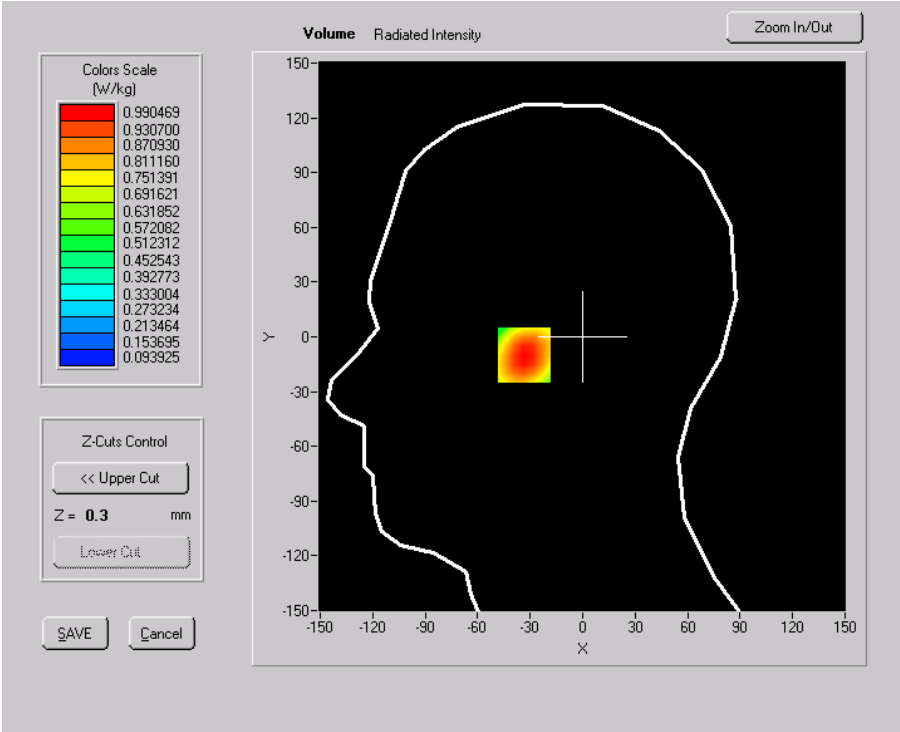

VOLUME SAR

Maximum location: X=-31.00, Y=-10.00

SAR 10g (W/Kg)	0.668551
SAR 1g (W/Kg)	0.952268

SAR, Z Axis Scan (X = -31, Y = -10)

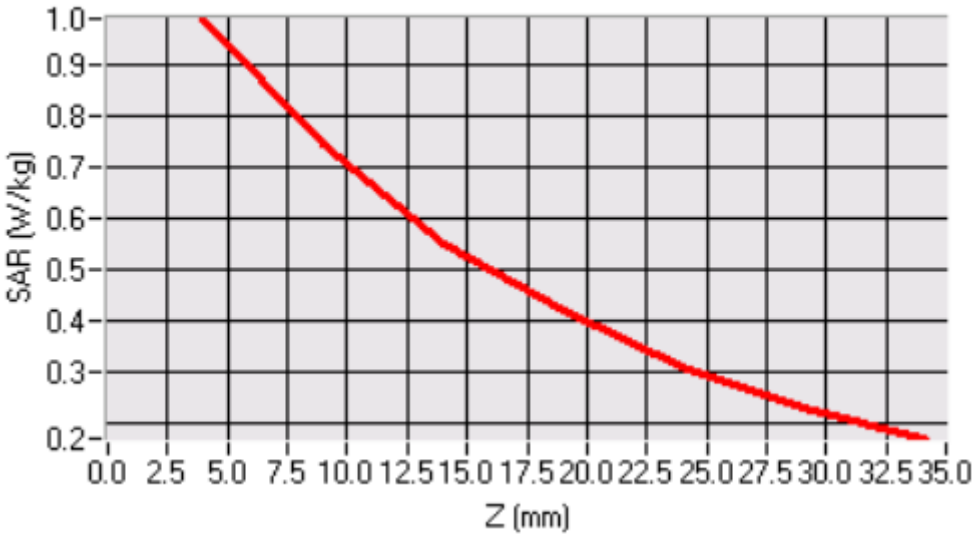

检测结果/说明（续页）：

Results of test and additional explanation (continued page)

1.7.2.3 Cheek, High channel (Channel 777)

Experimental conditions	
Phantom	Left head
Device Position	Cheek
Band	CDMA 800
Channels	High
Signal	CDMA
before/after Power Level:	28.90dBm / 28.96dBm
Liquid Temperature:	21.4°C
Duty Cycle:	1:1
Test Date	2010.06.09
Frequency (MHz)	848.309998
Relative permittivity (real part)	41.549000
Relative permittivity (imaginary part)	20.254499
Conductivity (S/m)	0.954561
Variation (%)	0.210000

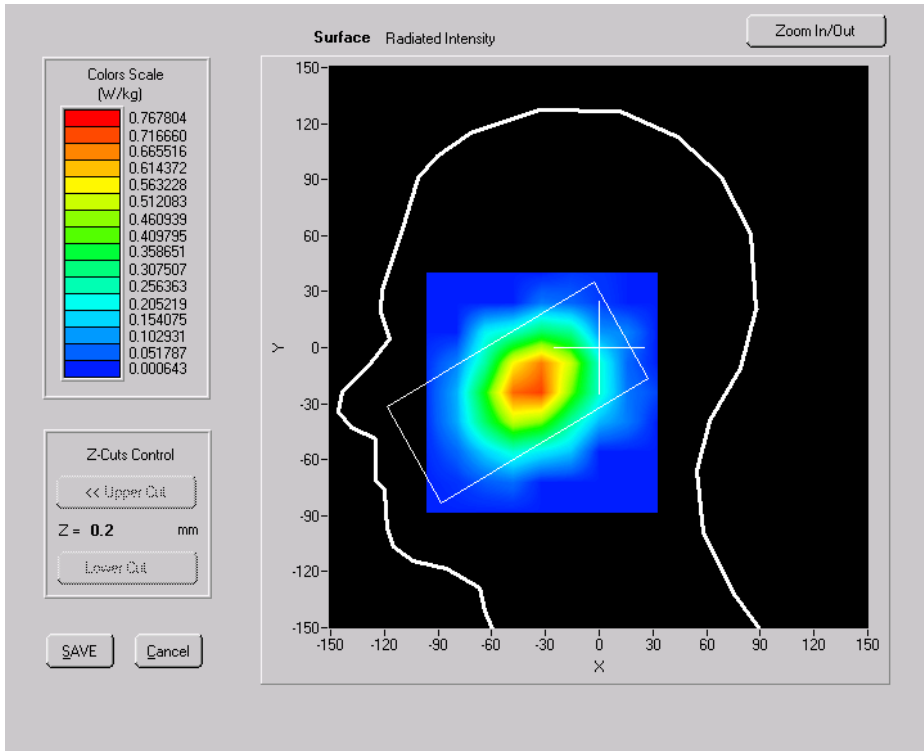

SURFACE SAR

检测结果/说明（续页）：

Results of test and additional explanation (continued page)

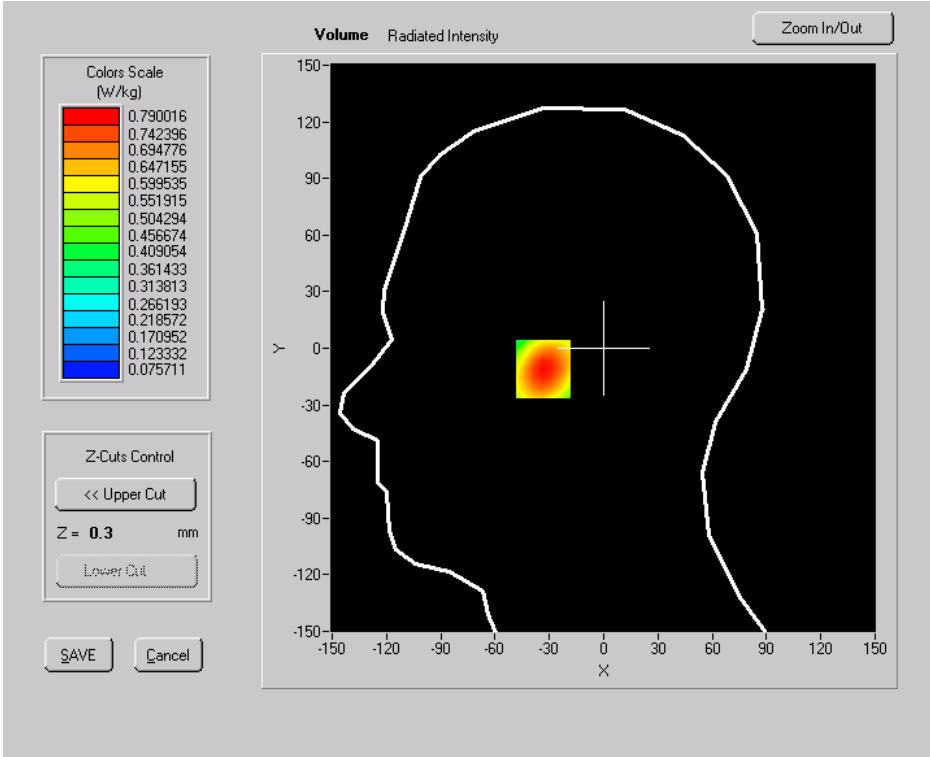

VOLUME SAR

Maximum location: X=-31.00, Y=-11.00

SAR 10g (W/Kg)	0.522678
SAR 1g (W/Kg)	0.751414

SAR, Z Axis Scan (X = -31, Y = -11)

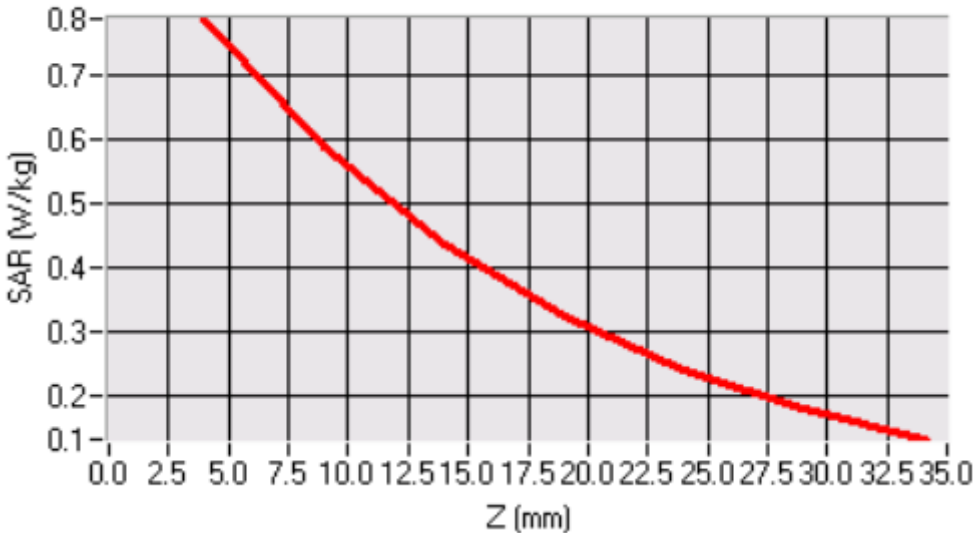

检测结果/说明（续页）：

Results of test and additional explanation (continued page)

1.7.2.4 Tilt, Middle channel (Channel 384)

Experimental conditions	
Phantom	Left head
Device Position	Tilt
Band	CDMA 800
Channels	Middle
Signal	CDMA
before/after Power Level:	28.65 dBm/28.70 dBm
Liquid Temperature:	21.5°C
Duty Cycle:	1:8
Test Date	2010.06.09
Frequency (MHz)	836.520020
Relative permittivity (real part)	41.671001
Relative permittivity (imaginary part)	20.227200
Conductivity (S/m)	0.940025
Variation (%)	0.220000

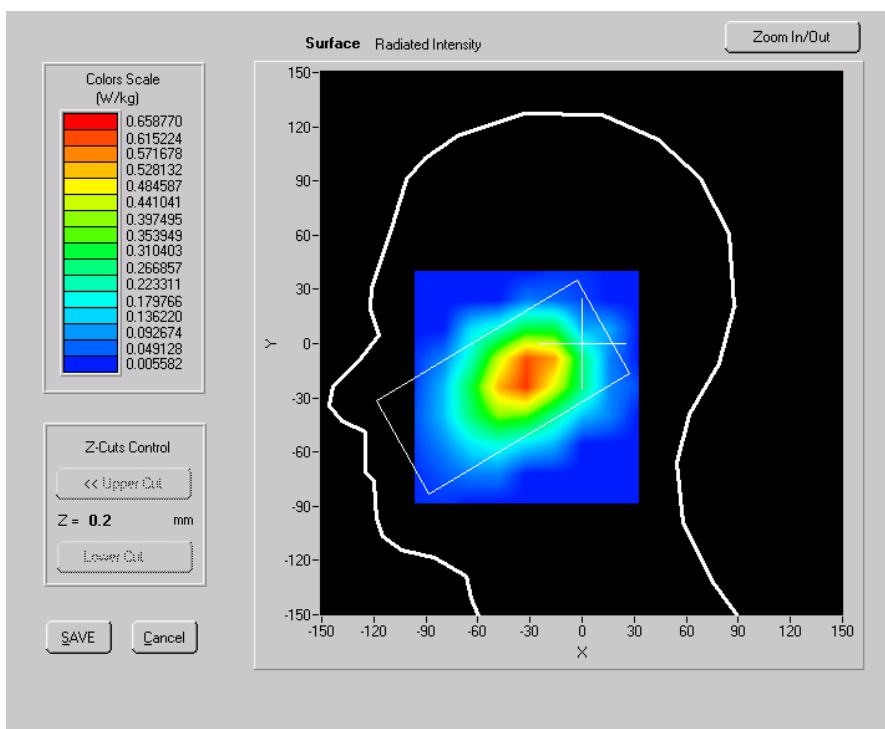

SURFACE SAR

检测结果/说明 (续页):

Results of test and additional explanation (continued page)

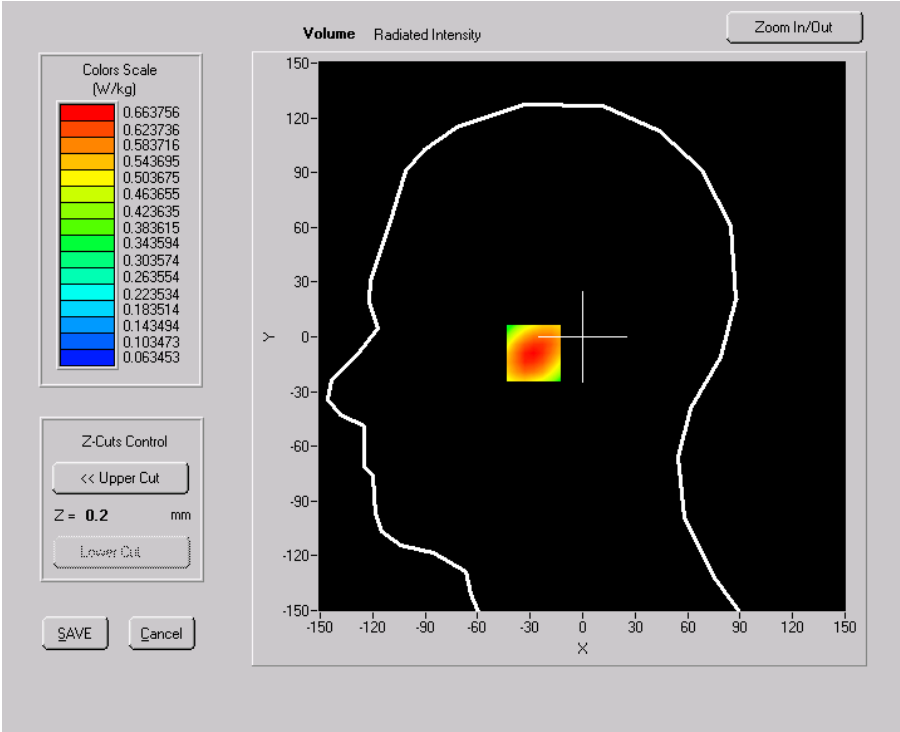

VOLUME SAR

Maximum location: X=-25.00, Y=-9.00

SAR 10g (W/Kg)	0.445908
SAR 1g (W/Kg)	0.633809

SAR, Z Axis Scan (X = -25, Y = -9)

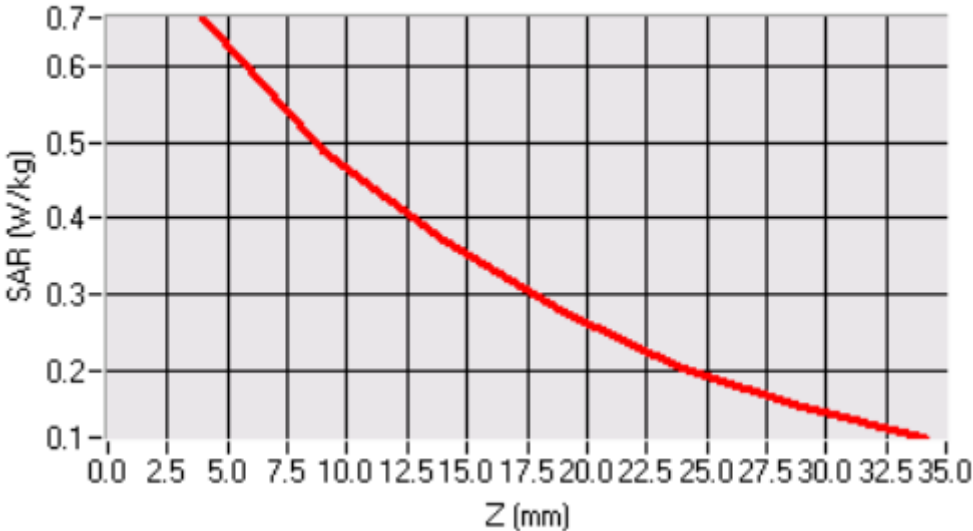

检测结果/说明（续页）：

Results of test and additional explanation (continued page)

1.7.3 Body front

1.7.3.1 Front face to phantom, Middle channel (Channel 384)

Experimental conditions	
Phantom	Validation plane
Device Position	Body
Band	CDMA 800
Channels	Middle
Signal	CDMA
before/after Power Level:	28.63dBm / 28.64dBm
Liquid Temperature:	21.2°C
Duty Cycle:	1:1
Test Date	2010.06.09
Frequency (MHz)	836.520020
Relative permittivity (real part)	55.585999
Relative permittivity (imaginary part)	21.832649
Conductivity (S/m)	1.014636
Variation (%)	-1.110000

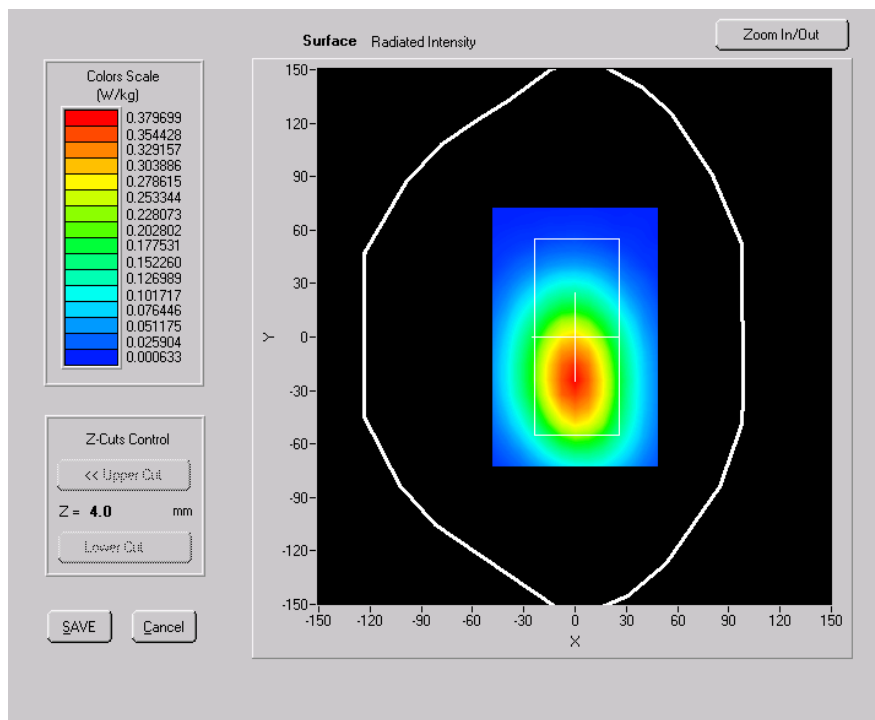

SURFACE SAR

检测结果/说明 (续页):

Results of test and additional explanation (continued page)

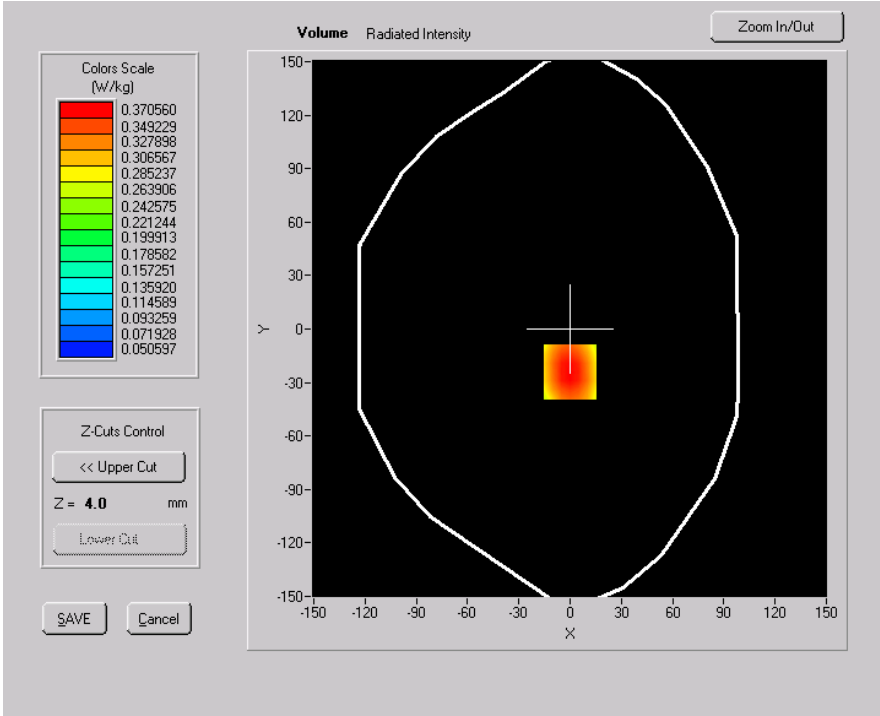

VOLUME SAR

Maximum location: X=0.00, Y=-24.00

SAR 10g (W/Kg)	0.283378
SAR 1g (W/Kg)	0.385206

SAR, Z Axis Scan (X = 0, Y = -24)

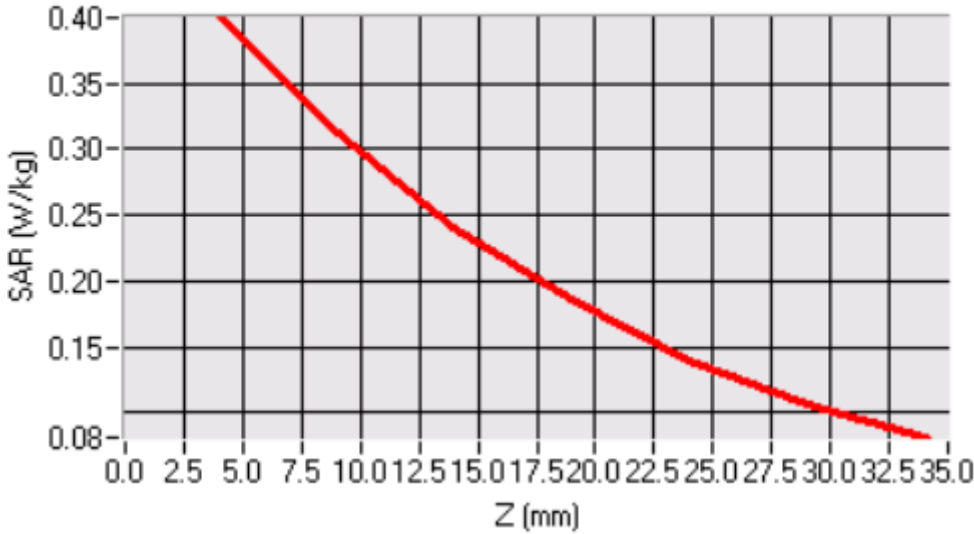

检测结果/说明（续页）：

Results of test and additional explanation (continued page)

1.7.3.2 Front face to phantom with headset, Middle channel (Channel 384)

Experimental conditions	
Phantom	Validation plane
Device Position	Body
Band	CDMA 800
Channels	Middle
Signal	CDMA
before/after Power Level:	28.65dBm / 28.67dBm
Liquid Temperature:	21.3°C
Duty Cycle:	1:1
Test Date	2010.06.09

Frequency (MHz)	836.520020
Relative permittivity (real part)	55.585999
Relative permittivity (imaginary part)	21.832649
Conductivity (S/m)	1.014636
Variation (%)	0.140000

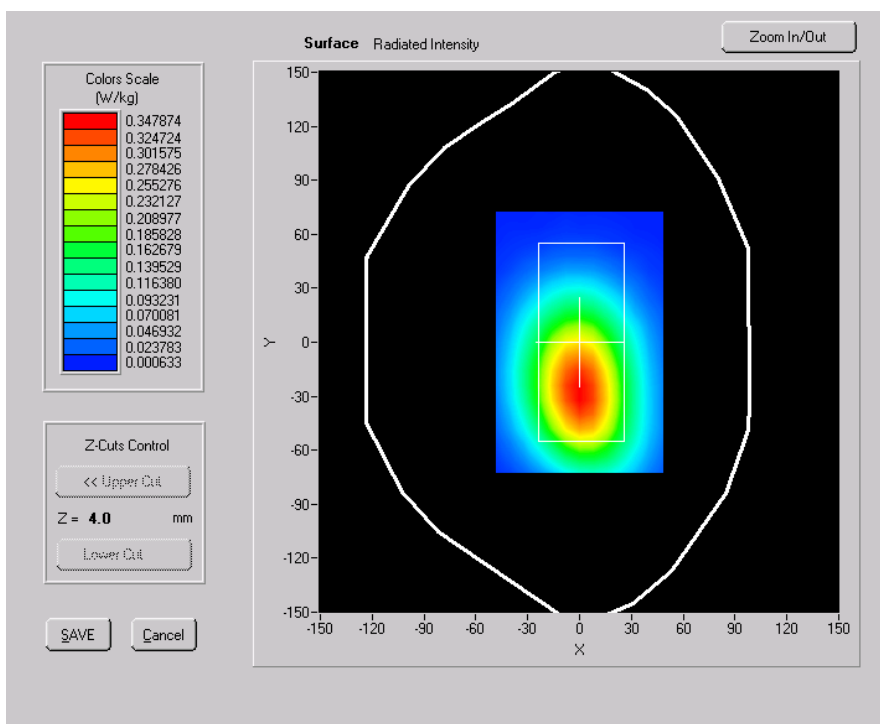

SURFACE SAR

检测结果/说明 (续页):

Results of test and additional explanation (continued page)

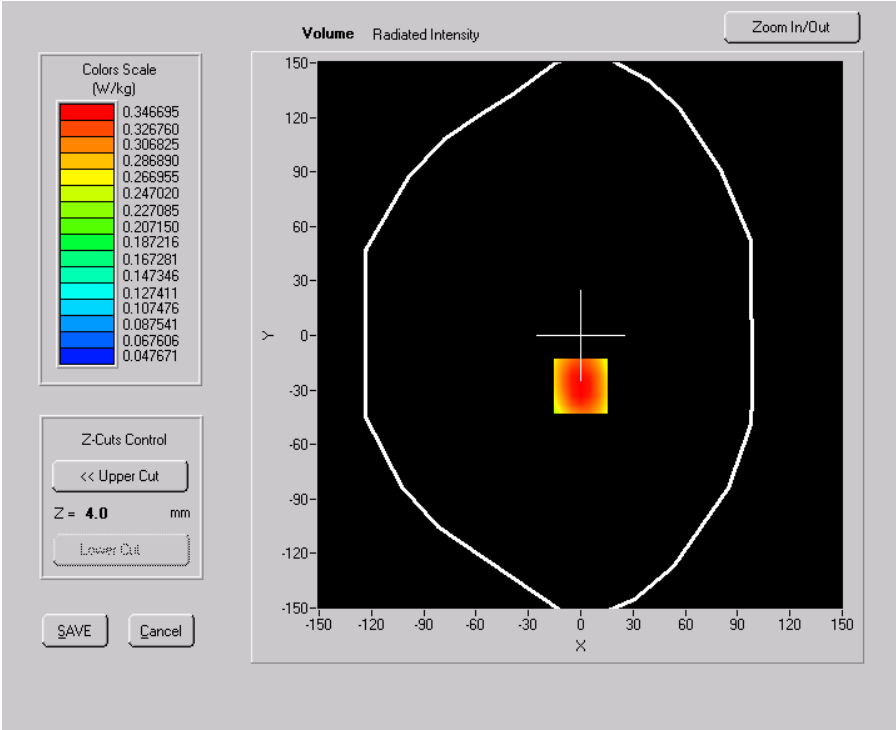

VOLUME SAR

Maximum location: X=0.00, Y=-28.00

SAR 10g (W/Kg)	0.265423
SAR 1g (W/Kg)	0.360913

SAR, Z Axis Scan (X = 0, Y = -28)

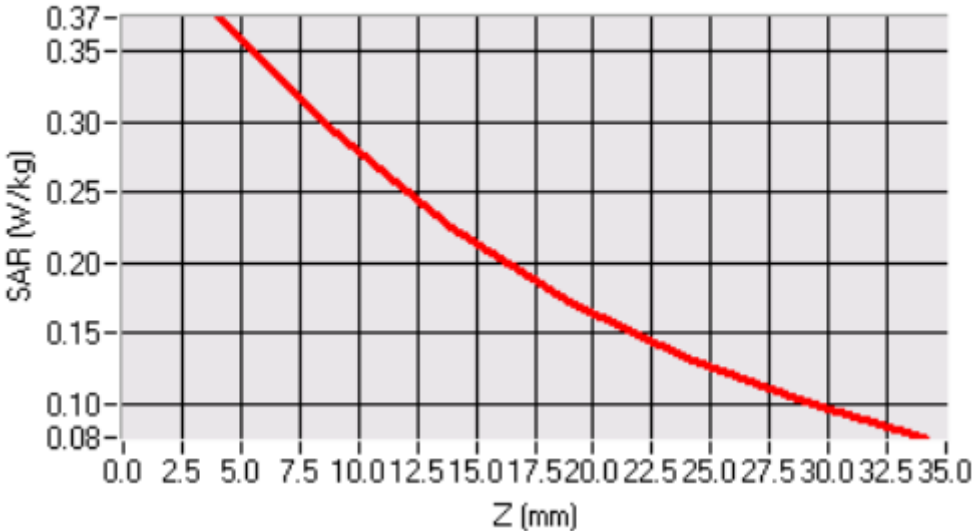

检测结果/说明（续页）：

Results of test and additional explanation (continued page)

1.7.4 Body back

1.7.4.1 Back face to phantom, Low channel (Channel 1013)

Experimental conditions	
Phantom	Validation plane
Device Position	Body
Band	CDMA 800
Channels	Low
Signal	CDMA
before/after Power Level:	28.85dBm / 28.86dBm
Liquid Temperature:	21.4°C
Duty Cycle:	1:1
Test Date	2010.06.09
Frequency (MHz)	824.700012
Relative permittivity (real part)	55.652000
Relative permittivity (imaginary part)	21.838949
Conductivity (S/m)	1.000588
Variation (%)	-0.710000

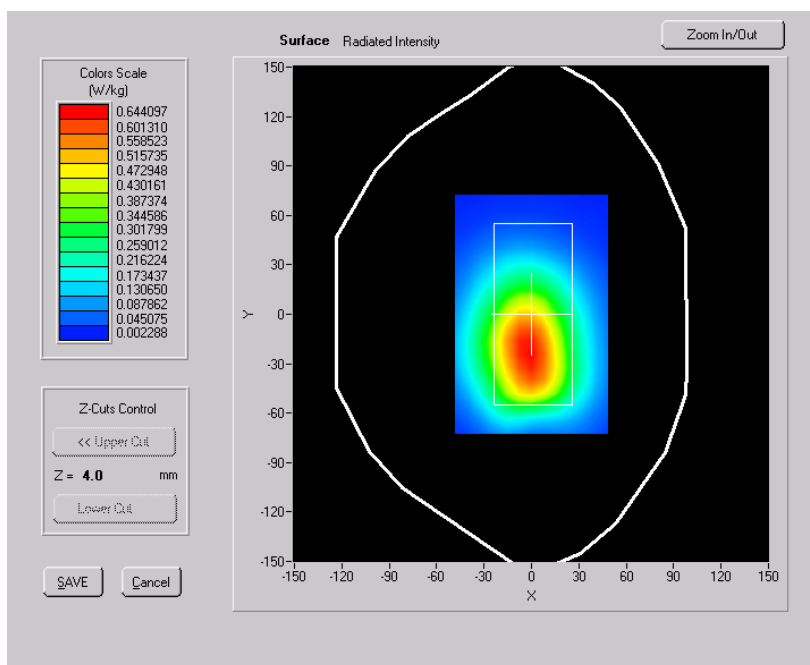

SURFACE SAR

检测结果/说明 (续页):

Results of test and additional explanation (continued page)

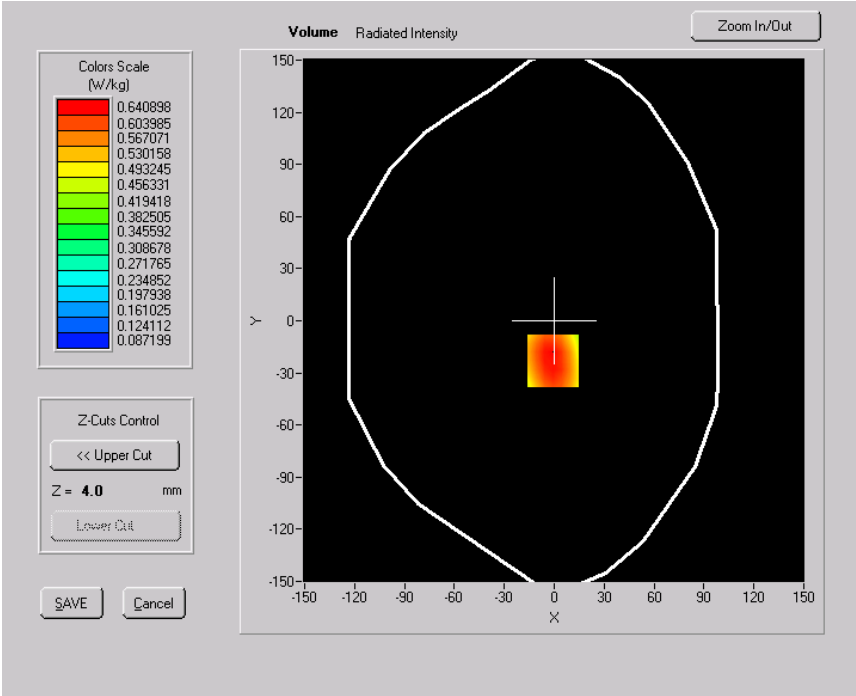

VOLUME SAR

Maximum location: X=-1.00, Y=-23.00

SAR 10g (W/Kg)	0.490977
SAR 1g (W/Kg)	0.667055

SAR, Z Axis Scan (X = -1, Y = -23)

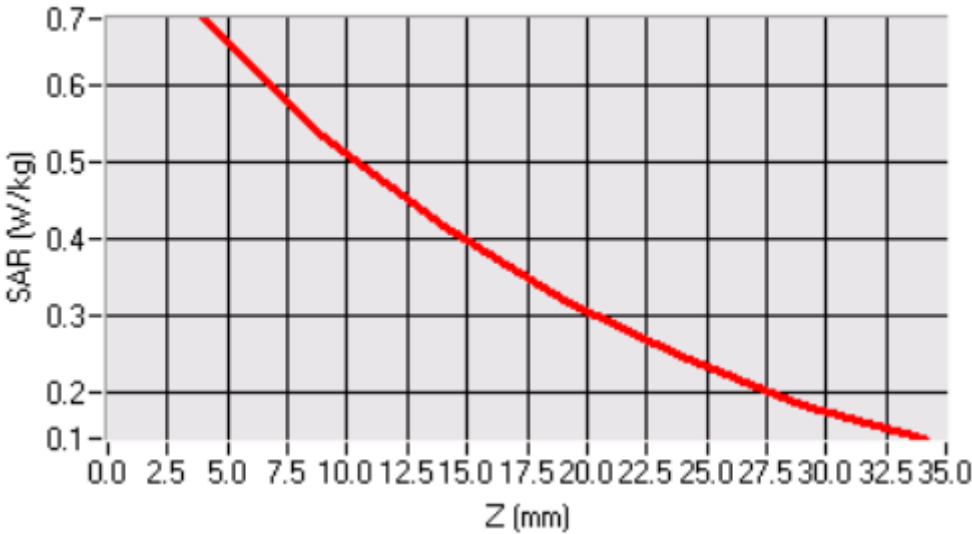

检测结果/说明（续页）：

Results of test and additional explanation (continued page)

1.7.4.2 Back face to phantom, Middle channel (Channel 384)

Experimental conditions	
Phantom	Validation plane
Device Position	Body
Band	CDMA 800
Channels	Middle
Signal	CDMA
before/after Power Level:	28.64dBm / 28.68dBm
Liquid Temperature:	21.3°C
Duty Cycle:	1:1
Test Date	2010.06.09

Frequency (MHz)	836.520020
Relative permittivity (real part)	55.585999
Relative permittivity (imaginary part)	21.832649
Conductivity (S/m)	1.014636
Variation (%)	-0.380000

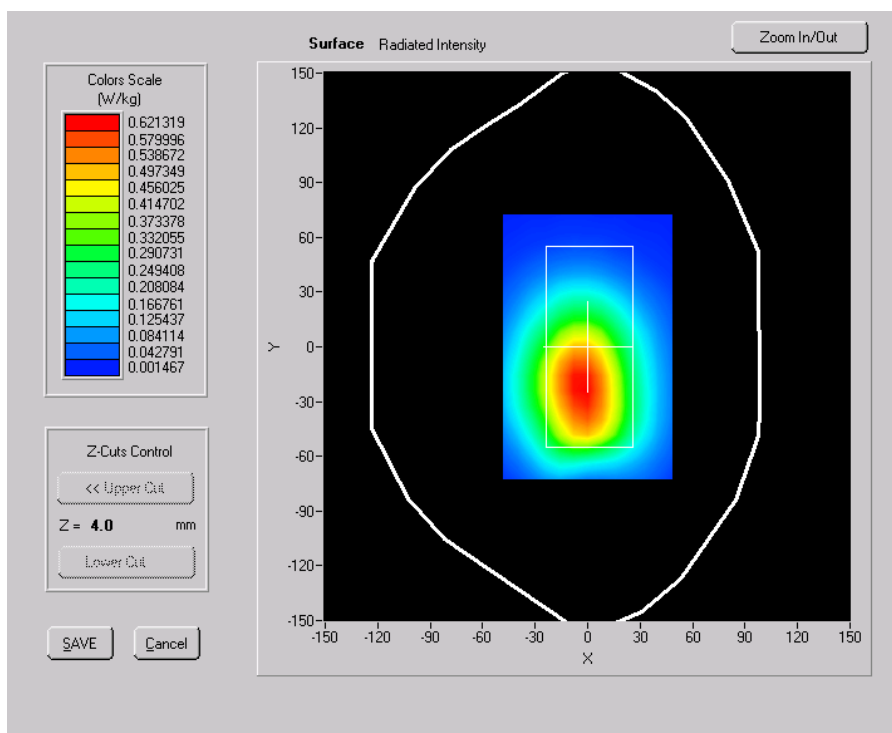

SURFACE SAR

检测结果/说明 (续页):

Results of test and additional explanation (continued page)

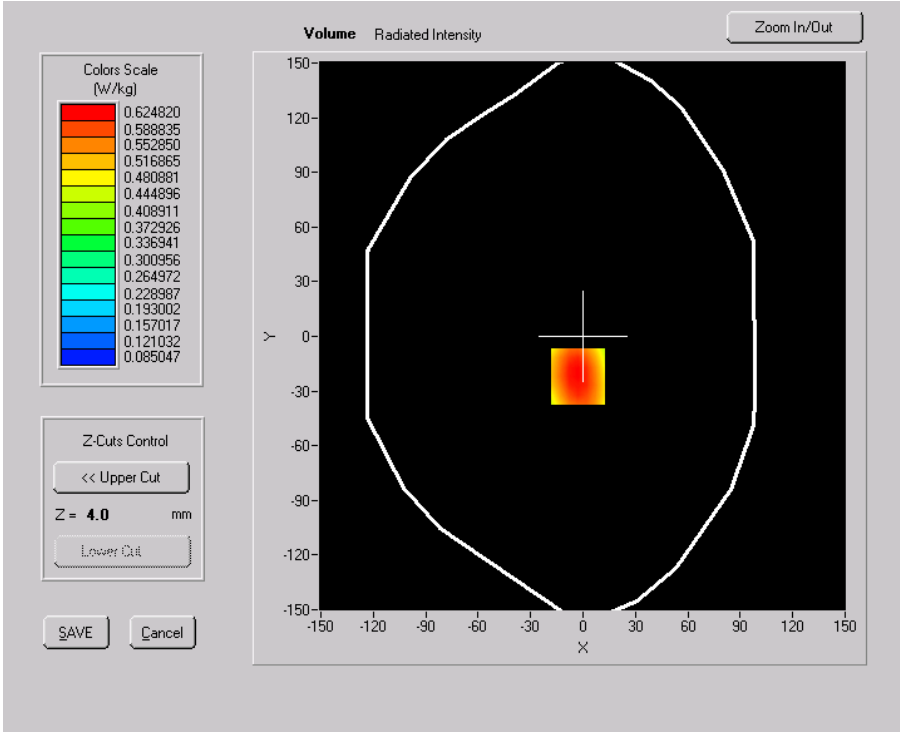

VOLUME SAR

Maximum location: X=-3.00, Y=-22.00

SAR 10g (W/Kg)	0.476099
SAR 1g (W/Kg)	0.651595

SAR, Z Axis Scan (X = -3, Y = -22)



检测结果/说明（续页）：

Results of test and additional explanation (continued page)

1.7.4.3 Back face to phantom, High channel (Channel 777)

Experimental conditions	
Phantom	Validation plane
Device Position	Body
Band	CDMA 800
Channels	High
Signal	CDMA
before/after Power Level:	28.96dBm / 28.94dBm
Liquid Temperature:	21.4°C
Duty Cycle:	1:1
Test Date	2010.06.09
Frequency (MHz)	848.309998
Relative permittivity (real part)	55.523998
Relative permittivity (imaginary part)	21.833700
Conductivity (S/m)	1.028986
Variation (%)	0.040000

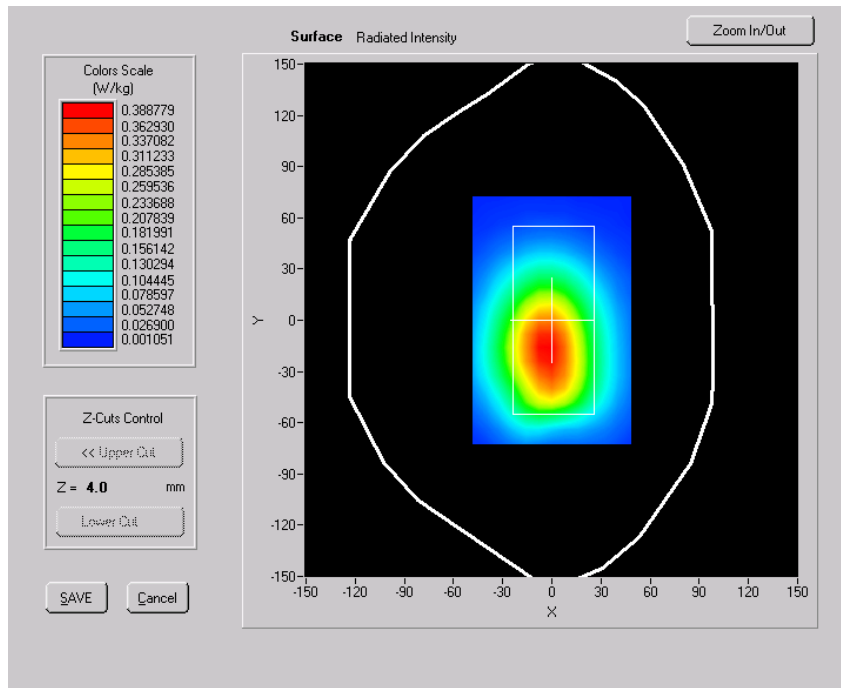

SURFACE SAR

检测结果/说明 (续页):

Results of test and additional explanation (continued page)

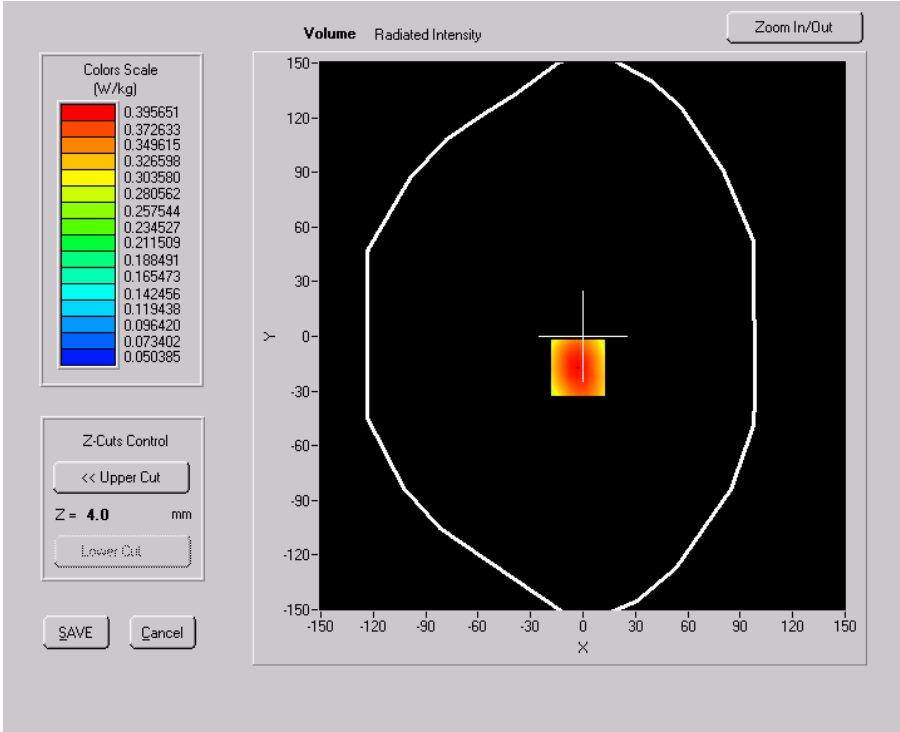

VOLUME SAR

Maximum location: X=-3.00, Y=-17.00

SAR 10g (W/Kg)	0.298362
SAR 1g (W/Kg)	0.409886

SAR, Z Axis Scan (X = -3, Y = -17)

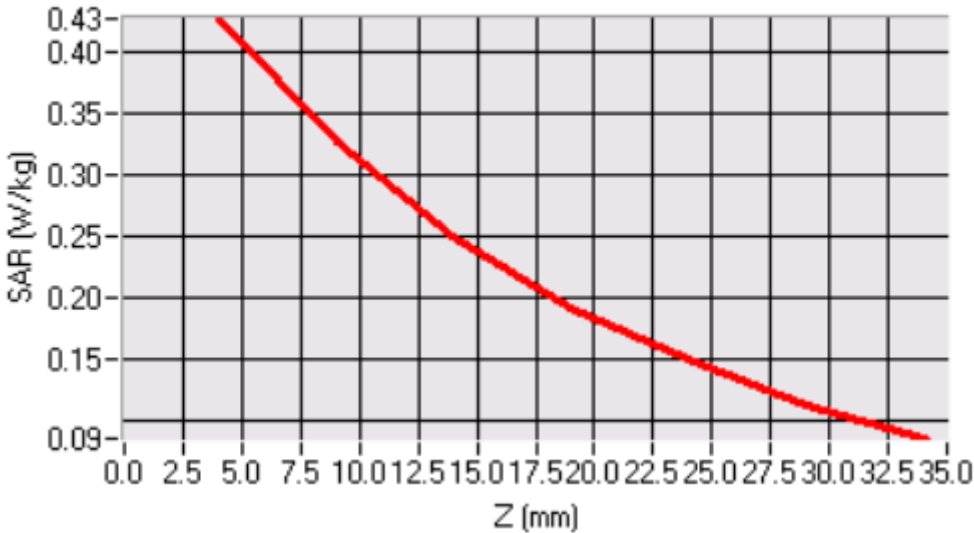

检测结果/说明（续页）：

Results of test and additional explanation (continued page)

1.7.4.4 Back face to phantom with headset, Middle channel (Channel 384)

Experimental conditions	
Phantom	Validation plane
Device Position	Body
Band	CDMA 800
Channels	Middle
Signal	CDMA
before/after Power Level:	28.67dBm / 28.66dBm
Liquid Temperature:	21.2°C
Duty Cycle:	1:1
Test Date	2010.06.09
Frequency (MHz)	836.520020
Relative permittivity (real part)	55.585999
Relative permittivity (imaginary part)	21.832649
Conductivity (S/m)	1.014636
Variation (%)	1.320000

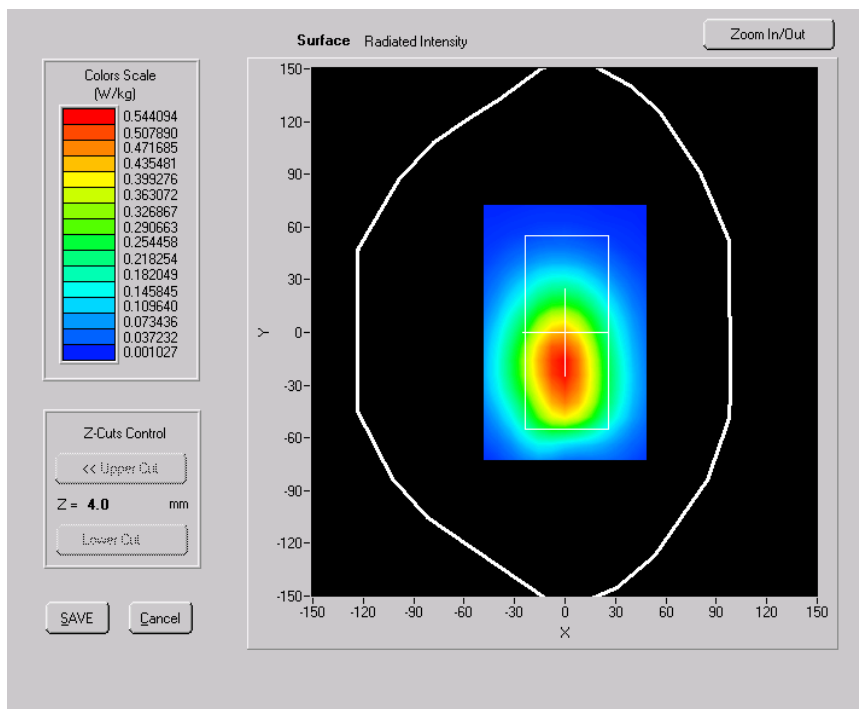

SURFACE SAR

检测结果/说明 (续页):

Results of test and additional explanation (continued page)

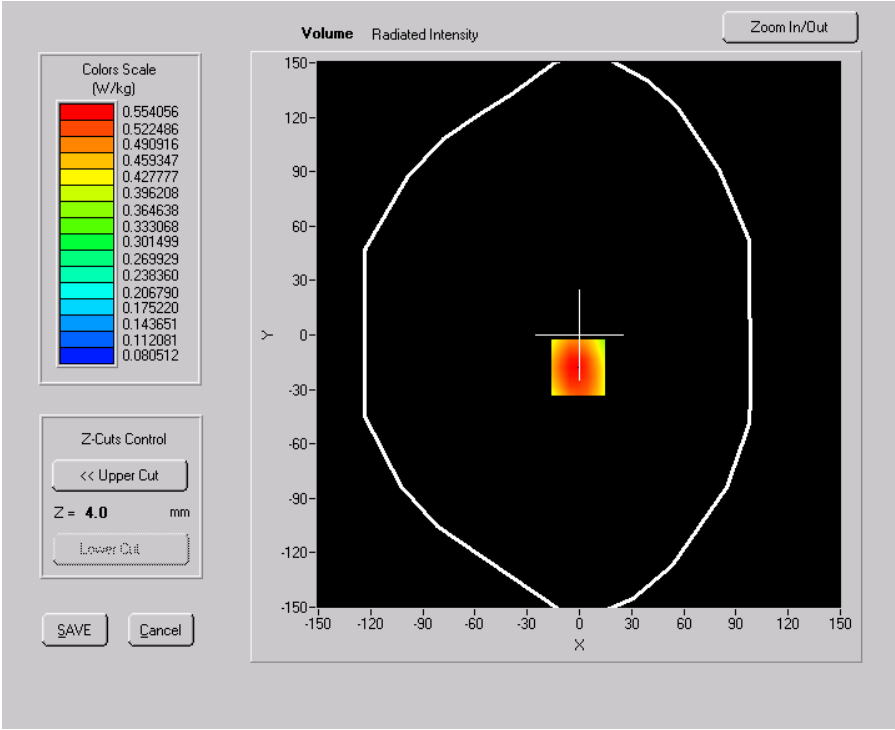

VOLUME SAR

Maximum location: X=-9.00, Y=8.00

SAR 10g (W/Kg)	0.423831
SAR 1g (W/Kg)	0.576888

SAR, Z Axis Scan (X = -1, Y = -18)

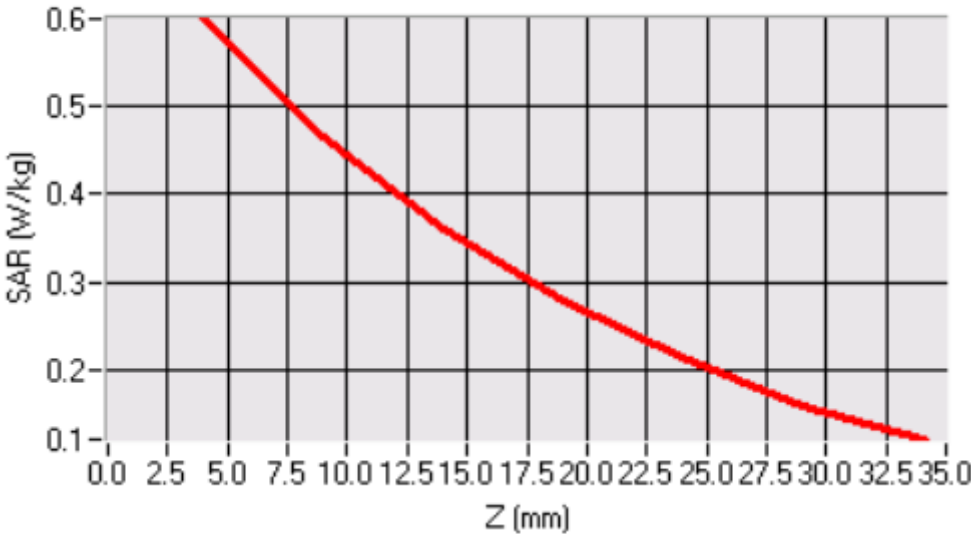

检测结果/说明（续页）：

Results of test and additional explanation (continued page)

1.7.5 SAR System Validation Data

1.7.5.1 Head

Experimental conditions

Middle channel SAR (Channel 384):

Phantom	Validation plane
Device Position	Dipole
Band	CDMA 800
Channels	Middle
Signal	CW
Input Power Level:	30dBm
Liquid Temperature:	21.3°C
Test Date	2010.06.09

Frequency (MHz)	836.520020
Relative permittivity (real part)	41.671001
Relative permittivity (imaginary part)	20.227200
Conductivity (S/m)	0.940025
Variation (%)	-0.140000

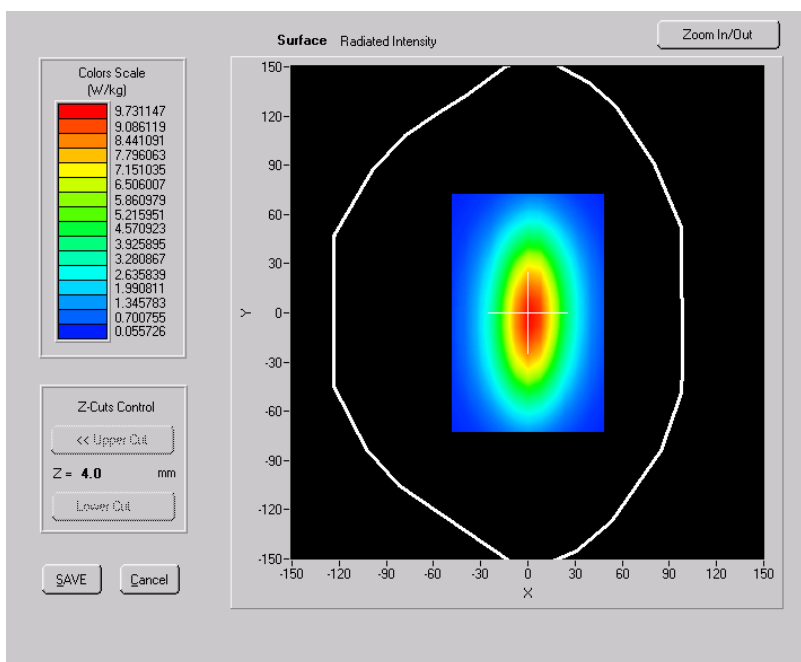

SURFACE SAR

检测结果/说明 (续页):

Results of test and additional explanation (continued page)

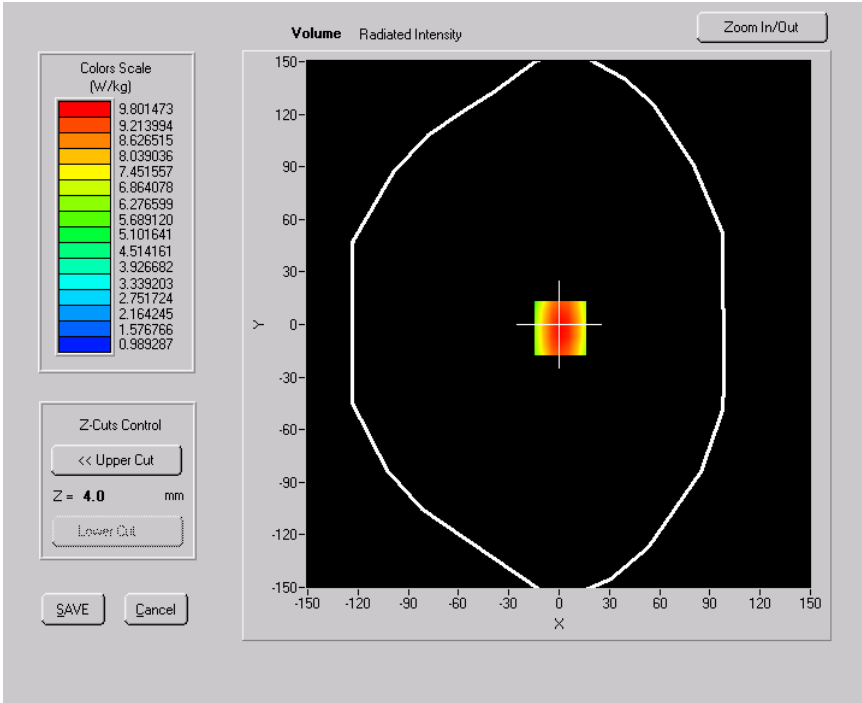

VOLUME SAR

Maximum location: X=1.00, Y=-2.00

SAR 10g (W/Kg)	6.298763
SAR 1g (W/Kg)	9.338287

SAR, Z Axis Scan (X = 1, Y = -2)

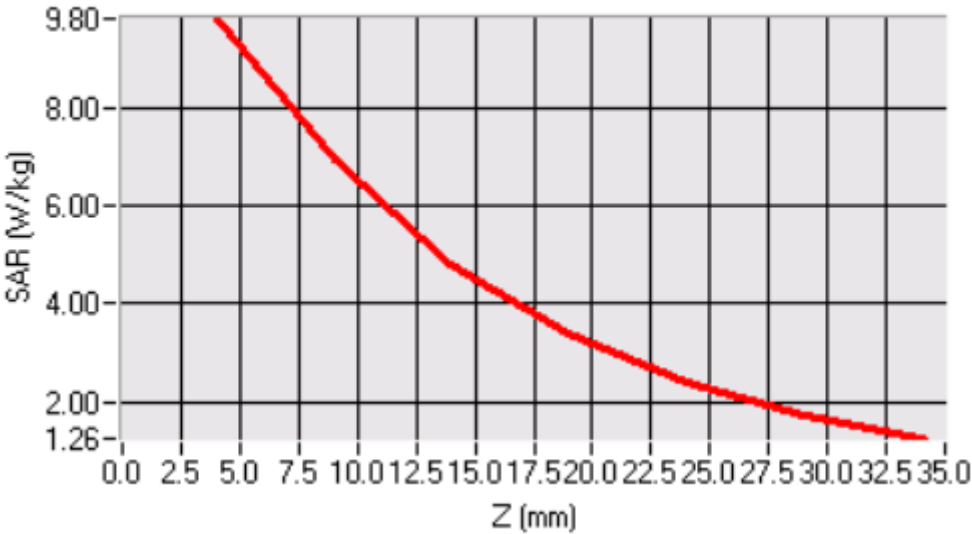

检测结果/说明（续页）：

Results of test and additional explanation (continued page)

1.7.5.2 Body

Experimental conditions

Middle channel SAR (Channel 384):

Phantom	Validation plane
Device Position	Dipole
Band	CDMA 800
Channels	Middle
Signal	CW
Input Power Level:	30dBm
Liquid Temperature:	21.2°C
Test Date	2010.06.09

Frequency (MHz)	836.520020
Relative permittivity (real part)	55.585999
Relative permittivity (imaginary part)	21.832649
Conductivity (S/m)	1.014636
Variation (%)	0.170000

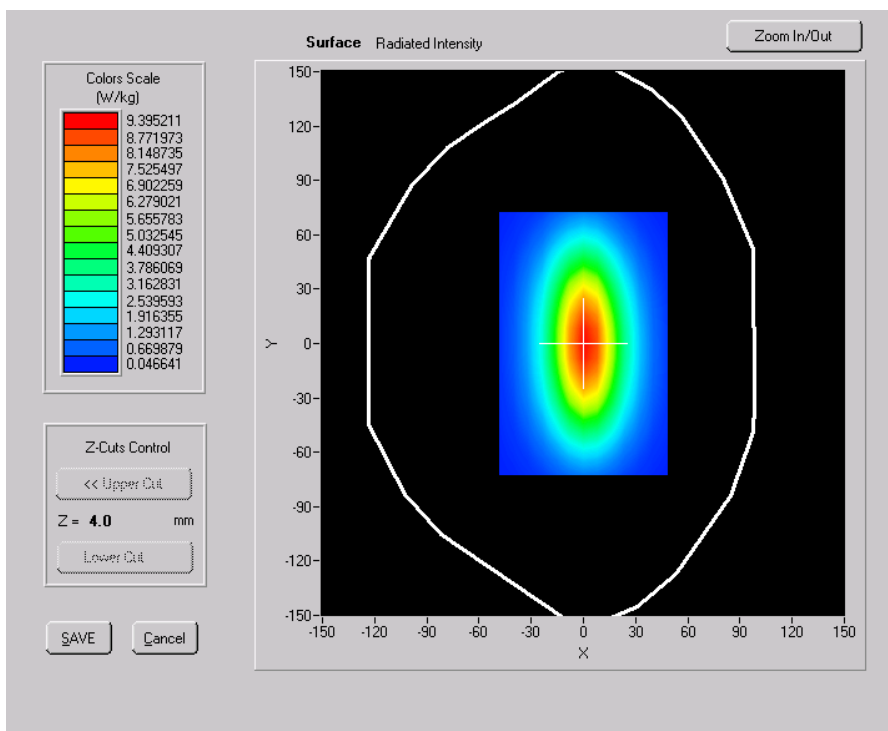

SURFACE SAR

检测结果/说明 (续页) :

Results of test and additional explanation (continued page)

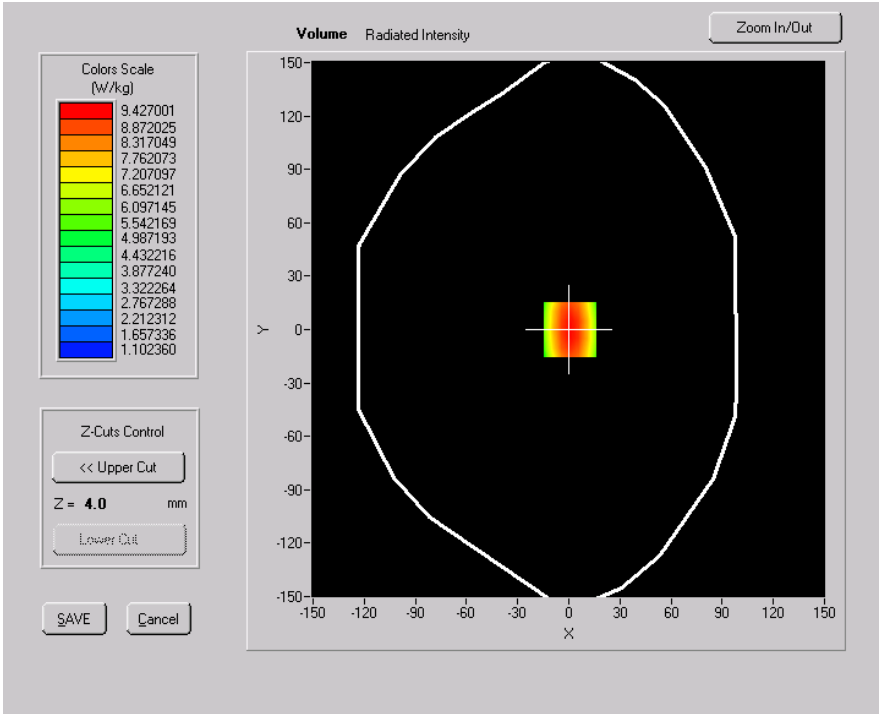

VOLUME SAR

Maximum location: X=1.00, Y=0.00

SAR 10g (W/Kg)	6.612073
SAR 1g (W/Kg)	9.692415

SAR, Z Axis Scan (X = 1, Y = 0)

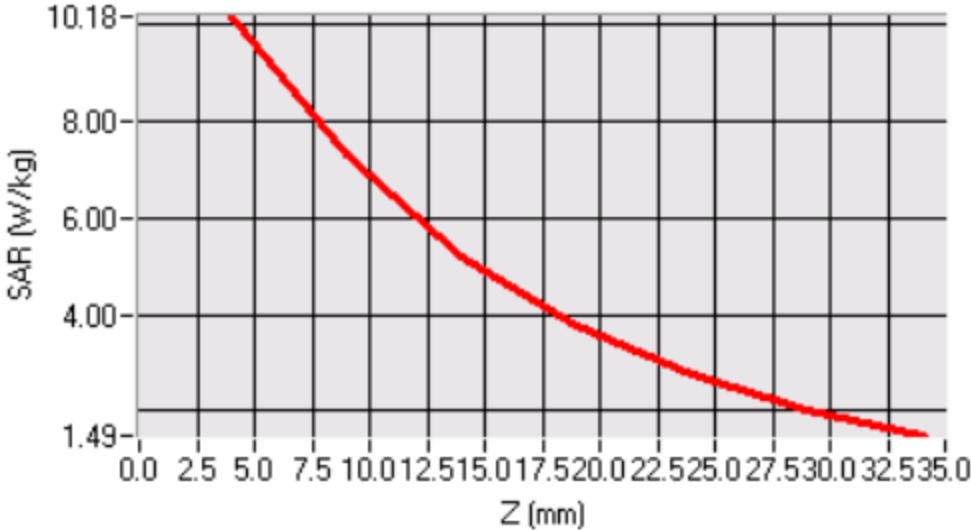

检测结果/说明（续页）：

Results of test and additional explanation (continued page)

Test instrumentation (Test date: 2010.06.09)

Name/Model	Number	Due date
6 axis Robot KR3	容-027-01	/
Vector Network Analyzer ZVB 8	容-027-27	2010.06.23
Signal Generator SMT 06	容-027-15	2010.06.25
Power Meter NRVD	容-027-16	2010.06.23
Millivolt meter 2000	容-027-26	2010.06.18
Isotropic E-Field Probe E-FIELD PROBE	容-027-54	2010.12.23
Universal Radio Communication Tester E5515C(or 8960)	容-027-56	2010.09.23
Solid State Power Amplifier BLMA 0820-6	容-027-18	2010.06.25
SAM Phantom	容-027-22	/
Mobile Phone Positioning Device POSITIONING DEVICE	容-027-20	/
850 MHz Dipole Antenna	/	2010.12.15

检测结果/说明（续页）：

Results of test and additional explanation (continued page)

Test photographs

Right head, Cheek



Right head, Tilt

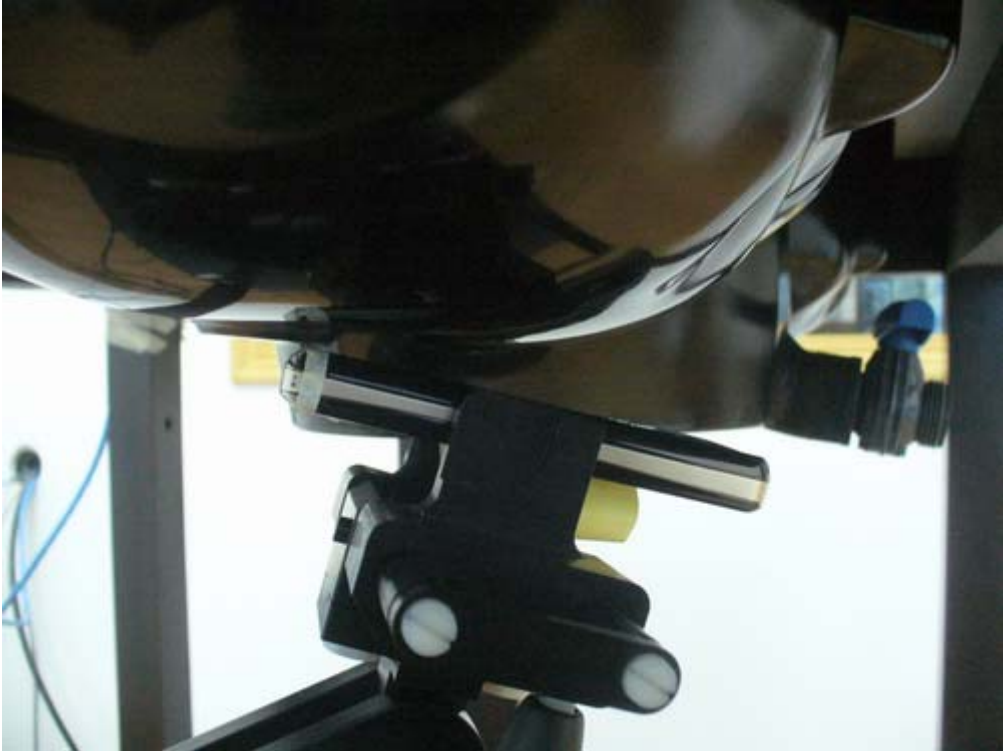

检测结果/说明（续页）：

Results of test and additional explanation (continued page)

Left head, Cheek

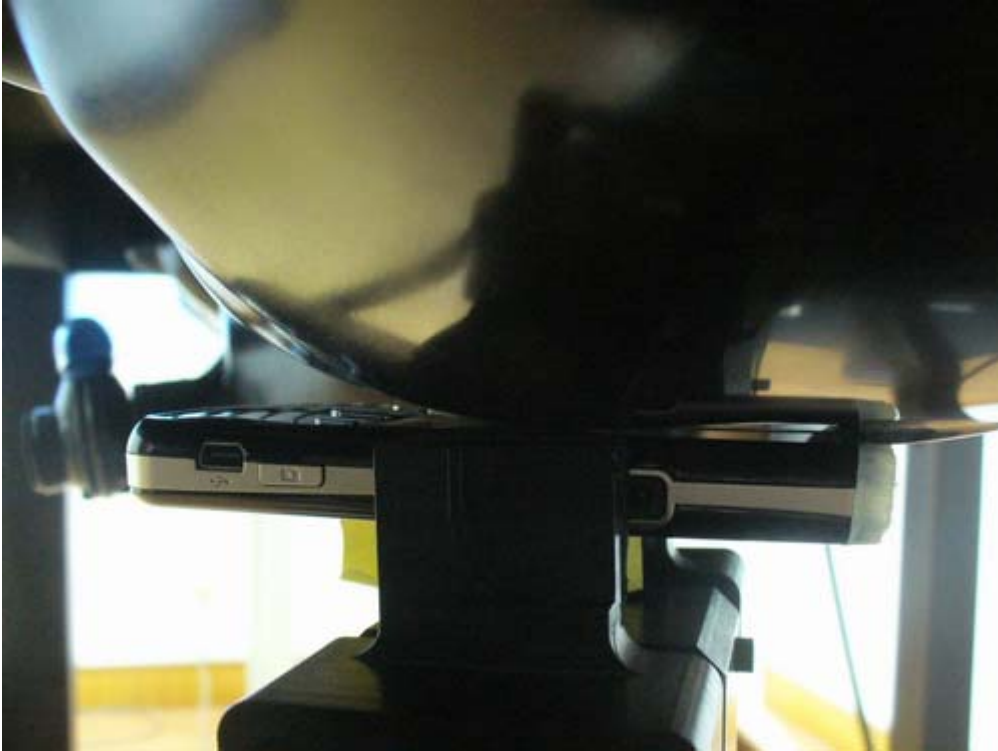

Left head, Tilt



检测结果/说明（续页）：

Results of test and additional explanation (continued page)

Body front face to phantom



Body front face to phantom with earphone t

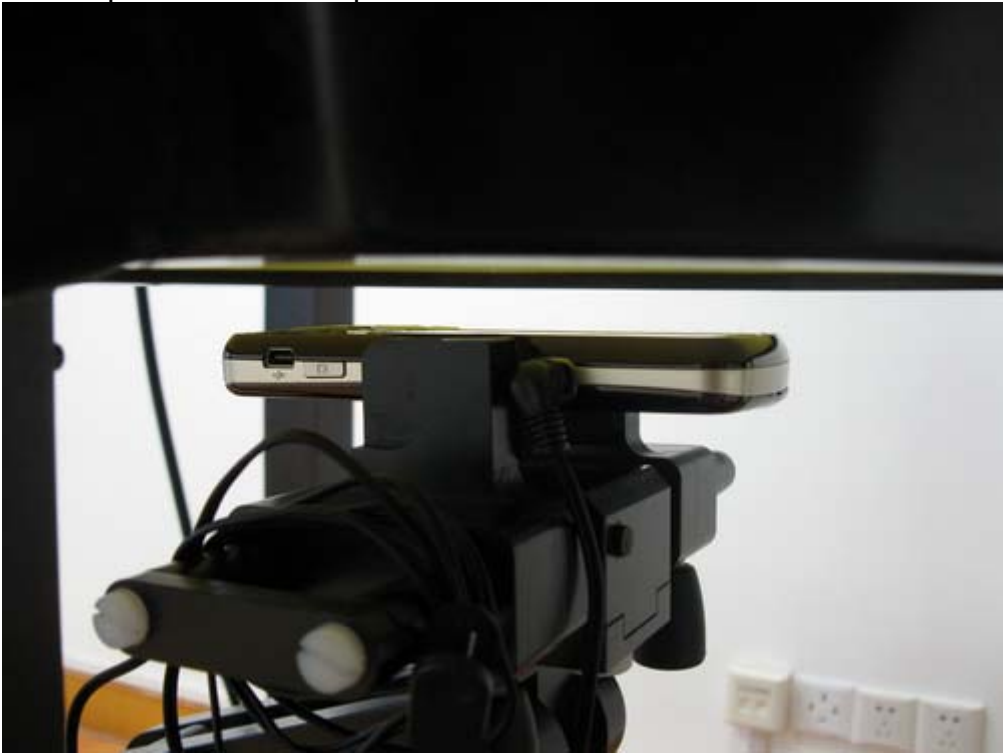

检测结果/说明（续页）：

Results of test and additional explanation (continued page)

Body back face to phantom

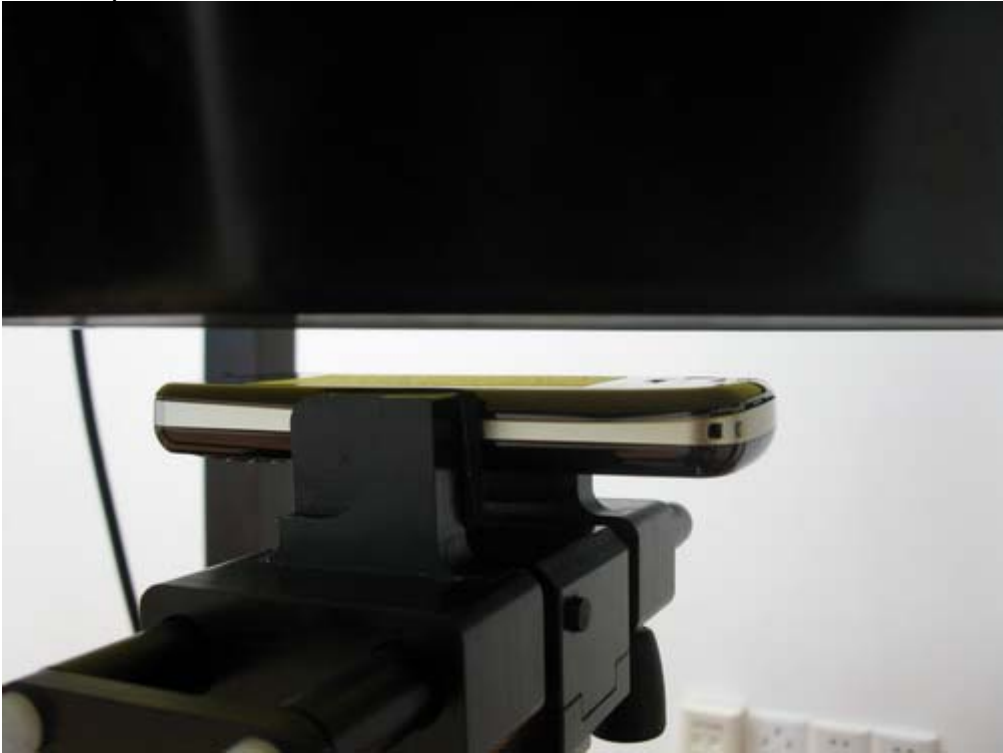

Body back face to phantom with earphone t



检测结果/说明（续页）：

Results of test and additional explanation (continued page)

Depth of Simulating Liquid in SAM Head Phantom

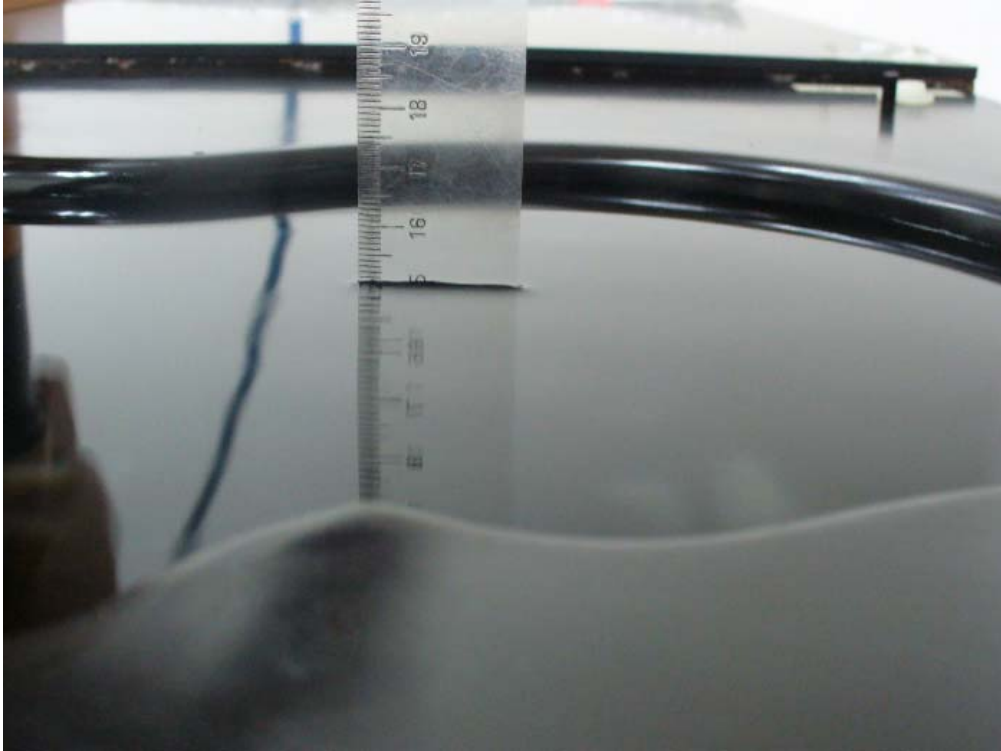

Depth of Simulating Liquid in SAM Flat (Body) Phantom

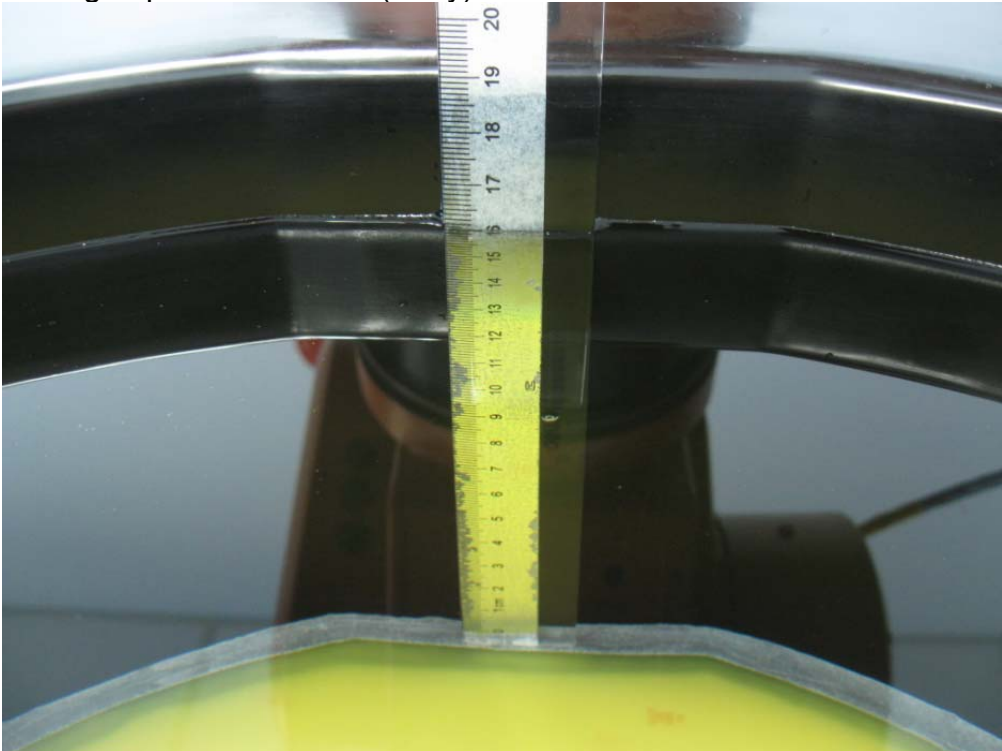

检测结果/说明 (续页):

Results of test and additional explanation (continued page)

Attachment 1:

本次检测所使用的主要测量仪器:

Main measuring instruments used in this test

名称/型号 Name/Model	编号 Number	证书编号/有效期限 Certificate No./Due date	测量范围/准确度 Measuring range/accuracy
6 axis Robot KR3	容-027-01	/	6 axes, Repeatability: ± 0.05 mm, Nominal payload: 3 kg
Vector Network Analyzer ZVB 8	容-027-27	2009F31-10-002461 2010.06.23	300kHz~8GHz, Frequency resolution: 100 μ Hz, Measurement time: < 8ms, Measurement bandwidths: 1Hz~ 500kHz / Uncertainty: +10dB~+3dB: 0.6 dB; +3dB~-15dB: 0.4dB; -15dB~ -25dB: 1dB; -25dB~-35dB: 3dB
Signal Generator SMT 06	容-027-15	2009F33-10-000470 2010.06.25	5kHz~6 GHz, Resolution:0.1Hz,-144dBm ~ + 13 dBm, Max.R F power: 1W, Max.DC voltage:0V / Level > -127 dBm: f<1.5 GHz:< 1dB; F>1.5 GHz:< 1.5dB; f> 3GHz:< 2dB
Power Meter NRVD	容-027-16	2009F31-10-002965 2010.06.23	100 kHz ~ 6 GHz, 10nW ~ 500mW
Millivolt meter 2000	容-027-26	2009F11-20-000607 2010.06.18	/
Isotropic E-Field Probe E-FIELD PROBE	容-027-54	2009J10-10-912004 2009J10-10-912005 2009J10-10-912006 2009J10-10-912007 2009J10-10-912008 2009J10-10-912009 2010.12.23	/
Universal Radio Communication Tester E5515C(or 8960)	容-027-56	2009F44-10-000579 2010.09.23	1)GSM channels (9): GSM 450MHz, GSM 480MHz,GSM 750MHz, GSM 850MHz, PGSM 900MHz, EGSM 900MHz, RGSM 900MHz, DCS 1800MHz, PCS 1900MHz, 3dB bandwidth: DC~20kHz; 2)WCDMA(10 个): Band I, II, III, IV, V, VI, VII, VIII, IX, X; 3) CDMA2000(13 个): Band 0, 1, 3, 4, 5, 6, 10, 11, 12, 14, 15, 18, 19
Solid State Power Amplifier BLMA 0820-6	容-027-18	2009F33-10-000472 2010.06.25	0.8 GHz ~ 2 GHz; Output:6W; Gain: min 37.8 / typ 40, ± 2 dB; Harmonics: 2nd: 20dBc, 3rd: 20dBc; Line power:125 W.

检测结果/说明（续页）：

Results of test and additional explanation (continued page)

名称/型号 Name/Model	编号 Number	证书编号/有效期限 Certificate No./Due date	测量范围/准确度 Measuring range/accuracy
SAM Phantom	容-027-22	/	/
Mobile Phone Positioning Device POSITIONING DEVICE	容-027-20	/	/
850 MHz Dipole Antenna	/	2010.12.15	/

检测结果/说明（续页）：

Results of test and additional explanation (continued page)

Attachment 2: Measurement Uncertainties

UNCERTAINTY EVALUATION FOR HANDSET SAR TEST

a	b	c	d	e= f(d,k)	f	g	h= c*f/e	i= c*g/e	k
Uncertainty Component	Sec.	Tol (+-%)	Prob. Dist.	Div.	Ci (1g)	Ci (10g)	1g Ui (+-%)	10g Ui (+-%)	Vi
Measurement System									
Probe calibration	E.2.1	6.0	N	1	1	1	6.0	6.0	∞
Axial Isotropy	E.2.2	2.5	R	$\sqrt{3}$	$(1-Cp)^{1/2}$	$(1-Cp)^{1/2}$	1.0	1.0	∞
Hemispherical Isotropy	E.2.2	4.0	R	$\sqrt{3}$	\sqrt{Cp}	\sqrt{Cp}	1.6	1.6	∞
Boundary effect	E.2.3	1.0	R	$\sqrt{3}$	1	1	0.6	0.6	∞
Linearity	E.2.4	5.0	R	$\sqrt{3}$	1	1	2.9	2.9	∞
System detection limits	E.2.5	1.0	R	$\sqrt{3}$	1	1	0.6	0.6	∞
Readout Electronics	E.2.6	0.5	N	1	1	1	0.5	0.5	∞
Reponse Time	E.2.7	0.2	R	$\sqrt{3}$	1	1	0.1	0.1	∞
Integration Time	E.2.8	2.0	R	$\sqrt{3}$	1	1	1.2	1.2	∞
RF ambient Conditions	E.6.1	3.0	R	$\sqrt{3}$	1	1	1.7	1.7	∞
Probe positioner Mechanical Tolerance	E.6.2	2.0	R	$\sqrt{3}$	1	1	1.2	1.2	∞
Probe positioning with respect to Phantom Shell	E.6.3	1.0	R	$\sqrt{3}$	1	1	0.6	0.6	∞
Extrapolation, interpolation and integration Algorithms for Max. SAR Evaluation	E.5.2	1.5	R	$\sqrt{3}$	1	1	0.9	0.9	∞

检测结果/说明（续页）：

Results of test and additional explanation (continued page)

a	b	c	d	e= f(d,k)	f	g	h= c*f/e	i= c*g/e	k
Uncertainty Component	Sec.	Tol (+-%)	Prob. Dist.	Div.	Ci (1g)	Ci (10g)	1g Ui (+-%)	10g Ui (+-%)	Vi
Test sample Related									
Test sample positioning	E.4.2.1	1.5	N	1	1	1	1.5	1.5	N-1
Device Holder Uncertainty	E.4.1.1	5.0	N	1	1	1	5.0	5.0	
Output power Variation - SAR drift measurement	6.6.2	0.5	R	$\sqrt{3}$	1	1	0.3	0.3	∞
Phantom and Tissue Parameters									
Phantom Uncertainty (Shape and thickness tolerances)	E.3.1	4.0	R	$\sqrt{3}$	1	1	2.3	2.3	∞
Liquid conductivity - deviation from target value	E.3.2	0.6	R	$\sqrt{3}$	0.64	0.43	0.2	0.2	∞
Liquid conductivity - measurement uncertainty	E.3.3	2.5	N	1	0.64	0.43	1.6	1.1	M
Liquid permittivity - deviation from target value	E.3.2	4.2	R	$\sqrt{3}$	0.6	0.49	1.5	1.2	∞
Liquid permittivity - measurement uncertainty	E.3.3	2.5	N	1	0.6	0.49	1.5	1.2	M
Combined Standard Uncertainty			RSS				9.4	9.4	
Expanded Uncertainty (95% Confidence interval)			k				18.4	18.2	

检测结果/说明（续页）：

Results of test and additional explanation (continued page)

UNCERTAINTY FOR SYSTEM PERFORMANCE CHECK

a	b	c	d	e= f(d,k)	f	g	h= c*f/e	i= c*g/e	k
Uncertainty Component	Sec.	Tol (+- %)	Prob. Dist.	Div.	Ci (1g)	Ci (10g)	1g Ui (+-%)	10g Ui (+-%)	Vi
Measurement System									
Probe calibration	E.2.1	6.0	N	1	1	1	6.0	6.0	∞
Axial Isotropy	E.2.2	2.5	R	$\sqrt{3}$	$(1-Cp)^{1/2}$	$(1-Cp)^{1/2}$	1.0	1.0	∞
Hemispherical Isotropy	E.2.2	4.0	R	$\sqrt{3}$	\sqrt{Cp}	\sqrt{Cp}	1.6	1.6	∞
Boundary effect	E.2.3	1.0	R	$\sqrt{3}$	1	1	0.6	0.6	∞
Linearity	E.2.4	5.0	R	$\sqrt{3}$	1	1	2.9	2.9	∞
System detection limits	E.2.5	1.0	R	$\sqrt{3}$	1	1	0.6	0.6	∞
Readout Electronics	E.2.6	0.5	N	1	1	1	0.5	0.5	∞
Reponse Time	E.2.7	0.2	R	$\sqrt{3}$	1	1	0.1	0.1	∞
Integration Time	E.2.8	2.0	R	$\sqrt{3}$	1	1	1.2	1.2	∞
RF ambient Conditions	E.6.1	3.0	R	$\sqrt{3}$	1	1	1.7	1.7	∞
Probe positioner Mechanical Tolerance	E.6.2	2.0	R	$\sqrt{3}$	1	1	1.2	1.2	∞
Probe positioning with respect to Phantom Shell	E.6.3	1.0	R	$\sqrt{3}$	1	1	0.6	0.6	∞
Extrapolation, interpolation and integration Algorithms for Max. SAR Evaluation	E.5.2	1.5	R	$\sqrt{3}$	1	1	0.9	0.9	∞

检测结果/说明（续页）：

Results of test and additional explanation (continued page)

a	b	c	d	e= f(d,k)	f	g	h= c*f/e	i= c*g/e	k
Uncertainty Component	Sec.	Tol (+-%)	Prob. Dist.	Div.	Ci (1g)	Ci (10g)	1g Ui (+-%)	10g Ui (+-%)	Vi
Dipole									
Dipole axis to liquid Distance	8,E.4.2	1.0	N	$\sqrt{3}$	1	1	0.6	0.6	N-1
Input power and SAR drift measurement	8,6.6.2	0.5	R	$\sqrt{3}$	1	1	0.3	0.3	∞
Phantom and Tissue Parameters									
Phantom Uncertainty (Shape and thickness tolerances)	E.3.1	4.0	R	$\sqrt{3}$	1	1	2.3	2.3	∞
Liquid conductivity - deviation from target value	E.3.2	0.6	R	$\sqrt{3}$	0.64	0.43	0.2	0.2	∞
Liquid conductivity - measurement uncertainty	E.3.3	2.5	N	1	0.64	0.43	1.6	1.1	M
Liquid permittivity - deviation from target value	E.3.2	4.2	R	$\sqrt{3}$	0.6	0.49	1.5	1.2	∞
Liquid permittivity - measurement uncertainty	E.3.3	2.5	N	1	0.6	0.49	1.5	1.2	M
Combined Standard Uncertainty			RSS				7.9	7.8	
Expanded Uncertainty (95% Confidence interval)			k				15.4	15.2	

End