

FCC 47 CFR PART 27 SUBPART L

CERTIFICATION TEST REPORT

For

nextbook

Model No.: NXA8LTE116

FCC ID: S7JNXA8LTE116

Trademark: N/A

REPORT NO.: ES150110111E4

ISSUE DATE: March 11, 2015

Prepared for

SHENZHEN YIFANG DIGITAL TECHNOLOGY CO., LTD.

Building NO.22,23, Fifth Region, Baiwangxin Industrial Park, Songbai Rd., Nanshan,
Shenzhen518108, China

Prepared by

SHENZHEN EMTEK CO., LTD.

Bldg 69, Majialong Industry Zone, Nanshan District, Shenzhen,
Guangdong, China

TEL: 86-755-26954280

FAX: 86-755-26954282

TABLE OF CONTENTS

1 TEST RESULT CERTIFICATION3

2 EUT TECHNICAL DESCRIPTION4

3 SUMMARY OF TEST RESULT6

4 TEST METHODOLOGY7

4.1 GENERAL DESCRIPTION OF APPLIED STANDARDS7

4.2 MEASUREMENT EQUIPMENT USED7

4.3 DESCRIPTION OF TEST MODES8

5 FACILITIES AND ACCREDITATIONS9

5.1 FACILITIES9

5.2 LABORATORY ACCREDITATIONS AND LISTINGS9

6 TEST SYSTEM UNCERTAINTY10

7 SETUP OF EQUIPMENT UNDER TEST11

7.1 RADIO FREQUENCY TEST SETUP 111

7.2 RADIO FREQUENCY TEST SETUP 211

7.3 CONDUCTED EMISSION TEST SETUP12

7.4 SUPPORT EQUIPMENT12

8 TEST REQUIREMENTS13

8.1 RF OUTPUT POWER13

8.2 OCCUPIED BANDWIDTH19

8.3 FREQUENCY STABILITY MEASUREMENT35

8.4 EFFECTIVE ISOTROPIC RADIATED POWER40

8.5 RADIATED SPURIOUS EMISSION44

8.6 PEAK TO AVERAGE RATIO78

8.7 CONDUCTED EMISSION TEST93

8.8 ANTENNA APPLICATION98

1 TEST RESULT CERTIFICATION

Applicant: SHENZHEN YIFANG DIGITAL TECHNOLOGY CO., LTD.
Building NO.22,23, Fifth Region, Baiwangxin Industrial Park, Songbai Rd., Nanshan, Shenzhen518108, China

Manufacturer: SHENZHEN YIFANG DIGITAL TECHNOLOGY CO., LTD.
Building NO.22,23, Fifth Region, Baiwangxin Industrial Park, Songbai Rd., Nanshan, Shenzhen518108, China

Product Description: nextbook

Model Number: NXA8LTE116

File Number: ES150210111E4

Date of Test: February 11, 2015 to March 11, 2015

Measurement Procedure Used:

APPLICABLE STANDARDS	
STANDARD	TEST RESULT
FCC 47 CFR Part 2, Subpart J FCC 47 CFR Part 27, Subpart L	PASS

The above equipment was tested by SHENZHEN EMTEK CO., LTD. The test data, data evaluation, test procedures, and equipment configurations shown in this report were made in accordance with the procedures given in ANSI C63.4 (2014) and the energy emitted by the sample EUT tested as described in this report is in compliance with the requirements of FCC Rules Part 2 and Part 27.

The test results of this report relate only to the tested sample identified in this report.

Date of Test : February 11, 2015 to March 11, 2015

Jack Li

Prepared by : Jack Li /Editor

Joe Xia

Reviewer : Joe Xia/Supervisor

[Signature]

Approve & Authorized Signer : Lisa Wang/Manager

Lisa Wang/Manager

2 EUT TECHNICAL DESCRIPTION

Characteristics	Description
Bandwidth:	LTE Band 4: 3MHz / 5MHz / 10MHz / 15MHz / 20MHz LTE Band 13: 5MHz / 10MHz
Tx Frequency:	LTE Band 4 : 1710.7 MHz ~ 1754.3 MHz LTE Band 13 : 779.5 MHz ~ 784.5 MHz
Rx Frequency:	LTE Band 4 : 2110.7 MHz ~ 2154.3 MHz LTE Band 13 : 748.5 MHz ~ 753.5 MHz
Modulation:	QPSK / 16QAM
Maximum Output Power to Antenna:	23.52dBm
Antenna Type:	<input checked="" type="checkbox"/> integral antenna; <input type="checkbox"/> antenna connector
Antenna Port:	<input type="checkbox"/> Ant1 ; <input checked="" type="checkbox"/> Ant2 ;
Antenna Gain(Main Antenna):	2dBi for LTE Band 4; 0.5dBi for LTE Band 13;
Antenna Gain (Auxiliary Antenna):	0.5dBi for LTE Band 4; -2.5dBi for LTE Band 13;
Power supply:	<input checked="" type="checkbox"/> DC supply: DC 3.7V internal rechargeable lithium battery or DC 5V from AC Adapter
	<input checked="" type="checkbox"/> Adapter supply: Model: ACDC-10BAU Input: 100-240V, 50-60Hz, 0.5A Output: DC 5V, 2A
Temperature Range:	-10°C ~ +55°C

Note: for more details, please refer to the User's manual of the EUT.

Modified Information

Version.	Summary	Date of Rev.	Report No.
Ver.1.0	Original Report	2015-03-10	ES150210111E4

3 SUMMARY OF TEST RESULT

FCC Part Clause	Test Parameter	Verdict	Remark
§2.1046(a)	RF Power Output	PASS	
§2.1049(h) §27.53(h)(3)	Occupied Bandwidth	PASS	
§2.1055(a)(1) §27.54 §2.1055(d)(1)	Frequency Stability	PASS	
§2.1046(a) §27.50(b)(10) §27.50(d)(4)	ERP/ EIRP measurement	PASS	
§2.1053 §27.53(c)(2) §27.53(f) §27.53(h)	Radiated Spurious Emission Conducted Band Edge	PASS	
§27.50(i) (B)	Peak to Average Ratio	PASS	
§2.1053 §27.53(c)(2) §27.53(f) §27.53(g)	Conducted Spurious Emission	PASS	
§27.56	Antenna Application	PASS	
NOTE1: N/A (Not Applicable) NOTE2: Both conducted and radiated testing were performed according to the procedures document of ANSI C63.4 (2014) and FCC CFR 47.1046, 2.1047, 2.1049, 2.1051, 2.1053, 2.1055 and 2.1057. The Output power Procedure of KDB941225 (SAR Measurement Procedures for 3G devices, WCDMA / HSPA / LTE) was used for EUT and Base station setting. KDB971168 D01 Power Meas license Digital System v01 as the supplemental guideline to conduct the measurement, including Peak to Power Average Ratio, Average Power over the fundamental signal BW (EIRP/ERP) and Signal Bandwidth.			

4 TEST METHODOLOGY

4.1 GENERAL DESCRIPTION OF APPLIED STANDARDS

According to its specifications, the EUT must comply with the requirements of the following standards:

FR Part 2, 27

ANSI / TIA / EIA-603-C-2014

FCC KDB 971168 D01 Power Meas. License Digital Systems v02r02

4.2 MEASUREMENT EQUIPMENT USED

4.2.1 Conducted Emission Test Equipment

EQUIPMENT TYPE	MFR	MODEL NUMBER	SERIAL NUMBER	LAST CAL.
Test Receiver	Rohde & Schwarz	ESCS30	828985/018	05/17/2014
L.I.S.N.	Schwarzbeck	NNLK8129	8129203	05/17/2014
50Ω Coaxial Switch	Anritsu	MP59B	M20531	N/A
Pulse Limiter	Rohde & Schwarz	ESH3-Z2	100006	05/17/2014
Voltage Probe	Rohde & Schwarz	TK9416	N/A	05/17/2014
I.S.N	Rohde & Schwarz	ENY22	1109.9508.02	05/17/2014

4.2.2 Radiated Emission Test Equipment

EQUIPMENT TYPE	MFR	MODEL NUMBER	SERIAL NUMBER	LAST CAL.
EMI Test Receiver	Rohde & Schwarz	ESU	1302.6005.26	05/17/2014
Pre-Amplifier	HP	8447D	2944A07999	05/17/2014
Bilog Antenna	Schwarzbeck	VULB9163	142	05/17/2014
Loop Antenna	ARA	PLA-1030/B	1029	05/17/2014
Horn Antenna	Schwarzbeck	BBHA 9170	BBHA9170399	05/17/2014
Horn Antenna	Schwarzbeck	BBHA 9120	D143	05/17/2014
Cable	Schwarzbeck	AK9513	ACRX1	05/17/2014
Cable	Rosenberger	N/A	FP2RX2	05/17/2014
Cable	Schwarzbeck	AK9513	CRPX1	05/17/2014
Cable	Schwarzbeck	AK9513	CRRX2	05/17/2014

4.2.3 Radio Frequency Test Equipment

EQUIPMENT TYPE	MFR	MODEL NUMBER	SERIAL NUMBER	LAST CAL.
Spectrum Analyzer	Agilent	E4407B	88156318	05/17/2014
Power meter	Anritsu	ML2495A	0824006	05/17/2014
Power sensor	Anritsu	MA2411B	0738172	05/17/2014
Temperature & Humidity Chamber	YINHE	SDH0525F	2003003	05/17/2014
EMI Test Receiver	Rohde & Schwarz	FSV40	132.1-3008K39-100967-AP	05/17/2014
Wideband Radio Communication Tester	R&S	CMW500	1201.0002K50-140822zk	05/17/2014

Remark: Each piece of equipment is scheduled for calibration once a year.

4.3 DESCRIPTION OF TEST MODES

The EUT has been tested under its typical operating condition.

The EUT configuration for testing is installed on RF field strength measurement to meet the Commissions requirement and operating in a manner which intends to maximize its emission characteristics in a continuous normal application.

The Transmitter was operated in the normal operating mode. The TX frequency was fixed which was for the purpose of the measurements.

Pre-defined engineering program for regulatory testing used to control the EUT for staying in continuous transmitting, Linking to simulator.

Test of channel included the lowest and middle and highest frequency to perform the test, then record on this report. This test report applies for LTE Band 4 and Band 13.

The EUT was pretested with 3 orientations placed on the table for the radiated emission measurement –X, Y, and Z-plane. The Z-plane results were found as the worst case and were shown in this report.

The evaluation of Test Mode as configured in UE presented on the Test Report:

The Measurement Data of field strength of spurious emission with respect to supported configuration of given application (Transmission Band, Modulation Scheme, Resource Block) have been pre-scanned, and the result that yields in the highest emission close to the limit are presented on the test report. In comparison among all Out of Band Emission at Antenna Terminal and Bandedge in the variety of combination on LTE band 4 & 13, respectively, It's revealed to generate the highest emission at 3M, 5M, 10M, 15MHz Transmission Bandwidth for band LTE 4 while RB size = 1 with 0 offset and RB size = 1 with 99 offset for 20MHz of LTE band 4. The highest emission at 5MHz and 10MHz transmission Bandwidth for LTE band 13 with RB size =1 with 24 offset and RB size = 1 with 0 offset. Be aware of that only data measurement that yields the worst measurement with supported modulation scheme (QPSK, 16QAM) are shown on the corresponding section.

The evaluation of Test band and frequency as configured in UE presented:

According to 3GPP TS 36.508 V9.5.0 ,For Signalling testing, E-UTRA frequency to be tested is mid range and E-UTRA channel bandwidth to be tested is 5MHz for all operating bands for all test cases as the default configuration unless specific channel bandwidth is specified for the operating band below:

For Band 13 and 20, channel bandwidth to be tested is 10 MHz as the default configuration.

For RF testing, E-UTRA frequencies to be tested are low range, mid range and high range for all supported operating bands by default. E-UTRA channel bandwidths to be tested are lowest bandwidth, 5MHz bandwidth and highest bandwidth for all supported operating bands by default. Actual test configurations are specified case by case and stated in test case itself as the initial conditions.

The lowest bandwidth, 5MHz bandwidth and highest bandwidth are selected from the combined table which includes nominal and additional channel bandwidth.

In the case 5MHz bandwidth is not supported by the UE, E-UTRA channel bandwidth to be tested is only lowest bandwidth and highest bandwidth.

In addition to the default channel bandwidths to be tested specified above, for Bands 4 and 20, an industry requirement of testing in 10MHz channel bandwidth is allowed for test cases in chapters 6 and 7 in TS 36.521-1 [21].

For RF testing, an industry requirement of testing in 10MHz channel bandwidth is requested for Bands 4 and 20 for test cases in chapters 6 and 7 in TS 36.521-1[21], changing the existing test points to address this is being discussed in RAN5 and will be considered pending technical justification.

TEST BAND	TEST BANDWIDTH
Band 4	3MHz, 5MHz , 20MHz
Band 13	5MHz , 10MHz

Test condition description:

Normal Means $T_{norm} (^{\circ}C)=25$ and $V_{norm}=3.7$; L.V means $V_{min}=3.2v$; H.V means $V_{max}=4.2v$;

L.T means $T_{min} (^{\circ}C)=0$; H.T means $T_{max} (^{\circ}C)=40$;

5 FACILITIES AND ACCREDITATIONS

5.1 FACILITIES

All measurement facilities used to collect the measurement data are located at

Bldg 69, Majialong Industry Zone District, Nanshan District, Shenzhen, China

The sites are constructed in conformance with the requirements of ANSI C63.7, ANSI C63.4 and CISPR Publication 22.

5.2 LABORATORY ACCREDITATIONS AND LISTINGS

Site Description

EMC Lab.

- : Accredited by CNAS, 2013.10.29
The certificate is valid until 2016.10.28
The Laboratory has been assessed and proved to be in compliance with CNAS-CL01: 2006(identical to ISO/IEC17025: 2005)
The Certificate Registration Number is L2291
- : Accredited by TUV Rheinland Shenzhen, 2010.5.25
The Laboratory has been assessed according to the requirements ISO/IEC 17025.
- : Accredited by FCC, October 28, 2010
The Certificate Registration Number is 406365.
- : Accredited by FCC, February 28, 2013
The Certificate Registration Number is 709623.
- : Accredited by Industry Canada, May 24, 2008
The Certificate Registration Number is 4480A-2

6 TEST SYSTEM UNCERTAINTY

The following measurement uncertainty levels have been estimated for tests performed on the apparatus:

Parameter	Uncertainty
RF Output Power Test	±1.42dB
Conducted Emissions Test	±2.74dB
Radiated Emission Test	±4.27dB
Occupied Bandwidth Test	±1.55dB
Band Edge Test	±1.55dB
Peak to Average Ratio	±1.55dB
All emission, radiated	±3dB
Antenna Port Emission	±3dB
Temperature	±0.5°C
Humidity	±3%

Measurement Uncertainty for a level of Confidence of 95%

7 SETUP OF EQUIPMENT UNDER TEST

7.1 RADIO FREQUENCY TEST SETUP 1

The WWAN component's antenna ports(s) of the EUT are connected to the measurement instrument per an appropriate attenuator. Pre-defined engineering program for regulatory testing used to control the EUT for staying in continuous transmitting, Linking to simulator.

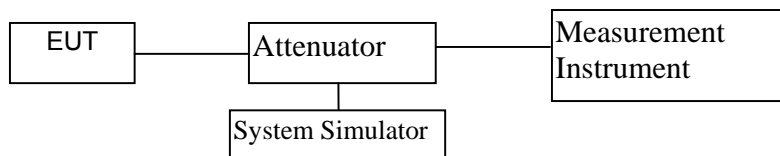

7.2 RADIO FREQUENCY TEST SETUP 2

The test site semi-anechoic chamber has met the requirement of NSA tolerance 4 dB according to the standards: ANSI C63.4. The test distance is 3m. The setup is according to the requirements in Section 13.1.4.1 of ANSI C63.4-2014 and CAN/CSA-CEI/IEC CISPR 22.

The maximal emission value is acquired by adjusting the antenna height, polarisation and turntable azimuth. Normally, the height range of antenna is 1 m to 4 m, the azimuth range of turntable is 0° to 360°, and the receive antenna has two polarizations Vertical (V) and Horizontal (H).

(b) Radiated Emission Test Set-Up, Frequency Below 1000MHz

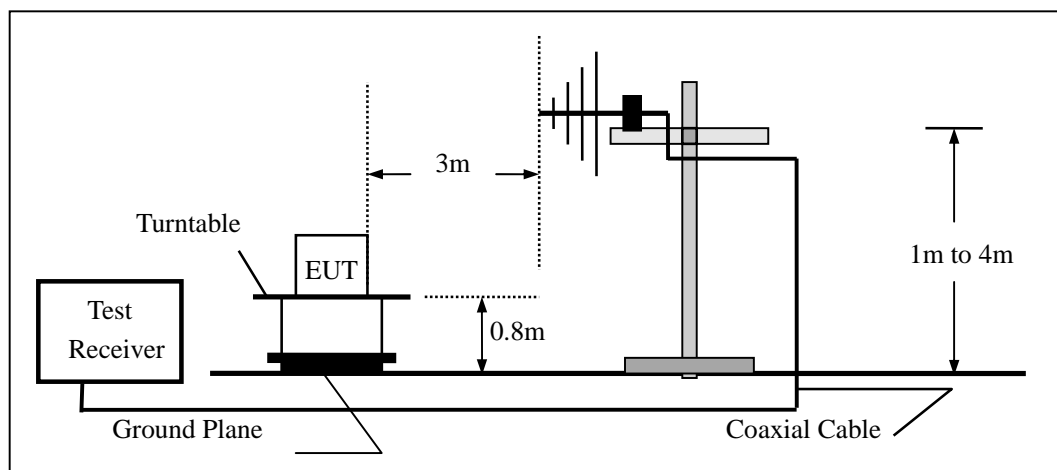

(c) Radiated Emission Test Set-Up, Frequency above 1000MHz

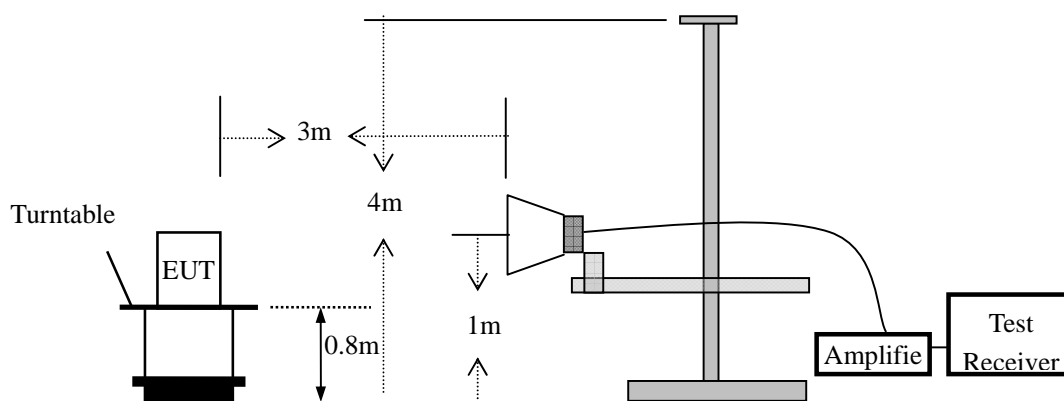

7.3 CONDUCTED EMISSION TEST SETUP

The mains cable of the EUT (nextbook) must be connected to LISN. The LISN shall be placed 0.8 m from the boundary of EUT and bonded to a ground reference plane for LISN mounted on top of the ground reference plane. This distance is between the closest points of the LISN and the EUT. All other units of the EUT and associated equipment shall be at least 0.8m from the LISN.

Ground connections, where required for safety purposes, shall be connected to the reference ground point of the LISN and, where not otherwise provided or specified by the manufacturer, shall be of same length as the mains cable and run parallel to the mains connection at a separation distance of not more than 0.1 m.

According to the requirements in Section 13.1.4.1 of ANSI C63.10-2013 Conducted emissions from the EUT measured in the frequency range between 0.15 MHz and 30 MHz using CISPR Quasi-Peak and average detector mode.

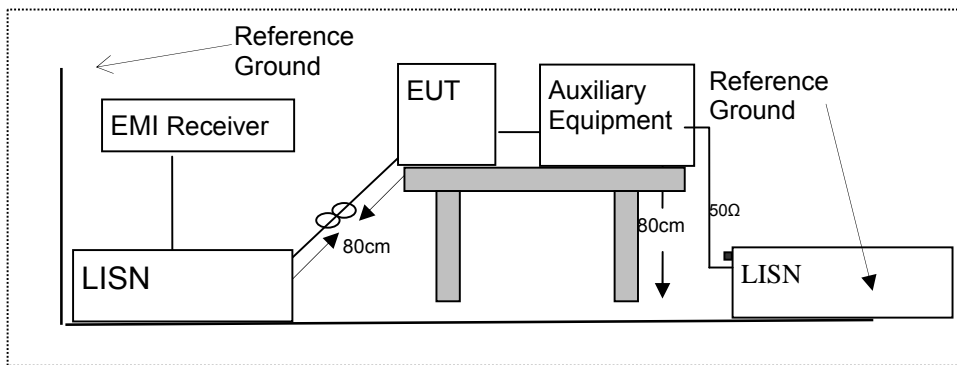

7.4 SUPPORT EQUIPMENT

Item	Equipment	Mfr/Brand	Model/Type No.	Series No.	Note

Notes:

1. All the equipment/cables were placed in the worst-case configuration to maximize the emission during the test.
2. Grounding was established in accordance with the manufacturer's requirements and conditions for the intended use.

8 TEST REQUIREMENTS

8.1 RF OUTPUT POWER

8.1.1 Applicable Standard

According to FCC Part 2.1046, FCC Part 27.50(b)(10) and FCC Part 27.50(d)(4).

8.1.2 Conformance Limit

For band 4 output power limit:

FCC Part 27.50 (d)(4): Fixed, mobile, and portable (hand-held) stations operating in the 1710-1755 MHz band are limited to 1 watt EIRP. Fixed stations operating in this band are limited to a maximum antenna height of 10 meters above ground. Mobile and portable stations operating in this band must employ a means for limiting power to the minimum necessary for successful communications.

For band 13 output power limit:

FCC Part 27.50 (b)(10): Portable stations (hand-held devices) transmitting in the 746-757 MHz, 776-788 MHz, and 805-806 MHz bands are limited to 3 watts ERP

8.1.3 Test Configuration

Test according to clause 7.1 radio frequency test setup 1

8.1.4 Test Procedure

The RF output of the transmitter was connected to base station simulator.

Set EUT at maximum average power by base station simulator.

Set RBW = 1-5% of the OBW, not to exceed 1 MHz.

Set VBW $\geq 3 \times$ RBW.

Number of points in sweep $\geq 2 \times$ span / RBW. (This gives bin-to-bin spacing \leq RBW/2, so that narrowband signals are not lost between frequency bins.)

Sweep time = auto.

Detector = RMS (power averaging).

Set sweep trigger to "free run".

Trace average at least 100 traces in power averaging (i.e., RMS) mode; however, the number of traces to be averaged shall be increased above 100 as needed such that the average accurately represents the true average over the on and off periods of the transmitter.

Compute power by integrating the spectrum across the OBW of the signal using the instrument's band power measurement function with band limits set equal to the OBW band edges. If the instrument does not have a band power function, sum the spectrum levels (in power units) at intervals equal to the RBW extending across the entire OBW of the spectrum.

Add $10 \log(1/x)$, where x is the duty cycle, to the measured power in order to compute the average power during the actual transmission times (because the measurement represents an average over both the on and off times of the transmission). For example, add $10 \log(1/0.25) = 6$ dB if the duty cycle is a constant 25%.

Measure lowest, middle, and highest channels for each bandwidth and different modulation.

Measure and record the results in the test report.

8.1.5 Test Results

All the modulation modes were tested, the data of the worst mode are described in the following table.

Temperature: 24°C
Humidity: 53 %

Test Date: March 2, 2015
Test By: KING KONG

Mode	Band Width (MHz)	Modulation	Uplink Channel Number	Frequency (MHz)	RB Size	RB Offset	Average Power (dBm)
LTE Band 4	20MHz	QPSK	20050	1720	1	0	23.15
					1	50	23.18
					1	99	23.38
					50	0	22.88
					50	50	23.01
			100	0	22.91		
			20175	1732.5	1	0	23.21
					1	50	23.19
					1	99	23.51
					50	0	22.89
					50	50	23.11
			100	0	22.96		
			20300	1745	1	0	23.47
					1	50	23.40
					1	99	23.08
		50			0	23.11	
		50			50	23.00	
		100	0	22.76			
		16-QAM	20050	1720	1	0	22.82
					1	50	22.82
					1	99	23.20
					24	0	22.99
					24	76	23.10
			100	0	23.07		
			20175	1732.5	1	0	23.00
					1	50	22.80
					1	99	23.18
					75	0	23.00
					75	25	23.06
			100	0	23.04		
20300	1745		1	0	23.22		
			1	49	23.19		
			1	99	23.19		
		75	0	22.92			
		75	25	22.76			
100	0	22.79					
VERDICT					PASS		

Temperature: 24°C
Humidity: 53 %

Test Date: March 2, 2015
Test By: KING KONG

Mode	Band Width (MHz)	Modulation	Uplink Channel Number	Frequency (MHz)	RB Size	RB Offset	Average Power (dBm)
LTE Band 4	5MHz	QPSK	19975	1712.5	1	0	23.46
					1	13	23.31
					1	24	23.37
					10	0	22.95
					10	15	22.99
					25	0	23.02
			20175	1732.5	1	0	23.24
					1	12	23.07
					1	24	23.28
					10	0	22.88
					10	6	22.97
					25	0	22.85
			20375	1752.5	1	0	23.01
					1	13	22.92
					1	24	22.95
		10			0	22.76	
		10			6	22.64	
		25			0	22.60	
		16-QAM	19975	1712.5	1	0	23.20
					1	13	23.17
					1	24	23.06
					8	0	23.20
					8	17	23.20
					25	0	23.11
			20175	1732.5	1	0	23.23
					1	13	23.20
					1	24	23.24
					8	0	23.09
					8	17	23.06
					25	0	23.01
20375	1752.5		1	0	22.78		
			1	13	22.62		
			1	24	22.68		
		8	0	22.82			
		8	17	22.89			
		25	0	22.87			
VERDICT					PASS		

Temperature: 24°C
Humidity: 53 %

Test Date: March 2, 2015
Test By: KING KONG

Mode	Band Width (MHz)	Modulation	Uplink Channel Number	Frequency (MHz)	RB Size	RB Offset	Average Power (dBm)
LTE Band 4	3MHz	QPSK	19965	1711.5	1	0	23.47
					1	8	23.41
					1	14	23.34
					10	0	23.09
					10	5	23.11
			15	0	23.06		
			20175	1732.5	1	0	23.41
					1	8	23.24
					1	14	23.34
					10	0	22.96
					10	5	23.01
			20385	1753.5	15	0	23.12
					1	0	23.03
					1	7	22.94
					1	14	22.95
		10			0	22.62	
		16-QAM	19965	1711.5	10	5	22.75
					15	0	22.69
					1	0	23.09
					1	8	23.00
					1	14	23.00
			20175	1732.5	6	0	23.52
					6	9	23.44
					15	0	23.13
					1	0	23.13
					1	8	23.20
			20385	1753.5	1	14	23.24
					6	0	23.29
					6	4	23.36
					15	0	23.02
1	0				22.84		
VERDICT					PASS		

Temperature: 24°C
Humidity: 53 %

Test Date: March 2, 2015
Test By: KING KONG

Mode	Band Width (MHz)	Modulation	Uplink Channel Number	Frequency (MHz)	RB Size	RB Offset	Average Power (dBm)
LTE Band 13	5MHz	QPSK	23205	779.5	1	0	23.18
					1	13	23.11
					1	24	23.04
					15	0	22.58
					15	10	22.76
			25	0	22.63		
			23230	782	1	0	23.13
					1	13	23.07
					1	24	23.09
					10	0	22.71
					10	15	22.58
			23255	784.5	25	0	22.61
					1	0	23.05
					1	13	23.05
					1	24	22.68
		10			0	22.68	
		16-QAM	23205	779.5	10	15	22.64
					25	0	22.65
					1	0	22.74
					1	13	22.60
					1	24	22.62
			23230	782	8	0	23.06
					8	17	23.05
					25	0	22.63
					1	0	22.16
					1	12	22.42
			23255	784.5	1	24	22.12
					8	0	23.01
					8	17	23.03
					25	0	22.86
1	0				22.97		
VERDICT					PASS		

Temperature: 24°C
Humidity: 53 %

Test Date: March 2, 2015
Test By: KING KONG

Mode	Band Width (MHz)	Modulation	Uplink Channel Number	Frequency (MHz)	RB Size	RB Offset	Average Power (dBm)				
LTE Band 13	10MHz	QPSK	23230	782	1	0	22.89				
					1	25	22.89				
					1	49	22.71				
					25	0	22.64				
					25	25	22.62				
					50	0	22.62				
	16-QAM	23230	782	1	0	22.88					
				1	24	22.88					
				1	49	22.86					
				30	0	22.89					
				30	20	22.84					
				50	0	22.81					
				VERDICT				PASS			

8.2 OCCUPIED BANDWIDTH

8.2.1 Applicable Standard

According to FCC Part 2.1049(h)

8.2.2 Conformance Limit

No limit requirement.

8.2.3 Test Configuration

Test according to clause 7.1 radio frequency test setup 1

8.2.4 Test Procedure

The 99% occupied bandwidth is the width of a frequency band such that, below the lower and above the upper frequency limits, the mean powers emitted are each equal to a specified percentage 0.5% of the total mean transmitted power.

The emission bandwidth is defined as the width of the signal between two points, located at the 2 sides of the carrier frequency, outside of which all emissions are attenuated at least 26 dB below the transmitter power.

The 99% occupied bandwidth and 26 dB bandwidth of the Low channel, middle channel and High channel for the highest RF powers were measured.

The testing follows FCC KDB 971168 v02r02 Section 4.2.

■ The following procedure shall be used for measuring (99 %) power bandwidth

a) The spectrum analyzer center frequency is set to the nominal EUT channel center frequency. The frequency span for the spectrum analyzer shall be set wide enough to capture all modulation products including the emission skirts (i.e., two to five times the OBW).

b) The nominal IF filter bandwidth (3 dB RBW) shall be in the range of 1 to 5 % of the anticipated OBW, and the VBW shall be at least 3 times the RBW.

c) Set the reference level of the instrument as required to keep the signal from exceeding the maximum input mixer level for linear operation. In general, the peak of the spectral envelope must be at least 10log (OBW / RBW) below the reference level.

d) NOTE—Steps a) through c) may require iteration to adjust within the specified tolerances.

e) Set the detection mode to peak, and the trace mode to max hold..

f) Use the 99 % power bandwidth function of the spectrum analyzer (if available) and report the measured bandwidth.

g) If the instrument does not have a 99 % power bandwidth function, the trace data points are to be recovered and directly summed in linear power terms. The recovered amplitude data points, beginning at the lowest frequency, are placed in a running sum until 0.5 % of the total is reached; that frequency is recorded as the lower frequency. The process is repeated until 99.5 % of the total is reached; that frequency is recorded as the upper frequency. The 99 % power bandwidth is the difference between these two frequencies.

h) The OBW shall be reported by providing plot(s) of the measuring instrument display. The frequency and amplitude axes and scale shall be clearly labeled. Tabular data may be reported in addition to the plot(s).

■ The reference value is the highest level of the spectral envelope of the modulated signal.

a) The spectrum analyzer center frequency is set to the nominal EUT channel center frequency. The span range for the spectrum analyzer shall be between two and five times the anticipated OBW.

b) The nominal resolution bandwidth (RBW) shall be in the range of 1 to 5 % of the anticipated OBW, and the VBW shall be at least 3 times the RBW.

c) Set the reference level of the instrument as required to prevent the signal from exceeding the maximum input mixer level for linear operation. In general, the peak of the spectral envelope must be at least 10log (OBW / RBW) below the reference level.

d) NOTE—Steps a) through c) may require iteration to adjust within the specified tolerances.

e) The dynamic range of the spectrum analyzer at the selected RBW shall be at least 10 dB below the target “-X dB down” requirement (i.e., if the requirement calls for measuring the -26 dB OBW, the spectrum

analyzer noise floor at the selected RBW shall be at least 36 dB below the reference value).

f) Set the detection mode to peak, and the trace mode to max hold.

g) Determine the reference value: Set the EUT to transmit a modulated signal. Allow the trace to stabilize. Set the spectrum analyzer marker to the highest level of the displayed trace (this is the reference value).

h) Determine the “-X dB down amplitude” as equal to (Reference Value – X). Alternatively, this calculation can be performed by the analyzer by using the marker-delta function.

i) Place two markers, one at the lowest and the other at the highest frequency of the envelope of the spectral display such that each marker is at or slightly below the “-X dB down amplitude” determined in step g). If a marker is below this “-X dB down amplitude” value it shall be placed as close as possible to this value. The OBW is the positive frequency difference between the two markers.

j) The occupied bandwidth shall be reported by providing plot(s) of the measuring instrument display. The frequency and amplitude axes and scale shall be clearly labeled. Tabular data may be reported in addition to the plot(s).

8.2.5 Test Results

Temperature:	24 °C	Test Date:	March 2, 2015
Humidity:	53 %	Test By:	KING KONG

Mode	Uplink Channel Number	Frequency (MHz)	Bandwidth (MHz)	Modulation	26dB Bandwidth (MHz)	99% Bandwidth (MHz)
LTE Band 4	20050	1720.00	20	QPSK	21.634	18.7293
	20175	1732.50	20		21.376	18.6112
	20300	1745.00	20		21.443	18.6752
	20050	1720.00	20	16-QAM	21.802	18.6875
	20175	1732.50	20		21.663	18.5879
	20300	1745.00	20		21.676	18.6747

Temperature:	24 °C	Test Date:	March 2, 2015
Humidity:	53 %	Test By:	KING KONG

Mode	Uplink Channel Number	Frequency (MHz)	Bandwidth (MHz)	Modulation	26dB Bandwidth (MHz)	99% Bandwidth (MHz)
LTE Band 4	19975	1712.50	5	QPSK	4.987	4.5372
	20175	1732.50	5		5.040	4.5216
	20375	1752.50	5		5.031	4.5176
	19975	1712.50	5	16-QAM	5.020	4.5189
	20175	1732.50	5		5.058	4.5338
	20375	1752.50	5		5.028	4.5087

Temperature: 24 °C
Humidity: 53 %

Test Date: March 2, 2015
Test By: KING KONG

Mode	Uplink Channel Number	Frequency (MHz)	Bandwidth (MHz)	Modulation	26dB Bandwidth (MHz)	99% Bandwidth (MHz)
LTE Band 4	19965	1711.5	3	QPSK	3.152	2.7750
	20175	1732.5	3		3.100	2.7680
	20385	1753.5	3		3.117	2.7534
	19965	1711.5	3	16-QAM	3.137	2.7624
	20175	1732.5	3		3.122	2.7709
	20385	1753.5	3		3.109	2.7562

Temperature: 24 °C
Humidity: 53 %

Test Date: March 2, 2015
Test By: KING KONG

Mode	Uplink Channel Number	Frequency (MHz)	Bandwidth (MHz)	Modulation	26dB Bandwidth (MHz)	99% Bandwidth (MHz)
LTE Band 13	23205	779.5	5	QPSK	5.050	4.5399
	23230	782	5		5.068	4.5555
	23255	784.5	5		5.000	4.5163
	23205	779.5	5	16-QAM	5.026	4.5266
	23230	782	5		5.028	4.5253
	23255	784.5	5		5.073	4.5131

Mode	Uplink Channel Number	Frequency (MHz)	Bandwidth (MHz)	Modulation	26dB Bandwidth (MHz)	99% Bandwidth (MHz)
LTE Band 13	20175	1732.50	10	QPSK	10.390	9.1215
	20175	1732.50	10	16-QAM	10.288	9.1415

All the modulation modes were tested, the data of the worst mode are described in the following table.

Test Model	99% Occupied Bandwidth & 26dB Bandwidth	
	LTE Band 4	
	Low Channel /20MHz	QPSK/Full RB

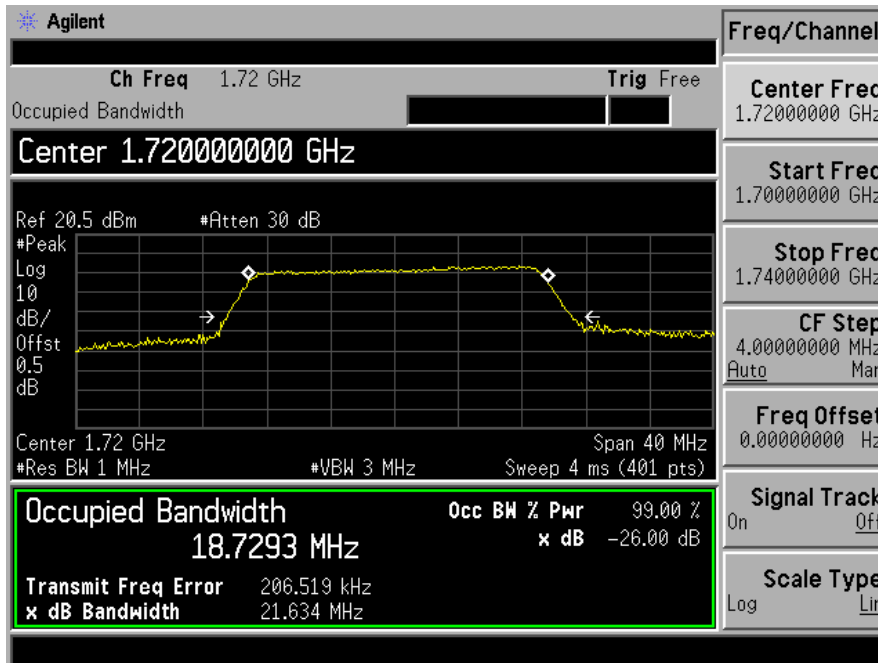

Test Model	99% Occupied Bandwidth & 26dB Bandwidth	
	LTE Band 4	
	Low Channel/20MHz	16-QAM/Full RB

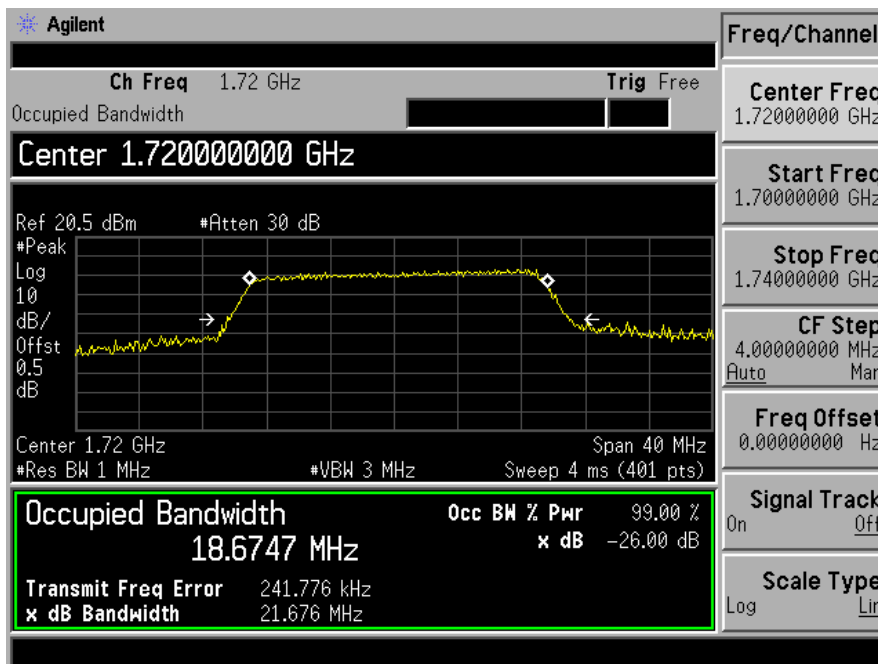

Test Model	99% Occupied Bandwidth & 26dB Bandwidth	
	LTE Band 4	
	Middle Channel /20MHz	QPSK/Full RB

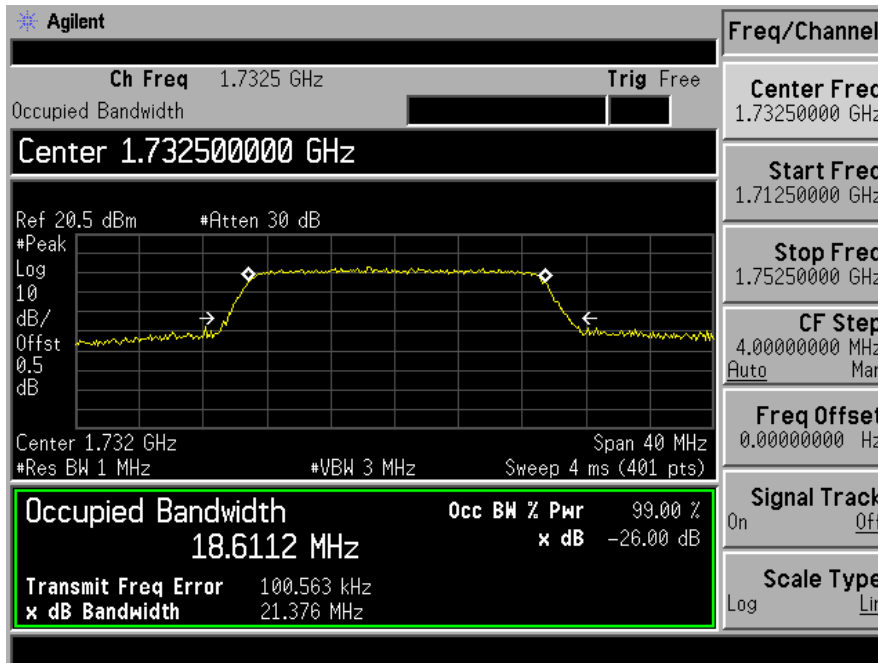

Test Model	99% Occupied Bandwidth & 26dB Bandwidth	
	LTE Band 4	
	Middle Channel /20MHz	16-QAM/Full RB

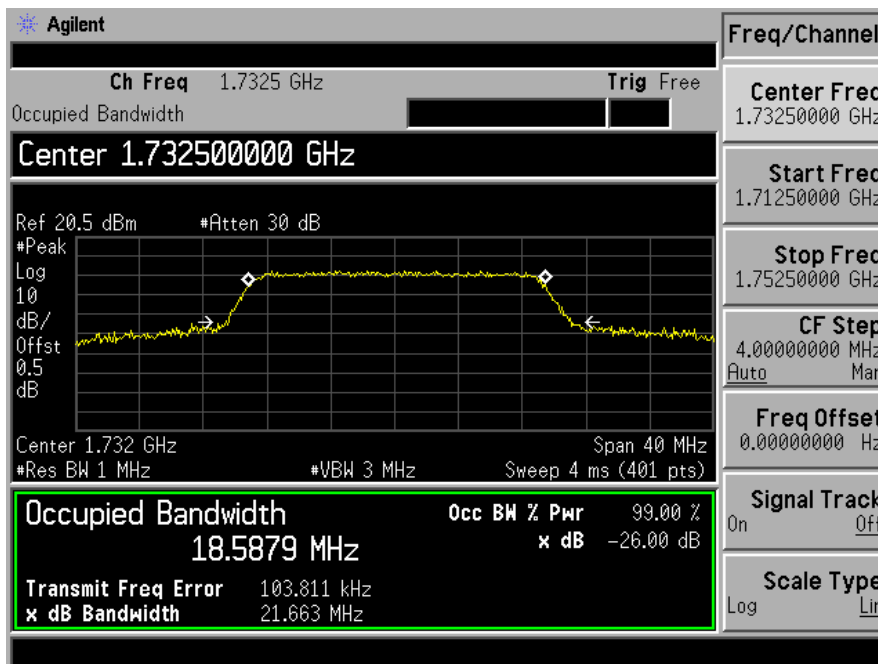

Test Model	99% Occupied Bandwidth & 26dB Bandwidth	
	LTE Band 4	
	High Channel /20MHz	QPSK/Full RB

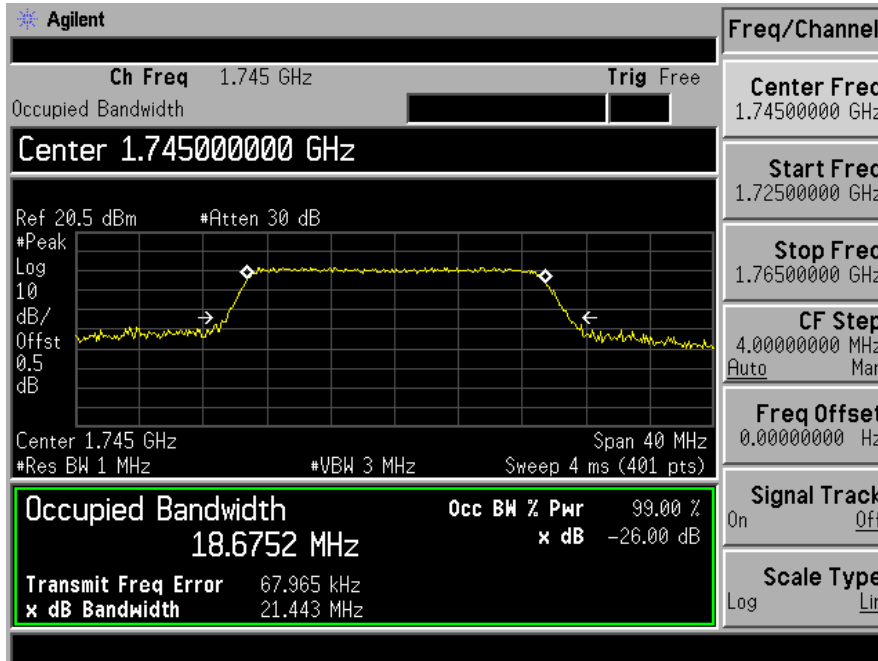

Test Model	99% Occupied Bandwidth & 26dB Bandwidth	
	LTE Band 4	
	High Chanel /20MHz	16-QAM/Full RB

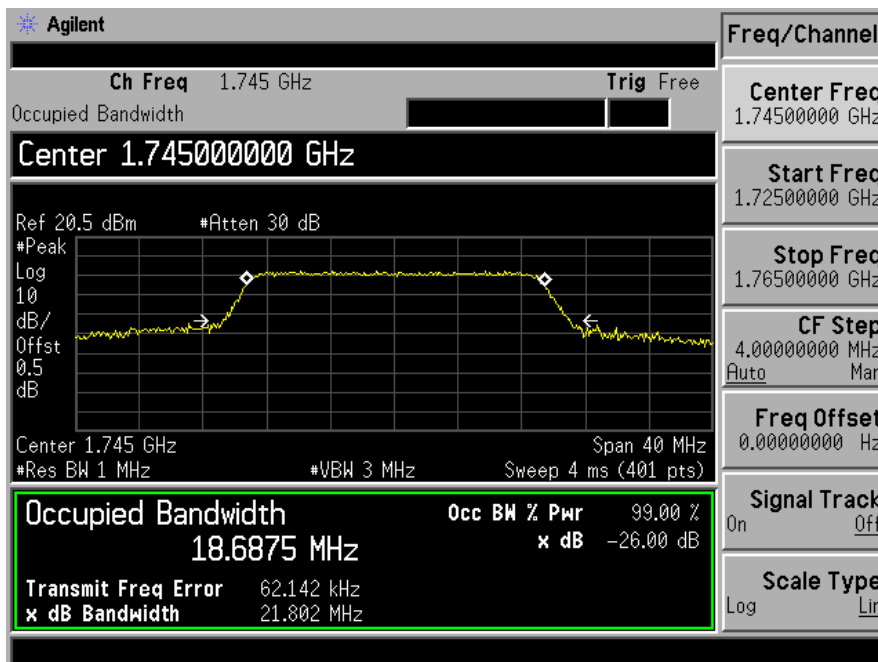

Test Model	99% Occupied Bandwidth & 26dB Bandwidth	
	LTE Band 4	
	Low Channel /5MHz	QPSK/Full RB

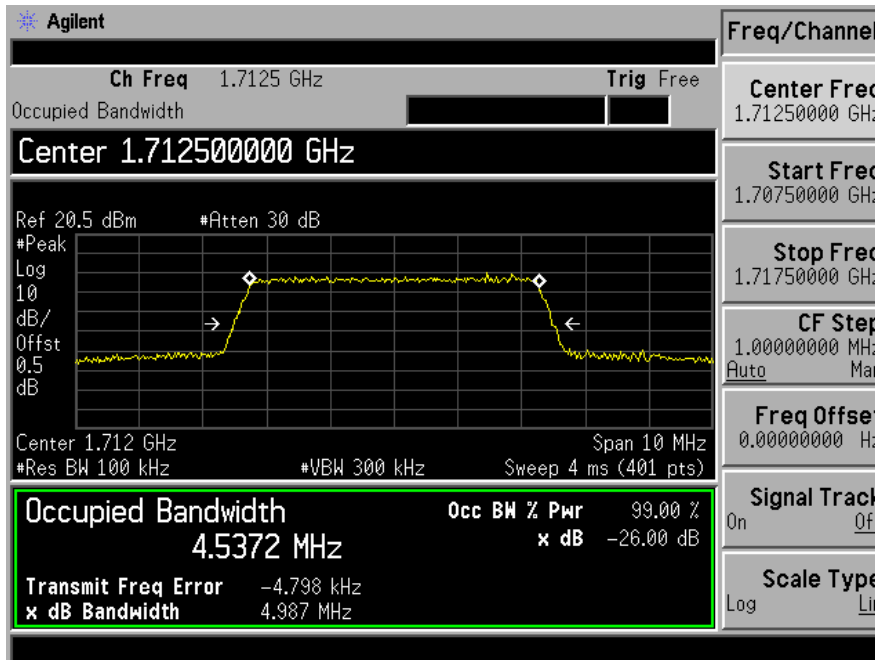

Test Model	99% Occupied Bandwidth & 26dB Bandwidth	
	LTE Band 4	
	Low Channel/5MHz	16-QAM/Full RB

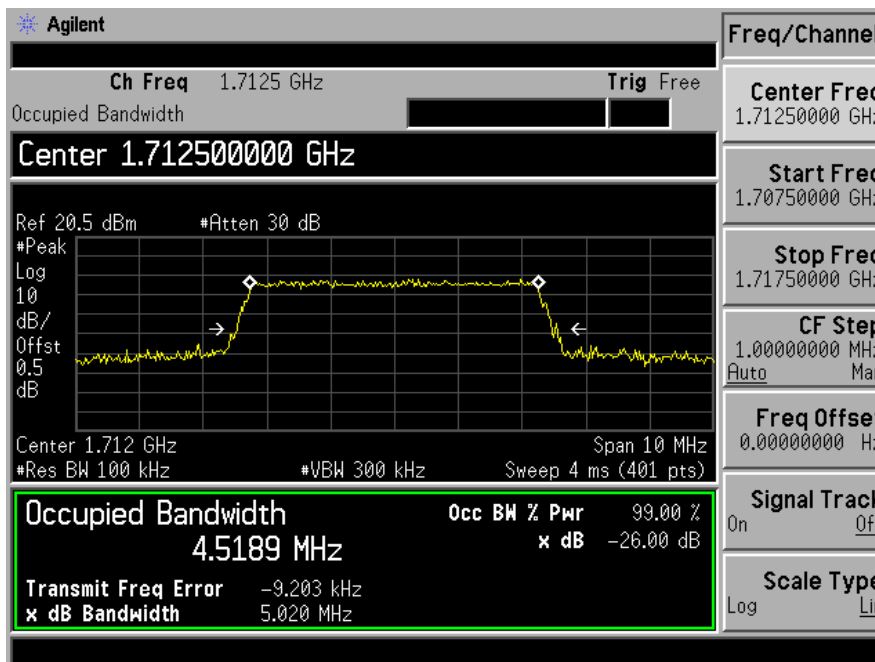

Test Model	99% Occupied Bandwidth & 26dB Bandwidth	
	LTE Band 4	
	Middle Channel /5MHz	QPSK/Full RB

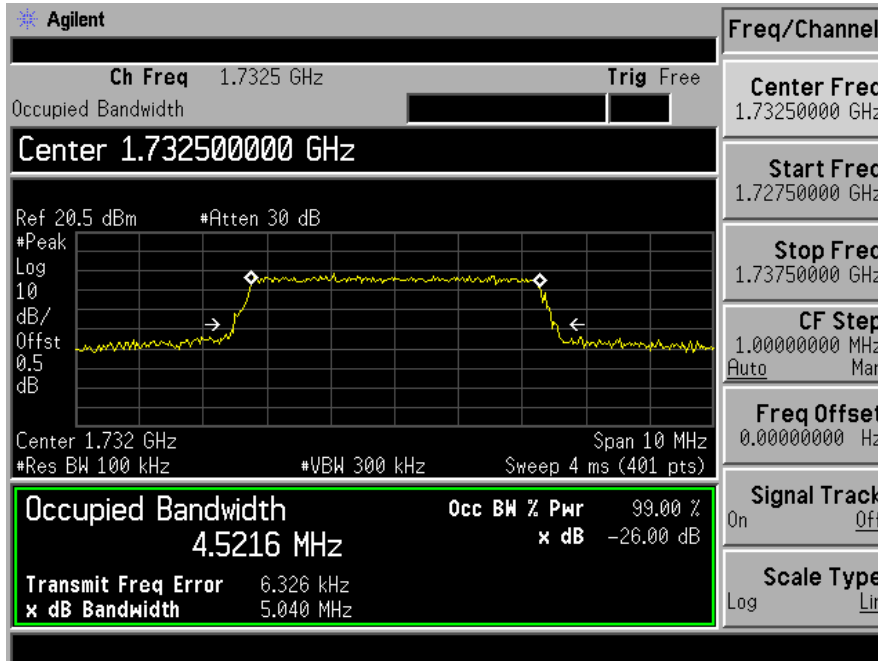

Test Model	99% Occupied Bandwidth & 26dB Bandwidth	
	LTE Band 4	
	Middle Chanel /5MHz	16-QAM/Full RB

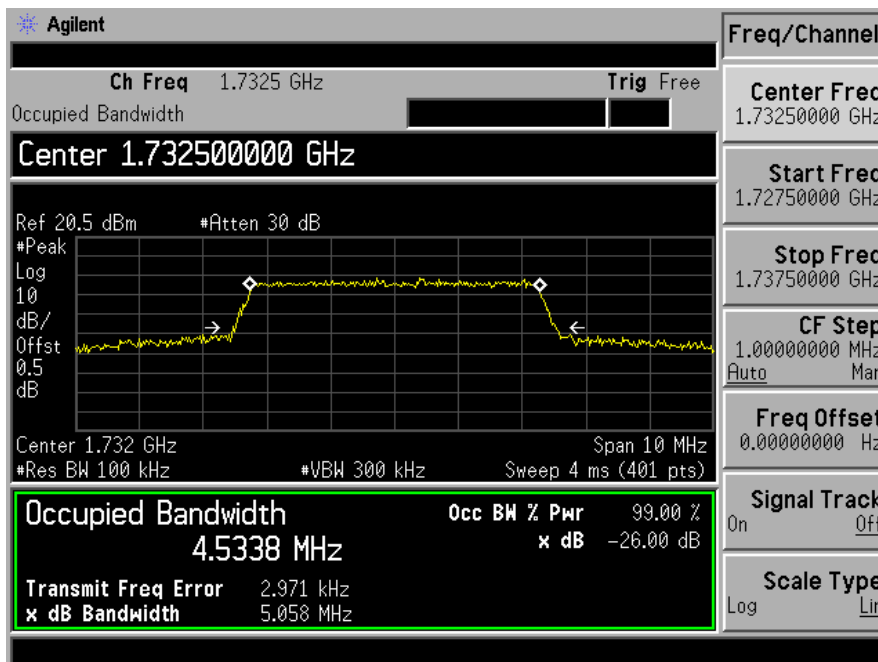

Test Model	99% Occupied Bandwidth & 26dB Bandwidth	
	LTE Band 4	
	High Channel /5MHz	QPSK/Full RB

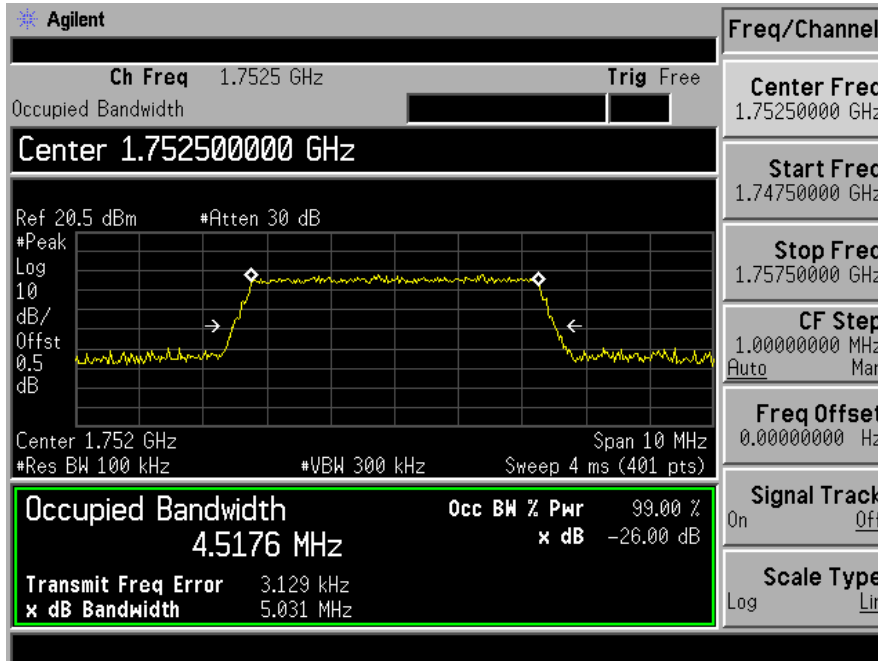

Test Model	99% Occupied Bandwidth & 26dB Bandwidth	
	LTE Band 4	
	High Channel /5MHz	16-QAM/Full RB

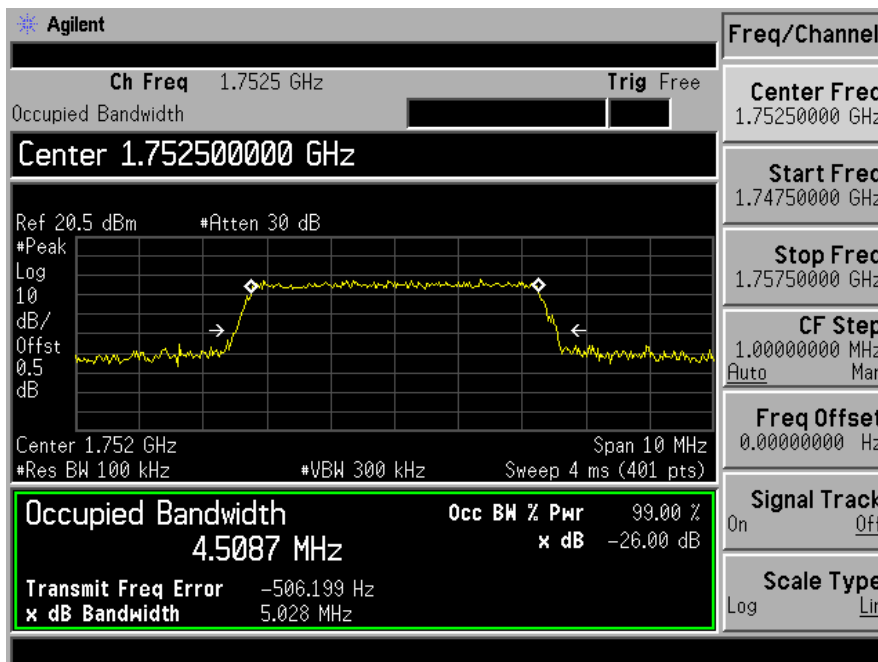

Test Model	99% Occupied Bandwidth & 26dB Bandwidth	
	LTE Band 4	
	Low Channel /3MHz	QPSK/Full RB

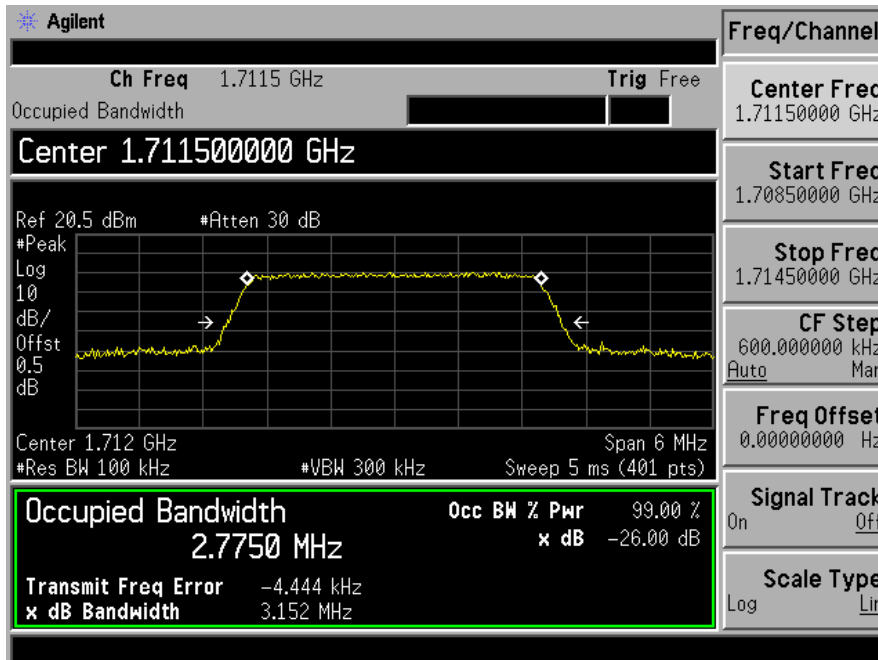

Test Model	99% Occupied Bandwidth & 26dB Bandwidth	
	LTE Band 4	
	Low Channel/3MHz	16-QAM/Full RB

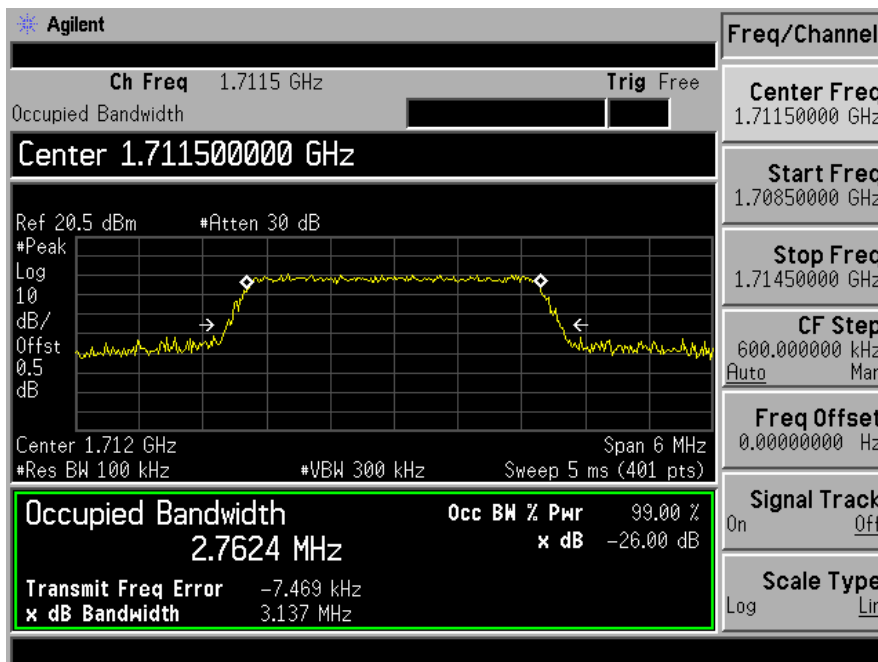

Test Model	99% Occupied Bandwidth & 26dB Bandwidth	
	LTE Band 4	
	Middle Channel /3MHz	QPSK/Full RB

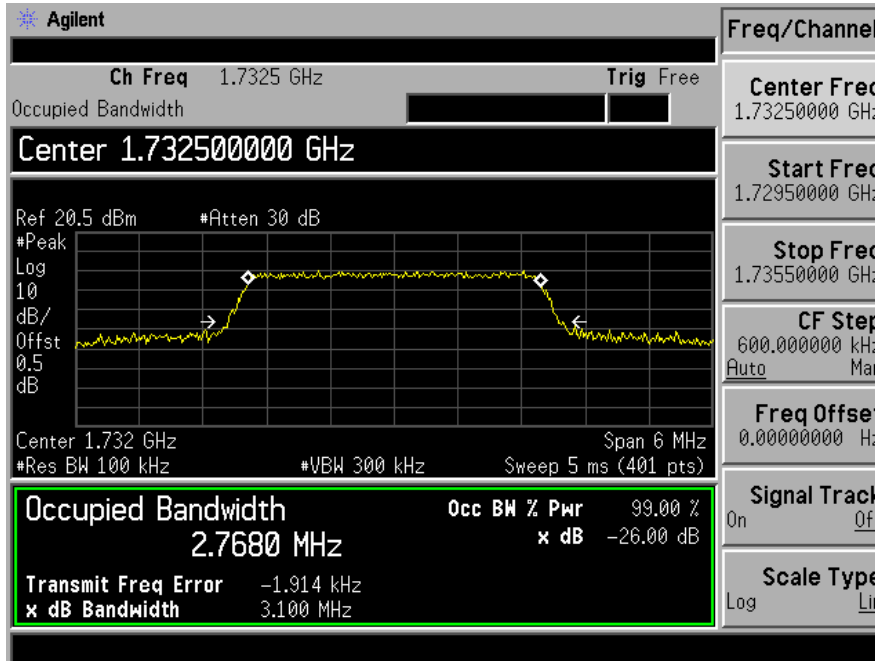

Test Model	99% Occupied Bandwidth & 26dB Bandwidth	
	LTE Band 4	
	Middle Chanel /3MHz	16-QAM/Full RB

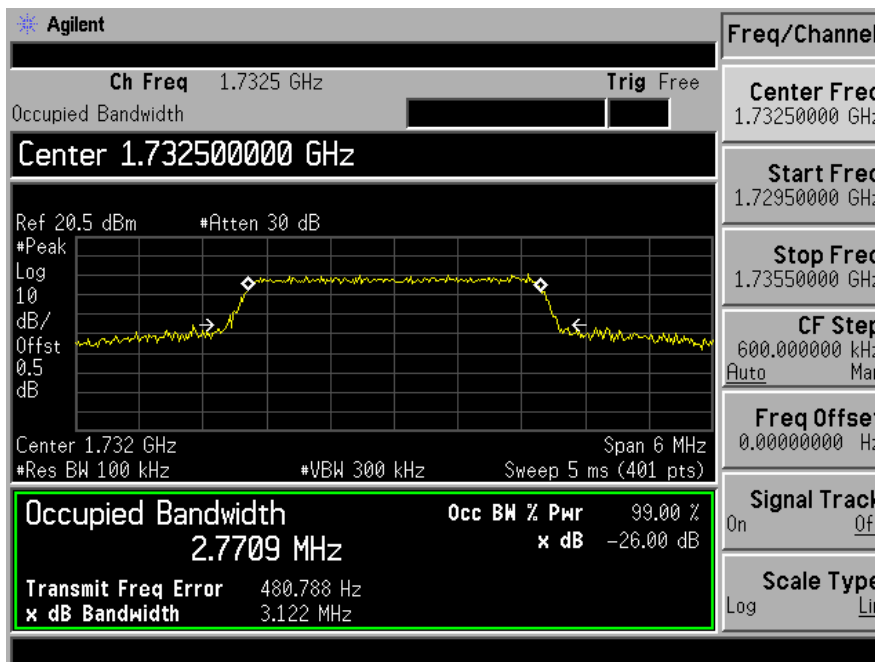

Test Model	99% Occupied Bandwidth & 26dB Bandwidth	
	LTE Band 4	
	High Channel /3MHz	QPSK/Full RB

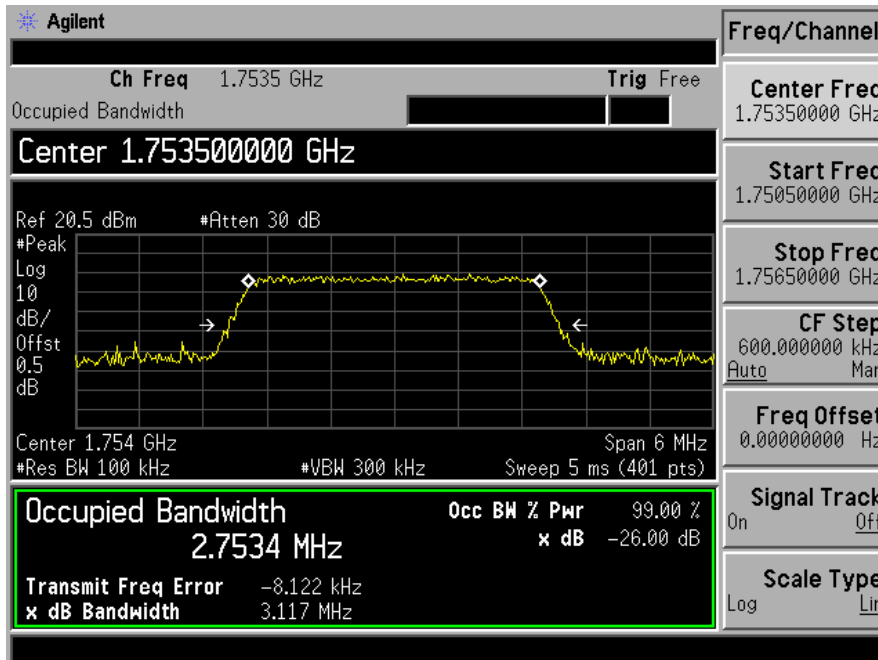

Test Model	99% Occupied Bandwidth & 26dB Bandwidth	
	LTE Band 4	
	High Chanel /3MHz	16-QAM/Full RB

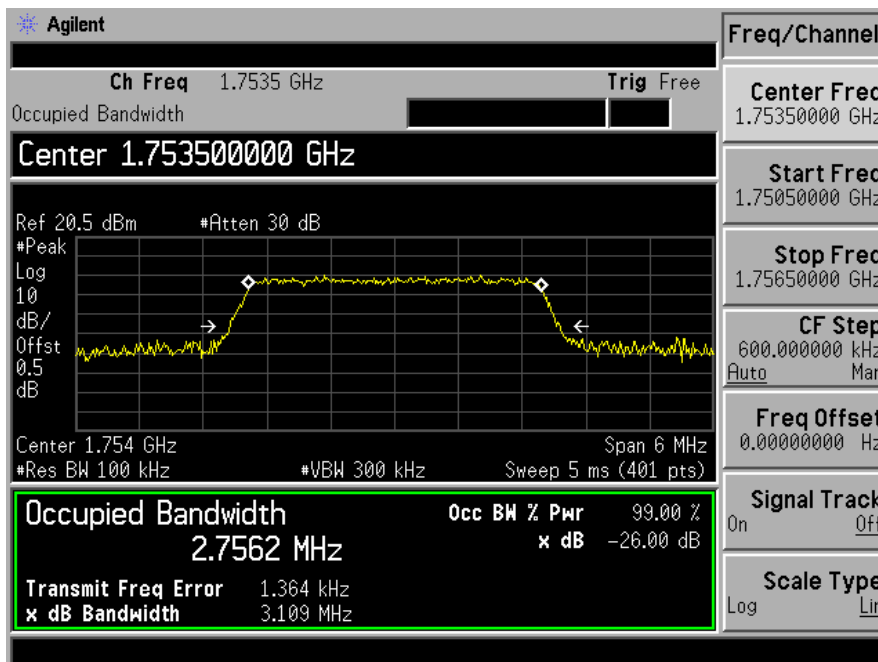

Test Model	99% Occupied Bandwidth & 26dB Bandwidth	
	LTE Band 13	
	Low Channel /5MHz	QPSK/Full RB

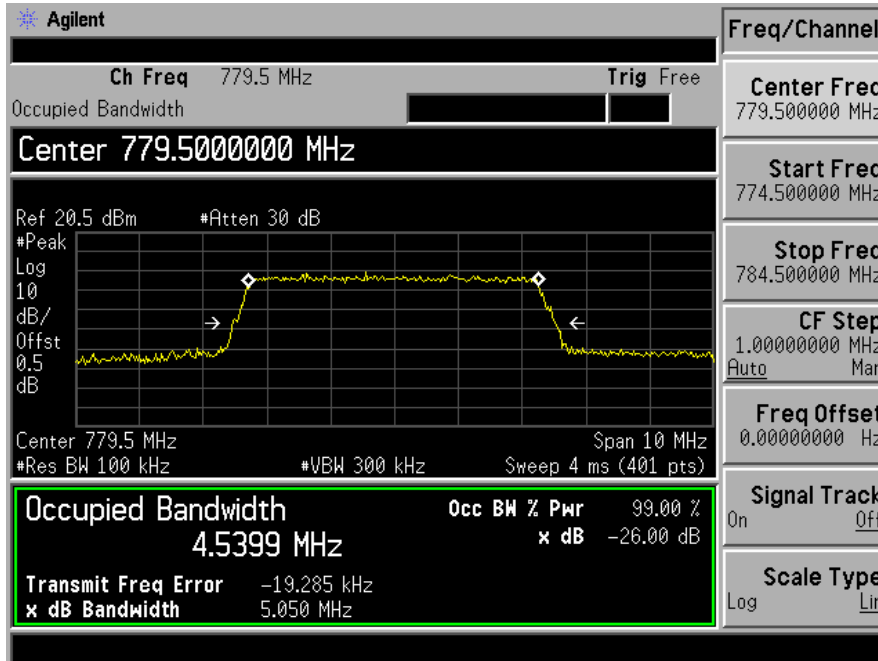

Test Model	99% Occupied Bandwidth & 26dB Bandwidth	
	LTE Band 13	
	Low Channel/5MHz	16-QAM/Full RB

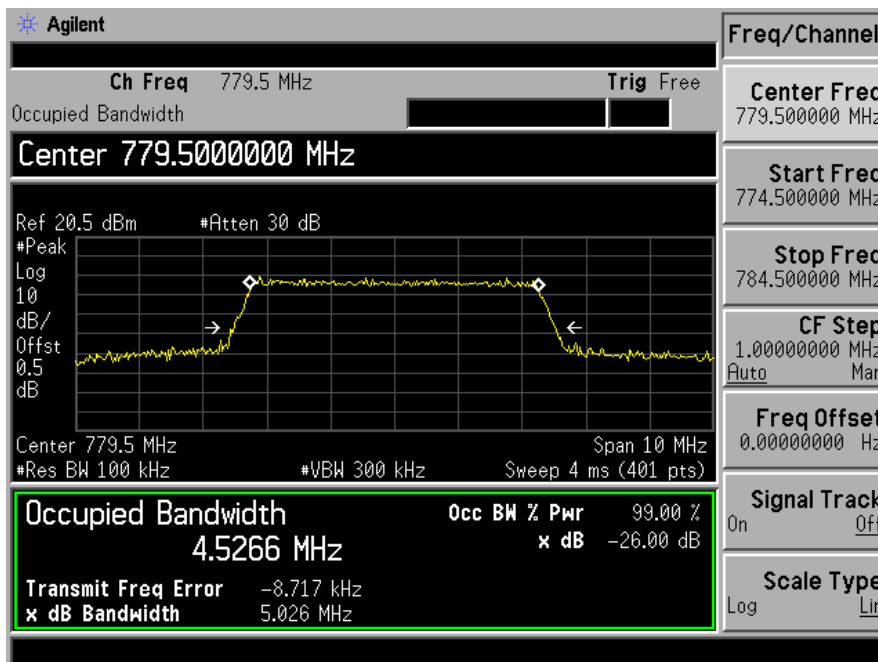

Test Model	99% Occupied Bandwidth & 26dB Bandwidth	
	LTE Band 13	
	Middle Channel /5MHz	QPSK/Full RB

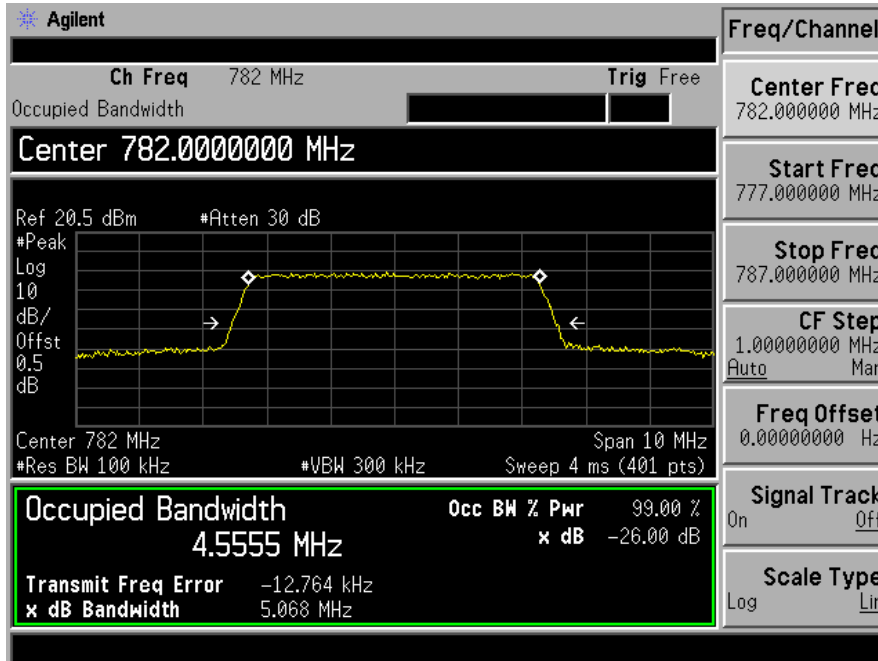

Test Model	99% Occupied Bandwidth & 26dB Bandwidth	
	LTE Band 13	
	Middle Chanel /5MHz	16-QAM/Full RB

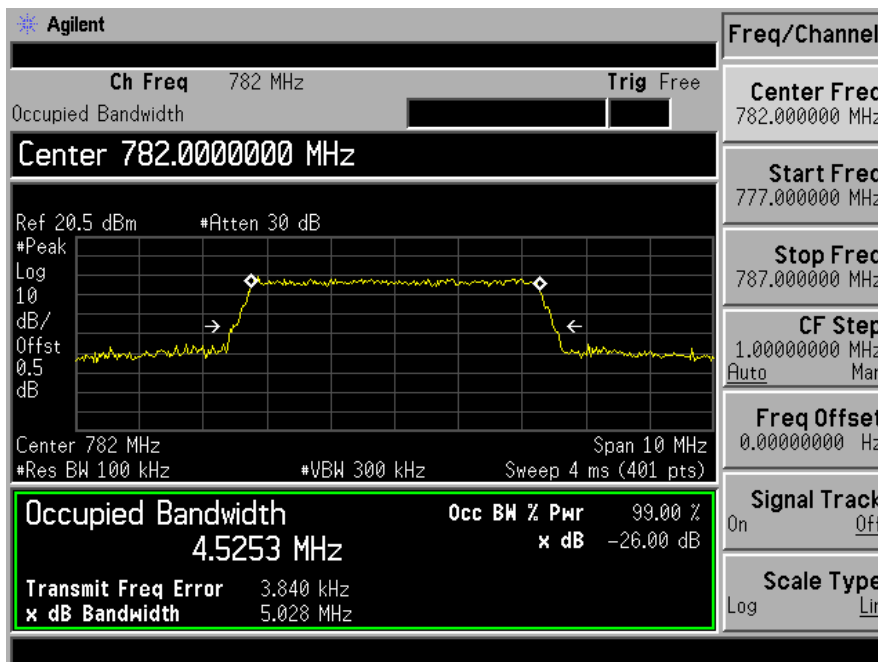

Test Model	99% Occupied Bandwidth & 26dB Bandwidth	
	LTE Band 13	
	High Channel /5MHz	QPSK/Full RB

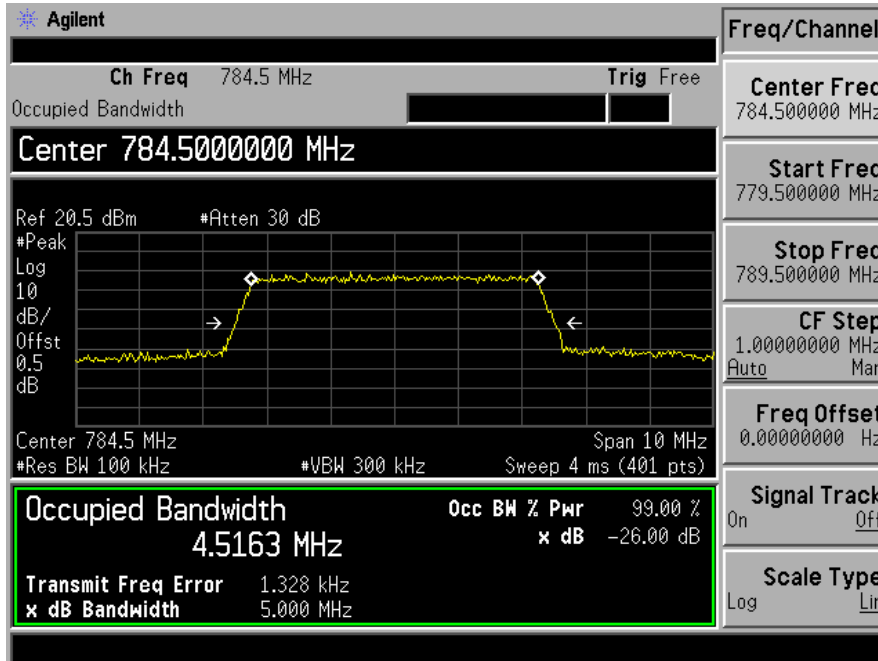

Test Model	99% Occupied Bandwidth & 26dB Bandwidth	
	LTE Band 13	
	High Chanel /5MHz	16-QAM/Full RB

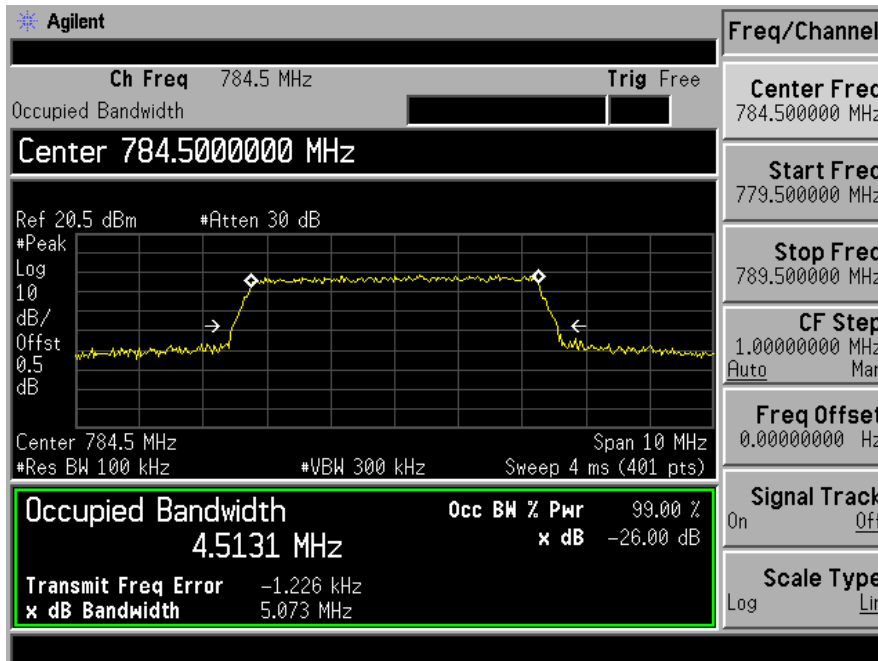

Test Model	99% Occupied Bandwidth & 26dB Bandwidth	
	LTE Band 13	
	Middle Channel /10MHz	QPSK/Full RB

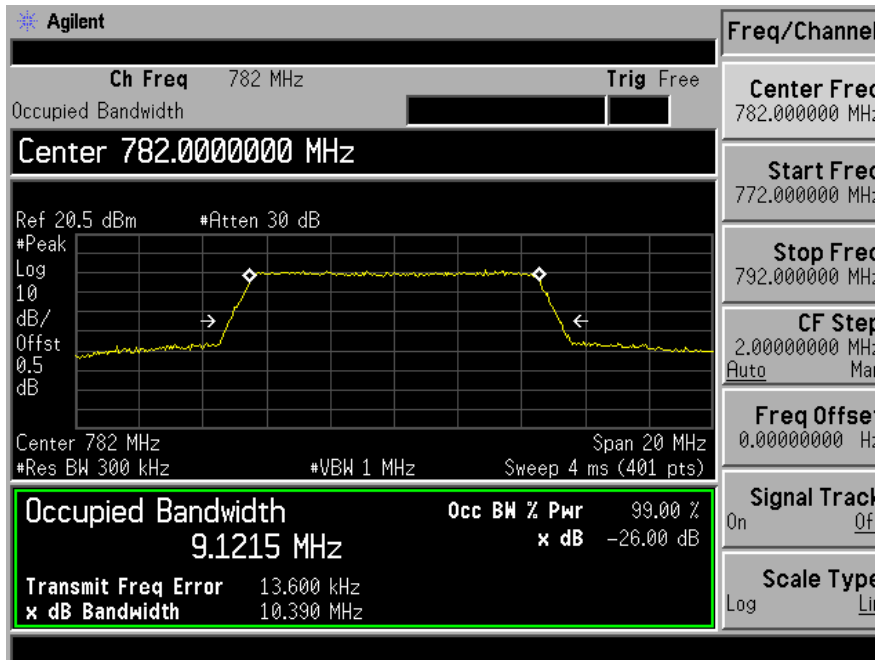

Test Model	99% Occupied Bandwidth & 26dB Bandwidth	
	LTE Band 13	
	Middle Channel /10MHz	16-QAM/Full RB

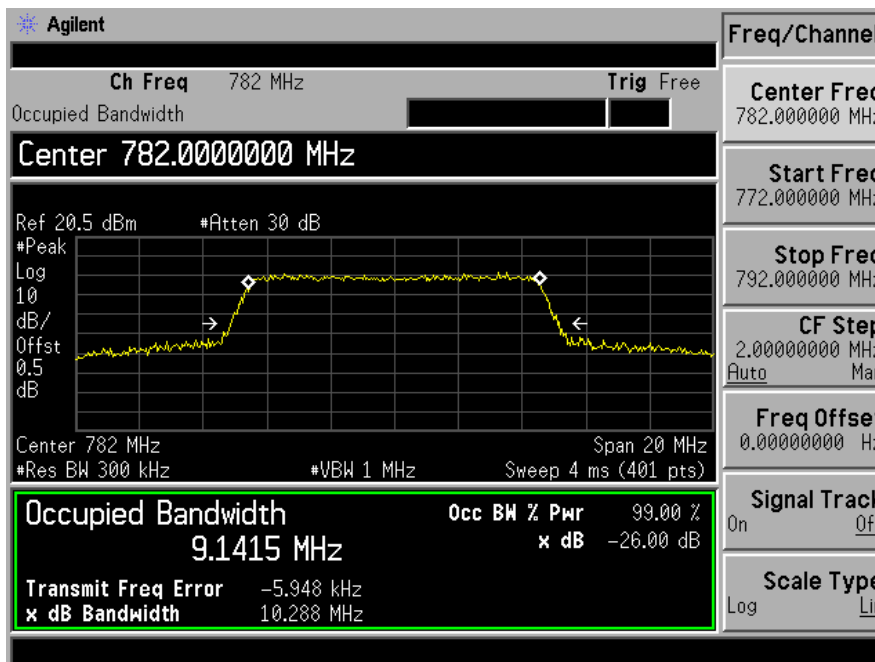

8.3 FREQUENCY STABILITY MEASUREMENT

8.3.1 Applicable Standard

According to FCC Part 2.1055 and Part 27.54.

8.3.2 Conformance Limit

According to FCC Part 2.1055

The frequency stability shall be measured by variation of ambient temperature and variation of primary supply voltage to ensure that the fundamental emission stays within the authorized frequency block. The frequency stability of the transmitter shall be maintained within $\pm 0.00025\%$ ($\pm 2.5\text{ppm}$) of the center frequency.

According to Part 27.54

The frequency stability shall be sufficient to ensure that the fundamental emissions stay within the authorized bands of operation

8.3.3 Test Procedures

EUT was placed at temperature chamber and connected to an external power supply.

Temperature and voltage condition shall be tested to confirm frequency stability.

Temperature range is from $-30\sim 70^{\circ}\text{C}$ and voltage range is from lowest to highest working voltage.

Tem Link up EUT and simulator. Confirm frequency drift value of simulator and record it.

8.3.4 Test Results

Temperature: N/A
Humidity: 53 %

Test Date: March 2, 2015
Test By: KING KONG
Test Band: LTE Band 4

Test Condition	Mode	Bandwidth (MHz)	Channel	Freq.Dev. (Hz)	Deviation (ppm)	Limit (ppm)	Result
Normal	QPSK	3MHz	19965	11	0.0064	2.5	PASS
			20175	13	0.0075		
			20385	14	0.0080		
		5MHz	19975	13	0.0076		
			20175	14	0.0081		
			20375	15	0.0086		
		20MHz	20050	10	0.0058		
			20175	12	0.0069		
			20300	11	0.0063		
	16QAM	3MHz	19965	11	0.0064		
			20175	11	0.0063		
			20385	13	0.0074		
		5MHz	19975	14	0.0082		
			20175	11	0.0063		
			20375	10	0.0057		
		20MHz	20050	10	0.0058		
			20175	11	0.0063		
			20300	11	0.0063		

Temperature: N/A
Humidity: 53 %

Test Date: March 2, 2015
Test By: KING KONG
Test Band: LTE Band 4

Test Condition	Mode	Bandwidth (MHz)	Channel	Freq.Dev. (Hz)	Deviation (ppm)	Limit (ppm)	Result
L.T /H.V	QPSK	3MHz	19965	8	0.0047	2.5	PASS
			20175	8	0.0046		
			20385	7	0.0040		
		5MHz	19975	10	0.0058		
			20175	9	0.0052		
			20375	9	0.0051		
		20MHz	20050	11	0.0064		
			20175	11	0.0063		
			20300	10	0.0057		
	16QAM	3MHz	19965	9	0.0053		
			20175	8	0.0046		
			20385	5	0.0029		
		5MHz	19975	10	0.0058		
			20175	12	0.0069		
			20375	9	0.0051		
		20MHz	20050	9	0.0052		
			20175	7	0.0040		
			20300	9	0.0052		

Temperature: N/A
Humidity: 53 %

Test Date: March 2, 2015
Test By: KING KONG
Test Band: LTE Band 4

Test Condition	Mode	Bandwidth (MHz)	Channel	Freq.Dev. (Hz)	Deviation (ppm)	Limit (ppm)	Result
L.T /L.V	QPSK	3MHz	19965	5	0.0029	2.5	PASS
			20175	5	0.0029		
			20385	8	0.0046		
		5MHz	19975	6	0.0035		
			20175	4	0.0023		
			20375	7	0.0040		
		20MHz	20050	7	0.0041		
			20175	9	0.0052		
			20300	6	0.0034		
	16QAM	3MHz	19965	10	0.0058		
			20175	10	0.0058		
			20385	8	0.0046		
		5MHz	19975	9	0.0053		
			20175	9	0.0052		
			20375	11	0.0063		
		20MHz	20050	12	0.0070		
			20175	10	0.0058		
			20300	6	0.0034		

Temperature: N/A
Humidity: 53 %

Test Date: March 2, 2015
Test By: KING KONG
Test Band: LTE Band 4

Test Condition	Mode	Bandwidth (MHz)	Channel	Freq.Dev. (Hz)	Deviation (ppm)	Limit (ppm)	Result
H.T /L.V	QPSK	3MHz	19965	16	0.0093	2.5	PASS
			20175	16	0.0092		
			20385	15	0.0086		
		5MHz	19975	12	0.0070		
			20175	14	0.0081		
			20375	15	0.0086		
		20MHz	20050	15	0.0087		
			20175	14	0.0081		
			20300	16	0.0092		
	16QAM	3MHz	19965	18	0.0105		
			20175	12	0.0069		
			20385	15	0.0086		
		5MHz	19975	16	0.0093		
			20175	16	0.0092		
			20375	11	0.0063		
		20MHz	20050	15	0.0087		
			20175	16	0.0092		
			20300	16	0.0092		

Temperature: N/A
Humidity: 53 %

Test Date: March 2, 2015
Test By: KING KONG
Test Band: LTE Band 4

Test Condition	Mode	Bandwidth (MHz)	Channel	Freq.Dev. (Hz)	Deviation (ppm)	Limit (ppm)	Result
H.T /H.V	QPSK	3MHz	19965	18	0.0105	2.5	PASS
			20175	15	0.0087		
			20385	17	0.0097		
		5MHz	19975	16	0.0093		
			20175	16	0.0092		
			20375	12	0.0068		
		20MHz	20050	12	0.0070		
			20175	17	0.0098		
			20300	15	0.0086		
	16QAM	3MHz	19965	15	0.0088		
			20175	13	0.0075		
			20385	16	0.0091		
		5MHz	19975	17	0.0099		
			20175	19	0.0110		
			20375	18	0.0103		
		20MHz	20050	14	0.0081		
			20175	14	0.0081		
			20300	17	0.0097		

Temperature: N/A
Humidity: 53 %

Test Date: March 2, 2015
Test By: KING KONG
Test Band: LTE Band 13

Test Condition	Mode	Bandwidth (MHz)	Channel	Freq.Dev. (Hz)	Deviation (ppm)	Limit (ppm)	Result
Normal	QPSK	5MHz	23205	5.9	0.0076	2.5	PASS
			23230	5.1	0.0065		
			23255	6.2	0.0079		
	10MHz	23230	6.6	0.0084			
	16QAM	5MHz	23205	5.5	0.0071		
			23230	4.8	0.0061		
			23255	4.9	0.0062		
			10MHz	23230	5.4		

Temperature: N/A
Humidity: 53 %

Test Date: March 2, 2015
Test By: KING KONG
Test Band: LTE Band 13

Test Condition	Mode	Bandwidth (MHz)	Channel	Freq.Dev. (Hz)	Deviation (ppm)	Limit (ppm)	Result
L.T /H.V	QPSK	5MHz	23205	-3.2	-0.0041	2.5	PASS
			23230	-2.9	-0.0037		
			23255	-2.4	-0.0031		
	10MHz	23230	-2.7	-0.0035			
	16QAM	5MHz	23205	-1.9	-0.0024		
			23230	-3.5	-0.0045		
			23255	-3.3	-0.0042		
			10MHz	23230	-2.8		

Temperature: N/A
Humidity: 53 %

Test Date: March 2, 2015
Test By: KING KONG
Test Band: LTE Band 13

Test Condition	Mode	Bandwidth (MHz)	Channel	Freq.Dev. (Hz)	Deviation (ppm)	Limit (ppm)	Result
L.T /L.V	QPSK	5MHz	23205	-3.5	-0.0045	2.5	PASS
			23230	-3.3	-0.0042		
			23255	-2.9	-0.0037		
	10MHz	23230	0.4	0.0005			
	16QAM	5MHz	23205	-0.7	-0.0009		
			23230	-2.2	-0.0028		
			23255	-1.6	-0.0020		
			10MHz	23230	-2.4		

Temperature: N/A
Humidity: 53 %

Test Date: March 2, 2015
Test By: KING KONG
Test Band: LTE Band 13

Test Condition	Mode	Bandwidth (MHz)	Channel	Freq.Dev. (Hz)	Deviation (ppm)	Limit (ppm)	Result
H.T /L.V	QPSK	5MHz	23205	4.9	0.0063	2.5	PASS
			23230	5.3	0.0068		
			23255	5.5	0.0070		
	16QAM	10MHz	23230	5.9	0.0075		
			5MHz	23205	6.1		
		23230		5.4	0.0069		
		23255		4.9	0.0062		
		10MHz	23230	5.6	0.0072		

Temperature: N/A
Humidity: 53 %

Test Date: March 2, 2015
Test By: KING KONG
Test Band: LTE Band 13

Test Condition	Mode	Bandwidth (MHz)	Channel	Freq.Dev. (Hz)	Deviation (ppm)	Limit (ppm)	Result
H.T /H.V	QPSK	5MHz	23205	6.6	0.0085	2.5	PASS
			23230	7.2	0.0092		
			23255	6.9	0.0088		
	16QAM	10MHz	23230	6.4	0.0082		
			5MHz	23205	7.4		
		23230		7	0.0090		
		23255		6.8	0.0087		
		10MHz	23230	7.1	0.0091		

8.4 EFFECTIVE ISOTROPIC RADIATED POWER

8.4.1 Applicable Standard

According to FCC Part 2.1046, FCC Part 27.50(b)(10) and FCC Part 27.50(d)(4).

8.4.2 Conformance Limit

For band 4 output power limit:

FCC Part 27.50 (d)(4): Fixed, mobile, and portable (hand-held) stations operating in the 1710-1755 MHz band are limited to 1 watt EIRP. Fixed stations operating in this band are limited to a maximum antenna height of 10 meters above ground. Mobile and portable stations operating in this band must employ a means for limiting power to the minimum necessary for successful communications.

For band 13 output power limit:

FCC Part 27.50 (b)(10): Portable stations (hand-held devices) transmitting in the 746-757 MHz, 776-788 MHz, and 805-806 MHz bands are limited to 3 watts ERP

8.4.3 Test Configuration

Test according to clause 7.2 radio frequency test setup 2

8.4.4 Test Procedure

Measurement is made at a semi-anechoic chamber that incorporates a turntable allowing a EUT rotation of 360°. A continuously-rotating, remotely-controlled turntable is installed at the test site to support the EUT and facilitate determination of the direction of maximum radiation for each EUT emission frequency. The EUT is placed at a height of 0.8m test table above the ground plane.

Measurement is made with the antenna positioned in both the horizontal and vertical planes of polarization. The measurement antenna is varied in height (1m ~ 4m) above the reference ground plane to obtain the maximum signal strength. Distance between EUT and antenna is 3 m.

This investigation is performed with the EUT rotated 360°, the antenna height scanned between 1 m and 4 m, and the antenna rotated to repeat the measurements for both the horizontal and vertical antenna polarizations.

Effective Radiated Power (ERP) and Effective Isotropic Radiated Power (EIRP) was measured by substitution method according to TIA/EIA-603-C. The EUT was replaced by dipole antenna (substitution antenna) at same location, and then a known power from S.G. was applied into the dipole antenna through a Tx cable, and then recorded the maximum Analyzer reading through raised and lowered the test antenna. The correction factor (in dB) = S.G. - Tx Cable loss + Substitution antenna gain - Analyzer reading. Then the EUT's EIRP was calculated with the correction factor, $EIRP = LVL + \text{Correction factor}$.
 $ERP = EIRP - 2.15 \text{dBi}$.

8.4.5 Test Results

PASS.

Temperature: 24°C
Humidity: 53 %
Test Band: LTE Band 4

Test Date: March 2, 2015
Test By: KING KONG

Frequency (MHz)	H/V	Bandwidth (MHz)	RB Size	RB Offset	Modulation	EIRP (dBm)	EIRP (W)	Limit (W)
1720.00	H	20	1	0	QPSK	18.33	0.0681	1
1732.50	H	20	1	0		17.28	0.0535	1
1745.00	H	20	1	0		17.47	0.0558	1
1720.00	V	20	1	0		6.34	0.0043	1
1732.50	V	20	1	0		6.44	0.0044	1
1745.00	V	20	1	0		7.04	0.0051	1
1720.00	H	20	1	0	16-QAM	18.25	0.0668	1
1732.50	H	20	1	0		16.89	0.0489	1
1745.00	H	20	1	0		17.32	0.0540	1
1720.00	V	20	1	0		6.30	0.0043	1
1732.50	V	20	1	0		6.06	0.0040	1
1745.00	V	20	1	0		6.84	0.0048	1

Temperature: 24°C
Humidity: 53 %
Test Band: LTE Band 4

Test Date: March 2, 2015
Test By: KING KONG

Frequency (MHz)	H/V	Bandwidth (MHz)	RB Size	RB Offset	Modulation	EIRP (dBm)	EIRP (W)	Limit (W)
1712.50	H	5	1	0	QPSK	18.79	0.0757	1
1732.50	H	5	1	0		17.26	0.0532	1
1752.50	H	5	1	0		17.36	0.0545	1
1712.50	V	5	1	0		7.37	0.0055	1
1732.50	V	5	1	0		7.07	0.0051	1
1752.50	V	5	1	0		5.78	0.0038	1
1712.50	H	5	1	0	16-QAM	18.79	0.0757	1
1732.50	H	5	1	0		17.26	0.0532	1
1752.50	H	5	1	0		17.36	0.0545	1
1712.50	V	5	1	0		7.37	0.0055	1
1732.50	V	5	1	0		7.07	0.0051	1
1752.50	V	5	1	0		5.78	0.0038	1

Temperature: 24°C
Humidity: 53 %
Test Band LTE Band 4

Test Date: March 2, 2015
Test By: KING KONG

Frequency (MHz)	H/V	Bandwidth (MHz)	RB Size	RB Offset	Modulation	EIRP (dBm)	EIRP (W)	Limit (W)
1711.50	H	3	1	0	QPSK	21.85	0.1531	1
1732.50	H	3	1	0		19.35	0.0861	1
1753.50	H	3	1	0		18.88	0.0773	1
1711.50	V	3	1	0		10.37	0.0109	1
1732.50	V	3	1	0		7.41	0.0055	1
1753.50	V	3	1	0		5.94	0.0039	1
1711.50	H	3	1	0	16-QAM	21.83	0.1524	1
1732.50	H	3	1	0		19.60	0.0912	1
1753.50	H	3	1	0		20.02	0.1005	1
1711.50	V	3	1	0		10.66	0.0116	1
1732.50	V	3	1	0		7.46	0.0056	1
1753.50	V	3	1	0		6.71	0.0047	1

Temperature: 24°C
Humidity: 53 %
Test Band LTE Band 13

Test Date: March 2, 2015
Test By: KING KONG

Frequency (MHz)	H/V	Bandwidth (MHz)	RB Size	RB Offset	Modulation	ERP (dBm)	ERP (W)	Limit (W)
779.5	H	5	1	0	QPSK	19.87	0.0971	3
782.0	H	5	1	0		20.00	0.1000	3
784.5	H	5	1	0		19.31	0.0853	3
779.5	V	5	1	0		7.58	0.0057	3
782.0	V	5	1	0		8.65	0.0073	3
784.5	V	5	1	0		7.91	0.0062	3
779.5	H	5	1	0	16-QAM	20.12	0.1028	3
782.0	H	5	1	0		20.41	0.1099	3
784.5	H	5	1	0		19.56	0.0903	3
779.5	V	5	1	0		7.94	0.0062	3
782.0	V	5	1	0		9.14	0.0082	3
784.5	V	5	1	0		8.24	0.0067	3

Temperature: 24°C
 Humidity: 53 %
 Test Band: LTE Band 13

Test Date: March 2, 2015
 Test By: KING KONG

Frequency (MHz)	H/V	Bandwidth (MHz)	RB Size	RB Offset	Modulation	ERP (dBm)	ERP (W)	Limit (W)
782.0	H	10	1	0	QPSK	19.95	0.0989	3
782.0	V	10	1	0		8.67	0.0074	3
782.0	H	10	1	0	16-QAM	19.85	0.0966	3
782.0	V	10	1	0		8.61	0.0073	3

All the modulation modes were tested, the data of the worst mode are described in the following table.

8.5 RADIATED SPURIOUS EMISSION

8.5.1 Applicable Standard

According to FCC Part 2.1053, Part 27.53(c)(1) and Part 27.53(g).

8.5.2 Conformance Limit

■ Radiated Spurious Emission

For band 4 Emission limit:

On any frequency outside the 746-758 MHz band, the power of any emission shall be attenuated outside the band below the transmitter power (P) by at least $43 + 10 \log(P)$ dB;

For band 13 Emission limit:

AWS emission limits—(1) General protection levels. Except as otherwise specified below, for operations in the 1710-1755 MHz, 2110-2155 MHz, 2000-2020 MHz, 2180-2200 MHz, 1915-1920 MHz, and 1995-2000 MHz bands, the power of any emission outside a licensee's frequency block shall be attenuated below the transmitter power (P) by at least $43 + 10 \log(P)$ dB

■ 100KHz Band Edge

For LTE Band 13 Band Edge:

FCC §27.53(c) (5) Compliance with the provisions, §27.53(c) (2) of this section is based on the use of measurement instrumentation employing a resolution bandwidth of 100 kHz or greater. However, in the 100 kHz bands immediately outside and adjacent to the frequency block, a resolution bandwidth of at least 30 kHz may be employed

For LTE Band 4 Band Edge:

Compliance with this provision is based on the use of measurement instrumentation employing a resolution bandwidth of 1 megahertz or greater. However, in the 1 megahertz bands immediately outside and adjacent to the licensee's frequency block, a resolution bandwidth of at least one percent of the emission bandwidth of the fundamental emission of the transmitter may be employed. The emission bandwidth is defined as the width of the signal between two points, one below the carrier center frequency and one above the carrier center frequency, outside of which all emissions are attenuated at least 26 dB below the transmitter power. (m)(4) For mobile digital stations, the attenuation factor shall be not less than $43 + 10 \log(P)$ dB at the channel edge and $55 + 10 \log(P)$ dB at 5.5 megahertz from the channel edges.

8.5.3 Test Configuration

Test according to clause 7.2 radio frequency test setup 2

8.5.4 Test Procedure

Step1. The EUT was placed on a rotatable wooden table with 0.8 meter above ground.

Step2. The EUT was set 3 meters from the receiving antenna, which was mounted on the antenna tower.

Step3. The table was rotated 360 degrees to determine the position of the highest spurious emission.

Step4. The height of the receiving antenna is varied between one meter and four meters to search the maximum spurious emission for both horizontal and vertical polarizations.

Step5. Make the measurement with the spectrum analyzer's RBW = 1MHz, VBW = 3MHz, taking the record of maximum spurious emission.

Step6. A horn antenna was substituted in place of the EUT and was driven by a signal generator.

Step7. Tune the output power of signal generator to the same emission level with EUT maximum spurious emission.

Step8. Taking the record of output power at antenna port.

Step9. Repeat step 7 to step 8 for another polarization.

Step10. Emission level (dBm) = output power + substitution Gain.

8.5.5 Test Results

■ Spurious Emission below 1000MHz (30MHz to 1000MHz)

Temperature:	24°C	Test Date:	March 2, 2015
Humidity:	53 %	Test By:	KING KONG
Test Band	LTE Band 4	Test Mode:	QPSK/ Middle Channel

Freq. (MHz)	H/V	Bandwidth (MHz)	RB Size	RB Offset	Emission Level(dBm)	Limit (dBm)	Margin (dBm)	Verdict
94.02	H	5	1	0	-64.48	-13.00	-51.48	PASS
272.50	H	5	1	0	-63.69	-13.00	-50.69	PASS
384.05	H	5	1	0	-60.75	-13.00	-47.75	PASS
579.99	H	5	1	0	-56.37	-13.00	-43.37	PASS
875.84	H	5	1	0	-50.38	-13.00	-37.38	PASS
947.62	H	5	1	0	-50.00	-13.00	-37.00	PASS
59.10	V	5	1	0	-58.02	-13.00	-45.02	PASS
94.02	V	5	1	0	-61.05	-13.00	-48.05	PASS
153.19	V	5	1	0	-64.62	-13.00	-51.62	PASS
605.21	V	5	1	0	-55.83	-13.00	-42.83	PASS
861.29	V	5	1	0	-51.20	-13.00	-38.20	PASS
910.76	V	5	1	0	-49.28	-13.00	-36.28	PASS

Test Band LTE Band 4 Test Mode: QPSK/ Middle Channel

Freq. (MHz)	H/V	Bandwidth (MHz)	RB Size	RB Offset	Emission Level(dBm)	Limit (dBm)	Margin (dBm)	Verdict
42.61	H	5	1	0	-65.44	-13.00	-52.44	PASS
95.96	H	5	1	0	-63.10	-13.00	-50.10	PASS
157.07	H	5	1	0	-65.16	-13.00	-52.16	PASS
622.67	H	5	1	0	-55.54	-13.00	-42.54	PASS
848.68	H	5	1	0	-50.78	-13.00	-37.78	PASS
912.70	H	5	1	0	-49.66	-13.00	-36.66	PASS
42.61	V	5	1	0	-50.30	-13.00	-37.30	PASS
101.78	V	5	1	0	-52.02	-13.00	-39.02	PASS
411.21	V	5	1	0	-46.32	-13.00	-33.32	PASS
788.54	V	5	1	0	-39.40	-13.00	-26.40	PASS
889.42	V	5	1	0	-37.02	-13.00	-24.02	PASS
974.78	V	5	1	0	-36.72	-13.00	-23.72	PASS

Test Band LTE Band 4 Test Mode: QPSK/ Middle Channel

Freq. (MHz)	H/V	Bandwidth (MHz)	RB Size	RB Offset	Emission Level(dBm)	Limit (dBm)	Margin (dBm)	Verdict
47.46	H	3	1	0	-64.96	-13.00	-51.96	PASS
94.02	H	3	1	0	-63.60	-13.00	-50.60	PASS
155.13	H	3	1	0	-65.07	-13.00	-52.07	PASS
499.48	H	3	1	0	-58.20	-13.00	-45.20	PASS
882.63	H	3	1	0	-49.85	-13.00	-36.85	PASS
946.65	H	3	1	0	-48.52	-13.00	-35.52	PASS
42.61	V	3	1	0	-59.86	-13.00	-46.86	PASS
58.13	V	3	1	0	-58.03	-13.00	-45.03	PASS
95.96	V	3	1	0	-60.62	-13.00	-47.62	PASS
839.95	V	3	1	0	-50.91	-13.00	-37.91	PASS
883.60	V	3	1	0	-50.51	-13.00	-37.51	PASS
912.70	V	3	1	0	-48.81	-13.00	-35.81	PASS

Temperature: 24°C
 Humidity: 53 %
 Test Band LTE Band 13

Test Date: March 2, 2015
 Test By: KING KONG
 Test Mode: QPSK/ Middle Channel

Freq. (MHz)	H/V	Bandwidth (MHz)	RB Size	RB Offset	Emission Level(dBm)	Limit (dBm)	Margin (dBm)	Verdict
100.81	H	5	1	0	-57.50	-13.00	-44.50	PASS
205.57	H	5	1	0	-57.07	-13.00	-44.07	PASS
499.48	H	5	1	0	-53.03	-13.00	-40.03	PASS
672.14	H	5	1	0	-44.63	-13.00	-31.63	PASS
915.61	H	5	1	0	-44.56	-13.00	-31.56	PASS
967.99	H	5	1	0	-44.79	-13.00	-31.79	PASS
40.67	V	5	1	0	-48.88	-13.00	-35.88	PASS
99.84	V	5	1	0	-53.40	-13.00	-40.40	PASS
208.48	V	5	1	0	-55.55	-13.00	-42.55	PASS
914.64	V	5	1	0	-44.97	-13.00	-31.97	PASS
944.71	V	5	1	0	-44.35	-13.00	-31.35	PASS
975.75	V	5	1	0	-45.07	-13.00	-32.07	PASS

Test Band LTE Band 13 Test Mode: QPSK/ Middle Channel

Freq. (MHz)	H/V	Bandwidth (MHz)	RB Size	RB Offset	Emission Level(dBm)	Limit (dBm)	Margin (dBm)	Verdict
101.08	H	10	1	0	-57.19	-13.00	-44.19	PASS
205.84	H	10	1	0	-56.76	-13.00	-43.76	PASS
499.75	H	10	1	0	-52.72	-13.00	-39.72	PASS
672.41	H	10	1	0	-44.32	-13.00	-31.32	PASS
915.88	H	10	1	0	-44.25	-13.00	-31.25	PASS
968.26	H	10	1	0	-44.48	-13.00	-31.48	PASS
40.94	V	10	1	0	-48.57	-13.00	-35.57	PASS
100.11	V	10	1	0	-53.09	-13.00	-40.09	PASS
208.75	V	10	1	0	-55.24	-13.00	-42.24	PASS
914.91	V	10	1	0	-44.66	-13.00	-31.66	PASS
944.98	V	10	1	0	-44.04	-13.00	-31.04	PASS
976.02	V	10	1	0	-44.76	-13.00	-31.76	PASS

■ Spurious Emission Above 1GHz (1GHz to 18GHz)

Temperature:	24°C	Test Date:	March 2, 2015
Humidity:	53 %	Test By:	KING KONG
Test Band	LTE Band 4	Test Mode:	QPSK/ Middle Channel

Freq. (MHz)	H/V	Bandwidth (MHz)	RB Size	RB Offset	Emission Level(dBm)	Limit (dBm)	Margin (dBm)	Verdict
3465.00	H	3	1	0	-20.77	-13.00	-7.77	PASS
5197.50	H	3	1	0	-21.34	-13.00	-8.34	PASS
6930.00	H	3	1	0	-27.64	-13.00	-14.64	PASS
8662.50	H	3	1	0	-30.37	-13.00	-17.37	PASS
10395.00	H	3	1	0	-32.97	-13.00	-19.97	PASS
12127.50	H	3	1	0	-36.89	-13.00	-23.89	PASS
3465.00	V	3	1	0	-19.69	-13.00	-6.69	PASS
5197.50	V	3	1	0	-20.51	-13.00	-7.51	PASS
6930.00	V	3	1	0	-25.28	-13.00	-12.28	PASS
8662.50	V	3	1	0	-29.57	-13.00	-16.57	PASS
10395.00	V	3	1	0	-34.45	-13.00	-21.45	PASS
12127.50	V	3	1	0	-39.88	-13.00	-26.88	PASS

Test Band LTE Band 4 Test Mode: QPSK/ Middle Channel

Freq. (MHz)	H/V	Bandwidth (MHz)	RB Size	RB Offset	Emission Level(dBm)	Limit (dBm)	Margin (dBm)	Verdict
3465.00	H	5	1	0	-22.04	-13.00	-9.04	PASS
5197.50	H	5	1	0	-22.61	-13.00	-9.61	PASS
6930.00	H	5	1	0	-28.91	-13.00	-15.91	PASS
8662.50	H	5	1	0	-31.64	-13.00	-18.64	PASS
10395.00	H	5	1	0	-34.24	-13.00	-21.24	PASS
12127.50	H	5	1	0	-38.16	-13.00	-25.16	PASS
3465.00	V	5	1	0	-20.96	-13.00	-7.96	PASS
5197.50	V	5	1	0	-21.78	-13.00	-8.78	PASS
6930.00	V	5	1	0	-26.55	-13.00	-13.55	PASS
8662.50	V	5	1	0	-30.84	-13.00	-17.84	PASS
10395.00	V	5	1	0	-35.72	-13.00	-22.72	PASS
12127.50	V	5	1	0	-41.15	-13.00	-28.15	PASS

Test Band LTE Band 4 Test Mode: QPSK/ Middle Channel

Freq. (MHz)	H/V	Bandwidth (MHz)	RB Size	RB Offset	Emission Level(dBm)	Limit (dBm)	Margin (dBm)	Verdict
3465.00	H	20	1	0	-19.83	-13.00	-6.83	PASS
5197.50	H	20	1	0	-20.40	-13.00	-7.40	PASS
6930.00	H	20	1	0	-26.70	-13.00	-13.70	PASS
8662.50	H	20	1	0	-29.43	-13.00	-16.43	PASS
10395.00	H	20	1	0	-32.03	-13.00	-19.03	PASS
12127.50	H	20	1	0	-35.95	-13.00	-22.95	PASS
3465.00	V	20	1	0	-18.75	-13.00	-5.75	PASS
5197.50	V	20	1	0	-19.57	-13.00	-6.57	PASS
6930.00	V	20	1	0	-24.34	-13.00	-11.34	PASS
8662.50	V	20	1	0	-28.63	-13.00	-15.63	PASS
10395.00	V	20	1	0	-33.51	-13.00	-20.51	PASS
12127.50	V	20	1	0	-38.94	-13.00	-25.94	PASS

Temperature: 24°C
Humidity: 53 %
Test Band LTE Band 13

Test Date: March 2, 2015
Test By: KING KONG
Test Mode: QPSK/ Middle Channel

Freq. (MHz)	H/V	Bandwidth (MHz)	RB Size	RB Offset	Emission Level(dBm)	Limit (dBm)	Margin (dBm)	Verdict
1564.00	H	5	1	0	-22.04	-13.00	-9.04	PASS
2346.00	H	5	1	0	-22.77	-13.00	-9.77	PASS
3128.00	H	5	1	0	-29.80	-13.00	-16.80	PASS
3910.00	H	5	1	0	-29.86	-13.00	-16.86	PASS
4692.00	H	5	1	0	-32.21	-13.00	-19.21	PASS
5474.00	H	5	1	0	-37.76	-13.00	-24.76	PASS
1564.00	V	5	1	0	-19.64	-13.00	-6.64	PASS
2346.00	V	5	1	0	-22.34	-13.00	-9.34	PASS
3128.00	V	5	1	0	-28.73	-13.00	-15.73	PASS
3910.00	V	5	1	0	-28.53	-13.00	-15.53	PASS
4692.00	V	5	1	0	-31.04	-13.00	-18.04	PASS
5474.00	V	5	1	0	-34.33	-13.00	-21.33	PASS

Test Band LTE Band 13 Test Mode: QPSK/ Middle Channel

Freq. (MHz)	H/V	Bandwidth (MHz)	RB Size	RB Offset	Emission Level(dBm)	Limit (dBm)	Margin (dBm)	Verdict
1564.00	H	10	1	0	-22.35	-13.00	-9.35	PASS
2346.00	H	10	1	0	-23.08	-13.00	-10.08	PASS
3128.00	H	10	1	0	-30.11	-13.00	-17.11	PASS
3910.00	H	10	1	0	-30.17	-13.00	-17.17	PASS
4692.00	H	10	1	0	-32.52	-13.00	-19.52	PASS
5474.00	H	10	1	0	-38.07	-13.00	-25.07	PASS
1564.00	V	10	1	0	-19.95	-13.00	-6.95	PASS
2346.00	V	10	1	0	-22.65	-13.00	-9.65	PASS
3128.00	V	10	1	0	-29.04	-13.00	-16.04	PASS
3910.00	V	10	1	0	-28.84	-13.00	-15.84	PASS
4692.00	V	10	1	0	-31.35	-13.00	-18.35	PASS
5474.00	V	10	1	0	-34.64	-13.00	-21.64	PASS

Note:

PMea= The power of signal source
Ppl = Path loss
Ga = Antenna Gain
Correct Factor(EIRP)=PMea -Ppl -Ga
Peak ERP=Correct Factor -Correction(ERP=EIRP-2.15)

Test Model	Band edge	
	LTE Band 4/ 3MHz /QPSK	
	Low Channel:19965	1 RB/ 0 offset

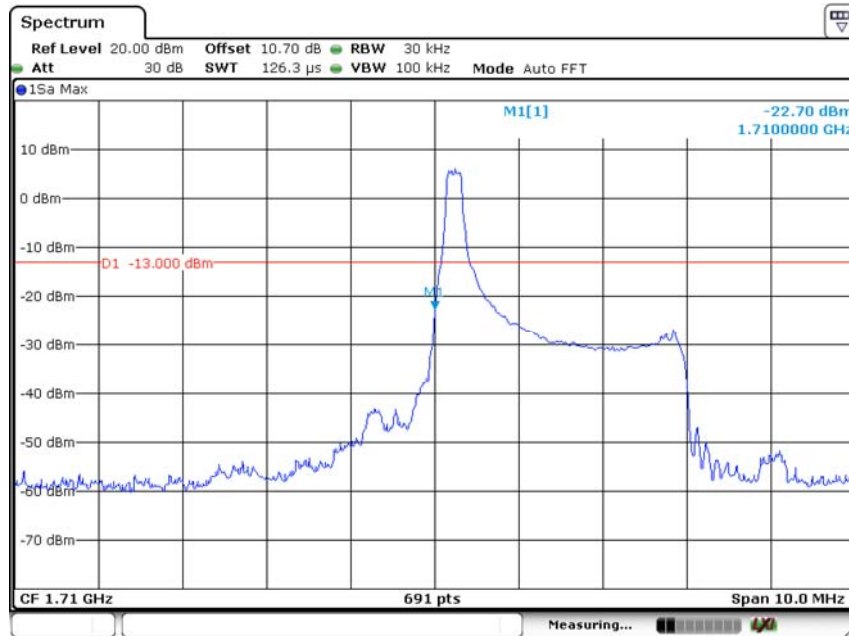

Test Model	Band edge	
	LTE Band 4/ 3MHz /QPSK	
	High Channel: 20385	1 RB/ 0 offset

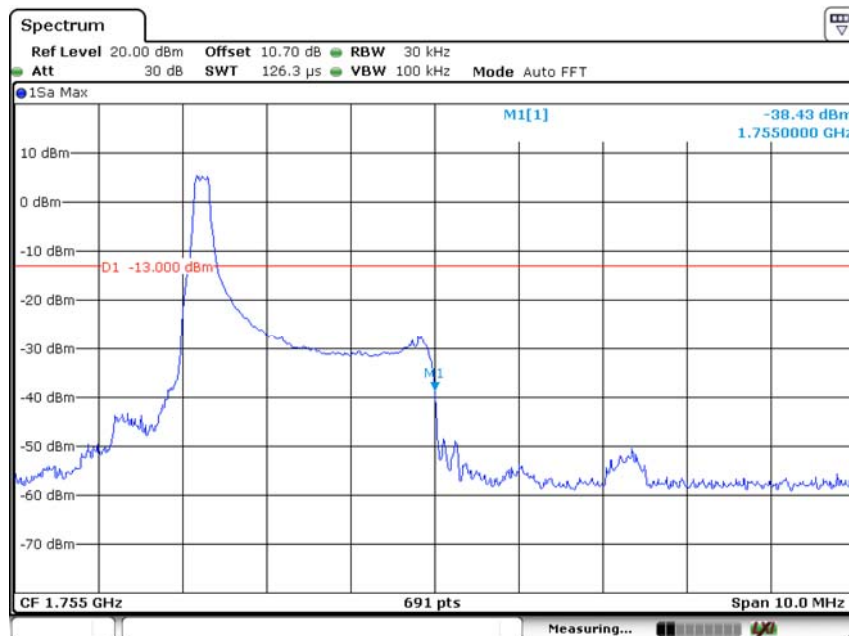

Test Model	Band edge	
	LTE Band 4/ 3MHz /QPSK	
	Low Channel: 19965	1 RB/ 14 offset

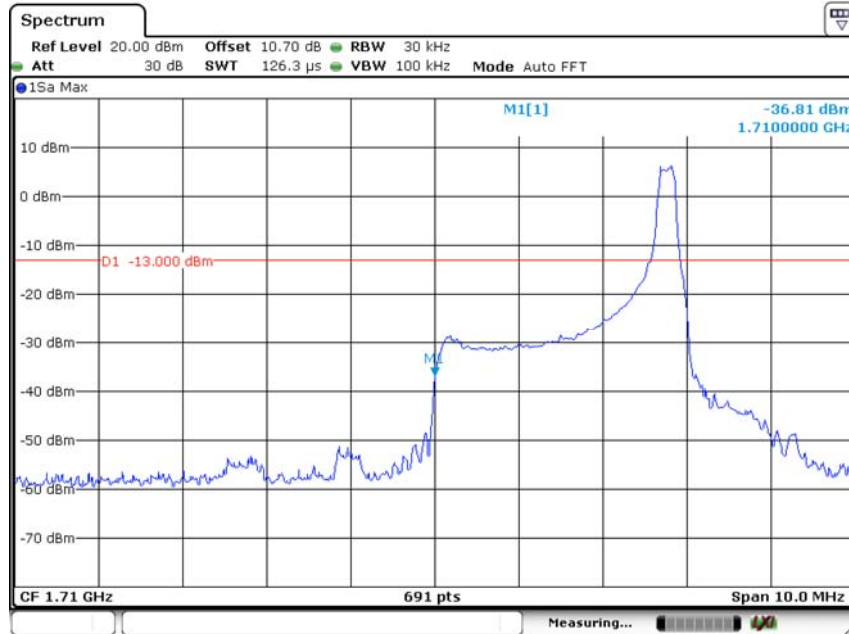

Test Model	Band edge	
	LTE Band 4/ 3MHz /QPSK	
	High Channel: 20385	1 RB/ 14 offset

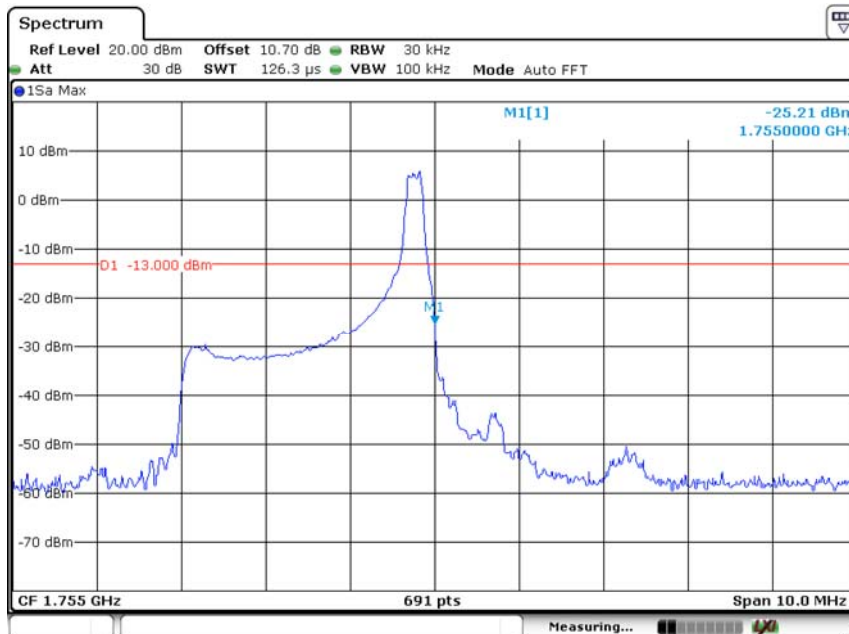

Test Model	Band edge	
	LTE Band 4/ 3MHz /QPSK	
	Low Channel: 19965	15 RB/ 0 offset

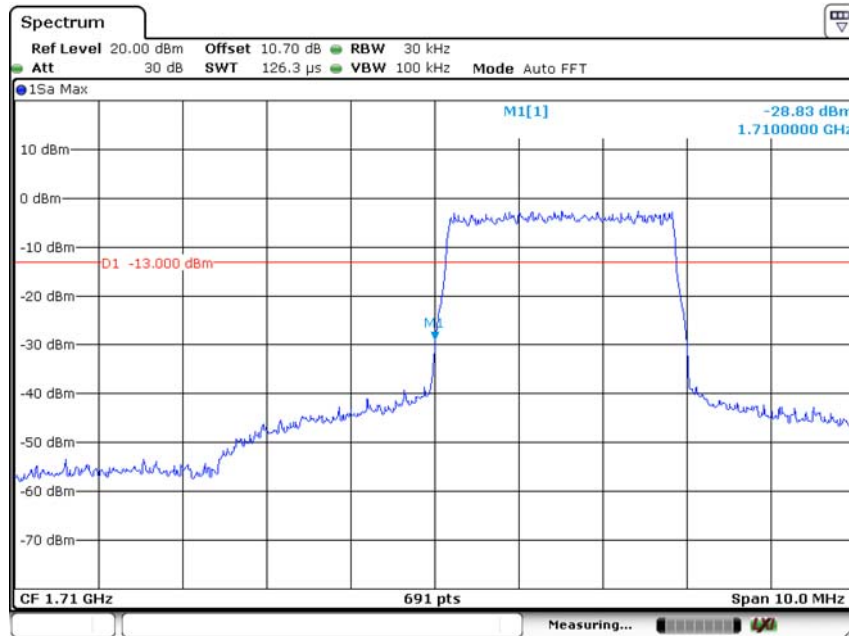

Test Model	Band edge	
	LTE Band 4/ 3MHz /QPSK	
	High Channel: 20385	15 RB/ 0 offset

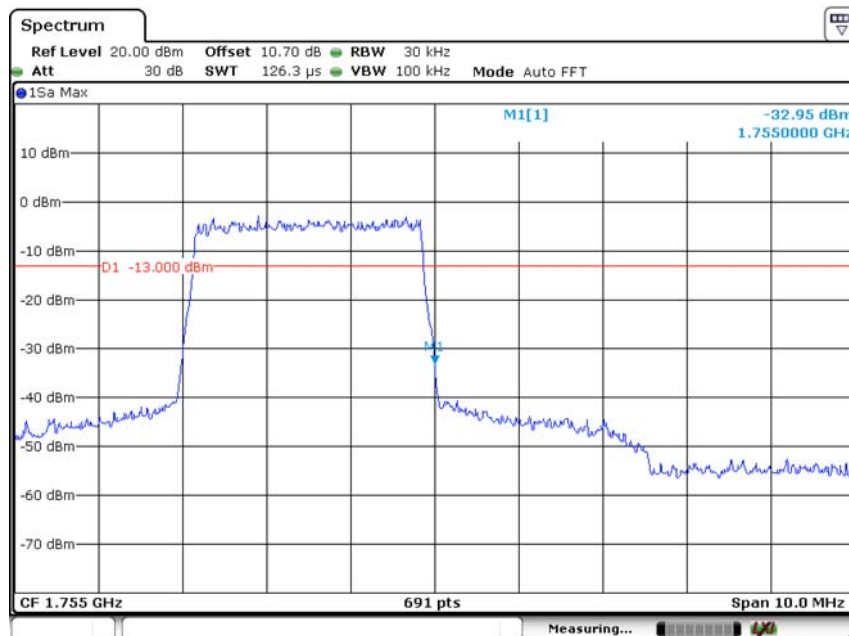

Test Model	Band edge	
	LTE Band 4/ 3MHz /16-QAM	
	Low Channel:19965	1 RB/ 0 offset

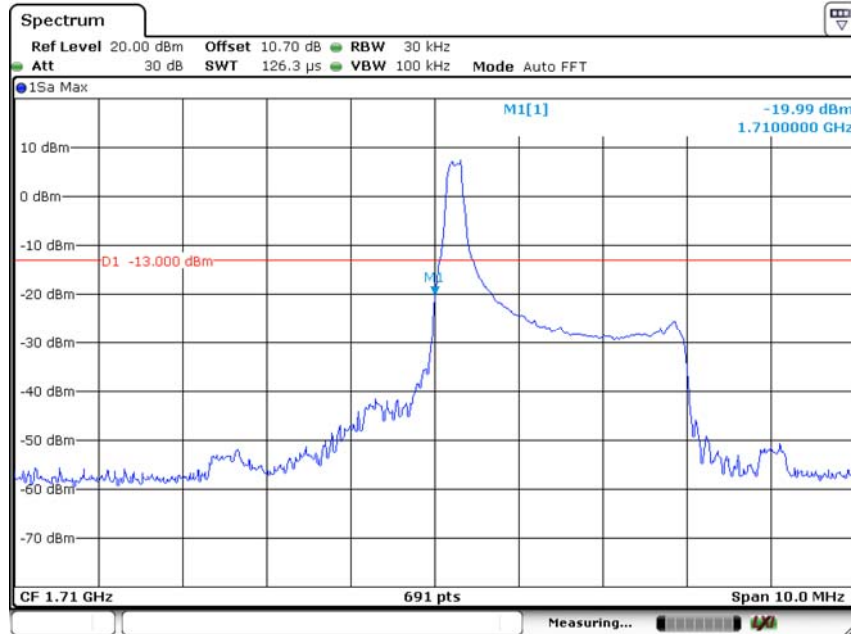

Test Model	Band edge	
	LTE Band 4/ 3MHz /16-QAM	
	High Channel: 20385	1 RB/ 0 offset

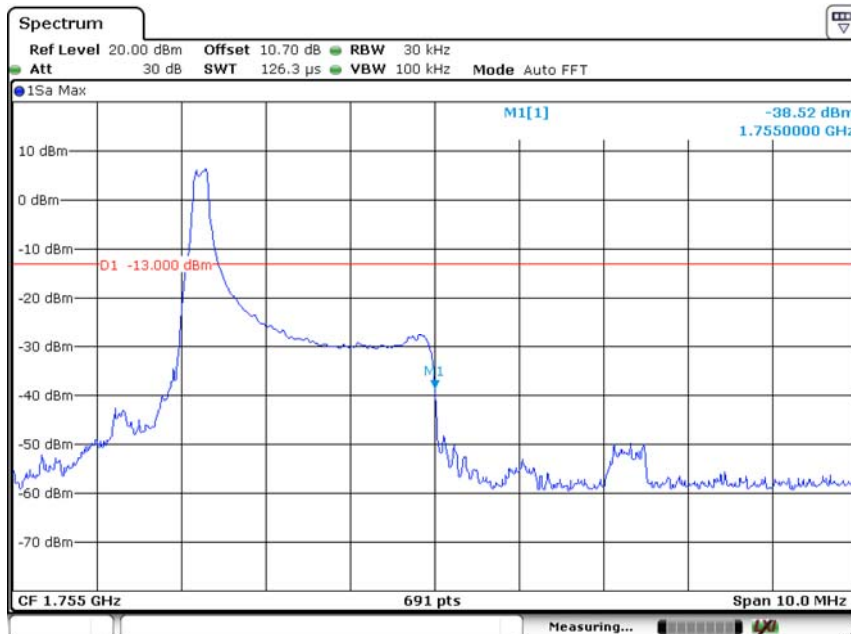

Test Model	Band edge	
	LTE Band 4/ 3MHz /16-QAM	
	Low Channel: 19965	1 RB/ 14 offset

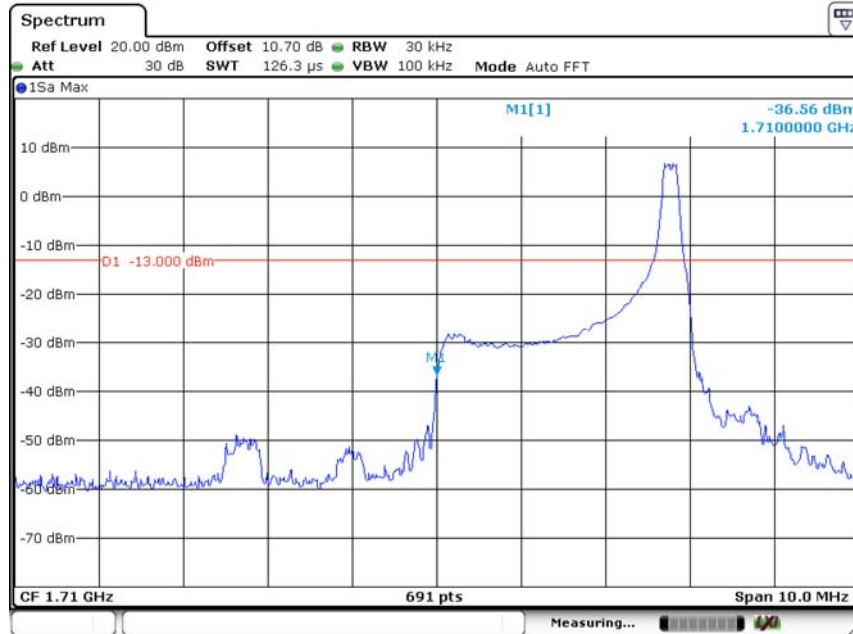

Test Model	Band edge	
	LTE Band 4/ 3MHz /16-QAM	
	High Channel: 20385	1 RB/ 14 offset

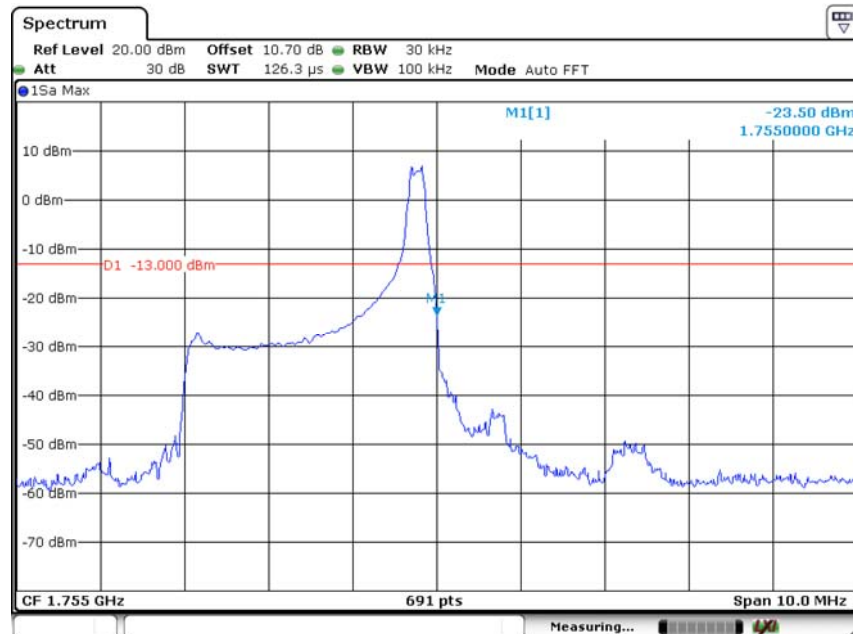

Test Model	Band edge	
	LTE Band 4/ 3MHz /16-QAM	
	Low Channel: 19965	15 RB/ 0 offset

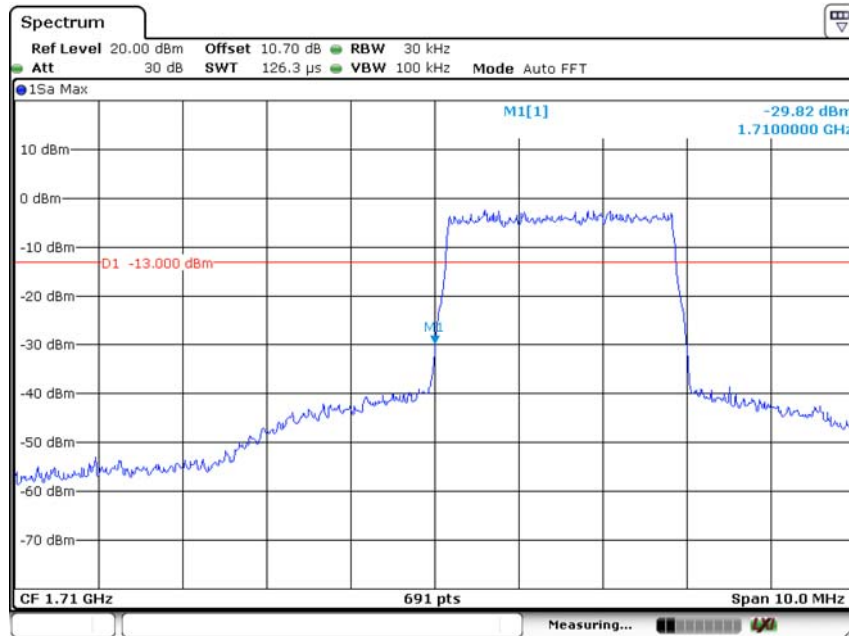

Test Model	Band edge	
	LTE Band 4/ 3MHz /16-QAM	
	High Channel: 20385	15 RB/ 0 offset

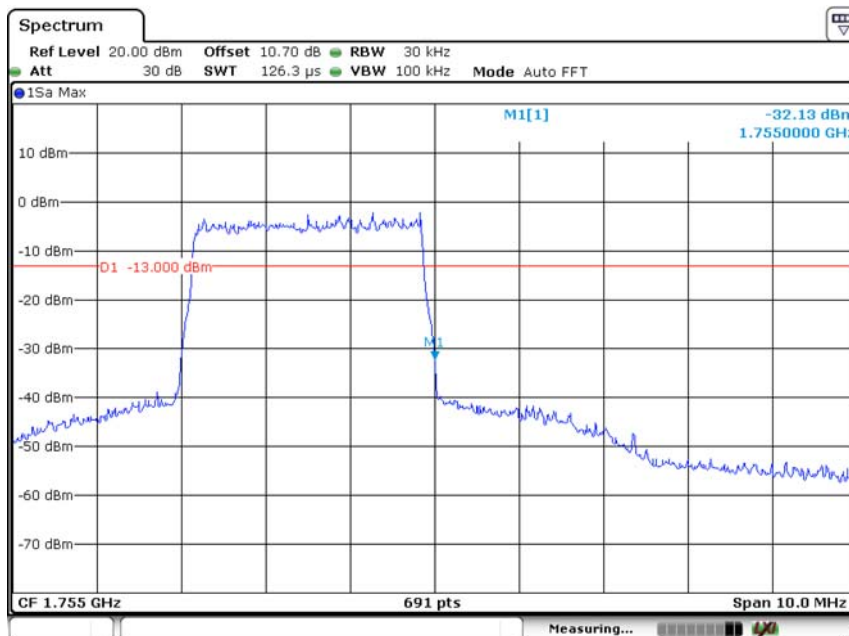

Test Model	Band edge	
	LTE Band 4/ 5MHz /QPSK	
	Low Channel: 19975	1 RB/ 0 offset

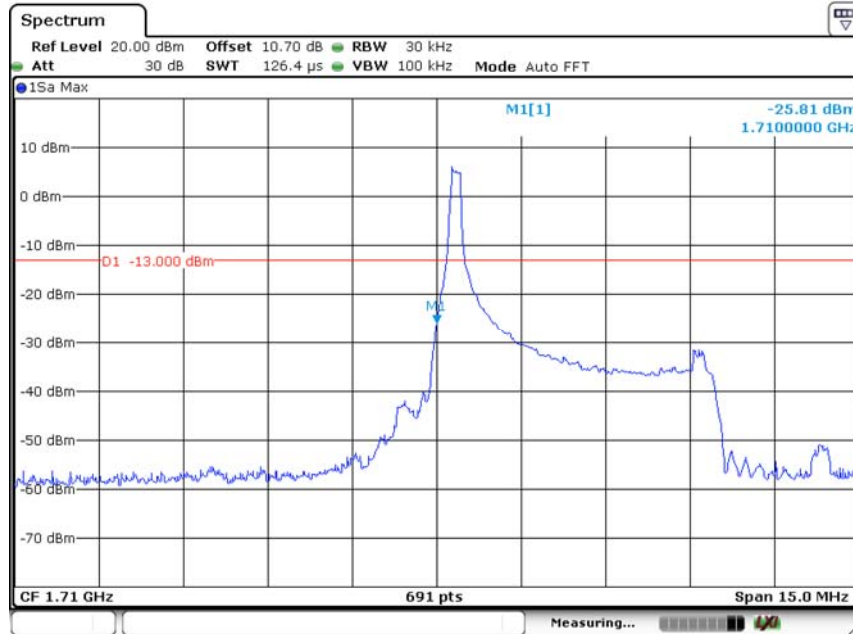

Test Model	Band edge	
	LTE Band 4/ 5MHz /QPSK	
	High Channel: 20375	1 RB/ 0 offset

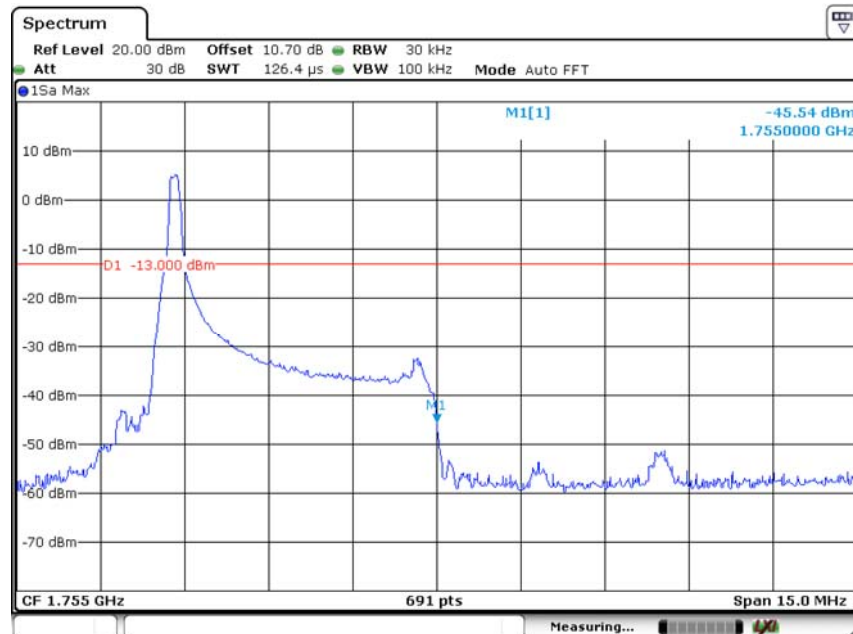

Test Model	Band edge	
	LTE Band 4/ 5MHz /QPSK	
	Low Channel: 19975	1 RB/ 24 offset

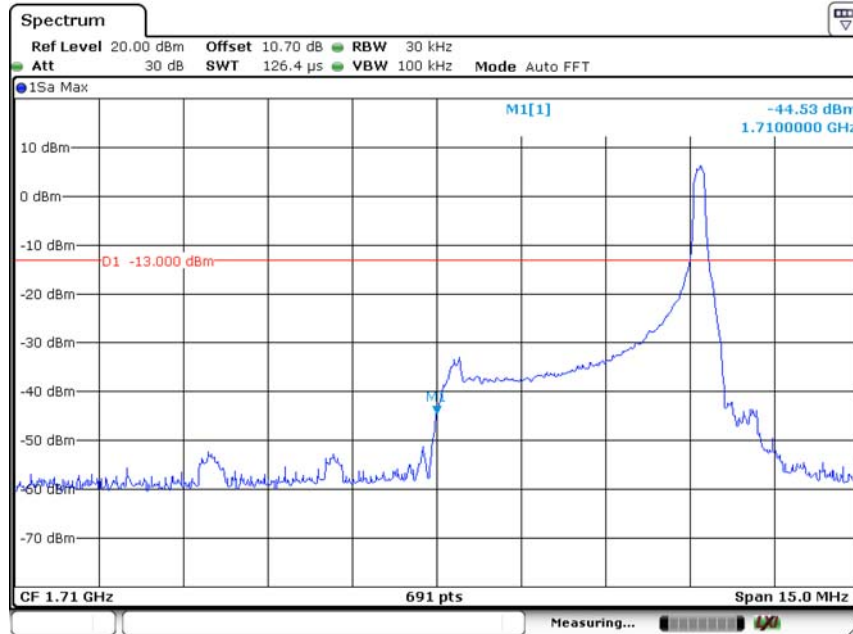

Test Model	Band edge	
	LTE Band 4/ 5MHz /QPSK	
	High Channel: 20375	1 RB/ 24 offset

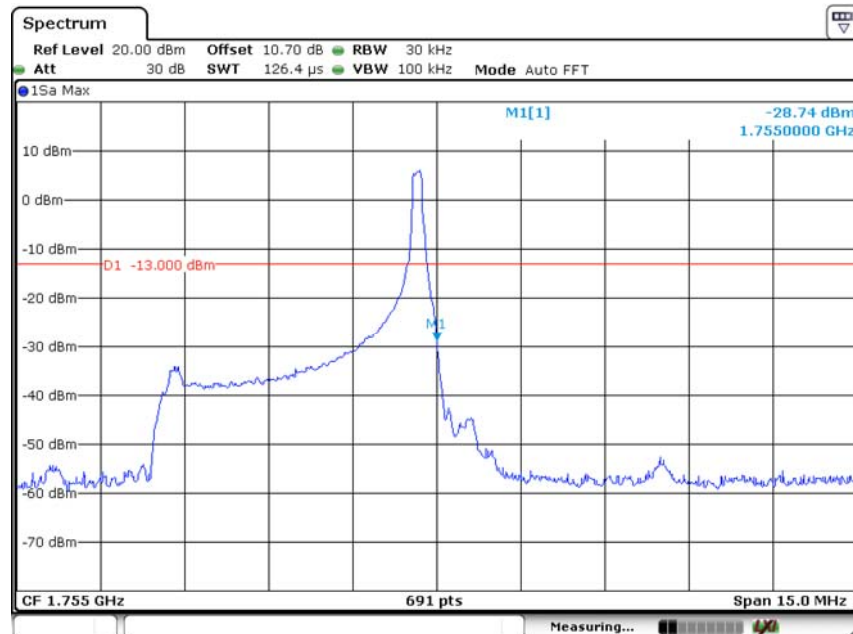

Test Model	Band edge	
	LTE Band 4/ 5MHz /QPSK	
	Low Channel: 19975	25 RB/ 0 offset

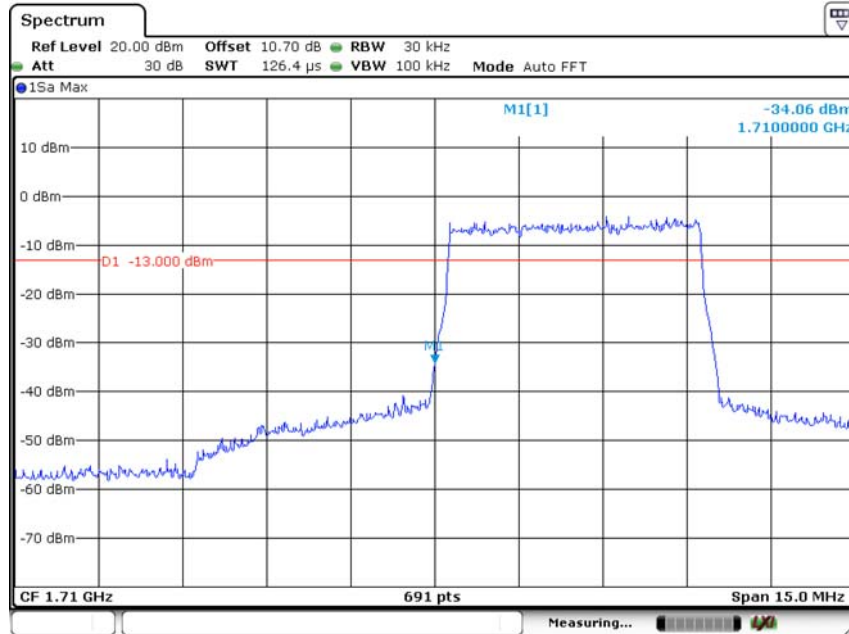

Test Model	Band edge	
	LTE Band 4/ 5MHz /QPSK	
	High Channel: 20375	25 RB/ 0 offset

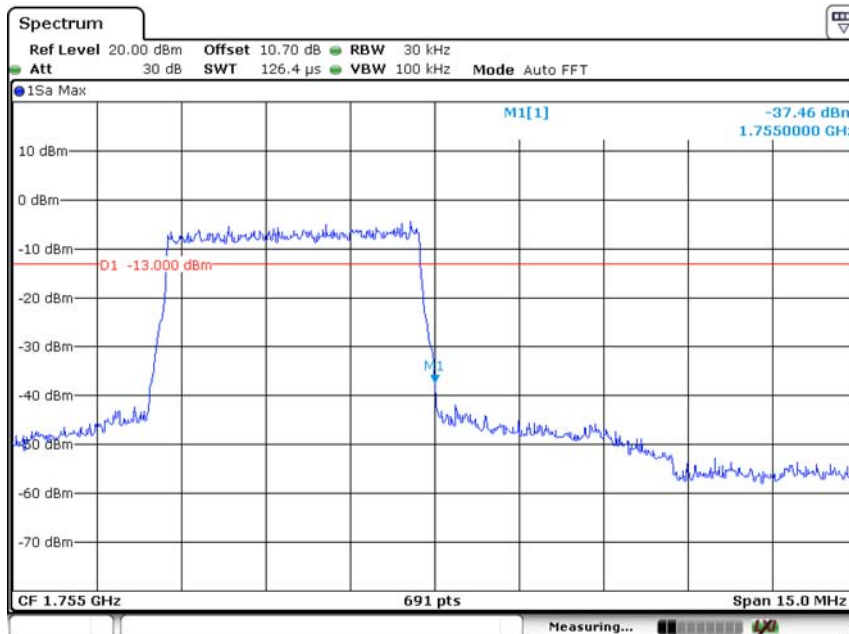

Test Model	Band edge	
	LTE Band 4/ 5MHz /16-QAM	
	Low Channel:19975	1 RB/ 0 offset

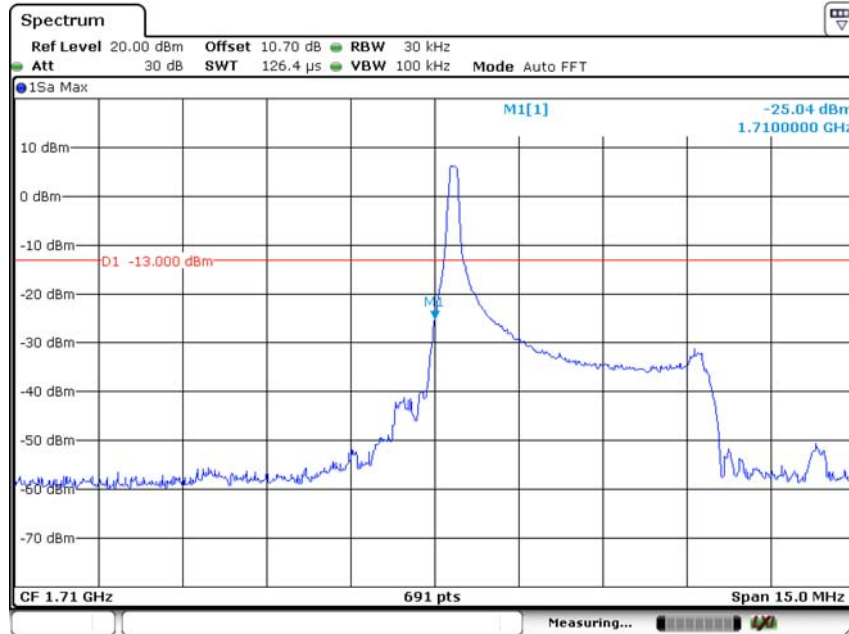

Test Model	Band edge	
	LTE Band 4/ 5MHz /16-QAM	
	High Channel: 20375	1 RB/ 0 offset

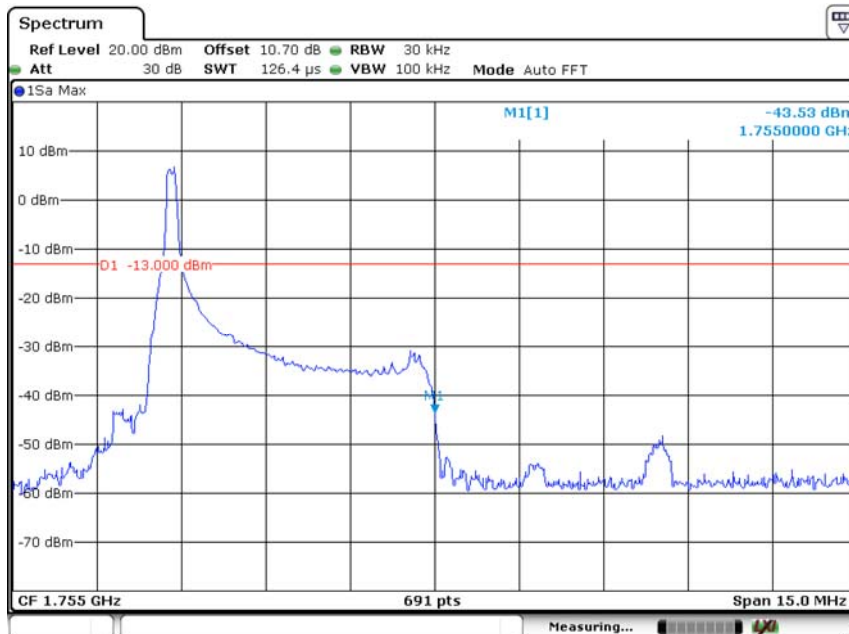

Test Model	Band edge	
	LTE Band 4/ 5MHz /16-QAM	
	Low Channel: 19975	1 RB/ 24 offset

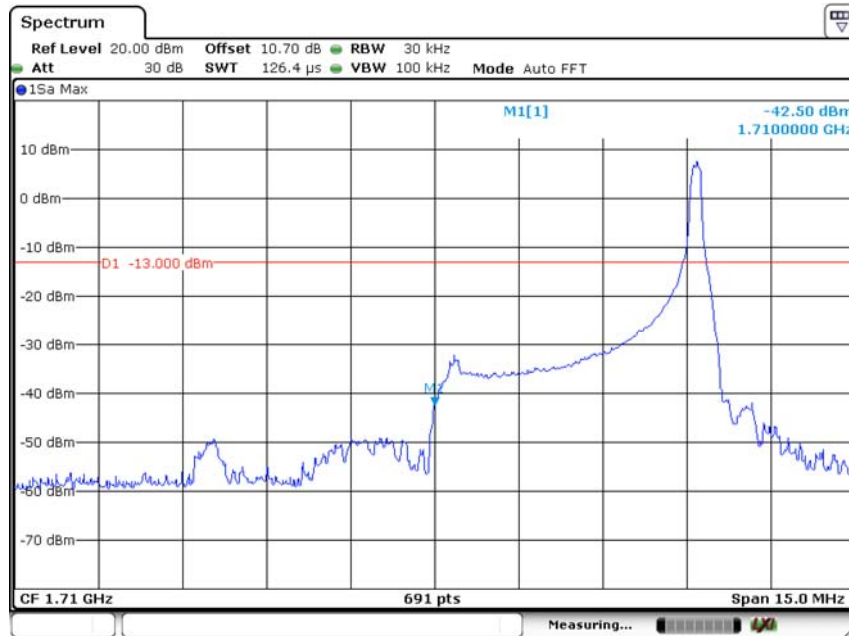

Test Model	Band edge	
	LTE Band 4/ 5MHz /16-QAM	
	High Channel: 20375	1 RB/ 24 offset

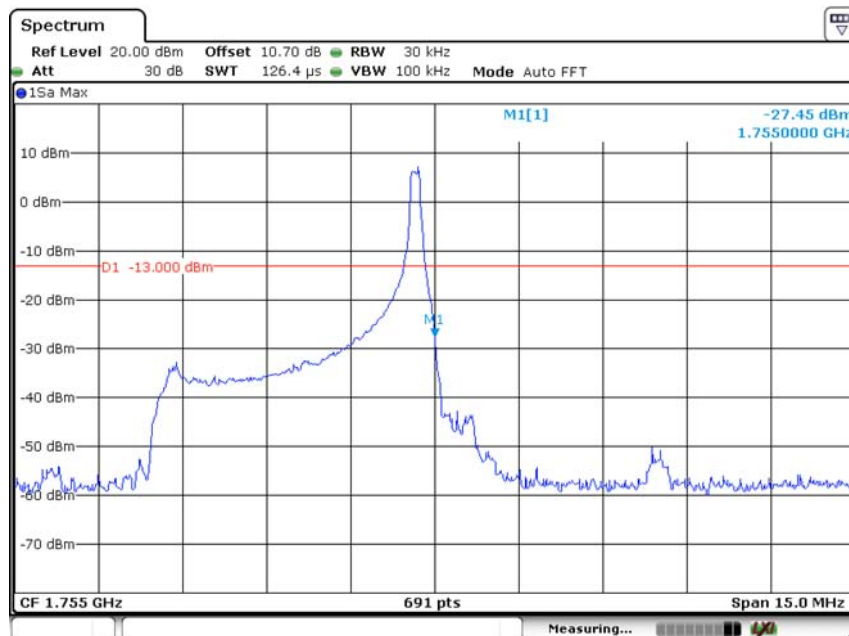

Test Model	Band edge	
	LTE Band 4/ 5MHz /16-QAM	
	Low Channel: 19975	25 RB/ 0 offset

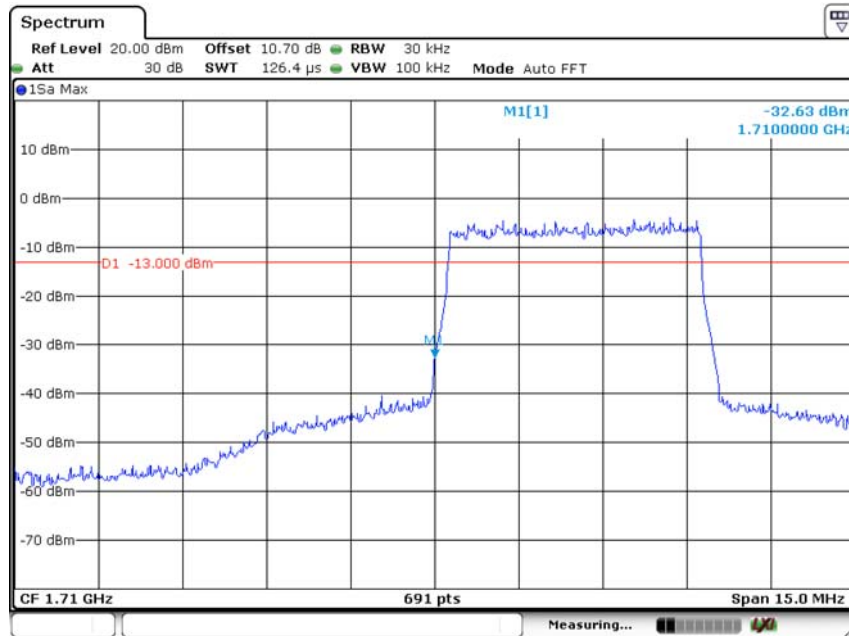

Test Model	Band edge	
	LTE Band 4/ 5MHz /16-QAM	
	High Channel: 20375	25 RB/ 0 offset

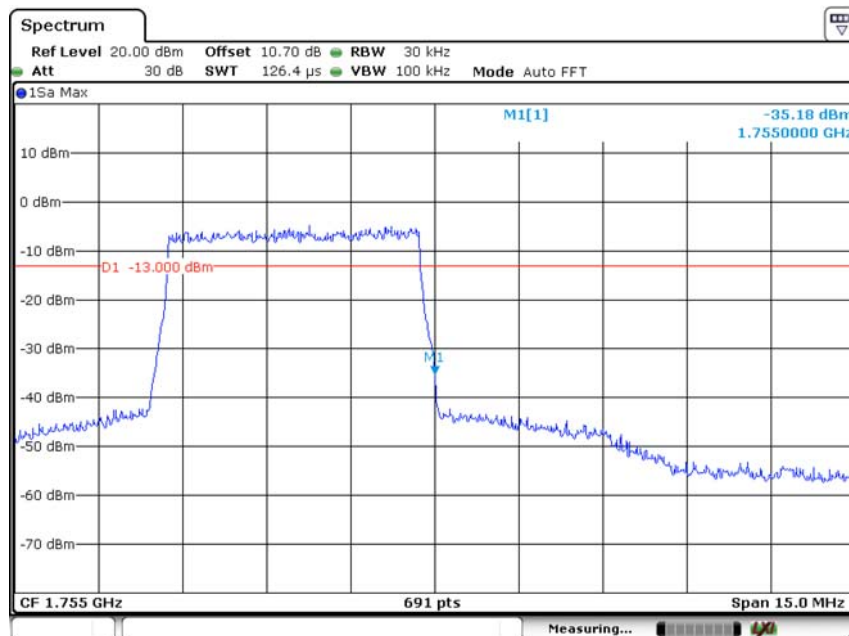

Test Model	Band edge	
	LTE Band 4/ 20MHz /QPSK	
	Low Channel: 20050	1 RB/ 0 offset

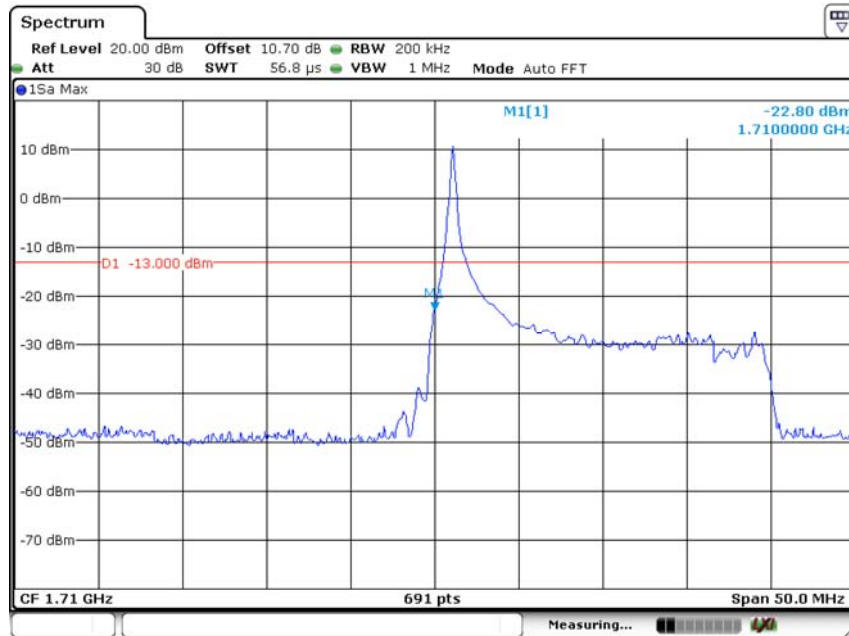

Test Model	Band edge	
	LTE Band 4/ 20MHz /QPSK	
	High Channel: 20300	1 RB/ 0 offset

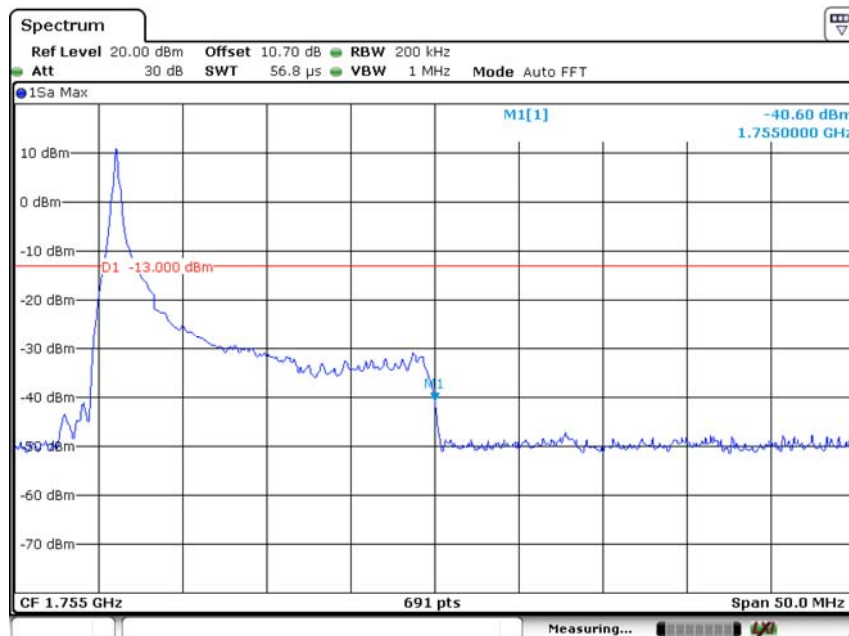

Test Model	Band edge	
	LTE Band 4/ 20MHz /QPSK	
	Low Channel: 20050	1 RB/ 99 offset

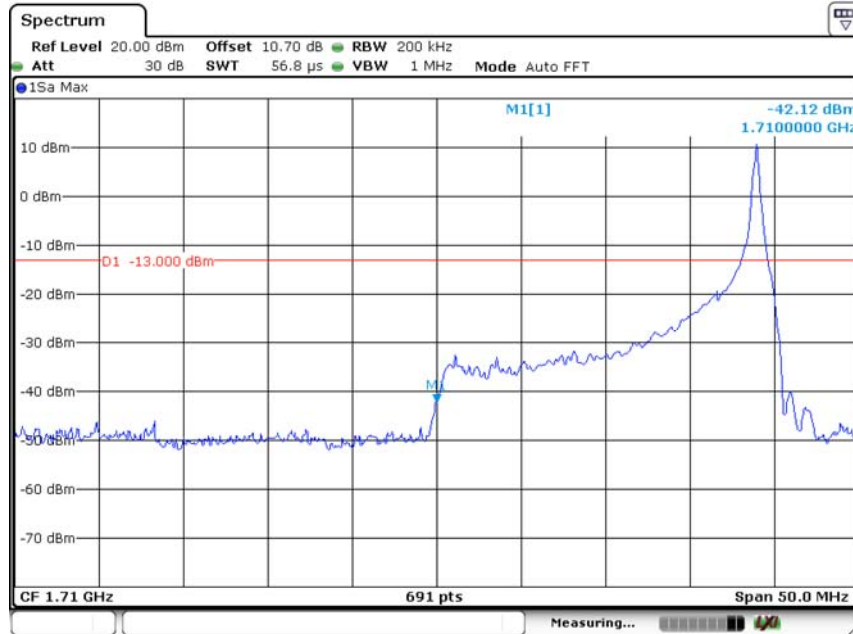

Test Model	Band edge	
	LTE Band 4/ 20MHz /QPSK	
	High Channel: 20300	1 RB/ 99 offset

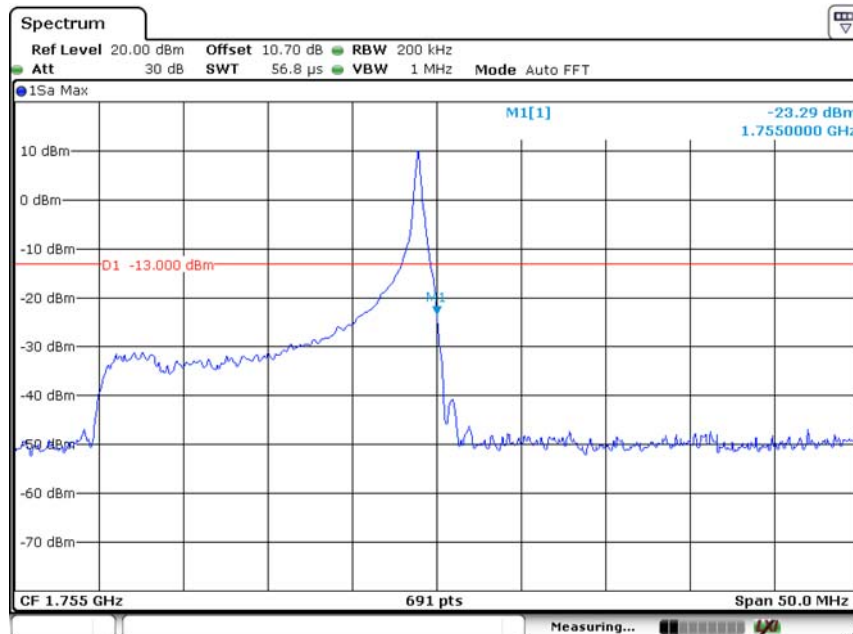

Test Model	Band edge	
	LTE Band 4/ 20MHz /QPSK	
	Low Channel: 20050	100 RB/ 0 offset

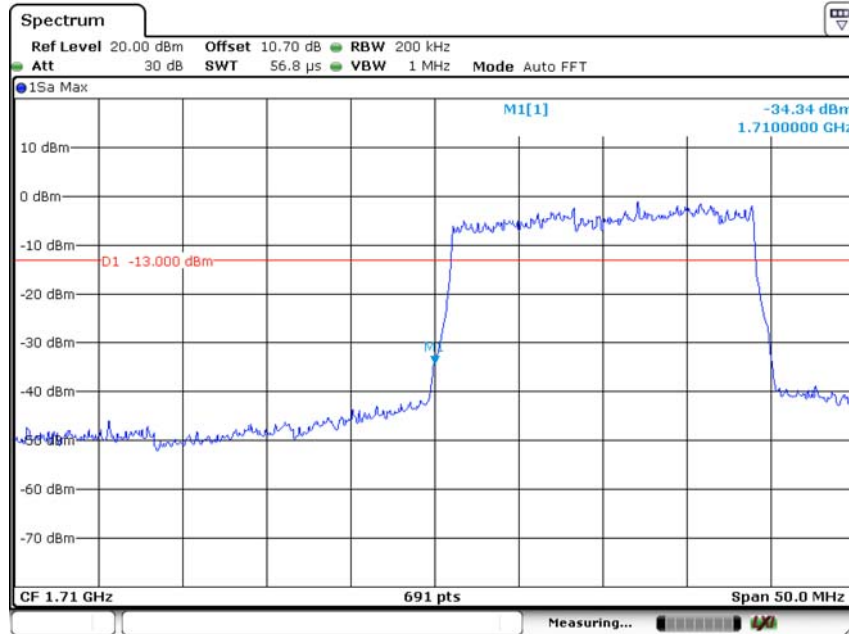

Test Model	Band edge	
	LTE Band 4/ 20MHz /QPSK	
	High Channel: 20300	100 RB/ 0 offset

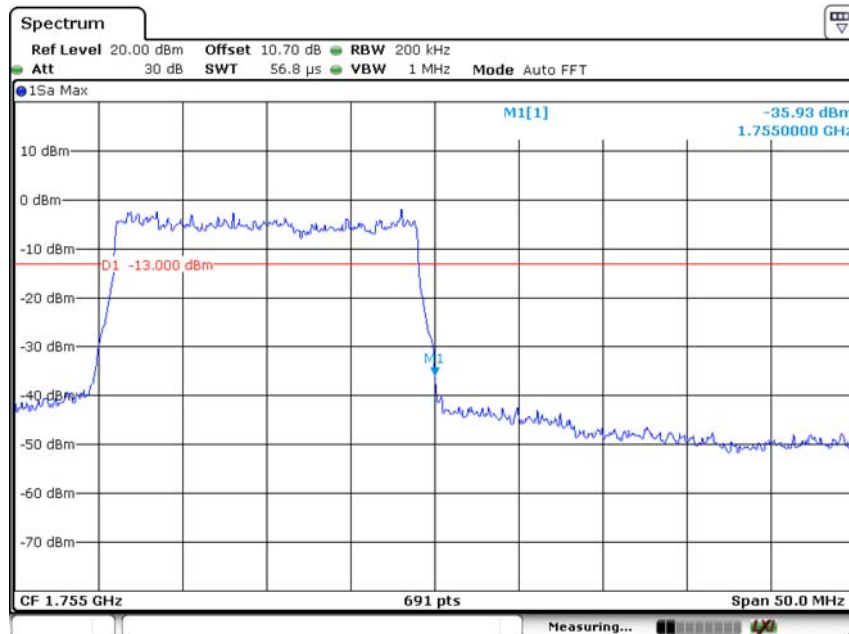

Test Model	Band edge	
	LTE Band 4/ 20MHz /16-QAM	
	Low Channel: 20050	1 RB/ 0 offset

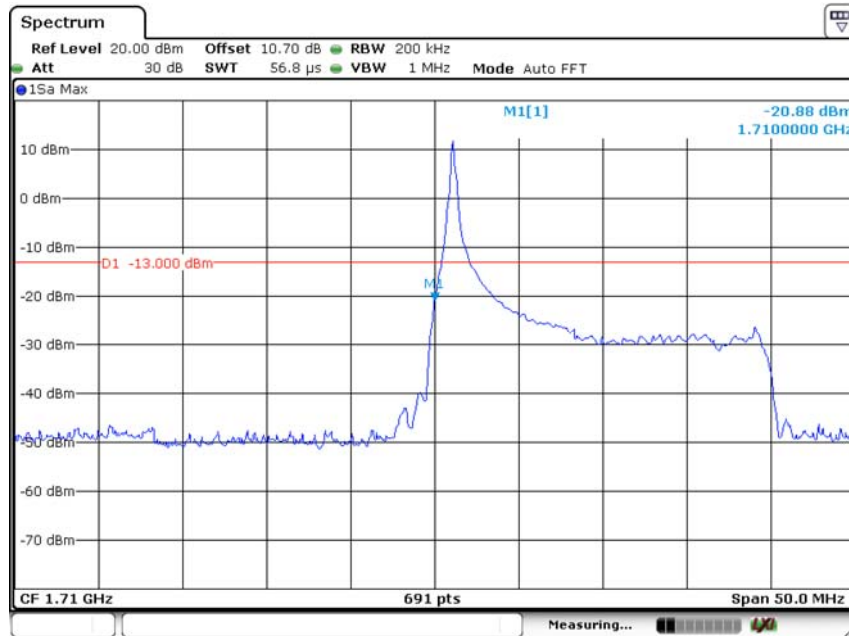

Test Model	Band edge	
	LTE Band 4/ 20MHz /16-QAM	
	High Channel: 20300	1 RB/ 0 offset

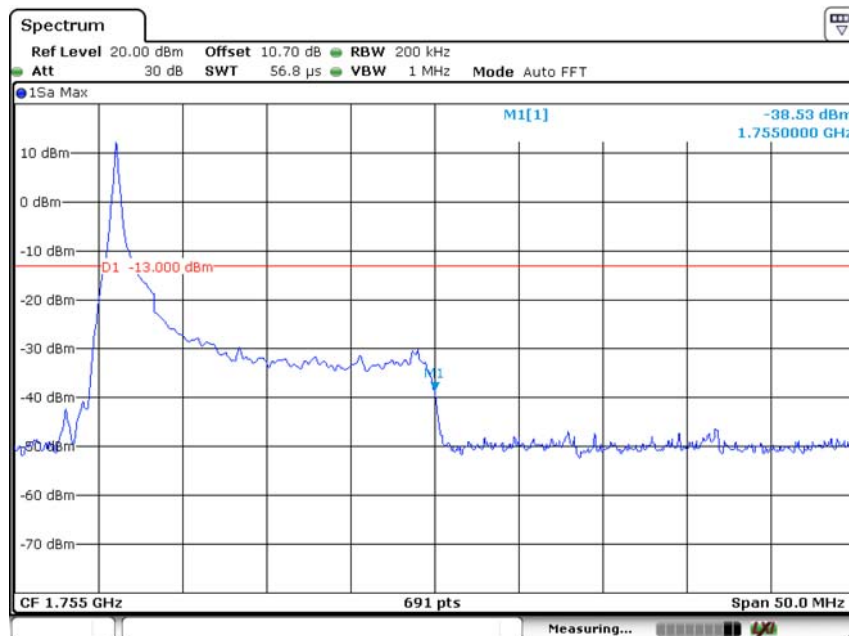

Test Model	Band edge	
	LTE Band 4/ 20MHz /16-QAM	
	Low Channel: 20050	1 RB/ 99 offset

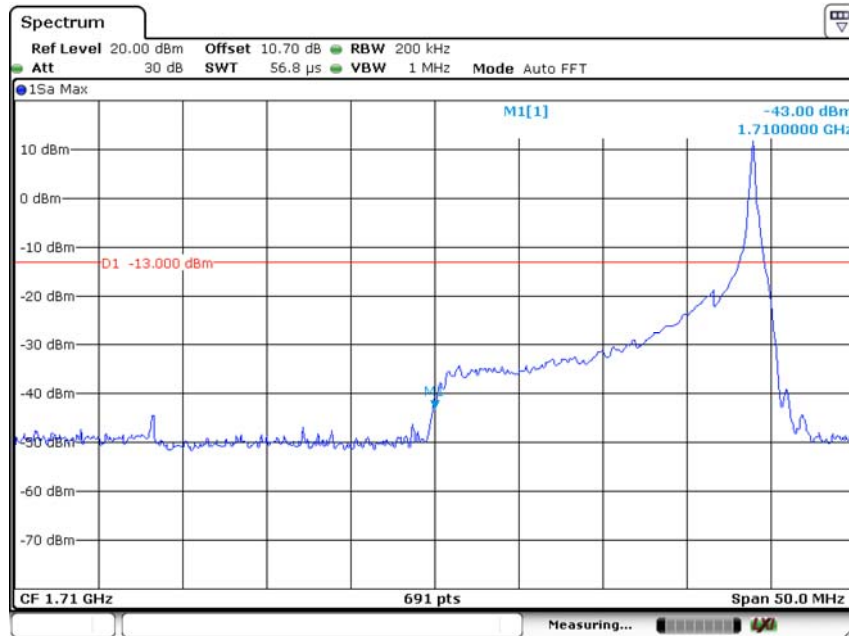

Test Model	Band edge	
	LTE Band 4/ 3MHz /16-QAM	
	High Channel: 20300	1 RB/ 99 offset

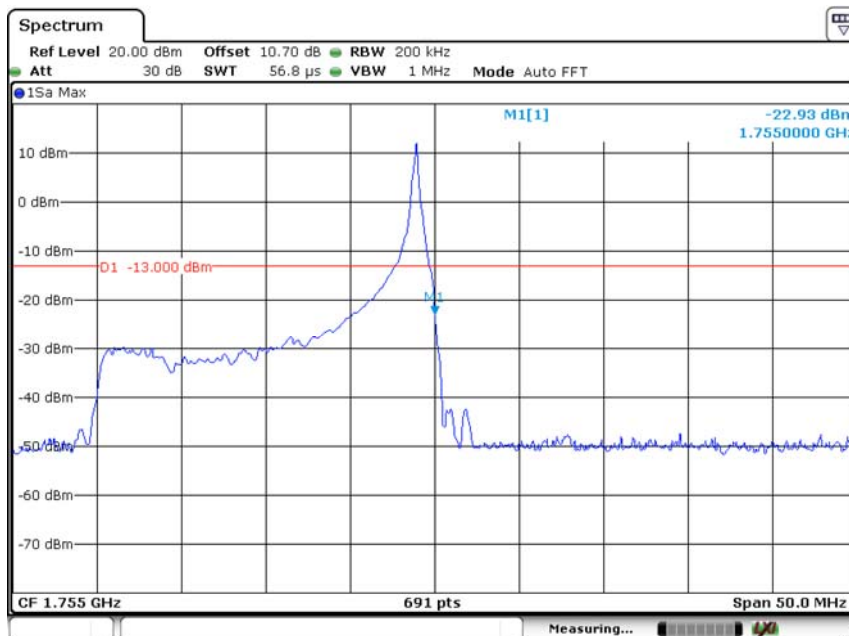

Test Model	Band edge	
	LTE Band 4/ 20MHz /16-QAM	
	Low Channel: 20050	100 RB/ 0 offset

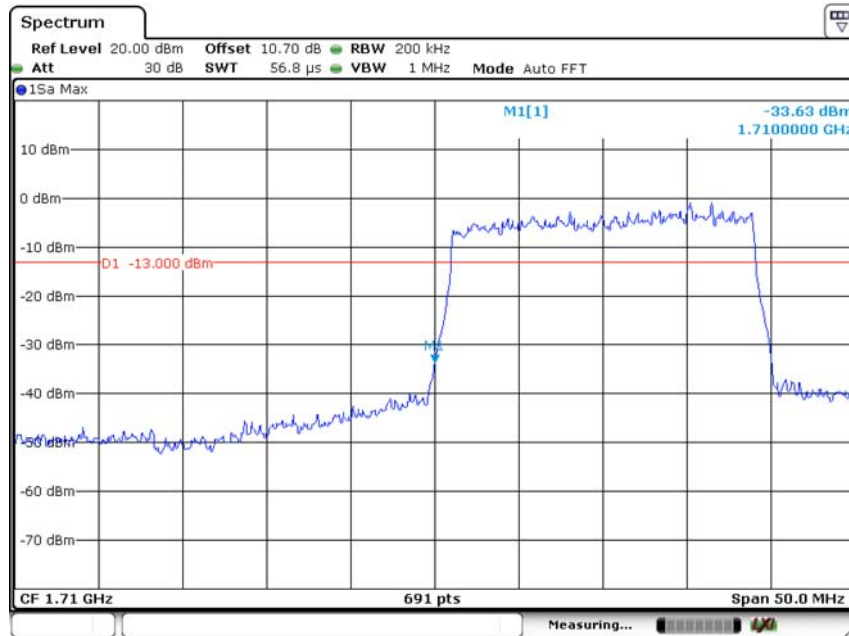

Test Model	Band edge	
	LTE Band 4/ 20MHz /16-QAM	
	High Channel: 20300	100 RB/ 0 offset

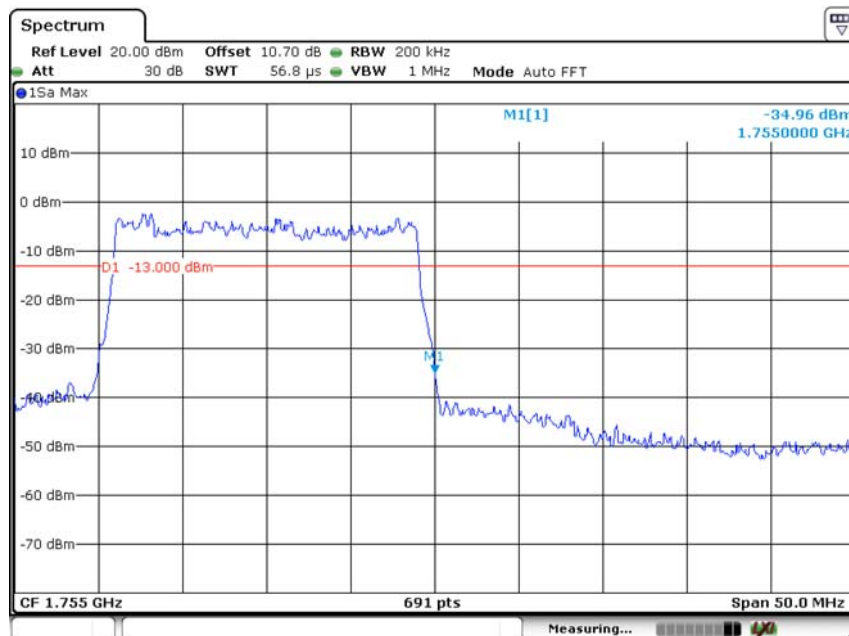

Test Model	Band edge	
	LTE Band 13/ 5MHz /16-QAM	
	Low Channel: 23205	1 RB/ 0 offset

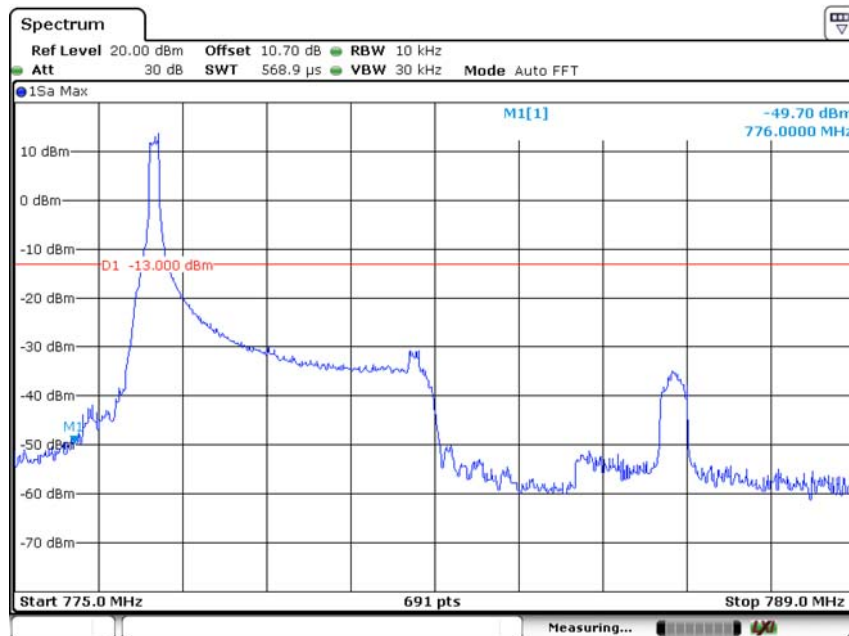
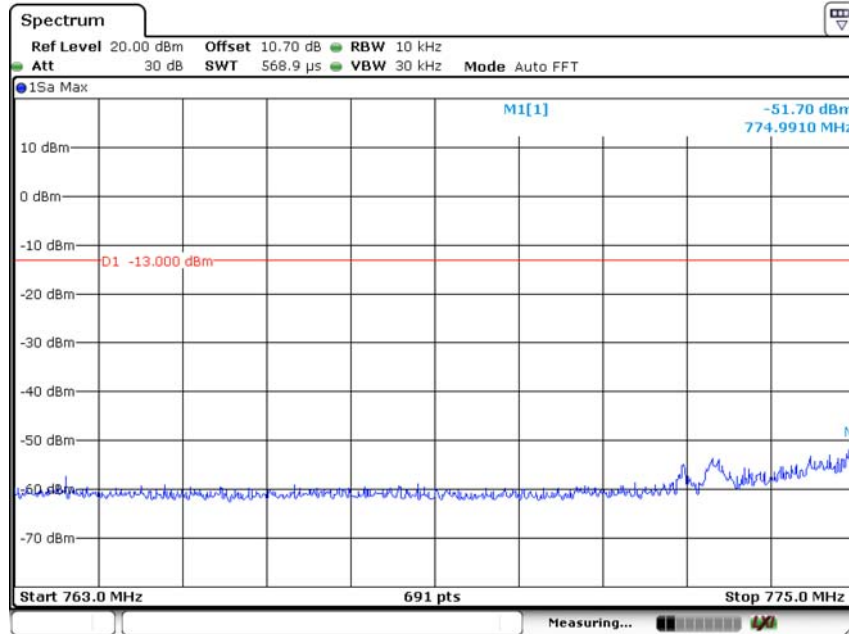

Test Model	Band edge	
	LTE Band 13/ 5MHz /16-QAM	
	High Channel: 23255	1 RB/ 0 offset

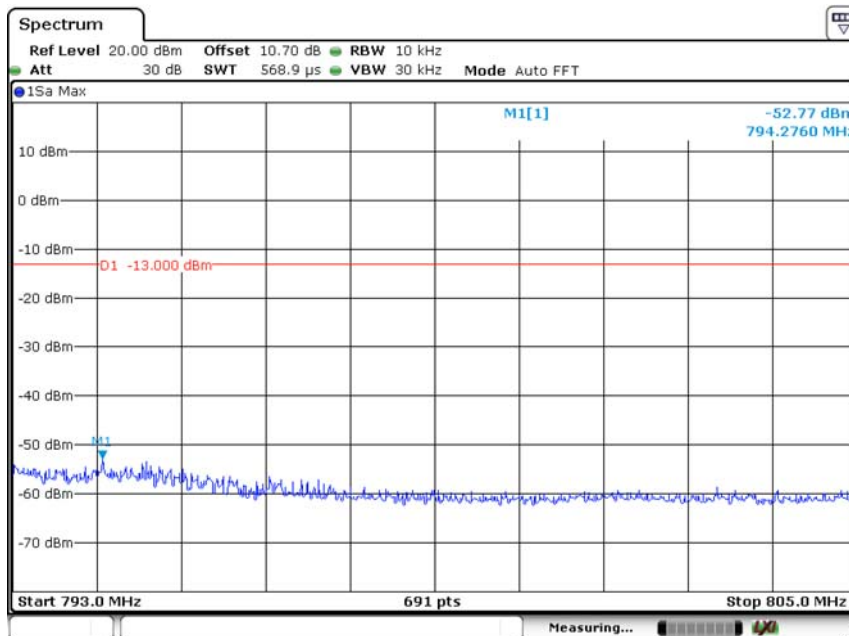
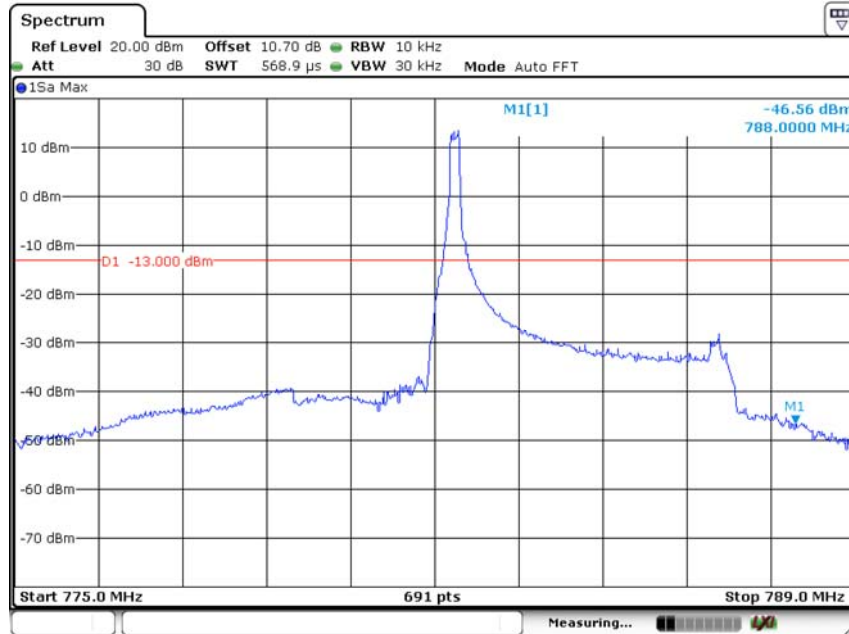

Test Model	Band edge	
	LTE Band 13/ 5MHz /QPSK	
	Low Channel: 23205	1 RB/ 0 offset

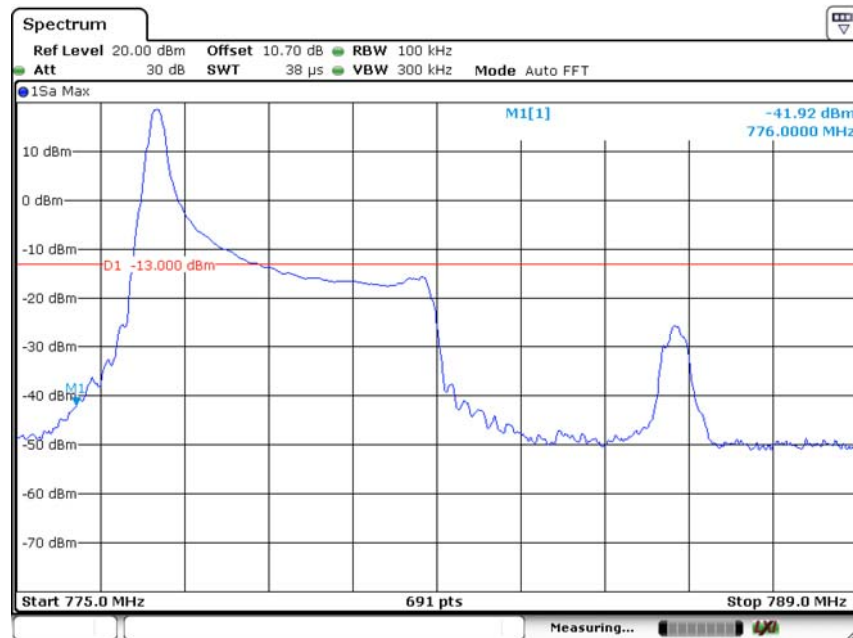
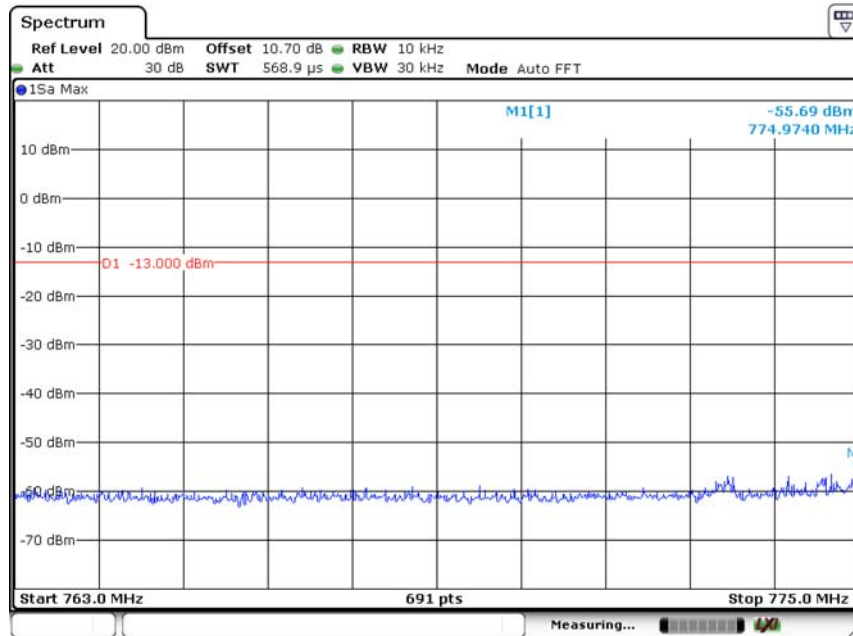

Test Model	Band edge	
	LTE Band 13/ 5MHz /QPSK	
	High Channel: 23255	1 RB/ 0 offset

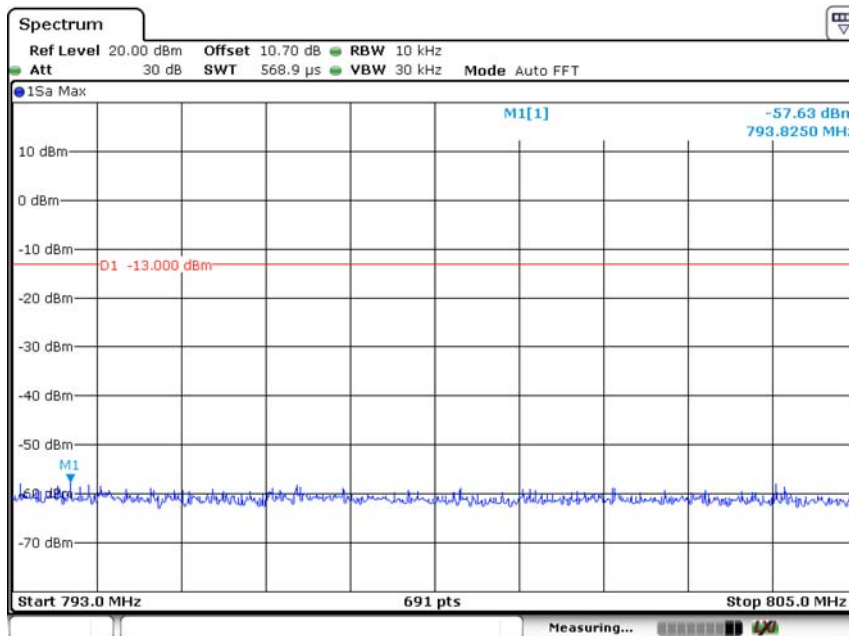

Test Model	Conducted Emissions	
	LTE Band 4	
	Low Channel /20MHz	QPSK/Full RB

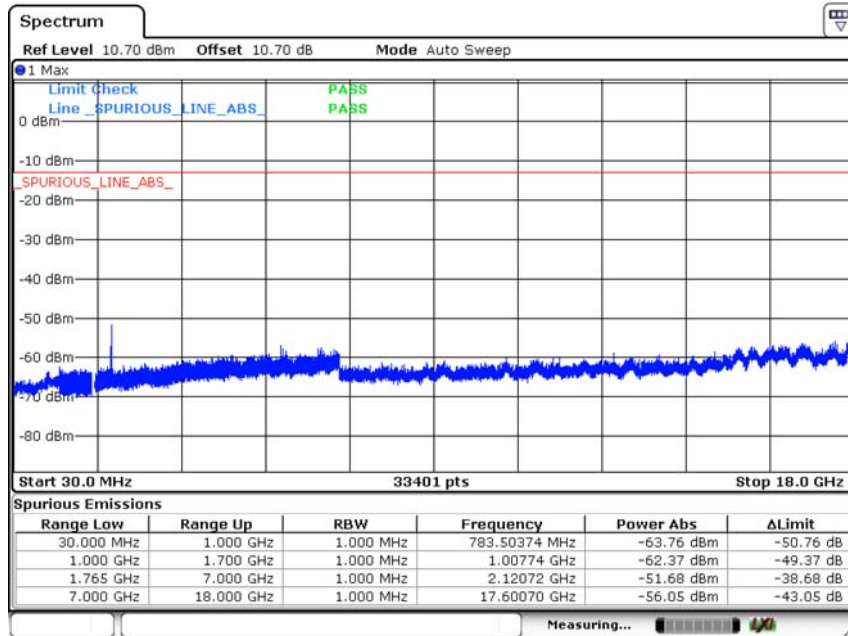

Test Model	Conducted Emissions	
	LTE Band 4	
	Middle Channel /20MHz	QPSK/Full RB

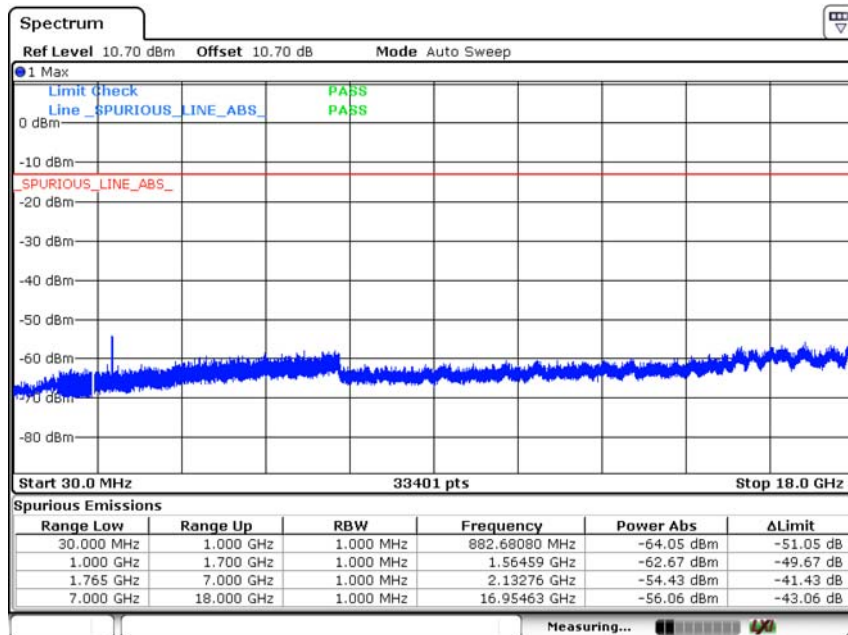

Test Model	Conducted Emissions	
	LTE Band 4	
	High Channel /20MHz	QPSK/Full RB

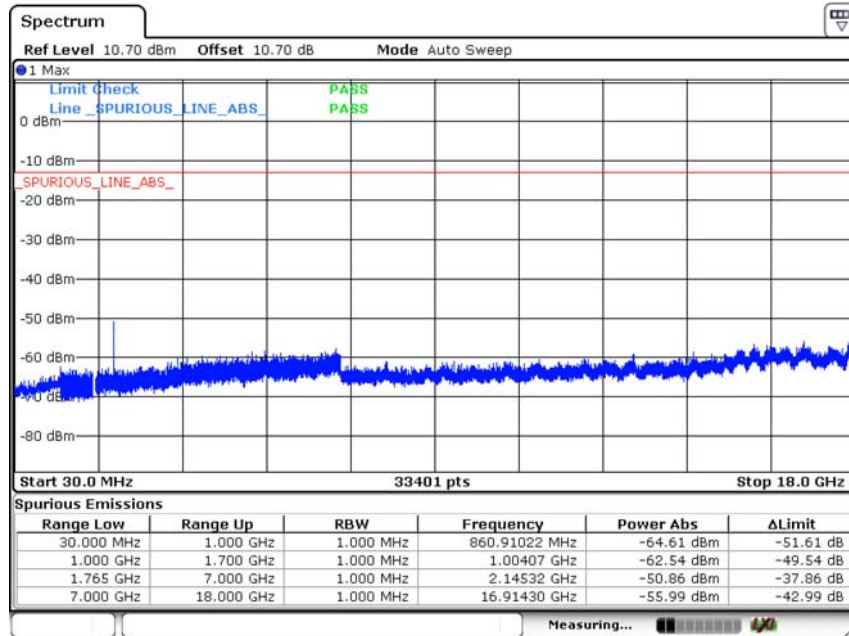

Test Model	Conducted Emissions	
	LTE Band 4	
	Low Channel /5MHz	QPSK/Full RB

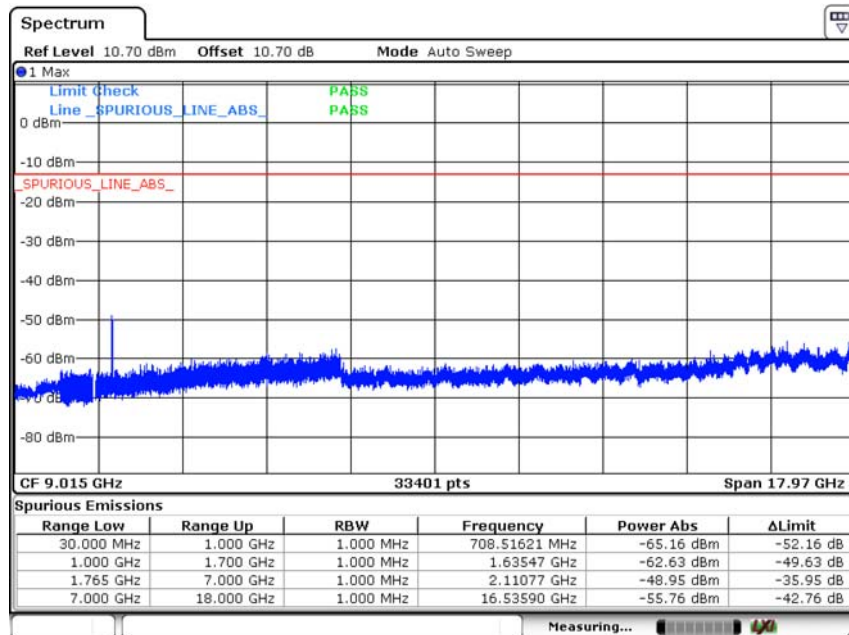

Test Model	Conducted Emissions	
	LTE Band 4	
	Middle Channel /5MHz	QPSK/Full RB

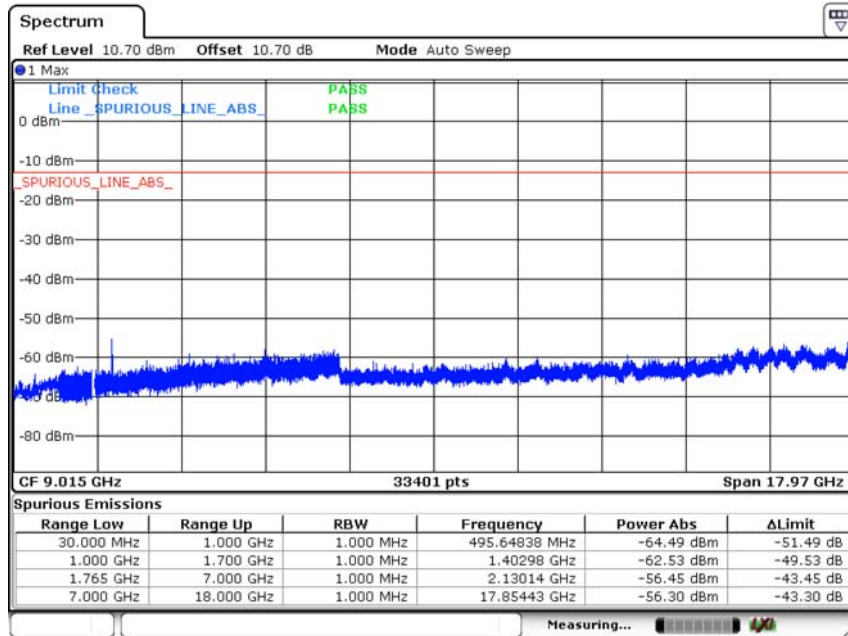

Test Model	Conducted Emissions	
	LTE Band 4	
	High Channel /5MHz	QPSK/Full RB

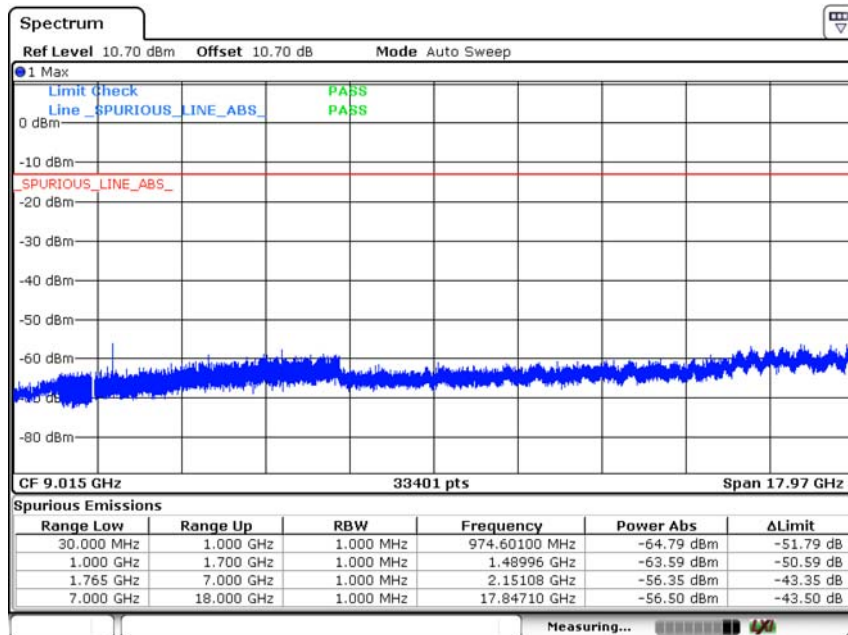

Test Model	Conducted Emissions	
	LTE Band 4	
	Low Channel /3MHz	QPSK/Full RB

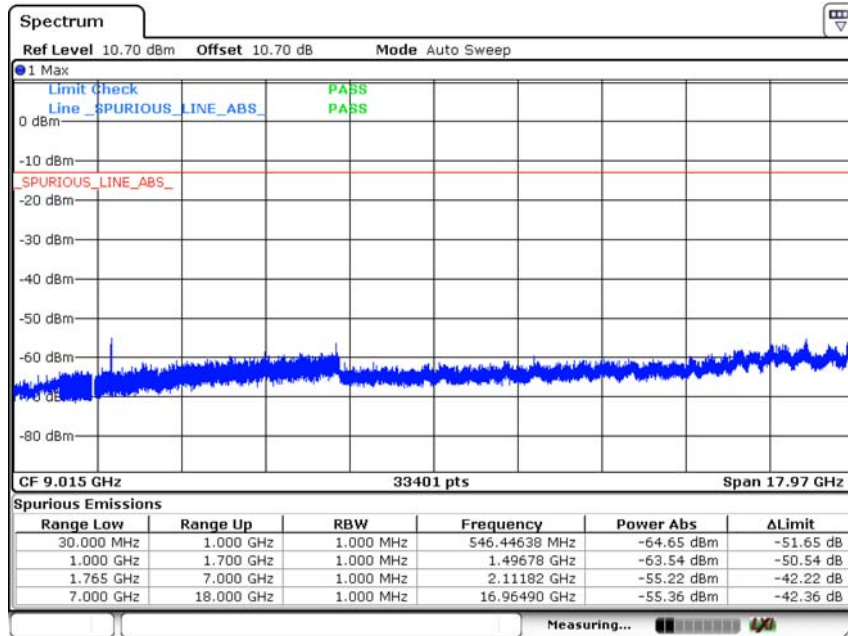

Test Model	Conducted Emissions	
	LTE Band 4	
	Middle Channel /3MHz	QPSK/Full RB

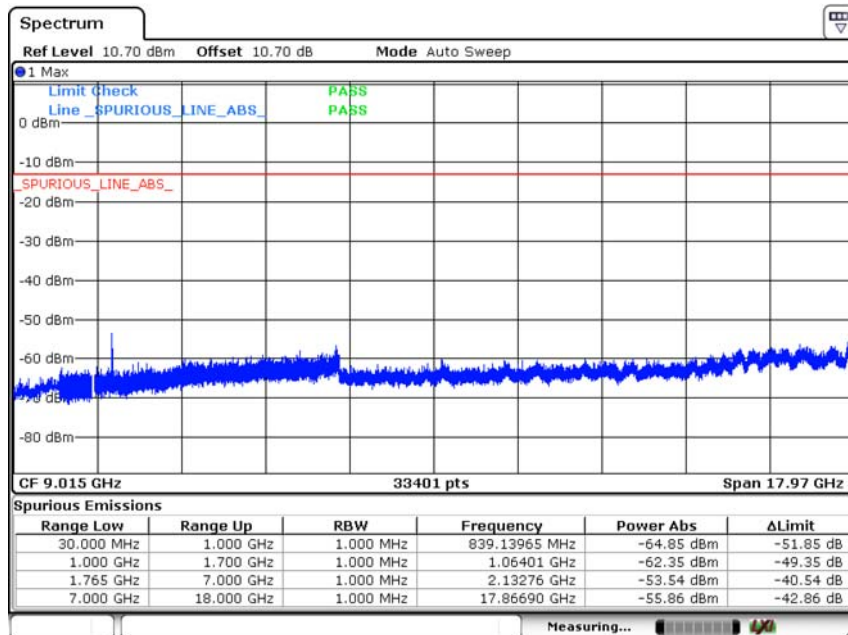

Test Model	Conducted Emissions	
	LTE Band 4	
	High Channel /3MHz	QPSK/Full RB

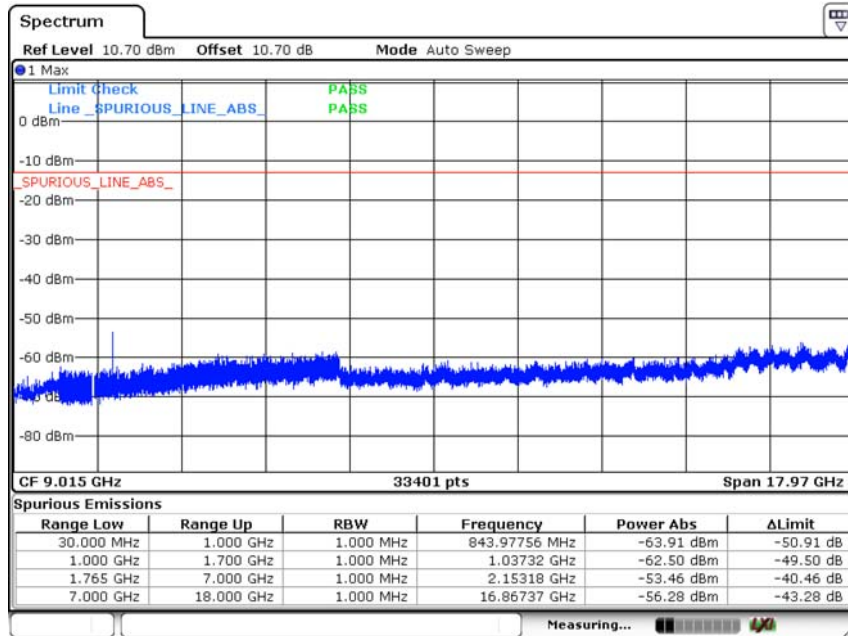

Test Model	Conducted Emissions	
	LTE Band 13	
	Low Channel /5MHz	QPSK/Full RB

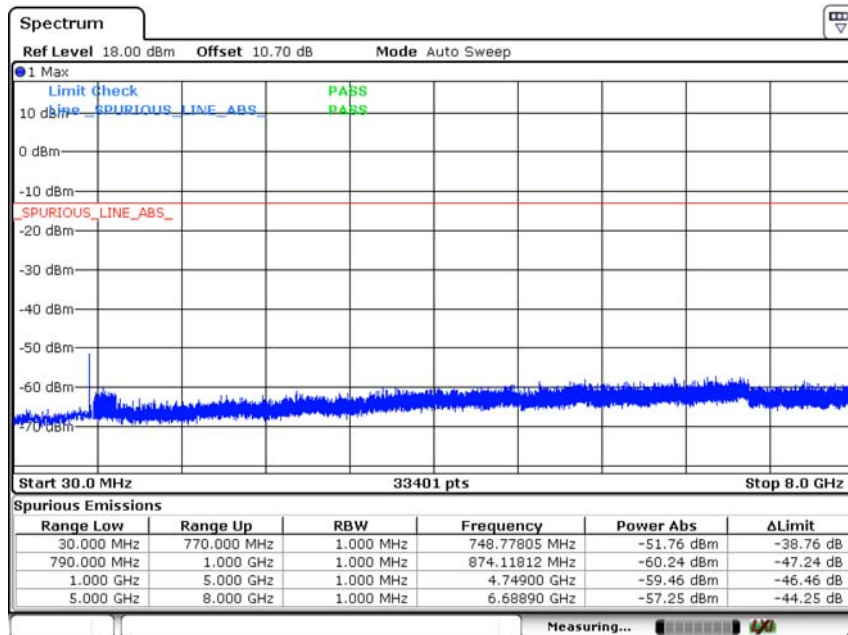

Test Model	Conducted Emissions	
	LTE Band 13	
	Middle Channel /5MHz	QPSK/Full RB

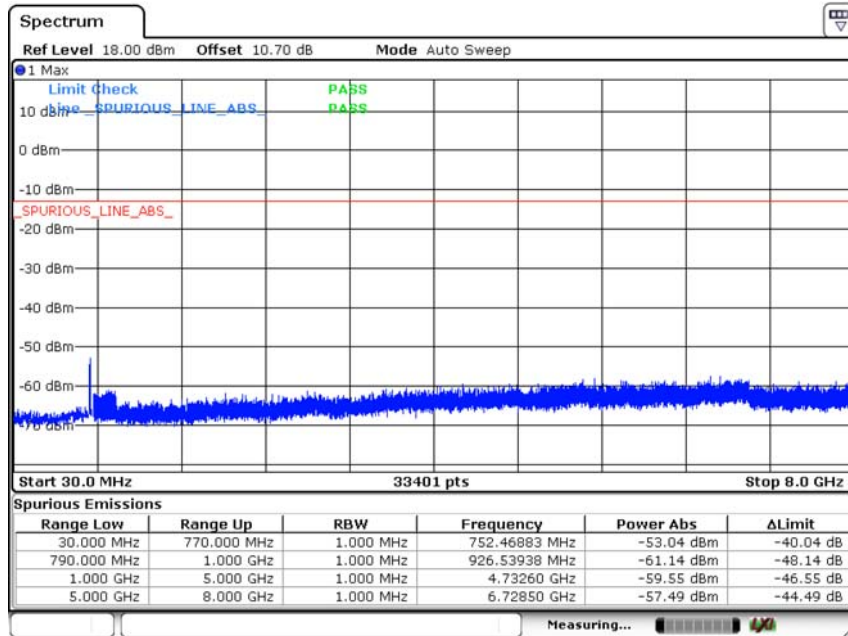

Test Model	Conducted Emissions	
	LTE Band 13	
	High Channel /5MHz	QPSK/Full RB

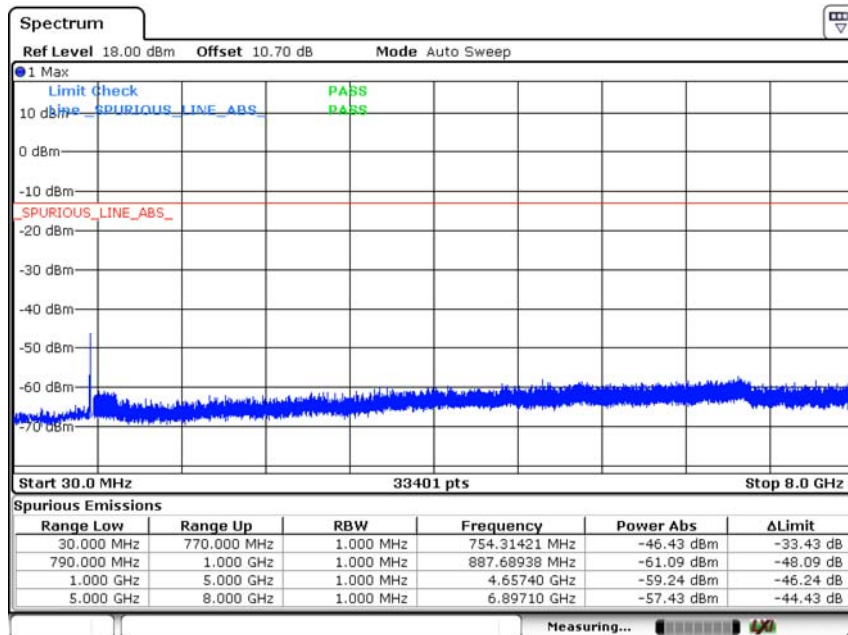

Test Model	Conducted Emissions	
	LTE Band 13	
	Middle Channel /10MHz	QPSK/Full RB

