

**ELECTROMAGNETIC EMISSIONS
COMPLIANCE REPORT**

Applicant: FIH CO., LTD.
No.4, Minsheng St., Tu-Cheng Dist., New Taipei City 23679,
Taiwan

Manufacturer: FIH CO., LTD.
No.4, Minsheng St., Tu-Cheng Dist., New Taipei City 23679,
Taiwan

Product Name: Internet Gateway

Brand Name: FIH

Model No.: FSNO21VA

Model Difference: N/A

Report Number: ER/2022/30082

FCC ID RYQFSNO21VA

Issue Date: May 30, 2022

Date of Test: April 7, 2022 ~ May 9, 2022

Date of EUT Received: March 30, 2022

Blue Yang
Approved By _____
Blue Yang

We hereby certify that:

The above equipment was tested by SGS Taiwan Ltd. Central RF Lab The test data, data evaluation, test procedures, and equipment configurations shown in this report were made in accordance with the procedures given in ANSI C63.26-2015 and the energy emitted by the sample EUT comply with FCC rule part 2 , 22H & 24E & 27 C.

The results of this report relate only to the sample identified in this report.

Unless otherwise stated the results shown in this test report refer only to the sample(s) tested and such sample(s) are retained for 90 days only.

除非另有說明，此報告結果僅對測試之樣品負責，同時此樣品僅保留90天。本報告未經本公司書面許可，不可部份複製。

This document is issued by the Company subject to its General Conditions of Service printed overleaf, available on request or accessible at <http://www.sgs.com.tw/Terms-and-Conditions> and for electronic format documents, subject to Terms and Conditions for Electronic Documents at <http://www.sgs.com.tw/Terms-and-Conditions>. Attention is drawn to the limitation of liability, indemnification and jurisdiction issues defined therein. Any holder of this document is advised that information contained hereon reflects the Company's findings at the time of its intervention only and within the limits of Client's instructions, if any. The Company's sole responsibility is to its Client and this document does not exonerate parties to a transaction from exercising all their rights and obligations under the transaction documents. This document cannot be reproduced except in full, without prior written approval of the Company. Any unauthorized alteration, forgery or falsification of the content or appearance of this document is unlawful and offenders may be prosecuted to the fullest extent of the law.

Revision History					
Report Number	Revision	Description	Issue Date	Revised By	Remark
ER/2022/30082	00	Original	May 30, 2022	Yuri Tsai	

Note:

- 1、The remark "*" indicates modification of the report upon requests from certification body.

Unless otherwise stated the results shown in this test report refer only to the sample(s) tested and such sample(s) are retained for 90 days only.

除非另有說明，此報告結果僅對測試之樣品負責，同時此樣品僅保留90天。本報告未經本公司書面許可，不可部份複製。

This document is issued by the Company subject to its General Conditions of Service printed overleaf, available on request or accessible at <http://www.sgs.com.tw/Terms-and-Conditions> and for electronic format documents, subject to Terms and Conditions for Electronic Documents at <http://www.sgs.com.tw/Terms-and-Conditions>. Attention is drawn to the limitation of liability, indemnification and jurisdiction issues defined therein. Any holder of this document is advised that information contained hereon reflects the Company's findings at the time of its intervention only and within the limits of Client's instructions, if any. The Company's sole responsibility is to its Client and this document does not exonerate parties to a transaction from exercising all their rights and obligations under the transaction documents. This document cannot be reproduced except in full, without prior written approval of the Company. Any unauthorized alteration, forgery or falsification of the content or appearance of this document is unlawful and offenders may be prosecuted to the fullest extent of the law.

Contents

1	GENERAL PRODUCT INFORMATION.....	4
2	SYSTEM TEST CONFIGURATION	10
3	SUMMARY OF TEST RESULTS	13
4	DESCRIPTION OF TEST MODES	14
5	MEASUREMENT UNCERTAINTY	16
6	MEASUREMENT EQUIPMENT USED.....	17
7	MAXIMUM OUTPUT POWER	18
8	OCCUPIED BANDWIDTH MEASUREMENT	39
9	OUT OF BAND EMISSION AT ANTENNA TERMINALS	76
10	FIELD STRENGTH OF SPURIOUS RADIATION MEASUREMENT.....	96
11	FREQUENCY STABILITY MEASUREMENT	119
12	PEAK TO AVERAGE RATIO	122

Unless otherwise stated the results shown in this test report refer only to the sample(s) tested and such sample(s) are retained for 90 days only.

除非另有說明，此報告結果僅對測試之樣品負責，同時此樣品僅保留90天。本報告未經本公司書面許可，不可部份複製。

This document is issued by the Company subject to its General Conditions of Service printed overleaf, available on request or accessible at <http://www.sgs.com.tw/Terms-and-Conditions> and for electronic format documents, subject to Terms and Conditions for Electronic Documents at <http://www.sgs.com.tw/Terms-and-Conditions>. Attention is drawn to the limitation of liability, indemnification and jurisdiction issues defined therein. Any holder of this document is advised that information contained hereon reflects the Company's findings at the time of its intervention only and within the limits of Client's instructions, if any. The Company's sole responsibility is to its Client and this document does not exonerate parties to a transaction from exercising all their rights and obligations under the transaction documents. This document cannot be reproduced except in full, without prior written approval of the Company. Any unauthorized alteration, forgery or falsification of the content or appearance of this document is unlawful and offenders may be prosecuted to the fullest extent of the law.

1 GENERAL PRODUCT INFORMATION

1.1 Product Description

Product Name:	Internet Gateway
Brand Name:	FIH
Model No.:	FSNO21VA
Model Difference:	N/A
Hardware Version:	1.0
Firmware Version:	V0.15A_1KUS
EUT Series No.:	356405430000450
Power Supply:	12Vdc from AC/DC Adapter
Test Software (Name/Version)	default

Unless otherwise stated the results shown in this test report refer only to the sample(s) tested and such sample(s) are retained for 90 days only.

除非另有說明，此報告結果僅對測試之樣品負責，同時此樣品僅保留90天。本報告未經本公司書面許可，不可部份複製。

This document is issued by the Company subject to its General Conditions of Service printed overleaf, available on request or accessible at <http://www.sgs.com.tw/Terms-and-Conditions> and for electronic format documents, subject to Terms and Conditions for Electronic Documents at <http://www.sgs.com.tw/Terms-and-Conditions>. Attention is drawn to the limitation of liability, indemnification and jurisdiction issues defined therein. Any holder of this document is advised that information contained hereon reflects the Company's findings at the time of its intervention only and within the limits of Client's instructions, if any. The Company's sole responsibility is to its Client and this document does not exonerate parties to a transaction from exercising all their rights and obligations under the transaction documents. This document cannot be reproduced except in full, without prior written approval of the Company. Any unauthorized alteration, forgery or falsification of the content or appearance of this document is unlawful and offenders may be prosecuted to the fullest extent of the law.

1.2 Operation Frequency Range

LTE Band 2	
BW (MHz)	Operation Frequency (MHz)
1.4	1850.7 - 1909.3
3	1851.5 - 1908.5
5	1852.5 - 1907.5
10	1855.0 - 1905.0
15	1857.5 - 1902.5
20	1860.0 - 1900.0
LTE Band 5	
BW (MHz)	Operation Frequency (MHz)
1.4	824.7 - 848.3
3	825.5 - 847.5
5	826.5 - 846.5
10	829.0 - 844.0

LTE Band 13	
BW (MHz)	Operation Frequency (MHz)
5	779.5 - 784.5
10	782.0
LTE Band 66	
BW (MHz)	Operation Frequency (MHz)
1.4	1710.7 - 1779.3
3	1711.5 - 1778.5
5	1712.5 - 1777.5
10	1715.0 - 1775.0
15	1717.5 - 1772.5
20	1720.0 - 1770.0

Unless otherwise stated the results shown in this test report refer only to the sample(s) tested and such sample(s) are retained for 90 days only.

除非另有說明，此報告結果僅對測試之樣品負責，同時此樣品僅保留90天。本報告未經本公司書面許可，不可部份複製。

This document is issued by the Company subject to its General Conditions of Service printed overleaf, available on request or accessible at <http://www.sgs.com.tw/Terms-and-Conditions> and for electronic format documents, subject to Terms and Conditions for Electronic Documents at <http://www.sgs.com.tw/Terms-and-Conditions>. Attention is drawn to the limitation of liability, indemnification and jurisdiction issues defined therein. Any holder of this document is advised that information contained hereon reflects the Company's findings at the time of its intervention only and within the limits of Client's instructions, if any. The Company's sole responsibility is to its Client and this document does not exonerate parties to a transaction from exercising all their rights and obligations under the transaction documents. This document cannot be reproduced except in full, without prior written approval of the Company. Any unauthorized alteration, forgery or falsification of the content or appearance of this document is unlawful and offenders may be prosecuted to the fullest extent of the law.

1.3 Antenna Designation

Antenna Type	Antenna No.
PIFA	Ant0
Dipole	Ant1
Monopole	Ant4
Note: Transmission frequencies in this test report are only available by the above antenna(s).	

Modulation	Frequency (MHz)			Peak Antenna Gain (dBi)		
				Ant0	Ant1	Ant4
LTE-Band 2	1850	~	1910	/	-0.07863	/
LTE-Band 5	824	~	849	-2.41266	/	/
LTE-Band 13	777	~	787	/	/	-2.98952
LTE-Band 66	1710	~	1780	/	-0.89447	/

Note: Antenna information is provided by the applicant.

Unless otherwise stated the results shown in this test report refer only to the sample(s) tested and such sample(s) are retained for 90 days only.

除非另有說明，此報告結果僅對測試之樣品負責，同時此樣品僅保留90天。本報告未經本公司書面許可，不可部份複製。

This document is issued by the Company subject to its General Conditions of Service printed overleaf, available on request or accessible at <http://www.sgs.com.tw/Terms-and-Conditions> and for electronic format documents, subject to Terms and Conditions for Electronic Documents at <http://www.sgs.com.tw/Terms-and-Conditions>. Attention is drawn to the limitation of liability, indemnification and jurisdiction issues defined therein. Any holder of this document is advised that information contained hereon reflects the Company's findings at the time of its intervention only and within the limits of Client's instructions, if any. The Company's sole responsibility is to its Client and this document does not exonerate parties to a transaction from exercising all their rights and obligations under the transaction documents. This document cannot be reproduced except in full, without prior written approval of the Company. Any unauthorized alteration, forgery or falsification of the content or appearance of this document is unlawful and offenders may be prosecuted to the fullest extent of the law.

1.4 Type of Emission & Max ERP/EIRP Power Measurement Result:

LTE Band	BW	Frequency		Modulation	ERP / EIRP (dBm)		(W)	99%	Type of Emission						
2	1.4	1850.7	1909.3	QPSK	22.64	EIRP	0.184	1.0893	1M09G7D						
				16QAM	21.87	EIRP	0.154	1.0934	1M09D7W						
				64QAM	20.79	EIRP	0.120	1.0884	1M09D7W						
				256QAM	17.83	EIRP	0.061	1.0872	1M09D7W						
2	3	1851.5	1908.5	QPSK	22.53	EIRP	0.179	2.6964	2M70G7D						
				16QAM	21.87	EIRP	0.154	2.7025	2M70D7W						
				64QAM	20.68	EIRP	0.117	2.7010	2M70D7W						
				256QAM	17.87	EIRP	0.061	2.6980	2M70D7W						
2	5	1852.5	1907.5	QPSK	22.61	EIRP	0.183	4.4993	4M50G7D						
				16QAM	21.82	EIRP	0.152	4.5040	4M50D7W						
				64QAM	20.82	EIRP	0.121	4.4967	4M50D7W						
				256QAM	17.85	EIRP	0.061	4.5054	4M51D7W						
2	10	1855.0	1905.0	QPSK	22.69	EIRP	0.186	8.9928	8M99G7D						
				16QAM	21.84	EIRP	0.153	8.9827	8M98D7W						
				64QAM	20.77	EIRP	0.119	8.9830	8M98D7W						
				256QAM	17.83	EIRP	0.061	8.9795	8M98D7W						
2	15	1857.5	1902.5	QPSK	22.41	EIRP	0.174	13.457	13M5G7D						
				16QAM	21.56	EIRP	0.143	13.463	13M5D7W						
				64QAM	20.50	EIRP	0.112	13.473	13M5D7W						
				256QAM	17.71	EIRP	0.059	13.447	13M4D7W						
2	20	1860.0	1900.0	QPSK	22.81	EIRP	0.191	17.951	18M0G7D						
				16QAM	21.73	EIRP	0.149	17.932	17M9D7W						
				64QAM	20.69	EIRP	0.117	17.923	17M9D7W						
				256QAM	17.68	EIRP	0.059	17.958	18M0D7W						
LTE Band	BW	Frequency		Modulation	ERP / EIRP (dBm)		(W)	99%	Type of Emission						
										QPSK	17.34	ERP	0.054	1.0886	1M09G7D
										16QAM	16.69	ERP	0.047	1.0913	1M09D7W
										64QAM	15.82	ERP	0.038	1.0901	1M09D7W
5	1.4	824.7	848.3	256QAM	12.64	ERP	0.018	1.0883	1M09D7W						
				QPSK	17.33	ERP	0.054	2.6979	2M70G7D						
				16QAM	16.54	ERP	0.045	2.7018	2M70D7W						
				64QAM	15.47	ERP	0.035	2.6971	2M70D7W						
5	3	825.5	847.5	256QAM	12.63	ERP	0.018	2.7005	2M70D7W						
				QPSK	17.47	ERP	0.056	4.4941	4M49G7D						
				16QAM	16.72	ERP	0.047	4.4970	4M50D7W						
				64QAM	15.58	ERP	0.036	4.4944	4M49D7W						
5	5	826.5	846.5	256QAM	12.68	ERP	0.019	4.4987	4M50D7W						
				QPSK	17.54	ERP	0.057	8.9889	8M99G7D						
				16QAM	16.83	ERP	0.048	8.9975	9M00D7W						
				64QAM	15.64	ERP	0.037	8.9753	8M98D7W						
5	10	829.0	844.0	256QAM	12.65	ERP	0.018	8.9795	8M98D7W						

LTE Band	BW	Frequency		Modulation	ERP / EIRP (dBm)		(W)	99%	Type of Emission
13	5	779.5	784.5	QPSK	17.86	ERP	0.061	4.5023	4M50G7D
				16QAM	17.33	ERP	0.054	4.5117	4M51D7W
				64QAM	16.08	ERP	0.041	4.4978	4M50D7W
				256QAM	13.13	ERP	0.021	4.5052	4M51D7W
13	10	782.0	782.0	QPSK	17.94	ERP	0.062	8.9439	8M94G7D
				16QAM	17.45	ERP	0.056	8.9336	8M93D7W
				64QAM	15.71	ERP	0.037	8.9497	8M95D7W
				256QAM	13.07	ERP	0.020	8.9585	8M96D7W

LTE Band	BW	Frequency		Modulation	ERP / EIRP (dBm)		(W)	99%	Type of Emission
66	1.4	1710.7	1779.3	QPSK	21.74	EIRP	0.149	1.0868	1M09G7D
				16QAM	20.98	EIRP	0.125	1.0900	1M09D7W
				64QAM	19.83	EIRP	0.096	1.0891	1M09D7W
				256QAM	16.89	EIRP	0.049	1.0899	1M09D7W
66	3	1711.5	1778.5	QPSK	21.64	EIRP	0.146	2.7027	2M70G7D
				16QAM	20.98	EIRP	0.125	2.7014	2M70D7W
				64QAM	19.99	EIRP	0.100	2.6995	2M70D7W
				256QAM	16.93	EIRP	0.049	2.6989	2M70D7W
66	5	1712.5	1777.5	QPSK	21.73	EIRP	0.149	4.5045	4M50G7D
				16QAM	21.06	EIRP	0.128	4.5029	4M50D7W
				64QAM	19.92	EIRP	0.098	4.5020	4M50D7W
				256QAM	16.93	EIRP	0.049	4.4960	4M50D7W
66	10	1715.0	1775.0	QPSK	21.72	EIRP	0.148	9.0030	9M00G7D
				16QAM	21.13	EIRP	0.130	8.9954	9M00D7W
				64QAM	19.76	EIRP	0.095	9.0047	9M00D7W
				256QAM	16.86	EIRP	0.048	8.9963	9M00D7W
66	15	1717.5	1772.5	QPSK	21.50	EIRP	0.141	13.4700	13M5G7D
				16QAM	20.79	EIRP	0.120	13.4650	13M5D7W
				64QAM	19.89	EIRP	0.097	13.4660	13M5D7W
				256QAM	16.79	EIRP	0.048	13.4660	13M5D7W
66	20	1720.0	1770.0	QPSK	21.80	EIRP	0.151	17.9340	17M9G7D
				16QAM	20.83	EIRP	0.121	17.9620	18M0D7W
				64QAM	19.91	EIRP	0.098	17.9330	17M9D7W
				256QAM	16.75	EIRP	0.047	17.9560	18M0D7W

Unless otherwise stated the results shown in this test report refer only to the sample(s) tested and such sample(s) are retained for 90 days only.

除非另有說明，此報告結果僅對測試之樣品負責，同時此樣品僅保留90天。本報告未經本公司書面許可，不可部份複製。

This document is issued by the Company subject to its General Conditions of Service printed overleaf, available on request or accessible at <http://www.sgs.com.tw/Terms-and-Conditions> and for electronic format documents, subject to Terms and Conditions for Electronic Documents at <http://www.sgs.com.tw/Terms-and-Conditions>. Attention is drawn to the limitation of liability, indemnification and jurisdiction issues defined therein. Any holder of this document is advised that information contained hereon reflects the Company's findings at the time of its intervention only and within the limits of Client's instructions, if any. The Company's sole responsibility is to its Client and this document does not exonerate parties to a transaction from exercising all their rights and obligations under the transaction documents. This document cannot be reproduced except in full, without prior written approval of the Company. Any unauthorized alteration, forgery or falsification of the content or appearance of this document is unlawful and offenders may be prosecuted to the fullest extent of the law.

1.5 Test Methodology of Applied Standards

FCC 47 CFR Part 2, 22H, 24E, 27C.

ANSI C63.26-2015

KDB971168 D01 Power Meas license Digital System v03r01

KDB412172 D01 Determining ERP and EIRP v01r01

1.6 Test Facility

Laboratory	Test Site Address	Test Site Name	FCC Designation number	IC CAB identifier
SGS Taiwan Ltd. Central RF Lab. (TAF code 3702)	No.134, Wu Kung Road, New Taipei Industrial Park, Wuku District, New Taipei City, Taiwan.	SAC 1	TW0027	TW3702
		SAC 3		
		Conduction 1		
		Conducted 1		
		Conducted 2		
		Conducted 3		
		Conducted 4		
		Conducted 5		
		Conducted 6		
	No.2, Keji 1st Rd., Guishan District, Taoyuan City, Taiwan 333	Conduction C	TW0028	
		SAC C		
		SAC D		
		SAC G		
		Conducted A		
		Conducted B		
		Conducted C		
		Conducted D		
		Conducted E		
		Conducted F		
Conducted G				

Note: Test site name is remarked on the equipment list in each section of this report as an indication where measurements occurred in specific test site and address.

Unless otherwise stated the results shown in this test report refer only to the sample(s) tested and such sample(s) are retained for 90 days only.

除非另有說明，此報告結果僅對測試之樣品負責，同時此樣品僅保留90天。本報告未經本公司書面許可，不可部份複製。

This document is issued by the Company subject to its General Conditions of Service printed overleaf, available on request or accessible at <http://www.sgs.com.tw/Terms-and-Conditions> and for electronic format documents, subject to Terms and Conditions for Electronic Documents at <http://www.sgs.com.tw/Terms-and-Conditions>. Attention is drawn to the limitation of liability, indemnification and jurisdiction issues defined therein. Any holder of this document is advised that information contained hereon reflects the Company's findings at the time of its intervention only and within the limits of Client's instructions, if any. The Company's sole responsibility is to its Client and this document does not exonerate parties to a transaction from exercising all their rights and obligations under the transaction documents. This document cannot be reproduced except in full, without prior written approval of the Company. Any unauthorized alteration, forgery or falsification of the content or appearance of this document is unlawful and offenders may be prosecuted to the fullest extent of the law.

1.7 Special Accessories

No special accessories were used during testing.

1.8 Equipment Modifications

There was no modifications incorporated into the EUT.

1.9 Radiated Emission Test Sites For Measurements From 9 kHz To 30 MHz

Radiated emission below 30MHz is measured in a 9m*6m*6m semi-anechoic chamber, the measurements correspond to those obtained at an open-field test site.

There is a comparison data of both open-field test site and semi-Anechoic chamber, and the result came out very similar.

Unless otherwise stated the results shown in this test report refer only to the sample(s) tested and such sample(s) are retained for 90 days only.

除非另有說明，此報告結果僅對測試之樣品負責，同時此樣品僅保留90天。本報告未經本公司書面許可，不可部份複製。

This document is issued by the Company subject to its General Conditions of Service printed overleaf, available on request or accessible at <http://www.sgs.com.tw/Terms-and-Conditions> and for electronic format documents, subject to Terms and Conditions for Electronic Documents at <http://www.sgs.com.tw/Terms-and-Conditions>. Attention is drawn to the limitation of liability, indemnification and jurisdiction issues defined therein. Any holder of this document is advised that information contained hereon reflects the Company's findings at the time of its intervention only and within the limits of Client's instructions, if any. The Company's sole responsibility is to its Client and this document does not exonerate parties to a transaction from exercising all their rights and obligations under the transaction documents. This document cannot be reproduced except in full, without prior written approval of the Company. Any unauthorized alteration, forgery or falsification of the content or appearance of this document is unlawful and offenders may be prosecuted to the fullest extent of the law.

2 SYSTEM TEST CONFIGURATION

2.1 EUT Configuration

The EUT configuration for testing is installed on RF field strength measurement to meet the Commissions requirement and operating in a manner which intends to maximize its emission characteristics in a continuous normal application.

2.2 EUT Exercise

The EUT (Transmitter) was operated in the continuous transmission mode employed with the simulator of the Base Station that fixates at test default channels to fix the Tx frequency which was for the purpose of the measurements.

2.3 Test Procedure

2.3.1 Conducted Measurement at Antenna Port

The EUT is placed on a table which is 0.8 m above ground plane. A low loss of RF cable was used to connect the antenna port of EUT to measurement equipment.

2.3.2 Radiated Emissions (ERP/EIRP)

The EUT is placed on a turn table, for emission measurements below 1 GHz is 0.8 m above ground plane, for emission measurements above 1 GHz, the table height shall be 1.5 m. The turn table shall rotate 360 degrees to determine the position of maximum emission level. EUT is set 3m away from the receiving antenna which varied from 1m to 4m to find out the highest emission. And also, each emission was to be maximized by changing the polarization of receiving antenna both Horizontal and Vertical. In order to find out the max. emission, the relative positions of this hand-held transmitter (EUT) was rotated through three orthogonal axes and measurement procedures for electric field radiated emissions above 1 GHz the EUT measurement is to be made “while keeping the antenna in the ‘cone of radiation’ from that area and pointed at the area both in azimuth and elevation, with polarization oriented for maximum response.” is still within the 3dB illumination BW of the measurement antenna.

2.4 Measurement Results Explanation Example

For all conducted test items:

The offset level is set in the spectrum analyzer to compensate the RF cable loss and attenuation factor between EUT conducted port and spectrum analyzer. With the offset compensation, the spectrum analyzer reading level is exactly EUT RF output level.

Note:

The spectrum analyzer offset is derived from RF cable loss and attenuator factor. Following shows an offset computation in physical test.

Frequency	RF Cable loss (dB)	Attenuation (dB)	Offset (dB)
LB(1GHz below)	4.96	10	14.96
LB(1GHz below)	4.48	10	14.48
MB(1GHz - 2GHz)	4.02	10	14.02

Unless otherwise stated the results shown in this test report refer only to the sample(s) tested and such sample(s) are retained for 90 days only.

除非另有說明，此報告結果僅對測試之樣品負責，同時此樣品僅保留90天。本報告未經本公司書面許可，不可部份複製。

This document is issued by the Company subject to its General Conditions of Service printed overleaf, available on request or accessible at <http://www.sgs.com.tw/Terms-and-Conditions> and for electronic format documents, subject to Terms and Conditions for Electronic Documents at <http://www.sgs.com.tw/Terms-and-Conditions>. Attention is drawn to the limitation of liability, indemnification and jurisdiction issues defined therein. Any holder of this document is advised that information contained hereon reflects the Company's findings at the time of its intervention only and within the limits of Client's instructions, if any. The Company's sole responsibility is to its Client and this document does not exonerate parties to a transaction from exercising all their rights and obligations under the transaction documents. This document cannot be reproduced except in full, without prior written approval of the Company. Any unauthorized alteration, forgery or falsification of the content or appearance of this document is unlawful and offenders may be prosecuted to the fullest extent of the law.

2.5 Final Amplifier Voltage and Current Information:

LTE Band 2

Test mode	AC voltage (V)	AC current (mA)
LTE Band 2_20M QPSK	120	71

LTE Band 5

Test mode	AC voltage (V)	AC current (mA)
LTE Band 5_10M QPSK	120	68

LTE Band 13

Test mode	AC voltage (V)	AC current (mA)
LTE Band 13_10M QPSK	120	69

LTE Band 66

Test mode	AC voltage (V)	AC current (mA)
LTE Band 66_20M QPSK	120	67

Unless otherwise stated the results shown in this test report refer only to the sample(s) tested and such sample(s) are retained for 90 days only.

除非另有說明，此報告結果僅對測試之樣品負責，同時此樣品僅保留90天。本報告未經本公司書面許可，不可部份複製。

This document is issued by the Company subject to its General Conditions of Service printed overleaf, available on request or accessible at <http://www.sgs.com.tw/Terms-and-Conditions> and for electronic format documents, subject to Terms and Conditions for Electronic Documents at <http://www.sgs.com.tw/Terms-and-Conditions>. Attention is drawn to the limitation of liability, indemnification and jurisdiction issues defined therein. Any holder of this document is advised that information contained hereon reflects the Company's findings at the time of its intervention only and within the limits of Client's instructions, if any. The Company's sole responsibility is to its Client and this document does not exonerate parties to a transaction from exercising all their rights and obligations under the transaction documents. This document cannot be reproduced except in full, without prior written approval of the Company. Any unauthorized alteration, forgery or falsification of the content or appearance of this document is unlawful and offenders may be prosecuted to the fullest extent of the law.

2.6 Test Configuration

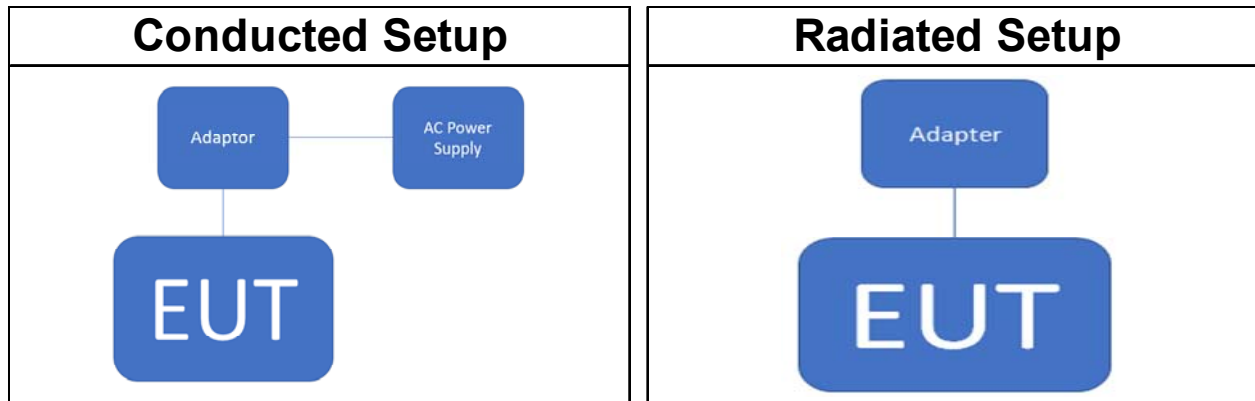

Note: Radio Communication Analyzer is placed in remote side for radiated test.

2.7 Control Unit(s)

Conducted Emission Test Site: Conducted 3					
EQUIPMENT TYPE	MFR	MODEL NUMBER	SERIAL NUMBER	LAST CAL.	CAL DUE.
Test Software	SGS	Radio Test Software	Ver. 21	N.C.R	N.C.R
Switching Adapter	Jiangxi JianAohai Technology	A929-120300W-US1	N/A	N/A	N/A
Radiated Emission Test Site: SAC 1					
EQUIPMENT TYPE	MFR	MODEL NUMBER	SERIAL NUMBER	LAST CAL.	CAL DUE.
SWITCHING ADAPTER	Jiangxi JianAohai Technology Co.,Ltd	A929-120300W-US1	N/A	N/A	N/A
Test Software	Audix	e3	Ver. 9.210322	N.C.R	N.C.R

Unless otherwise stated the results shown in this test report refer only to the sample(s) tested and such sample(s) are retained for 90 days only.

除非另有說明，此報告結果僅對測試之樣品負責，同時此樣品僅保留90天。本報告未經本公司書面許可，不可部份複製。

This document is issued by the Company subject to its General Conditions of Service printed overleaf, available on request or accessible at <http://www.sgs.com.tw/Terms-and-Conditions> and for electronic format documents, subject to Terms and Conditions for Electronic Documents at <http://www.sgs.com.tw/Terms-and-Conditions>. Attention is drawn to the limitation of liability, indemnification and jurisdiction issues defined therein. Any holder of this document is advised that information contained hereon reflects the Company's findings at the time of its intervention only and within the limits of Client's instructions, if any. The Company's sole responsibility is to its Client and this document does not exonerate parties to a transaction from exercising all their rights and obligations under the transaction documents. This document cannot be reproduced except in full, without prior written approval of the Company. Any unauthorized alteration, forgery or falsification of the content or appearance of this document is unlawful and offenders may be prosecuted to the fullest extent of the law.

3 SUMMARY OF TEST RESULTS

FCC Rules	Description Of Test	Result
§2.1046(a)	RF Power Output	Compliant
§22.913(a)(5) §24.232(c) §27.50(b)(9) §27.50(d)(4)	ERP/ EIRP measurement	Compliant
§2.1049(h)	99% & 26dB Occupied Bandwidth	Compliant
§2.1051 §22.917(a)(b) §24.238(a) §27.53(c) §27.53(h)	Out of Band Emissions at Antenna Terminals and Band Edge / Emission mask requirements	Compliant
§2.1053 §22.917(a) §24.238(a) §27.53(c)(f) §27.53(h)	Field Strength of Spurious Radiation	Compliant
§24.232(d) §27.50(a)(1)(B)	Peak to Average Ratio	Compliant
§2.1055(a)(1) §22.355 §24.235 §27.54	Frequency Stability	Compliant

Unless otherwise stated the results shown in this test report refer only to the sample(s) tested and such sample(s) are retained for 90 days only.

除非另有說明，此報告結果僅對測試之樣品負責，同時此樣品僅保留90天。本報告未經本公司書面許可，不可部份複製。

This document is issued by the Company subject to its General Conditions of Service printed overleaf, available on request or accessible at <http://www.sgs.com.tw/Terms-and-Conditions> and for electronic format documents, subject to Terms and Conditions for Electronic Documents at <http://www.sgs.com.tw/Terms-and-Conditions>. Attention is drawn to the limitation of liability, indemnification and jurisdiction issues defined therein. Any holder of this document is advised that information contained hereon reflects the Company's findings at the time of its intervention only and within the limits of Client's instructions, if any. The Company's sole responsibility is to its Client and this document does not exonerate parties to a transaction from exercising all their rights and obligations under the transaction documents. This document cannot be reproduced except in full, without prior written approval of the Company. Any unauthorized alteration, forgery or falsification of the content or appearance of this document is unlawful and offenders may be prosecuted to the fullest extent of the law.

4 DESCRIPTION OF TEST MODES

4.1 The Worst Test Modes and Channel Details

1. The EUT has been tested under operating condition.
2. Pre-Scan has been conducted to determine the worst-case scenario from all possible combinations among available modulations, data rates and antenna ports, the worst case configurations listed below for the final test.
3. The field strength of radiated emission was measured as the EUT positioned in different orthogonal planes (E1/E2/H) based on actual usage of the EUT to pre-scan the emissions for determining the worst case scenario.

4.2 Measurement Configuration

Test Items				Max. Output Power													
Band	Test Channel			Bandwidth (MHz)						Modulation				RB #			
	L	M	H	1.4	3	5	10	15	20	QPSK	16QAM	64QAM	256QAM	1	Half	Full	
2	v	v	v	v	v	v	v	v	v	v	v	v	v	v	v	v	v
5	v	v	v	v	v	v	v	-	-	v	v	v	v	v	v	v	v
13	v	v	v	-	-	v	v	-	-	v	v	v	v	v	v	v	v
66	v	v	v	v	v	v	v	v	v	v	v	v	v	v	v	v	v
Test Items				Frequency Stability													
2	-	v	-	-	-	-	v	-	-	v	-	-	-	-	-	-	v
5	-	v	-	-	-	-	v	-	-	v	-	-	-	-	-	-	v
13	-	v	-	-	-	-	v	-	-	v	-	-	-	-	-	-	v
66	-	v	-	-	-	-	v	-	-	v	-	-	-	-	-	-	v
Test Items				26dB and 99% Bandwidth													
Band	Test Channel			Bandwidth (MHz)						Modulation				RB #			
	L	M	H	1.4	3	5	10	15	20	QPSK	16QAM	64QAM	256QAM	1	Half	Full	
2	v	v	v	v	v	v	v	v	v	v	v	v	v	-	-	v	
5	v	v	v	v	v	v	v	-	-	v	v	v	v	-	-	v	
13	v	v	v	-	-	v	v	-	-	v	v	v	v	-	-	v	
66	v	v	v	v	v	v	v	v	v	v	v	v	v	-	-	v	
Test Items				Peak-to-Average Ratio													
2	v	v	v	v	v	v	v	v	v	-	-	-	v	-	-	v	
5	v	v	v	v	v	v	v	-	-	-	-	-	v	-	-	v	
13	v	v	v	-	-	v	v	-	-	-	-	-	v	-	-	v	
66	v	v	v	v	v	v	v	v	v	-	-	-	v	-	-	v	
Test Items				Band Edge													
Band	Test Channel			Bandwidth (MHz)						Modulation				RB #			
	L	M	H	1.4	3	5	10	15	20	QPSK	16QAM	64QAM	256QAM	1	Half	Full	
2	v	-	v	v	v	v	v	v	v	v	-	-	-	v	v	v	
5	v	-	v	v	v	v	v	-	-	v	-	-	-	v	v	v	
13	v	-	v	-	-	v	v	-	-	v	-	-	-	v	v	v	
66	v	-	v	v	v	v	v	v	v	v	-	-	-	v	v	v	
Test Items				Conducted Emission													
2	v	v	v	-	-	-	-	-	v	v	-	-	-	v	-	-	
5	v	v	v	-	-	-	v	-	-	v	-	-	-	v	-	-	
13	v	v	v	-	-	-	v	-	-	v	-	-	-	v	-	-	
66	v	v	v	-	-	-	-	-	v	v	-	-	-	v	-	-	

Unless otherwise stated the results shown in this test report refer only to the sample(s) tested and such sample(s) are retained for 90 days only.

除非另有說明，此報告結果僅對測試之樣品負責，同時此樣品僅保留90天。本報告未經本公司書面許可，不可部份複製。

This document is issued by the Company subject to its General Conditions of Service printed overleaf, available on request or accessible at <http://www.sgs.com.tw/Terms-and-Conditions> and for electronic format documents, subject to Terms and Conditions for Electronic Documents at <http://www.sgs.com.tw/Terms-and-Conditions>. Attention is drawn to the limitation of liability, indemnification and jurisdiction issues defined therein. Any holder of this document is advised that information contained hereon reflects the Company's findings at the time of its intervention only and within the limits of Client's instructions, if any. The Company's sole responsibility is to its Client and this document does not exonerate parties to a transaction from exercising all their rights and obligations under the transaction documents. This document cannot be reproduced except in full, without prior written approval of the Company. Any unauthorized alteration, forgery or falsification of the content or appearance of this document is unlawful and offenders may be prosecuted to the fullest extent of the law.

Test Items				Radiated Emission												
Band	Test Channel			Bandwidth (MHz)						Modulation				RB #		
	L	M	H	1.4	3	5	10	15	20	QPSK	16QAM	64QAM	256QAM	1	Half	Full
2	V	V	V	-	-	-	-	-	V	V	-	-	-	V	-	-
5	V	V	V	-	-	-	V	-	-	V	-	-	-	V	-	-
13	V	V	V	-	-	-	V	-	-	V	-	-	-	V	-	-
66	V	V	V	-	-	-	-	-	V	V	-	-	-	V	-	-

Unless otherwise stated the results shown in this test report refer only to the sample(s) tested and such sample(s) are retained for 90 days only.

除非另有說明，此報告結果僅對測試之樣品負責，同時此樣品僅保留90天。本報告未經本公司書面許可，不可部份複製。

This document is issued by the Company subject to its General Conditions of Service printed overleaf, available on request or accessible at <http://www.sgs.com.tw/Terms-and-Conditions> and for electronic format documents, subject to Terms and Conditions for Electronic Documents at <http://www.sgs.com.tw/Terms-and-Conditions>. Attention is drawn to the limitation of liability, indemnification and jurisdiction issues defined therein. Any holder of this document is advised that information contained hereon reflects the Company's findings at the time of its intervention only and within the limits of Client's instructions, if any. The Company's sole responsibility is to its Client and this document does not exonerate parties to a transaction from exercising all their rights and obligations under the transaction documents. This document cannot be reproduced except in full, without prior written approval of the Company. Any unauthorized alteration, forgery or falsification of the content or appearance of this document is unlawful and offenders may be prosecuted to the fullest extent of the law.

5 MEASUREMENT UNCERTAINTY

Test Items	Uncertainty
RF Power Output	+/- 1 dB
ERP/ EIRP measurement	+/- 3 dB
	+/- 3 dB
Emission Bandwidth	+/- 1.53 Hz
Out of Band Emissions at Antenna Terminals and Band Edge	+/- 1.68 dB
Peak to Average Ratio	+/- 1 dB
Frequency Stability vs. Temperature	+/- 1.53 Hz
Frequency Stability vs. Voltage	+/- 1.53 Hz
Temperature	+/- 0.4 °C
Humidity	+/- 3.5 %
DC / AC Power Source	+/- 1 %

Radiated Spurious Emission Measurement Uncertainty		
Polarization: Vertical	+/- 2.57 dB	9kHz~30MHz
	+/- 4.85 dB	30MHz - 1000MHz
	+/- 4.45 dB	1GHz - 18GHz
	+/- 4.24 dB	18GHz - 40GHz
Polarization: Horizontal	+/- 2.57 dB	9kHz~30MHz
	+/- 4.37 dB	30MHz - 1000MHz
	+/- 4.45 dB	1GHz - 18GHz
	+/- 4.24 dB	18GHz - 40GHz

This uncertainty represents an expanded uncertainty expressed at approximately the 95% confidence level using a coverage factor of k=2.

Unless otherwise stated the results shown in this test report refer only to the sample(s) tested and such sample(s) are retained for 90 days only.

除非另有說明，此報告結果僅對測試之樣品負責，同時此樣品僅保留90天。本報告未經本公司書面許可，不可部份複製。

This document is issued by the Company subject to its General Conditions of Service printed overleaf, available on request or accessible at <http://www.sgs.com.tw/Terms-and-Conditions> and for electronic format documents, subject to Terms and Conditions for Electronic Documents at <http://www.sgs.com.tw/Terms-and-Conditions>. Attention is drawn to the limitation of liability, indemnification and jurisdiction issues defined therein. Any holder of this document is advised that information contained hereon reflects the Company's findings at the time of its intervention only and within the limits of Client's instructions, if any. The Company's sole responsibility is to its Client and this document does not exonerate parties to a transaction from exercising all their rights and obligations under the transaction documents. This document cannot be reproduced except in full, without prior written approval of the Company. Any unauthorized alteration, forgery or falsification of the content or appearance of this document is unlawful and offenders may be prosecuted to the fullest extent of the law.

6 MEASUREMENT EQUIPMENT USED

6.1 Conducted Measurement

Conducted Emission Test Site: Conducted 3					
EQUIPMENT TYPE	MFR	MODEL NUMBER	SERIAL NUMBER	LAST CAL.	CAL DUE.
EXA Spectrum Analyzer	Agilent	N9010A	MY54200716	10/13/2021	10/12/2022
Radio Communication Analyzer	Anritsu	MT8821C	6261786084	01/18/2022	01/17/2023
Temperature Chamber	Giant Force	GTH-150-40-CP-AR	MAA0512-018	05/19/2021	05/18/2022
AC Power Source	Gwinstek	APS-7050E	GEV171679	09/28/2021	09/27/2022
Attenuator	Mini-Circuit	BW-S10W2+	4	12/14/2021	12/13/2022
DC Block	Mini-Circuits	BLK-18-S+	1	12/14/2021	12/13/2022
Power Divider	RF-LAMBAD	RFLT2W1G18G	11-JSPF412-020	12/14/2021	12/13/2022

6.2 Radiated Measurement

Radiated Emission Test Site: SAC 1					
EQUIPMENT TYPE	MFR	MODEL NUMBER	SERIAL NUMBER	LAST CAL.	CAL DUE.
Bi-log Antenna	SCHWARZBECK	VULB9168	300	10/19/2021	10/18/2022
Horn Antenna	SCHWARZBECK	BBHA9120D	D803	12/20/2021	12/19/2022
Bi-log Antenna	TESEO	CBL 6112D	35242 & AT-N0555	01/03/2022	01/02/2023
Horn Antenna	SCHWARZBECK	BBHA9120D	603	05/18/2021	05/17/2022
Horn Antenna	SCHWARZBECK	BBHA9170	184	12/16/2021	12/15/2022
Horn Antenna	SCHWARZBECK	BBHA9170	185	08/06/2021	08/05/2022
Site Cal	SGS	SAC I chamber	N/A	01/01/2022	12/31/2022
EXA Spectrum Analyzer	KEYSIGHT	N9010B	MY59071541	07/14/2021	07/13/2022
Signal Generator	R&S	SMBV100A	263084	01/11/2022	01/10/2023
Radio Communication Analyzer	Anritsu	MT8821C	6261786084	01/18/2022	01/17/2023
Pre-Amplifier	EMC Instruments	EMC184045B	980135	10/27/2021	10/26/2022
Pre-Amplifier	HP	8449B	3008A01973	12/16/2021	12/15/2022
Pre-Amplifier	HP	8447D	2944A09469	12/16/2021	12/15/2022
Bandreject Filter 800-1000	Micro-Tronics	EWT	M1	12/14/2021	12/13/2022
1.3G-15GHz High Pass Filter	WI	WHKX10-1066-80SS	19	12/14/2021	12/13/2022
3.2GHz High Pass Filter	WI	WHKX10-2624-80SS	3	12/14/2021	12/13/2022

Unless otherwise stated the results shown in this test report refer only to the sample(s) tested and such sample(s) are retained for 90 days only.

除非另有說明，此報告結果僅對測試之樣品負責，同時此樣品僅保留90天。本報告未經本公司書面許可，不可部份複製。

This document is issued by the Company subject to its General Conditions of Service printed overleaf, available on request or accessible at <http://www.sgs.com.tw/Terms-and-Conditions> and for electronic format documents, subject to Terms and Conditions for Electronic Documents at <http://www.sgs.com.tw/Terms-and-Conditions>. Attention is drawn to the limitation of liability, indemnification and jurisdiction issues defined therein. Any holder of this document is advised that information contained hereon reflects the Company's findings at the time of its intervention only and within the limits of Client's instructions, if any. The Company's sole responsibility is to its Client and this document does not exonerate parties to a transaction from exercising all their rights and obligations under the transaction documents. This document cannot be reproduced except in full, without prior written approval of the Company. Any unauthorized alteration, forgery or falsification of the content or appearance of this document is unlawful and offenders may be prosecuted to the fullest extent of the law.

7 MAXIMUM OUTPUT POWER

7.1 Standard Applicable

A base station simulator was used to establish communication with the EUT. Its parameters were set to transmit the maximum power on the EUT. The measured power in the radio frequency on the transmitter output terminals.

7.1.1 ERP/EIRP LIMIT

According to FCC §2.1046

FCC 22.913(a)

(5) mobile transmitters and auxiliary test transmitters must not exceed 7 watts.

FCC 24.232(c)

Mobile and portable stations are limited to 2 W EIRP.

FCC 27.50 (b)

(9) Control stations and mobile stations transmitting in the 746-757 MHz, 776-788 MHz, and 805-806 MHz bands are limited to 30 watts ERP.

FCC 27.50(d)

(4) Mobile, and portable (hand-held) stations operating in the 1710-1755 MHz, 1695-1710 MHz and 1755-1780 MHz bands are limited to 1W EIRP.

Unless otherwise stated the results shown in this test report refer only to the sample(s) tested and such sample(s) are retained for 90 days only.

除非另有說明，此報告結果僅對測試之樣品負責，同時此樣品僅保留90天。本報告未經本公司書面許可，不可部份複製。

This document is issued by the Company subject to its General Conditions of Service printed overleaf, available on request or accessible at <http://www.sgs.com.tw/Terms-and-Conditions> and for electronic format documents, subject to Terms and Conditions for Electronic Documents at <http://www.sgs.com.tw/Terms-and-Conditions>. Attention is drawn to the limitation of liability, indemnification and jurisdiction issues defined therein. Any holder of this document is advised that information contained hereon reflects the Company's findings at the time of its intervention only and within the limits of Client's instructions, if any. The Company's sole responsibility is to its Client and this document does not exonerate parties to a transaction from exercising all their rights and obligations under the transaction documents. This document cannot be reproduced except in full, without prior written approval of the Company. Any unauthorized alteration, forgery or falsification of the content or appearance of this document is unlawful and offenders may be prosecuted to the fullest extent of the law.

7.2 Test Set-up

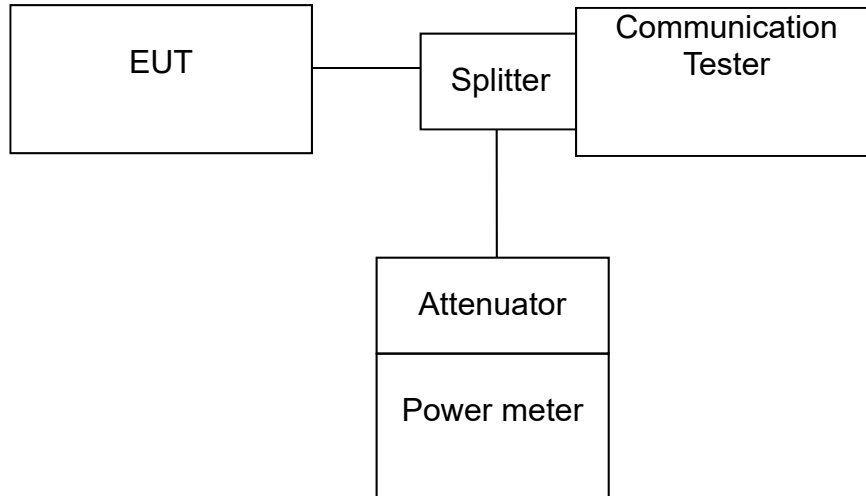

Note: Measurement setup for testing on Antenna connector

7.3 Output Power Measurement Applicable Guidance

The transmitter output was connected to a calibrated attenuator, the other end of which was connected to a power meter. Transmitter output was read off the power meter in dBm. The power output at the transmitter antenna port was determined by adding the value of the attenuator to the power meter reading.

KDB 971168 D01 Power Meas License Digital System as the supplemental test methodology to adjust the proper setting obtaining the measurement results.

All LTE bands conducted average power is obtained from the simulator telecommunication test set.

Unless otherwise stated the results shown in this test report refer only to the sample(s) tested and such sample(s) are retained for 90 days only.

除非另有說明，此報告結果僅對測試之樣品負責，同時此樣品僅保留90天。本報告未經本公司書面許可，不可部份複製。

This document is issued by the Company subject to its General Conditions of Service printed overleaf, available on request or accessible at <http://www.sgs.com.tw/Terms-and-Conditions> and for electronic format documents, subject to Terms and Conditions for Electronic Documents at <http://www.sgs.com.tw/Terms-and-Conditions>. Attention is drawn to the limitation of liability, indemnification and jurisdiction issues defined therein. Any holder of this document is advised that information contained hereon reflects the Company's findings at the time of its intervention only and within the limits of Client's instructions, if any. The Company's sole responsibility is to its Client and this document does not exonerate parties to a transaction from exercising all their rights and obligations under the transaction documents. This document cannot be reproduced except in full, without prior written approval of the Company. Any unauthorized alteration, forgery or falsification of the content or appearance of this document is unlawful and offenders may be prosecuted to the fullest extent of the law.

7.4 Determining ERP and/or EIRP from conducted RF output power measurements

According to KDB 412172 D01 Power Approach,

$$EIRP = P_T + G_T - L_C,$$

$$ERP = EIRP - 2.15,$$

Where:

- ERP or EIRP = effective radiated power or equivalent isotropically radiated power (expressed in the same units as P_T , typically dBW, dBm, or power spectral density (PSD)²), relative to either a dipole antenna (ERP) or an isotropic antenna (EIRP);
- P_T = transmitter output power, expressed in dBW, dBm, or PSD;
- G_T = gain of the transmitting antenna, in dBd (ERP) or dBi (EIRP);
- L_C = signal attenuation in the connecting cable between the transmitter and antenna, in dB.

Unless otherwise stated the results shown in this test report refer only to the sample(s) tested and such sample(s) are retained for 90 days only.

除非另有說明，此報告結果僅對測試之樣品負責，同時此樣品僅保留90天。本報告未經本公司書面許可，不可部份複製。

This document is issued by the Company subject to its General Conditions of Service printed overleaf, available on request or accessible at <http://www.sgs.com.tw/Terms-and-Conditions> and for electronic format documents, subject to Terms and Conditions for Electronic Documents at <http://www.sgs.com.tw/Terms-and-Conditions>. Attention is drawn to the limitation of liability, indemnification and jurisdiction issues defined therein. Any holder of this document is advised that information contained hereon reflects the Company's findings at the time of its intervention only and within the limits of Client's instructions, if any. The Company's sole responsibility is to its Client and this document does not exonerate parties to a transaction from exercising all their rights and obligations under the transaction documents. This document cannot be reproduced except in full, without prior written approval of the Company. Any unauthorized alteration, forgery or falsification of the content or appearance of this document is unlawful and offenders may be prosecuted to the fullest extent of the law.

7.5 Measurement Results:

Antenna gain (dBi)		-0.07863							
LTE Band 2_Uplink frequency band : 1850 to 1910 MHz									
BW (MHz)	UL Channel	Frequency (MHz)	Modulation	RB Size	RB Offset	Conducted Average (dBm)	EIRP Average (dBm)	EIRP Limit (dBm)	Margin (dB)
1.4	18607	1850.7	QPSK	1	0	22.75	22.67	33	-10.32863
				1	5	22.71	22.63	33	-10.36863
				3	2	22.76	22.68	33	-10.31863
				6	0	21.75	21.67	33	-11.32863
	18900	1880	QPSK	1	0	22.97	22.89	33	-10.10863
				1	5	22.87	22.79	33	-10.20863
				3	2	22.93	22.85	33	-10.14863
				6	0	21.91	21.83	33	-11.16863
	19193	1909.3	QPSK	1	0	22.60	22.52	33	-10.47863
				1	5	22.58	22.50	33	-10.49863
				3	2	22.69	22.61	33	-10.38863
				6	0	21.69	21.61	33	-11.38863
1.4	18607	1850.7	16QAM	1	0	22.08	22.00	33	-10.99863
				1	5	21.83	21.75	33	-11.24863
				3	2	21.81	21.73	33	-11.26863
				6	0	20.72	20.64	33	-12.35863
	18900	1880	16QAM	1	0	22.20	22.12	33	-10.87863
				1	5	21.85	21.77	33	-11.22863
				3	2	22.01	21.93	33	-11.06863
				6	0	20.96	20.88	33	-12.11863
	19193	1909.3	16QAM	1	0	22.20	22.12	33	-10.87863
				1	5	21.86	21.78	33	-11.21863
				3	2	21.77	21.69	33	-11.30863
				6	0	20.54	20.46	33	-12.53863
1.4	18607	1850.7	64QAM	1	0	21.12	21.04	33	-11.95863
				1	5	21.03	20.95	33	-12.04863
				3	2	20.91	20.83	33	-12.16863
				6	0	19.88	19.80	33	-13.19863
	18900	1880	64QAM	1	0	21.08	21.00	33	-11.99863
				1	5	20.82	20.74	33	-12.25863
				3	2	20.97	20.89	33	-12.10863
				6	0	19.86	19.78	33	-13.21863
	19193	1909.3	64QAM	1	0	20.85	20.77	33	-12.22863
				1	5	21.00	20.92	33	-12.07863
				3	2	20.68	20.60	33	-12.39863
				6	0	19.78	19.70	33	-13.29863
1.4	18607	1850.7	256QAM	1	0	17.94	17.86	33	-15.13863
				1	5	17.88	17.80	33	-15.19863
				3	2	17.96	17.88	33	-15.11863
				6	0	17.81	17.73	33	-15.26863
	18900	1880	256QAM	1	0	18.16	18.08	33	-14.91863
				1	5	18.13	18.05	33	-14.94863
				3	2	18.04	17.96	33	-15.03863
				6	0	18.06	17.98	33	-15.01863
	19193	1909.3	256QAM	1	0	18.02	17.94	33	-15.05863
				1	5	17.93	17.85	33	-15.14863
				3	2	17.78	17.70	33	-15.29863
				6	0	17.76	17.68	33	-15.31863

Unless otherwise stated the results shown in this test report refer only to the sample(s) tested and such sample(s) are retained for 90 days only.

除非另有說明，此報告結果僅對測試之樣品負責，同時此樣品僅保留90天。本報告未經本公司書面許可，不可部份複製。

This document is issued by the Company subject to its General Conditions of Service printed overleaf, available on request or accessible at <http://www.sgs.com.tw/Terms-and-Conditions> and for electronic format documents, subject to Terms and Conditions for Electronic Documents at <http://www.sgs.com.tw/Terms-and-Conditions>. Attention is drawn to the limitation of liability, indemnification and jurisdiction issues defined therein. Any holder of this document is advised that information contained hereon reflects the Company's findings at the time of its intervention only and within the limits of Client's instructions, if any. The Company's sole responsibility is to its Client and this document does not exonerate parties to a transaction from exercising all their rights and obligations under the transaction documents. This document cannot be reproduced except in full, without prior written approval of the Company. Any unauthorized alteration, forgery or falsification of the content or appearance of this document is unlawful and offenders may be prosecuted to the fullest extent of the law.

Antenna gain (dBi)		-0.07863							
LTE Band 2_Uplink frequency band : 1850 to 1910 MHz									
BW (MHz)	UL Channel	Frequency (MHz)	Modulation	RB Size	RB Offset	Conducted Average (dBm)	EIRP Average (dBm)	EIRP Limit (dBm)	Margin (dB)
3	18615	1851.5	QPSK	1	0	22.67	22.59	33	-10.40863
				1	14	22.57	22.49	33	-10.50863
				8	4	21.83	21.75	33	-11.24863
				15	0	21.81	21.73	33	-11.26863
	18900	1880	QPSK	1	0	22.86	22.78	33	-10.21863
				1	14	22.78	22.70	33	-10.29863
				8	4	21.88	21.80	33	-11.19863
				15	0	21.87	21.79	33	-11.20863
	19185	1908.5	QPSK	1	0	22.72	22.64	33	-10.35863
				1	14	22.48	22.40	33	-10.59863
				8	4	21.70	21.62	33	-11.37863
				15	0	21.72	21.64	33	-11.35863
3	18615	1851.5	16QAM	1	0	21.93	21.85	33	-11.14863
				1	14	21.95	21.87	33	-11.12863
				8	4	20.85	20.77	33	-12.22863
				15	0	20.82	20.74	33	-12.25863
	18900	1880	16QAM	1	0	21.93	21.85	33	-11.14863
				1	14	22.20	22.12	33	-10.87863
				8	4	20.97	20.89	33	-12.10863
				15	0	20.92	20.84	33	-12.15863
	19185	1908.5	16QAM	1	0	22.03	21.95	33	-11.04863
				1	14	21.37	21.29	33	-11.70863
				8	4	20.80	20.72	33	-12.27863
				15	0	20.82	20.74	33	-12.25863
3	18615	1851.5	64QAM	1	0	21.01	20.93	33	-12.06863
				1	14	20.66	20.58	33	-12.41863
				8	4	19.84	19.76	33	-13.23863
				15	0	19.80	19.72	33	-13.27863
	18900	1880	64QAM	1	0	20.91	20.83	33	-12.16863
				1	14	20.91	20.83	33	-12.16863
				8	4	20.04	19.96	33	-13.03863
				15	0	19.93	19.85	33	-13.14863
	19185	1908.5	64QAM	1	0	20.80	20.72	33	-12.27863
				1	14	20.71	20.63	33	-12.36863
				8	4	19.76	19.68	33	-13.31863
				15	0	19.69	19.61	33	-13.38863
3	18615	1851.5	256QAM	1	0	18.12	18.04	33	-14.95863
				1	14	17.98	17.90	33	-15.09863
				8	4	17.95	17.87	33	-15.12863
				15	0	17.89	17.81	33	-15.18863
	18900	1880	256QAM	1	0	18.20	18.12	33	-14.87863
				1	14	18.03	17.95	33	-15.04863
				8	4	18.01	17.93	33	-15.06863
				15	0	17.95	17.87	33	-15.12863
	19185	1908.5	256QAM	1	0	17.91	17.83	33	-15.16863
				1	14	17.74	17.66	33	-15.33863
				8	4	17.77	17.69	33	-15.30863
				15	0	17.75	17.67	33	-15.32863

Unless otherwise stated the results shown in this test report refer only to the sample(s) tested and such sample(s) are retained for 90 days only.

除非另有說明，此報告結果僅對測試之樣品負責，同時此樣品僅保留90天。本報告未經本公司書面許可，不可部份複製。

This document is issued by the Company subject to its General Conditions of Service printed overleaf, available on request or accessible at <http://www.sgs.com.tw/Terms-and-Conditions> and for electronic format documents, subject to Terms and Conditions for Electronic Documents at <http://www.sgs.com.tw/Terms-and-Conditions>. Attention is drawn to the limitation of liability, indemnification and jurisdiction issues defined therein. Any holder of this document is advised that information contained hereon reflects the Company's findings at the time of its intervention only and within the limits of Client's instructions, if any. The Company's sole responsibility is to its Client and this document does not exonerate parties to a transaction from exercising all their rights and obligations under the transaction documents. This document cannot be reproduced except in full, without prior written approval of the Company. Any unauthorized alteration, forgery or falsification of the content or appearance of this document is unlawful and offenders may be prosecuted to the fullest extent of the law.

Antenna gain (dBi)		-0.07863							
LTE Band 2_Uplink frequency band : 1850 to 1910 MHz									
BW (MHz)	UL Channel	Frequency (MHz)	Modulation	RB Size	RB Offset	Conducted Average (dBm)	EIRP Average (dBm)	EIRP Limit (dBm)	Margin (dB)
5	18625	1852.5	QPSK	1	0	22.74	22.66	33	-10.33863
				1	24	22.76	22.68	33	-10.31863
				12	6	21.83	21.75	33	-11.24863
				25	0	21.84	21.76	33	-11.23863
	18900	1880	QPSK	1	0	22.94	22.86	33	-10.13863
				1	24	22.87	22.79	33	-10.20863
				12	6	21.86	21.78	33	-11.21863
				25	0	21.93	21.85	33	-11.14863
	19175	1907.5	QPSK	1	0	22.70	22.62	33	-10.37863
				1	24	22.66	22.58	33	-10.41863
				12	6	21.75	21.67	33	-11.32863
				25	0	21.76	21.68	33	-11.31863
5	18625	1852.5	16QAM	1	0	22.00	21.92	33	-11.07863
				1	24	21.72	21.64	33	-11.35863
				12	6	20.92	20.84	33	-12.15863
				25	0	20.84	20.76	33	-12.23863
	18900	1880	16QAM	1	0	22.04	21.96	33	-11.03863
				1	24	22.10	22.02	33	-10.97863
				12	6	20.91	20.83	33	-12.16863
				25	0	20.97	20.89	33	-12.10863
	19175	1907.5	16QAM	1	0	22.15	22.07	33	-10.92863
				1	24	21.75	21.67	33	-11.32863
				12	6	20.78	20.70	33	-12.29863
				25	0	20.81	20.73	33	-12.26863
5	18625	1852.5	64QAM	1	0	20.82	20.74	33	-12.25863
				1	24	20.93	20.85	33	-12.14863
				12	6	19.90	19.82	33	-13.17863
				25	0	19.84	19.76	33	-13.23863
	18900	1880	64QAM	1	0	21.15	21.07	33	-11.92863
				1	24	20.46	20.38	33	-12.61863
				12	6	20.01	19.93	33	-13.06863
				25	0	19.87	19.79	33	-13.20863
	19175	1907.5	64QAM	1	0	20.87	20.79	33	-12.20863
				1	24	20.67	20.59	33	-12.40863
				12	6	19.89	19.81	33	-13.18863
				25	0	19.74	19.66	33	-13.33863
5	18625	1852.5	256QAM	1	0	18.02	17.94	33	-15.05863
				1	24	18.10	18.02	33	-14.97863
				12	6	17.94	17.86	33	-15.13863
				25	0	17.87	17.79	33	-15.20863
	18900	1880	256QAM	1	0	18.18	18.10	33	-14.89863
				1	24	18.11	18.03	33	-14.96863
				12	6	18.02	17.94	33	-15.05863
				25	0	17.94	17.86	33	-15.13863
	19175	1907.5	256QAM	1	0	18.00	17.92	33	-15.07863
				1	24	17.98	17.90	33	-15.09863
				12	6	17.89	17.81	33	-15.18863
				25	0	17.80	17.72	33	-15.27863

Unless otherwise stated the results shown in this test report refer only to the sample(s) tested and such sample(s) are retained for 90 days only.

除非另有說明，此報告結果僅對測試之樣品負責，同時此樣品僅保留90天。本報告未經本公司書面許可，不可部份複製。

This document is issued by the Company subject to its General Conditions of Service printed overleaf, available on request or accessible at <http://www.sgs.com.tw/Terms-and-Conditions> and for electronic format documents, subject to Terms and Conditions for Electronic Documents at <http://www.sgs.com.tw/Terms-and-Conditions>. Attention is drawn to the limitation of liability, indemnification and jurisdiction issues defined therein. Any holder of this document is advised that information contained hereon reflects the Company's findings at the time of its intervention only and within the limits of Client's instructions, if any. The Company's sole responsibility is to its Client and this document does not exonerate parties to a transaction from exercising all their rights and obligations under the transaction documents. This document cannot be reproduced except in full, without prior written approval of the Company. Any unauthorized alteration, forgery or falsification of the content or appearance of this document is unlawful and offenders may be prosecuted to the fullest extent of the law.

Antenna gain (dBi)		-0.07863							
LTE Band 2_Uplink frequency band : 1850 to 1910 MHz									
BW (MHz)	UL Channel	Frequency (MHz)	Modulation	RB Size	RB Offset	Conducted Average (dBm)	EIRP Average (dBm)	EIRP Limit (dBm)	Margin (dB)
10	18650	1855	QPSK	1	0	22.74	22.66	33	-10.33863
				1	49	22.70	22.62	33	-10.37863
				25	12	21.83	21.75	33	-11.24863
				50	0	21.82	21.74	33	-11.25863
	18900	1880	QPSK	1	0	23.02	22.94	33	-10.05863
				1	49	22.80	22.72	33	-10.27863
				25	12	21.88	21.80	33	-11.19863
				50	0	21.91	21.83	33	-11.16863
	19150	1905	QPSK	1	0	22.69	22.61	33	-10.38863
				1	49	22.77	22.69	33	-10.30863
				25	12	21.86	21.78	33	-11.21863
				50	0	21.80	21.72	33	-11.27863
10	18650	1855	16QAM	1	0	22.06	21.98	33	-11.01863
				1	49	22.04	21.96	33	-11.03863
				25	12	20.91	20.83	33	-12.16863
				50	0	20.79	20.71	33	-12.28863
	18900	1880	16QAM	1	0	22.17	22.09	33	-10.90863
				1	49	21.99	21.91	33	-11.08863
				25	12	20.92	20.84	33	-12.15863
				50	0	20.91	20.83	33	-12.16863
	19150	1905	16QAM	1	0	21.62	21.54	33	-11.45863
				1	49	21.76	21.68	33	-11.31863
				25	12	20.85	20.77	33	-12.22863
				50	0	20.75	20.67	33	-12.32863
10	18650	1855	64QAM	1	0	20.93	20.85	33	-12.14863
				1	49	20.83	20.75	33	-12.24863
				25	12	19.84	19.76	33	-13.23863
				50	0	19.77	19.69	33	-13.30863
	18900	1880	64QAM	1	0	20.91	20.83	33	-12.16863
				1	49	21.10	21.02	33	-11.97863
				25	12	19.98	19.90	33	-13.09863
				50	0	19.90	19.82	33	-13.17863
	19150	1905	64QAM	1	0	20.87	20.79	33	-12.20863
				1	49	20.80	20.72	33	-12.27863
				25	12	19.82	19.74	33	-13.25863
				50	0	19.85	19.77	33	-13.22863
10	18650	1855	256QAM	1	0	18.08	18.00	33	-14.99863
				1	49	17.95	17.87	33	-15.12863
				25	12	17.89	17.81	33	-15.18863
				50	0	17.91	17.83	33	-15.16863
	18900	1880	256QAM	1	0	18.16	18.08	33	-14.91863
				1	49	18.05	17.97	33	-15.02863
				25	12	17.97	17.89	33	-15.10863
				50	0	17.99	17.91	33	-15.08863
	19150	1905	256QAM	1	0	18.05	17.97	33	-15.02863
				1	49	17.85	17.77	33	-15.22863
				25	12	17.82	17.74	33	-15.25863
				50	0	17.79	17.71	33	-15.28863

Unless otherwise stated the results shown in this test report refer only to the sample(s) tested and such sample(s) are retained for 90 days only.

除非另有說明，此報告結果僅對測試之樣品負責，同時此樣品僅保留90天。本報告未經本公司書面許可，不可部份複製。

This document is issued by the Company subject to its General Conditions of Service printed overleaf, available on request or accessible at <http://www.sgs.com.tw/Terms-and-Conditions> and for electronic format documents, subject to Terms and Conditions for Electronic Documents at <http://www.sgs.com.tw/Terms-and-Conditions>. Attention is drawn to the limitation of liability, indemnification and jurisdiction issues defined therein. Any holder of this document is advised that information contained hereon reflects the Company's findings at the time of its intervention only and within the limits of Client's instructions, if any. The Company's sole responsibility is to its Client and this document does not exonerate parties to a transaction from exercising all their rights and obligations under the transaction documents. This document cannot be reproduced except in full, without prior written approval of the Company. Any unauthorized alteration, forgery or falsification of the content or appearance of this document is unlawful and offenders may be prosecuted to the fullest extent of the law.

Antenna gain (dBi)		-0.07863							
LTE Band 2_Uplink frequency band : 1850 to 1910 MHz									
BW (MHz)	UL Channel	Frequency (MHz)	Modulation	RB Size	RB Offset	Conducted Average (dBm)	EIRP Average (dBm)	EIRP Limit (dBm)	Margin (dB)
15	18675	1857.5	QPSK	1	0	22.59	22.51	33	-10.48863
				1	74	22.66	22.58	33	-10.41863
				36	18	21.69	21.61	33	-11.38863
				75	0	21.80	21.72	33	-11.27863
	18900	1880	QPSK	1	0	22.65	22.57	33	-10.42863
				1	74	22.74	22.66	33	-10.33863
				36	18	21.79	21.71	33	-11.28863
				75	0	21.77	21.69	33	-11.30863
	19125	1902.5	QPSK	1	0	22.55	22.47	33	-10.52863
				1	74	22.39	22.31	33	-10.68863
				36	18	21.72	21.64	33	-11.35863
				75	0	21.71	21.63	33	-11.36863
15	18675	1857.5	16QAM	1	0	21.87	21.79	33	-11.20863
				1	74	21.83	21.75	33	-11.24863
				36	18	20.77	20.69	33	-12.30863
				75	0	20.79	20.71	33	-12.28863
	18900	1880	16QAM	1	0	21.86	21.78	33	-11.21863
				1	74	21.89	21.81	33	-11.18863
				36	18	20.73	20.65	33	-12.34863
				75	0	20.81	20.73	33	-12.26863
	19125	1902.5	16QAM	1	0	21.48	21.40	33	-11.59863
				1	74	21.44	21.36	33	-11.63863
				36	18	20.74	20.66	33	-12.33863
				75	0	20.74	20.66	33	-12.33863
15	18675	1857.5	64QAM	1	0	20.73	20.65	33	-12.34863
				1	74	20.83	20.75	33	-12.24863
				36	18	19.74	19.66	33	-13.33863
				75	0	19.77	19.69	33	-13.30863
	18900	1880	64QAM	1	0	20.82	20.74	33	-12.25863
				1	74	20.79	20.71	33	-12.28863
				36	18	19.76	19.68	33	-13.31863
				75	0	19.80	19.72	33	-13.27863
	19125	1902.5	64QAM	1	0	20.58	20.50	33	-12.49863
				1	74	20.65	20.57	33	-12.42863
				36	18	19.68	19.60	33	-13.39863
				75	0	19.69	19.61	33	-13.38863
15	18675	1857.5	256QAM	1	0	17.92	17.84	33	-15.15863
				1	74	18.03	17.95	33	-15.04863
				36	18	17.76	17.68	33	-15.31863
				75	0	17.75	17.67	33	-15.32863
	18900	1880	256QAM	1	0	18.04	17.96	33	-15.03863
				1	74	18.01	17.93	33	-15.06863
				36	18	17.81	17.73	33	-15.26863
				75	0	17.82	17.74	33	-15.25863
	19125	1902.5	256QAM	1	0	17.98	17.90	33	-15.09863
				1	74	17.82	17.74	33	-15.25863
				36	18	17.70	17.62	33	-15.37863
				75	0	17.68	17.60	33	-15.39863

Unless otherwise stated the results shown in this test report refer only to the sample(s) tested and such sample(s) are retained for 90 days only.

除非另有說明，此報告結果僅對測試之樣品負責，同時此樣品僅保留90天。本報告未經本公司書面許可，不可部份複製。

This document is issued by the Company subject to its General Conditions of Service printed overleaf, available on request or accessible at <http://www.sgs.com.tw/Terms-and-Conditions> and for electronic format documents, subject to Terms and Conditions for Electronic Documents at <http://www.sgs.com.tw/Terms-and-Conditions>. Attention is drawn to the limitation of liability, indemnification and jurisdiction issues defined therein. Any holder of this document is advised that information contained hereon reflects the Company's findings at the time of its intervention only and within the limits of Client's instructions, if any. The Company's sole responsibility is to its Client and this document does not exonerate parties to a transaction from exercising all their rights and obligations under the transaction documents. This document cannot be reproduced except in full, without prior written approval of the Company. Any unauthorized alteration, forgery or falsification of the content or appearance of this document is unlawful and offenders may be prosecuted to the fullest extent of the law.

Antenna gain (dBi)		-0.07863							
LTE Band 2_Uplink frequency band : 1850 to 1910 MHz									
BW (MHz)	UL Channel	Frequency (MHz)	Modulation	RB Size	RB Offset	Conducted Average (dBm)	EIRP Average (dBm)	EIRP Limit (dBm)	Margin (dB)
20	18700	1860	QPSK	1	0	23.14	23.06	33	-9.93863
				1	99	22.75	22.67	33	-10.32863
				50	25	21.79	21.71	33	-11.28863
				100	0	21.77	21.69	33	-11.30863
	18900	1880	QPSK	1	0	22.63	22.55	33	-10.44863
				1	99	22.65	22.57	33	-10.42863
				50	25	21.81	21.73	33	-11.26863
				100	0	21.76	21.68	33	-11.31863
	19100	1900	QPSK	1	0	22.85	22.77	33	-10.22863
				1	99	22.78	22.70	33	-10.29863
				50	25	21.76	21.68	33	-11.31863
				100	0	21.69	21.61	33	-11.38863
20	18700	1860	16QAM	1	0	21.86	21.78	33	-11.21863
				1	99	21.76	21.68	33	-11.31863
				50	25	20.81	20.73	33	-12.26863
				100	0	20.73	20.65	33	-12.34863
	18900	1880	16QAM	1	0	22.06	21.98	33	-11.01863
				1	99	21.96	21.88	33	-11.11863
				50	25	20.82	20.74	33	-12.25863
				100	0	20.85	20.77	33	-12.22863
	19100	1900	16QAM	1	0	21.98	21.90	33	-11.09863
				1	99	20.86	20.78	33	-12.21863
				50	25	20.77	20.69	33	-12.30863
				100	0	20.68	20.60	33	-12.39863
20	18700	1860	64QAM	1	0	20.59	20.51	33	-12.48863
				1	99	20.80	20.72	33	-12.27863
				50	25	19.73	19.65	33	-13.34863
				100	0	19.76	19.68	33	-13.31863
	18900	1880	64QAM	1	0	20.94	20.86	33	-12.13863
				1	99	21.02	20.94	33	-12.05863
				50	25	19.81	19.73	33	-13.26863
				100	0	19.67	19.59	33	-13.40863
	19100	1900	64QAM	1	0	20.64	20.56	33	-12.43863
				1	99	20.55	20.47	33	-12.52863
				50	25	19.74	19.66	33	-13.33863
				100	0	19.73	19.65	33	-13.34863
20	18700	1860	256QAM	1	0	17.98	17.90	33	-15.09863
				1	99	18.01	17.93	33	-15.06863
				50	25	17.79	17.71	33	-15.28863
				100	0	17.77	17.69	33	-15.30863
	18900	1880	256QAM	1	0	17.94	17.86	33	-15.13863
				1	99	17.96	17.88	33	-15.11863
				50	25	17.82	17.74	33	-15.25863
				100	0	17.85	17.77	33	-15.22863
	19100	1900	256QAM	1	0	17.93	17.85	33	-15.14863
				1	99	17.94	17.86	33	-15.13863
				50	25	17.76	17.68	33	-15.31863
				100	0	17.74	17.66	33	-15.33863

Unless otherwise stated the results shown in this test report refer only to the sample(s) tested and such sample(s) are retained for 90 days only.

除非另有說明，此報告結果僅對測試之樣品負責，同時此樣品僅保留90天。本報告未經本公司書面許可，不可部份複製。

This document is issued by the Company subject to its General Conditions of Service printed overleaf, available on request or accessible at <http://www.sgs.com.tw/Terms-and-Conditions> and for electronic format documents, subject to Terms and Conditions for Electronic Documents at <http://www.sgs.com.tw/Terms-and-Conditions>. Attention is drawn to the limitation of liability, indemnification and jurisdiction issues defined therein. Any holder of this document is advised that information contained hereon reflects the Company's findings at the time of its intervention only and within the limits of Client's instructions, if any. The Company's sole responsibility is to its Client and this document does not exonerate parties to a transaction from exercising all their rights and obligations under the transaction documents. This document cannot be reproduced except in full, without prior written approval of the Company. Any unauthorized alteration, forgery or falsification of the content or appearance of this document is unlawful and offenders may be prosecuted to the fullest extent of the law.

Antenna gain (dBi)		-2.41266								
LTE Band 5_Uplink frequency band : 824 to 849 MHz										
BW (MHz)	UL Channel	Frequency (MHz)	Modulation	RB Size	RB Offset	Conducted Average (dBm)	ERP Average (dBm)	EIRP Average (dBm)	ERP Limit (dBm)	Margin (dB)
1.4	20407	824.7	QPSK	1	0	22.70	18.14	20.29	38.45	-20.31
				1	5	22.71	18.15	20.30	38.45	-20.30
				3	2	22.73	18.17	20.32	38.45	-20.28
				6	0	21.78	17.22	19.37	38.45	-21.23
	20525	836.5	QPSK	1	0	22.54	17.98	20.13	38.45	-20.47
				1	5	22.63	18.07	20.22	38.45	-20.38
				3	2	22.70	18.14	20.29	38.45	-20.31
				6	0	21.73	17.17	19.32	38.45	-21.28
	20643	848.3	QPSK	1	0	22.58	18.02	20.17	38.45	-20.43
				1	5	22.52	17.96	20.11	38.45	-20.49
				3	2	22.60	18.04	20.19	38.45	-20.41
				6	0	21.54	16.98	19.13	38.45	-21.47
1.4	20407	824.7	16QAM	1	0	22.08	17.52	19.67	38.45	-20.93
				1	5	21.81	17.25	19.40	38.45	-21.20
				3	2	21.79	17.23	19.38	38.45	-21.22
				6	0	20.83	16.27	18.42	38.45	-22.18
	20525	836.5	16QAM	1	0	21.74	17.18	19.33	38.45	-21.27
				1	5	22.05	17.49	19.64	38.45	-20.96
				3	2	21.83	17.27	19.42	38.45	-21.18
				6	0	20.67	16.11	18.26	38.45	-22.34
	20643	848.3	16QAM	1	0	21.88	17.32	19.47	38.45	-21.13
				1	5	21.76	17.20	19.35	38.45	-21.25
				3	2	21.60	17.04	19.19	38.45	-21.41
				6	0	20.63	16.07	18.22	38.45	-22.38
1.4	20407	824.7	64QAM	1	0	21.21	16.65	18.80	38.45	-21.80
				1	5	20.74	16.18	18.33	38.45	-22.27
				3	2	20.78	16.22	18.37	38.45	-22.23
				6	0	19.70	15.14	17.29	38.45	-23.31
	20525	836.5	64QAM	1	0	20.76	16.20	18.35	38.45	-22.25
				1	5	20.71	16.15	18.30	38.45	-22.30
				3	2	20.74	16.18	18.33	38.45	-22.27
				6	0	19.71	15.15	17.30	38.45	-23.30
	20643	848.3	64QAM	1	0	20.53	15.97	18.12	38.45	-22.48
				1	5	20.62	16.06	18.21	38.45	-22.39
				3	2	20.74	16.18	18.33	38.45	-22.27
				6	0	19.64	15.08	17.23	38.45	-23.37
1.4	20407	824.7	256QAM	1	0	18.03	13.47	15.62	38.45	-24.98
				1	5	17.96	13.40	15.55	38.45	-25.05
				3	2	17.91	13.35	15.50	38.45	-25.10
				6	0	17.84	13.28	15.43	38.45	-25.17
	20525	836.5	256QAM	1	0	17.97	13.41	15.56	38.45	-25.04
				1	5	17.90	13.34	15.49	38.45	-25.11
				3	2	17.81	13.25	15.40	38.45	-25.20
				6	0	17.79	13.23	15.38	38.45	-25.22
	20643	848.3	256QAM	1	0	17.78	13.22	15.37	38.45	-25.23
				1	5	17.85	13.29	15.44	38.45	-25.16
				3	2	17.69	13.13	15.28	38.45	-25.32
				6	0	17.63	13.07	15.22	38.45	-25.38

Unless otherwise stated the results shown in this test report refer only to the sample(s) tested and such sample(s) are retained for 90 days only.

除非另有說明，此報告結果僅對測試之樣品負責，同時此樣品僅保留90天。本報告未經本公司書面許可，不可部份複製。

This document is issued by the Company subject to its General Conditions of Service printed overleaf, available on request or accessible at <http://www.sgs.com.tw/Terms-and-Conditions> and for electronic format documents, subject to Terms and Conditions for Electronic Documents at <http://www.sgs.com.tw/Terms-and-Conditions>. Attention is drawn to the limitation of liability, indemnification and jurisdiction issues defined therein. Any holder of this document is advised that information contained herein reflects the Company's findings at the time of its intervention only and within the limits of Client's instructions, if any. The Company's sole responsibility is to its Client and this document does not exonerate parties to a transaction from exercising all their rights and obligations under the transaction documents. This document cannot be reproduced except in full, without prior written approval of the Company. Any unauthorized alteration, forgery or falsification of the content or appearance of this document is unlawful and offenders may be prosecuted to the fullest extent of the law.

Antenna gain (dBi)		-2.41266								
LTE Band 5_Uplink frequency band : 824 to 849 MHz										
BW (MHz)	UL Channel	Frequency (MHz)	Modulation	RB Size	RB Offset	Conducted Average (dBm)	ERP Average (dBm)	EIRP Average (dBm)	ERP Limit (dBm)	Margin (dB)
3	20415	825.5	QPSK	1	0	22.60	18.04	20.19	38.45	-20.41
				1	14	22.72	18.16	20.31	38.45	-20.29
				8	4	21.77	17.21	19.36	38.45	-21.24
				15	0	21.73	17.17	19.32	38.45	-21.28
	20525	836.5	QPSK	1	0	22.56	18.00	20.15	38.45	-20.45
				1	14	22.59	18.03	20.18	38.45	-20.42
				8	4	21.76	17.20	19.35	38.45	-21.25
				15	0	21.78	17.22	19.37	38.45	-21.23
	20635	847.5	QPSK	1	0	22.58	18.02	20.17	38.45	-20.43
				1	14	22.63	18.07	20.22	38.45	-20.38
				8	4	21.51	16.95	19.10	38.45	-21.50
				15	0	21.61	17.05	19.20	38.45	-21.40
3	20415	825.5	16QAM	1	0	21.93	17.37	19.52	38.45	-21.08
				1	14	21.89	17.33	19.48	38.45	-21.12
				8	4	20.84	16.28	18.43	38.45	-22.17
				15	0	20.70	16.14	18.29	38.45	-22.31
	20525	836.5	16QAM	1	0	21.81	17.25	19.40	38.45	-21.20
				1	14	21.86	17.30	19.45	38.45	-21.15
				8	4	20.59	16.03	18.18	38.45	-22.42
				15	0	20.70	16.14	18.29	38.45	-22.31
	20635	847.5	16QAM	1	0	21.87	17.31	19.46	38.45	-21.14
				1	14	21.74	17.18	19.33	38.45	-21.27
				8	4	20.68	16.12	18.27	38.45	-22.33
				15	0	20.52	15.96	18.11	38.45	-22.49
3	20415	825.5	64QAM	1	0	20.86	16.30	18.45	38.45	-22.15
				1	14	20.80	16.24	18.39	38.45	-22.21
				8	4	19.88	15.32	17.47	38.45	-23.13
				15	0	19.78	15.22	17.37	38.45	-23.23
	20525	836.5	64QAM	1	0	20.86	16.30	18.45	38.45	-22.15
				1	14	20.38	15.82	17.97	38.45	-22.63
				8	4	19.83	15.27	17.42	38.45	-23.18
				15	0	19.69	15.13	17.28	38.45	-23.32
	20635	847.5	64QAM	1	0	20.86	16.30	18.45	38.45	-22.15
				1	14	20.42	15.86	18.01	38.45	-22.59
				8	4	19.60	15.04	17.19	38.45	-23.41
				15	0	19.64	15.08	17.23	38.45	-23.37
3	20415	825.5	256QAM	1	0	17.95	13.39	15.54	38.45	-25.06
				1	14	18.02	13.46	15.61	38.45	-24.99
				8	4	17.88	13.32	15.47	38.45	-25.13
				15	0	17.77	13.21	15.36	38.45	-25.24
	20525	836.5	256QAM	1	0	17.91	13.35	15.50	38.45	-25.10
				1	14	17.98	13.42	15.57	38.45	-25.03
				8	4	17.83	13.27	15.42	38.45	-25.18
				15	0	17.80	13.24	15.39	38.45	-25.21
	20635	847.5	256QAM	1	0	17.74	13.18	15.33	38.45	-25.27
				1	14	17.80	13.24	15.39	38.45	-25.21
				8	4	17.77	13.21	15.36	38.45	-25.24
				15	0	17.67	13.11	15.26	38.45	-25.34

Unless otherwise stated the results shown in this test report refer only to the sample(s) tested and such sample(s) are retained for 90 days only.

除非另有說明，此報告結果僅對測試之樣品負責，同時此樣品僅保留90天。本報告未經本公司書面許可，不可部份複製。

This document is issued by the Company subject to its General Conditions of Service printed overleaf, available on request or accessible at <http://www.sgs.com.tw/Terms-and-Conditions> and for electronic format documents, subject to Terms and Conditions for Electronic Documents at <http://www.sgs.com.tw/Terms-and-Conditions>. Attention is drawn to the limitation of liability, indemnification and jurisdiction issues defined therein. Any holder of this document is advised that information contained herein reflects the Company's findings at the time of its intervention only and within the limits of Client's instructions, if any. The Company's sole responsibility is to its Client and this document does not exonerate parties to a transaction from exercising all their rights and obligations under the transaction documents. This document cannot be reproduced except in full, without prior written approval of the Company. Any unauthorized alteration, forgery or falsification of the content or appearance of this document is unlawful and offenders may be prosecuted to the fullest extent of the law.

Antenna gain (dBi)		-2.41266								
LTE Band 5_Uplink frequency band : 824 to 849 MHz										
BW (MHz)	UL Channel	Frequency (MHz)	Modulation	RB Size	RB Offset	Conducted Average (dBm)	ERP Average (dBm)	EIRP Average (dBm)	ERP Limit (dBm)	Margin (dB)
5	20425	826.5	QPSK	1	0	22.78	18.22	20.37	38.45	-20.23
				1	24	22.53	17.97	20.12	38.45	-20.48
				12	6	21.70	17.14	19.29	38.45	-21.31
				25	0	21.89	17.33	19.48	38.45	-21.12
	20525	836.5	QPSK	1	0	22.72	18.16	20.31	38.45	-20.29
				1	24	22.86	18.30	20.45	38.45	-20.15
				12	6	21.61	17.05	19.20	38.45	-21.40
				25	0	21.52	16.96	19.11	38.45	-21.49
	20625	846.5	QPSK	1	0	22.69	18.13	20.28	38.45	-20.32
				1	24	22.67	18.11	20.26	38.45	-20.34
				12	6	21.70	17.14	19.29	38.45	-21.31
				25	0	21.64	17.08	19.23	38.45	-21.37
5	20425	826.5	16QAM	1	0	22.11	17.55	19.70	38.45	-20.90
				1	24	22.11	17.55	19.70	38.45	-20.90
				12	6	20.90	16.34	18.49	38.45	-22.11
				25	0	20.82	16.26	18.41	38.45	-22.19
	20525	836.5	16QAM	1	0	21.59	17.03	19.18	38.45	-21.42
				1	24	21.94	17.38	19.53	38.45	-21.07
				12	6	20.71	16.15	18.30	38.45	-22.30
				25	0	20.77	16.21	18.36	38.45	-22.24
	20625	846.5	16QAM	1	0	21.95	17.39	19.54	38.45	-21.06
				1	24	21.89	17.33	19.48	38.45	-21.12
				12	6	20.78	16.22	18.37	38.45	-22.23
				25	0	20.68	16.12	18.27	38.45	-22.33
5	20425	826.5	64QAM	1	0	20.68	16.12	18.27	38.45	-22.33
				1	24	20.90	16.34	18.49	38.45	-22.11
				12	6	19.82	15.26	17.41	38.45	-23.19
				25	0	19.85	15.29	17.44	38.45	-23.16
	20525	836.5	64QAM	1	0	20.81	16.25	18.40	38.45	-22.20
				1	24	20.97	16.41	18.56	38.45	-22.04
				12	6	19.71	15.15	17.30	38.45	-23.30
				25	0	19.82	15.26	17.41	38.45	-23.19
	20625	846.5	64QAM	1	0	20.82	16.26	18.41	38.45	-22.19
				1	24	20.88	16.32	18.47	38.45	-22.13
				12	6	19.65	15.09	17.24	38.45	-23.36
				25	0	19.66	15.10	17.25	38.45	-23.35
5	20425	826.5	256QAM	1	0	18.03	13.47	15.62	38.45	-24.98
				1	24	18.01	13.45	15.60	38.45	-25.00
				12	6	17.87	13.31	15.46	38.45	-25.14
				25	0	17.85	13.29	15.44	38.45	-25.16
	20525	836.5	256QAM	1	0	18.07	13.51	15.66	38.45	-24.94
				1	24	18.01	13.45	15.60	38.45	-25.00
				12	6	17.76	13.20	15.35	38.45	-25.25
				25	0	17.81	13.25	15.40	38.45	-25.20
	20625	846.5	256QAM	1	0	17.93	13.37	15.52	38.45	-25.08
				1	24	17.87	13.31	15.46	38.45	-25.14
				12	6	17.71	13.15	15.30	38.45	-25.30
				25	0	17.70	13.14	15.29	38.45	-25.31

Unless otherwise stated the results shown in this test report refer only to the sample(s) tested and such sample(s) are retained for 90 days only.

除非另有說明，此報告結果僅對測試之樣品負責，同時此樣品僅保留90天。本報告未經本公司書面許可，不可部份複製。

This document is issued by the Company subject to its General Conditions of Service printed overleaf, available on request or accessible at <http://www.sgs.com.tw/Terms-and-Conditions> and for electronic format documents, subject to Terms and Conditions for Electronic Documents at <http://www.sgs.com.tw/Terms-and-Conditions>. Attention is drawn to the limitation of liability, indemnification and jurisdiction issues defined therein. Any holder of this document is advised that information contained herein reflects the Company's findings at the time of its intervention only and within the limits of Client's instructions, if any. The Company's sole responsibility is to its Client and this document does not exonerate parties to a transaction from exercising all their rights and obligations under the transaction documents. This document cannot be reproduced except in full, without prior written approval of the Company. Any unauthorized alteration, forgery or falsification of the content or appearance of this document is unlawful and offenders may be prosecuted to the fullest extent of the law.

Antenna gain (dBi)		-2.41266								
LTE Band 5_Uplink frequency band : 824 to 849 MHz										
BW (MHz)	UL Channel	Frequency (MHz)	Modulation	RB Size	RB Offset	Conducted Average (dBm)	ERP Average (dBm)	EIRP Average (dBm)	ERP Limit (dBm)	Margin (dB)
10	20450	829	QPSK	1	0	22.93	18.37	20.52	38.45	-20.08
				1	49	22.46	17.90	20.05	38.45	-20.55
				25	12	21.89	17.33	19.48	38.45	-21.12
				50	0	21.81	17.25	19.40	38.45	-21.20
	20525	836.5	QPSK	1	0	22.74	18.18	20.33	38.45	-20.27
				1	49	22.53	17.97	20.12	38.45	-20.48
				25	12	21.86	17.30	19.45	38.45	-21.15
				50	0	21.81	17.25	19.40	38.45	-21.20
	20600	844	QPSK	1	0	22.55	17.99	20.14	38.45	-20.46
				1	49	22.61	18.05	20.20	38.45	-20.40
				25	12	21.68	17.12	19.27	38.45	-21.33
				50	0	21.71	17.15	19.30	38.45	-21.30
10	20450	829	16QAM	1	0	21.82	17.26	19.41	38.45	-21.19
				1	49	22.22	17.66	19.81	38.45	-20.79
				25	12	20.92	16.36	18.51	38.45	-22.09
				50	0	20.84	16.28	18.43	38.45	-22.17
	20525	836.5	16QAM	1	0	21.88	17.32	19.47	38.45	-21.13
				1	49	21.25	16.69	18.84	38.45	-21.76
				25	12	20.90	16.34	18.49	38.45	-22.11
				50	0	20.84	16.28	18.43	38.45	-22.17
	20600	844	16QAM	1	0	21.80	17.24	19.39	38.45	-21.21
				1	49	21.84	17.28	19.43	38.45	-21.17
				25	12	20.44	15.88	18.03	38.45	-22.57
				50	0	20.63	16.07	18.22	38.45	-22.38
10	20450	829	64QAM	1	0	20.88	16.32	18.47	38.45	-22.13
				1	49	20.86	16.30	18.45	38.45	-22.15
				25	12	19.89	15.33	17.48	38.45	-23.12
				50	0	19.85	15.29	17.44	38.45	-23.16
	20525	836.5	64QAM	1	0	21.03	16.47	18.62	38.45	-21.98
				1	49	20.67	16.11	18.26	38.45	-22.34
				25	12	19.87	15.31	17.46	38.45	-23.14
				50	0	19.82	15.26	17.41	38.45	-23.19
	20600	844	64QAM	1	0	20.72	16.16	18.31	38.45	-22.29
				1	49	20.59	16.03	18.18	38.45	-22.42
				25	12	19.55	14.99	17.14	38.45	-23.46
				50	0	19.73	15.17	17.32	38.45	-23.28
10	20450	829	256QAM	1	0	18.03	13.47	15.62	38.45	-24.98
				1	49	17.99	13.43	15.58	38.45	-25.02
				25	12	17.96	13.40	15.55	38.45	-25.05
				50	0	17.90	13.34	15.49	38.45	-25.11
	20525	836.5	256QAM	1	0	18.02	13.46	15.61	38.45	-24.99
				1	49	18.04	13.48	15.63	38.45	-24.97
				25	12	17.85	13.29	15.44	38.45	-25.16
				50	0	17.89	13.33	15.48	38.45	-25.12
	20600	844	256QAM	1	0	17.94	13.38	15.53	38.45	-25.07
				1	49	17.86	13.30	15.45	38.45	-25.15
				25	12	17.77	13.21	15.36	38.45	-25.24
				50	0	17.76	13.20	15.35	38.45	-25.25

Unless otherwise stated the results shown in this test report refer only to the sample(s) tested and such sample(s) are retained for 90 days only.

除非另有說明，此報告結果僅對測試之樣品負責，同時此樣品僅保留90天。本報告未經本公司書面許可，不可部份複製。

This document is issued by the Company subject to its General Conditions of Service printed overleaf, available on request or accessible at <http://www.sgs.com.tw/Terms-and-Conditions> and for electronic format documents, subject to Terms and Conditions for Electronic Documents at <http://www.sgs.com.tw/Terms-and-Conditions>. Attention is drawn to the limitation of liability, indemnification and jurisdiction issues defined therein. Any holder of this document is advised that information contained herein reflects the Company's findings at the time of its intervention only and within the limits of Client's instructions, if any. The Company's sole responsibility is to its Client and this document does not exonerate parties to a transaction from exercising all their rights and obligations under the transaction documents. This document cannot be reproduced except in full, without prior written approval of the Company. Any unauthorized alteration, forgery or falsification of the content or appearance of this document is unlawful and offenders may be prosecuted to the fullest extent of the law.

Antenna gain (dBi)		-2.98952								
LTE Band 13_Uplink frequency band : 777 to 787 MHz										
BW (MHz)	UL Channel	Frequency (MHz)	Modulation	RB Size	RB Offset	Conducted Average (dBm)	ERP Average (dBm)	EIRP Average (dBm)	ERP Limit (dBm)	Margin (dB)
5	23205	779.5	QPSK	1	0	21.93	16.79	18.94	34.77	-17.98
				1	24	21.88	16.74	18.89	34.77	-18.03
				12	6	20.99	15.85	18.00	34.77	-18.92
				25	0	20.92	15.78	17.93	34.77	-18.99
	23230	782	QPSK	1	0	21.88	16.74	18.89	34.77	-18.03
				1	24	21.90	16.76	18.91	34.77	-18.01
				12	6	20.91	15.77	17.92	34.77	-19.00
				25	0	20.84	15.70	17.85	34.77	-19.07
	23255	784.5	QPSK	1	0	21.93	16.79	18.94	34.77	-17.98
				1	24	21.92	16.78	18.93	34.77	-17.99
				12	6	20.98	15.84	17.99	34.77	-18.93
				25	0	20.88	15.74	17.89	34.77	-19.03
5	23205	779.5	16QAM	1	0	20.89	15.75	17.90	34.77	-19.02
				1	24	20.87	15.73	17.88	34.77	-19.04
				12	6	20.01	14.87	17.02	34.77	-19.90
				25	0	19.99	14.85	17.00	34.77	-19.92
	23230	782	16QAM	1	0	21.03	15.89	18.04	34.77	-18.88
				1	24	21.09	15.95	18.10	34.77	-18.82
				12	6	19.98	14.84	16.99	34.77	-19.93
				25	0	19.92	14.78	16.93	34.77	-19.99
	23255	784.5	16QAM	1	0	21.19	16.05	18.20	34.77	-18.72
				1	24	21.14	16.00	18.15	34.77	-18.77
				12	6	19.97	14.83	16.98	34.77	-19.94
				25	0	19.98	14.84	16.99	34.77	-19.93
5	23205	779.5	64QAM	1	0	19.90	14.76	16.91	34.77	-20.01
				1	24	19.92	14.78	16.93	34.77	-19.99
				12	6	19.01	13.87	16.02	34.77	-20.90
				25	0	18.98	13.84	15.99	34.77	-20.93
	23230	782	64QAM	1	0	19.74	14.60	16.75	34.77	-20.17
				1	24	20.06	14.92	17.07	34.77	-19.85
				12	6	18.89	13.75	15.90	34.77	-21.02
				25	0	18.78	13.64	15.79	34.77	-21.13
	23255	784.5	64QAM	1	0	20.05	14.91	17.06	34.77	-19.86
				1	24	20.24	15.10	17.25	34.77	-19.67
				12	6	18.98	13.84	15.99	34.77	-20.93
				25	0	18.87	13.73	15.88	34.77	-21.04
5	23205	779.5	256QAM	1	0	16.97	11.83	13.98	34.77	-22.94
				1	24	17.08	11.94	14.09	34.77	-22.83
				12	6	17.04	11.90	14.05	34.77	-22.87
				25	0	16.96	11.82	13.97	34.77	-22.95
	23230	782	256QAM	1	0	16.97	11.83	13.98	34.77	-22.94
				1	24	17.09	11.95	14.10	34.77	-22.82
				12	6	16.92	11.78	13.93	34.77	-22.99
				25	0	16.89	11.75	13.90	34.77	-23.02
	23255	784.5	256QAM	1	0	17.09	11.95	14.10	34.77	-22.82
				1	24	17.04	11.90	14.05	34.77	-22.87
				12	6	16.99	11.85	14.00	34.77	-22.92
				25	0	16.97	11.83	13.98	34.77	-22.94

Unless otherwise stated the results shown in this test report refer only to the sample(s) tested and such sample(s) are retained for 90 days only.

除非另有說明，此報告結果僅對測試之樣品負責，同時此樣品僅保留90天。本報告未經本公司書面許可，不可部份複製。

This document is issued by the Company subject to its General Conditions of Service printed overleaf, available on request or accessible at <http://www.sgs.com.tw/Terms-and-Conditions> and for electronic format documents, subject to Terms and Conditions for Electronic Documents at <http://www.sgs.com.tw/Terms-and-Conditions>. Attention is drawn to the limitation of liability, indemnification and jurisdiction issues defined therein. Any holder of this document is advised that information contained herein reflects the Company's findings at the time of its intervention only and within the limits of Client's instructions, if any. The Company's sole responsibility is to its Client and this document does not exonerate parties to a transaction from exercising all their rights and obligations under the transaction documents. This document cannot be reproduced except in full, without prior written approval of the Company. Any unauthorized alteration, forgery or falsification of the content or appearance of this document is unlawful and offenders may be prosecuted to the fullest extent of the law.

Antenna gain (dBi)		-2.98952								
LTE Band 13_Uplink frequency band : 777 to 787 MHz										
BW (MHz)	UL Channel	Frequency (MHz)	Modulation	RB Size	RB Offset	Conducted Average (dBm)	ERP Average (dBm)	EIRP Average (dBm)	ERP Limit (dBm)	Margin (dB)
10	23230	782	QPSK	1	0	22.16	17.02	19.17	34.77	-17.75
				1	49	22.02	16.88	19.03	34.77	-17.89
				25	12	20.94	15.80	17.95	34.77	-18.97
				50	0	20.93	15.79	17.94	34.77	-18.98
10	23230	782	16QAM	1	0	21.19	16.05	18.20	34.77	-18.72
				1	49	21.04	15.90	18.05	34.77	-18.87
				25	12	19.94	14.80	16.95	34.77	-19.97
				50	0	19.90	14.76	16.91	34.77	-20.01
10	23230	782	64QAM	1	0	20.08	14.94	17.09	34.77	-19.83
				1	49	20.08	14.94	17.09	34.77	-19.83
				25	12	19.07	13.93	16.08	34.77	-20.84
				50	0	18.90	13.76	15.91	34.77	-21.01
10	23230	782	256QAM	1	0	17.11	11.97	14.12	34.77	-22.80
				1	49	17.20	12.06	14.21	34.77	-22.71
				25	12	17.01	11.87	14.02	34.77	-22.90
				50	0	17.09	11.95	14.10	34.77	-22.82

Unless otherwise stated the results shown in this test report refer only to the sample(s) tested and such sample(s) are retained for 90 days only.

除非另有說明，此報告結果僅對測試之樣品負責，同時此樣品僅保留90天。本報告未經本公司書面許可，不可部份複製。

This document is issued by the Company subject to its General Conditions of Service printed overleaf, available on request or accessible at <http://www.sgs.com.tw/Terms-and-Conditions> and for electronic format documents, subject to Terms and Conditions for Electronic Documents at <http://www.sgs.com.tw/Terms-and-Conditions>. Attention is drawn to the limitation of liability, indemnification and jurisdiction issues defined therein. Any holder of this document is advised that information contained hereon reflects the Company's findings at the time of its intervention only and within the limits of Client's instructions, if any. The Company's sole responsibility is to its Client and this document does not exonerate parties to a transaction from exercising all their rights and obligations under the transaction documents. This document cannot be reproduced except in full, without prior written approval of the Company. Any unauthorized alteration, forgery or falsification of the content or appearance of this document is unlawful and offenders may be prosecuted to the fullest extent of the law.

Antenna gain (dBi)		-0.89447							
LTE Band 66_Uplink frequency band : 1710 to 1780 MHz									
BW (MHz)	UL Channel	Frequency (MHz)	Modulation	RB Size	RB Offset	Conducted Average (dBm)	EIRP Average (dBm)	EIRP Limit (dBm)	Margin (dB)
1.4	131979	1710.7	QPSK	1	0	22.36	21.47	30	-8.53447
				1	5	22.33	21.44	30	-8.56447
				3	2	22.36	21.47	30	-8.53447
				6	0	21.34	20.45	30	-9.55447
	132322	1745	QPSK	1	0	22.54	21.65	30	-8.35447
				1	5	22.53	21.64	30	-8.36447
				3	2	22.63	21.74	30	-8.26447
				6	0	21.62	20.73	30	-9.27447
	132665	1779.3	QPSK	1	0	22.38	21.49	30	-8.51447
				1	5	22.47	21.58	30	-8.42447
				3	2	22.48	21.59	30	-8.41447
				6	0	21.59	20.70	30	-9.30447
1.4	131979	1710.7	16QAM	1	0	21.50	20.61	30	-9.39447
				1	5	21.79	20.90	30	-9.10447
				3	2	21.48	20.59	30	-9.41447
				6	0	20.41	19.52	30	-10.48447
	132322	1745	16QAM	1	0	21.84	20.95	30	-9.05447
				1	5	21.87	20.98	30	-9.02447
				3	2	21.71	20.82	30	-9.18447
				6	0	20.65	19.76	30	-10.24447
	132665	1779.3	16QAM	1	0	21.39	20.50	30	-9.50447
				1	5	21.69	20.80	30	-9.20447
				3	2	21.43	20.54	30	-9.46447
				6	0	20.60	19.71	30	-10.29447
1.4	131979	1710.7	64QAM	1	0	20.25	19.36	30	-10.64447
				1	5	20.27	19.38	30	-10.62447
				3	2	20.32	19.43	30	-10.57447
				6	0	19.31	18.42	30	-11.58447
	132322	1745	64QAM	1	0	20.41	19.52	30	-10.48447
				1	5	20.60	19.71	30	-10.29447
				3	2	20.72	19.83	30	-10.17447
				6	0	19.66	18.77	30	-11.23447
	132665	1779.3	64QAM	1	0	20.48	19.59	30	-10.41447
				1	5	20.43	19.54	30	-10.46447
				3	2	20.59	19.70	30	-10.30447
				6	0	19.50	18.61	30	-11.39447
1.4	131979	1710.7	256QAM	1	0	17.55	16.66	30	-13.34447
				1	5	17.56	16.67	30	-13.33447
				3	2	17.43	16.54	30	-13.46447
				6	0	17.47	16.58	30	-13.42447
	132322	1745	256QAM	1	0	17.78	16.89	30	-13.11447
				1	5	17.76	16.87	30	-13.13447
				3	2	17.72	16.83	30	-13.17447
				6	0	17.61	16.72	30	-13.28447
	132665	1779.3	256QAM	1	0	17.75	16.86	30	-13.14447
				1	5	17.65	16.76	30	-13.24447
				3	2	17.52	16.63	30	-13.37447
				6	0	17.56	16.67	30	-13.33447

Unless otherwise stated the results shown in this test report refer only to the sample(s) tested and such sample(s) are retained for 90 days only.

除非另有說明，此報告結果僅對測試之樣品負責，同時此樣品僅保留90天。本報告未經本公司書面許可，不可部份複製。

This document is issued by the Company subject to its General Conditions of Service printed overleaf, available on request or accessible at <http://www.sgs.com.tw/Terms-and-Conditions> and for electronic format documents, subject to Terms and Conditions for Electronic Documents at <http://www.sgs.com.tw/Terms-and-Conditions>. Attention is drawn to the limitation of liability, indemnification and jurisdiction issues defined therein. Any holder of this document is advised that information contained hereon reflects the Company's findings at the time of its intervention only and within the limits of Client's instructions, if any. The Company's sole responsibility is to its Client and this document does not exonerate parties to a transaction from exercising all their rights and obligations under the transaction documents. This document cannot be reproduced except in full, without prior written approval of the Company. Any unauthorized alteration, forgery or falsification of the content or appearance of this document is unlawful and offenders may be prosecuted to the fullest extent of the law.

Antenna gain (dBi)		-0.89447							
LTE Band 66_Uplink frequency band : 1710 to 1780 MHz									
BW (MHz)	UL Channel	Frequency (MHz)	Modulation	RB Size	RB Offset	Conducted Average (dBm)	EIRP Average (dBm)	EIRP Limit (dBm)	Margin (dB)
3	131987	1711.5	QPSK	1	0	22.22	21.33	30	-8.67447
				1	14	22.32	21.43	30	-8.57447
				8	4	21.47	20.58	30	-9.42447
				15	0	21.38	20.49	30	-9.51447
	132322	1745	QPSK	1	0	22.51	21.62	30	-8.38447
				1	14	22.47	21.58	30	-8.42447
				8	4	21.70	20.81	30	-9.19447
				15	0	21.50	20.61	30	-9.39447
	132657	1778.5	QPSK	1	0	22.53	21.64	30	-8.36447
				1	14	22.40	21.51	30	-8.49447
				8	4	21.55	20.66	30	-9.34447
				15	0	21.53	20.64	30	-9.36447
3	131987	1711.5	16QAM	1	0	21.58	20.69	30	-9.31447
				1	14	21.52	20.63	30	-9.37447
				8	4	20.41	19.52	30	-10.48447
				15	0	20.39	19.50	30	-10.50447
	132322	1745	16QAM	1	0	21.87	20.98	30	-9.02447
				1	14	21.58	20.69	30	-9.31447
				8	4	20.67	19.78	30	-10.22447
				15	0	20.55	19.66	30	-10.34447
	132657	1778.5	16QAM	1	0	21.60	20.71	30	-9.29447
				1	14	21.64	20.75	30	-9.25447
				8	4	20.43	19.54	30	-10.46447
				15	0	20.53	19.64	30	-10.36447
3	131987	1711.5	64QAM	1	0	20.02	19.13	30	-10.87447
				1	14	20.71	19.82	30	-10.18447
				8	4	19.46	18.57	30	-11.43447
				15	0	19.43	18.54	30	-11.46447
	132322	1745	64QAM	1	0	20.72	19.83	30	-10.17447
				1	14	20.63	19.74	30	-10.26447
				8	4	19.68	18.79	30	-11.21447
				15	0	19.57	18.68	30	-11.32447
	132657	1778.5	64QAM	1	0	20.88	19.99	30	-10.01447
				1	14	20.66	19.77	30	-10.23447
				8	4	19.60	18.71	30	-11.29447
				15	0	19.56	18.67	30	-11.33447
3	131987	1711.5	256QAM	1	0	17.53	16.64	30	-13.36447
				1	14	17.54	16.65	30	-13.35447
				8	4	17.46	16.57	30	-13.43447
				15	0	17.40	16.51	30	-13.49447
	132322	1745	256QAM	1	0	17.67	16.78	30	-13.22447
				1	14	17.82	16.93	30	-13.07447
				8	4	17.60	16.71	30	-13.29447
				15	0	17.58	16.69	30	-13.31447
	132657	1778.5	256QAM	1	0	17.73	16.84	30	-13.16447
				1	14	17.71	16.82	30	-13.18447
				8	4	17.51	16.62	30	-13.38447
				15	0	17.58	16.69	30	-13.31447

Unless otherwise stated the results shown in this test report refer only to the sample(s) tested and such sample(s) are retained for 90 days only.

除非另有說明，此報告結果僅對測試之樣品負責，同時此樣品僅保留90天。本報告未經本公司書面許可，不可部份複製。

This document is issued by the Company subject to its General Conditions of Service printed overleaf, available on request or accessible at <http://www.sgs.com.tw/Terms-and-Conditions> and for electronic format documents, subject to Terms and Conditions for Electronic Documents at <http://www.sgs.com.tw/Terms-and-Conditions>. Attention is drawn to the limitation of liability, indemnification and jurisdiction issues defined therein. Any holder of this document is advised that information contained hereon reflects the Company's findings at the time of its intervention only and within the limits of Client's instructions, if any. The Company's sole responsibility is to its Client and this document does not exonerate parties to a transaction from exercising all their rights and obligations under the transaction documents. This document cannot be reproduced except in full, without prior written approval of the Company. Any unauthorized alteration, forgery or falsification of the content or appearance of this document is unlawful and offenders may be prosecuted to the fullest extent of the law.

LTE Band 66_Uplink frequency band : 1710 to 1780 MHz									
BW (MHz)	UL Channel	Frequency (MHz)	Modulation	RB Size	RB Offset	Conducted Average (dBm)	EIRP Average (dBm)	EIRP Limit (dBm)	Margin (dB)
5	131997	1712.5	QPSK	1	0	22.43	21.54	30	-8.46447
				1	24	22.46	21.57	30	-8.43447
				12	6	21.45	20.56	30	-9.44447
				25	0	21.45	20.56	30	-9.44447
	132322	1745	QPSK	1	0	22.58	21.69	30	-8.31447
				1	24	22.62	21.73	30	-8.27447
				12	6	21.61	20.72	30	-9.28447
				25	0	21.53	20.64	30	-9.36447
	132647	1777.5	QPSK	1	0	22.58	21.69	30	-8.31447
				1	24	22.53	21.64	30	-8.36447
				12	6	21.55	20.66	30	-9.34447
				25	0	21.59	20.70	30	-9.30447
5	131997	1712.5	16QAM	1	0	21.47	20.58	30	-9.42447
				1	24	21.56	20.67	30	-9.33447
				12	6	20.42	19.53	30	-10.47447
				25	0	20.44	19.55	30	-10.45447
	132322	1745	16QAM	1	0	21.95	21.06	30	-8.94447
				1	24	21.69	20.80	30	-9.20447
				12	6	20.56	19.67	30	-10.33447
				25	0	20.47	19.58	30	-10.42447
	132647	1777.5	16QAM	1	0	21.79	20.90	30	-9.10447
				1	24	21.76	20.87	30	-9.13447
				12	6	20.63	19.74	30	-10.26447
				25	0	20.61	19.72	30	-10.28447
5	131997	1712.5	64QAM	1	0	20.61	19.72	30	-10.28447
				1	24	20.59	19.70	30	-10.30447
				12	6	19.44	18.55	30	-11.45447
				25	0	19.46	18.57	30	-11.43447
	132322	1745	64QAM	1	0	20.69	19.80	30	-10.20447
				1	24	20.52	19.63	30	-10.37447
				12	6	19.70	18.81	30	-11.19447
				25	0	19.48	18.59	30	-11.41447
	132647	1777.5	64QAM	1	0	20.57	19.68	30	-10.32447
				1	24	20.81	19.92	30	-10.08447
				12	6	19.55	18.66	30	-11.34447
				25	0	19.50	18.61	30	-11.39447
5	131997	1712.5	256QAM	1	0	17.54	16.65	30	-13.35447
				1	24	17.53	16.64	30	-13.36447
				12	6	17.50	16.61	30	-13.39447
				25	0	17.44	16.55	30	-13.45447
	132322	1745	256QAM	1	0	17.78	16.89	30	-13.11447
				1	24	17.82	16.93	30	-13.07447
				12	6	17.63	16.74	30	-13.26447
				25	0	17.59	16.70	30	-13.30447
	132647	1777.5	256QAM	1	0	17.67	16.78	30	-13.22447
				1	24	17.61	16.72	30	-13.28447
				12	6	17.52	16.63	30	-13.37447
				25	0	17.55	16.66	30	-13.34447

Unless otherwise stated the results shown in this test report refer only to the sample(s) tested and such sample(s) are retained for 90 days only.

除非另有說明，此報告結果僅對測試之樣品負責，同時此樣品僅保留90天。本報告未經本公司書面許可，不可部份複製。

This document is issued by the Company subject to its General Conditions of Service printed overleaf, available on request or accessible at <http://www.sgs.com.tw/Terms-and-Conditions> and for electronic format documents, subject to Terms and Conditions for Electronic Documents at <http://www.sgs.com.tw/Terms-and-Conditions>. Attention is drawn to the limitation of liability, indemnification and jurisdiction issues defined therein. Any holder of this document is advised that information contained hereon reflects the Company's findings at the time of its intervention only and within the limits of Client's instructions, if any. The Company's sole responsibility is to its Client and this document does not exonerate parties to a transaction from exercising all their rights and obligations under the transaction documents. This document cannot be reproduced except in full, without prior written approval of the Company. Any unauthorized alteration, forgery or falsification of the content or appearance of this document is unlawful and offenders may be prosecuted to the fullest extent of the law.

Antenna gain (dBi)		-0.89447							
LTE Band 66_Uplink frequency band : 1710 to 1780 MHz									
BW (MHz)	UL Channel	Frequency (MHz)	Modulation	RB Size	RB Offset	Conducted Average (dBm)	EIRP Average (dBm)	EIRP Limit (dBm)	Margin (dB)
10	132022	1715	QPSK	1	0	22.26	21.37	30	-8.63447
				1	49	22.39	21.50	30	-8.50447
				25	12	21.49	20.60	30	-9.40447
				50	0	21.46	20.57	30	-9.43447
	132322	1745	QPSK	1	0	22.46	21.57	30	-8.43447
				1	49	22.61	21.72	30	-8.28447
				25	12	21.58	20.69	30	-9.31447
				50	0	21.58	20.69	30	-9.31447
	132622	1775	QPSK	1	0	22.49	21.60	30	-8.40447
				1	49	22.56	21.67	30	-8.33447
				25	12	21.58	20.69	30	-9.31447
				50	0	21.58	20.69	30	-9.31447
10	132022	1715	16QAM	1	0	21.49	20.60	30	-9.40447
				1	49	21.86	20.97	30	-9.03447
				25	12	20.47	19.58	30	-10.42447
				50	0	20.43	19.54	30	-10.46447
	132322	1745	16QAM	1	0	21.69	20.80	30	-9.20447
				1	49	21.75	20.86	30	-9.14447
				25	12	20.52	19.63	30	-10.37447
				50	0	20.52	19.63	30	-10.37447
	132622	1775	16QAM	1	0	21.93	21.04	30	-8.96447
				1	49	22.02	21.13	30	-8.87447
				25	12	20.59	19.70	30	-10.30447
				50	0	20.61	19.72	30	-10.28447
10	132022	1715	64QAM	1	0	20.22	19.33	30	-10.67447
				1	49	20.50	19.61	30	-10.39447
				25	12	19.45	18.56	30	-11.44447
				50	0	19.49	18.60	30	-11.40447
	132322	1745	64QAM	1	0	20.64	19.75	30	-10.25447
				1	49	20.61	19.72	30	-10.28447
				25	12	19.46	18.57	30	-11.43447
				50	0	19.57	18.68	30	-11.32447
	132622	1775	64QAM	1	0	20.65	19.76	30	-10.24447
				1	49	20.43	19.54	30	-10.46447
				25	12	19.57	18.68	30	-11.32447
				50	0	19.56	18.67	30	-11.33447
10	132022	1715	256QAM	1	0	17.59	16.70	30	-13.30447
				1	49	17.60	16.71	30	-13.29447
				25	12	17.48	16.59	30	-13.41447
				50	0	17.47	16.58	30	-13.42447
	132322	1745	256QAM	1	0	17.73	16.84	30	-13.16447
				1	49	17.75	16.86	30	-13.14447
				25	12	17.61	16.72	30	-13.28447
				50	0	17.64	16.75	30	-13.25447
	132622	1775	256QAM	1	0	17.67	16.78	30	-13.22447
				1	49	17.65	16.76	30	-13.24447
				25	12	17.64	16.75	30	-13.25447
				50	0	17.62	16.73	30	-13.27447

Unless otherwise stated the results shown in this test report refer only to the sample(s) tested and such sample(s) are retained for 90 days only.

除非另有說明，此報告結果僅對測試之樣品負責，同時此樣品僅保留90天。本報告未經本公司書面許可，不可部份複製。

This document is issued by the Company subject to its General Conditions of Service printed overleaf, available on request or accessible at <http://www.sgs.com.tw/Terms-and-Conditions> and for electronic format documents, subject to Terms and Conditions for Electronic Documents at <http://www.sgs.com.tw/Terms-and-Conditions>. Attention is drawn to the limitation of liability, indemnification and jurisdiction issues defined therein. Any holder of this document is advised that information contained hereon reflects the Company's findings at the time of its intervention only and within the limits of Client's instructions, if any. The Company's sole responsibility is to its Client and this document does not exonerate parties to a transaction from exercising all their rights and obligations under the transaction documents. This document cannot be reproduced except in full, without prior written approval of the Company. Any unauthorized alteration, forgery or falsification of the content or appearance of this document is unlawful and offenders may be prosecuted to the fullest extent of the law.

Antenna gain (dBi)		-0.89447							
LTE Band 66_Uplink frequency band : 1710 to 1780 MHz									
BW (MHz)	UL Channel	Frequency (MHz)	Modulation	RB Size	RB Offset	Conducted Average (dBm)	EIRP Average (dBm)	EIRP Limit (dBm)	Margin (dB)
15	132047	1717.5	QPSK	1	0	22.22	21.33	30	-8.67447
				1	74	22.34	21.45	30	-8.55447
				36	18	21.29	20.40	30	-9.60447
				75	0	21.32	20.43	30	-9.57447
	132322	1745	QPSK	1	0	22.33	21.44	30	-8.56447
				1	74	22.38	21.49	30	-8.51447
				36	18	21.51	20.62	30	-9.38447
				75	0	21.45	20.56	30	-9.44447
	132597	1772.5	QPSK	1	0	22.39	21.50	30	-8.50447
				1	74	22.37	21.48	30	-8.52447
				36	18	21.51	20.62	30	-9.38447
				75	0	21.52	20.63	30	-9.37447
15	132047	1717.5	16QAM	1	0	21.30	20.41	30	-9.59447
				1	74	21.42	20.53	30	-9.47447
				36	18	20.32	19.43	30	-10.57447
				75	0	20.31	19.42	30	-10.58447
	132322	1745	16QAM	1	0	21.19	20.30	30	-9.70447
				1	74	21.51	20.62	30	-9.38447
				36	18	20.49	19.60	30	-10.40447
				75	0	20.38	19.49	30	-10.51447
	132597	1772.5	16QAM	1	0	21.65	20.76	30	-9.24447
				1	74	21.68	20.79	30	-9.21447
				36	18	20.47	19.58	30	-10.42447
				75	0	20.39	19.50	30	-10.50447
15	132047	1717.5	64QAM	1	0	20.32	19.43	30	-10.57447
				1	74	20.39	19.50	30	-10.50447
				36	18	19.38	18.49	30	-11.51447
				75	0	19.29	18.40	30	-11.60447
	132322	1745	64QAM	1	0	20.46	19.57	30	-10.43447
				1	74	20.63	19.74	30	-10.26447
				36	18	19.42	18.53	30	-11.47447
				75	0	19.39	18.50	30	-11.50447
	132597	1772.5	64QAM	1	0	20.37	19.48	30	-10.52447
				1	74	20.78	19.89	30	-10.11447
				36	18	19.48	18.59	30	-11.41447
				75	0	19.53	18.64	30	-11.36447
15	132047	1717.5	256QAM	1	0	17.47	16.58	30	-13.42447
				1	74	17.50	16.61	30	-13.39447
				36	18	17.34	16.45	30	-13.55447
				75	0	17.32	16.43	30	-13.57447
	132322	1745	256QAM	1	0	17.61	16.72	30	-13.28447
				1	74	17.68	16.79	30	-13.21447
				36	18	17.50	16.61	30	-13.39447
				75	0	17.42	16.53	30	-13.47447
	132597	1772.5	256QAM	1	0	17.66	16.77	30	-13.23447
				1	74	17.62	16.73	30	-13.27447
				36	18	17.47	16.58	30	-13.42447
				75	0	17.45	16.56	30	-13.44447

Unless otherwise stated the results shown in this test report refer only to the sample(s) tested and such sample(s) are retained for 90 days only.

除非另有說明，此報告結果僅對測試之樣品負責，同時此樣品僅保留90天。本報告未經本公司書面許可，不可部份複製。

This document is issued by the Company subject to its General Conditions of Service printed overleaf, available on request or accessible at <http://www.sgs.com.tw/Terms-and-Conditions> and for electronic format documents, subject to Terms and Conditions for Electronic Documents at <http://www.sgs.com.tw/Terms-and-Conditions>. Attention is drawn to the limitation of liability, indemnification and jurisdiction issues defined therein. Any holder of this document is advised that information contained hereon reflects the Company's findings at the time of its intervention only and within the limits of Client's instructions, if any. The Company's sole responsibility is to its Client and this document does not exonerate parties to a transaction from exercising all their rights and obligations under the transaction documents. This document cannot be reproduced except in full, without prior written approval of the Company. Any unauthorized alteration, forgery or falsification of the content or appearance of this document is unlawful and offenders may be prosecuted to the fullest extent of the law.

Antenna gain (dBi)		-0.89447							
LTE Band 66_Uplink frequency band : 1710 to 1780 MHz									
BW (MHz)	UL Channel	Frequency (MHz)	Modulation	RB Size	RB Offset	Conducted Average (dBm)	EIRP Average (dBm)	EIRP Limit (dBm)	Margin (dB)
20	132072	1720	QPSK	1	0	22.69	21.80	30	-8.20447
				1	99	22.43	21.54	30	-8.46447
				50	25	21.38	20.49	30	-9.51447
				100	0	21.30	20.41	30	-9.59447
	132322	1745	QPSK	1	0	22.29	21.40	30	-8.60447
				1	99	22.43	21.54	30	-8.46447
				50	25	21.55	20.66	30	-9.34447
				100	0	21.39	20.50	30	-9.50447
	132572	1770	QPSK	1	0	22.41	21.52	30	-8.48447
				1	99	22.35	21.46	30	-8.54447
				50	25	21.55	20.66	30	-9.34447
				100	0	21.45	20.56	30	-9.44447
20	132072	1720	16QAM	1	0	21.41	20.52	30	-9.48447
				1	99	21.26	20.37	30	-9.63447
				50	25	20.35	19.46	30	-10.54447
				100	0	20.30	19.41	30	-10.59447
	132322	1745	16QAM	1	0	21.15	20.26	30	-9.74447
				1	99	21.65	20.76	30	-9.24447
				50	25	20.47	19.58	30	-10.42447
				100	0	20.41	19.52	30	-10.48447
	132572	1770	16QAM	1	0	21.72	20.83	30	-9.17447
				1	99	21.66	20.77	30	-9.23447
				50	25	20.53	19.64	30	-10.36447
				100	0	20.50	19.61	30	-10.39447
20	132072	1720	64QAM	1	0	20.38	19.49	30	-10.51447
				1	99	20.32	19.43	30	-10.57447
				50	25	19.41	18.52	30	-11.48447
				100	0	19.27	18.38	30	-11.62447
	132322	1745	64QAM	1	0	20.56	19.67	30	-10.33447
				1	99	20.60	19.71	30	-10.29447
				50	25	19.36	18.47	30	-11.53447
				100	0	19.40	18.51	30	-11.49447
	132572	1770	64QAM	1	0	20.80	19.91	30	-10.09447
				1	99	20.40	19.51	30	-10.49447
				50	25	19.58	18.69	30	-11.31447
				100	0	19.46	18.57	30	-11.43447
20	132072	1720	256QAM	1	0	17.45	16.56	30	-13.44447
				1	99	17.54	16.65	30	-13.35447
				50	25	17.43	16.54	30	-13.46447
				100	0	17.31	16.42	30	-13.58447
	132322	1745	256QAM	1	0	17.59	16.70	30	-13.30447
				1	99	17.61	16.72	30	-13.28447
				50	25	17.47	16.58	30	-13.42447
				100	0	17.46	16.57	30	-13.43447
	132572	1770	256QAM	1	0	17.64	16.75	30	-13.25447
				1	99	17.59	16.70	30	-13.30447
				50	25	17.50	16.61	30	-13.39447
				100	0	17.48	16.59	30	-13.41447

Unless otherwise stated the results shown in this test report refer only to the sample(s) tested and such sample(s) are retained for 90 days only.

除非另有說明，此報告結果僅對測試之樣品負責，同時此樣品僅保留90天。本報告未經本公司書面許可，不可部份複製。

This document is issued by the Company subject to its General Conditions of Service printed overleaf, available on request or accessible at <http://www.sgs.com.tw/Terms-and-Conditions> and for electronic format documents, subject to Terms and Conditions for Electronic Documents at <http://www.sgs.com.tw/Terms-and-Conditions>. Attention is drawn to the limitation of liability, indemnification and jurisdiction issues defined therein. Any holder of this document is advised that information contained hereon reflects the Company's findings at the time of its intervention only and within the limits of Client's instructions, if any. The Company's sole responsibility is to its Client and this document does not exonerate parties to a transaction from exercising all their rights and obligations under the transaction documents. This document cannot be reproduced except in full, without prior written approval of the Company. Any unauthorized alteration, forgery or falsification of the content or appearance of this document is unlawful and offenders may be prosecuted to the fullest extent of the law.

8 OCCUPIED BANDWIDTH MEASUREMENT

8.1 Standard Applicable

The occupied bandwidth is the frequency bandwidth such that, below its lower and above its upper frequency limits, the mean powers radiated are each equal to 0.5 percent of the total mean power.

8.2 Test Set-up

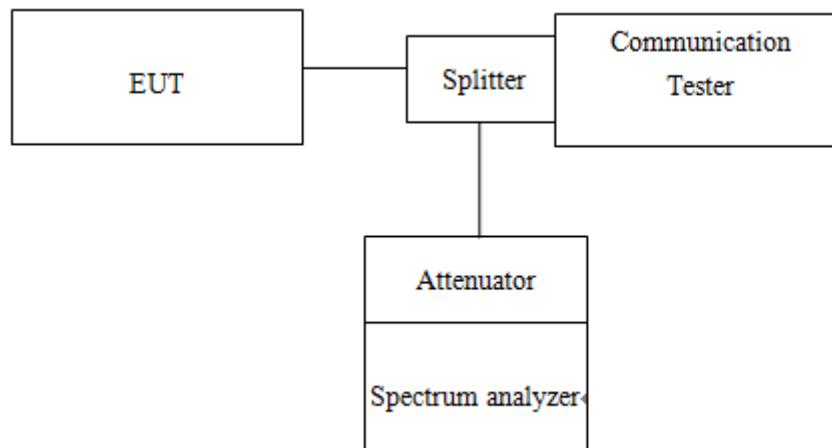

8.3 Measurement Procedure

99% & 26dB Bandwidth with detector peak

The EUT's output RF connector was connected with a short cable to the spectrum analyzer, RBW was set to about 1% of emission BW, VBW= 3 times RBW, -26dBc display line was placed on the screen (or 26dB bandwidth), the occupied bandwidth is the delta frequency between the two points where the display line intersects the signal trace. Then set RBW to 99% bandwidth, RBW= 1%, VBW= 3 * RBW, with span > 2 * Signal BW, set % Power = 99%.

Unless otherwise stated the results shown in this test report refer only to the sample(s) tested and such sample(s) are retained for 90 days only.

除非另有說明，此報告結果僅對測試之樣品負責，同時此樣品僅保留90天。本報告未經本公司書面許可，不可部份複製。

This document is issued by the Company subject to its General Conditions of Service printed overleaf, available on request or accessible at <http://www.sgs.com.tw/Terms-and-Conditions> and for electronic format documents, subject to Terms and Conditions for Electronic Documents at <http://www.sgs.com.tw/Terms-and-Conditions>. Attention is drawn to the limitation of liability, indemnification and jurisdiction issues defined therein. Any holder of this document is advised that information contained hereon reflects the Company's findings at the time of its intervention only and within the limits of Client's instructions, if any. The Company's sole responsibility is to its Client and this document does not exonerate parties to a transaction from exercising all their rights and obligations under the transaction documents. This document cannot be reproduced except in full, without prior written approval of the Company. Any unauthorized alteration, forgery or falsification of the content or appearance of this document is unlawful and offenders may be prosecuted to the fullest extent of the law.

Band2_1.4MHz_QPSK_RB6_0_CH18607

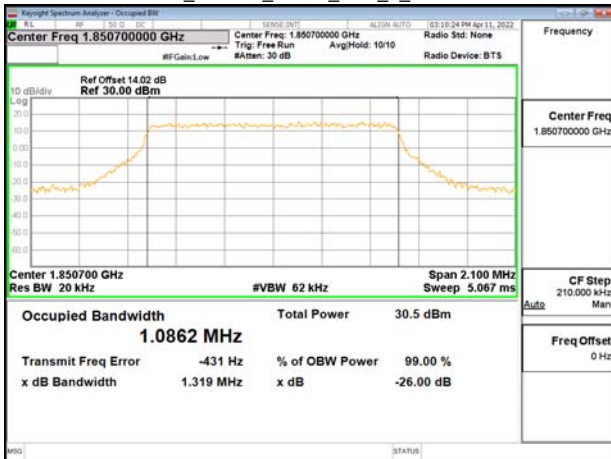

Band2_1.4MHz_16QAM_RB6_0_CH18607

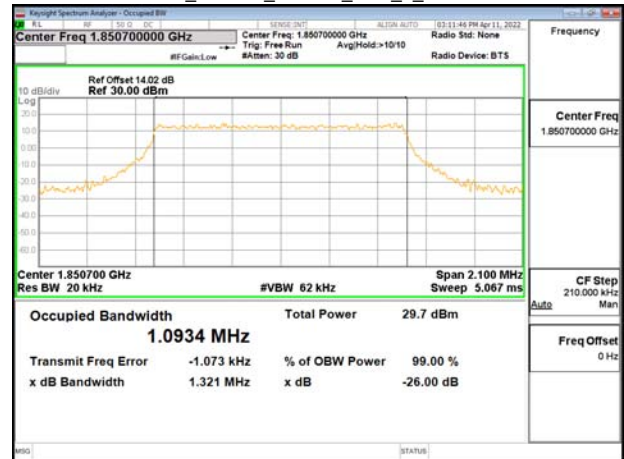

Band2_1.4MHz_QPSK_RB6_0_CH18900

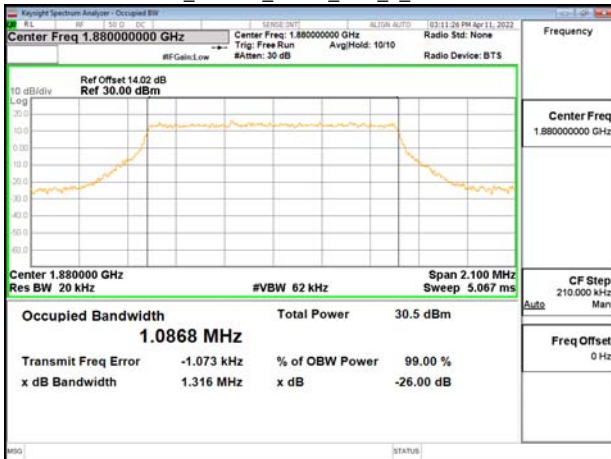

Band2_1.4MHz_16QAM_RB6_0_CH18900

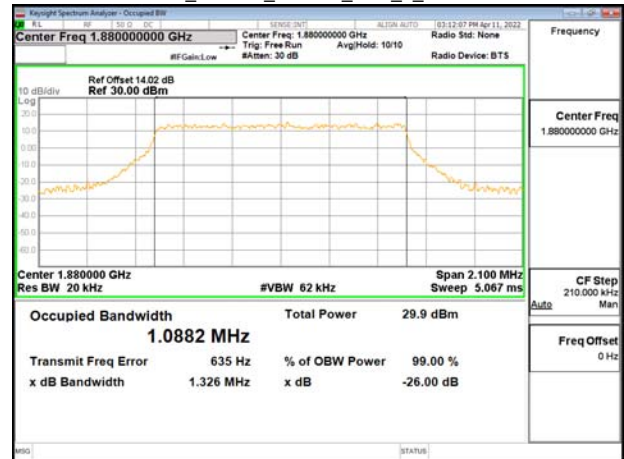

Band2_1.4MHz_QPSK_RB6_0_CH19193

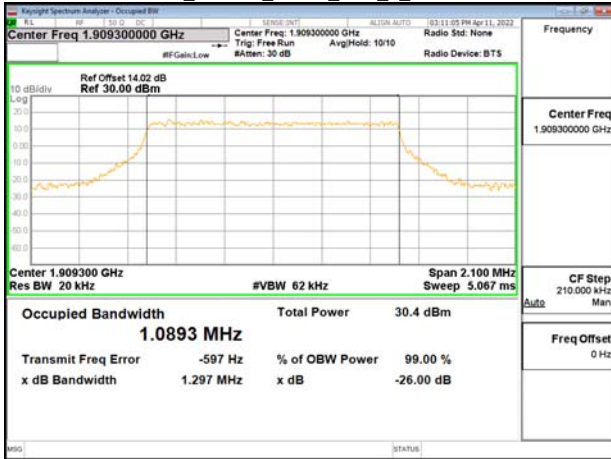

Band2_1.4MHz_16QAM_RB6_0_CH19193

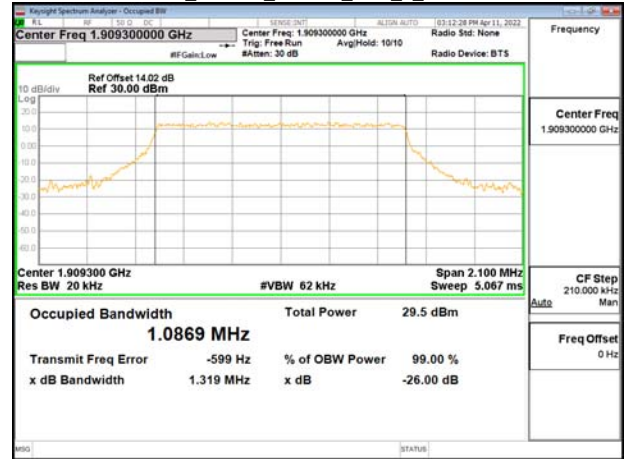

Unless otherwise stated the results shown in this test report refer only to the sample(s) tested and such sample(s) are retained for 90 days only.

除非另有說明，此報告結果僅對測試之樣品負責，同時此樣品僅保留90天。本報告未經本公司書面許可，不可部份複製。

This document is issued by the Company subject to its General Conditions of Service printed overleaf, available on request or accessible at <http://www.sgs.com.tw/Terms-and-Conditions> and for electronic format documents, subject to Terms and Conditions for Electronic Documents at <http://www.sgs.com.tw/Terms-and-Conditions>. Attention is drawn to the limitation of liability, indemnification and jurisdiction issues defined therein. Any holder of this document is advised that information contained herein reflects the Company's findings at the time of its intervention only and within the limits of Client's instructions, if any. The Company's sole responsibility is to its Client and this document does not exonerate parties to a transaction from exercising all their rights and obligations under the transaction documents. This document cannot be reproduced except in full, without prior written approval of the Company. Any unauthorized alteration, forgery or falsification of the content or appearance of this document is unlawful and offenders may be prosecuted to the fullest extent of the law.

Band2_1.4MHz_64QAM_RB6_0_CH18607

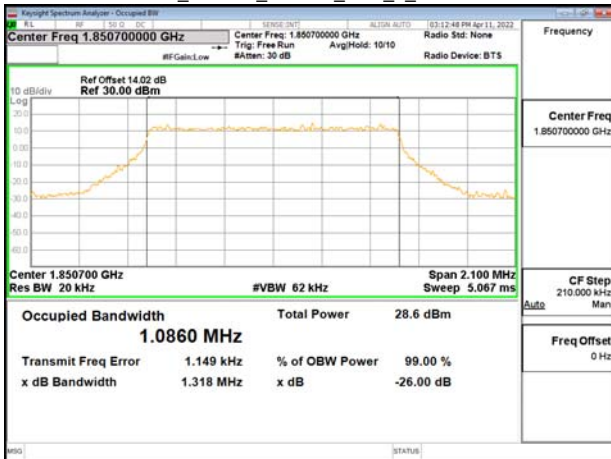

Band2_1.4MHz_256QAM_RB6_0_CH18607

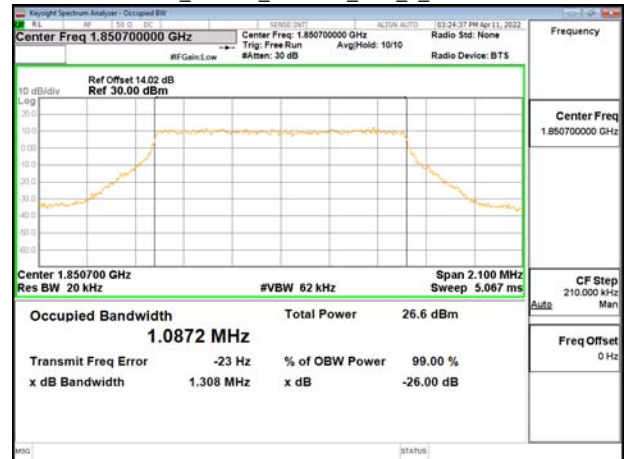

Band2_1.4MHz_64QAM_RB6_0_CH18900

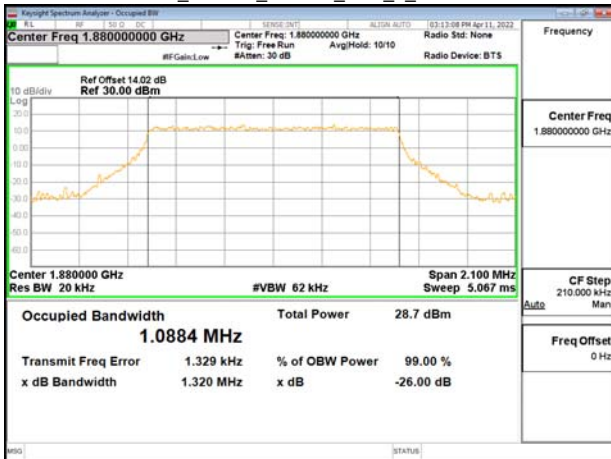

Band2_1.4MHz_256QAM_RB6_0_CH18900



Band2_1.4MHz_64QAM_RB6_0_CH19193



Band2_1.4MHz_256QAM_RB6_0_CH19193



Unless otherwise stated the results shown in this test report refer only to the sample(s) tested and such sample(s) are retained for 90 days only.

除非另有說明，此報告結果僅對測試之樣品負責，同時此樣品僅保留90天。本報告未經本公司書面許可，不可部份複製。

This document is issued by the Company subject to its General Conditions of Service printed overleaf, available on request or accessible at <http://www.sgs.com.tw/Terms-and-Conditions> and for electronic format documents, subject to Terms and Conditions for Electronic Documents at <http://www.sgs.com.tw/Terms-and-Conditions>. Attention is drawn to the limitation of liability, indemnification and jurisdiction issues defined therein. Any holder of this document is advised that information contained herein reflects the Company's findings at the time of its intervention only and within the limits of Client's instructions, if any. The Company's sole responsibility is to its Client and this document does not exonerate parties to a transaction from exercising all their rights and obligations under the transaction documents. This document cannot be reproduced except in full, without prior written approval of the Company. Any unauthorized alteration, forgery or falsification of the content or appearance of this document is unlawful and offenders may be prosecuted to the fullest extent of the law.

Band2_3MHz_QPSK_RB15_0_CH18615

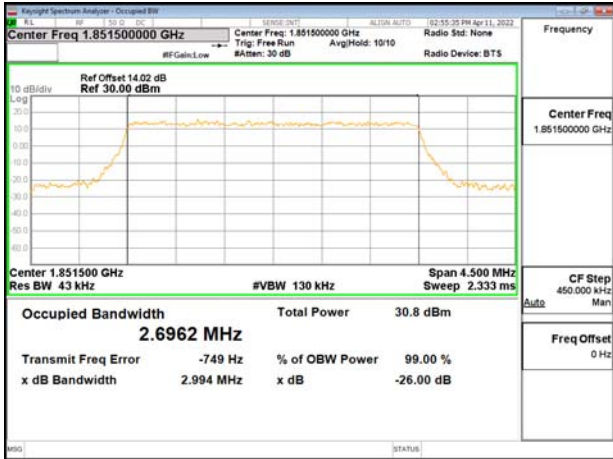

Band2_3MHz_16QAM_RB15_0_CH18615

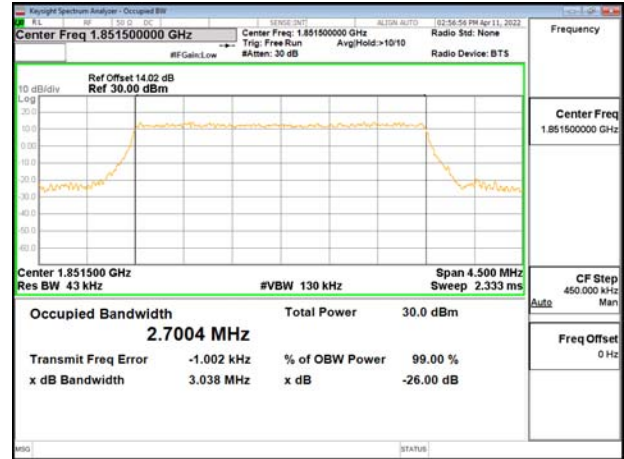

Band2_3MHz_QPSK_RB15_0_CH18900

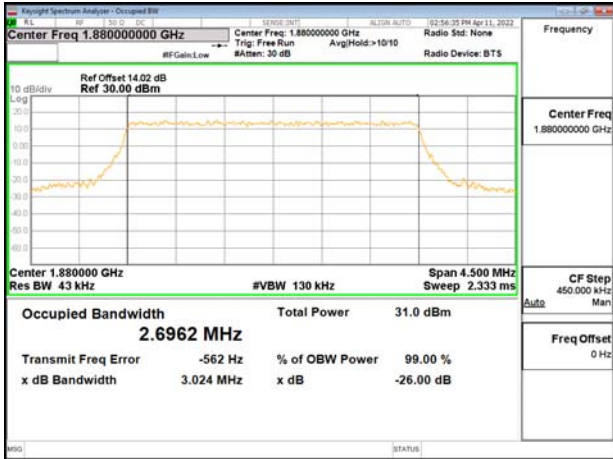

Band2_3MHz_16QAM_RB15_0_CH18900

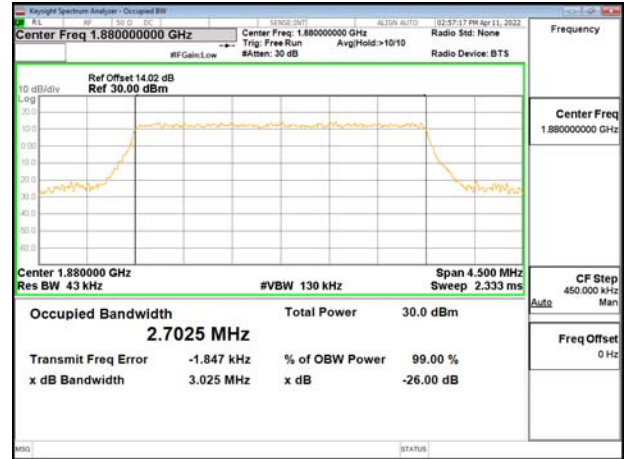

Band2_3MHz_QPSK_RB15_0_CH19185

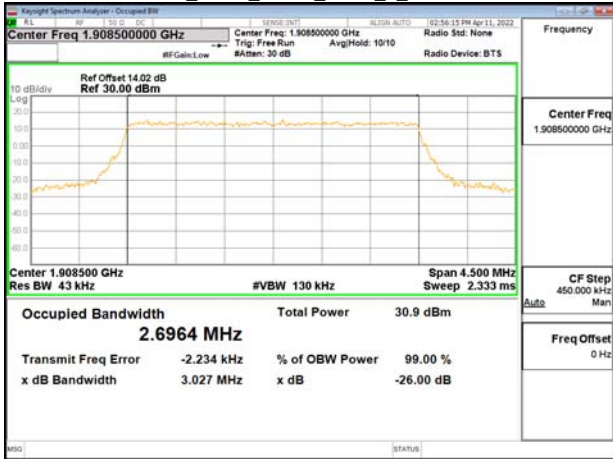

Band2_3MHz_16QAM_RB15_0_CH19185

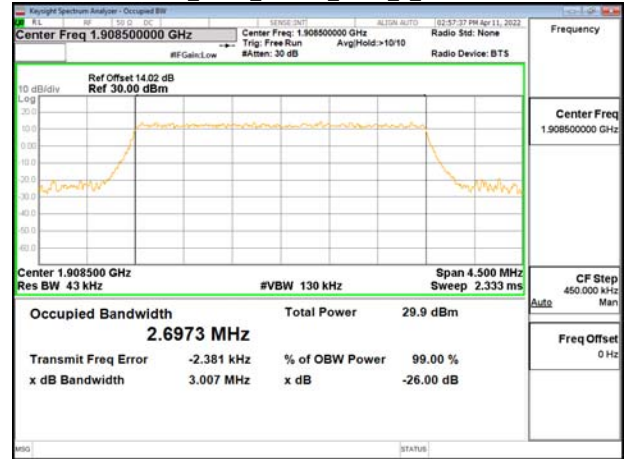

Unless otherwise stated the results shown in this test report refer only to the sample(s) tested and such sample(s) are retained for 90 days only.

除非另有說明，此報告結果僅對測試之樣品負責，同時此樣品僅保留90天。本報告未經本公司書面許可，不可部份複製。

This document is issued by the Company subject to its General Conditions of Service printed overleaf, available on request or accessible at <http://www.sgs.com.tw/Terms-and-Conditions> and for electronic format documents, subject to Terms and Conditions for Electronic Documents at <http://www.sgs.com.tw/Terms-and-Conditions>. Attention is drawn to the limitation of liability, indemnification and jurisdiction issues defined therein. Any holder of this document is advised that information contained herein reflects the Company's findings at the time of its intervention only and within the limits of Client's instructions, if any. The Company's sole responsibility is to its Client and this document does not exonerate parties to a transaction from exercising all their rights and obligations under the transaction documents. This document cannot be reproduced except in full, without prior written approval of the Company. Any unauthorized alteration, forgery or falsification of the content or appearance of this document is unlawful and offenders may be prosecuted to the fullest extent of the law.

Band2_3MHz_64QAM_RB15_0_CH18615

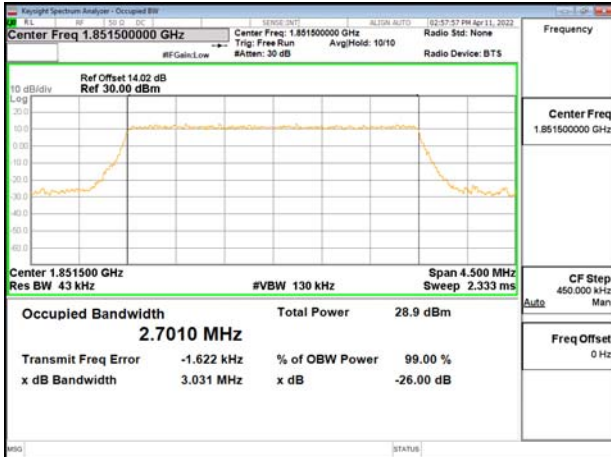

Band2_3MHz_256QAM_RB15_0_CH18615

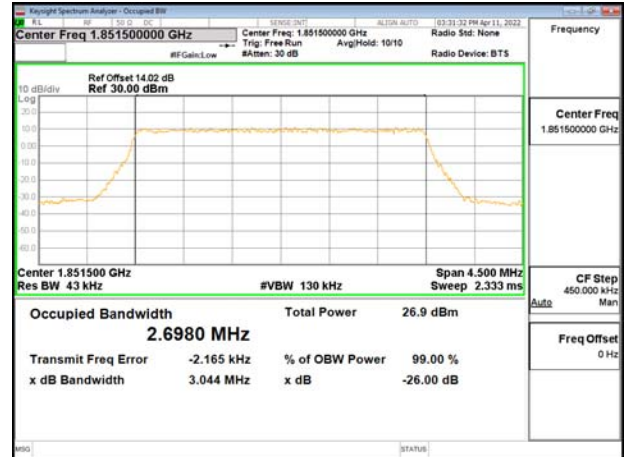

Band2_3MHz_64QAM_RB15_0_CH18900

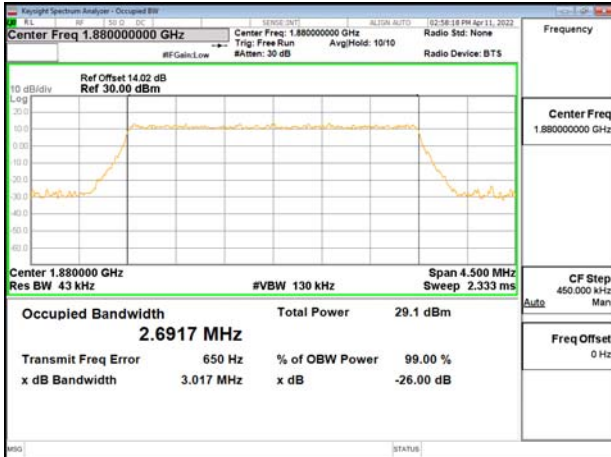

Band2_3MHz_256QAM_RB15_0_CH18900

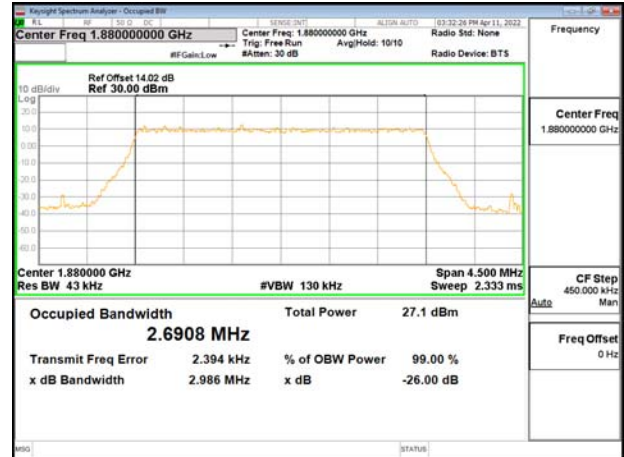

Band2_3MHz_64QAM_RB15_0_CH19185

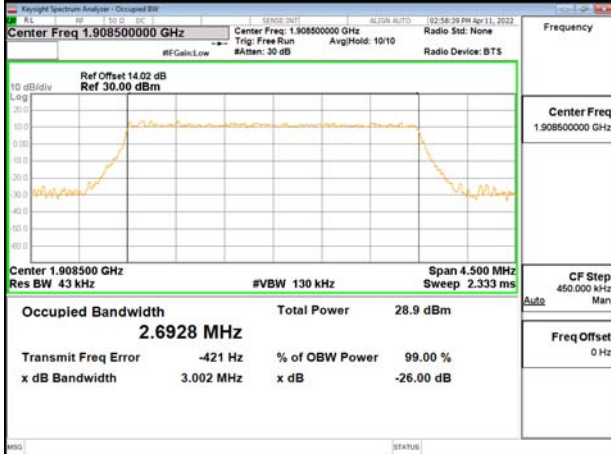

Band2_3MHz_256QAM_RB15_0_CH19185

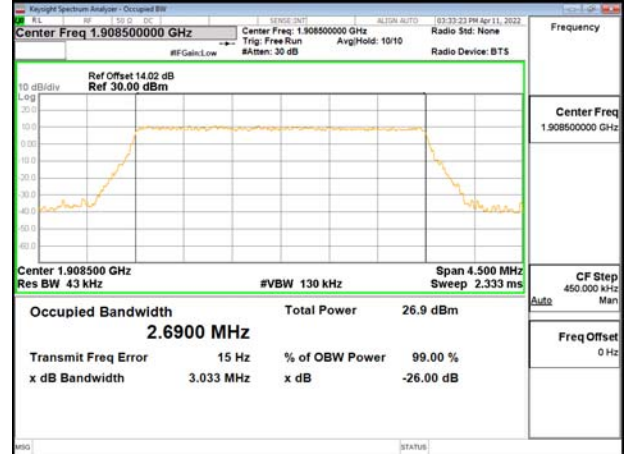

Unless otherwise stated the results shown in this test report refer only to the sample(s) tested and such sample(s) are retained for 90 days only.

除非另有說明，此報告結果僅對測試之樣品負責，同時此樣品僅保留90天。本報告未經本公司書面許可，不可部份複製。

This document is issued by the Company subject to its General Conditions of Service printed overleaf, available on request or accessible at <http://www.sgs.com.tw/Terms-and-Conditions> and for electronic format documents, subject to Terms and Conditions for Electronic Documents at <http://www.sgs.com.tw/Terms-and-Conditions>. Attention is drawn to the limitation of liability, indemnification and jurisdiction issues defined therein. Any holder of this document is advised that information contained herein reflects the Company's findings at the time of its intervention only and within the limits of Client's instructions, if any. The Company's sole responsibility is to its Client and this document does not exonerate parties to a transaction from exercising all their rights and obligations under the transaction documents. This document cannot be reproduced except in full, without prior written approval of the Company. Any unauthorized alteration, forgery or falsification of the content or appearance of this document is unlawful and offenders may be prosecuted to the fullest extent of the law.

Band2_5MHz_QPSK_RB25_0_CH18625

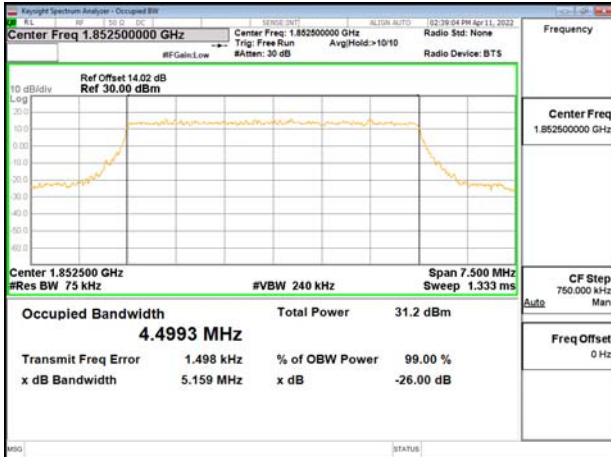

Band2_5MHz_16QAM_RB25_0_CH18625

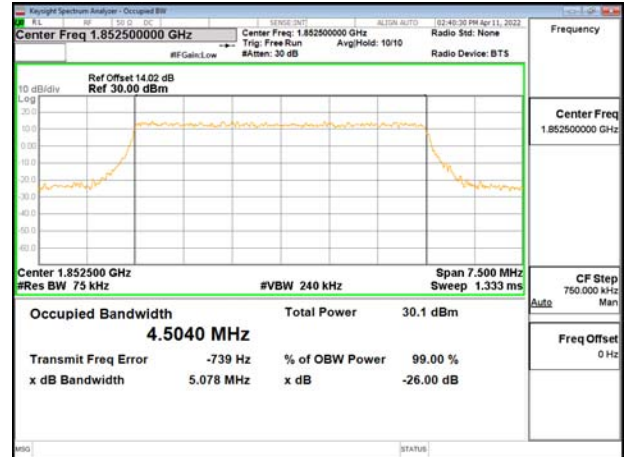

Band2_5MHz_QPSK_RB25_0_CH18900

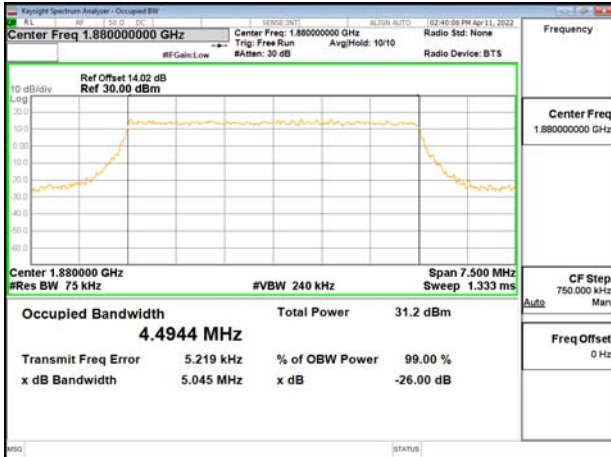

Band2_5MHz_16QAM_RB25_0_CH18900

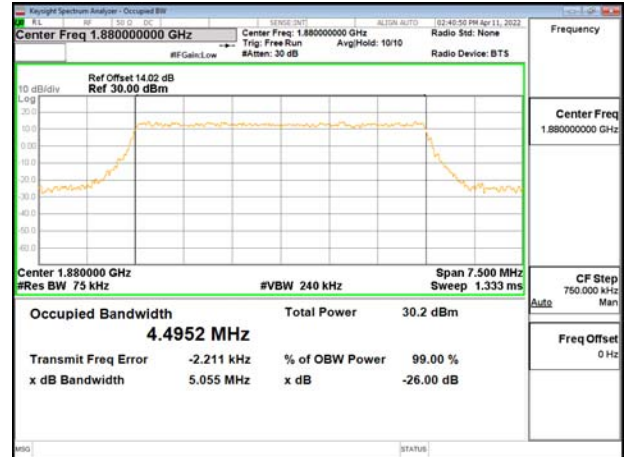

Band2_5MHz_QPSK_RB25_0_CH19175

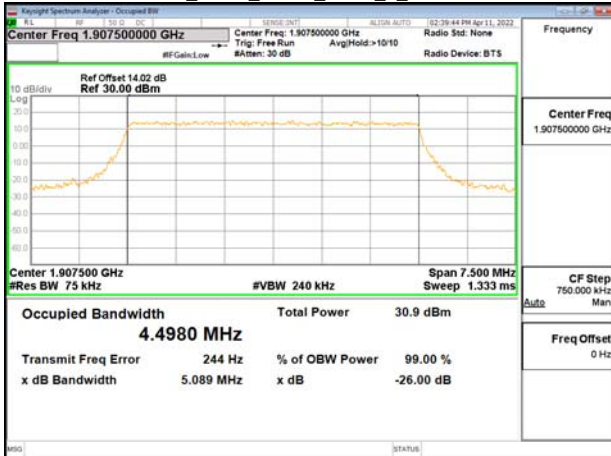

Band2_5MHz_16QAM_RB25_0_CH19175

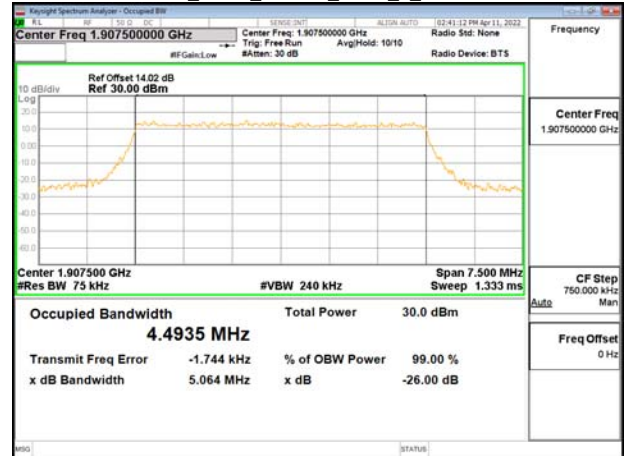

Unless otherwise stated the results shown in this test report refer only to the sample(s) tested and such sample(s) are retained for 90 days only.

除非另有說明，此報告結果僅對測試之樣品負責，同時此樣品僅保留90天。本報告未經本公司書面許可，不可部份複製。

This document is issued by the Company subject to its General Conditions of Service printed overleaf, available on request or accessible at <http://www.sgs.com.tw/Terms-and-Conditions> and for electronic format documents, subject to Terms and Conditions for Electronic Documents at <http://www.sgs.com.tw/Terms-and-Conditions>. Attention is drawn to the limitation of liability, indemnification and jurisdiction issues defined therein. Any holder of this document is advised that information contained herein reflects the Company's findings at the time of its intervention only and within the limits of Client's instructions, if any. The Company's sole responsibility is to its Client and this document does not exonerate parties to a transaction from exercising all their rights and obligations under the transaction documents. This document cannot be reproduced except in full, without prior written approval of the Company. Any unauthorized alteration, forgery or falsification of the content or appearance of this document is unlawful and offenders may be prosecuted to the fullest extent of the law.

Band2_5MHz_64QAM_RB25_0_CH18625

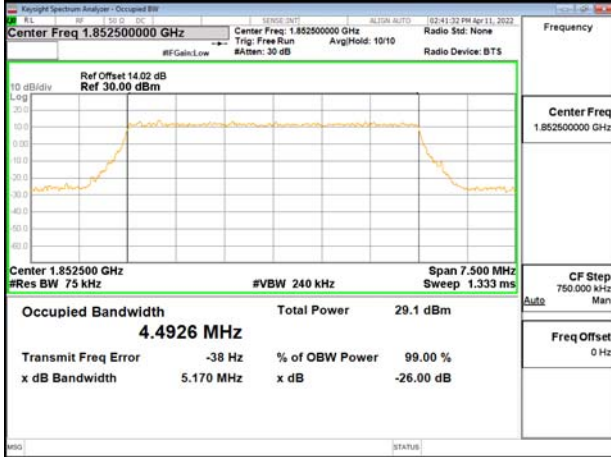

Band2_5MHz_256QAM_RB25_0_CH18625

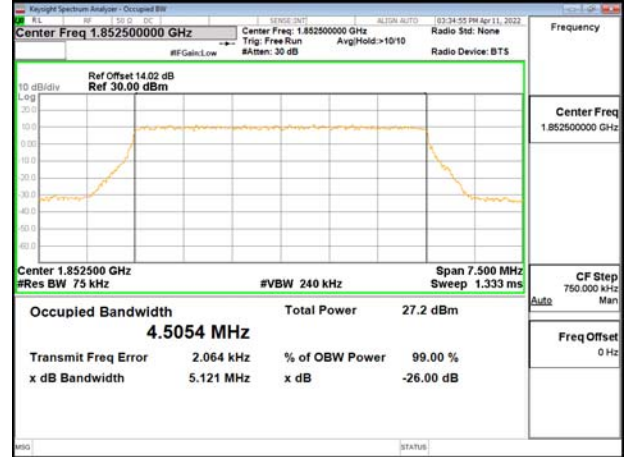

Band2_5MHz_64QAM_RB25_0_CH18900

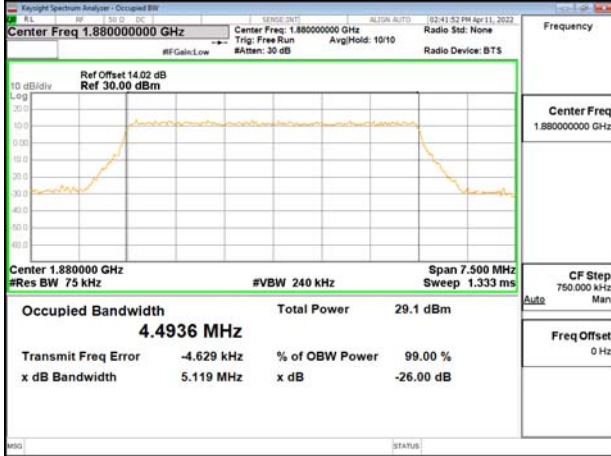

Band2_5MHz_256QAM_RB25_0_CH18900



Band2_5MHz_64QAM_RB25_0_CH19175

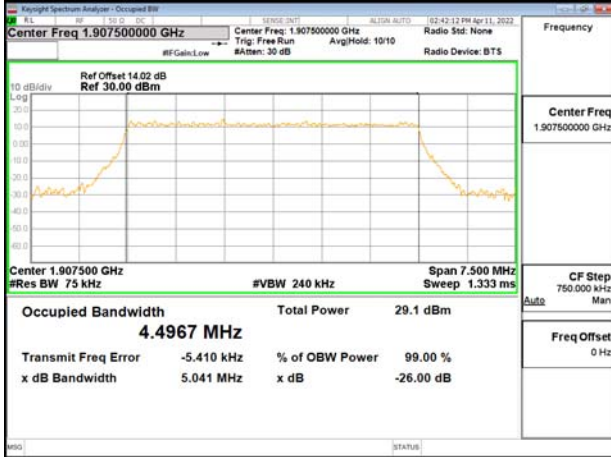

Band2_5MHz_256QAM_RB25_0_CH19175

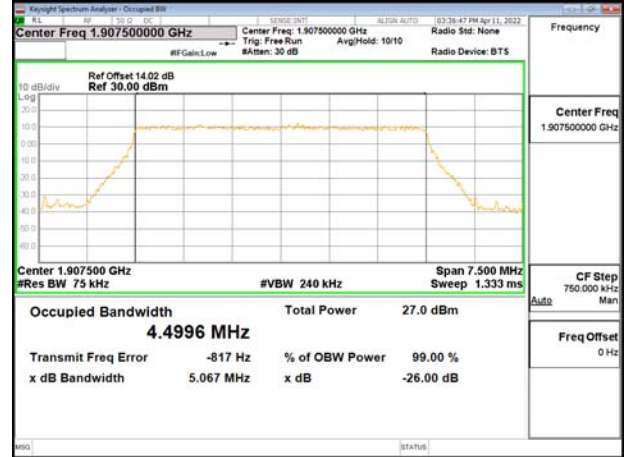

Unless otherwise stated the results shown in this test report refer only to the sample(s) tested and such sample(s) are retained for 90 days only.

除非另有說明，此報告結果僅對測試之樣品負責，同時此樣品僅保留90天。本報告未經本公司書面許可，不可部份複製。

This document is issued by the Company subject to its General Conditions of Service printed overleaf, available on request or accessible at <http://www.sgs.com.tw/Terms-and-Conditions> and for electronic format documents, subject to Terms and Conditions for Electronic Documents at <http://www.sgs.com.tw/Terms-and-Conditions>. Attention is drawn to the limitation of liability, indemnification and jurisdiction issues defined therein. Any holder of this document is advised that information contained herein reflects the Company's findings at the time of its intervention only and within the limits of Client's instructions, if any. The Company's sole responsibility is to its Client and this document does not exonerate parties to a transaction from exercising all their rights and obligations under the transaction documents. This document cannot be reproduced except in full, without prior written approval of the Company. Any unauthorized alteration, forgery or falsification of the content or appearance of this document is unlawful and offenders may be prosecuted to the fullest extent of the law.

Band2_10MHz_QPSK_RB50_0_CH18650

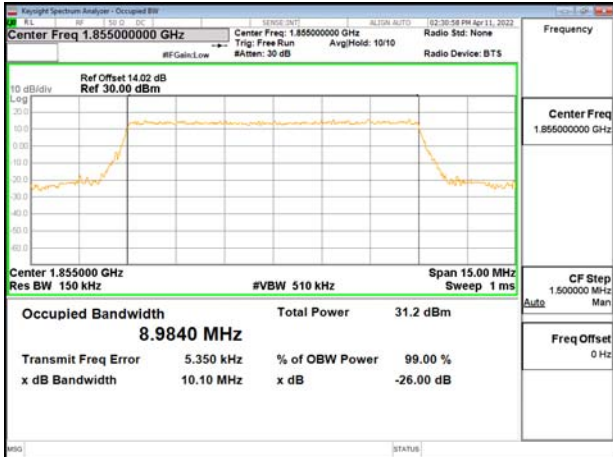

Band2_10MHz_16QAM_RB50_0_CH18650

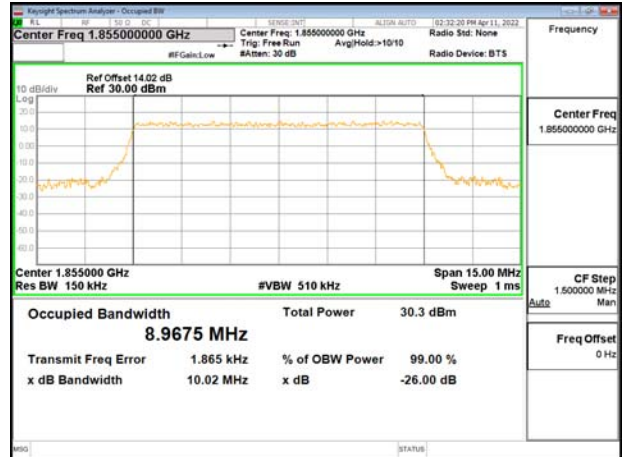

Band2_10MHz_QPSK_RB50_0_CH18900

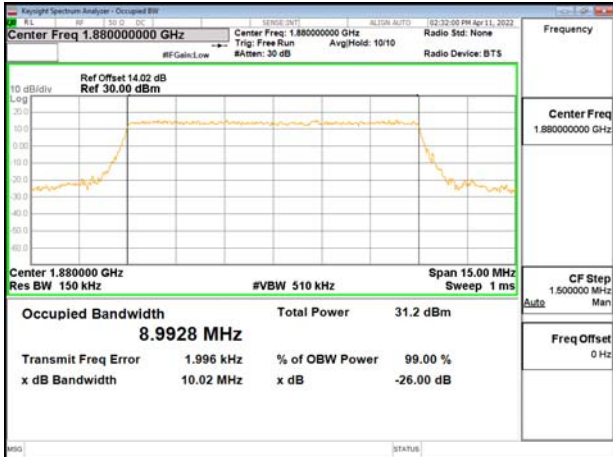

Band2_10MHz_16QAM_RB50_0_CH18900

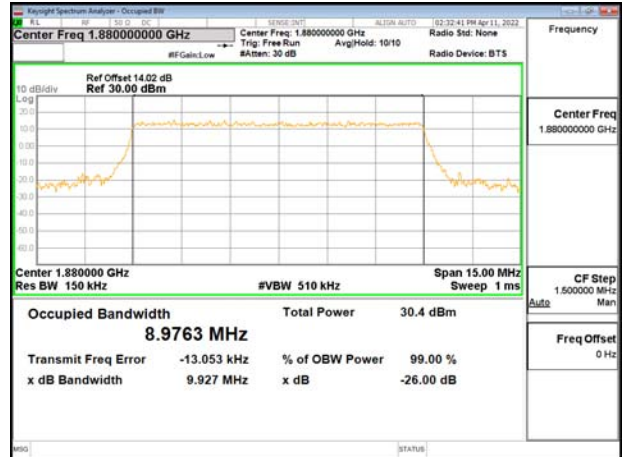

Band2_10MHz_QPSK_RB50_0_CH19150

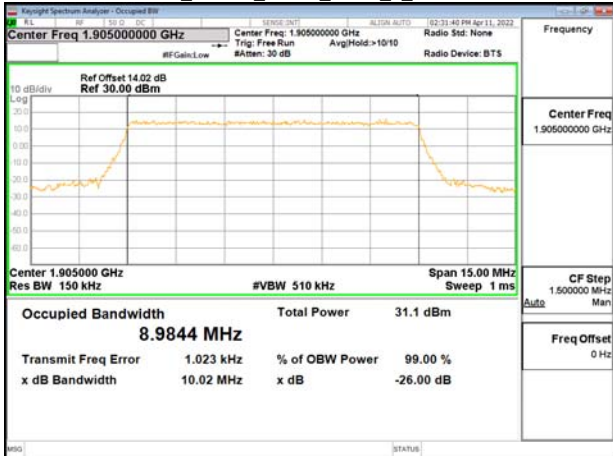

Band2_10MHz_16QAM_RB50_0_CH19150

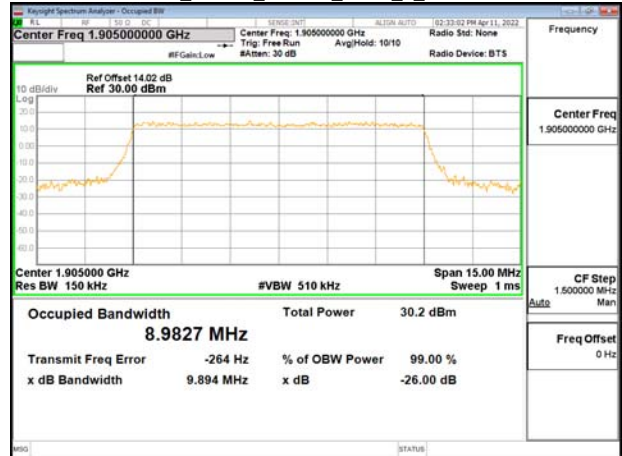

Unless otherwise stated the results shown in this test report refer only to the sample(s) tested and such sample(s) are retained for 90 days only.

除非另有說明，此報告結果僅對測試之樣品負責，同時此樣品僅保留90天。本報告未經本公司書面許可，不可部份複製。

This document is issued by the Company subject to its General Conditions of Service printed overleaf, available on request or accessible at <http://www.sgs.com.tw/Terms-and-Conditions> and for electronic format documents, subject to Terms and Conditions for Electronic Documents at <http://www.sgs.com.tw/Terms-and-Conditions>. Attention is drawn to the limitation of liability, indemnification and jurisdiction issues defined therein. Any holder of this document is advised that information contained herein reflects the Company's findings at the time of its intervention only and within the limits of Client's instructions, if any. The Company's sole responsibility is to its Client and this document does not exonerate parties to a transaction from exercising all their rights and obligations under the transaction documents. This document cannot be reproduced except in full, without prior written approval of the Company. Any unauthorized alteration, forgery or falsification of the content or appearance of this document is unlawful and offenders may be prosecuted to the fullest extent of the law.

Band2_10MHz_64QAM_RB50_0_CH18650

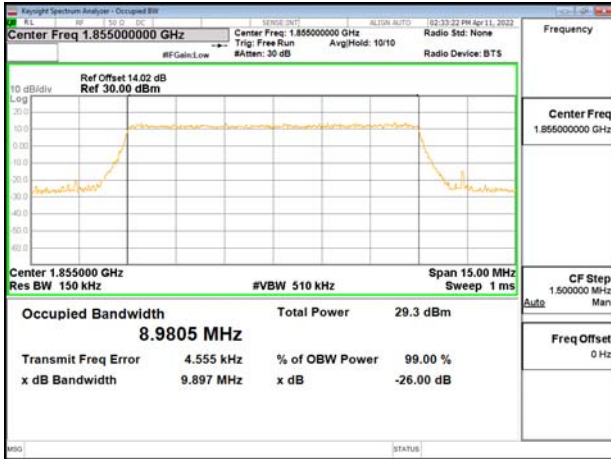

Band2_10MHz_256QAM_RB50_0_CH18650

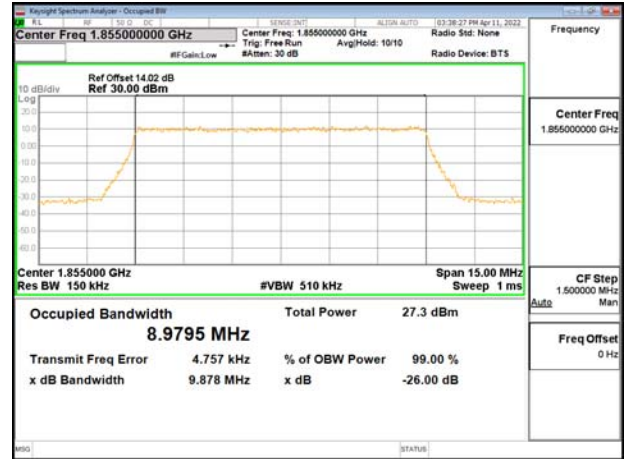

Band2_10MHz_64QAM_RB50_0_CH18900

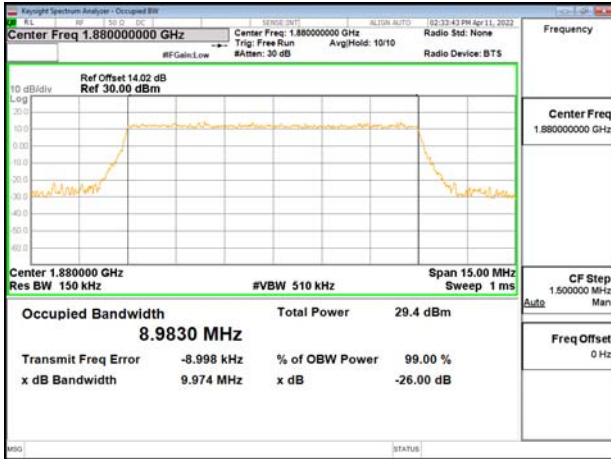

Band2_10MHz_256QAM_RB50_0_CH18900

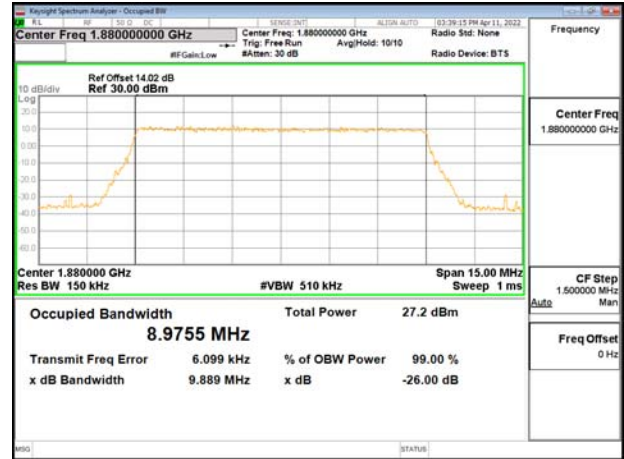

Band2_10MHz_64QAM_RB50_0_CH19150

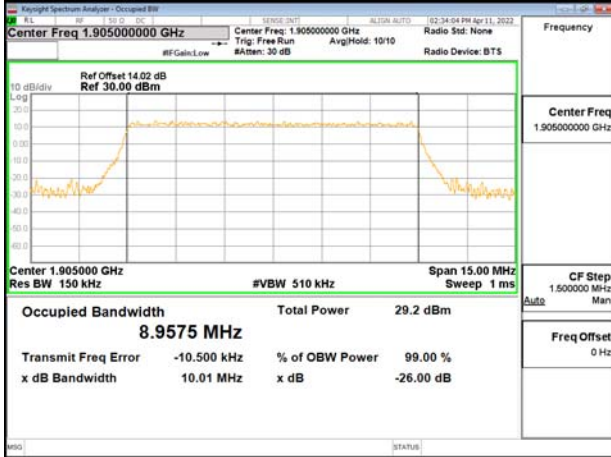

Band2_10MHz_256QAM_RB50_0_CH19150

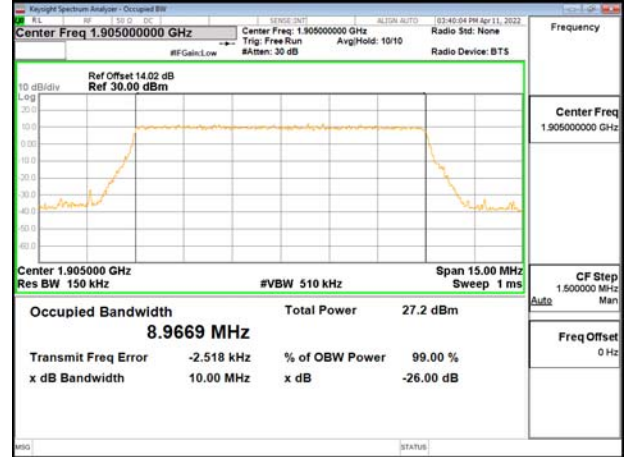

Unless otherwise stated the results shown in this test report refer only to the sample(s) tested and such sample(s) are retained for 90 days only.

除非另有說明，此報告結果僅對測試之樣品負責，同時此樣品僅保留90天。本報告未經本公司書面許可，不可部份複製。

This document is issued by the Company subject to its General Conditions of Service printed overleaf, available on request or accessible at <http://www.sgs.com.tw/Terms-and-Conditions> and for electronic format documents, subject to Terms and Conditions for Electronic Documents at <http://www.sgs.com.tw/Terms-and-Conditions>. Attention is drawn to the limitation of liability, indemnification and jurisdiction issues defined therein. Any holder of this document is advised that information contained herein reflects the Company's findings at the time of its intervention only and within the limits of Client's instructions, if any. The Company's sole responsibility is to its Client and this document does not exonerate parties to a transaction from exercising all their rights and obligations under the transaction documents. This document cannot be reproduced except in full, without prior written approval of the Company. Any unauthorized alteration, forgery or falsification of the content or appearance of this document is unlawful and offenders may be prosecuted to the fullest extent of the law.

Band2_15MHz_QPSK_RB75_0_CH18675

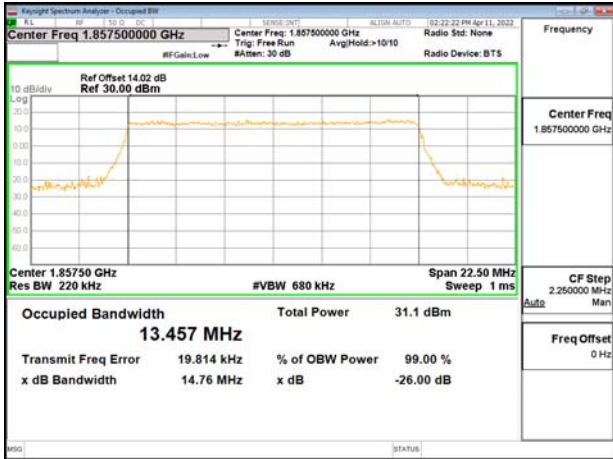

Band2_15MHz_16QAM_RB75_0_CH18675

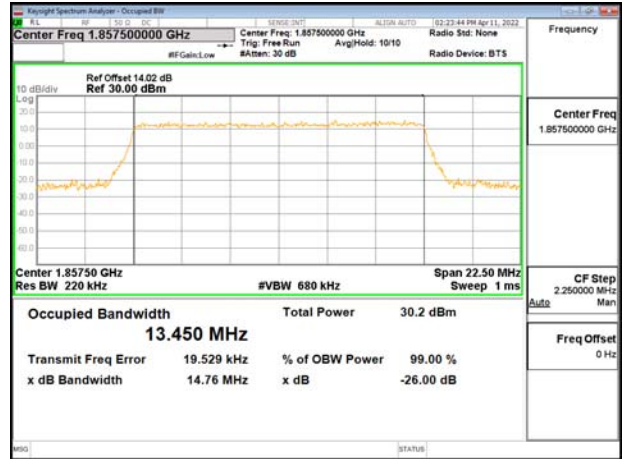

Band2_15MHz_QPSK_RB75_0_CH18900

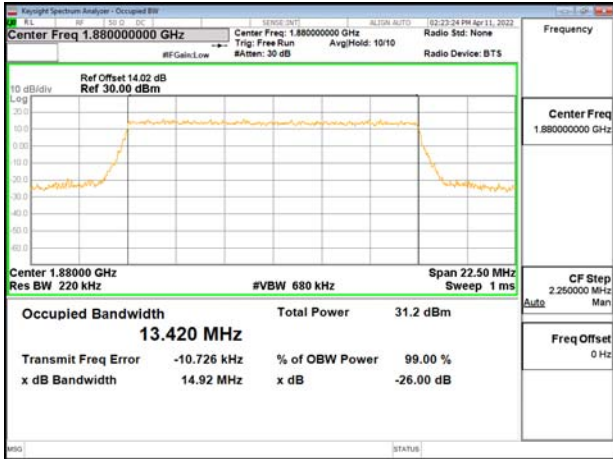

Band2_15MHz_16QAM_RB75_0_CH18900

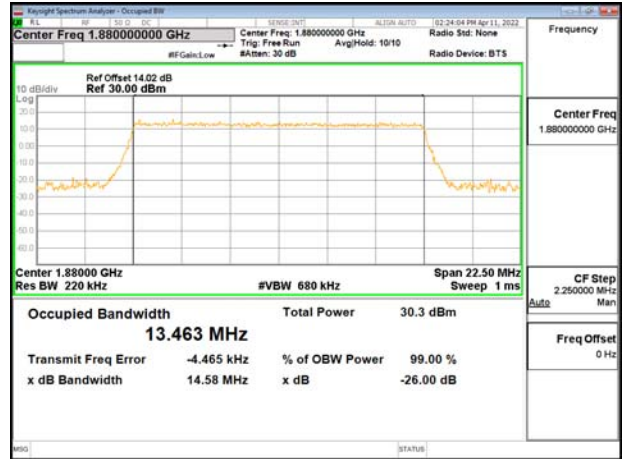

Band2_15MHz_QPSK_RB75_0_CH19125

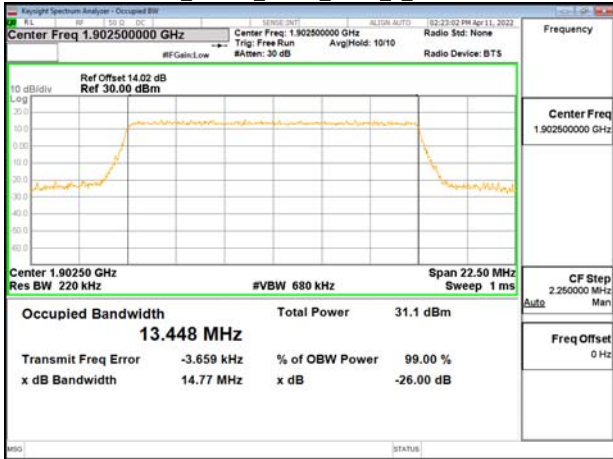

Band2_15MHz_16QAM_RB75_0_CH19125

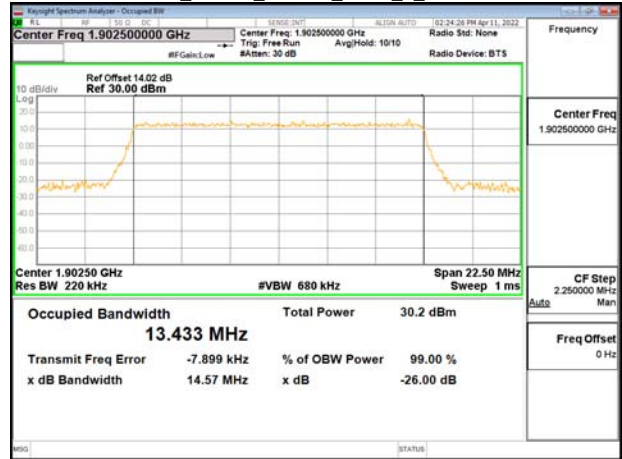

Unless otherwise stated the results shown in this test report refer only to the sample(s) tested and such sample(s) are retained for 90 days only.

除非另有說明，此報告結果僅對測試之樣品負責，同時此樣品僅保留90天。本報告未經本公司書面許可，不可部份複製。

This document is issued by the Company subject to its General Conditions of Service printed overleaf, available on request or accessible at <http://www.sgs.com.tw/Terms-and-Conditions> and for electronic format documents, subject to Terms and Conditions for Electronic Documents at <http://www.sgs.com.tw/Terms-and-Conditions>. Attention is drawn to the limitation of liability, indemnification and jurisdiction issues defined therein. Any holder of this document is advised that information contained herein reflects the Company's findings at the time of its intervention only and within the limits of Client's instructions, if any. The Company's sole responsibility is to its Client and this document does not exonerate parties to a transaction from exercising all their rights and obligations under the transaction documents. This document cannot be reproduced except in full, without prior written approval of the Company. Any unauthorized alteration, forgery or falsification of the content or appearance of this document is unlawful and offenders may be prosecuted to the fullest extent of the law.

Band2_15MHz_64QAM_RB75_0_CH18675

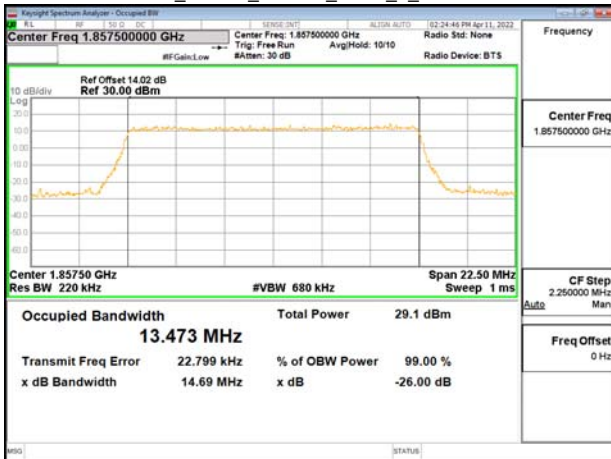

Band2_15MHz_256QAM_RB75_0_CH18675

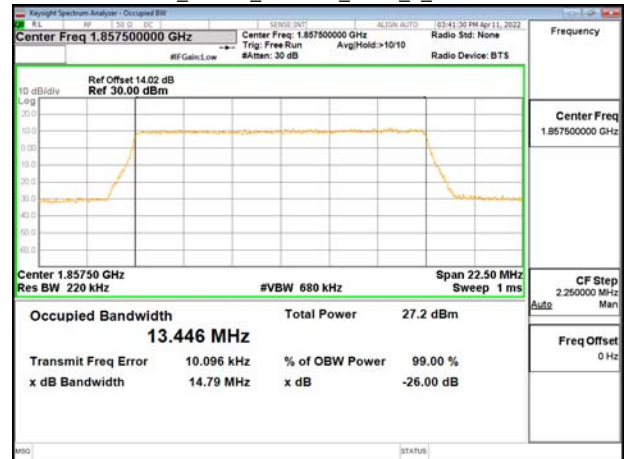

Band2_15MHz_64QAM_RB75_0_CH18900

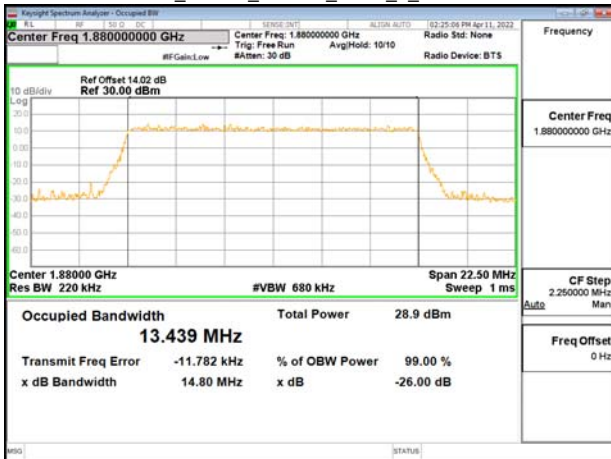

Band2_15MHz_256QAM_RB75_0_CH18900

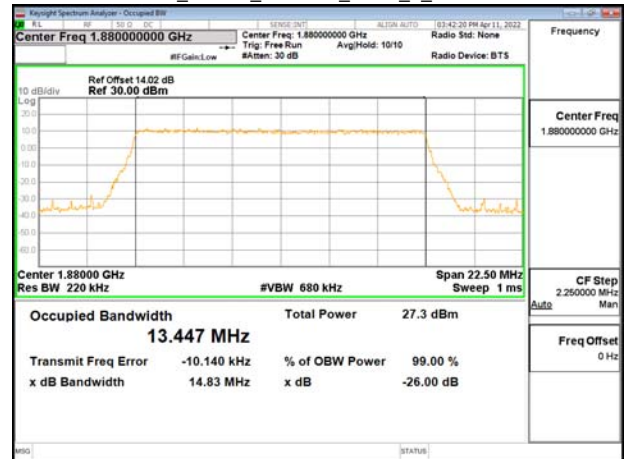

Band2_15MHz_64QAM_RB75_0_CH19125

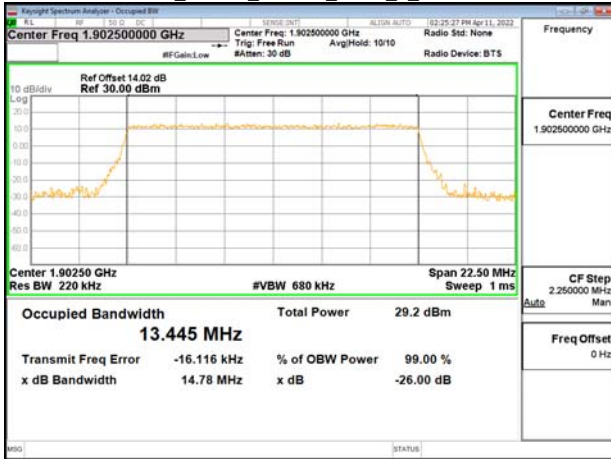

Band2_15MHz_256QAM_RB75_0_CH19125

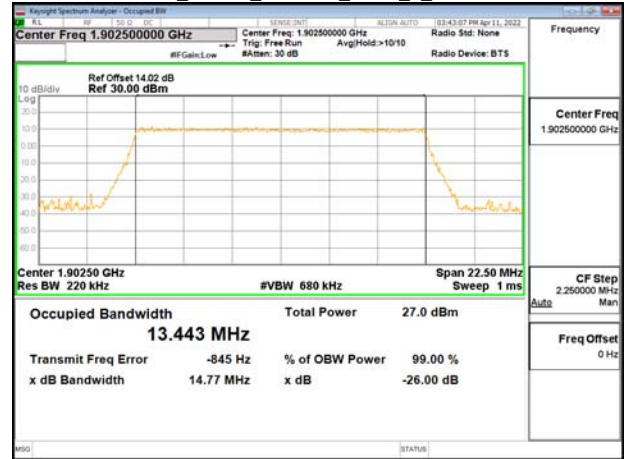

Unless otherwise stated the results shown in this test report refer only to the sample(s) tested and such sample(s) are retained for 90 days only.

除非另有說明，此報告結果僅對測試之樣品負責，同時此樣品僅保留90天。本報告未經本公司書面許可，不可部份複製。

This document is issued by the Company subject to its General Conditions of Service printed overleaf, available on request or accessible at <http://www.sgs.com.tw/Terms-and-Conditions> and for electronic format documents, subject to Terms and Conditions for Electronic Documents at <http://www.sgs.com.tw/Terms-and-Conditions>. Attention is drawn to the limitation of liability, indemnification and jurisdiction issues defined therein. Any holder of this document is advised that information contained herein reflects the Company's findings at the time of its intervention only and within the limits of Client's instructions, if any. The Company's sole responsibility is to its Client and this document does not exonerate parties to a transaction from exercising all their rights and obligations under the transaction documents. This document cannot be reproduced except in full, without prior written approval of the Company. Any unauthorized alteration, forgery or falsification of the content or appearance of this document is unlawful and offenders may be prosecuted to the fullest extent of the law.

Band2_20MHz_QPSK_RB100_0_CH18700

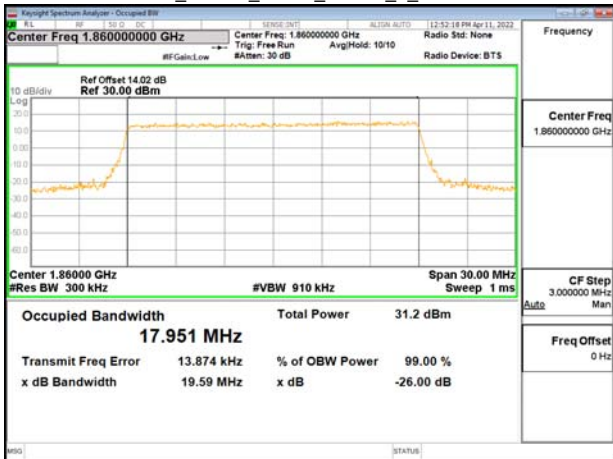

Band2_20MHz_16QAM_RB100_0_CH18700

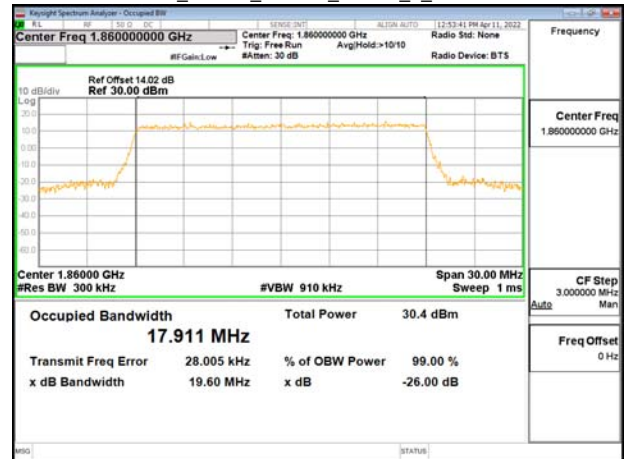

Band2_20MHz_QPSK_RB100_0_CH18900

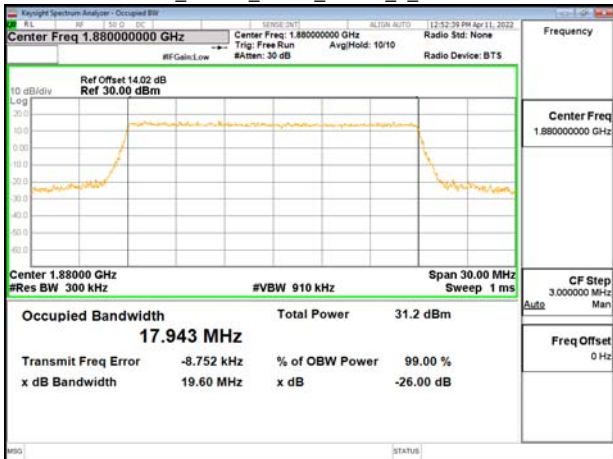

Band2_20MHz_16QAM_RB100_0_CH18900

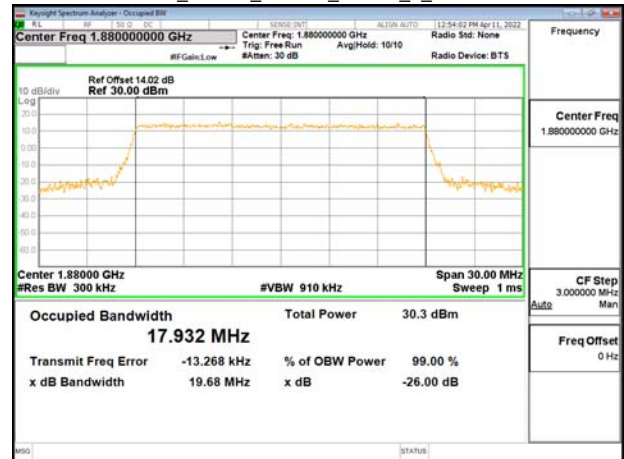

Band2_20MHz_QPSK_RB100_0_CH19100

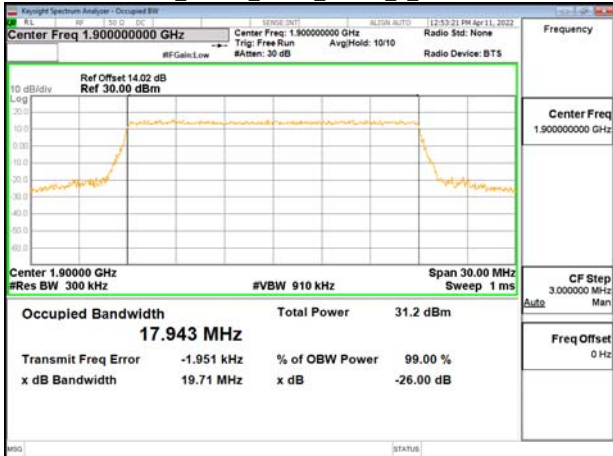

Band2_20MHz_16QAM_RB100_0_CH19100

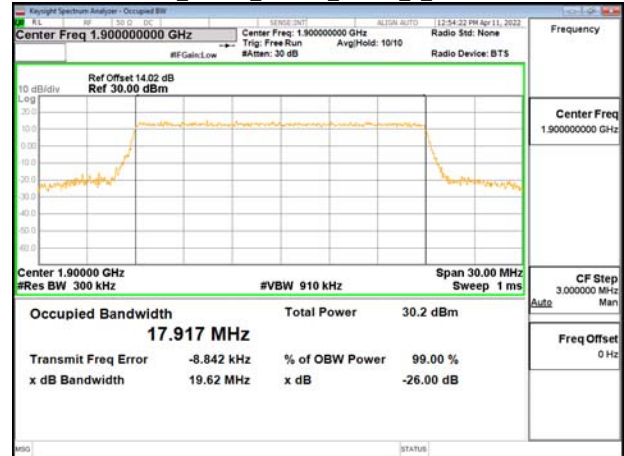

Unless otherwise stated the results shown in this test report refer only to the sample(s) tested and such sample(s) are retained for 90 days only.

除非另有說明，此報告結果僅對測試之樣品負責，同時此樣品僅保留90天。本報告未經本公司書面許可，不可部份複製。

This document is issued by the Company subject to its General Conditions of Service printed overleaf, available on request or accessible at <http://www.sgs.com.tw/Terms-and-Conditions> and for electronic format documents, subject to Terms and Conditions for Electronic Documents at <http://www.sgs.com.tw/Terms-and-Conditions>. Attention is drawn to the limitation of liability, indemnification and jurisdiction issues defined therein. Any holder of this document is advised that information contained herein reflects the Company's findings at the time of its intervention only and within the limits of Client's instructions, if any. The Company's sole responsibility is to its Client and this document does not exonerate parties to a transaction from exercising all their rights and obligations under the transaction documents. This document cannot be reproduced except in full, without prior written approval of the Company. Any unauthorized alteration, forgery or falsification of the content or appearance of this document is unlawful and offenders may be prosecuted to the fullest extent of the law.

Band2_20MHz_64QAM_RB100_0_CH18700

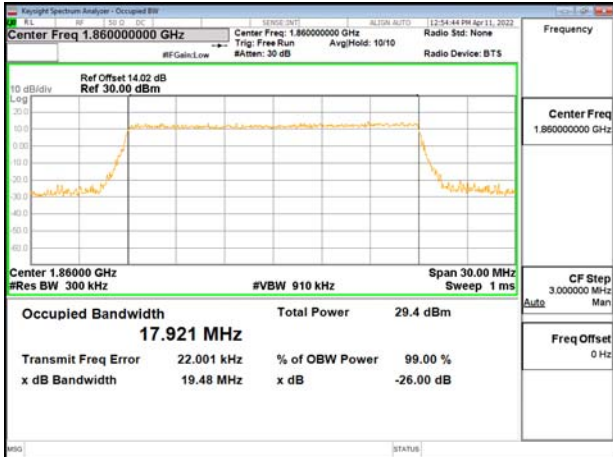

Band2_20MHz_256QAM_RB100_0_CH18700

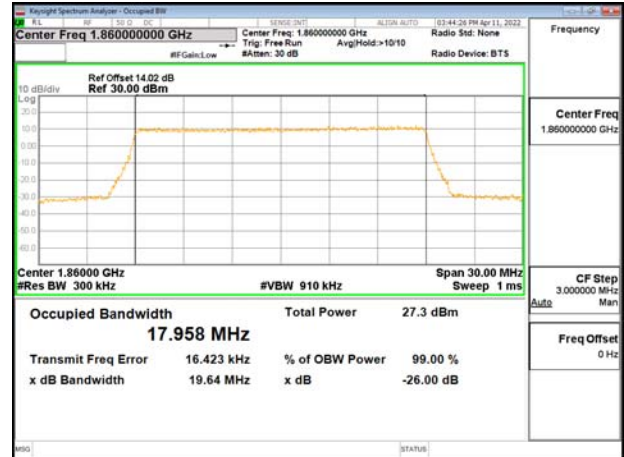

Band2_20MHz_64QAM_RB100_0_CH18900

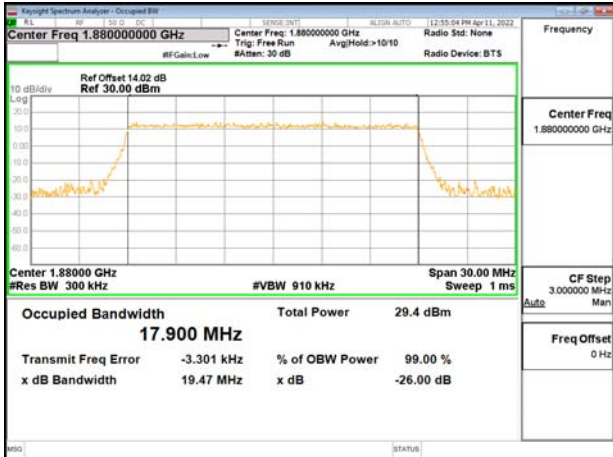

Band2_20MHz_256QAM_RB100_0_CH18900

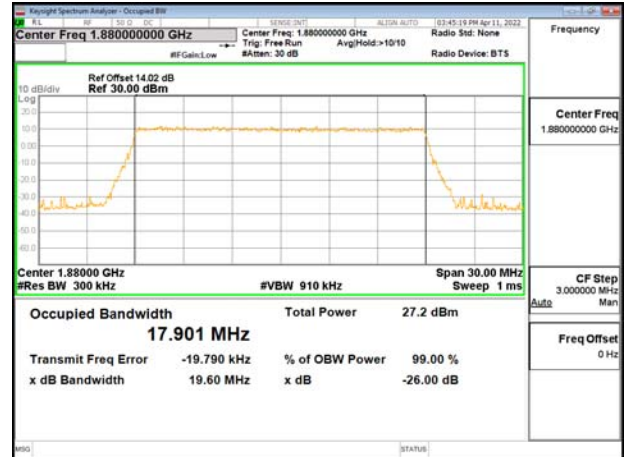

Band2_20MHz_64QAM_RB100_0_CH19100

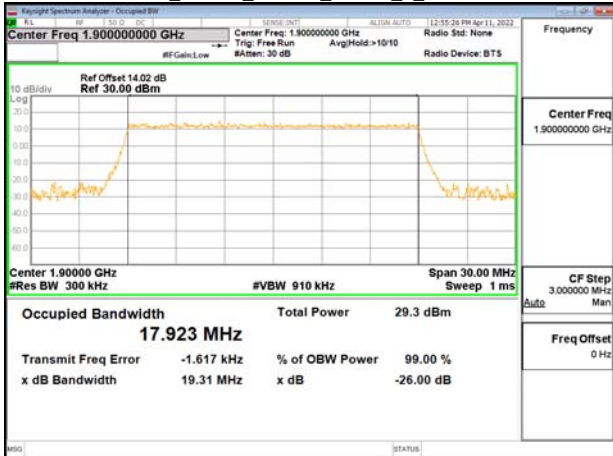

Band2_20MHz_256QAM_RB100_0_CH19100

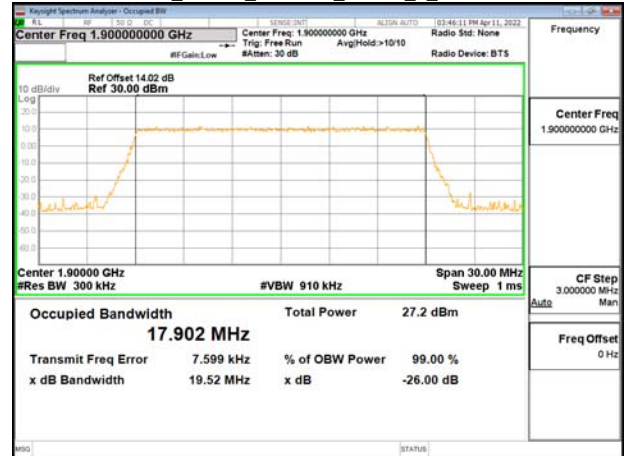

Unless otherwise stated the results shown in this test report refer only to the sample(s) tested and such sample(s) are retained for 90 days only.

除非另有說明，此報告結果僅對測試之樣品負責，同時此樣品僅保留90天。本報告未經本公司書面許可，不可部份複製。

This document is issued by the Company subject to its General Conditions of Service printed overleaf, available on request or accessible at <http://www.sgs.com.tw/Terms-and-Conditions> and for electronic format documents, subject to Terms and Conditions for Electronic Documents at <http://www.sgs.com.tw/Terms-and-Conditions>. Attention is drawn to the limitation of liability, indemnification and jurisdiction issues defined therein. Any holder of this document is advised that information contained herein reflects the Company's findings at the time of its intervention only and within the limits of Client's instructions, if any. The Company's sole responsibility is to its Client and this document does not exonerate parties to a transaction from exercising all their rights and obligations under the transaction documents. This document cannot be reproduced except in full, without prior written approval of the Company. Any unauthorized alteration, forgery or falsification of the content or appearance of this document is unlawful and offenders may be prosecuted to the fullest extent of the law.

Band5_1.4MHz_QPSK_RB6_0_CH20407

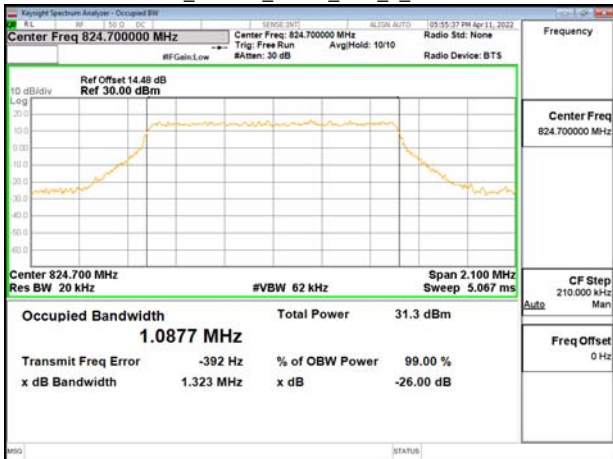

Band5_1.4MHz_16QAM_RB6_0_CH20407

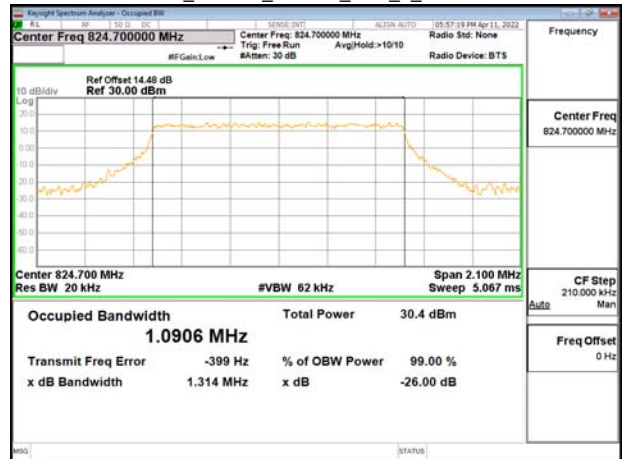

Band5_1.4MHz_QPSK_RB6_0_CH20525

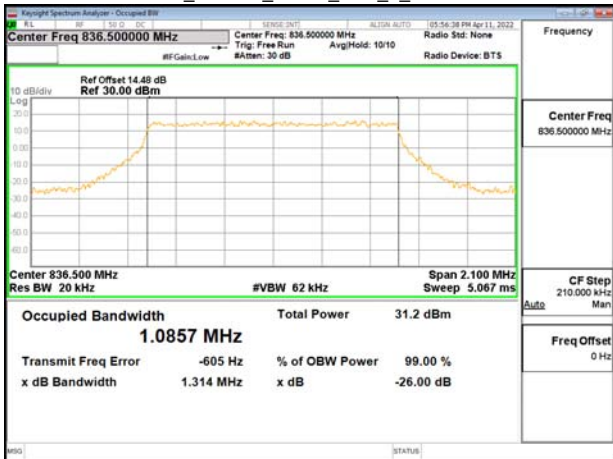

Band5_1.4MHz_16QAM_RB6_0_CH20525

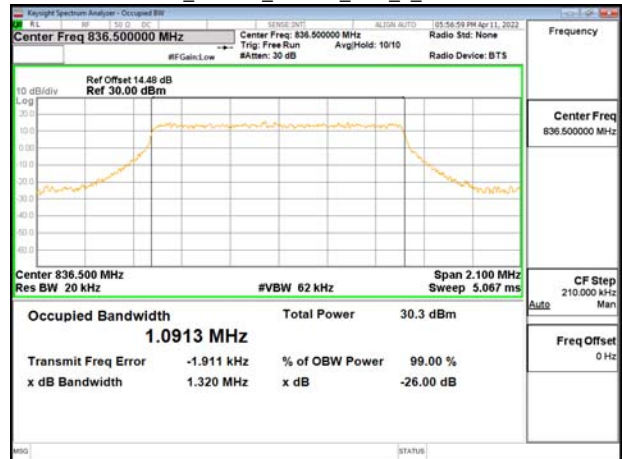

Band5_1.4MHz_QPSK_RB6_0_CH20643



Band5_1.4MHz_16QAM_RB6_0_CH20643



Unless otherwise stated the results shown in this test report refer only to the sample(s) tested and such sample(s) are retained for 90 days only.

除非另有說明，此報告結果僅對測試之樣品負責，同時此樣品僅保留90天。本報告未經本公司書面許可，不可部份複製。

This document is issued by the Company subject to its General Conditions of Service printed overleaf, available on request or accessible at <http://www.sgs.com.tw/Terms-and-Conditions> and for electronic format documents, subject to Terms and Conditions for Electronic Documents at <http://www.sgs.com.tw/Terms-and-Conditions>. Attention is drawn to the limitation of liability, indemnification and jurisdiction issues defined therein. Any holder of this document is advised that information contained herein reflects the Company's findings at the time of its intervention only and within the limits of Client's instructions, if any. The Company's sole responsibility is to its Client and this document does not exonerate parties to a transaction from exercising all their rights and obligations under the transaction documents. This document cannot be reproduced except in full, without prior written approval of the Company. Any unauthorized alteration, forgery or falsification of the content or appearance of this document is unlawful and offenders may be prosecuted to the fullest extent of the law.

Band5_1.4MHz_64QAM_RB6_0_CH20407

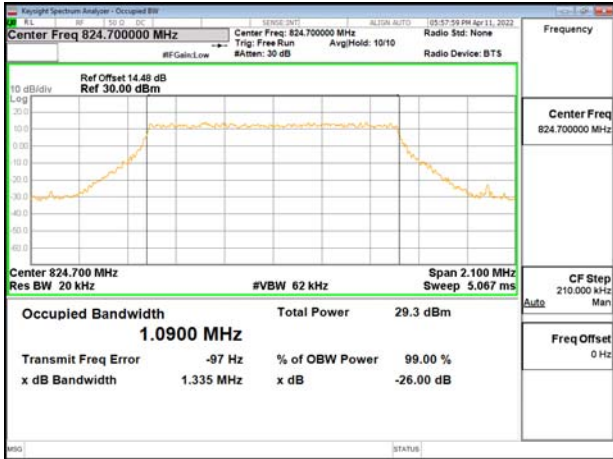

Band5_1.4MHz_256QAM_RB6_0_CH20407

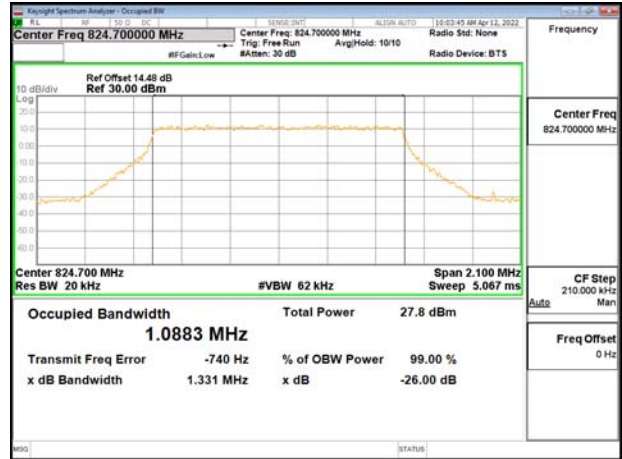

Band5_1.4MHz_64QAM_RB6_0_CH20525

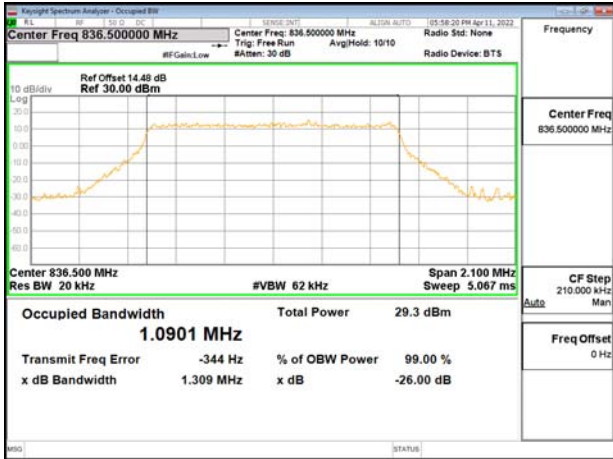

Band5_1.4MHz_256QAM_RB6_0_CH20525

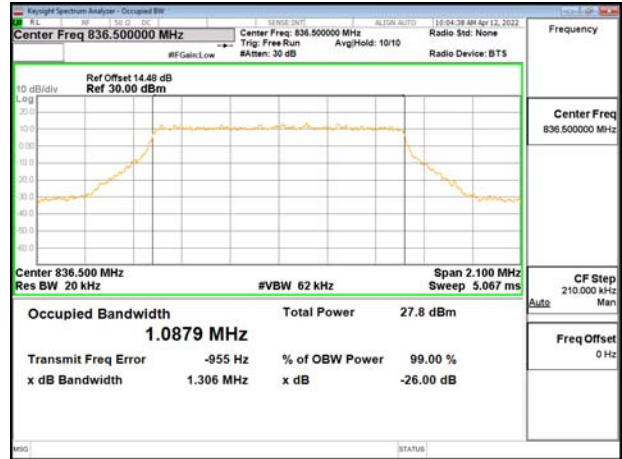

Band5_1.4MHz_64QAM_RB6_0_CH20643

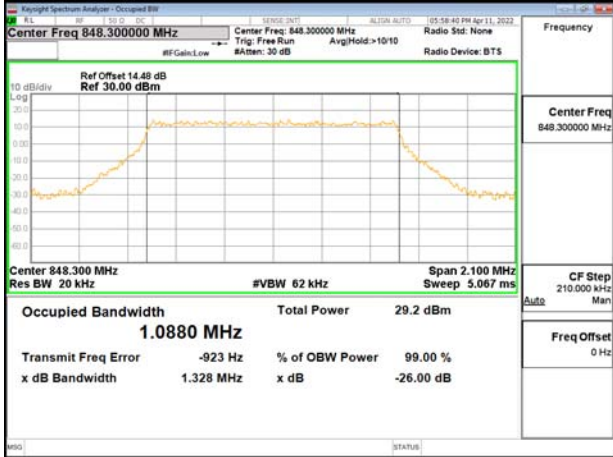

Band5_1.4MHz_256QAM_RB6_0_CH20643



Unless otherwise stated the results shown in this test report refer only to the sample(s) tested and such sample(s) are retained for 90 days only.

除非另有說明，此報告結果僅對測試之樣品負責，同時此樣品僅保留90天。本報告未經本公司書面許可，不可部份複製。

This document is issued by the Company subject to its General Conditions of Service printed overleaf, available on request or accessible at <http://www.sgs.com.tw/Terms-and-Conditions> and for electronic format documents, subject to Terms and Conditions for Electronic Documents at <http://www.sgs.com.tw/Terms-and-Conditions>. Attention is drawn to the limitation of liability, indemnification and jurisdiction issues defined therein. Any holder of this document is advised that information contained herein reflects the Company's findings at the time of its intervention only and within the limits of Client's instructions, if any. The Company's sole responsibility is to its Client and this document does not exonerate parties to a transaction from exercising all their rights and obligations under the transaction documents. This document cannot be reproduced except in full, without prior written approval of the Company. Any unauthorized alteration, forgery or falsification of the content or appearance of this document is unlawful and offenders may be prosecuted to the fullest extent of the law.

Band5_3MHz_QPSK_RB15_0_CH20415

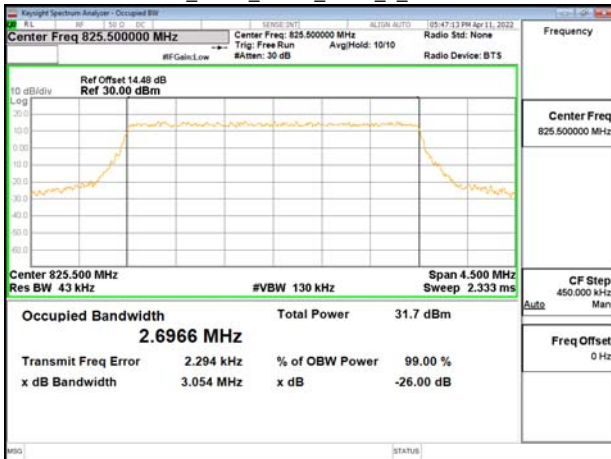

Band5_3MHz_16QAM_RB15_0_CH20415

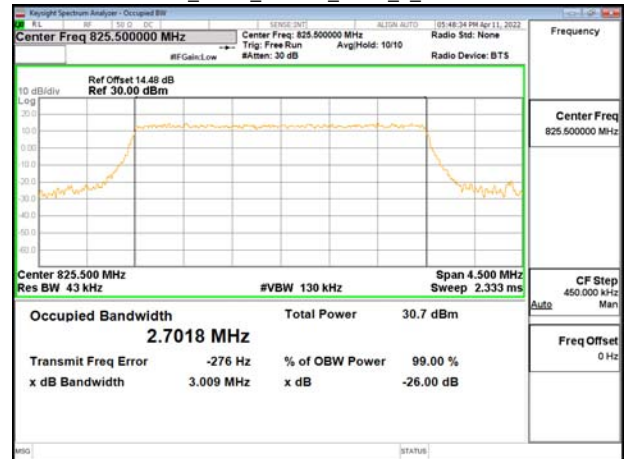

Band5_3MHz_QPSK_RB15_0_CH20525

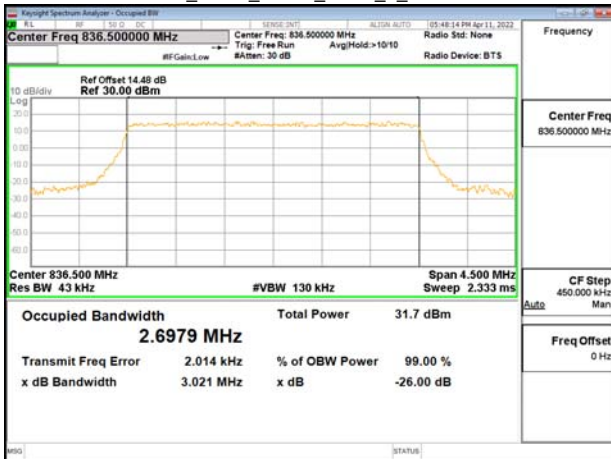

Band5_3MHz_16QAM_RB15_0_CH20525

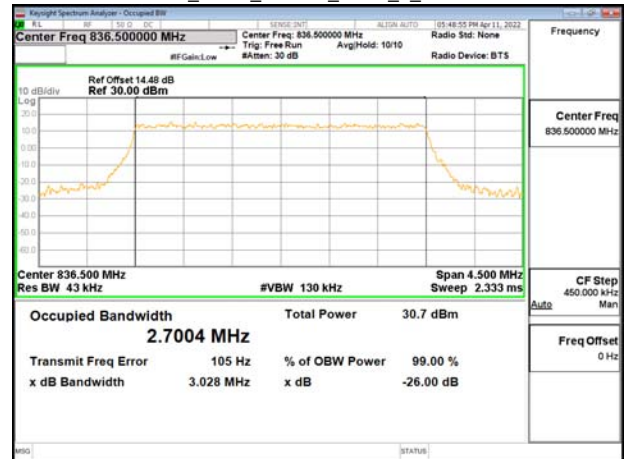

Band5_3MHz_QPSK_RB15_0_CH20635

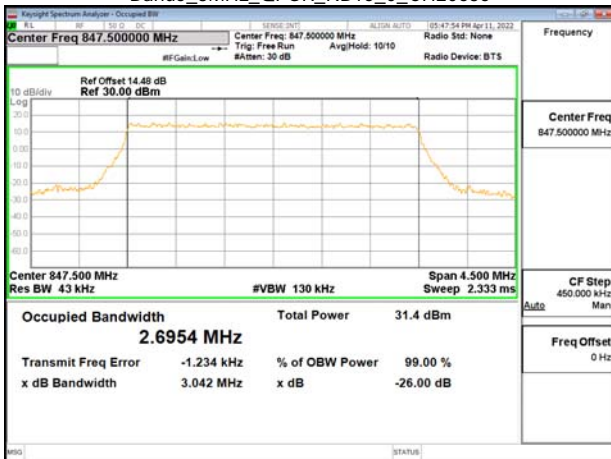

Band5_3MHz_16QAM_RB15_0_CH20635

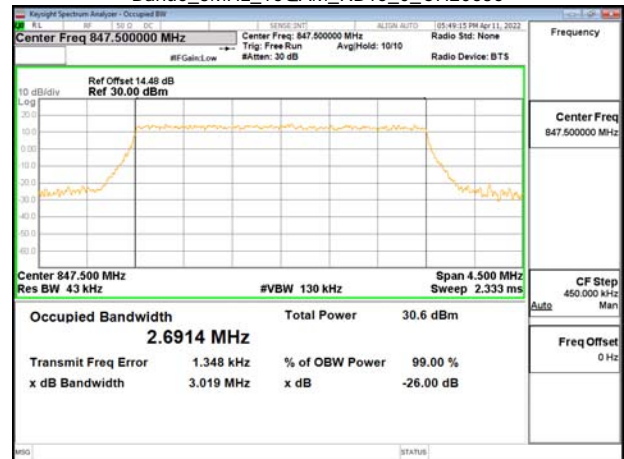

Unless otherwise stated the results shown in this test report refer only to the sample(s) tested and such sample(s) are retained for 90 days only.

除非另有說明，此報告結果僅對測試之樣品負責，同時此樣品僅保留90天。本報告未經本公司書面許可，不可部份複製。

This document is issued by the Company subject to its General Conditions of Service printed overleaf, available on request or accessible at <http://www.sgs.com.tw/Terms-and-Conditions> and for electronic format documents, subject to Terms and Conditions for Electronic Documents at <http://www.sgs.com.tw/Terms-and-Conditions>. Attention is drawn to the limitation of liability, indemnification and jurisdiction issues defined therein. Any holder of this document is advised that information contained herein reflects the Company's findings at the time of its intervention only and within the limits of Client's instructions, if any. The Company's sole responsibility is to its Client and this document does not exonerate parties to a transaction from exercising all their rights and obligations under the transaction documents. This document cannot be reproduced except in full, without prior written approval of the Company. Any unauthorized alteration, forgery or falsification of the content or appearance of this document is unlawful and offenders may be prosecuted to the fullest extent of the law.

Band5_3MHz_64QAM_RB15_0_CH20415

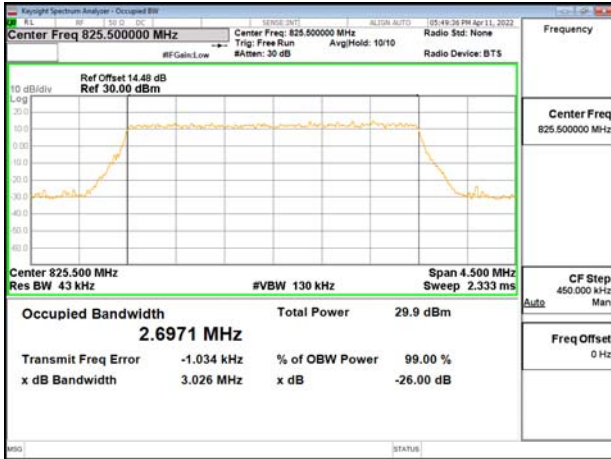

Band5_3MHz_256QAM_RB15_0_CH20415

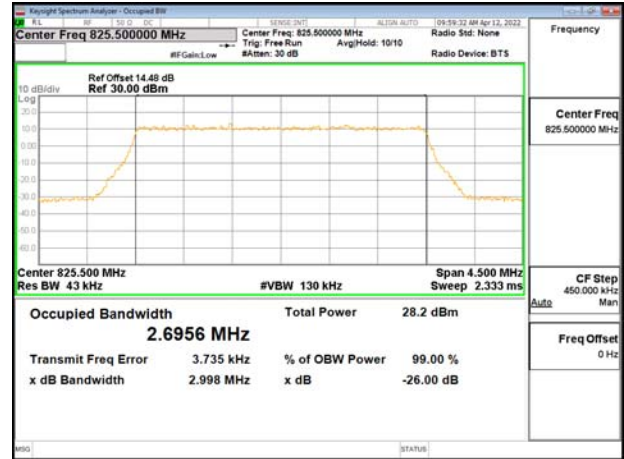

Band5_3MHz_64QAM_RB15_0_CH20525

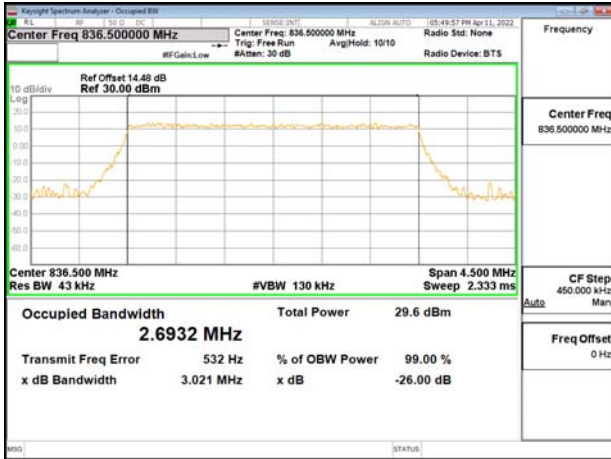

Band5_3MHz_256QAM_RB15_0_CH20525

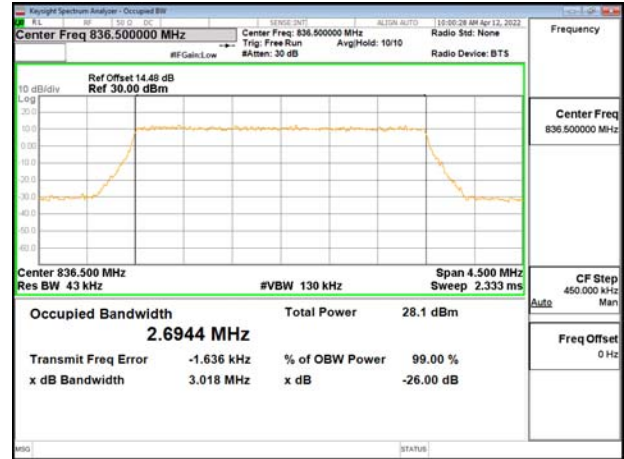

Band5_3MHz_64QAM_RB15_0_CH20635

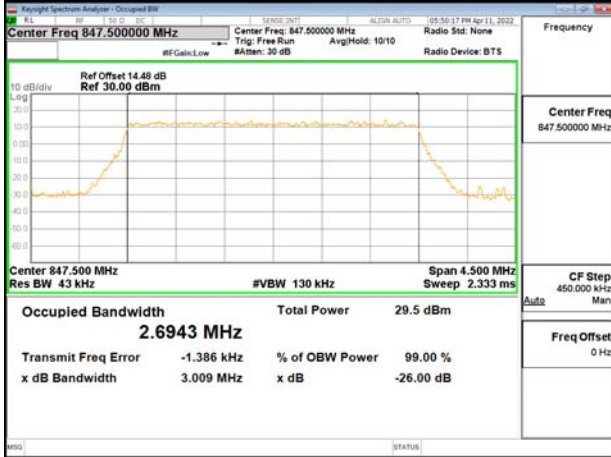

Band5_3MHz_256QAM_RB15_0_CH20635

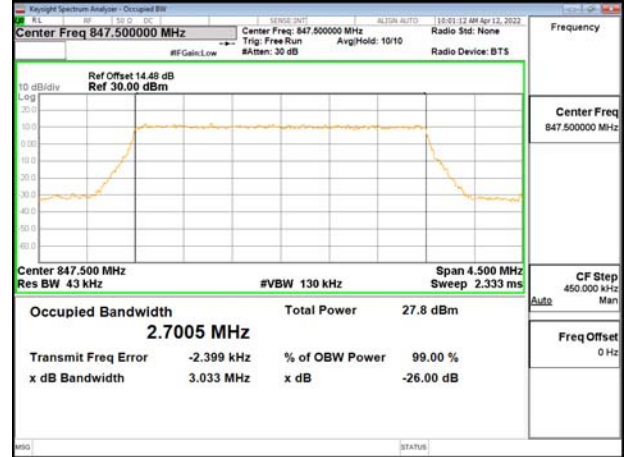

Unless otherwise stated the results shown in this test report refer only to the sample(s) tested and such sample(s) are retained for 90 days only.

除非另有說明，此報告結果僅對測試之樣品負責，同時此樣品僅保留90天。本報告未經本公司書面許可，不可部份複製。

This document is issued by the Company subject to its General Conditions of Service printed overleaf, available on request or accessible at <http://www.sgs.com.tw/Terms-and-Conditions> and for electronic format documents, subject to Terms and Conditions for Electronic Documents at <http://www.sgs.com.tw/Terms-and-Conditions>. Attention is drawn to the limitation of liability, indemnification and jurisdiction issues defined therein. Any holder of this document is advised that information contained herein reflects the Company's findings at the time of its intervention only and within the limits of Client's instructions, if any. The Company's sole responsibility is to its Client and this document does not exonerate parties to a transaction from exercising all their rights and obligations under the transaction documents. This document cannot be reproduced except in full, without prior written approval of the Company. Any unauthorized alteration, forgery or falsification of the content or appearance of this document is unlawful and offenders may be prosecuted to the fullest extent of the law.

Band5_5MHz_QPSK_RB25_0_CH20425

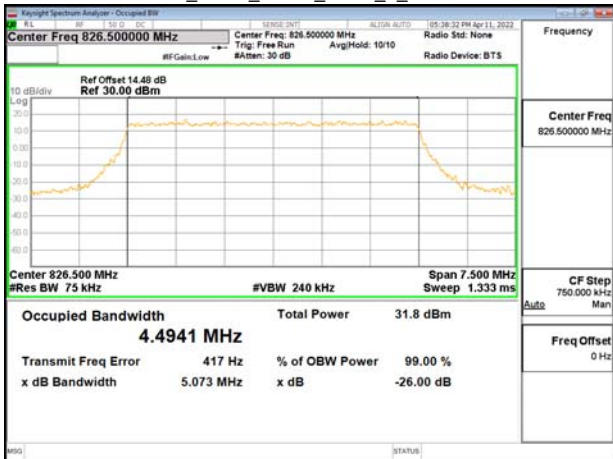

Band5_5MHz_16QAM_RB25_0_CH20425

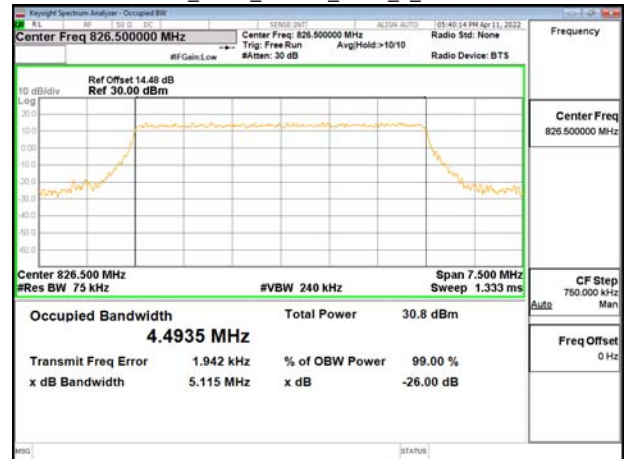

Band5_5MHz_QPSK_RB25_0_CH20525

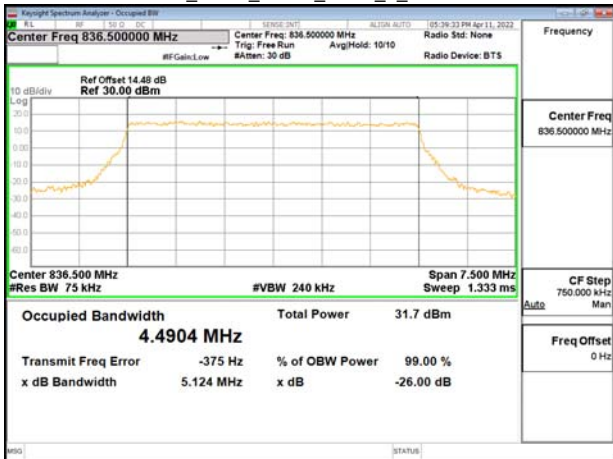

Band5_5MHz_16QAM_RB25_0_CH20525

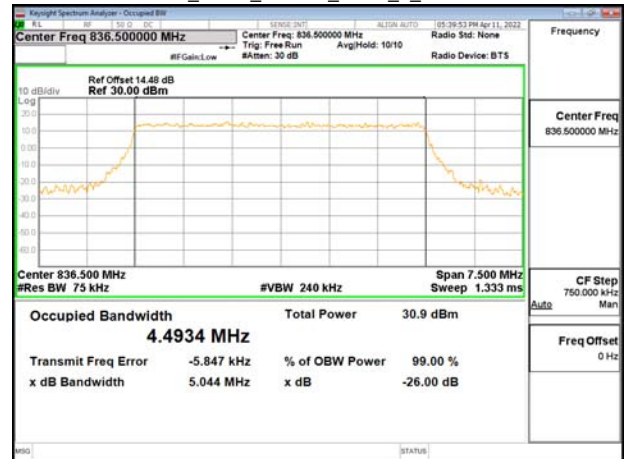

Band5_5MHz_QPSK_RB25_0_CH20625

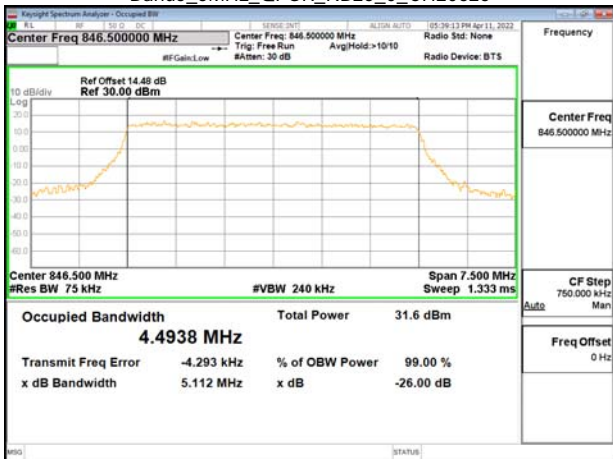

Band5_5MHz_16QAM_RB25_0_CH20625



Unless otherwise stated the results shown in this test report refer only to the sample(s) tested and such sample(s) are retained for 90 days only.

除非另有說明，此報告結果僅對測試之樣品負責，同時此樣品僅保留90天。本報告未經本公司書面許可，不可部份複製。

This document is issued by the Company subject to its General Conditions of Service printed overleaf, available on request or accessible at <http://www.sgs.com.tw/Terms-and-Conditions> and for electronic format documents, subject to Terms and Conditions for Electronic Documents at <http://www.sgs.com.tw/Terms-and-Conditions>. Attention is drawn to the limitation of liability, indemnification and jurisdiction issues defined therein. Any holder of this document is advised that information contained herein reflects the Company's findings at the time of its intervention only and within the limits of Client's instructions, if any. The Company's sole responsibility is to its Client and this document does not exonerate parties to a transaction from exercising all their rights and obligations under the transaction documents. This document cannot be reproduced except in full, without prior written approval of the Company. Any unauthorized alteration, forgery or falsification of the content or appearance of this document is unlawful and offenders may be prosecuted to the fullest extent of the law.

Band5_5MHz_64QAM_RB25_0_CH20425

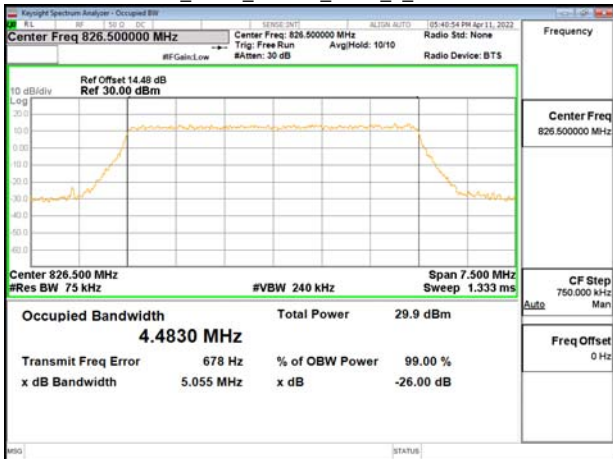

Band5_5MHz_256QAM_RB25_0_CH20425

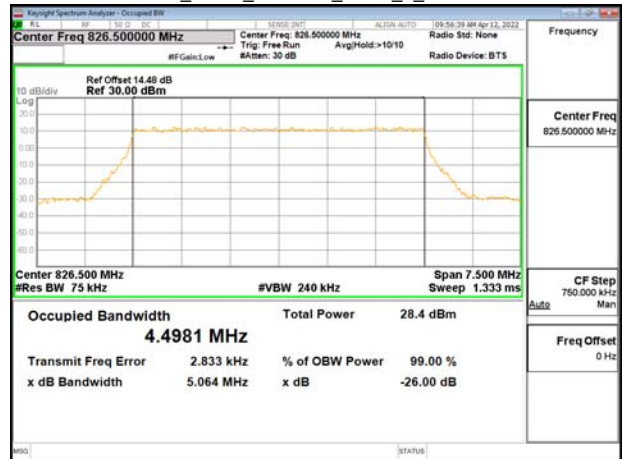

Band5_5MHz_64QAM_RB25_0_CH20525

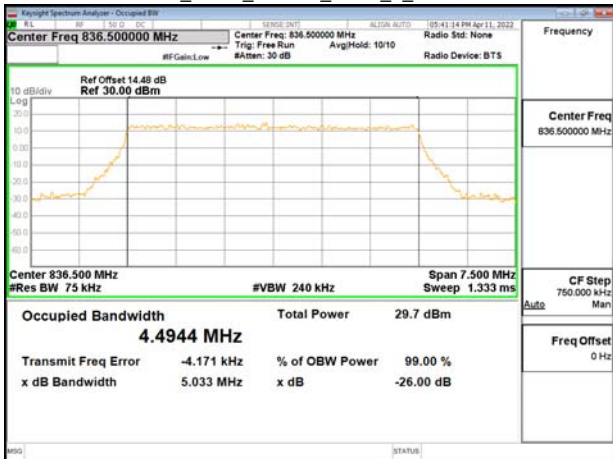

Band5_5MHz_256QAM_RB25_0_CH20525

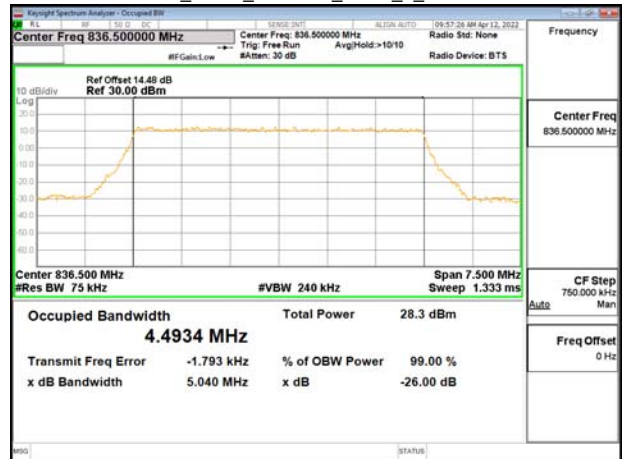

Band5_5MHz_64QAM_RB25_0_CH20625

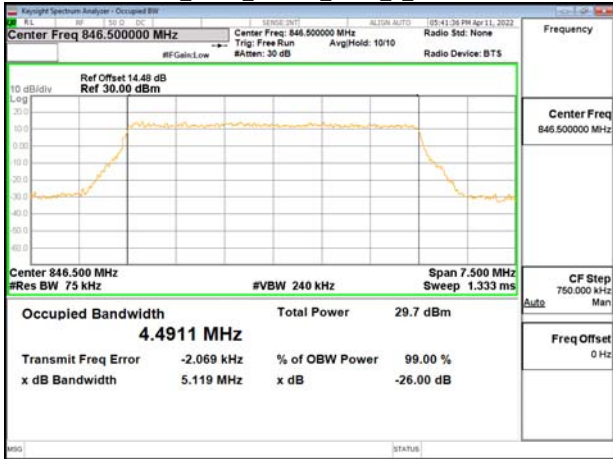

Band5_5MHz_256QAM_RB25_0_CH20625

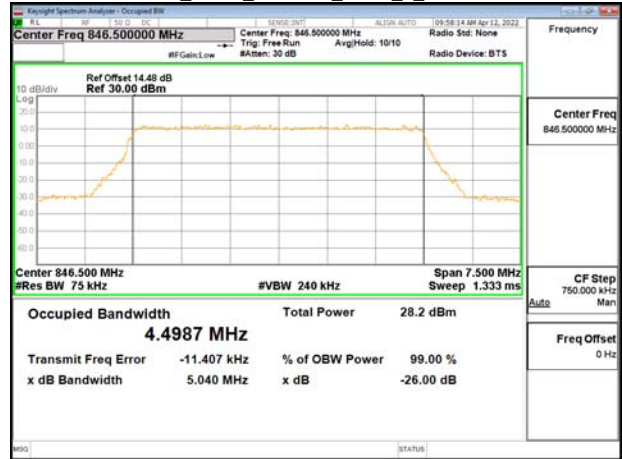

Unless otherwise stated the results shown in this test report refer only to the sample(s) tested and such sample(s) are retained for 90 days only.

除非另有說明，此報告結果僅對測試之樣品負責，同時此樣品僅保留90天。本報告未經本公司書面許可，不可部份複製。

This document is issued by the Company subject to its General Conditions of Service printed overleaf, available on request or accessible at <http://www.sgs.com.tw/Terms-and-Conditions> and for electronic format documents, subject to Terms and Conditions for Electronic Documents at <http://www.sgs.com.tw/Terms-and-Conditions>. Attention is drawn to the limitation of liability, indemnification and jurisdiction issues defined therein. Any holder of this document is advised that information contained herein reflects the Company's findings at the time of its intervention only and within the limits of Client's instructions, if any. The Company's sole responsibility is to its Client and this document does not exonerate parties to a transaction from exercising all their rights and obligations under the transaction documents. This document cannot be reproduced except in full, without prior written approval of the Company. Any unauthorized alteration, forgery or falsification of the content or appearance of this document is unlawful and offenders may be prosecuted to the fullest extent of the law.

Band5_10MHz_QPSK_RB50_0_CH20450

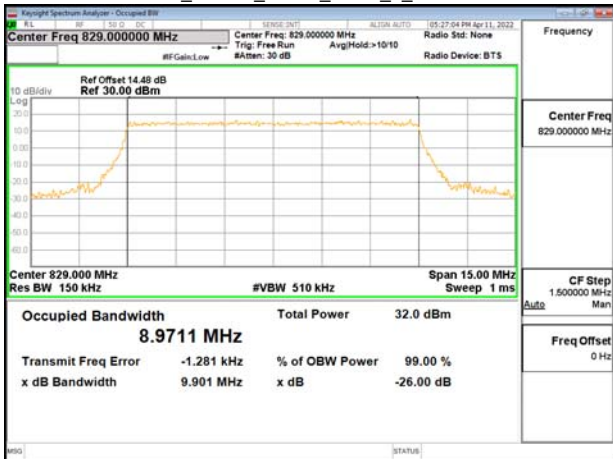

Band5_10MHz_16QAM_RB50_0_CH20450

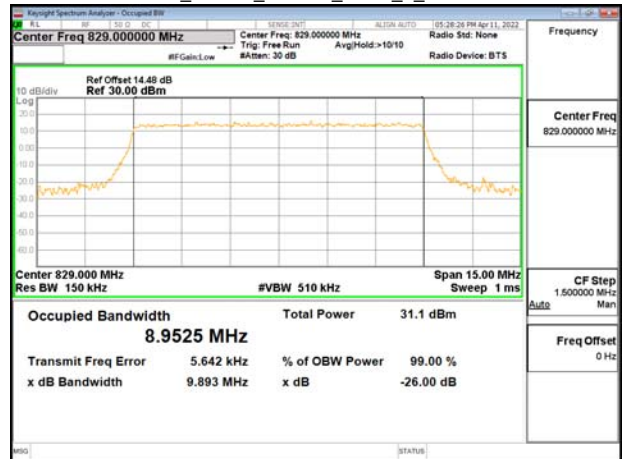

Band5_10MHz_QPSK_RB50_0_CH20525

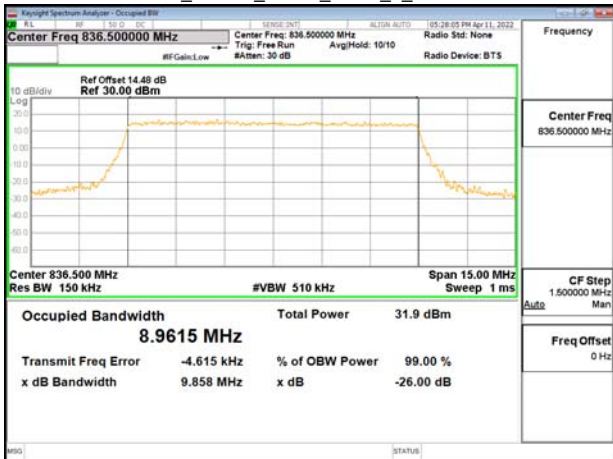

Band5_10MHz_16QAM_RB50_0_CH20525

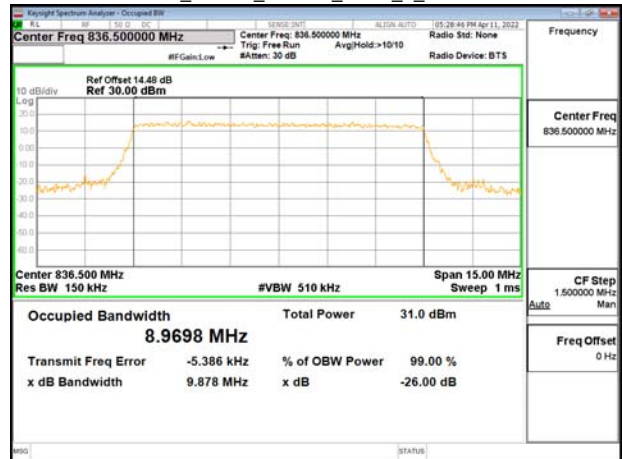

Band5_10MHz_QPSK_RB50_0_CH20600

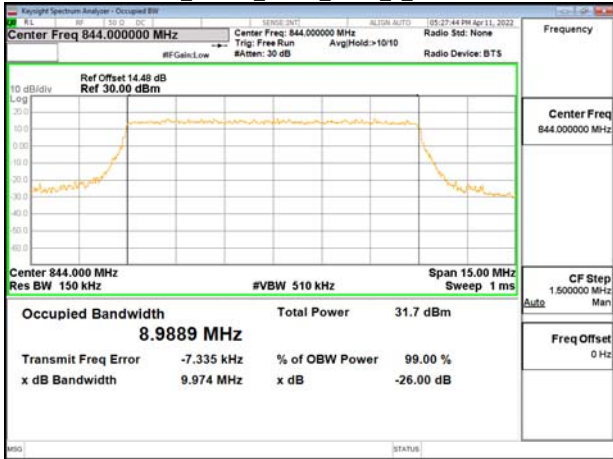

Band5_10MHz_16QAM_RB50_0_CH20600

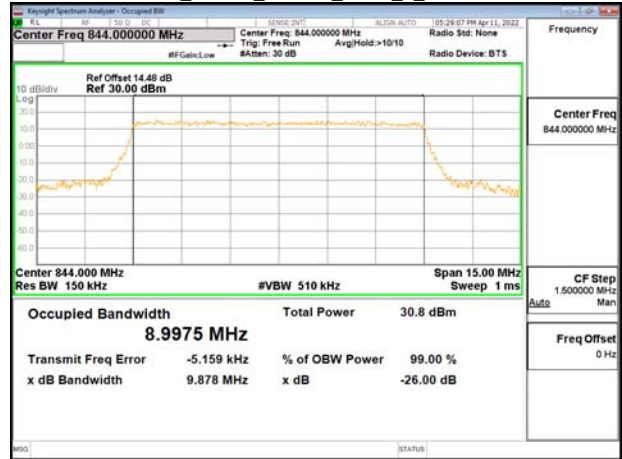

Unless otherwise stated the results shown in this test report refer only to the sample(s) tested and such sample(s) are retained for 90 days only.

除非另有說明，此報告結果僅對測試之樣品負責，同時此樣品僅保留90天。本報告未經本公司書面許可，不可部份複製。

This document is issued by the Company subject to its General Conditions of Service printed overleaf, available on request or accessible at <http://www.sgs.com.tw/Terms-and-Conditions> and for electronic format documents, subject to Terms and Conditions for Electronic Documents at <http://www.sgs.com.tw/Terms-and-Conditions>. Attention is drawn to the limitation of liability, indemnification and jurisdiction issues defined therein. Any holder of this document is advised that information contained herein reflects the Company's findings at the time of its intervention only and within the limits of Client's instructions, if any. The Company's sole responsibility is to its Client and this document does not exonerate parties to a transaction from exercising all their rights and obligations under the transaction documents. This document cannot be reproduced except in full, without prior written approval of the Company. Any unauthorized alteration, forgery or falsification of the content or appearance of this document is unlawful and offenders may be prosecuted to the fullest extent of the law.

Band5_10MHz_64QAM_RB50_0_CH20450

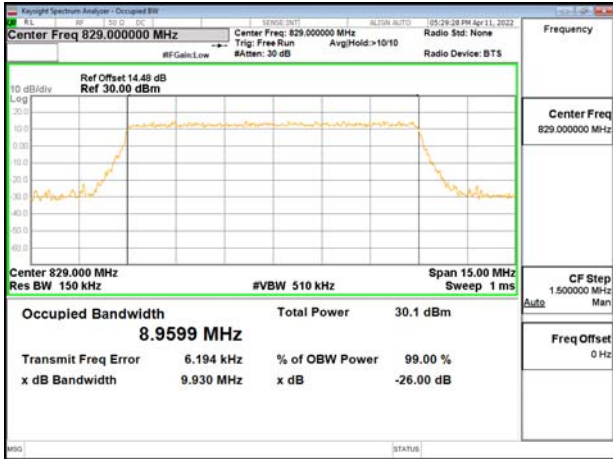

Band5_10MHz_256QAM_RB50_0_CH20450

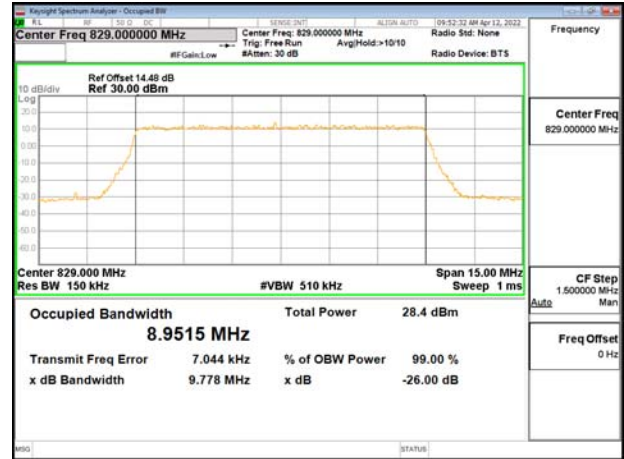

Band5_10MHz_64QAM_RB50_0_CH20525

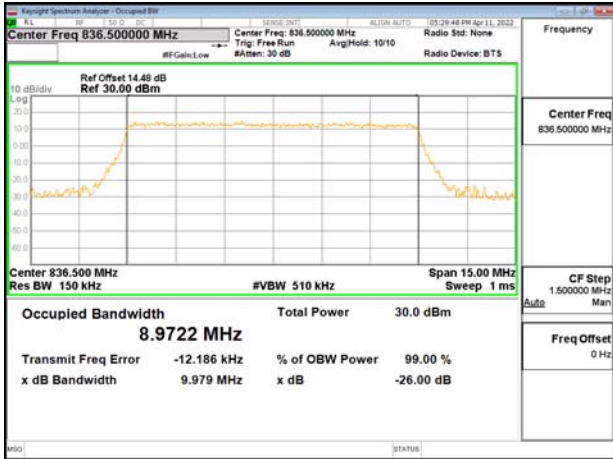

Band5_10MHz_256QAM_RB50_0_CH20525

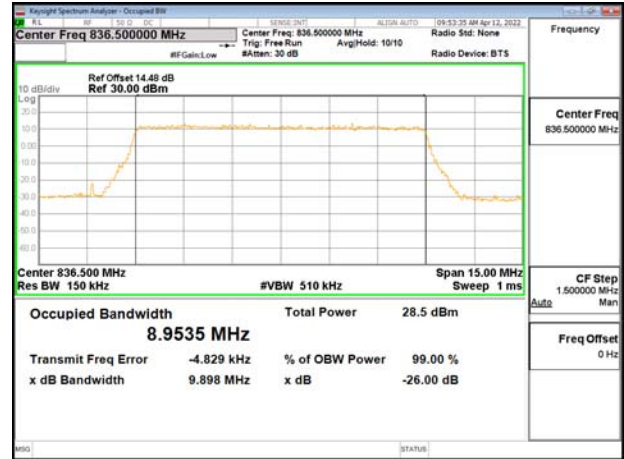

Band5_10MHz_64QAM_RB50_0_CH20600

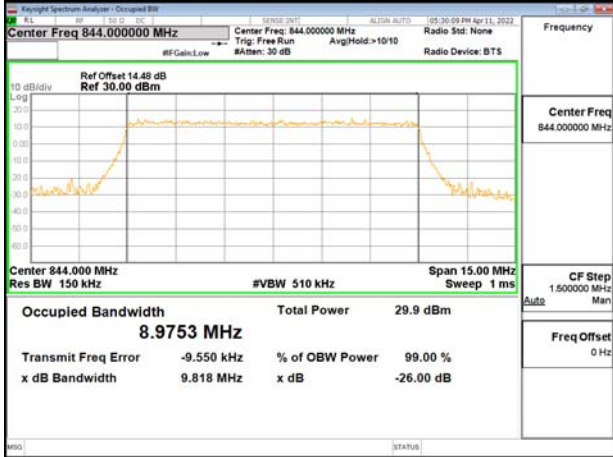

Band5_10MHz_256QAM_RB50_0_CH20600

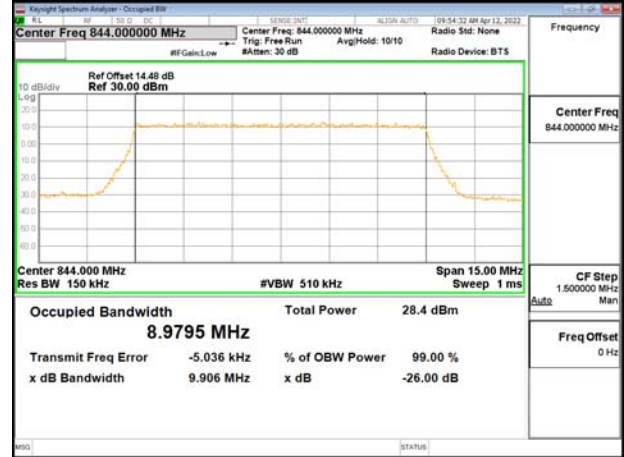

Unless otherwise stated the results shown in this test report refer only to the sample(s) tested and such sample(s) are retained for 90 days only.

除非另有說明，此報告結果僅對測試之樣品負責，同時此樣品僅保留90天。本報告未經本公司書面許可，不可部份複製。

This document is issued by the Company subject to its General Conditions of Service printed overleaf, available on request or accessible at <http://www.sgs.com.tw/Terms-and-Conditions> and for electronic format documents, subject to Terms and Conditions for Electronic Documents at <http://www.sgs.com.tw/Terms-and-Conditions>. Attention is drawn to the limitation of liability, indemnification and jurisdiction issues defined therein. Any holder of this document is advised that information contained herein reflects the Company's findings at the time of its intervention only and within the limits of Client's instructions, if any. The Company's sole responsibility is to its Client and this document does not exonerate parties to a transaction from exercising all their rights and obligations under the transaction documents. This document cannot be reproduced except in full, without prior written approval of the Company. Any unauthorized alteration, forgery or falsification of the content or appearance of this document is unlawful and offenders may be prosecuted to the fullest extent of the law.

Band13_5MHz_QPSK_RB25_0_CH23205

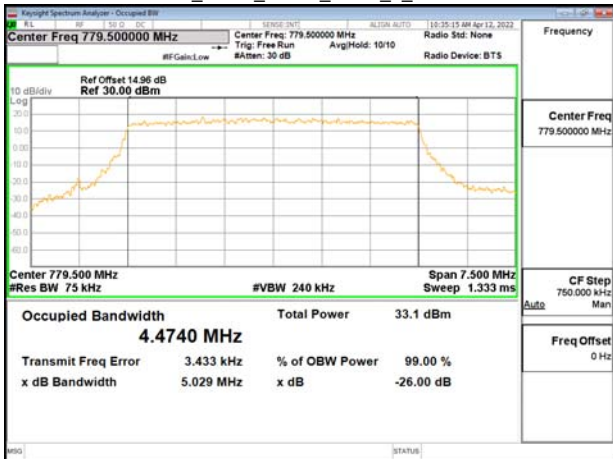

Band13_5MHz_16QAM_RB25_0_CH23205

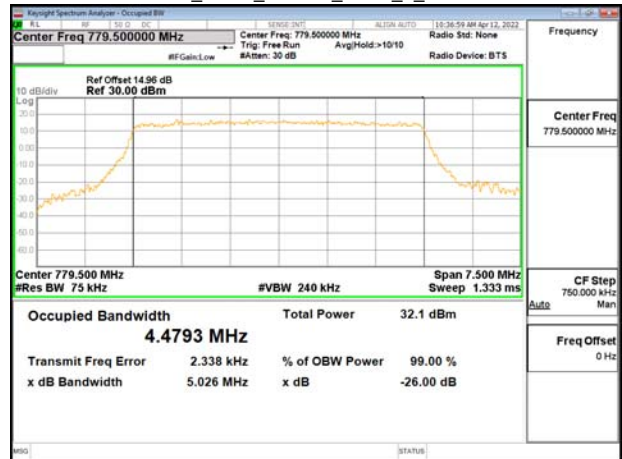

Band13_5MHz_QPSK_RB25_0_CH23230

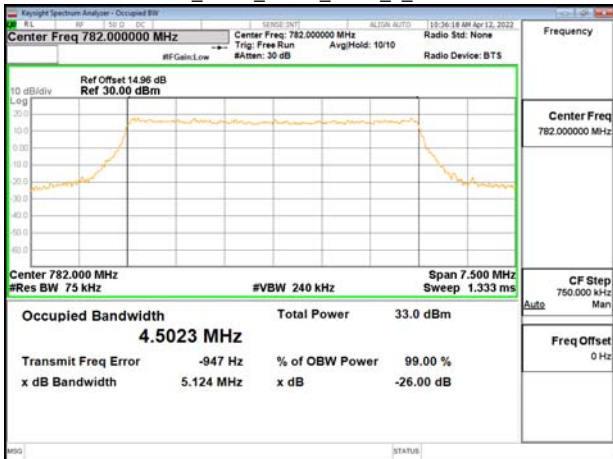

Band13_5MHz_16QAM_RB25_0_CH23230

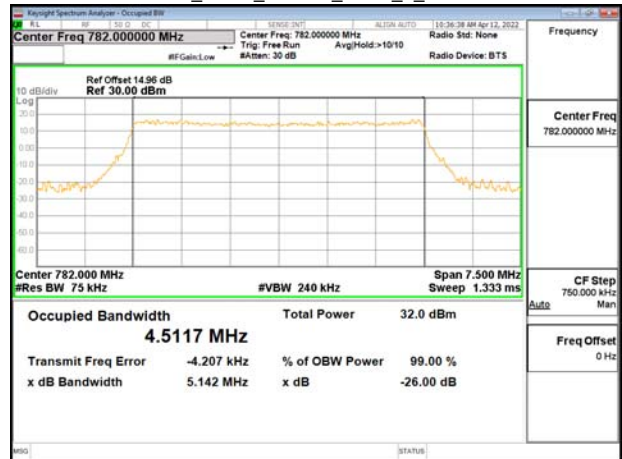

Band13_5MHz_QPSK_RB25_0_CH23255

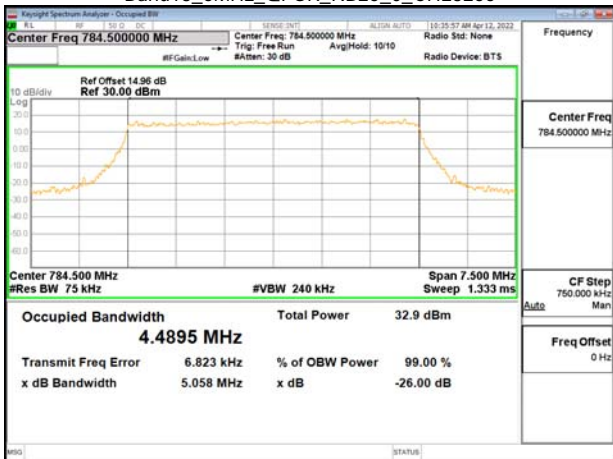

Band13_5MHz_16QAM_RB25_0_CH23255

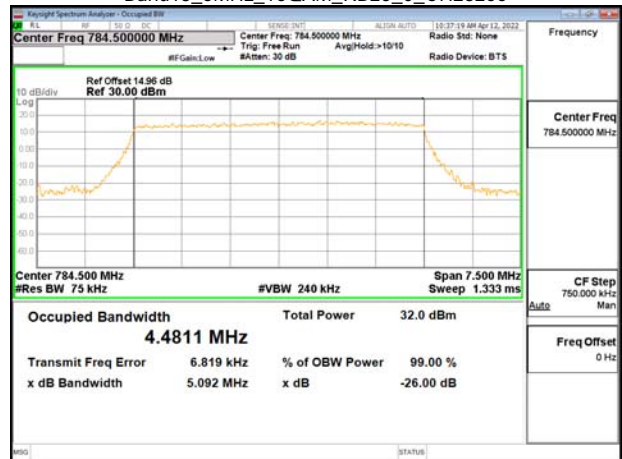

Unless otherwise stated the results shown in this test report refer only to the sample(s) tested and such sample(s) are retained for 90 days only.

除非另有說明，此報告結果僅對測試之樣品負責，同時此樣品僅保留90天。本報告未經本公司書面許可，不可部份複製。

This document is issued by the Company subject to its General Conditions of Service printed overleaf, available on request or accessible at <http://www.sgs.com.tw/Terms-and-Conditions> and for electronic format documents, subject to Terms and Conditions for Electronic Documents at <http://www.sgs.com.tw/Terms-and-Conditions>. Attention is drawn to the limitation of liability, indemnification and jurisdiction issues defined therein. Any holder of this document is advised that information contained herein reflects the Company's findings at the time of its intervention only and within the limits of Client's instructions, if any. The Company's sole responsibility is to its Client and this document does not exonerate parties to a transaction from exercising all their rights and obligations under the transaction documents. This document cannot be reproduced except in full, without prior written approval of the Company. Any unauthorized alteration, forgery or falsification of the content or appearance of this document is unlawful and offenders may be prosecuted to the fullest extent of the law.

Band13_5MHz_64QAM_RB25_0_CH23205

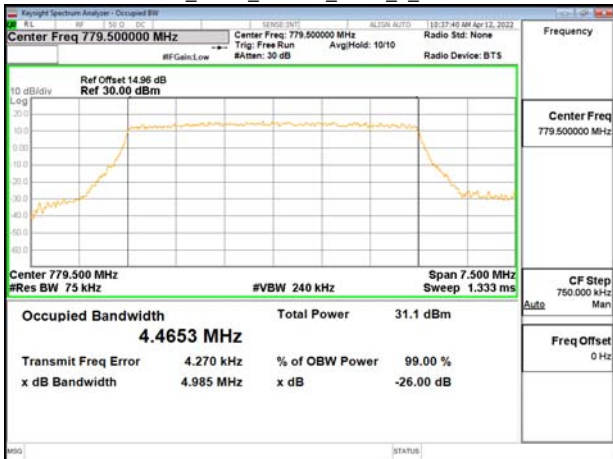

Band13_5MHz_256QAM_RB25_0_CH23205

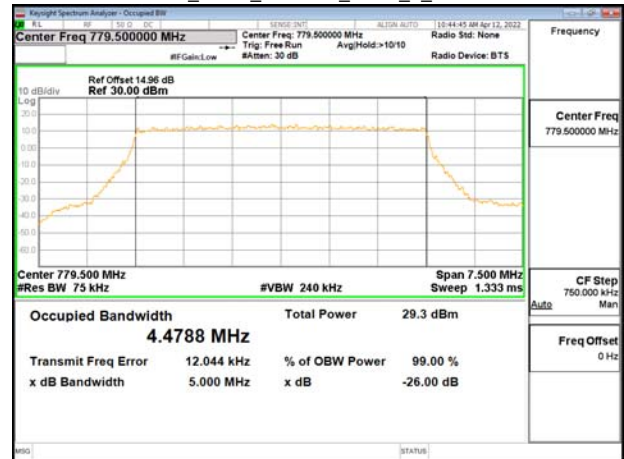

Band13_5MHz_64QAM_RB25_0_CH23230

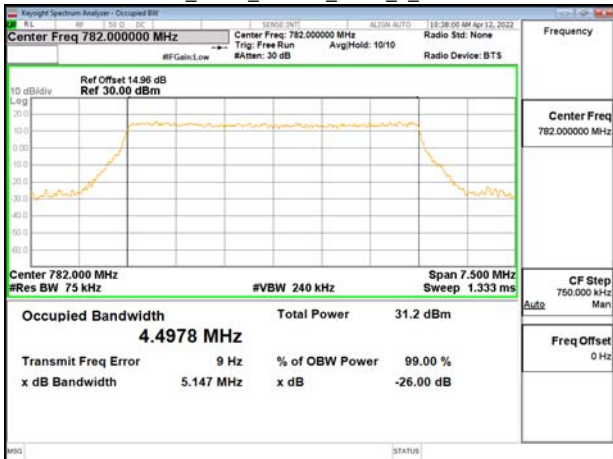

Band13_5MHz_256QAM_RB25_0_CH23230



Band13_5MHz_64QAM_RB25_0_CH23255

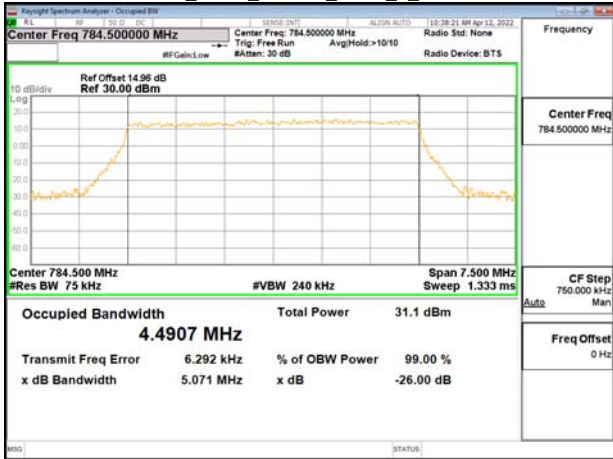

Band13_5MHz_256QAM_RB25_0_CH23255

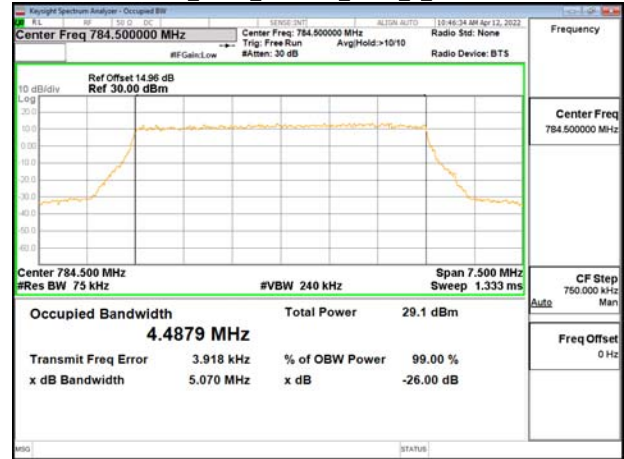

Unless otherwise stated the results shown in this test report refer only to the sample(s) tested and such sample(s) are retained for 90 days only.

除非另有說明，此報告結果僅對測試之樣品負責，同時此樣品僅保留90天。本報告未經本公司書面許可，不可部份複製。

This document is issued by the Company subject to its General Conditions of Service printed overleaf, available on request or accessible at <http://www.sgs.com.tw/Terms-and-Conditions> and for electronic format documents, subject to Terms and Conditions for Electronic Documents at <http://www.sgs.com.tw/Terms-and-Conditions>. Attention is drawn to the limitation of liability, indemnification and jurisdiction issues defined therein. Any holder of this document is advised that information contained herein reflects the Company's findings at the time of its intervention only and within the limits of Client's instructions, if any. The Company's sole responsibility is to its Client and this document does not exonerate parties to a transaction from exercising all their rights and obligations under the transaction documents. This document cannot be reproduced except in full, without prior written approval of the Company. Any unauthorized alteration, forgery or falsification of the content or appearance of this document is unlawful and offenders may be prosecuted to the fullest extent of the law.

Band13_10MHz_QPSK_RB50_0_CH23230

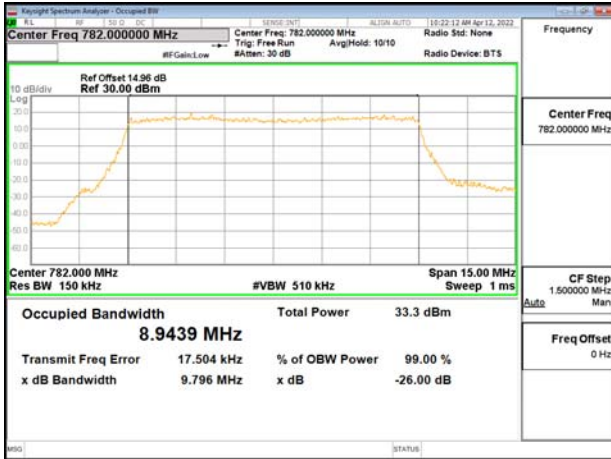

Band13_10MHz_256QAM_RB50_0_CH23230

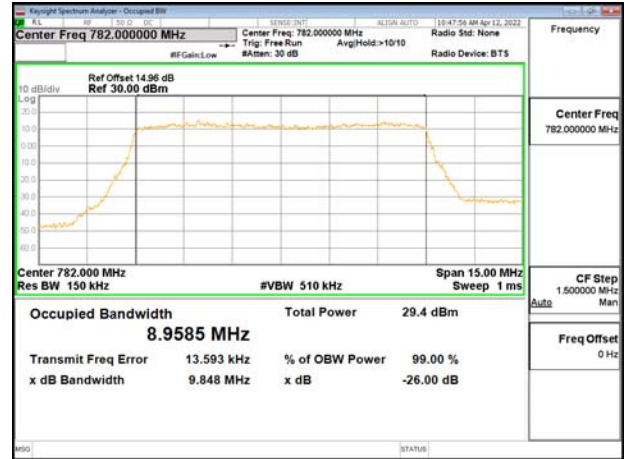

Band13_10MHz_16QAM_RB50_0_CH23230

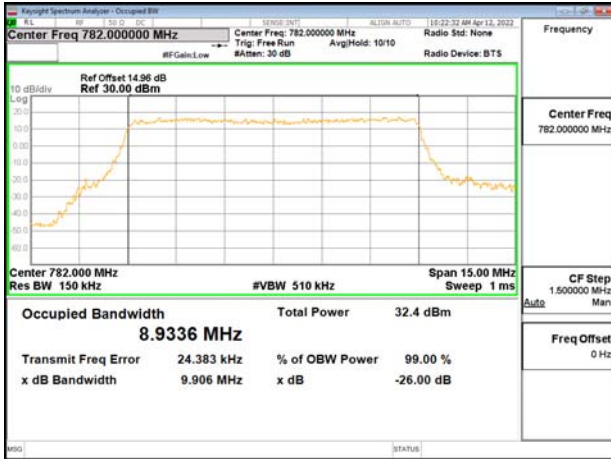

Band66_1.4MHz_QPSK_RB6_0_CH131979

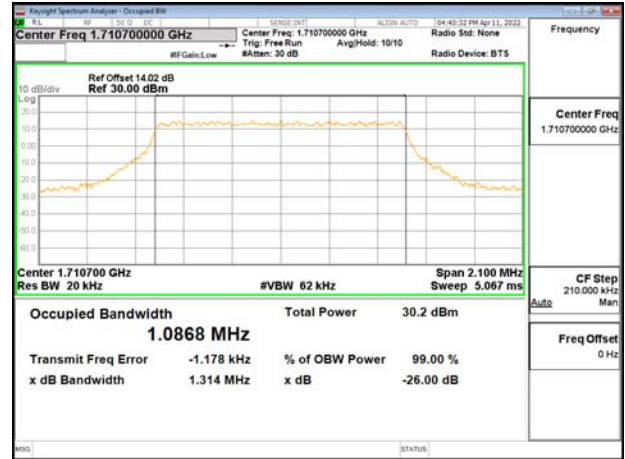

Band13_10MHz_64QAM_RB50_0_CH23230

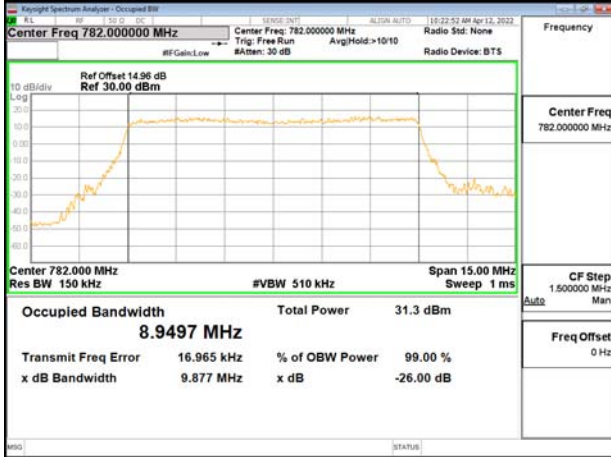

Band66_1.4MHz_QPSK_RB6_0_CH132322

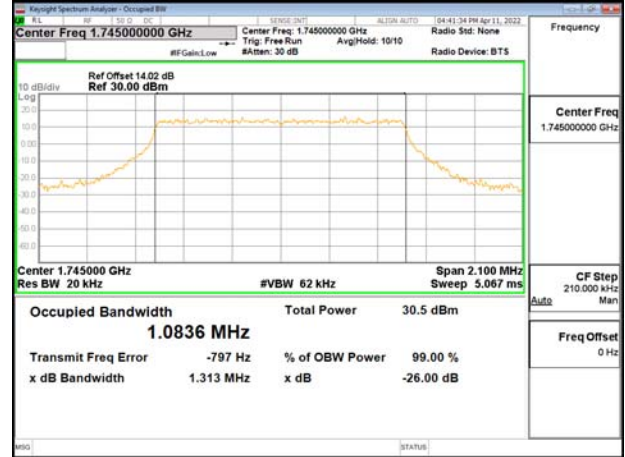

Unless otherwise stated the results shown in this test report refer only to the sample(s) tested and such sample(s) are retained for 90 days only.

除非另有說明，此報告結果僅對測試之樣品負責，同時此樣品僅保留90天。本報告未經本公司書面許可，不可部份複製。

This document is issued by the Company subject to its General Conditions of Service printed overleaf, available on request or accessible at <http://www.sgs.com.tw/Terms-and-Conditions> and for electronic format documents, subject to Terms and Conditions for Electronic Documents at <http://www.sgs.com.tw/Terms-and-Conditions>. Attention is drawn to the limitation of liability, indemnification and jurisdiction issues defined therein. Any holder of this document is advised that information contained herein reflects the Company's findings at the time of its intervention only and within the limits of Client's instructions, if any. The Company's sole responsibility is to its Client and this document does not exonerate parties to a transaction from exercising all their rights and obligations under the transaction documents. This document cannot be reproduced except in full, without prior written approval of the Company. Any unauthorized alteration, forgery or falsification of the content or appearance of this document is unlawful and offenders may be prosecuted to the fullest extent of the law.

Band66_1.4MHz_QPSK_RB6_0_CH132665

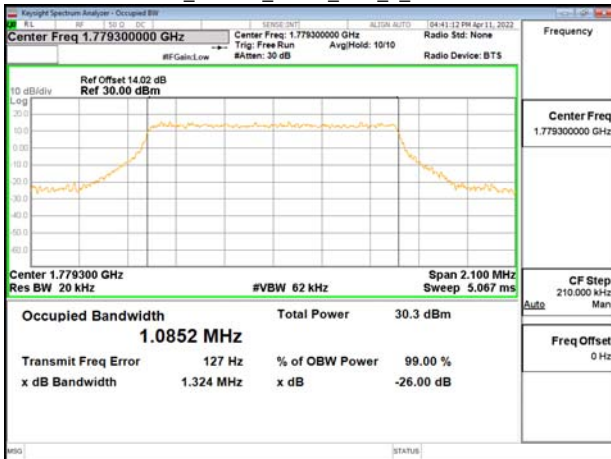

Band66_1.4MHz_16QAM_RB6_0_CH132665

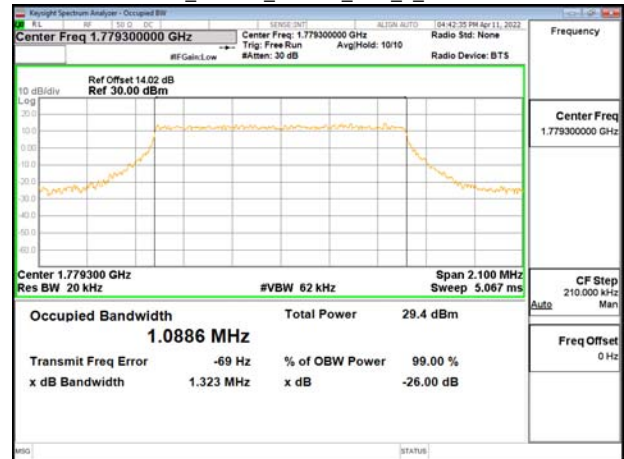

Band66_1.4MHz_16QAM_RB6_0_CH131979

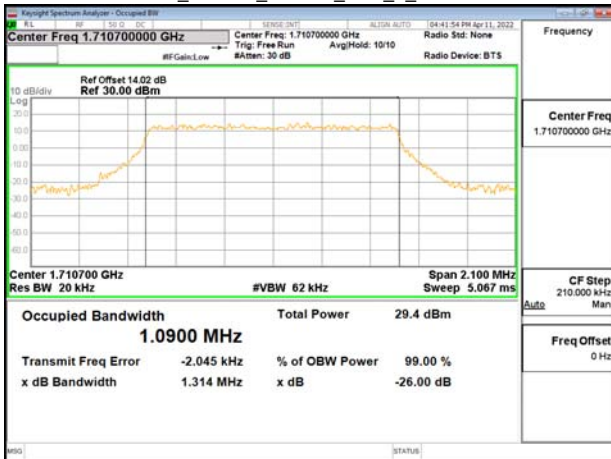

Band66_1.4MHz_64QAM_RB6_0_CH131979



Band66_1.4MHz_16QAM_RB6_0_CH132322

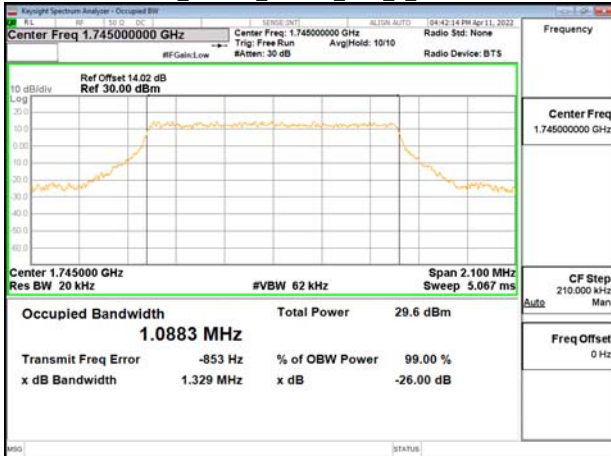

Band66_1.4MHz_64QAM_RB6_0_CH132322

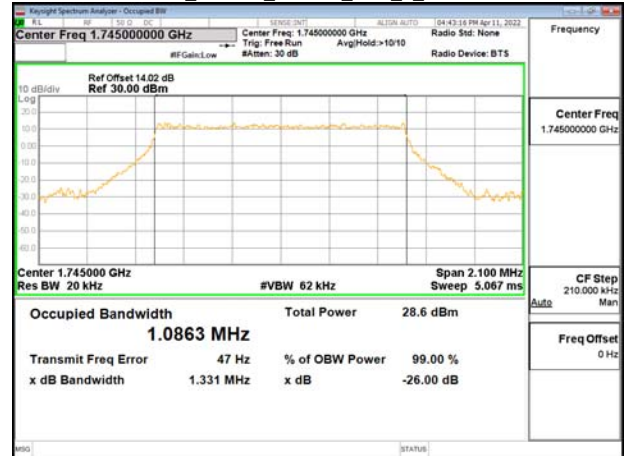

Unless otherwise stated the results shown in this test report refer only to the sample(s) tested and such sample(s) are retained for 90 days only.

除非另有說明，此報告結果僅對測試之樣品負責，同時此樣品僅保留90天。本報告未經本公司書面許可，不可部份複製。

This document is issued by the Company subject to its General Conditions of Service printed overleaf, available on request or accessible at <http://www.sgs.com.tw/Terms-and-Conditions> and for electronic format documents, subject to Terms and Conditions for Electronic Documents at <http://www.sgs.com.tw/Terms-and-Conditions>. Attention is drawn to the limitation of liability, indemnification and jurisdiction issues defined therein. Any holder of this document is advised that information contained herein reflects the Company's findings at the time of its intervention only and within the limits of Client's instructions, if any. The Company's sole responsibility is to its Client and this document does not exonerate parties to a transaction from exercising all their rights and obligations under the transaction documents. This document cannot be reproduced except in full, without prior written approval of the Company. Any unauthorized alteration, forgery or falsification of the content or appearance of this document is unlawful and offenders may be prosecuted to the fullest extent of the law.