

**ELECTROMAGNETIC EMISSIONS  
COMPLIANCE REPORT**

**Applicant:** FIH CO., LTD.  
No.4, Minsheng St., Tu-Cheng Dist., New Taipei City 23679,  
Taiwan

**Manufacturer:** FIH CO., LTD.  
No.4, Minsheng St., Tu-Cheng Dist., New Taipei City 23679,  
Taiwan

**Product Name:** Internet Gateway

**Brand Name:** FIH

**Model No.:** FSNO21VA

**Model Difference:** N/A

**Report Number:** ER/2022/30083

**FCC ID** RYQFSNO21VA

**Issue Date:** June 6, 2022

**Date of Test:** April 13, 2022 ~ May 10, 2022

**Date of EUT Received:** March 30, 2022

Approved By \_\_\_\_\_

**Blue Yang**

**We hereby certify that:**

The above equipment was tested by SGS Taiwan Ltd. Central RF Lab The test data, data evaluation, test procedures, and equipment configurations shown in this report were made in accordance with the procedures given in ANSI C63.26-2015 and the energy emitted by the sample EUT comply with FCC rule part 2 , 22H & 27 C.

The results of this report relate only to the sample identified in this report.

Unless otherwise stated the results shown in this test report refer only to the sample(s) tested and such sample(s) are retained for 90 days only.

除非另有說明，此報告結果僅對測試之樣品負責，同時此樣品僅保留90天。本報告未經本公司書面許可，不可部份複製。

This document is issued by the Company subject to its General Conditions of Service printed overleaf, available on request or accessible at <http://www.sgs.com.tw/Terms-and-Conditions> and for electronic format documents, subject to Terms and Conditions for Electronic Documents at <http://www.sgs.com.tw/Terms-and-Conditions>. Attention is drawn to the limitation of liability, indemnification and jurisdiction issues defined therein. Any holder of this document is advised that information contained hereon reflects the Company's findings at the time of its intervention only and within the limits of Client's instructions, if any. The Company's sole responsibility is to its Client and this document does not exonerate parties to a transaction from exercising all their rights and obligations under the transaction documents. This document cannot be reproduced except in full, without prior written approval of the Company. Any unauthorized alteration, forgery or falsification of the content or appearance of this document is unlawful and offenders may be prosecuted to the fullest extent of the law.

Revision History					
Report Number	Revision	Description	Issue Date	Revised By	Remark
ER/2022/30083	00	Original	May 30, 2022	Yuri Tsai	
ER/2022/30083	01	Updated type of emission	June 6, 2022	Yuri Tsai	*

**Note:**

- 1、The remark "\*" indicates modification of the report upon requests from certification body.

Unless otherwise stated the results shown in this test report refer only to the sample(s) tested and such sample(s) are retained for 90 days only.

除非另有說明，此報告結果僅對測試之樣品負責，同時此樣品僅保留90天。本報告未經本公司書面許可，不可部份複製。

This document is issued by the Company subject to its General Conditions of Service printed overleaf, available on request or accessible at <http://www.sgs.com.tw/Terms-and-Conditions> and for electronic format documents, subject to Terms and Conditions for Electronic Documents at <http://www.sgs.com.tw/Terms-and-Conditions>. Attention is drawn to the limitation of liability, indemnification and jurisdiction issues defined therein. Any holder of this document is advised that information contained hereon reflects the Company's findings at the time of its intervention only and within the limits of Client's instructions, if any. The Company's sole responsibility is to its Client and this document does not exonerate parties to a transaction from exercising all their rights and obligations under the transaction documents. This document cannot be reproduced except in full, without prior written approval of the Company. Any unauthorized alteration, forgery or falsification of the content or appearance of this document is unlawful and offenders may be prosecuted to the fullest extent of the law.

## Contents

<b>1</b>	<b>GENERAL PRODUCT INFORMATION .....</b>	<b>4</b>
<b>2</b>	<b>SYSTEM TEST CONFIGURATION .....</b>	<b>10</b>
<b>3</b>	<b>SUMMARY OF TEST RESULTS.....</b>	<b>13</b>
<b>4</b>	<b>DESCRIPTION OF TEST MODES .....</b>	<b>14</b>
<b>5</b>	<b>MEASUREMENT UNCERTAINTY .....</b>	<b>19</b>
<b>6</b>	<b>MEASUREMENT EQUIPMENT USED.....</b>	<b>20</b>
<b>7</b>	<b>MAXIMUM OUTPUT POWER .....</b>	<b>21</b>
<b>8</b>	<b>OCCUPIED BANDWIDTH MEASUREMENT .....</b>	<b>36</b>
<b>9</b>	<b>OUT OF BAND EMISSION AT ANTENNA TERMINALS .....</b>	<b>48</b>
<b>10</b>	<b>FIELD STRENGTH OF SPURIOUS RADIATION MEASUREMENT .....</b>	<b>58</b>
<b>11</b>	<b>FREQUENCY STABILITY MEASUREMENT .....</b>	<b>91</b>
<b>12</b>	<b>PEAK TO AVERAGE RATIO .....</b>	<b>94</b>

Unless otherwise stated the results shown in this test report refer only to the sample(s) tested and such sample(s) are retained for 90 days only.

除非另有說明，此報告結果僅對測試之樣品負責，同時此樣品僅保留90天。本報告未經本公司書面許可，不可部份複製。

This document is issued by the Company subject to its General Conditions of Service printed overleaf, available on request or accessible at <http://www.sgs.com.tw/Terms-and-Conditions> and for electronic format documents, subject to Terms and Conditions for Electronic Documents at <http://www.sgs.com.tw/Terms-and-Conditions>. Attention is drawn to the limitation of liability, indemnification and jurisdiction issues defined therein. Any holder of this document is advised that information contained hereon reflects the Company's findings at the time of its intervention only and within the limits of Client's instructions, if any. The Company's sole responsibility is to its Client and this document does not exonerate parties to a transaction from exercising all their rights and obligations under the transaction documents. This document cannot be reproduced except in full, without prior written approval of the Company. Any unauthorized alteration, forgery or falsification of the content or appearance of this document is unlawful and offenders may be prosecuted to the fullest extent of the law.

# 1 GENERAL PRODUCT INFORMATION

## 1.1 Product Description

Product Name:	Internet Gateway
Brand Name:	FIH
Model No.:	FSNO21VA
Model Difference:	N/A
Hardware Version:	1.0
Firmware Version:	V0.15A_1KUS
EUT Series No.:	356405430000450
Power Supply:	12Vdc from AC/DC Adapter
Test Software (Name/Version)	default

Unless otherwise stated the results shown in this test report refer only to the sample(s) tested and such sample(s) are retained for 90 days only.

除非另有說明，此報告結果僅對測試之樣品負責，同時此樣品僅保留90天。本報告未經本公司書面許可，不可部份複製。

This document is issued by the Company subject to its General Conditions of Service printed overleaf, available on request or accessible at <http://www.sgs.com.tw/Terms-and-Conditions> and for electronic format documents, subject to Terms and Conditions for Electronic Documents at <http://www.sgs.com.tw/Terms-and-Conditions>. Attention is drawn to the limitation of liability, indemnification and jurisdiction issues defined therein. Any holder of this document is advised that information contained hereon reflects the Company's findings at the time of its intervention only and within the limits of Client's instructions, if any. The Company's sole responsibility is to its Client and this document does not exonerate parties to a transaction from exercising all their rights and obligations under the transaction documents. This document cannot be reproduced except in full, without prior written approval of the Company. Any unauthorized alteration, forgery or falsification of the content or appearance of this document is unlawful and offenders may be prosecuted to the fullest extent of the law.

## 1.2 Operation Frequency Range

LTE Band 5B	
BW (MHz)	Operation Frequency (MHz)
15	831.5 - 841.5
20	834.0 - 839.0
LTE Band 66B	
BW (MHz)	Operation Frequency (MHz)
10	1715.0 - 1775.0
15	1717.5 - 1772.5
20	1720.0 - 1770.0
LTE Band 66C	
BW (MHz)	Operation Frequency (MHz)
25	1722.5 - 1767.5
30	1725.0 - 1765.0
35	1727.5 - 1762.5
40	1730.0 - 1760.0

Unless otherwise stated the results shown in this test report refer only to the sample(s) tested and such sample(s) are retained for 90 days only.

除非另有說明，此報告結果僅對測試之樣品負責，同時此樣品僅保留90天。本報告未經本公司書面許可，不可部份複製。

This document is issued by the Company subject to its General Conditions of Service printed overleaf, available on request or accessible at <http://www.sgs.com.tw/Terms-and-Conditions> and for electronic format documents, subject to Terms and Conditions for Electronic Documents at <http://www.sgs.com.tw/Terms-and-Conditions>. Attention is drawn to the limitation of liability, indemnification and jurisdiction issues defined therein. Any holder of this document is advised that information contained hereon reflects the Company's findings at the time of its intervention only and within the limits of Client's instructions, if any. The Company's sole responsibility is to its Client and this document does not exonerate parties to a transaction from exercising all their rights and obligations under the transaction documents. This document cannot be reproduced except in full, without prior written approval of the Company. Any unauthorized alteration, forgery or falsification of the content or appearance of this document is unlawful and offenders may be prosecuted to the fullest extent of the law.

### 1.3 Antenna Designation

Antenna Type	Antenna No.
PIFA	Ant0
Dipole	Ant1
<b>Note:</b> Transmission in frequencies in this test report are only available by the above antenna(s).	

Modulation	Frequency (MHz)			Peak Antenna Gain (dBi)	
				Ant0	Ant1
LTE-Band 5	824	~	849	-2.41266	
LTE-Band 66	1710	~	1780		-0.89447

**Note:** Antenna information is provided by the applicant.

Unless otherwise stated the results shown in this test report refer only to the sample(s) tested and such sample(s) are retained for 90 days only.

除非另有說明，此報告結果僅對測試之樣品負責，同時此樣品僅保留90天。本報告未經本公司書面許可，不可部份複製。

This document is issued by the Company subject to its General Conditions of Service printed overleaf, available on request or accessible at <http://www.sgs.com.tw/Terms-and-Conditions> and for electronic format documents, subject to Terms and Conditions for Electronic Documents at <http://www.sgs.com.tw/Terms-and-Conditions>. Attention is drawn to the limitation of liability, indemnification and jurisdiction issues defined therein. Any holder of this document is advised that information contained hereon reflects the Company's findings at the time of its intervention only and within the limits of Client's instructions, if any. The Company's sole responsibility is to its Client and this document does not exonerate parties to a transaction from exercising all their rights and obligations under the transaction documents. This document cannot be reproduced except in full, without prior written approval of the Company. Any unauthorized alteration, forgery or falsification of the content or appearance of this document is unlawful and offenders may be prosecuted to the fullest extent of the law.

### 1.4 Type of Emission & Max ERP/EIRP Power Measurement Result:

#### 1.4.1 Intra-Band

LTE Band	BW	Modulation	ERP / EIRP (dBm)		(W)	99%	Type of Emission
5B	15	QPSK	19.25	ERP	<b>0.084</b>	13.8840	13M9G7D
		16QAM	18.30	ERP	0.068	13.8970	13M9D7W
		64QAM	17.37	ERP	0.055	13.8840	13M9D7W
5B	20	QPSK	18.99	ERP	0.079	18.7490	18M7G7D
		16QAM	18.13	ERP	0.065	18.7710	18M8D7W
		64QAM	17.11	ERP	0.051	18.7520	18M8D7W
LTE Band	BW	Modulation	ERP / EIRP (dBm)		(W)	99%	Type of Emission
66C	25	QPSK	22.41	EIRP	0.174	23.2600	23M3G7D
		16QAM	21.72	EIRP	0.148	23.2060	23M2D7W
		64QAM	20.67	EIRP	0.117	23.1930	23M2D7W
66C	30	QPSK	22.49	EIRP	<b>0.177</b>	28.3830	28M4G7D
		16QAM	21.64	EIRP	0.146	28.3840	28M4D7W
		64QAM	20.58	EIRP	0.114	28.4040	28M4D7W
66C	35	QPSK	22.46	EIRP	<b>0.176</b>	32.7470	32M7G7D
		16QAM	21.49	EIRP	0.141	32.7320	32M7D7W
		64QAM	20.73	EIRP	0.118	32.7380	32M7D7W
66C	40	QPSK	22.35	EIRP	<b>0.172</b>	37.6400	37M6G7D
		16QAM	21.38	EIRP	0.137	37.7120	37M7D7W
		64QAM	20.45	EIRP	0.111	37.6630	37M7D7W
LTE Band	BW	Modulation	ERP / EIRP (dBm)		(W)	99%	Type of Emission
66B	10	QPSK	22.60	EIRP	<b>0.182</b>	9.2234	9M2G7D
		16QAM	21.55	EIRP	0.143	9.2484	9M2D7W
		64QAM	20.83	EIRP	0.121	9.2707	9M3D7W
66B	15	QPSK	22.59	EIRP	0.181	13.8940	13M9G7D
		16QAM	21.69	EIRP	0.147	13.9100	13M9D7W
		64QAM	20.64	EIRP	0.116	13.9310	13M9D7W
66B	20	QPSK	22.53	EIRP	<b>0.179</b>	18.8170	18M8G7D
		16QAM	21.76	EIRP	0.150	18.7910	18M8D7W
		64QAM	20.65	EIRP	0.116	18.8040	18M8D7W

#### 1.4.2 Inter-Band

Please refer to section 7.5.2 of this report.

Unless otherwise stated the results shown in this test report refer only to the sample(s) tested and such sample(s) are retained for 90 days only.

除非另有說明，此報告結果僅對測試之樣品負責，同時此樣品僅保留90天。本報告未經本公司書面許可，不可部份複製。

This document is issued by the Company subject to its General Conditions of Service printed overleaf, available on request or accessible at <http://www.sgs.com.tw/Terms-and-Conditions> and for electronic format documents, subject to Terms and Conditions for Electronic Documents at <http://www.sgs.com.tw/Terms-and-Conditions>. Attention is drawn to the limitation of liability, indemnification and jurisdiction issues defined therein. Any holder of this document is advised that information contained hereon reflects the Company's findings at the time of its intervention only and within the limits of Client's instructions, if any. The Company's sole responsibility is to its Client and this document does not exonerate parties to a transaction from exercising all their rights and obligations under the transaction documents. This document cannot be reproduced except in full, without prior written approval of the Company. Any unauthorized alteration, forgery or falsification of the content or appearance of this document is unlawful and offenders may be prosecuted to the fullest extent of the law.

### 1.5 Test Methodology of Applied Standards

FCC 47 CFR Part 2, 22H, 27C

ANSI C63.26-2015

KDB971168 D01 Power Meas license Digital System v03r01

KDB412172 D01 Determining ERP and EIRP v01r01

### 1.6 Test Facility

Laboratory	Test Site Address	Test Site Name	FCC Designation number	IC CAB identifier
SGS Taiwan Ltd. Central RF Lab. (TAF code 3702)	No.134, Wu Kung Road, New Taipei Industrial Park, Wuku District, New Taipei City, Taiwan.	SAC 1	TW0027	TW3702
		SAC 3		
		Conduction 1		
		Conducted 1		
		Conducted 2		
		Conducted 3		
		Conducted 4		
		Conducted 5		
	Conducted 6			
	No.2, Keji 1st Rd., Guishan District, Taoyuan City, Taiwan 333	Conduction C	TW0028	
		SAC C		
		SAC D		
		SAC G		
		Conducted A		
		Conducted B		
		Conducted C		
		Conducted D		
		Conducted E		
		Conducted F		
Conducted G				

**Note:** Test site name is remarked on the equipment list in each section of this report as an indication where measurements occurred in specific test site and address.

Unless otherwise stated the results shown in this test report refer only to the sample(s) tested and such sample(s) are retained for 90 days only.

除非另有說明，此報告結果僅對測試之樣品負責，同時此樣品僅保留90天。本報告未經本公司書面許可，不可部份複製。

This document is issued by the Company subject to its General Conditions of Service printed overleaf, available on request or accessible at <http://www.sgs.com.tw/Terms-and-Conditions> and for electronic format documents, subject to Terms and Conditions for Electronic Documents at <http://www.sgs.com.tw/Terms-and-Conditions>. Attention is drawn to the limitation of liability, indemnification and jurisdiction issues defined therein. Any holder of this document is advised that information contained hereon reflects the Company's findings at the time of its intervention only and within the limits of Client's instructions, if any. The Company's sole responsibility is to its Client and this document does not exonerate parties to a transaction from exercising all their rights and obligations under the transaction documents. This document cannot be reproduced except in full, without prior written approval of the Company. Any unauthorized alteration, forgery or falsification of the content or appearance of this document is unlawful and offenders may be prosecuted to the fullest extent of the law.



## 1.7 Special Accessories

No special accessories were used during testing.

## 1.8 Equipment Modifications

There was no modifications incorporated into the EUT.

## 1.9 Radiated Emission Test Sites for Measurements from 9 kHz to 30 MHz

Radiated emission below 30MHz is measured in a 9m\*6m\*6m semi-anechoic chamber, the measurements correspond to those obtained at an open-field test site.

There is a comparison data of both open-field test site and semi-Anechoic chamber, and the result came out very similar.

Unless otherwise stated the results shown in this test report refer only to the sample(s) tested and such sample(s) are retained for 90 days only.

除非另有說明，此報告結果僅對測試之樣品負責，同時此樣品僅保留90天。本報告未經本公司書面許可，不可部份複製。

This document is issued by the Company subject to its General Conditions of Service printed overleaf, available on request or accessible at <http://www.sgs.com.tw/Terms-and-Conditions> and for electronic format documents, subject to Terms and Conditions for Electronic Documents at <http://www.sgs.com.tw/Terms-and-Conditions>. Attention is drawn to the limitation of liability, indemnification and jurisdiction issues defined therein. Any holder of this document is advised that information contained hereon reflects the Company's findings at the time of its intervention only and within the limits of Client's instructions, if any. The Company's sole responsibility is to its Client and this document does not exonerate parties to a transaction from exercising all their rights and obligations under the transaction documents. This document cannot be reproduced except in full, without prior written approval of the Company. Any unauthorized alteration, forgery or falsification of the content or appearance of this document is unlawful and offenders may be prosecuted to the fullest extent of the law.

## 2 SYSTEM TEST CONFIGURATION

### 2.1 EUT Configuration

The EUT configuration for testing is installed on RF field strength measurement to meet the Commissions requirement and operating in a manner which intends to maximize its emission characteristics in a continuous normal application.

### 2.2 EUT Exercise

The EUT (Transmitter) was operated in the continuous transmission mode employed with the simulator of the Base Station that fixates at test default channels to fix the Tx frequency which was for the purpose of the measurements.

### 2.3 Test Procedure

#### 2.3.1 Conducted Measurement at Antenna Port

The EUT is placed on a table which is 0.8 m above ground plane. A low loss of RF cable was used to connect the antenna port of EUT to measurement equipment.

#### 2.3.2 Radiated Emissions (ERP/EIRP)

The EUT is placed on a turn table, for emission measurements below 1 GHz is 0.8 m above ground plane, for emission measurements above 1 GHz, the table height shall be 1.5 m. The turn table shall rotate 360 degrees to determine the position of maximum emission level. EUT is set 3m away from the receiving antenna which varied from 1m to 4m to find out the highest emission. And also, each emission was to be maximized by changing the polarization of receiving antenna both Horizontal and Vertical. In order to find out the max. emission, the relative positions of this hand-held transmitter (EUT) was rotated through three orthogonal axes and measurement procedures for electric field radiated emissions above 1 GHz the EUT measurement is to be made “while keeping the antenna in the ‘cone of radiation’ from that area and pointed at the area both in azimuth and elevation, with polarization oriented for maximum response.” is still within the 3dB illumination BW of the measurement antenna.

### 2.4 Measurement Results Explanation Example

#### For all conducted test items:

The offset level is set in the spectrum analyzer to compensate the RF cable loss and attenuation factor between EUT conducted port and spectrum analyzer. With the offset compensation, the spectrum analyzer reading level is exactly EUT RF output level.

#### Note:

The spectrum analyzer offset is derived from RF cable loss and attenuator factor. Following shows an offset computation in physical test.

Frequency	RF Cable loss (dB)	Attenuation (dB)	Offset (dB)
LB(1GHz below)	4.48	10	14.48
MB(1GHz - 2GHz)	4.02	10	14.02

Unless otherwise stated the results shown in this test report refer only to the sample(s) tested and such sample(s) are retained for 90 days only.

除非另有說明，此報告結果僅對測試之樣品負責，同時此樣品僅保留90天。本報告未經本公司書面許可，不可部份複製。

This document is issued by the Company subject to its General Conditions of Service printed overleaf, available on request or accessible at <http://www.sgs.com.tw/Terms-and-Conditions> and for electronic format documents, subject to Terms and Conditions for Electronic Documents at <http://www.sgs.com.tw/Terms-and-Conditions>. Attention is drawn to the limitation of liability, indemnification and jurisdiction issues defined therein. Any holder of this document is advised that information contained hereon reflects the Company's findings at the time of its intervention only and within the limits of Client's instructions, if any. The Company's sole responsibility is to its Client and this document does not exonerate parties to a transaction from exercising all their rights and obligations under the transaction documents. This document cannot be reproduced except in full, without prior written approval of the Company. Any unauthorized alteration, forgery or falsification of the content or appearance of this document is unlawful and offenders may be prosecuted to the fullest extent of the law.

**2.5 Final Amplifier Voltage and Current Information:**

**LTE CA Band 5B**

Test mode	AC voltage (V)	AC current (mA)
LTE CA Band 5B 10M+10M QPSK	120	85

**LTE CA Band 66B**

Test mode	AC voltage (V)	AC current (mA)
LTE CA Band 66C 10M+10M QPSK	120	80

**LTE CA Band 66C**

Test mode	AC voltage (V)	AC current (mA)
LTE CA Band 66C 20M+20M QPSK	120	83

Unless otherwise stated the results shown in this test report refer only to the sample(s) tested and such sample(s) are retained for 90 days only.

除非另有說明，此報告結果僅對測試之樣品負責，同時此樣品僅保留90天。本報告未經本公司書面許可，不可部份複製。

This document is issued by the Company subject to its General Conditions of Service printed overleaf, available on request or accessible at <http://www.sgs.com.tw/Terms-and-Conditions> and for electronic format documents, subject to Terms and Conditions for Electronic Documents at <http://www.sgs.com.tw/Terms-and-Conditions>. Attention is drawn to the limitation of liability, indemnification and jurisdiction issues defined therein. Any holder of this document is advised that information contained hereon reflects the Company's findings at the time of its intervention only and within the limits of Client's instructions, if any. The Company's sole responsibility is to its Client and this document does not exonerate parties to a transaction from exercising all their rights and obligations under the transaction documents. This document cannot be reproduced except in full, without prior written approval of the Company. Any unauthorized alteration, forgery or falsification of the content or appearance of this document is unlawful and offenders may be prosecuted to the fullest extent of the law.

## 2.6 Test Configuration

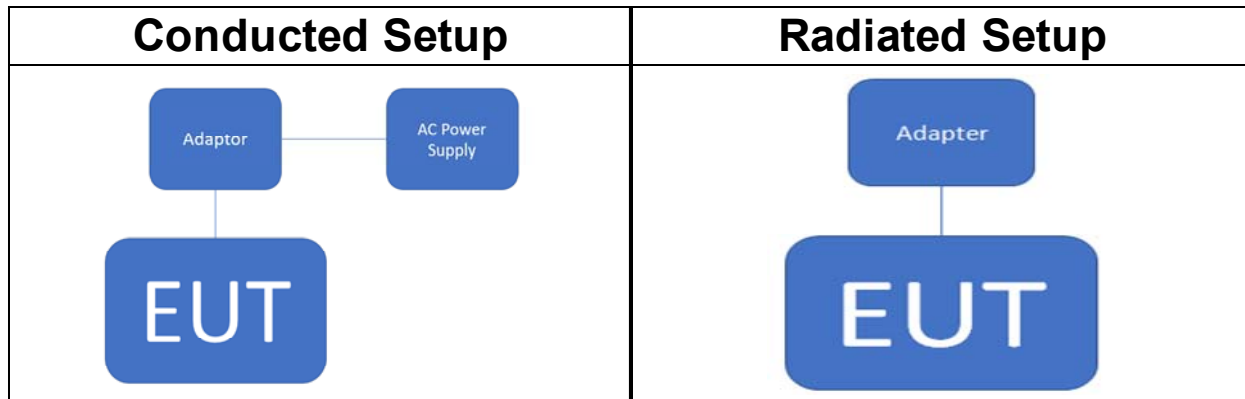

**Note:** Radio Communication Analyzer is placed in remote side for radiated test.

## 2.7 Control Unit(s)

Conducted Emission Test Site: Conducted 3					
EQUIPMENT TYPE	MFR	MODEL NUMBER	SERIAL NUMBER	LAST CAL.	CAL DUE.
Test Software	SGS	Radio Test Software	Ver. 21	N.C.R	N.C.R
Switching Adapter	Jiangxi JianAohai Technology	A929-120300W-US1	N/A	N/A	N/A
Radiated Emission Test Site: SAC 1					
EQUIPMENT TYPE	MFR	MODEL NUMBER	SERIAL NUMBER	LAST CAL.	CAL DUE.
SWITCHING ADAPTER	Jiangxi JianAohai Technology Co.,Ltd	A929-120300W-US1	N/A	N/A	N/A
Test Software	Audix	e3	Ver. 9.210322	N.C.R	N.C.R

Unless otherwise stated the results shown in this test report refer only to the sample(s) tested and such sample(s) are retained for 90 days only.

除非另有說明，此報告結果僅對測試之樣品負責，同時此樣品僅保留90天。本報告未經本公司書面許可，不可部份複製。

This document is issued by the Company subject to its General Conditions of Service printed overleaf, available on request or accessible at <http://www.sgs.com.tw/Terms-and-Conditions> and for electronic format documents, subject to Terms and Conditions for Electronic Documents at <http://www.sgs.com.tw/Terms-and-Conditions>. Attention is drawn to the limitation of liability, indemnification and jurisdiction issues defined therein. Any holder of this document is advised that information contained hereon reflects the Company's findings at the time of its intervention only and within the limits of Client's instructions, if any. The Company's sole responsibility is to its Client and this document does not exonerate parties to a transaction from exercising all their rights and obligations under the transaction documents. This document cannot be reproduced except in full, without prior written approval of the Company. Any unauthorized alteration, forgery or falsification of the content or appearance of this document is unlawful and offenders may be prosecuted to the fullest extent of the law.

### 3 SUMMARY OF TEST RESULTS

FCC Rules	Description Of Test	Result
§2.1046(a)	RF Power Output	Compliant
§22.913(a)(5) §27.50(d)(4)	ERP/ EIRP measurement	Compliant
§2.1049(h)	99% & 26dB Occupied Bandwidth	Compliant
§2.1051 §22.917(a) §27.53(h)	Out of Band Emissions at Antenna Terminals and Band Edge / Emission mask re- quirements	Compliant
§2.1053 §22.917(a) §27.53(h)	Field Strength of Spurious Radiation	Compliant
§27.50(a)(1)(B)	Peak to Average Ratio	Compliant
§2.1055(a)(1) §22.355 §27.54	Frequency Stability	Compliant

Unless otherwise stated the results shown in this test report refer only to the sample(s) tested and such sample(s) are retained for 90 days only.

除非另有說明，此報告結果僅對測試之樣品負責，同時此樣品僅保留90天。本報告未經本公司書面許可，不可部份複製。

This document is issued by the Company subject to its General Conditions of Service printed overleaf, available on request or accessible at <http://www.sgs.com.tw/Terms-and-Conditions> and for electronic format documents, subject to Terms and Conditions for Electronic Documents at <http://www.sgs.com.tw/Terms-and-Conditions>. Attention is drawn to the limitation of liability, indemnification and jurisdiction issues defined therein. Any holder of this document is advised that information contained hereon reflects the Company's findings at the time of its intervention only and within the limits of Client's instructions, if any. The Company's sole responsibility is to its Client and this document does not exonerate parties to a transaction from exercising all their rights and obligations under the transaction documents. This document cannot be reproduced except in full, without prior written approval of the Company. Any unauthorized alteration, forgery or falsification of the content or appearance of this document is unlawful and offenders may be prosecuted to the fullest extent of the law.

## 4 DESCRIPTION OF TEST MODES

### 4.1 The Test Channel Details

This device supports with carrier aggregation (two carrier) uplink, Intra-Band contiguous and Inter-Band non-contiguous specification as below:

E-UTRA Intra-Band CA configuration / Bandwidth combination set		
E-UTRA CA configuration	Component carriers in order of in-creasing carrier frequency Channel bandwidth for PCC and SCC [MHz]	Maximum ag-gregated band-width [MHz]
CA_5B	5+10 / 10+5	15
	10+10	20
CA_66B	5+5	10
	5+10 / 10+5	15
	5+15 / 15+5 / 10+10	20
CA_66C	5+20 / 20+5 / 10+15 / 15+10	25
	10+20 / 20+10 / 15+15	30
	15+20 / 20+15	35
	20+20	40

Unless otherwise stated the results shown in this test report refer only to the sample(s) tested and such sample(s) are retained for 90 days only.

除非另有說明，此報告結果僅對測試之樣品負責，同時此樣品僅保留90天。本報告未經本公司書面許可，不可部份複製。

This document is issued by the Company subject to its General Conditions of Service printed overleaf, available on request or accessible at <http://www.sgs.com.tw/Terms-and-Conditions> and for electronic format documents, subject to Terms and Conditions for Electronic Documents at <http://www.sgs.com.tw/Terms-and-Conditions>. Attention is drawn to the limitation of liability, indemnification and jurisdiction issues defined therein. Any holder of this document is advised that information contained hereon reflects the Company's findings at the time of its intervention only and within the limits of Client's instructions, if any. The Company's sole responsibility is to its Client and this document does not exonerate parties to a transaction from exercising all their rights and obligations under the transaction documents. This document cannot be reproduced except in full, without prior written approval of the Company. Any unauthorized alteration, forgery or falsification of the content or appearance of this document is unlawful and offenders may be prosecuted to the fullest extent of the law.

E-UTRA Inter-Band CA configuration / Bandwidth combination set									
Uplink CA configurations (NOTE 4)	E-UTRA Bands	1.4 MHz	3 MHz	5 MHz	10 MHz	15 MHz	20 MHz	Maximum aggregated bandwidth [MHz]	Bandwidth combination set
CA_2A-5A	2			Yes	Yes	Yes	Yes	30	0
	5			Yes	Yes				
	2			Yes	Yes			20	1
	5			Yes	Yes				
CA_2A_12A	2			Yes	Yes	Yes	Yes	30	0
	12			Yes	Yes				
	2			Yes	Yes	Yes	Yes	30	1
	12		Yes	Yes	Yes				
	2			Yes	Yes			20	2
	12			Yes	Yes				
CA_4A-5A	4			Yes	Yes			20	0
	5			Yes	Yes				
	4			Yes	Yes	Yes	Yes	30	1
	5			Yes	Yes				
CA_4A-12A	4	Yes	Yes	Yes	Yes			20	0
	12			Yes	Yes				
	4	Yes	Yes	Yes	Yes	Yes	Yes	30	1
	12			Yes	Yes				
	4			Yes	Yes	Yes	Yes	30	2
	12		Yes	Yes	Yes				
	4			Yes	Yes			20	3
	12			Yes	Yes				
	4			Yes	Yes	Yes	Yes	30	4
	12			Yes	Yes				
	4			Yes	Yes	Yes		20	5
12			Yes						
CA_12A-66A	12			Yes	Yes			20	0
	66	Yes	Yes	Yes	Yes				
	12			Yes	Yes			30	1
	66	Yes	Yes	Yes	Yes	Yes	Yes		
	12		Yes	Yes	Yes			30	2
	66			Yes	Yes	Yes	Yes		
	66			Yes	Yes			20	3
	12			Yes	Yes				
	66			Yes	Yes	Yes	Yes	30	4
	12			Yes					
66			Yes	Yes	Yes		20	5	
12			Yes						

Unless otherwise stated the results shown in this test report refer only to the sample(s) tested and such sample(s) are retained for 90 days only.

除非另有說明，此報告結果僅對測試之樣品負責，同時此樣品僅保留90天。本報告未經本公司書面許可，不可部份複製。

This document is issued by the Company subject to its General Conditions of Service printed overleaf, available on request or accessible at <http://www.sgs.com.tw/Terms-and-Conditions> and for electronic format documents, subject to Terms and Conditions for Electronic Documents at <http://www.sgs.com.tw/Terms-and-Conditions>. Attention is drawn to the limitation of liability, indemnification and jurisdiction issues defined therein. Any holder of this document is advised that information contained hereon reflects the Company's findings at the time of its intervention only and within the limits of Client's instructions, if any. The Company's sole responsibility is to its Client and this document does not exonerate parties to a transaction from exercising all their rights and obligations under the transaction documents. This document cannot be reproduced except in full, without prior written approval of the Company. Any unauthorized alteration, forgery or falsification of the content or appearance of this document is unlawful and offenders may be prosecuted to the fullest extent of the law.

## 4.2 The Worst-Case Test Modes and Details

1. Transmissions of each frequency bands are available by 4 antennas below, only one antenna can be enabled at any given time by each band, the EUT dose not support MIMO mode.
2. This EUT is UE LTE 4G 1Tx/4Rx device for single carrier that can support uplink Band 2/5/13/66.
3. The worst-case scenario for all measurements is based on the average conducted output power measurement investigation results. Output power measurements were measured on QPSK, 16QAM, 64QAM modulations. It was found that QPSK results the highest, hence all testing was performed using QPSK modulations to represent the worst case.
4. For occupied bandwidth, frequency stability and conducted unwanted emission measurements, due to each single LTE Band standalone transmission generates higher power than the **Inter-band** transmissions, the test results are only demonstrated for each single LTE band standalone transmission in test report ER/2022/30082 as the worst case scenarios.  
In addition, the radiated unwanted emissions of **inter-band** has been evaluated as no noticeable emissions, therefore, the conducted unwanted emissions was not tested.
5. For Band Edge and Emission Mask: The widest and narrowest BW combinations were tested. Combinations of same BW is considered equivalent. The RB combinations were selected as the signal activated closest to the band limit for determining the worst case scenario.
6. For Out of Band Emissions: The widest and narrowest RB combinations was tested to determine the worst case scenario with combinations generate higher emissions.
7. For peak to average ratio measurements, due to each single LTE Band standalone transmission generates higher power than the **Inter-band** transmissions, the test results are only demonstrated for each single LTE band standalone transmission in test report ER/2022/30082 as the worst case scenarios.
8. The field strength of radiated emission was measured as the EUT positioned in different orthogonal planes (E1/E2/H) based on actual usage of the EUT to pre-scan the emissions for determining the worst case scenario.

Unless otherwise stated the results shown in this test report refer only to the sample(s) tested and such sample(s) are retained for 90 days only.

除非另有說明，此報告結果僅對測試之樣品負責，同時此樣品僅保留90天。本報告未經本公司書面許可，不可部份複製。

This document is issued by the Company subject to its General Conditions of Service printed overleaf, available on request or accessible at <http://www.sgs.com.tw/Terms-and-Conditions> and for electronic format documents, subject to Terms and Conditions for Electronic Documents at <http://www.sgs.com.tw/Terms-and-Conditions>. Attention is drawn to the limitation of liability, indemnification and jurisdiction issues defined therein. Any holder of this document is advised that information contained hereon reflects the Company's findings at the time of its intervention only and within the limits of Client's instructions, if any. The Company's sole responsibility is to its Client and this document does not exonerate parties to a transaction from exercising all their rights and obligations under the transaction documents. This document cannot be reproduced except in full, without prior written approval of the Company. Any unauthorized alteration, forgery or falsification of the content or appearance of this document is unlawful and offenders may be prosecuted to the fullest extent of the law.



### 4.2.1 Intra-Band

For uplink Intra-Band CA, evaluation has been done for contiguous and non-contiguous channel and bandwidth, configurations that generates highest output power in standalone transmission have been selected for the final test.

Test Items	Band	Test Channel			Bandwidth (MHz)						Modulation			RB #						
		L	M	H	10	15	20	25	30	35	40	QPSK	16QAM	64QAM	Edge left + Edge right	Edge left + Edge left	Edge right + Edge right	Edge right + Edge left	Full	
Max. Output Power	5B	v	v	v		v	v					v	v	v					v	v
	66B	v	v	v	v	v	v					v	v	v					v	v
	66C	v	v	v				v	v	v	v	v	v	v					v	v
Frequency Stability	5B		v				v					v								v
	66B		v				v					v								v
	66C		v							v		v								v
26dB and 99% Bandwidth	5B		v			v	v					v	v	v						v
	66B		v		v	v	v					v	v	v						v
	66C		v					v	v	v	v	v	v	v						v
Peak-to-Average Ratio	5B		v			v	v					v	v							v
	66B		v		v	v	v					v	v							v
	66C		v					v	v	v	v	v	v							v
Band Edge	5B	v		v		v	v					v				v	v			v
	66B	v		v	v		v					v				v	v			v
	66C	v		v				v		v		v				v	v			v
Conducted Emission	5B	v	v	v		v	v					v								v
	66B	v	v	v	v	v	v					v								v
	66C	v	v	v						v		v								v
Radiated Emission	5B	v	v	v		v						v								v
	66B	v	v	v	v							v								v
	66C	v	v	v						v		v								v

### Radiated Emission

Band	Test Channel	Channel Bandwidth (MHz)	Modulation	PCC RB		SCC1 RB	
				Size	Offset	Size	Offset
5B	Low, Mid, High	5+10	QPSK	1	24	1	0
66C	Low, Mid, High	20+10	QPSK	1	99	1	0
66B	Low, Mid, High	5+5	QPSK	1	24	1	0

Unless otherwise stated the results shown in this test report refer only to the sample(s) tested and such sample(s) are retained for 90 days only.

除非另有說明，此報告結果僅對測試之樣品負責，同時此樣品僅保留90天。本報告未經本公司書面許可，不可部份複製。

This document is issued by the Company subject to its General Conditions of Service printed overleaf, available on request or accessible at <http://www.sgs.com.tw/Terms-and-Conditions> and for electronic format documents, subject to Terms and Conditions for Electronic Documents at <http://www.sgs.com.tw/Terms-and-Conditions>. Attention is drawn to the limitation of liability, indemnification and jurisdiction issues defined therein. Any holder of this document is advised that information contained hereon reflects the Company's findings at the time of its intervention only and within the limits of Client's instructions, if any. The Company's sole responsibility is to its Client and this document does not exonerate parties to a transaction from exercising all their rights and obligations under the transaction documents. This document cannot be reproduced except in full, without prior written approval of the Company. Any unauthorized alteration, forgery or falsification of the content or appearance of this document is unlawful and offenders may be prosecuted to the fullest extent of the law.

### 4.2.2 Inter-Band

For uplink Inter-Band CA configurations, following configurations have been selected for the final test.

Band	Test Channel	Channel Bandwidth (MHz)	Modulation	PCC RB		SCC1 RB	
				Size	Offset	Size	Offset
2A_5A	High_High	5_5	QPSK	1	0	1	0
2A_13A	Low_Mid	5_10	QPSK	1	0	1	0
2A_66A	Mid_Mid	5_20	QPSK	1	0	1	0
5A_66A	High_High	5_20	QPSK	1	0	1	0
13A_66A	Mid_Mid	10_20	QPSK	1	0	1	0
5A_13A	Low_Mid	5_10	QPSK	1	0	1	0

Unless otherwise stated the results shown in this test report refer only to the sample(s) tested and such sample(s) are retained for 90 days only.

除非另有說明，此報告結果僅對測試之樣品負責，同時此樣品僅保留90天。本報告未經本公司書面許可，不可部份複製。

This document is issued by the Company subject to its General Conditions of Service printed overleaf, available on request or accessible at <http://www.sgs.com.tw/Terms-and-Conditions> and for electronic format documents, subject to Terms and Conditions for Electronic Documents at <http://www.sgs.com.tw/Terms-and-Conditions>. Attention is drawn to the limitation of liability, indemnification and jurisdiction issues defined therein. Any holder of this document is advised that information contained hereon reflects the Company's findings at the time of its intervention only and within the limits of Client's instructions, if any. The Company's sole responsibility is to its Client and this document does not exonerate parties to a transaction from exercising all their rights and obligations under the transaction documents. This document cannot be reproduced except in full, without prior written approval of the Company. Any unauthorized alteration, forgery or falsification of the content or appearance of this document is unlawful and offenders may be prosecuted to the fullest extent of the law.

## 5 MEASUREMENT UNCERTAINTY

Test Items	Uncertainty
RF Power Output	+/- 1 dB
ERP/ EIRP measurement	+/- 3 dB
	+/- 3 dB
Emission Bandwidth	+/- 1.53 Hz
Out of Band Emissions at Antenna Terminals and Band Edge	+/- 1.68 dB
Peak to Average Ratio	+/- 1 dB
Frequency Stability vs. Temperature	+/- 1.53 Hz
Frequency Stability vs. Voltage	+/- 1.53 Hz
Temperature	+/- 0.4 °C
Humidity	+/- 3.5 %
DC / AC Power Source	+/- 1 %

Radiated Spurious Emission Measurement Uncertainty		
Polarization: Vertical	+/- 2.57 dB	9kHz~30MHz
	+/- 4.85 dB	30MHz - 1000MHz
	+/- 4.45 dB	1GHz - 18GHz
	+/- 4.24 dB	18GHz - 40GHz
Polarization: Horizontal	+/- 2.57 dB	9kHz~30MHz
	+/- 4.37 dB	30MHz - 1000MHz
	+/- 4.45 dB	1GHz - 18GHz
	+/- 4.24 dB	18GHz - 40GHz

This uncertainty represents an expanded uncertainty expressed at approximately the 95% confidence level using a coverage factor of k=2.

Unless otherwise stated the results shown in this test report refer only to the sample(s) tested and such sample(s) are retained for 90 days only.

除非另有說明，此報告結果僅對測試之樣品負責，同時此樣品僅保留90天。本報告未經本公司書面許可，不可部份複製。

This document is issued by the Company subject to its General Conditions of Service printed overleaf, available on request or accessible at <http://www.sgs.com.tw/Terms-and-Conditions> and for electronic format documents, subject to Terms and Conditions for Electronic Documents at <http://www.sgs.com.tw/Terms-and-Conditions>. Attention is drawn to the limitation of liability, indemnification and jurisdiction issues defined therein. Any holder of this document is advised that information contained hereon reflects the Company's findings at the time of its intervention only and within the limits of Client's instructions, if any. The Company's sole responsibility is to its Client and this document does not exonerate parties to a transaction from exercising all their rights and obligations under the transaction documents. This document cannot be reproduced except in full, without prior written approval of the Company. Any unauthorized alteration, forgery or falsification of the content or appearance of this document is unlawful and offenders may be prosecuted to the fullest extent of the law.

## 6 MEASUREMENT EQUIPMENT USED

### 6.1 Conducted Measurement

Conducted Emission Test Site: Conducted 3					
EQUIPMENT TYPE	MFR	MODEL NUMBER	SERIAL NUMBER	LAST CAL.	CAL DUE.
EXA Spectrum Analyzer	Agilent	N9010A	MY54200716	10/13/2021	10/12/2022
Radio Communication Analyer	Anritsu	MT8821C	6261786084	01/18/2022	01/17/2023
Temperature Chamber	Giant Force	GTH-150-40-CP-AR	MAA0512-018	05/19/2021	05/18/2022
AC Power Source	Gwinstek	APS-7050E	GEV171679	09/28/2021	09/27/2022
Attenuator	Mini-Circuit	BW-S10W2+	4	12/14/2021	12/13/2022
DC Block	Mini-Circuits	BLK-18-S+	1	12/14/2021	12/13/2022
Power Divider	RF-LAMBAD	RFLT2W1G18G	11-JSPF412-020	12/14/2021	12/13/2022

### 6.2 Radiated Measurement

Radiated Emission Test Site: SAC 1					
EQUIPMENT TYPE	MFR	MODEL NUMBER	SERIAL NUMBER	LAST CAL.	CAL DUE.
Bi-log Antenna	SCHWARZBECK	VULB9168	300	10/19/2021	10/18/2022
Horn Antenna	SCHWARZBECK	BBHA9120D	D803	12/20/2021	12/19/2022
Bi-log Antenna	TESEO	CBL 6112D	35242 & AT-N0555	01/03/2022	01/02/2023
Horn Antenna	SCHWARZBECK	BBHA9120D	603	05/18/2021	05/17/2022
Horn Antenna	SCHWARZBECK	BBHA9170	184	12/16/2021	12/15/2022
Horn Antenna	SCHWARZBECK	BBHA9170	185	08/06/2021	08/05/2022
Site Cal	SGS	SAC I chamber	N/A	01/01/2022	12/31/2022
EXA Spectrum Analyzer	KEYSIGHT	N9010B	MY59071541	07/14/2021	07/13/2022
Signal Generator	R&S	SMBV100A	263084	01/11/2022	01/10/2023
Radio Communication Analyer	Anritsu	MT8821C	6261786084	01/18/2022	01/17/2023
Pre-Amplifier	EMC Instruments	EMC184045B	980135	10/27/2021	10/26/2022
Pre-Amplifier	HP	8449B	3008A01973	12/16/2021	12/15/2022
Pre-Amplifier	HP	8447D	2944A09469	12/16/2021	12/15/2022
Bandreject Filter 800-1000	Micro-Tronics	EWT	M1	12/14/2021	12/13/2022
1.3G-15GHz High Pass Filter	WI	WHKX10-1066-80SS	19	12/14/2021	12/13/2022
Bandreject Filter 1700-2000	Micro-Tronics	EWT	M3	12/14/2021	12/13/2022

Unless otherwise stated the results shown in this test report refer only to the sample(s) tested and such sample(s) are retained for 90 days only.

除非另有說明，此報告結果僅對測試之樣品負責，同時此樣品僅保留90天。本報告未經本公司書面許可，不可部份複製。

This document is issued by the Company subject to its General Conditions of Service printed overleaf, available on request or accessible at <http://www.sgs.com.tw/Terms-and-Conditions> and for electronic format documents, subject to Terms and Conditions for Electronic Documents at <http://www.sgs.com.tw/Terms-and-Conditions>. Attention is drawn to the limitation of liability, indemnification and jurisdiction issues defined therein. Any holder of this document is advised that information contained hereon reflects the Company's findings at the time of its intervention only and within the limits of Client's instructions, if any. The Company's sole responsibility is to its Client and this document does not exonerate parties to a transaction from exercising all their rights and obligations under the transaction documents. This document cannot be reproduced except in full, without prior written approval of the Company. Any unauthorized alteration, forgery or falsification of the content or appearance of this document is unlawful and offenders may be prosecuted to the fullest extent of the law.

## 7 MAXIMUM OUTPUT POWER

### 7.1 Standard Applicable

A base station simulator was used to establish communication with the EUT. Its parameters were set to transmit the maximum power on the EUT. The measured power in the radio frequency on the transmitter output terminals.

#### 7.1.1 ERP/EIRP LIMIT

According to FCC §2.1046

##### FCC 22.913(a)

(5) mobile transmitters and auxiliary test transmitters must not exceed 7 watts.

##### FCC 27.50(d)

(4) Mobile, and portable (hand-held) stations operating in the 1710-1755 MHz, 1695-1710 MHz and 1755-1780 MHz bands are limited to 1W EIRP.

### 7.2 Test Set-up

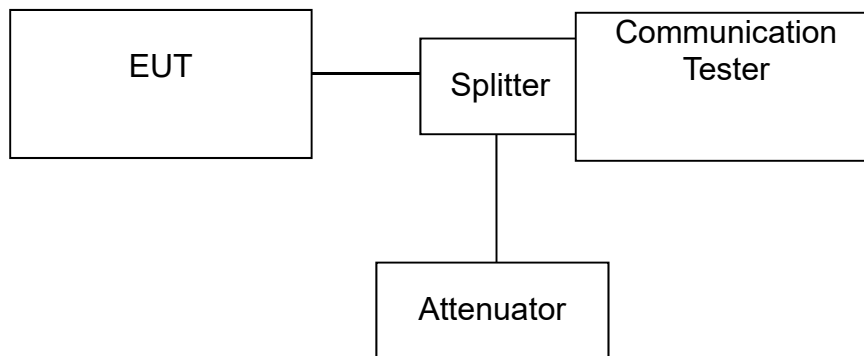

**Note:** Measurement setup for testing on Antenna connector

Unless otherwise stated the results shown in this test report refer only to the sample(s) tested and such sample(s) are retained for 90 days only.

除非另有說明，此報告結果僅對測試之樣品負責，同時此樣品僅保留90天。本報告未經本公司書面許可，不可部份複製。

This document is issued by the Company subject to its General Conditions of Service printed overleaf, available on request or accessible at <http://www.sgs.com.tw/Terms-and-Conditions> and for electronic format documents, subject to Terms and Conditions for Electronic Documents at <http://www.sgs.com.tw/Terms-and-Conditions>. Attention is drawn to the limitation of liability, indemnification and jurisdiction issues defined therein. Any holder of this document is advised that information contained hereon reflects the Company's findings at the time of its intervention only and within the limits of Client's instructions, if any. The Company's sole responsibility is to its Client and this document does not exonerate parties to a transaction from exercising all their rights and obligations under the transaction documents. This document cannot be reproduced except in full, without prior written approval of the Company. Any unauthorized alteration, forgery or falsification of the content or appearance of this document is unlawful and offenders may be prosecuted to the fullest extent of the law.

### 7.3 Output Power Measurement Applicable Guidance

The transmitter output was connected to a calibrated attenuator, the other end of which was connected to a power meter. Transmitter output was read off the power meter in dBm. The power output at the transmitter antenna port was determined by adding the value of the attenuator to the power meter reading.

The Procedure of KDB941225 (SAR Measurement Procedures for 3G devices, (WCDMA/HSPA) was used for EUT and Base station setting. RMC 12.2kps is used for this testing, and KDB 971168 D01 Power Meas License Digital System as the supplemental test methodology to adjust the proper setting obtaining the measurement results.

All LTE bands conducted average power is obtained from the simulator telecommunication test set.

### 7.4 Determining ERP and/or EIRP from conducted RF output power measurements

According to KDB 412172 D01 Power Approach,

$$EIRP = P_T + G_T - L_C,$$

$$ERP = EIRP - 2.15,$$

Where:

ERP or EIRP = effective radiated power or equivalent isotropically radiated power (expressed in the same units as  $P_T$ , typically dBW, dBm, or power spectral density (PSD)<sup>2</sup>), relative to either a dipole antenna (ERP) or an isotropic antenna (EIRP);

$P_T$  = transmitter output power, expressed in dBW, dBm, or PSD;

$G_T$  = gain of the transmitting antenna, in dBd (ERP) or dBi (EIRP);

$L_C$  = signal attenuation in the connecting cable between the transmitter and antenna, in dB.

Unless otherwise stated the results shown in this test report refer only to the sample(s) tested and such sample(s) are retained for 90 days only.

除非另有說明，此報告結果僅對測試之樣品負責，同時此樣品僅保留90天。本報告未經本公司書面許可，不可部份複製。

This document is issued by the Company subject to its General Conditions of Service printed overleaf, available on request or accessible at <http://www.sgs.com.tw/Terms-and-Conditions> and for electronic format documents, subject to Terms and Conditions for Electronic Documents at <http://www.sgs.com.tw/Terms-and-Conditions>. Attention is drawn to the limitation of liability, indemnification and jurisdiction issues defined therein. Any holder of this document is advised that information contained hereon reflects the Company's findings at the time of its intervention only and within the limits of Client's instructions, if any. The Company's sole responsibility is to its Client and this document does not exonerate parties to a transaction from exercising all their rights and obligations under the transaction documents. This document cannot be reproduced except in full, without prior written approval of the Company. Any unauthorized alteration, forgery or falsification of the content or appearance of this document is unlawful and offenders may be prosecuted to the fullest extent of the law.

## 7.5 LTE Measurement Results:

### 7.5.1 Intra-Band

Part 22 / RSS 132_ ERP Limit (W)		7		OUTPUT POWER FOR LTE BAND 5B (5MHz + 10MHz)											
Antenna Gain		-2.41266													
Bandwidth	PCC		SCC1		Modulation	PCC RB		SCC1 RB		Conducted Average (dBm)			EIRP Average	ERP Average	ERP Average
	Earfcn	MHz	Earfcn	MHz		Size	Offset	Size	Offset	PCC	SCC1	Total	(dBm)	(dBm)	(W)
5MHz+ 10MHz	20428	826.8	20500	834.0	QPSK	1	24	1	0	20.73	21.80	23.74	21.33	19.18	0.083
						25	0	50	0	18.89	18.81	21.83	19.42	17.27	0.053
	20478	831.8	20550	839.0	QPSK	1	24	1	0	20.80	21.82	23.81	21.40	19.25	0.084
						25	0	50	0	18.80	18.78	21.78	19.37	17.22	0.053
	20528	836.8	20600	844.0	QPSK	1	24	1	0	20.71	21.80	23.75	21.34	19.19	0.083
						25	0	50	0	18.74	18.79	21.75	19.34	17.19	0.052
5MHz+ 10MHz	20428	826.8	20500	834.0	16QAM	1	24	1	0	19.85	20.61	22.79	20.38	18.23	0.066
						25	0	50	0	17.90	17.80	20.84	18.43	16.28	0.042
	20478	831.8	20550	839.0	16QAM	1	24	1	0	19.97	20.67	22.82	20.41	18.26	0.067
						25	0	50	0	17.89	17.79	20.83	18.42	16.27	0.042
	20528	836.8	20600	844.0	16QAM	1	24	1	0	19.51	20.88	22.69	20.28	18.13	0.065
						25	0	50	0	17.71	17.73	20.73	18.32	16.17	0.041
5MHz+ 10MHz	20428	826.8	20500	834.0	64QAM	1	24	1	0	18.59	19.92	21.74	19.33	17.18	0.052
						25	0	50	0	17.90	17.79	20.82	18.41	16.26	0.042
	20478	831.8	20550	839.0	64QAM	1	24	1	0	18.88	19.78	21.79	19.38	17.23	0.053
						25	0	50	0	17.84	17.79	20.80	18.39	16.24	0.042
	20528	836.8	20600	844.0	64QAM	1	24	1	0	19.02	19.88	21.88	19.47	17.32	0.054
						25	0	50	0	17.73	17.71	20.71	18.30	16.15	0.041
Part 22 / RSS 132_ ERP Limit (W)		7		OUTPUT POWER FOR LTE BAND 5B (10MHz + 5MHz)											
Antenna Gain		-2.41266													
Bandwidth	PCC		SCC1		Modulation	PCC RB		SCC1 RB		Conducted Average (dBm)			EIRP Average	ERP Average	ERP Average
	Earfcn	MHz	Earfcn	MHz		Size	Offset	Size	Offset	PCC	SCC1	Total	(dBm)	(dBm)	(W)
10MHz+ 5MHz	20450	829.0	20522	836.2	QPSK	1	49	1	0	22.00	20.69	23.71	21.30	19.15	0.082
						50	0	25	0	18.05	18.71	21.77	19.36	17.21	0.053
	20500	834.0	20572	841.2	QPSK	1	49	1	0	21.67	20.51	23.54	21.13	18.98	0.079
						50	0	25	0	18.91	18.74	21.80	19.39	17.24	0.053
	20550	839.0	20622	846.2	QPSK	1	49	1	0	21.83	20.71	23.71	21.30	19.15	0.082
						50	0	25	0	18.83	18.74	21.76	19.35	17.20	0.052
10MHz+ 5MHz	20450	829.0	20522	836.2	16QAM	1	49	1	0	20.94	19.82	22.86	20.45	18.30	0.068
						50	0	25	0	17.84	17.84	20.82	18.41	16.26	0.042
	20500	834.0	20572	841.2	16QAM	1	49	1	0	20.96	19.52	22.70	20.29	18.14	0.065
						50	0	25	0	17.86	17.76	20.78	18.37	16.22	0.042
	20550	839.0	20622	846.2	16QAM	1	49	1	0	21.12	19.56	22.79	20.38	18.23	0.066
						50	0	25	0	17.85	17.65	20.74	18.33	16.18	0.041
10MHz+ 5MHz	20450	829.0	20522	836.2	64QAM	1	49	1	0	19.91	18.66	21.87	19.46	17.31	0.054
						50	0	25	0	17.87	17.68	20.75	18.34	16.19	0.042
	20500	834.0	20572	841.2	64QAM	1	49	1	0	19.99	18.91	21.93	19.52	17.37	0.055
						50	0	25	0	17.82	17.67	20.73	18.32	16.17	0.041
	20550	839.0	20622	846.2	64QAM	1	49	1	0	19.87	18.77	21.77	19.36	17.21	0.053
						50	0	25	0	17.85	17.62	20.72	18.31	16.16	0.041

Unless otherwise stated the results shown in this test report refer only to the sample(s) tested and such sample(s) are retained for 90 days only.

除非另有說明，此報告結果僅對測試之樣品負責，同時此樣品僅保留90天。本報告未經本公司書面許可，不可部份複製。

This document is issued by the Company subject to its General Conditions of Service printed overleaf, available on request or accessible at <http://www.sgs.com.tw/Terms-and-Conditions> and for electronic format documents, subject to Terms and Conditions for Electronic Documents at <http://www.sgs.com.tw/Terms-and-Conditions>. Attention is drawn to the limitation of liability, indemnification and jurisdiction issues defined therein. Any holder of this document is advised that information contained hereon reflects the Company's findings at the time of its intervention only and within the limits of Client's instructions, if any. The Company's sole responsibility is to its Client and this document does not exonerate parties to a transaction from exercising all their rights and obligations under the transaction documents. This document cannot be reproduced except in full, without prior written approval of the Company. Any unauthorized alteration, forgery or falsification of the content or appearance of this document is unlawful and offenders may be prosecuted to the fullest extent of the law.

Part 22 / RSS 132_ ERP Limit (W)	7
Antenna Gain	-2.41266

**OUTPUT POWER FOR LTE BAND 5B (10MHz + 10MHz)**

Bandwidth	PCC		SCC1		Modulation	PCC RB		SCC1 RB		Conducted Average (dBm)			EIRP Average	ERP Average	ERP Average
	Earfcn	MHz	Earfcn	MHz		Size	Offset	Size	Offset	PCC	SCC1	Total	(dBm)	(dBm)	(W)
10MHz+ 10MHz	20450	829.0	20549	838.9	QPSK	1	49	1	0	20.43	20.43	23.44	21.03	18.88	0.077
						50	0	50	0	18.67	18.59	21.64	19.23	17.08	0.051
	20476	831.6	20575	841.5	QPSK	1	49	1	0	20.51	20.58	23.55	21.14	18.99	0.079
						50	0	50	0	18.67	18.55	21.62	19.21	17.06	0.051
	20501	834.1	20600	844.0	QPSK	1	49	1	0	20.52	20.48	23.51	21.10	18.95	0.078
						50	0	50	0	18.62	18.60	21.62	19.21	17.06	0.051
10MHz+ 10MHz	20450	829.0	20549	838.9	16QAM	1	49	1	0	19.59	19.50	22.55	20.14	17.99	0.063
						50	0	50	0	17.67	17.66	20.68	18.27	16.12	0.041
	20476	831.6	20575	841.5	16QAM	1	49	1	0	19.59	19.76	22.69	20.28	18.13	0.065
						50	0	50	0	17.67	17.54	20.62	18.21	16.06	0.040
	20501	834.1	20600	844.0	16QAM	1	49	1	0	19.59	19.22	22.42	20.01	17.86	0.061
						50	0	50	0	17.60	17.63	20.62	18.21	16.06	0.040
10MHz+ 10MHz	20450	829.0	20549	838.9	64QAM	1	49	1	0	18.67	18.44	21.57	19.16	17.01	0.050
						50	0	50	0	17.63	17.60	20.62	18.21	16.06	0.040
	20476	831.6	20575	841.5	64QAM	1	49	1	0	18.76	18.56	21.67	19.26	17.11	0.051
						50	0	50	0	17.63	17.54	20.60	18.19	16.04	0.040
	20501	834.1	20600	844.0	64QAM	1	49	1	0	18.75	18.35	21.56	19.15	17.00	0.050
						50	0	50	0	17.66	17.58	20.63	18.22	16.07	0.040

Part 27 / RSS 139_ EIRP Limit (W)	1
Antenna Gain	-0.89447

**OUTPUT POWER FOR LTE BAND 66B (5MHz + 5MHz)**

Bandwidth	PCC		SCC1		Modulation	PCC RB		SCC1 RB		Conducted Average (dBm)			EIRP Average	EIRP Average
	Earfcn	MHz	Earfcn	MHz		Size	Offset	Size	Offset	PCC	SCC1	Total	(dBm)	(W)
5MHz+ 5MHz	131997	1712.5	132045	1717.3	QPSK	1	24	1	0	20.20	20.25	23.22	22.33	0.171
						25	0	25	0	18.35	18.31	21.34	20.45	0.111
	132398	1752.6	132446	1757.4	QPSK	1	24	1	0	20.52	20.45	23.49	22.60	0.182
						25	0	25	0	18.53	18.54	21.55	20.66	0.116
	132599	1772.7	132647	1777.5	QPSK	1	24	1	0	20.85	19.85	23.38	22.49	0.177
						25	0	25	0	18.45	18.38	21.43	20.54	0.113
5MHz+ 5MHz	131997	1712.5	132045	1717.3	16QAM	1	24	1	0	19.34	19.54	22.44	21.55	0.143
						25	0	25	0	17.42	17.34	20.39	19.50	0.089
	132398	1752.6	132446	1757.4	16QAM	1	24	1	0	19.38	19.47	22.43	21.54	0.142
						25	0	25	0	17.53	17.46	20.51	19.62	0.092
	132599	1772.7	132647	1777.5	16QAM	1	24	1	0	19.18	19.54	22.36	21.47	0.140
						25	0	25	0	17.53	17.44	20.49	19.60	0.091
5MHz+ 5MHz	131997	1712.5	132045	1717.3	64QAM	1	24	1	0	18.41	18.27	21.34	20.45	0.111
						25	0	25	0	17.42	17.25	20.35	19.46	0.088
	132398	1752.6	132446	1757.4	64QAM	1	24	1	0	18.61	18.82	21.72	20.83	0.121
						25	0	25	0	17.52	17.50	20.52	19.63	0.092
	132599	1772.7	132647	1777.5	64QAM	1	24	1	0	18.56	18.27	21.42	20.53	0.113
						25	0	25	0	17.44	17.48	20.47	19.58	0.091

Unless otherwise stated the results shown in this test report refer only to the sample(s) tested and such sample(s) are retained for 90 days only.

除非另有說明，此報告結果僅對測試之樣品負責，同時此樣品僅保留90天。本報告未經本公司書面許可，不可部份複製。

This document is issued by the Company subject to its General Conditions of Service printed overleaf, available on request or accessible at <http://www.sgs.com.tw/Terms-and-Conditions> and for electronic format documents, subject to Terms and Conditions for Electronic Documents at <http://www.sgs.com.tw/Terms-and-Conditions>. Attention is drawn to the limitation of liability, indemnification and jurisdiction issues defined therein. Any holder of this document is advised that information contained hereon reflects the Company's findings at the time of its intervention only and within the limits of Client's instructions, if any. The Company's sole responsibility is to its Client and this document does not exonerate parties to a transaction from exercising all their rights and obligations under the transaction documents. This document cannot be reproduced except in full, without prior written approval of the Company. Any unauthorized alteration, forgery or falsification of the content or appearance of this document is unlawful and offenders may be prosecuted to the fullest extent of the law.



Part 27 / RSS 139_ EIRP Limit (W)	1
Antenna Gain	-0.89447

**OUTPUT POWER FOR LTE BAND 66B (5MHz + 10MHz)**

Bandwidth	PCC		SCC1		Modulation	PCC RB		SCC1 RB		Conducted Average (dBm)			EIRP Average	EIRP Average
	Earfcn	MHz	Earfcn	MHz		Size	Offset	Size	Offset	PCC	SCC1	Total	(dBm)	(W)
5MHz+ 10MHz	132000	1712.8	132072	1720.0	QPSK	1	24	1	0	20.13	21.49	23.15	22.26	0.168
						25	0	50	0	18.23	18.25	21.23	20.34	0.108
	132375	1750.3	132447	1757.5	QPSK	1	24	1	0	20.22	21.34	23.24	22.35	0.172
						25	0	50	0	18.35	18.46	21.39	20.50	0.112
	132550	1767.8	132622	1775.0	QPSK	1	24	1	0	20.12	21.48	23.14	22.25	0.168
						25	0	50	0	18.41	18.44	21.41	20.52	0.113
5MHz+ 10MHz	132000	1712.8	132072	1720.0	16QAM	1	24	1	0	19.25	20.27	22.26	21.37	0.137
						25	0	50	0	17.32	17.30	20.29	19.40	0.087
	132375	1750.3	132447	1757.5	16QAM	1	24	1	0	19.54	20.64	22.58	21.69	0.147
						25	0	50	0	17.31	17.36	20.32	19.43	0.088
	132550	1767.8	132622	1775.0	16QAM	1	24	1	0	19.49	20.55	22.49	21.60	0.144
						25	0	50	0	17.45	17.36	20.39	19.50	0.089
5MHz+ 10MHz	132000	1712.8	132072	1720.0	64QAM	1	24	1	0	18.10	19.59	21.38	20.49	0.112
						25	0	50	0	17.21	17.29	20.24	19.35	0.086
	132375	1750.3	132447	1757.5	64QAM	1	24	1	0	18.28	19.61	21.32	20.43	0.110
						25	0	50	0	17.53	17.45	20.48	19.59	0.091
	132550	1767.8	132622	1775.0	64QAM	1	24	1	0	18.10	19.55	21.30	20.41	0.110
						25	0	50	0	17.42	17.47	20.43	19.54	0.090

Part 27 / RSS 139_ EIRP Limit (W)	1
Antenna Gain	-0.89447

**OUTPUT POWER FOR LTE BAND 66B (10MHz + 5MHz)**

Bandwidth	PCC		SCC1		Modulation	PCC RB		SCC1 RB		Conducted Average (dBm)			EIRP Average	EIRP Average
	Earfcn	MHz	Earfcn	MHz		Size	Offset	Size	Offset	PCC	SCC1	Total	(dBm)	(W)
10MHz+ 5MHz	132022	1715.0	132094	1722.2	QPSK	1	49	1	0	21.20	20.21	23.25	22.36	0.172
						50	0	25	0	18.27	18.29	21.27	20.38	0.109
	132397	1752.5	132469	1759.7	QPSK	1	49	1	0	21.43	20.34	23.36	22.47	0.176
						50	0	25	0	18.39	18.32	21.34	20.45	0.111
	132572	1770.0	132644	1777.2	QPSK	1	49	1	0	21.42	20.50	23.48	22.59	0.181
						50	0	25	0	18.39	18.31	21.33	20.44	0.111
10MHz+ 5MHz	132022	1715.0	132094	1722.2	16QAM	1	49	1	0	20.49	19.20	22.22	21.33	0.136
						50	0	25	0	17.26	17.30	20.27	19.38	0.087
	132397	1752.5	132469	1759.7	16QAM	1	49	1	0	20.47	19.31	22.27	21.38	0.137
						50	0	25	0	17.38	17.33	20.34	19.45	0.088
	132572	1770.0	132644	1777.2	16QAM	1	49	1	0	20.35	19.66	22.42	21.53	0.142
						50	0	25	0	17.42	17.37	20.39	19.50	0.089
10MHz+ 5MHz	132022	1715.0	132094	1722.2	64QAM	1	49	1	0	19.52	18.65	21.53	20.64	0.116
						50	0	25	0	17.33	17.29	20.30	19.41	0.087
	132397	1752.5	132469	1759.7	64QAM	1	49	1	0	19.60	18.46	21.47	20.58	0.114
						50	0	25	0	17.47	17.34	20.39	19.50	0.089
	132572	1770.0	132644	1777.2	64QAM	1	49	1	0	19.63	18.39	21.43	20.54	0.113
						50	0	25	0	17.51	17.35	20.42	19.53	0.090

Unless otherwise stated the results shown in this test report refer only to the sample(s) tested and such sample(s) are retained for 90 days only.

除非另有說明，此報告結果僅對測試之樣品負責，同時此樣品僅保留90天。本報告未經本公司書面許可，不可部份複製。

This document is issued by the Company subject to its General Conditions of Service printed overleaf, available on request or accessible at <http://www.sgs.com.tw/Terms-and-Conditions> and for electronic format documents, subject to Terms and Conditions for Electronic Documents at <http://www.sgs.com.tw/Terms-and-Conditions>. Attention is drawn to the limitation of liability, indemnification and jurisdiction issues defined therein. Any holder of this document is advised that information contained hereon reflects the Company's findings at the time of its intervention only and within the limits of Client's instructions, if any. The Company's sole responsibility is to its Client and this document does not exonerate parties to a transaction from exercising all their rights and obligations under the transaction documents. This document cannot be reproduced except in full, without prior written approval of the Company. Any unauthorized alteration, forgery or falsification of the content or appearance of this document is unlawful and offenders may be prosecuted to the fullest extent of the law.

Part 27 / RSS 139_ EIRP Limit (W)		1												
Antenna Gain		-0.89447												
OUTPUT POWER FOR LTE BAND 66B (5MHz + 15MHz)														
Bandwidth	PCC		SCC1		Modulation	PCC RB		SCC1 RB		Conducted Average (dBm)			EIRP Average	EIRP Average
	Earfcn	MHz	Earfcn	MHz		Size	Offset	Size	Offset	PCC	SCC1	Total	(dBm)	(W)
5MHz+ 15MHz	132002	1713.0	132095	1722.3	QPSK	1	24	1	0	20.09	20.17	23.11	22.22	0.167
						25	0	75	0	18.20	18.67	21.24	20.35	0.108
	132353	1748.1	132446	1757.4	QPSK	1	24	1	0	19.86	20.72	23.38	22.49	0.177
						25	0	75	0	18.43	18.78	21.42	20.53	0.113
	132504	1763.2	132597	1772.5	QPSK	1	24	1	0	20.25	20.02	23.26	22.37	0.172
						25	0	75	0	18.38	18.72	21.35	20.46	0.111
5MHz+ 15MHz	132002	1713.0	132095	1722.3	16QAM	1	24	1	0	19.48	19.16	22.28	21.39	0.138
						25	0	75	0	17.25	17.64	20.27	19.38	0.087
	132353	1748.1	132446	1757.4	16QAM	1	24	1	0	19.57	19.25	22.59	21.70	0.148
						25	0	75	0	17.46	17.76	20.41	19.52	0.089
	132504	1763.2	132597	1772.5	16QAM	1	24	1	0	19.31	19.18	22.25	21.36	0.137
						25	0	75	0	17.42	17.81	20.41	19.52	0.089
5MHz+ 15MHz	132002	1713.0	132095	1722.3	64QAM	1	24	1	0	18.54	18.35	21.46	20.57	0.114
						25	0	75	0	17.14	17.67	20.23	19.34	0.086
	132353	1748.1	132446	1757.4	64QAM	1	24	1	0	18.72	18.29	21.54	20.65	0.116
						25	0	75	0	17.36	17.77	20.38	19.49	0.089
	132504	1763.2	132597	1772.5	64QAM	1	24	1	0	18.84	18.61	21.46	20.57	0.114
						25	0	75	0	17.29	17.79	20.35	19.46	0.088

Part 27 / RSS 139_ EIRP Limit (W)		1												
Antenna Gain		-0.89447												
OUTPUT POWER FOR LTE BAND 66B (15MHz + 5MHz)														
Bandwidth	PCC		SCC1		Modulation	PCC RB		SCC1 RB		Conducted Average (dBm)			EIRP Average	EIRP Average
	Earfcn	MHz	Earfcn	MHz		Size	Offset	Size	Offset	PCC	SCC1	Total	(dBm)	(W)
15MHz+ 5MHz	132047	1717.5	132140	1726.8	QPSK	1	74	1	0	20.47	19.63	23.13	22.24	0.167
						75	0	25	0	18.65	18.25	21.26	20.37	0.109
	132398	1752.6	132491	1761.9	QPSK	1	74	1	0	20.66	19.79	23.30	22.41	0.174
						75	0	25	0	18.81	18.31	21.37	20.48	0.112
	132549	1767.7	132642	1777.0	QPSK	1	74	1	0	20.38	20.47	23.42	22.53	0.179
						75	0	25	0	18.81	18.29	21.37	20.48	0.112
15MHz+ 5MHz	132047	1717.5	132140	1726.8	16QAM	1	74	1	0	19.25	19.35	22.24	21.35	0.136
						75	0	25	0	17.66	17.30	20.29	19.40	0.087
	132398	1752.6	132491	1761.9	16QAM	1	74	1	0	19.39	19.46	22.48	21.59	0.144
						75	0	25	0	17.77	17.33	20.36	19.47	0.088
	132549	1767.7	132642	1777.0	16QAM	1	74	1	0	19.61	19.65	22.65	21.76	0.150
						75	0	25	0	17.79	17.34	20.35	19.46	0.088
15MHz+ 5MHz	132047	1717.5	132140	1726.8	64QAM	1	74	1	0	18.28	18.33	21.32	20.43	0.110
						75	0	25	0	17.64	17.27	20.27	19.38	0.087
	132398	1752.6	132491	1761.9	64QAM	1	74	1	0	18.58	18.08	21.46	20.57	0.114
						75	0	25	0	17.75	17.33	20.35	19.46	0.088
	132549	1767.7	132642	1777.0	64QAM	1	74	1	0	18.23	18.80	21.49	20.60	0.115
						75	0	25	0	17.71	17.34	20.33	19.44	0.088

Unless otherwise stated the results shown in this test report refer only to the sample(s) tested and such sample(s) are retained for 90 days only.  
 除非另有說明，此報告結果僅對測試之樣品負責，同時此樣品僅保留90天。本報告未經本公司書面許可，不可部份複製。  
 This document is issued by the Company subject to its General Conditions of Service printed overleaf, available on request or accessible at <http://www.sgs.com.tw/Terms-and-Conditions> and for electronic format documents, subject to Terms and Conditions for Electronic Documents at <http://www.sgs.com.tw/Terms-and-Conditions>. Attention is drawn to the limitation of liability, indemnification and jurisdiction issues defined therein. Any holder of this document is advised that information contained hereon reflects the Company's findings at the time of its intervention only and within the limits of Client's instructions, if any. The Company's sole responsibility is to its Client and this document does not exonerate parties to a transaction from exercising all their rights and obligations under the transaction document. This document cannot be reproduced except in full, without prior written approval of the Company. Any unauthorized alteration, forgery or falsification of the content or appearance of this document is unlawful and offenders may be prosecuted to the fullest extent of the law.

Part 27 / RSS 139_ EIRP Limit (W)	1
Antenna Gain	-0.89447

**OUTPUT POWER FOR LTE BAND 66B (10MHz + 10MHz)**

Bandwidth	PCC		SCC1		Modulation	PCC RB		SCC1 RB		Conducted Average (dBm)			EIRP Average	EIRP Average
	Earfcn	MHz	Earfcn	MHz		Size	Offset	Size	Offset	PCC	SCC1	Total	(dBm)	(W)
10MHz+ 10MHz	132022	1715.0	132121	1724.9	QPSK	1	49	1	0	20.10	20.08	23.10	22.21	0.166
						50	0	50	0	18.16	18.23	21.21	20.32	0.108
	132373	1750.1	132472	1760.0	QPSK	1	49	1	0	20.33	20.30	23.32	22.43	0.175
						50	0	50	0	18.35	18.35	21.36	20.47	0.111
	132523	1765.1	132622	1775.0	QPSK	1	49	1	0	20.28	20.30	23.30	22.41	0.174
						50	0	50	0	18.36	18.34	21.36	20.47	0.111
10MHz+ 10MHz	132022	1715.0	132121	1724.9	16QAM	1	49	1	0	19.26	19.10	22.19	21.30	0.135
						50	0	50	0	17.20	17.25	20.24	19.35	0.086
	132373	1750.1	132472	1760.0	16QAM	1	49	1	0	19.36	19.54	22.46	21.57	0.143
						50	0	50	0	17.36	17.30	20.34	19.45	0.088
	132523	1765.1	132622	1775.0	16QAM	1	49	1	0	19.39	19.32	22.36	21.47	0.140
						50	0	50	0	17.48	17.28	20.39	19.50	0.089
10MHz+ 10MHz	132022	1715.0	132121	1724.9	64QAM	1	49	1	0	18.12	18.18	21.16	20.27	0.106
						50	0	50	0	17.61	17.67	20.65	19.76	0.095
	132373	1750.1	132472	1760.0	64QAM	1	49	1	0	18.50	18.50	21.51	20.62	0.115
						50	0	50	0	17.42	17.34	20.39	19.50	0.089
	132523	1765.1	132622	1775.0	64QAM	1	49	1	0	18.29	18.62	21.47	20.58	0.114
						50	0	50	0	17.33	17.30	20.32	19.43	0.088

Part 27 / RSS 139_ EIRP Limit (W)	1
Antenna Gain	-0.89447

**OUTPUT POWER FOR LTE BAND 66C (5MHz + 20MHz)**

Bandwidth	PCC		SCC1		Modulation	PCC RB		SCC1 RB		Conducted Average (dBm)			EIRP Average	EIRP Average
	Earfcn	MHz	Earfcn	MHz		Size	Offset	Size	Offset	PCC	SCC1	Total	(dBm)	(W)
5MHz+ 20MHz	132005	1713.3	132122	1725.0	QPSK	1	24	1	0	20.48	19.58	22.99	22.10	0.162
						25	0	100	0	18.06	18.50	21.06	20.17	0.104
	132330	1745.8	132447	1757.5	QPSK	1	24	1	0	20.14	20.09	23.16	22.27	0.168
						25	0	100	0	18.24	18.65	21.20	20.31	0.107
	132455	1758.3	132572	1770.0	QPSK	1	24	1	0	20.06	19.98	23.08	22.19	0.165
						25	0	100	0	18.21	18.66	21.20	20.31	0.107
5MHz+ 20MHz	132005	1713.3	132122	1725.0	16QAM	1	24	1	0	19.25	19.28	22.22	21.33	0.136
						25	0	100	0	17.11	17.55	20.10	19.21	0.083
	132330	1745.8	132447	1757.5	16QAM	1	24	1	0	19.50	19.38	22.39	21.50	0.141
						25	0	100	0	17.30	17.68	20.24	19.35	0.086
	132455	1758.3	132572	1770.0	16QAM	1	24	1	0	19.41	19.32	22.38	21.49	0.141
						25	0	100	0	17.22	17.73	20.22	19.33	0.086
5MHz+ 20MHz	132005	1713.3	132122	1725.0	64QAM	1	24	1	0	18.08	17.90	21.00	20.11	0.102
						25	0	100	0	17.13	17.53	20.09	19.20	0.083
	132330	1745.8	132447	1757.5	64QAM	1	24	1	0	18.39	17.96	21.18	20.29	0.107
						25	0	100	0	17.23	17.58	20.16	19.27	0.084
	132455	1758.3	132572	1770.0	64QAM	1	24	1	0	18.34	18.02	21.28	20.39	0.109
						25	0	100	0	17.27	17.71	20.21	19.32	0.085

Unless otherwise stated the results shown in this test report refer only to the sample(s) tested and such sample(s) are retained for 90 days only.

除非另有說明，此報告結果僅對測試之樣品負責，同時此樣品僅保留90天。本報告未經本公司書面許可，不可部份複製。

This document is issued by the Company subject to its General Conditions of Service printed overleaf, available on request or accessible at <http://www.sgs.com.tw/Terms-and-Conditions> and for electronic format documents, subject to Terms and Conditions for Electronic Documents at <http://www.sgs.com.tw/Terms-and-Conditions>. Attention is drawn to the limitation of liability, indemnification and jurisdiction issues defined therein. Any holder of this document is advised that information contained hereon reflects the Company's findings at the time of its intervention only and within the limits of Client's instructions, if any. The Company's sole responsibility is to its Client and this document does not exonerate parties to a transaction from exercising all their rights and obligations under the transaction documents. This document cannot be reproduced except in full, without prior written approval of the Company. Any unauthorized alteration, forgery or falsification of the content or appearance of this document is unlawful and offenders may be prosecuted to the fullest extent of the law.

Part 27 / RSS 139_ EIRP Limit (W)	1
Antenna Gain	-0.89447

**OUTPUT POWER FOR LTE BAND 66C (10MHz + 15MHz)**

Bandwidth	PCC		SCC1		Modulation	PCC RB		SCC1 RB		Conducted Average (dBm)			EIRP Average	EIRP Average
	Earfcn	MHz	Earfcn	MHz		Size	Offset	Size	Offset	PCC	SCC1	Total	(dBm)	(W)
10MHz+ 15MHz	132025	1715.3	132145	1727.3	QPSK	1	49	1	0	19.52	20.73	23.07	22.18	0.165
						50	0	75	0	18.29	18.18	21.24	20.35	0.108
	132351	1747.9	132471	1759.9	QPSK	1	49	1	0	20.32	20.46	23.30	22.41	0.174
						50	0	75	0	18.40	18.25	21.34	20.45	0.111
	132477	1760.5	132597	1772.5	QPSK	1	49	1	0	20.32	20.40	23.28	22.39	0.173
						50	0	75	0	18.37	18.29	21.34	20.45	0.111
10MHz+ 15MHz	132025	1715.3	132145	1727.3	16QAM	1	49	1	0	19.06	19.41	22.19	21.30	0.135
						50	0	75	0	17.29	17.22	20.26	19.37	0.086
	132351	1747.9	132471	1759.9	16QAM	1	49	1	0	19.60	19.84	22.61	21.72	0.148
						50	0	75	0	17.42	17.31	20.37	19.48	0.089
	132477	1760.5	132597	1772.5	16QAM	1	49	1	0	19.55	19.36	22.38	21.49	0.141
						50	0	75	0	17.43	17.31	20.38	19.49	0.089
10MHz+ 15MHz	132025	1715.3	132145	1727.3	64QAM	1	49	1	0	18.48	18.38	21.33	20.44	0.111
						50	0	75	0	17.25	17.21	20.24	19.35	0.086
	132351	1747.9	132471	1759.9	64QAM	1	49	1	0	18.45	18.38	21.36	20.47	0.111
						50	0	75	0	17.45	17.37	20.42	19.53	0.090
	132477	1760.5	132597	1772.5	64QAM	1	49	1	0	18.22	18.45	21.27	20.38	0.109
						50	0	75	0	17.38	17.25	20.33	19.44	0.088

Part 27 / RSS 139_ EIRP Limit (W)	1
Antenna Gain	-0.89447

**OUTPUT POWER FOR LTE BAND 66C (15MHz + 10MHz)**

Bandwidth	PCC		SCC1		Modulation	PCC RB		SCC1 RB		Conducted Average (dBm)			EIRP Average	EIRP Average
	Earfcn	MHz	Earfcn	MHz		Size	Offset	Size	Offset	PCC	SCC1	Total	(dBm)	(W)
15MHz+ 10MHz	132047	1717.5	132167	1729.5	QPSK	1	74	1	0	20.12	19.95	22.96	22.07	0.161
						75	0	50	0	18.27	18.23	21.26	20.37	0.109
	132373	1750.1	132493	1762.1	QPSK	1	74	1	0	20.76	19.69	23.20	22.31	0.170
						75	0	50	0	18.36	18.25	21.32	20.43	0.110
	132499	1762.7	132619	1774.7	QPSK	1	74	1	0	20.42	20.30	23.30	22.40	0.174
						75	0	50	0	18.32	18.30	21.32	20.43	0.110
15MHz+ 10MHz	132047	1717.5	132167	1729.5	16QAM	1	74	1	0	19.01	19.92	22.39	21.50	0.141
						75	0	50	0	17.21	17.25	20.24	19.35	0.086
	132373	1750.1	132493	1762.1	16QAM	1	74	1	0	19.32	19.34	22.22	21.33	0.136
						75	0	50	0	17.42	17.33	20.38	19.49	0.089
	132499	1762.7	132619	1774.7	16QAM	1	74	1	0	19.46	19.37	22.35	21.46	0.140
						75	0	50	0	17.38	17.34	20.37	19.48	0.089
15MHz+ 10MHz	132047	1717.5	132167	1729.5	64QAM	1	74	1	0	18.37	18.32	21.23	20.34	0.108
						75	0	50	0	17.19	17.25	20.23	19.34	0.086
	132373	1750.1	132493	1762.1	64QAM	1	74	1	0	18.54	17.96	21.21	20.32	0.108
						75	0	50	0	17.36	17.38	20.38	19.49	0.089
	132499	1762.7	132619	1774.7	64QAM	1	74	1	0	18.32	18.61	21.37	20.48	0.112
						75	0	50	0	17.33	17.36	20.36	19.47	0.088

Unless otherwise stated the results shown in this test report refer only to the sample(s) tested and such sample(s) are retained for 90 days only.

除非另有說明，此報告結果僅對測試之樣品負責，同時此樣品僅保留90天。本報告未經本公司書面許可，不可部份複製。

This document is issued by the Company subject to its General Conditions of Service printed overleaf, available on request or accessible at <http://www.sgs.com.tw/Terms-and-Conditions> and for electronic format documents, subject to Terms and Conditions for Electronic Documents at <http://www.sgs.com.tw/Terms-and-Conditions>. Attention is drawn to the limitation of liability, indemnification and jurisdiction issues defined therein. Any holder of this document is advised that information contained hereon reflects the Company's findings at the time of its intervention only and within the limits of Client's instructions, if any. The Company's sole responsibility is to its Client and this document does not exonerate parties to a transaction from exercising all their rights and obligations under the transaction documents. This document cannot be reproduced except in full, without prior written approval of the Company. Any unauthorized alteration, forgery or falsification of the content or appearance of this document is unlawful and offenders may be prosecuted to the fullest extent of the law.

Part 27 / RSS 139_ EIRP Limit (W)	1
Antenna Gain	-0.89447

**OUTPUT POWER FOR LTE BAND 66C (20MHz + 5MHz)**

Bandwidth	PCC		SCC1		Modulation	PCC RB		SCC1 RB		Conducted Average (dBm)			EIRP Average	EIRP Average
	Earfcn	MHz	Earfcn	MHz		Size	Offset	Size	Offset	PCC	SCC1	Total	(dBm)	(W)
20MHz+ 5MHz	132072	1720.0	132189	1731.7	QPSK	1	99	1	0	20.33	19.34	22.98	22.09	0.162
						100	0	25	0	18.15	18.25	21.22	20.33	0.108
	132397	1752.5	132514	1764.2	QPSK	1	99	1	0	19.92	19.87	23.02	22.13	0.163
						100	0	25	0	18.23	18.23	21.25	20.36	0.109
	132522	1765.0	132639	1776.7	QPSK	1	99	1	0	20.44	19.47	23.11	22.22	0.167
						100	0	25	0	18.84	17.83	21.38	20.49	0.112
20MHz+ 5MHz	132072	1720.0	132189	1731.7	16QAM	1	99	1	0	19.36	19.27	22.45	21.56	0.143
						100	0	25	0	17.65	17.22	20.19	19.30	0.085
	132397	1752.5	132514	1764.2	16QAM	1	99	1	0	18.95	19.25	22.16	21.27	0.134
						100	0	25	0	17.27	17.24	20.27	19.38	0.087
	132522	1765.0	132639	1776.7	16QAM	1	99	1	0	19.13	19.32	22.37	21.48	0.140
						100	0	25	0	17.25	17.29	20.29	19.40	0.087
20MHz+ 5MHz	132072	1720.0	132189	1731.7	64QAM	1	99	1	0	18.32	18.01	21.31	20.42	0.110
						100	0	25	0	17.19	17.19	20.21	19.32	0.085
	132397	1752.5	132514	1764.2	64QAM	1	99	1	0	18.31	18.54	21.56	20.67	0.117
						100	0	25	0	17.33	17.32	20.34	19.45	0.088
	132522	1765.0	132639	1776.7	64QAM	1	99	1	0	18.15	18.18	21.31	20.42	0.110
						100	0	25	0	17.38	17.37	20.39	19.50	0.089

Part 27 / RSS 139_ EIRP Limit (W)	1
Antenna Gain	-0.89447

**OUTPUT POWER FOR LTE BAND 66C (10MHz + 20MHz)**

Bandwidth	PCC		SCC1		Modulation	PCC RB		SCC1 RB		Conducted Average (dBm)			EIRP Average	EIRP Average
	Earfcn	MHz	Earfcn	MHz		Size	Offset	Size	Offset	PCC	SCC1	Total	(dBm)	(W)
10MHz+ 20MHz	132027	1715.5	132171	1729.9	QPSK	1	49	1	0	19.62	22.16	23.13	22.24	0.167
						50	0	100	0	18.31	18.23	21.26	20.37	0.109
	132328	1745.6	132472	1760.0	QPSK	1	49	1	0	20.37	22.36	23.29	22.40	0.174
						50	0	100	0	18.54	18.39	21.45	20.56	0.114
	132428	1755.6	132572	1770.0	QPSK	1	49	1	0	20.25	22.30	23.26	22.37	0.172
						50	0	100	0	18.52	18.37	21.42	20.53	0.113
10MHz+ 20MHz	132027	1715.5	132171	1729.9	16QAM	1	49	1	0	19.60	21.40	22.49	21.60	0.144
						50	0	100	0	17.22	17.25	20.22	19.33	0.086
	132328	1745.6	132472	1760.0	16QAM	1	49	1	0	19.86	21.17	22.45	21.56	0.143
						50	0	100	0	17.47	17.33	20.39	19.50	0.089
	132428	1755.6	132572	1770.0	16QAM	1	49	1	0	19.39	21.66	22.41	21.52	0.142
						50	0	100	0	17.54	17.32	20.42	19.53	0.090
10MHz+ 20MHz	132027	1715.5	132171	1729.9	64QAM	1	49	1	0	18.31	20.23	21.31	20.42	0.110
						50	0	100	0	17.35	17.27	20.29	19.40	0.087
	132328	1745.6	132472	1760.0	64QAM	1	49	1	0	18.62	20.41	21.42	20.53	0.113
						50	0	100	0	17.44	17.38	20.40	19.51	0.089
	132428	1755.6	132572	1770.0	64QAM	1	49	1	0	18.72	20.43	21.47	20.58	0.114
						50	0	100	0	17.46	17.38	20.40	19.51	0.089

Unless otherwise stated the results shown in this test report refer only to the sample(s) tested and such sample(s) are retained for 90 days only.

除非另有說明，此報告結果僅對測試之樣品負責，同時此樣品僅保留90天。本報告未經本公司書面許可，不可部份複製。

This document is issued by the Company subject to its General Conditions of Service printed overleaf, available on request or accessible at <http://www.sgs.com.tw/Terms-and-Conditions> and for electronic format documents, subject to Terms and Conditions for Electronic Documents at <http://www.sgs.com.tw/Terms-and-Conditions>. Attention is drawn to the limitation of liability, indemnification and jurisdiction issues defined therein. Any holder of this document is advised that information contained hereon reflects the Company's findings at the time of its intervention only and within the limits of Client's instructions, if any. The Company's sole responsibility is to its Client and this document does not exonerate parties to a transaction from exercising all their rights and obligations under the transaction documents. This document cannot be reproduced except in full, without prior written approval of the Company. Any unauthorized alteration, forgery or falsification of the content or appearance of this document is unlawful and offenders may be prosecuted to the fullest extent of the law.

Part 27 / RSS 139_ EIRP Limit (W)	1
Antenna Gain	-0.89447

**OUTPUT POWER FOR LTE BAND 66C (15MHz + 15MHz)**

Bandwidth	PCC		SCC1		Modulation	PCC RB		SCC1 RB		Conducted Average (dBm)			EIRP Average	EIRP Average
	Earfcn	MHz	Earfcn	MHz		Size	Offset	Size	Offset	PCC	SCC1	Total	(dBm)	(W)
15MHz+ 15MHz	132047	1717.5	132197	1732.5	QPSK	1	74	1	0	20.09	20.02	23.07	22.18	0.165
						75	0	75	0	18.24	18.23	21.25	20.36	0.109
	132347	1747.5	132497	1762.5	QPSK	1	74	1	0	20.25	20.20	23.24	22.35	0.172
						75	0	75	0	18.35	18.27	21.32	20.43	0.110
	132447	1757.5	132597	1772.5	QPSK	1	74	1	0	20.16	20.16	23.17	22.28	0.169
						75	0	75	0	18.45	18.30	21.39	20.50	0.112
15MHz+ 15MHz	132047	1717.5	132197	1732.5	16QAM	1	74	1	0	19.10	19.17	22.15	21.26	0.134
						75	0	75	0	17.28	17.25	20.27	19.38	0.087
	132347	1747.5	132497	1762.5	16QAM	1	74	1	0	19.09	19.42	22.27	21.38	0.137
						75	0	75	0	17.45	17.23	20.35	19.46	0.088
	132447	1757.5	132597	1772.5	16QAM	1	74	1	0	18.96	19.46	22.23	21.34	0.136
						75	0	75	0	17.47	17.23	20.36	19.47	0.088
15MHz+ 15MHz	132047	1717.5	132197	1732.5	64QAM	1	74	1	0	17.90	18.44	21.19	20.30	0.107
						75	0	75	0	17.24	17.24	20.25	19.36	0.086
	132347	1747.5	132497	1762.5	64QAM	1	74	1	0	18.43	18.32	21.38	20.49	0.112
						75	0	75	0	17.44	17.38	20.42	19.53	0.090
	132447	1757.5	132597	1772.5	64QAM	1	74	1	0	18.13	18.32	21.24	20.35	0.108
						75	0	75	0	17.44	17.33	20.40	19.51	0.089

Part 27 / RSS 139_ EIRP Limit (W)	1
Antenna Gain	-0.89447

**OUTPUT POWER FOR LTE BAND 66C (20MHz + 10MHz)**

Bandwidth	PCC		SCC1		Modulation	PCC RB		SCC1 RB		Conducted Average (dBm)			EIRP Average	EIRP Average
	Earfcn	MHz	Earfcn	MHz		Size	Offset	Size	Offset	PCC	SCC1	Total	(dBm)	(W)
20MHz+ 10MHz	132072	1720.0	132216	1734.4	QPSK	1	99	1	0	22.01	20.06	23.05	22.16	0.164
						100	0	50	0	18.27	18.38	21.31	20.42	0.110
	132373	1750.1	132517	1764.5	QPSK	1	99	1	0	22.25	20.38	23.38	22.49	0.177
						100	0	50	0	18.42	18.35	21.37	20.48	0.112
	132473	1760.1	132617	1774.5	QPSK	1	99	1	0	22.25	20.14	23.22	22.33	0.171
						100	0	50	0	18.40	18.38	21.37	20.48	0.112
20MHz+ 10MHz	132072	1720.0	132216	1734.4	16QAM	1	99	1	0	21.39	19.55	22.53	21.64	0.146
						100	0	50	0	17.28	17.32	20.28	19.39	0.087
	132373	1750.1	132517	1764.5	16QAM	1	99	1	0	21.35	19.24	22.41	21.52	0.142
						100	0	50	0	17.41	17.35	20.36	19.47	0.088
	132473	1760.1	132617	1774.5	16QAM	1	99	1	0	21.35	19.35	22.35	21.46	0.140
						100	0	50	0	17.41	17.24	20.31	19.42	0.087
20MHz+ 10MHz	132072	1720.0	132216	1734.4	64QAM	1	99	1	0	20.45	18.07	21.38	20.49	0.112
						100	0	50	0	17.30	17.29	20.28	19.39	0.087
	132373	1750.1	132517	1764.5	64QAM	1	99	1	0	20.48	18.50	21.47	20.58	0.114
						100	0	50	0	17.51	17.37	20.43	19.54	0.090
	132473	1760.1	132617	1774.5	64QAM	1	99	1	0	20.33	18.20	21.29	20.40	0.110
						100	0	50	0	17.49	17.50	20.48	19.59	0.091

Unless otherwise stated the results shown in this test report refer only to the sample(s) tested and such sample(s) are retained for 90 days only.

除非另有說明，此報告結果僅對測試之樣品負責，同時此樣品僅保留90天。本報告未經本公司書面許可，不可部份複製。

This document is issued by the Company subject to its General Conditions of Service printed overleaf, available on request or accessible at <http://www.sgs.com.tw/Terms-and-Conditions> and for electronic format documents, subject to Terms and Conditions for Electronic Documents at <http://www.sgs.com.tw/Terms-and-Conditions>. Attention is drawn to the limitation of liability, indemnification and jurisdiction issues defined therein. Any holder of this document is advised that information contained hereon reflects the Company's findings at the time of its intervention only and within the limits of Client's instructions, if any. The Company's sole responsibility is to its Client and this document does not exonerate parties to a transaction from exercising all their rights and obligations under the transaction documents. This document cannot be reproduced except in full, without prior written approval of the Company. Any unauthorized alteration, forgery or falsification of the content or appearance of this document is unlawful and offenders may be prosecuted to the fullest extent of the law.

Part 27 / RSS 139_ EIRP Limit (W)		1		<b>OUTPUT POWER FOR LTE BAND 66C (15MHz + 20MHz)</b>														
Antenna Gain		-0.89447		Bandwidth	PCC		SCC1		Modulation	PCC RB		SCC1 RB		Conducted Average (dBm)			EIRP Average	EIRP Average
Earfcn	MHz	Earfcn	MHz		Size	Offset	Size	Offset		PCC	SCC1	Total	(dBm)	(W)				
															Size	Offset	PCC	SCC1
15MHz+20MHz	132050	1717.8	132221	1734.9	QPSK	1	74	1	0	20.04	20.08	23.07	22.18	0.165				
						75	0	100	0	18.35	18.36	21.37	20.48	0.112				
	132325	1745.3	132496	1762.4	QPSK	1	74	1	0	20.37	20.32	23.35	22.46	0.176				
						75	0	100	0	18.49	18.35	21.43	20.54	0.113				
	132401	1752.9	132572	1770.0	QPSK	1	74	1	0	20.19	20.15	23.18	22.29	0.169				
						75	0	100	0	17.48	18.31	21.41	20.52	0.113				
15MHz+20MHz	132050	1717.8	132221	1734.9	16QAM	1	74	1	0	19.28	19.34	22.32	21.43	0.139				
						75	0	100	0	17.34	17.29	20.32	19.43	0.088				
	132325	1745.3	132496	1762.4	16QAM	1	74	1	0	19.51	19.23	22.38	21.49	0.141				
						75	0	100	0	17.47	17.33	20.41	19.52	0.089				
	132401	1752.9	132572	1770.0	16QAM	1	74	1	0	19.63	18.95	22.31	21.42	0.139				
						75	0	100	0	17.52	17.31	20.43	19.54	0.090				
15MHz+20MHz	132050	1717.8	132221	1734.9	64QAM	1	74	1	0	18.63	18.59	21.62	20.73	0.118				
						75	0	100	0	17.29	17.28	20.30	19.41	0.087				
	132325	1745.3	132496	1762.4	64QAM	1	74	1	0	18.49	18.49	21.50	20.61	0.115				
						75	0	100	0	17.53	17.41	20.48	19.59	0.091				
	132401	1752.9	132572	1770.0	64QAM	1	74	1	0	18.22	18.39	21.32	20.43	0.110				
						75	0	100	0	17.49	17.28	20.40	19.51	0.089				

Part 27 / RSS 139_ EIRP Limit (W)		1		<b>OUTPUT POWER FOR LTE BAND 66C (20MHz + 15MHz)</b>														
Antenna Gain		-0.89447		Bandwidth	PCC		SCC1		Modulation	PCC RB		SCC1 RB		Conducted Average (dBm)			EIRP Average	EIRP Average
Earfcn	MHz	Earfcn	MHz		Size	Offset	Size	Offset		PCC	SCC1	Total	(dBm)	(W)				
															Size	Offset	PCC	SCC1
20MHz+15MHz	132072	1720.0	132243	1737.1	QPSK	1	99	1	0	19.97	20.01	23.00	22.11	0.162				
						100	0	75	0	18.81	17.83	21.36	20.47	0.111				
	132348	1747.6	132519	1764.7	QPSK	1	99	1	0	20.17	20.17	23.18	22.29	0.169				
						100	0	75	0	18.44	18.35	21.40	20.51	0.112				
	132423	1755.1	132594	1772.2	QPSK	1	99	1	0	20.07	20.05	23.07	22.18	0.165				
						100	0	75	0	18.45	18.43	21.45	20.56	0.114				
20MHz+15MHz	132072	1720.0	132243	1737.1	16QAM	1	99	1	0	19.18	19.07	22.13	21.24	0.133				
						100	0	75	0	17.33	17.34	20.34	19.45	0.088				
	132348	1747.6	132519	1764.7	16QAM	1	99	1	0	19.03	19.57	22.31	21.42	0.139				
						100	0	75	0	17.44	17.37	20.41	19.52	0.089				
	132423	1755.1	132594	1772.2	16QAM	1	99	1	0	19.43	19.29	22.37	21.48	0.140				
						100	0	75	0	17.46	17.35	20.42	19.53	0.090				
20MHz+15MHz	132072	1720.0	132243	1737.1	64QAM	1	99	1	0	18.26	18.38	21.33	20.44	0.111				
						100	0	75	0	17.31	17.32	20.32	19.43	0.088				
	132348	1747.6	132519	1764.7	64QAM	1	99	1	0	18.36	18.59	21.49	20.60	0.115				
						100	0	75	0	17.43	17.39	20.42	19.53	0.090				
	132423	1755.1	132594	1772.2	64QAM	1	99	1	0	18.38	18.24	21.32	20.43	0.110				
						100	0	75	0	17.41	17.37	20.40	19.51	0.089				

Unless otherwise stated the results shown in this test report refer only to the sample(s) tested and such sample(s) are retained for 90 days only.  
 除非另有說明，此報告結果僅對測試之樣品負責，同時此樣品僅保留90天。本報告未經本公司書面許可，不可部份複製。  
 This document is issued by the Company subject to its General Conditions of Service printed overleaf, available on request or accessible at <http://www.sgs.com.tw/Terms-and-Conditions> and for electronic format documents, subject to Terms and Conditions for Electronic Documents at <http://www.sgs.com.tw/Terms-and-Conditions>. Attention is drawn to the limitation of liability, indemnification and jurisdiction issues defined therein. Any holder of this document is advised that information contained hereon reflects the Company's findings at the time of its intervention only and within the limits of Client's instructions, if any. The Company's sole responsibility is to its Client and this document does not exonerate parties to a transaction from exercising all their rights and obligations under the transaction documents. This document cannot be reproduced except in full, without prior written approval of the Company. Any unauthorized alteration, forgery or falsification of the content or appearance of this document is unlawful and offenders may be prosecuted to the fullest extent of the law.

Part 27 / RSS 139_ EIRP Limit (W)	1
Antenna Gain	-0.89447

**OUTPUT POWER FOR LTE BAND 66C (20MHz + 20MHz)**

Bandwidth	PCC		SCC1		Modulation	PCC RB		SCC1 RB		Conducted Average (dBm)			EIRP Average	EIRP Average
	Earfcn	MHz	Earfcn	MHz		Size	Offset	Size	Offset	PCC	SCC1	Total	(dBm)	(W)
20MHz+20MHz	132072	1720.0	132270	1739.8	QPSK	1	99	1	0	20.11	20.06	23.09	22.20	0.166
						100	0	100	0	18.26	18.35	21.32	20.43	0.110
	132323	1745.1	132521	1764.9	QPSK	1	99	1	0	20.25	20.21	23.24	22.35	0.172
						100	0	100	0	18.45	18.30	21.39	20.50	0.112
	132374	1750.2	132572	1770.0	QPSK	1	99	1	0	20.14	20.11	23.14	22.25	0.168
						100	0	100	0	18.44	18.39	21.42	20.53	0.113
20MHz+20MHz	132072	1720.0	132270	1739.8	16QAM	1	99	1	0	19.52	18.96	22.26	21.37	0.137
						100	0	100	0	17.28	17.37	20.34	19.45	0.088
	132323	1745.1	132521	1764.9	16QAM	1	99	1	0	19.39	19.12	22.27	21.38	0.137
						100	0	100	0	17.49	17.34	20.43	19.54	0.090
	132374	1750.2	132572	1770.0	16QAM	1	99	1	0	19.51	18.92	22.24	21.35	0.136
						100	0	100	0	17.48	17.36	20.43	19.54	0.090
20MHz+20MHz	132072	1720.0	132270	1739.8	64QAM	1	99	1	0	18.20	18.00	21.11	20.22	0.105
						100	0	100	0	17.31	17.33	20.33	19.44	0.088
	132323	1745.1	132521	1764.9	64QAM	1	99	1	0	18.43	18.23	21.34	20.45	0.111
						100	0	100	0	17.44	17.24	20.35	19.46	0.088
	132374	1750.2	132572	1770.0	64QAM	1	99	1	0	17.98	18.53	21.28	20.39	0.109
						100	0	100	0	17.52	17.33	20.44	19.55	0.090

Unless otherwise stated the results shown in this test report refer only to the sample(s) tested and such sample(s) are retained for 90 days only.

除非另有說明，此報告結果僅對測試之樣品負責，同時此樣品僅保留90天。本報告未經本公司書面許可，不可部份複製。

This document is issued by the Company subject to its General Conditions of Service printed overleaf, available on request or accessible at <http://www.sgs.com.tw/Terms-and-Conditions> and for electronic format documents, subject to Terms and Conditions for Electronic Documents at <http://www.sgs.com.tw/Terms-and-Conditions>. Attention is drawn to the limitation of liability, indemnification and jurisdiction issues defined therein. Any holder of this document is advised that information contained hereon reflects the Company's findings at the time of its intervention only and within the limits of Client's instructions, if any. The Company's sole responsibility is to its Client and this document does not exonerate parties to a transaction from exercising all their rights and obligations under the transaction documents. This document cannot be reproduced except in full, without prior written approval of the Company. Any unauthorized alteration, forgery or falsification of the content or appearance of this document is unlawful and offenders may be prosecuted to the fullest extent of the law.



### 7.5.2 Inter-Band

PCC Antenna gain (dBi)	-0.1
SCC Antenna gain (dBi)	-2.4

PCC						SCC						Conducted Average (dBm)		EIRP (dBm)	ERP (dBm)	EIRP Limit (dBm)	ERP Limit (dBm)
Band	Bandwidth (MHz)	PCC Channel/Frequency		PCC RB		Band	Bandwidth (MHz)	SCC Channel/Frequency		SCC RB		PCC	SCC	PCC	SCC	PCC	SCC
		Earfcn	MHz	Size	Offset			Earfcn	MHz	Size	Offset						
2	5	18625	1852.5	1	0	5	5	20425	826.5	1	0	21.12	20.89	21.0	16.3	33	38.45
2	5	18625	1852.5	1	0	5	10	20450	829	1	0	20.82	21.23	20.7	16.7	33	38.45
2	20	18700	1860	1	0	5	5	20425	826.5	1	0	21.07	21.09	21.0	16.5	33	38.45
2	20	18700	1860	1	0	5	10	20450	829	1	0	21.04	20.92	21.0	16.4	33	38.45
2	5	18900	1880	1	0	5	5	20525	836.5	1	0	21.03	21.8	21.0	17.2	33	38.45
2	5	18900	1880	1	0	5	10	20525	836.5	1	0	21.24	21.27	21.2	16.7	33	38.45
2	20	18900	1880	1	0	5	5	20525	836.5	1	0	20.94	21.41	20.9	16.8	33	38.45
2	20	18900	1880	1	0	5	10	20525	836.5	1	0	20.58	21.55	20.5	17.0	33	38.45
2	5	19175	1907.5	1	0	5	5	20625	846.5	1	0	21.38	21.87	21.3	17.3	33	38.45
2	5	19175	1907.5	1	0	5	10	20600	844	1	0	21.4	21.53	21.3	17.0	33	38.45
2	20	19100	1900	1	0	5	5	20625	846.5	1	0	21.06	21.82	21.0	17.3	33	38.45
2	20	19100	1900	1	0	5	10	20600	844	1	0	21.08	21.54	21.0	17.0	33	38.45

PCC Antenna gain (dBi)	-0.1
SCC Antenna gain (dBi)	-3.0

PCC						SCC						Conducted Average (dBm)		EIRP (dBm)	ERP (dBm)	EIRP Limit (dBm)	ERP Limit (dBm)
Band	Bandwidth (MHz)	PCC Channel/Frequency		PCC RB		Band	Bandwidth (MHz)	SCC Channel/Frequency		SCC RB		PCC	SCC	PCC	SCC	PCC	SCC
		Earfcn	MHz	Size	Offset			Earfcn	MHz	Size	Offset						
2	5	18625	1852.5	1	0	13	5	23205	779.5	1	0	21.53	20.32	21.5	15.2	33	34.77
2	5	18625	1852.5	1	0	13	10	23230	782	1	0	21.69	20.51	21.6	15.4	33	34.77
2	20	18700	1860	1	0	13	5	23205	779.5	1	0	21.45	20.55	21.4	15.4	33	34.77
2	20	18700	1860	1	0	13	10	23230	782	1	0	21.6	20.48	21.5	15.3	33	34.77
2	5	18900	1880	1	0	13	5	23230	782	1	0	19.94	20.49	19.9	15.4	33	34.77
2	5	18900	1880	1	0	13	10	23230	782	1	0	20.12	19.85	20.0	14.7	33	34.77
2	20	18900	1880	1	0	13	5	23230	782	1	0	20.04	20.18	20.0	15.0	33	34.77
2	20	18900	1880	1	0	13	10	23230	782	1	0	20.1	20.37	20.0	15.2	33	34.77
2	5	18625	1852.5	1	0	13	5	23255	784.5	1	0	21.55	20.2	21.5	15.1	33	34.77
2	5	18625	1852.5	1	0	13	10	23230	782	1	0	21.68	20.27	21.6	15.1	33	34.77
2	20	18700	1860	1	0	13	5	23255	784.5	1	0	21.37	20.26	21.3	15.1	33	34.77
2	20	18700	1860	1	0	13	10	23230	782	1	0	21.74	20.35	21.7	15.2	33	34.77

Unless otherwise stated the results shown in this test report refer only to the sample(s) tested and such sample(s) are retained for 90 days only.

除非另有說明，此報告結果僅對測試之樣品負責，同時此樣品僅保留90天。本報告未經本公司書面許可，不可部份複製。

This document is issued by the Company subject to its General Conditions of Service printed overleaf, available on request or accessible at <http://www.sgs.com.tw/Terms-and-Conditions> and for electronic format documents, subject to Terms and Conditions for Electronic Documents at <http://www.sgs.com.tw/Terms-and-Conditions>. Attention is drawn to the limitation of liability, indemnification and jurisdiction issues defined therein. Any holder of this document is advised that information contained hereon reflects the Company's findings at the time of its intervention only and within the limits of Client's instructions, if any. The Company's sole responsibility is to its Client and this document does not exonerate parties to a transaction from exercising all their rights and obligations under the transaction documents. This document cannot be reproduced except in full, without prior written approval of the Company. Any unauthorized alteration, forgery or falsification of the content or appearance of this document is unlawful and offenders may be prosecuted to the fullest extent of the law.

PCC Antenna gain (dBi)	-0.1
SCC Antenna gain (dBi)	-0.9

PCC						SCC						Conducted Average (dBm)		EIRP (dBm)	EIRP (dBm)	EIRP Limit (dBm)	EIRP Limit (dBm)
Band	Bandwidth (MHz)	PCC		PCC		Band	Bandwidth (MHz)	SCC		SCC		PCC	SCC	PCC	SCC	PCC	SCC
		Earfcn	MHz	Size	Offset			Earfcn	MHz	Size	Offset						
2	5	18625	1852.5	1	0	66	5	131997	1712.5	1	0	20.99	20.39	20.9	19.5	33	30
2	5	18625	1852.5	1	0	66	20	132072	1720	1	0	21.01	20.41	20.9	19.5	33	30
2	20	18700	1860	1	0	66	5	131997	1712.5	1	0	20.8	20.83	20.7	19.9	33	30
2	20	18700	1860	1	0	66	20	132072	1720	1	0	20.83	20.5	20.8	19.6	33	30
2	5	18900	1880	1	0	66	5	132322	1745	1	0	21.09	21.17	21.0	20.3	33	30
2	5	18900	1880	1	0	66	20	132322	1745	1	0	21.16	20.7	21.1	19.8	33	30
2	20	18900	1880	1	0	66	5	132322	1745	1	0	21.11	21.28	21.0	20.4	33	30
2	20	18900	1880	1	0	66	20	132322	1745	1	0	21.03	20.97	21.0	20.1	33	30
2	5	18625	1852.5	1	0	66	5	132647	1777.5	1	0	20.94	20.99	20.9	20.1	33	30
2	5	18625	1852.5	1	0	66	20	132572	1770	1	0	21.1	20.48	21.0	19.6	33	30
2	20	18700	1860	1	0	66	5	132647	1777.5	1	0	20.76	20.86	20.7	20.0	33	30
2	20	18700	1860	1	0	66	20	132572	1770	1	0	20.8	20.53	20.7	19.6	33	30

PCC Antenna gain (dBi)	-2.4
SCC Antenna gain (dBi)	-0.9

PCC						SCC						Conducted Average (dBm)		ERP (dBm)	EIRP (dBm)	ERP Limit (dBm)	EIRP Limit (dBm)
Band	Bandwidth (MHz)	PCC		PCC		Band	Bandwidth (MHz)	SCC		SCC		PCC	SCC	PCC	SCC	PCC	SCC
		Channel/Frequency	RB	Earfcn	MHz			Size	Offset	Earfcn	MHz						
5	5	20425	826.5	1	0	66	5	131997	1712.5	1	0	21.18	20.84	16.6	19.9	38.45	30
5	5	20425	826.5	1	0	66	20	132072	1720	1	0	21.35	21.1	16.8	20.2	38.45	30
5	10	20450	829	1	0	66	5	131997	1712.5	1	0	21.26	20.87	16.7	20.0	38.45	30
5	10	20450	829	1	0	66	20	132072	1720	1	0	21.19	21.12	16.6	20.2	38.45	30
5	5	20525	836.5	1	0	66	5	132322	1745	1	0	21.61	21.28	17.0	20.4	38.45	30
5	5	20525	836.5	1	0	66	20	132322	1745	1	0	21.8	21.24	17.2	20.3	38.45	30
5	10	20525	836.5	1	0	66	5	132322	1745	1	0	21.43	21.26	16.9	20.4	38.45	30
5	10	20525	836.5	1	0	66	20	132322	1745	1	0	21.33	21.57	16.8	20.7	38.45	30
5	5	20625	846.5	1	0	66	5	132647	1777.5	1	0	22.28	20.51	17.7	19.6	38.45	30
5	5	20625	846.5	1	0	66	20	132572	1770	1	0	22.24	21.2	17.7	20.3	38.45	30
5	10	20600	844	1	0	66	5	132647	1777.5	1	0	21.68	20.64	17.1	19.7	38.45	30
5	10	20600	844	1	0	66	20	132572	1770	1	0	21.94	21.15	17.4	20.3	38.45	30

Unless otherwise stated the results shown in this test report refer only to the sample(s) tested and such sample(s) are retained for 90 days only.

除非另有說明，此報告結果僅對測試之樣品負責，同時此樣品僅保留90天。本報告未經本公司書面許可，不可部份複製。

This document is issued by the Company subject to its General Conditions of Service printed overleaf, available on request or accessible at <http://www.sgs.com.tw/Terms-and-Conditions> and for electronic format documents, subject to Terms and Conditions for Electronic Documents at <http://www.sgs.com.tw/Terms-and-Conditions>. Attention is drawn to the limitation of liability, indemnification and jurisdiction issues defined therein. Any holder of this document is advised that information contained hereon reflects the Company's findings at the time of its intervention only and within the limits of Client's instructions, if any. The Company's sole responsibility is to its Client and this document does not exonerate parties to a transaction from exercising all their rights and obligations under the transaction documents. This document cannot be reproduced except in full, without prior written approval of the Company. Any unauthorized alteration, forgery or falsification of the content or appearance of this document is unlawful and offenders may be prosecuted to the fullest extent of the law.

PCC Antenna gain (dBi)	-3.0
SCC Antenna gain (dBi)	-0.9

Band	Bandwidth (MHz)	PCC				Band	Bandwidth (MHz)	SCC				Conducted Average (dBm)		ERP (dBm)	EIRP (dBm)	ERP Limit (dBm)	EIRP Limit (dBm)
		PCC		PCC				SCC		SCC		PCC	SCC	PCC	SCC	PCC	SCC
		Earfcn	MHz	Size	Offset			Earfcn	MHz	Size	Offset						
13	5	23205	779.5	1	0	66	5	131997	1712.5	1	0	20.45	20.77	15.3	19.9	34.77	30
13	5	23205	779.5	1	0	66	20	132072	1720	1	0	20.47	20.83	15.3	19.9	34.77	30
13	10	23230	782	1	0	66	5	131997	1712.5	1	0	20.46	20.88	15.3	20.0	34.77	30
13	10	23230	782	1	0	66	20	132072	1720	1	0	20.43	20.93	15.3	20.0	34.77	30
13	5	23230	782	1	0	66	5	132322	1745	1	0	21.3	21.2	16.2	20.3	34.77	30
13	5	23230	782	1	0	66	20	132322	1745	1	0	21.35	21	16.2	20.1	34.77	30
13	10	23230	782	1	0	66	5	132322	1745	1	0	21.43	21.04	16.3	20.1	34.77	30
13	10	23230	782	1	0	66	20	132322	1745	1	0	21.62	20.98	16.5	20.1	34.77	30
13	5	23255	784.5	1	0	66	5	132647	1777.5	1	0	20.35	21.05	15.2	20.2	34.77	30
13	5	23255	784.5	1	0	66	20	132572	1770	1	0	20.27	21.23	15.1	20.3	34.77	30
13	10	23230	782	1	0	66	5	132647	1777.5	1	0	20.93	20.59	15.8	19.7	34.77	30
13	10	23230	782	1	0	66	20	132572	1770	1	0	20.54	20.99	15.4	20.1	34.77	30

PCC Antenna gain (dBi)	-2.4
SCC Antenna gain (dBi)	-3.0

Band	Bandwidth (MHz)	PCC				Band	Bandwidth (MHz)	SCC				Conducted Average (dBm)		ERP (dBm)	EIRP (dBm)	ERP Limit (dBm)	EIRP Limit (dBm)
		PCC		PCC				SCC		SCC		PCC	SCC	PCC	SCC	PCC	SCC
		Earfcn	MHz	Size	Offset			Earfcn	MHz	Size	Offset						
5	5	20425	826.5	1	0	13	10	23230	782	1	0	22.41	21.76	17.8	16.6	38.45	34.77
5	10	20450	829	1	0	13	10	23230	782	1	0	22.3	22.05	17.7	16.9	38.45	34.77
5	5	20525	836.5	1	0	13	10	23230	782	1	0	22.35	21.5	17.8	16.4	38.45	34.77
5	10	20525	836.5	1	0	13	10	23230	782	1	0	22.16	21.52	17.6	16.4	38.45	34.77
5	5	20625	846.5	1	0	13	10	23230	782	1	0	21.83	21.61	17.3	16.5	38.45	34.77
5	10	20600	844	1	0	13	10	23230	782	1	0	22.13	21.74	17.6	16.6	38.45	34.77

Unless otherwise stated the results shown in this test report refer only to the sample(s) tested and such sample(s) are retained for 90 days only.

除非另有說明，此報告結果僅對測試之樣品負責，同時此樣品僅保留90天。本報告未經本公司書面許可，不可部份複製。

This document is issued by the Company subject to its General Conditions of Service printed overleaf, available on request or accessible at <http://www.sgs.com.tw/Terms-and-Conditions> and for electronic format documents, subject to Terms and Conditions for Electronic Documents at <http://www.sgs.com.tw/Terms-and-Conditions>. Attention is drawn to the limitation of liability, indemnification and jurisdiction issues defined therein. Any holder of this document is advised that information contained hereon reflects the Company's findings at the time of its intervention only and within the limits of Client's instructions, if any. The Company's sole responsibility is to its Client and this document does not exonerate parties to a transaction from exercising all their rights and obligations under the transaction documents. This document cannot be reproduced except in full, without prior written approval of the Company. Any unauthorized alteration, forgery or falsification of the content or appearance of this document is unlawful and offenders may be prosecuted to the fullest extent of the law.

## 8 OCCUPIED BANDWIDTH MEASUREMENT

### 8.1 Standard Applicable

The occupied bandwidth is the frequency bandwidth such that, below its lower and above its upper frequency limits, the mean powers radiated are each equal to 0.5 percent of the total mean power.

### 8.2 Test Set-up

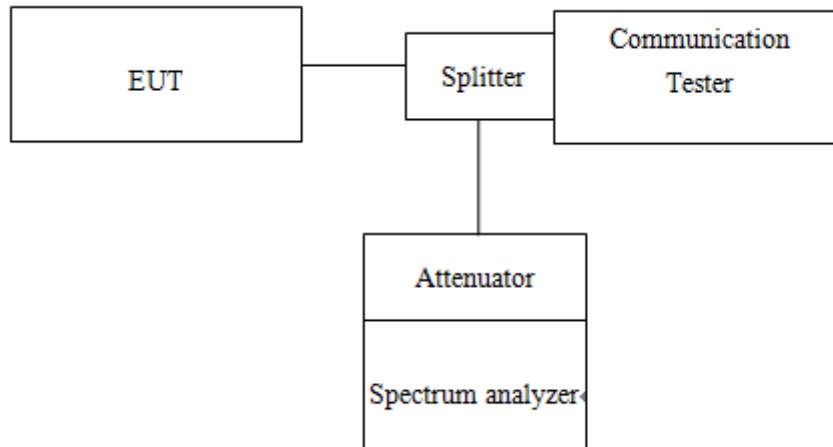

### 8.3 Measurement Procedure

#### **99% & 26dB Bandwidth with detector peak**

The EUT's output RF connector was connected with a short cable to the spectrum analyzer, RBW was set to about 1% of emission BW, VBW= 3 times RBW, -26dBc display line was placed on the screen (or 26dB bandwidth), the occupied bandwidth is the delta frequency between the two points where the display line intersects the signal trace. Then set RBW to 99% bandwidth, RBW= 1%, VBW= 3 RBW, with span > 2 \* Signal BW, set % Power = 99%.

#### **99% Bandwidth with detector sample**

The EUT's output RF connector was connected with a short cable to the spectrum analyzer, RBW was set to about 1% ~ 5% of emission BW, VBW= 3 times RBW, -20dBc display line was placed on the screen (or 20dB bandwidth). Set RBW to 99% bandwidth, RBW= 1% ~ 5%, VBW= 3 RBW, with span > 2 \* Signal BW, set % Power = 99%.

Unless otherwise stated the results shown in this test report refer only to the sample(s) tested and such sample(s) are retained for 90 days only.

除非另有說明，此報告結果僅對測試之樣品負責，同時此樣品僅保留90天。本報告未經本公司書面許可，不可部份複製。

This document is issued by the Company subject to its General Conditions of Service printed overleaf, available on request or accessible at <http://www.sgs.com.tw/Terms-and-Conditions> and for electronic format documents, subject to Terms and Conditions for Electronic Documents at <http://www.sgs.com.tw/Terms-and-Conditions>. Attention is drawn to the limitation of liability, indemnification and jurisdiction issues defined therein. Any holder of this document is advised that information contained hereon reflects the Company's findings at the time of its intervention only and within the limits of Client's instructions, if any. The Company's sole responsibility is to its Client and this document does not exonerate parties to a transaction from exercising all their rights and obligations under the transaction documents. This document cannot be reproduced except in full, without prior written approval of the Company. Any unauthorized alteration, forgery or falsification of the content or appearance of this document is unlawful and offenders may be prosecuted to the fullest extent of the law.

## 8.4 Measurement Result

### LTE BAND 5B

Band	Bandwidth	RB Allocation/RB Offset	Frequency (MHz)	99% BW (MHz)			26 dB BW (MHz)		
				QPSK	16QAM	64QAM	QPSK	16QAM	64QAM
LTE BAND 5B	5MHz + 10MHz	25/0 + 50/0	836.5	13.877	13.853	13.877	14.84	14.84	14.88
LTE BAND 5B	10MHz + 5MHz	50/0 + 25/0	836.5	13.884	13.897	13.884	14.86	14.81	14.8
LTE BAND 5B	10MHz + 10MHz	50/0 + 50/0	836.5	18.749	18.771	18.752	20.1	20.02	20.08

### LTE BAND 66B

Band	Bandwidth	RB Allocation/RB Offset	Frequency (MHz)	99% BW (MHz)			26 dB BW (MHz)		
				QPSK	16QAM	64QAM	QPSK	16QAM	64QAM
LTE BAND 66B	5MHz + 5MHz	25/0 + 25/0	1745.0	9.2234	9.248	9.2707	9.826	9.987	10.08
LTE BAND 66B	5MHz + 10MHz	25/0 + 50/0	1745.0	13.884	13.907	13.931	14.81	14.75	14.85
LTE BAND 66B	10MHz + 5MHz	50/0 + 25/0	1745.0	13.894	13.910	13.915	14.8	14.74	14.75
LTE BAND 66B	5MHz + 15MHz	25/0 + 75/0	1745.0	18.231	18.224	18.254	19.25	19.36	19.36
LTE BAND 66B	15MHz + 5MHz	75/0 + 25/0	1745.0	18.212	18.233	18.22	19.18	19.31	19.39
LTE BAND 66B	10MHz + 10MHz	50/0 + 50/0	1745.0	18.817	18.791	18.804	20.07	20.07	20.08

### LTE BAND 66C

Band	Bandwidth	RB Allocation/RB Offset	Frequency (MHz)	99% BW (MHz)			26 dB BW (MHz)		
				QPSK	16QAM	64QAM	QPSK	16QAM	64QAM
LTE BAND 66C	5MHz + 20MHz	25/0 + 100/0	1745.0	22.994	22.934	22.947	24.39	24.18	24.26
LTE BAND 66C	20MHz + 5MHz	100/0 + 25/0	1745.0	22.938	22.927	22.927	24.36	24.38	24.31
LTE BAND 66C	10MHz + 15MHz	50/0 + 75/0	1745.0	23.225	23.206	23.193	24.88	24.86	24.87
LTE BAND 66C	15MHz + 10MHz	75/0 + 50/0	1745.0	23.26	23.132	23.174	24.65	24.65	24.72
LTE BAND 66C	10MHz + 20MHz	50/0 + 100/0	1745.0	27.862	27.851	27.854	29.67	29.67	29.57
LTE BAND 66C	20MHz + 10MHz	100/0 + 50/0	1745.0	27.853	27.827	27.888	29.75	29.67	29.63
LTE BAND 66C	15MHz + 15MHz	75/0 + 75/0	1745.0	28.383	28.384	28.404	30.38	30.4	30.37
LTE BAND 66C	15MHz + 20MHz	75/0 + 100/0	1745.0	32.714	32.732	32.738	34.82	34.71	34.78
LTE BAND 66C	20MHz + 15MHz	100/0 + 75/0	1745.0	32.747	32.683	32.692	34.82	34.76	34.81
LTE BAND 66C	20MHz + 20MHz	100/0 + 100/0	1745.0	37.64	37.712	37.663	40.14	40.16	40.22

Unless otherwise stated the results shown in this test report refer only to the sample(s) tested and such sample(s) are retained for 90 days only.

除非另有說明，此報告結果僅對測試之樣品負責，同時此樣品僅保留90天。本報告未經本公司書面許可，不可部份複製。

This document is issued by the Company subject to its General Conditions of Service printed overleaf, available on request or accessible at <http://www.sgs.com.tw/Terms-and-Conditions> and for electronic format documents, subject to Terms and Conditions for Electronic Documents at <http://www.sgs.com.tw/Terms-and-Conditions>. Attention is drawn to the limitation of liability, indemnification and jurisdiction issues defined therein. Any holder of this document is advised that information contained hereon reflects the Company's findings at the time of its intervention only and within the limits of Client's instructions, if any. The Company's sole responsibility is to its Client and this document does not exonerate parties to a transaction from exercising all their rights and obligations under the transaction documents. This document cannot be reproduced except in full, without prior written approval of the Company. Any unauthorized alteration, forgery or falsification of the content or appearance of this document is unlawful and offenders may be prosecuted to the fullest extent of the law.

Band5\_5MHz+10MHz\_OPSK\_RB25-0+RB50-0\_CH20478+CH20550



Band5\_10MHz+5MHz\_OPSK\_RB50-0+RB25-0\_CH20500+CH20572

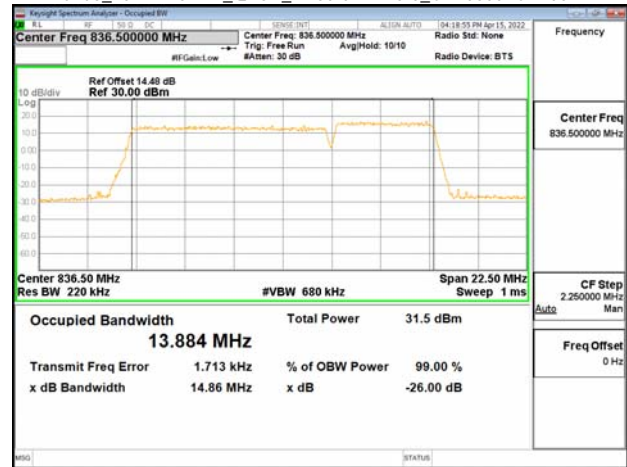

Band5\_5MHz+10MHz\_16QAM\_RB25-0+RB50-0\_CH20478+CH20550

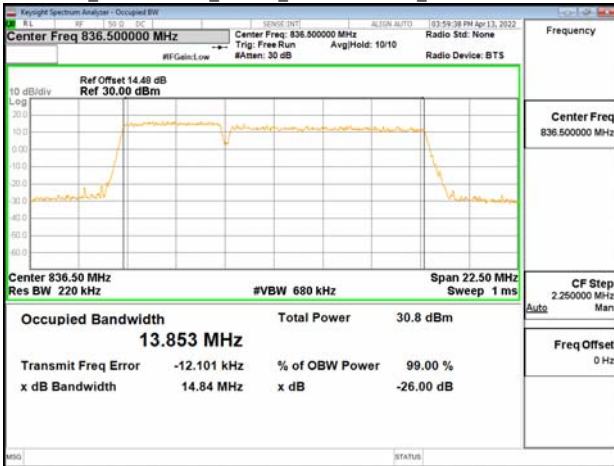

Band5\_10MHz+5MHz\_16QAM\_RB50-0+RB25-0\_CH20500+CH20572

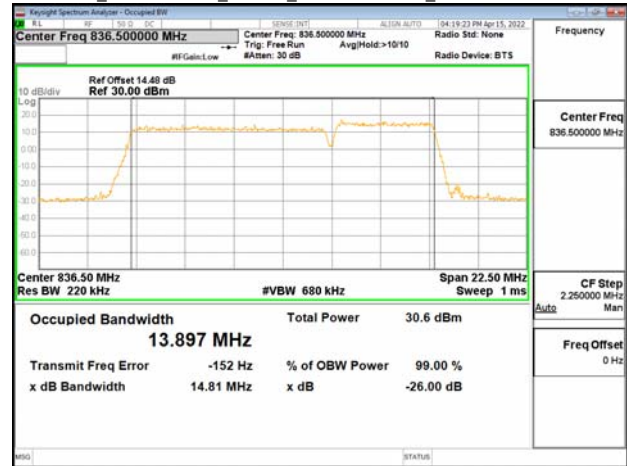

Band5\_5MHz+10MHz\_64QAM\_RB25-0+RB50-0\_CH20478+CH20550

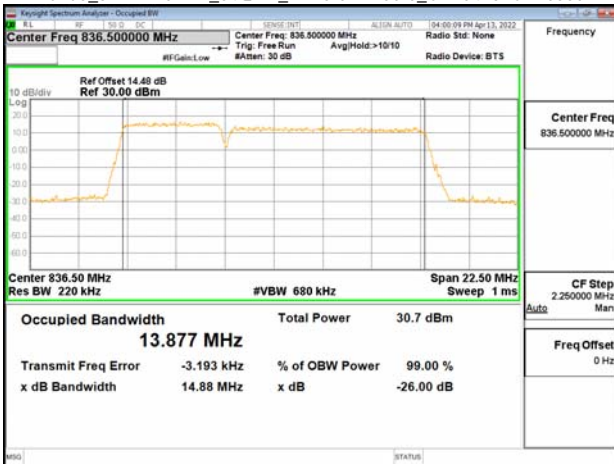

Band5\_10MHz+5MHz\_64QAM\_RB50-0+RB25-0\_CH20500+CH20572

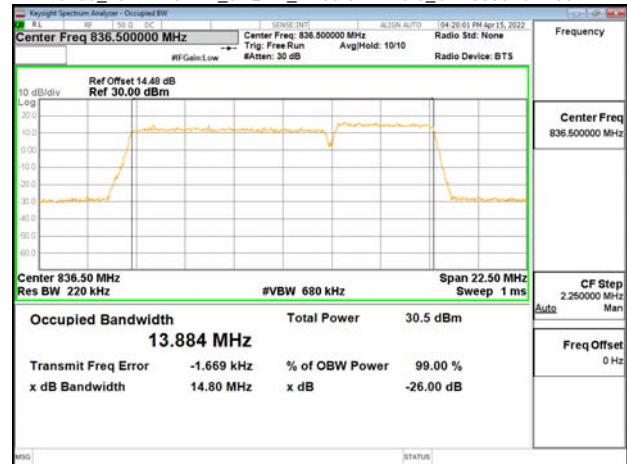

Unless otherwise stated the results shown in this test report refer only to the sample(s) tested and such sample(s) are retained for 90 days only.

除非另有說明，此報告結果僅對測試之樣品負責，同時此樣品僅保留90天。本報告未經本公司書面許可，不可部份複製。  
This document is issued by the Company subject to its General Conditions of Service printed overleaf, available on request or accessible at <http://www.sgs.com.tw/Terms-and-Conditions> and for electronic format documents, subject to Terms and Conditions for Electronic Documents at <http://www.sgs.com.tw/Terms-and-Conditions>. Attention is drawn to the limitation of liability, indemnification and jurisdiction issues defined therein. Any holder of this document is advised that information contained herein reflects the Company's findings at the time of its intervention only and within the limits of Client's instructions, if any. The Company's sole responsibility is to its Client and this document does not exonerate parties to a transaction from exercising all their rights and obligations under the transaction documents. This document cannot be reproduced except in full, without prior written approval of the Company. Any unauthorized alteration, forgery or falsification of the content or appearance of this document is unlawful and offenders may be prosecuted to the fullest extent of the law.

Band5\_10MHz+10MHz\_QPSK\_RB50-0+RB50-0\_CH20476+CH20575

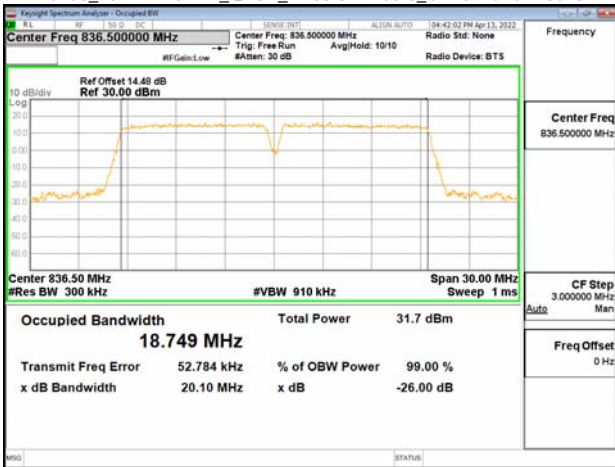

Band66\_5MHz+20MHz\_QPSK\_RB25-0+RB100-0\_CH132330+CH132447



Band5\_10MHz+10MHz\_16QAM\_RB50-0+RB50-0\_CH20476+CH20575

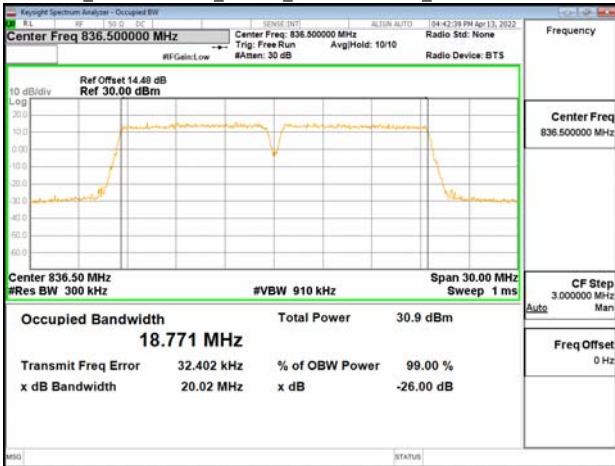

Band66\_5MHz+20MHz\_16QAM\_RB25-0+RB100-0\_CH132330+CH132447

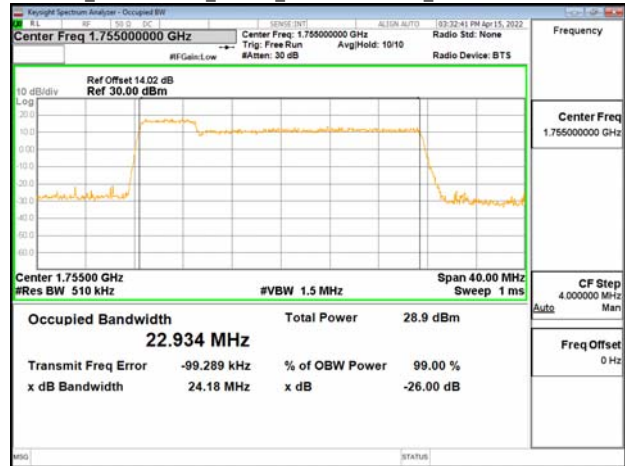

Band5\_10MHz+10MHz\_64QAM\_RB50-0+RB50-0\_CH20476+CH20575

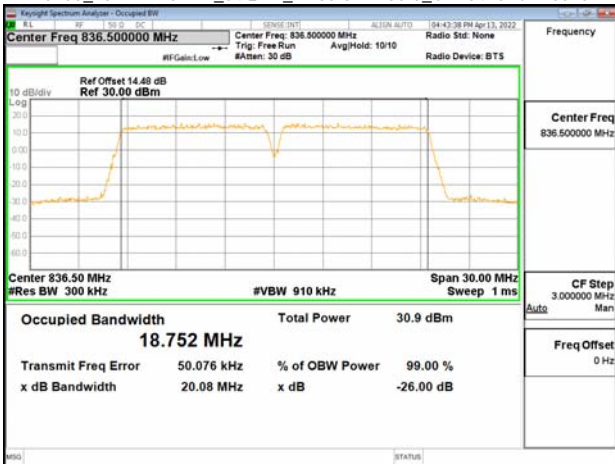

Band66\_5MHz+20MHz\_64QAM\_RB25-0+RB100-0\_CH132330+CH132447

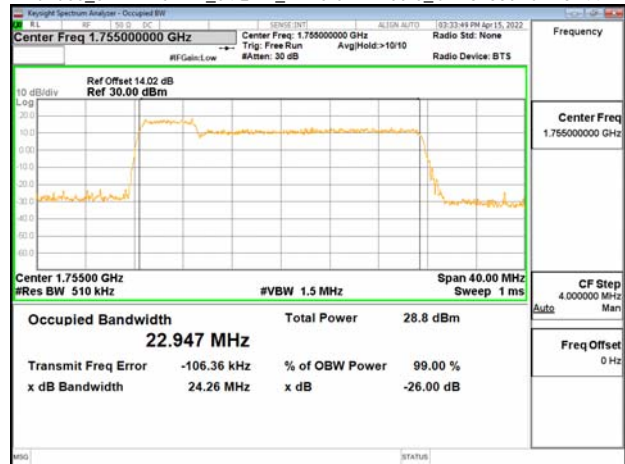

Unless otherwise stated the results shown in this test report refer only to the sample(s) tested and such sample(s) are retained for 90 days only.

除非另有說明，此報告結果僅對測試之樣品負責，同時此樣品僅保留90天。本報告未經本公司書面許可，不可部份複製。

This document is issued by the Company subject to its General Conditions of Service printed overleaf, available on request or accessible at <http://www.sgs.com.tw/Terms-and-Conditions> and for electronic format documents, subject to Terms and Conditions for Electronic Documents at <http://www.sgs.com.tw/Terms-and-Conditions>. Attention is drawn to the limitation of liability, indemnification and jurisdiction issues defined therein. Any holder of this document is advised that information contained herein reflects the Company's findings at the time of its intervention only and within the limits of Client's instructions, if any. The Company's sole responsibility is to its Client and this document does not exonerate parties to a transaction from exercising all their rights and obligations under the transaction documents. This document cannot be reproduced except in full, without prior written approval of the Company. Any unauthorized alteration, forgery or falsification of the content or appearance of this document is unlawful and offenders may be prosecuted to the fullest extent of the law.

Band66\_10MHz+15MHz\_OPSK\_RB50-0+RB75-0\_CH132351+CH132471

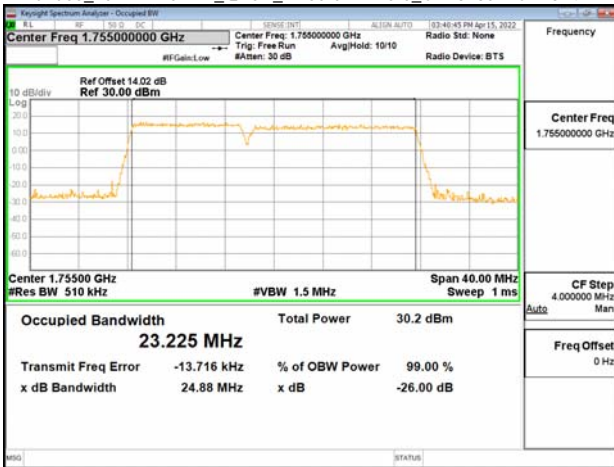

Band66\_15MHz+10MHz\_OPSK\_RB75-0+RB50-0\_CH132373+CH132493



Band66\_10MHz+15MHz\_16QAM\_RB50-0+RB75-0\_CH132351+CH132471



Band66\_15MHz+10MHz\_16QAM\_RB75-0+RB50-0\_CH132373+CH132493

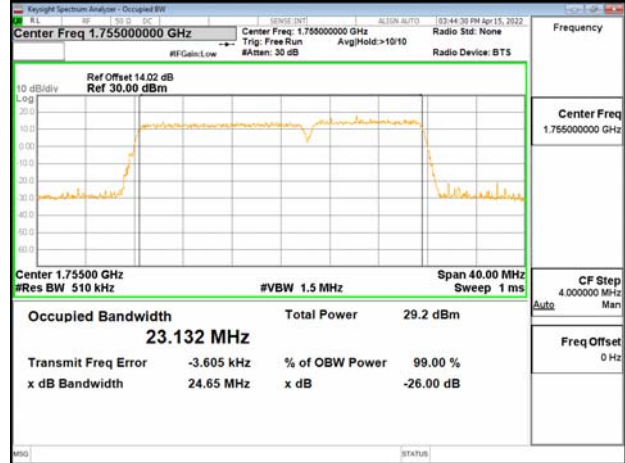

Band66\_10MHz+15MHz\_64QAM\_RB50-0+RB75-0\_CH132351+CH132471



Band66\_15MHz+10MHz\_64QAM\_RB75-0+RB50-0\_CH132373+CH132493

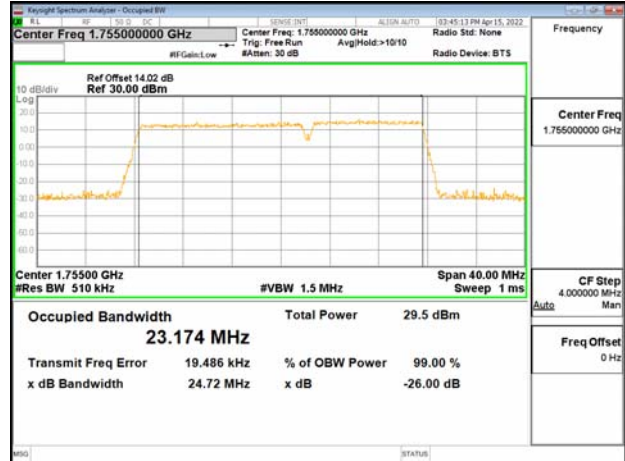

Unless otherwise stated the results shown in this test report refer only to the sample(s) tested and such sample(s) are retained for 90 days only.

除非另有說明，此報告結果僅對測試之樣品負責，同時此樣品僅保留90天。本報告未經本公司書面許可，不可部份複製。  
This document is issued by the Company subject to its General Conditions of Service printed overleaf, available on request or accessible at <http://www.sgs.com.tw/Terms-and-Conditions> and for electronic format documents, subject to Terms and Conditions for Electronic Documents at <http://www.sgs.com.tw/Terms-and-Conditions>. Attention is drawn to the limitation of liability, indemnification and jurisdiction issues defined therein. Any holder of this document is advised that information contained herein reflects the Company's findings at the time of its intervention only and within the limits of Client's instructions, if any. The Company's sole responsibility is to its Client and this document does not exonerate parties to a transaction from exercising all their rights and obligations under the transaction documents. This document cannot be reproduced except in full, without prior written approval of the Company. Any unauthorized alteration, forgery or falsification of the content or appearance of this document is unlawful and offenders may be prosecuted to the fullest extent of the law.



Band66\_20MHz+5MHz\_QPSK\_RB100-0+RB25-0\_CH132397+CH132514



Band66\_10MHz+20MHz\_QPSK\_RB50-0+RB100-0\_CH132328+CH132472

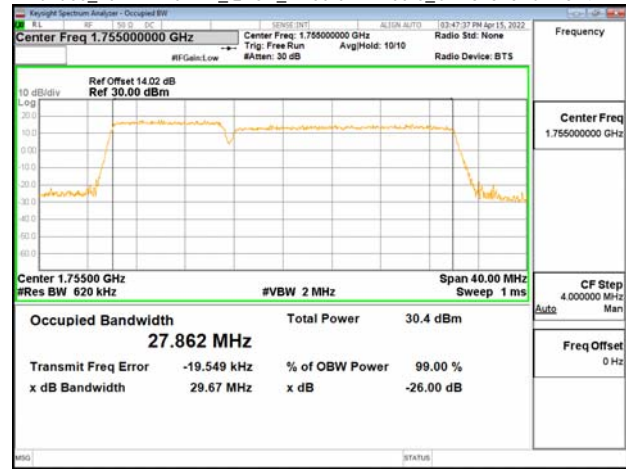

Band66\_20MHz+5MHz\_16QAM\_RB100-0+RB25-0\_CH132397+CH132514



Band66\_10MHz+20MHz\_16QAM\_RB50-0+RB100-0\_CH132328+CH132472



Band66\_20MHz+5MHz\_64QAM\_RB100-0+RB25-0\_CH132397+CH132514



Band66\_10MHz+20MHz\_64QAM\_RB50-0+RB100-0\_CH132328+CH132472

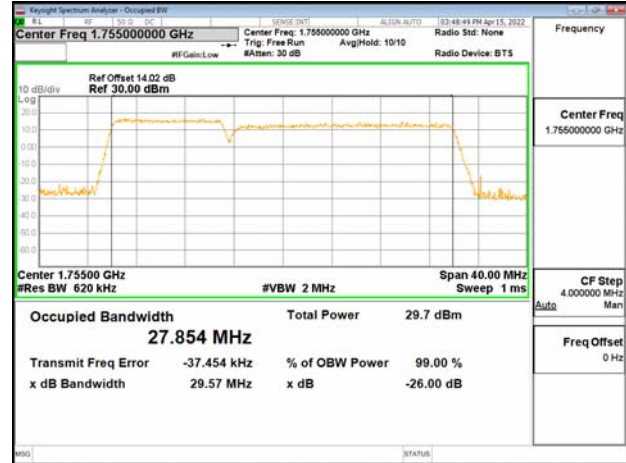

Unless otherwise stated the results shown in this test report refer only to the sample(s) tested and such sample(s) are retained for 90 days only.

除非另有說明，此報告結果僅對測試之樣品負責，同時此樣品僅保留90天。本報告未經本公司書面許可，不可部份複製。

This document is issued by the Company subject to its General Conditions of Service printed overleaf, available on request or accessible at <http://www.sgs.com.tw/Terms-and-Conditions> and for electronic format documents, subject to Terms and Conditions for Electronic Documents at <http://www.sgs.com.tw/Terms-and-Conditions>. Attention is drawn to the limitation of liability, indemnification and jurisdiction issues defined therein. Any holder of this document is advised that information contained herein reflects the Company's findings at the time of its intervention only and within the limits of Client's instructions, if any. The Company's sole responsibility is to its Client and this document does not exonerate parties to a transaction from exercising all their rights and obligations under the transaction documents. This document cannot be reproduced except in full, without prior written approval of the Company. Any unauthorized alteration, forgery or falsification of the content or appearance of this document is unlawful and offenders may be prosecuted to the fullest extent of the law.

Band66\_15MHz+15MHz\_OPSK\_RB75-0+RB75-0\_CH132347+CH132497

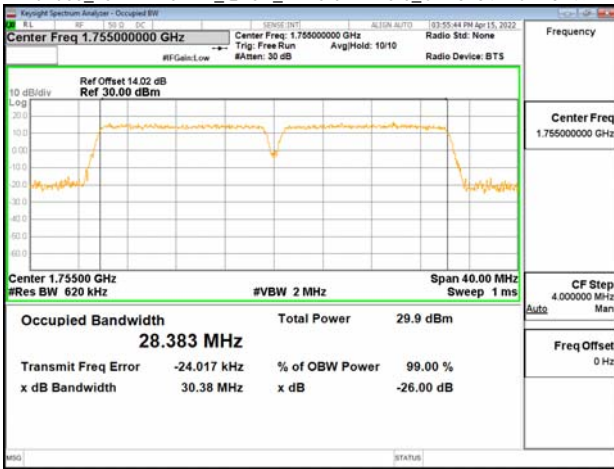

Band66\_20MHz+10MHz\_OPSK\_RB100-0+RB50-0\_CH132373+CH132517



Band66\_15MHz+15MHz\_16QAM\_RB75-0+RB75-0\_CH132347+CH132497

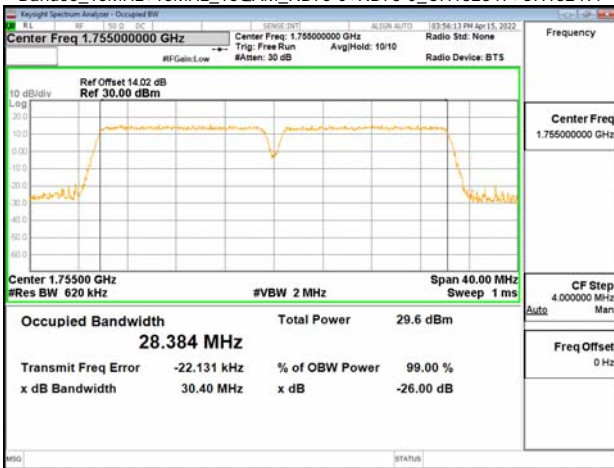

Band66\_20MHz+10MHz\_16QAM\_RB100-0+RB50-0\_CH132373+CH132517



Band66\_15MHz+15MHz\_64QAM\_RB75-0+RB75-0\_CH132347+CH132497

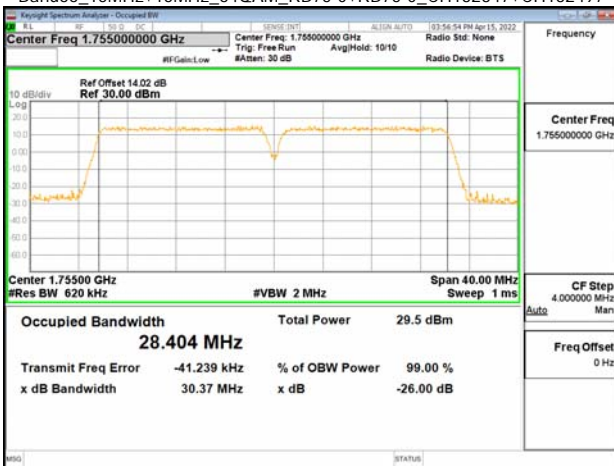

Band66\_20MHz+10MHz\_64QAM\_RB100-0+RB50-0\_CH132373+CH132517



Unless otherwise stated the results shown in this test report refer only to the sample(s) tested and such sample(s) are retained for 90 days only.

除非另有說明，此報告結果僅對測試之樣品負責，同時此樣品僅保留90天。本報告未經本公司書面許可，不可部份複製。

This document is issued by the Company subject to its General Conditions of Service printed overleaf, available on request or accessible at <http://www.sgs.com.tw/Terms-and-Conditions> and for electronic format documents, subject to Terms and Conditions for Electronic Documents at <http://www.sgs.com.tw/Terms-and-Conditions>. Attention is drawn to the limitation of liability, indemnification and jurisdiction issues defined therein. Any holder of this document is advised that information contained herein reflects the Company's findings at the time of its intervention only and within the limits of Client's instructions, if any. The Company's sole responsibility is to its Client and this document does not exonerate parties to a transaction from exercising all their rights and obligations under the transaction documents. This document cannot be reproduced except in full, without prior written approval of the Company. Any unauthorized alteration, forgery or falsification of the content or appearance of this document is unlawful and offenders may be prosecuted to the fullest extent of the law.

Band66\_15MHz+20MHz\_OPSK\_RB75-0+RB100-0\_CH132325+CH132496

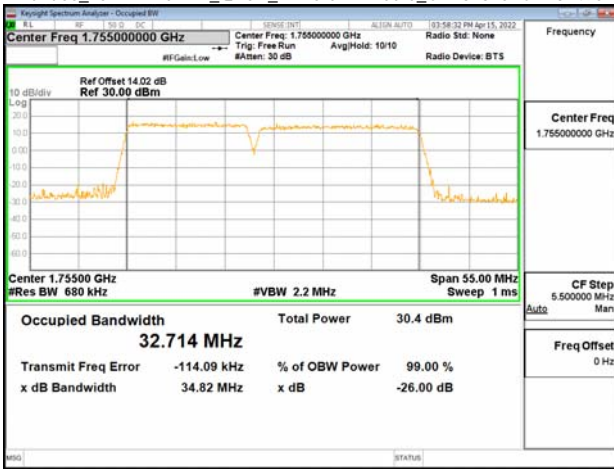

Band66\_20MHz+15MHz\_OPSK\_RB100-0+RB75-0\_CH132348+CH132519



Band66\_15MHz+20MHz\_16QAM\_RB75-0+RB100-0\_CH132325+CH132496

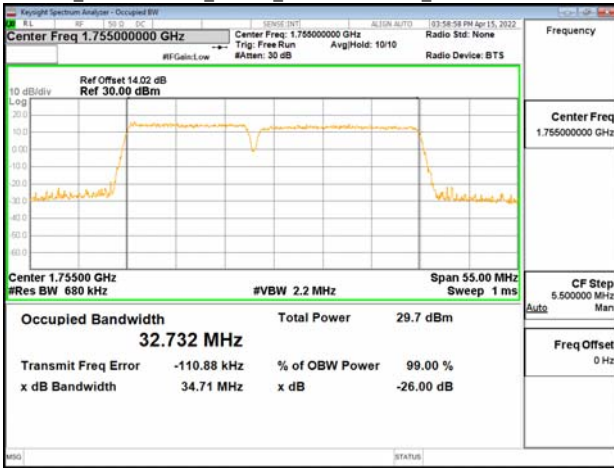

Band66\_20MHz+15MHz\_16QAM\_RB100-0+RB75-0\_CH132348+CH132519

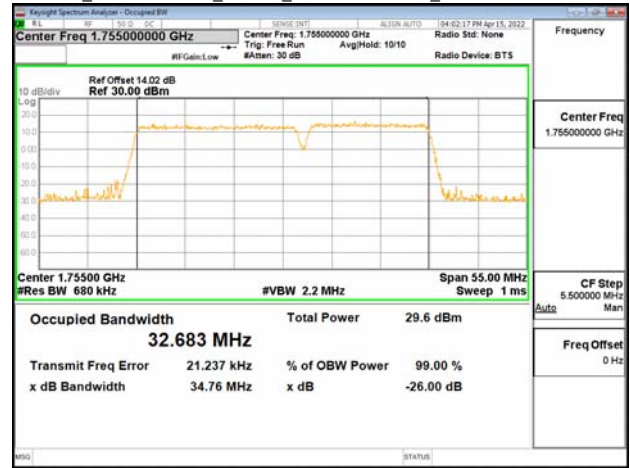

Band66\_15MHz+20MHz\_64QAM\_RB75-0+RB100-0\_CH132325+CH132496

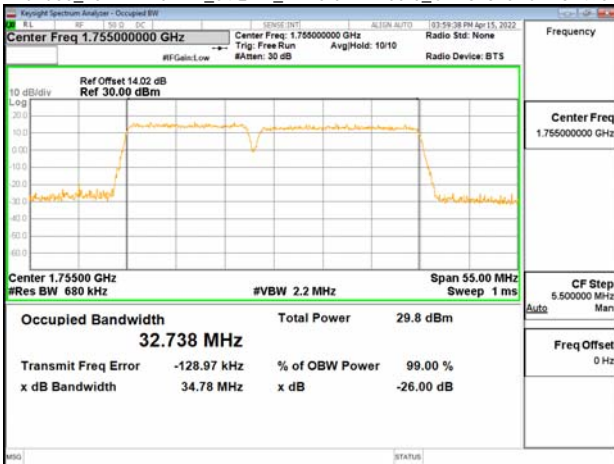

Band66\_20MHz+15MHz\_64QAM\_RB100-0+RB75-0\_CH132348+CH132519



Unless otherwise stated the results shown in this test report refer only to the sample(s) tested and such sample(s) are retained for 90 days only.

除非另有說明，此報告結果僅對測試之樣品負責，同時此樣品僅保留90天。本報告未經本公司書面許可，不可部份複製。

This document is issued by the Company subject to its General Conditions of Service printed overleaf, available on request or accessible at <http://www.sgs.com.tw/Terms-and-Conditions> and for electronic format documents, subject to Terms and Conditions for Electronic Documents at <http://www.sgs.com.tw/Terms-and-Conditions>. Attention is drawn to the limitation of liability, indemnification and jurisdiction issues defined therein. Any holder of this document is advised that information contained herein reflects the Company's findings at the time of its intervention only and within the limits of Client's instructions, if any. The Company's sole responsibility is to its Client and this document does not exonerate parties to a transaction from exercising all their rights and obligations under the transaction documents. This document cannot be reproduced except in full, without prior written approval of the Company. Any unauthorized alteration, forgery or falsification of the content or appearance of this document is unlawful and offenders may be prosecuted to the fullest extent of the law.

Band66\_20MHz+20MHz\_QPSK\_RB100-0+RB100-0\_CH132323+CH132521

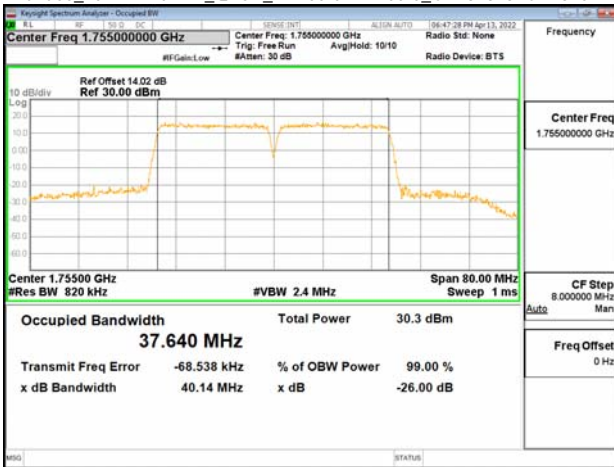

Band66B\_5MHz+5MHz\_QPSK\_RB25-0+RB25-0\_CH132398+CH132446

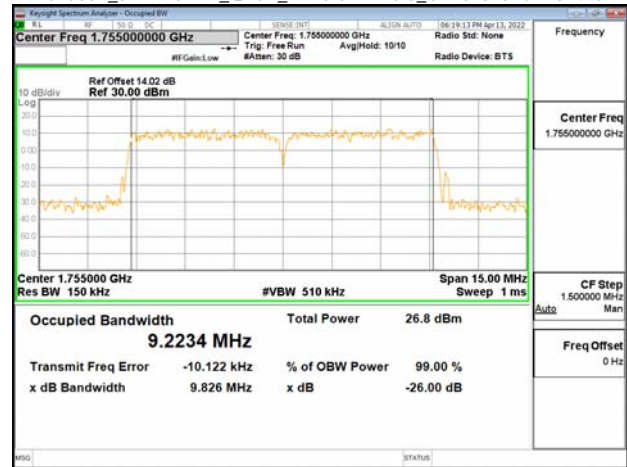

Band66\_20MHz+20MHz\_16QAM\_RB100-0+RB100-0\_CH132323+CH132521

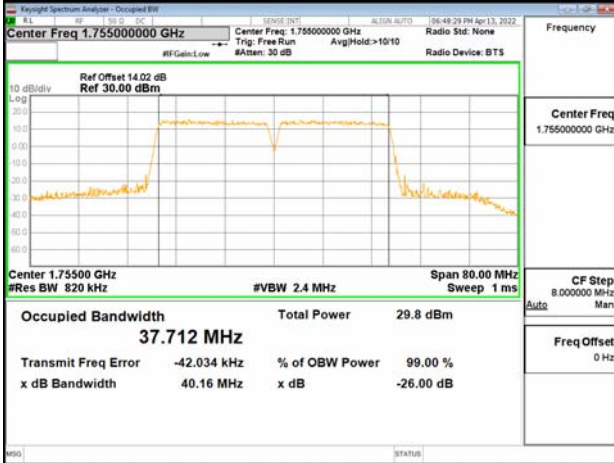

Band66B\_5MHz+5MHz\_16QAM\_RB25-0+RB25-0\_CH132398+CH132446

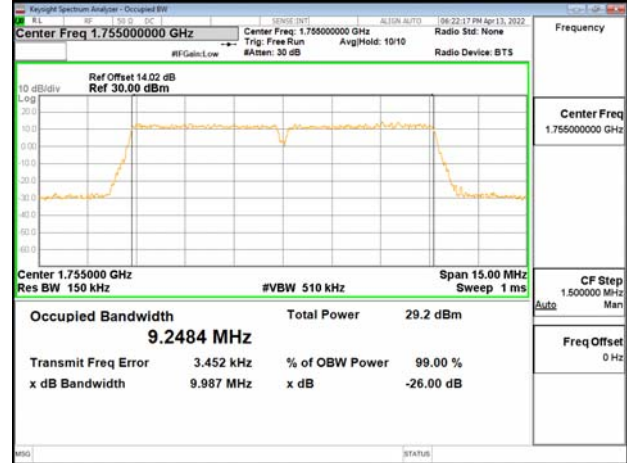

Band66\_20MHz+20MHz\_64QAM\_RB100-0+RB100-0\_CH132323+CH132521



Band66B\_5MHz+5MHz\_64QAM\_RB25-0+RB25-0\_CH132398+CH132446

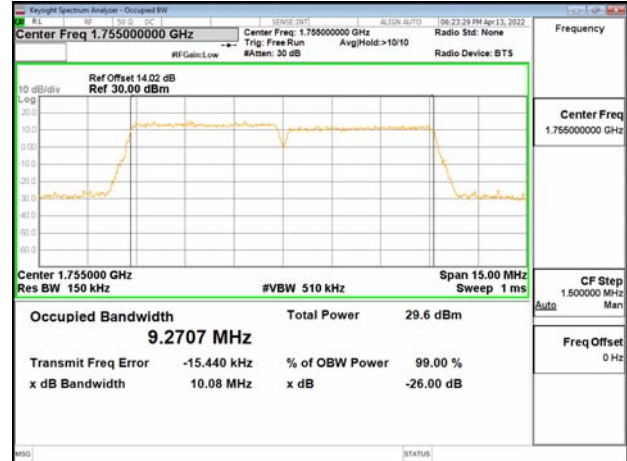

Unless otherwise stated the results shown in this test report refer only to the sample(s) tested and such sample(s) are retained for 90 days only.

除非另有說明，此報告結果僅對測試之樣品負責，同時此樣品僅保留90天。本報告未經本公司書面許可，不可部份複製。

This document is issued by the Company subject to its General Conditions of Service printed overleaf, available on request or accessible at <http://www.sgs.com.tw/Terms-and-Conditions> and for electronic format documents, subject to Terms and Conditions for Electronic Documents at <http://www.sgs.com.tw/Terms-and-Conditions>. Attention is drawn to the limitation of liability, indemnification and jurisdiction issues defined therein. Any holder of this document is advised that information contained herein reflects the Company's findings at the time of its intervention only and within the limits of Client's instructions, if any. The Company's sole responsibility is to its Client and this document does not exonerate parties to a transaction from exercising all their rights and obligations under the transaction documents. This document cannot be reproduced except in full, without prior written approval of the Company. Any unauthorized alteration, forgery or falsification of the content or appearance of this document is unlawful and offenders may be prosecuted to the fullest extent of the law.

Band66B\_5MHz+10MHz\_OPSK\_RB25-0+RB50-0\_CH132375+CH132447

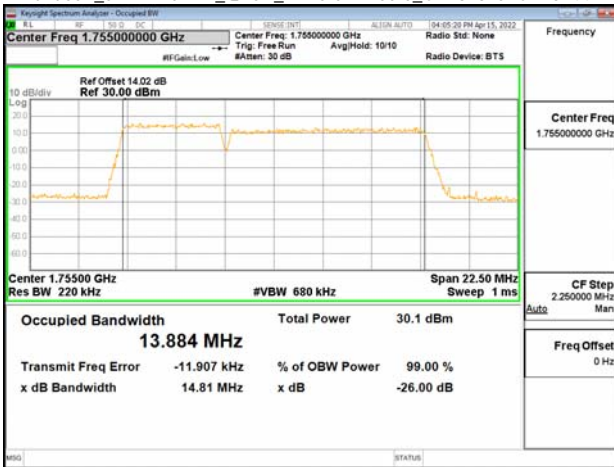

Band66B\_10MHz+5MHz\_OPSK\_RB50-0+RB25-0\_CH132397+CH132469

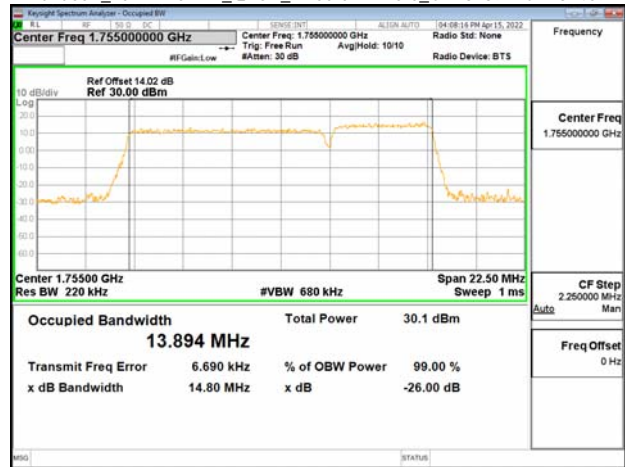

Band66B\_5MHz+10MHz\_16QAM\_RB25-0+RB50-0\_CH132375+CH132447

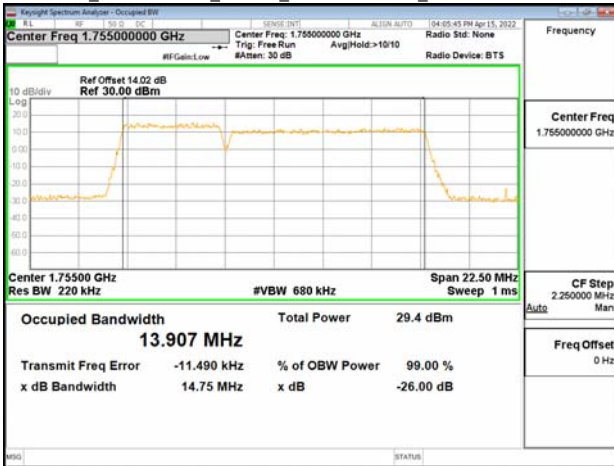

Band66B\_10MHz+5MHz\_16QAM\_RB50-0+RB25-0\_CH132397+CH132469

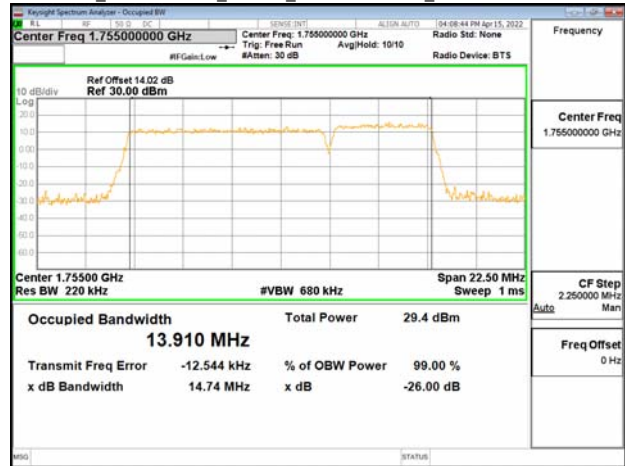

Band66B\_5MHz+10MHz\_64QAM\_RB25-0+RB50-0\_CH132375+CH132447

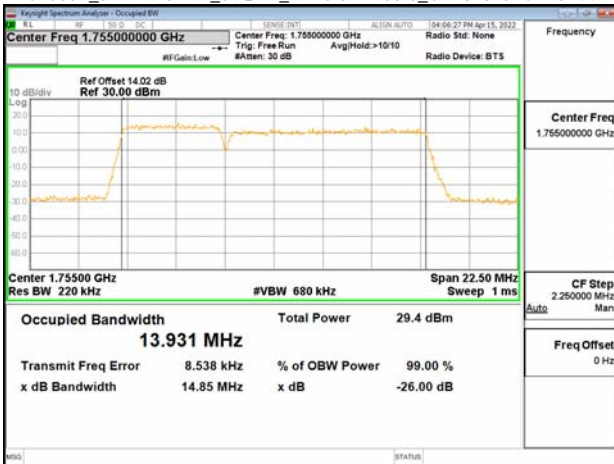

Band66B\_10MHz+5MHz\_64QAM\_RB50-0+RB25-0\_CH132397+CH132469

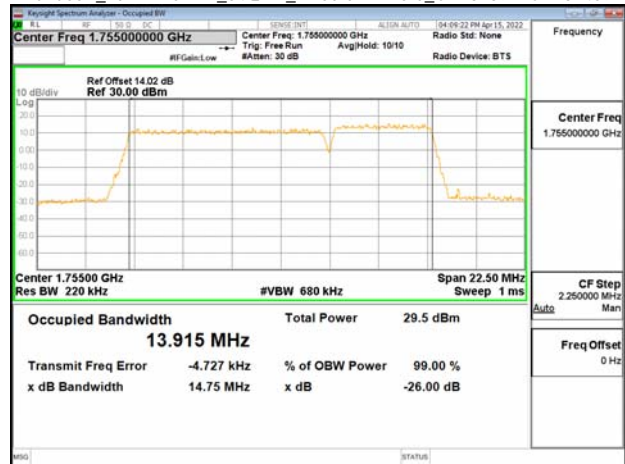

Unless otherwise stated the results shown in this test report refer only to the sample(s) tested and such sample(s) are retained for 90 days only.

除非另有說明，此報告結果僅對測試之樣品負責，同時此樣品僅保留90天。本報告未經本公司書面許可，不可部份複製。

This document is issued by the Company subject to its General Conditions of Service printed overleaf, available on request or accessible at <http://www.sgs.com.tw/Terms-and-Conditions> and for electronic format documents, subject to Terms and Conditions for Electronic Documents at <http://www.sgs.com.tw/Terms-and-Conditions>. Attention is drawn to the limitation of liability, indemnification and jurisdiction issues defined therein. Any holder of this document is advised that information contained herein reflects the Company's findings at the time of its intervention only and within the limits of Client's instructions, if any. The Company's sole responsibility is to its Client and this document does not exonerate parties to a transaction from exercising all their rights and obligations under the transaction documents. This document cannot be reproduced except in full, without prior written approval of the Company. Any unauthorized alteration, forgery or falsification of the content or appearance of this document is unlawful and offenders may be prosecuted to the fullest extent of the law.

Band66B\_5MHz+15MHz\_OPSK\_RB25-0+RB75-0\_CH132353+CH132446

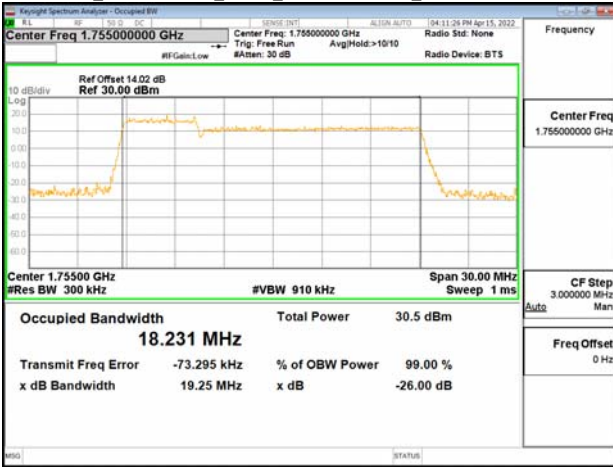

Band66B\_15MHz+5MHz\_OPSK\_RB75-0+RB25-0\_CH132398+CH132491

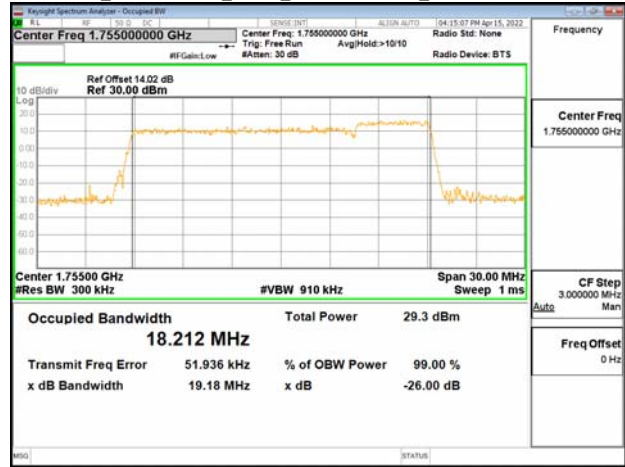

Band66B\_5MHz+15MHz\_16QAM\_RB25-0+RB75-0\_CH132353+CH132446

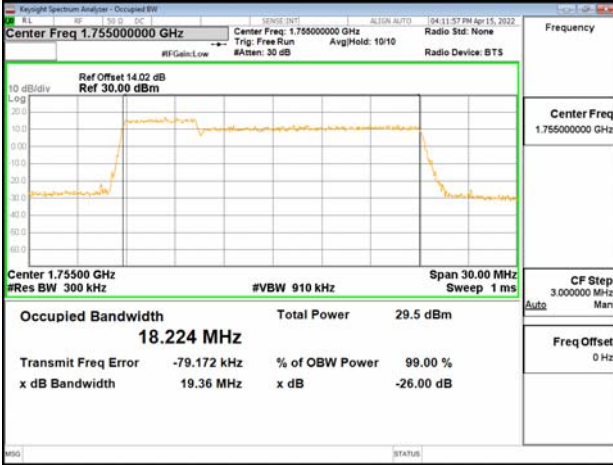

Band66B\_15MHz+5MHz\_16QAM\_RB75-0+RB25-0\_CH132398+CH132491

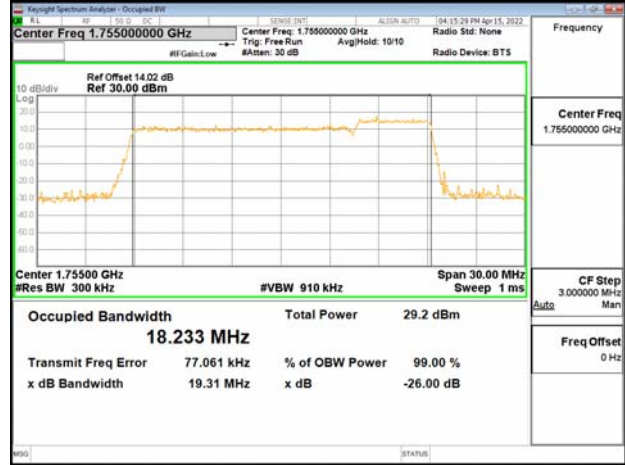

Band66B\_5MHz+15MHz\_64QAM\_RB25-0+RB75-0\_CH132353+CH132446

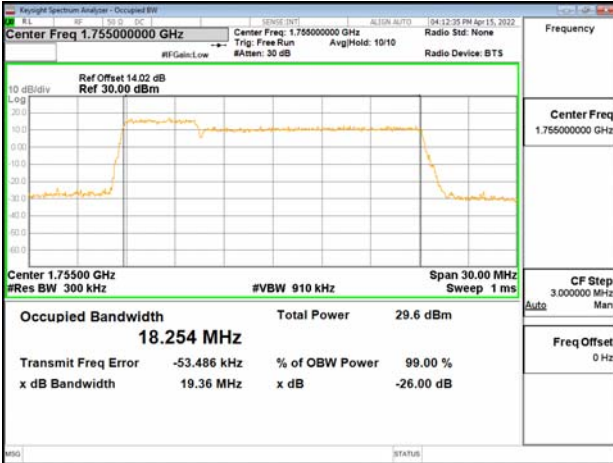

Band66B\_15MHz+5MHz\_64QAM\_RB75-0+RB25-0\_CH132398+CH132491

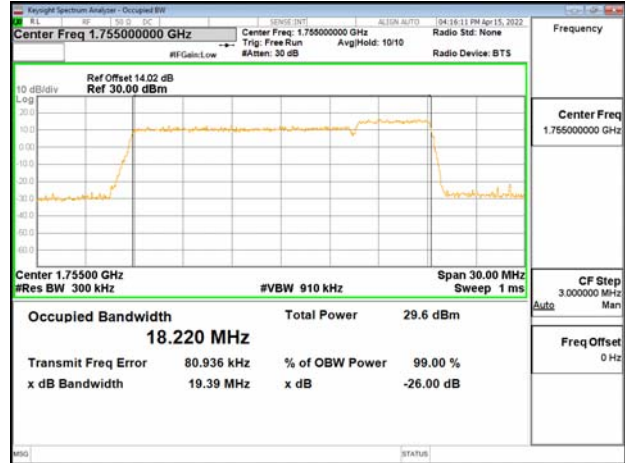

Unless otherwise stated the results shown in this test report refer only to the sample(s) tested and such sample(s) are retained for 90 days only.

除非另有說明，此報告結果僅對測試之樣品負責，同時此樣品僅保留90天。本報告未經本公司書面許可，不可部份複製。

This document is issued by the Company subject to its General Conditions of Service printed overleaf, available on request or accessible at <http://www.sgs.com.tw/Terms-and-Conditions> and for electronic format documents, subject to Terms and Conditions for Electronic Documents at <http://www.sgs.com.tw/Terms-and-Conditions>. Attention is drawn to the limitation of liability, indemnification and jurisdiction issues defined therein. Any holder of this document is advised that information contained herein reflects the Company's findings at the time of its intervention only and within the limits of Client's instructions, if any. The Company's sole responsibility is to its Client and this document does not exonerate parties to a transaction from exercising all their rights and obligations under the transaction documents. This document cannot be reproduced except in full, without prior written approval of the Company. Any unauthorized alteration, forgery or falsification of the content or appearance of this document is unlawful and offenders may be prosecuted to the fullest extent of the law.

Band66B\_10MHz+10MHz\_QPSK\_RB50-0+RB50-0\_CH132373+CH132472

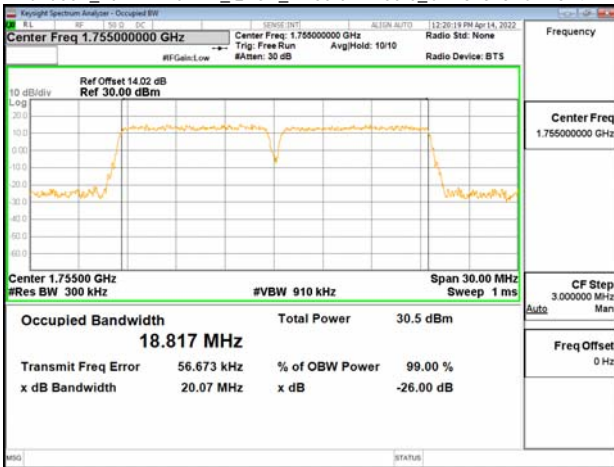

Band66B\_10MHz+10MHz\_16QAM\_RB50-0+RB50-0\_CH132373+CH132472

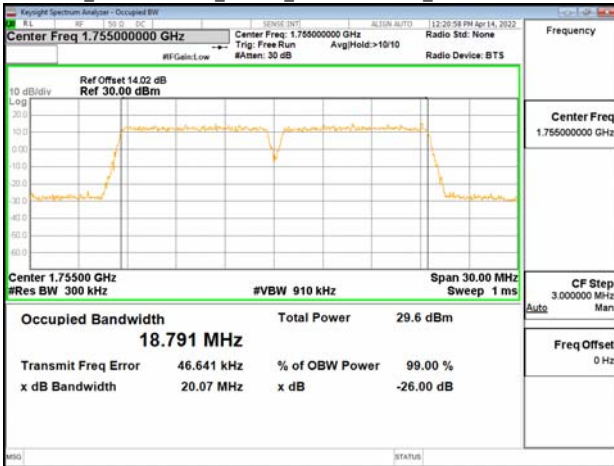

Band66B\_10MHz+10MHz\_64QAM\_RB50-0+RB50-0\_CH132373+CH132472

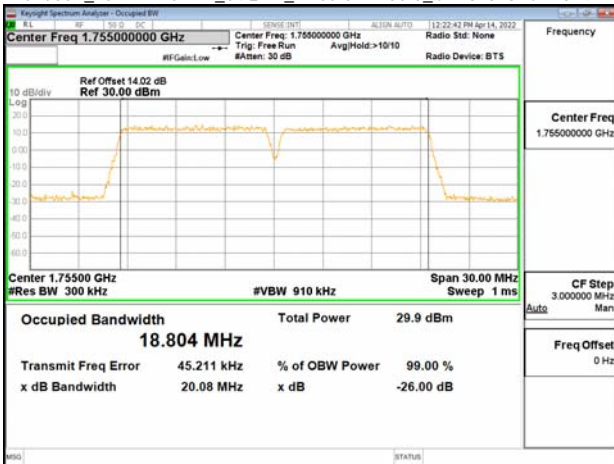

Unless otherwise stated the results shown in this test report refer only to the sample(s) tested and such sample(s) are retained for 90 days only.

除非另有說明，此報告結果僅對測試之樣品負責，同時此樣品僅保留90天。本報告未經本公司書面許可，不可部份複製。

This document is issued by the Company subject to its General Conditions of Service printed overleaf, available on request or accessible at <http://www.sgs.com.tw/Terms-and-Conditions> and for electronic format documents, subject to Terms and Conditions for Electronic Documents at <http://www.sgs.com.tw/Terms-and-Conditions>. Attention is drawn to the limitation of liability, indemnification and jurisdiction issues defined therein. Any holder of this document is advised that information contained hereon reflects the Company's findings at the time of its intervention only and within the limits of Client's instructions, if any. The Company's sole responsibility is to its Client and this document does not exonerate parties to a transaction from exercising all their rights and obligations under the transaction documents. This document cannot be reproduced except in full, without prior written approval of the Company. Any unauthorized alteration, forgery or falsification of the content or appearance of this document is unlawful and offenders may be prosecuted to the fullest extent of the law.

## 9 OUT OF BAND EMISSION AT ANTENNA TERMINALS

### 9.1 Standard Applicable

#### FCC §22.917(a), §27.53(h)

Out of band emissions. The power of any emission outside of the authorized operating frequency ranges must be attenuated below the transmitting power (P) by a factor of at least  $43 + 10 \log(P)$  dB.

#### FCC §27.53(h)(1)

(h) *AWS emission limits*—(1) *General protection levels*. Except as otherwise specified below, for operations in the 1695-1710 MHz, 1710-1755 MHz, 1755-1780 MHz, 1915-1920 MHz, 1995-2000 MHz, 2000-2020 MHz, 2110-2155 MHz, 2155-2180 MHz, and 2180-2200 bands, the power of any emission outside a licensee's frequency block shall be attenuated below the transmitter power (P) in watts by at least  $43 + 10 \log_{10}(P)$  dB.

### 9.2 Test SET-UP

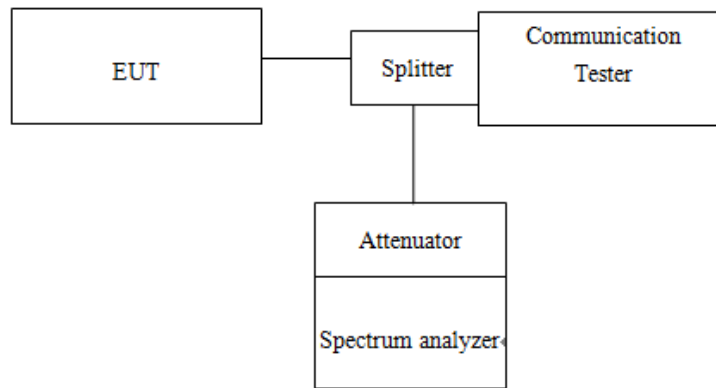

### 9.3 Measurement Procedure

#### 9.3.1 Conducted Emission

The RF output of the transceiver was connected to a spectrum analyzer through appropriate attenuation. The resolution bandwidth of the spectrum analyzer was set at 1MHz, sufficient scans were taken to show the out of band Emissions if any up to 10th harmonic.

1. To connect Antenna Port of EUT to Spectrum.
2. Set RBW = 1MHz & VBW = 1MHz on Spectrum.
3. Allow trace to fully stabilize
4. Repeat above procedures until all default test channel measured were complete.

#### 9.3.2 Band Edge or Mask

1. To connect Antenna Port of EUT to Spectrum.
2. The band edge of low and high channels for the highest RF powers was measured. Setting RBW  $\geq$  1% EBW.
3. Allow trace to fully stabilize
4. Repeat above procedures until all default test channel measured were complete.

Unless otherwise stated the results shown in this test report refer only to the sample(s) tested and such sample(s) are retained for 90 days only.

除非另有說明，此報告結果僅對測試之樣品負責，同時此樣品僅保留90天。本報告未經本公司書面許可，不可部份複製。

This document is issued by the Company subject to its General Conditions of Service printed overleaf, available on request or accessible at <http://www.sgs.com.tw/Terms-and-Conditions> and for electronic format documents, subject to Terms and Conditions for Electronic Documents at <http://www.sgs.com.tw/Terms-and-Conditions>. Attention is drawn to the limitation of liability, indemnification and jurisdiction issues defined therein. Any holder of this document is advised that information contained hereon reflects the Company's findings at the time of its intervention only and within the limits of Client's instructions, if any. The Company's sole responsibility is to its Client and this document does not exonerate parties to a transaction from exercising all their rights and obligations under the transaction documents. This document cannot be reproduced except in full, without prior written approval of the Company. Any unauthorized alteration, forgery or falsification of the content or appearance of this document is unlawful and offenders may be prosecuted to the fullest extent of the law.



#### 9.4 Band Edge Measurement Result:

Refer to next pages.

Unless otherwise stated the results shown in this test report refer only to the sample(s) tested and such sample(s) are retained for 90 days only.

除非另有說明，此報告結果僅對測試之樣品負責，同時此樣品僅保留90天。本報告未經本公司書面許可，不可部份複製。

This document is issued by the Company subject to its General Conditions of Service printed overleaf, available on request or accessible at <http://www.sgs.com.tw/Terms-and-Conditions> and for electronic format documents, subject to Terms and Conditions for Electronic Documents at <http://www.sgs.com.tw/Terms-and-Conditions>. Attention is drawn to the limitation of liability, indemnification and jurisdiction issues defined therein. Any holder of this document is advised that information contained hereon reflects the Company's findings at the time of its intervention only and within the limits of Client's instructions, if any. The Company's sole responsibility is to its Client and this document does not exonerate parties to a transaction from exercising all their rights and obligations under the transaction documents. This document cannot be reproduced except in full, without prior written approval of the Company. Any unauthorized alteration, forgery or falsification of the content or appearance of this document is unlawful and offenders may be prosecuted to the fullest extent of the law.

Band5\_5MHz+10MHz\_QPSK\_RB1-0\_1-0\_CH20428-20500

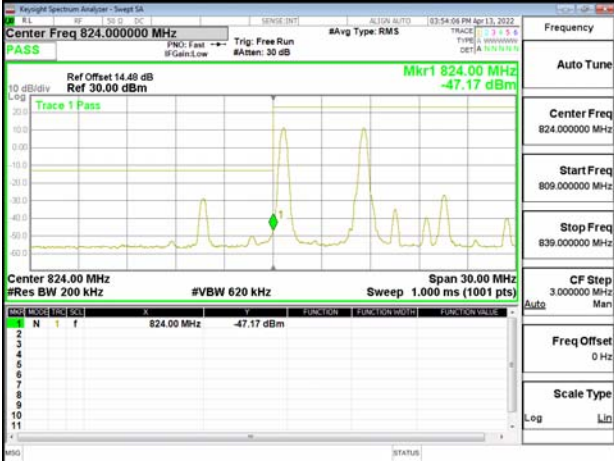

Band5\_5MHz+10MHz\_QPSK\_RB25-0\_50-0\_CH20528-20600

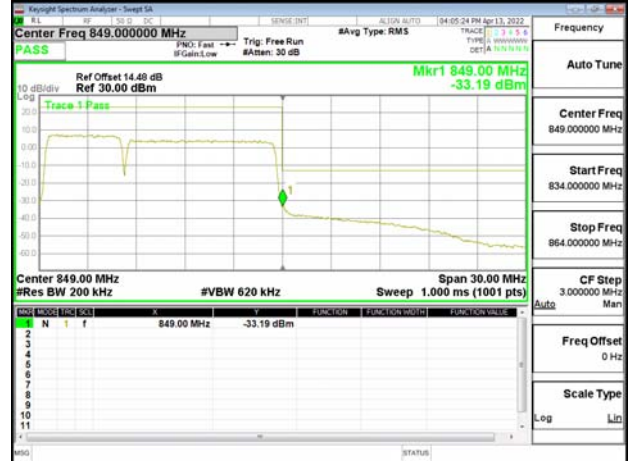

Band5\_5MHz+10MHz\_QPSK\_RB1-24\_1-49\_CH20528-20600

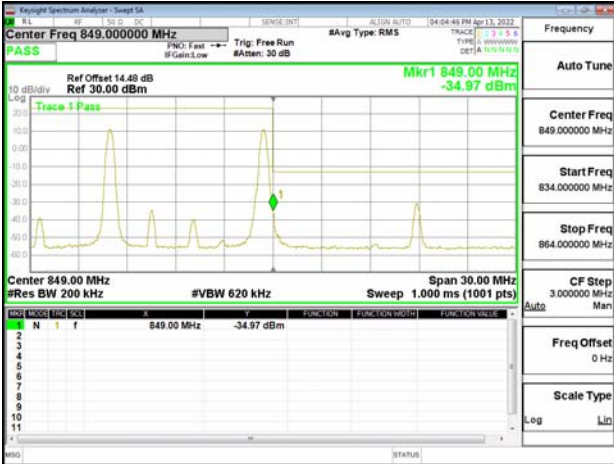

Band5\_10MHz+10MHz\_QPSK\_RB1-0\_1-0\_CH20450-20549

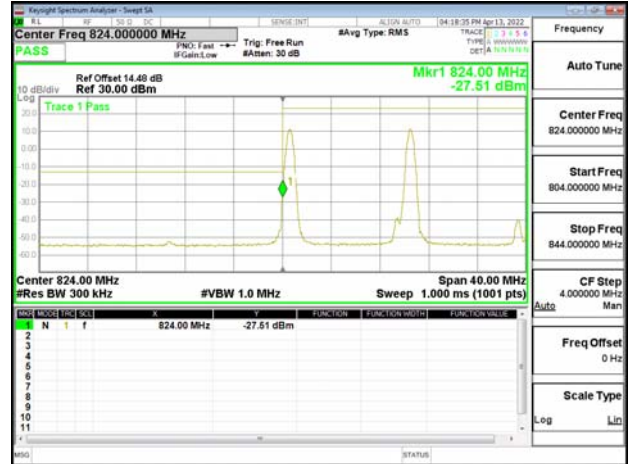

Band5\_5MHz+10MHz\_QPSK\_RB25-0\_50-0\_CH20428-20500

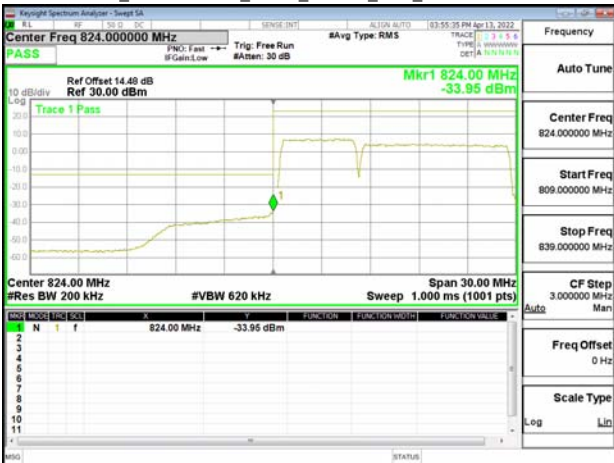

Band5\_10MHz+10MHz\_QPSK\_RB1-49\_1-49\_CH20501-20600

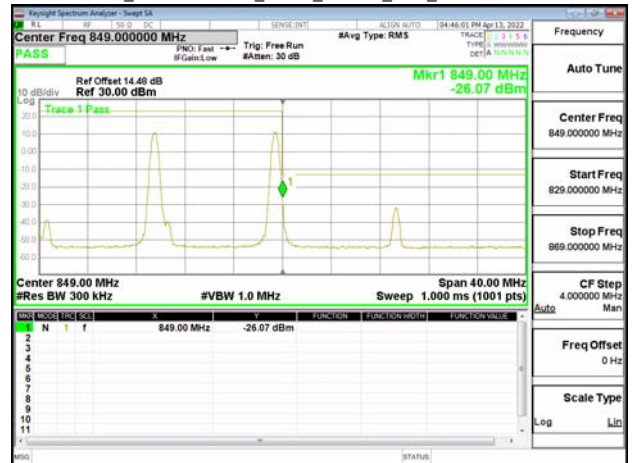

Unless otherwise stated the results shown in this test report refer only to the sample(s) tested and such sample(s) are retained for 90 days only.

除非另有說明，此報告結果僅對測試之樣品負責，同時此樣品僅保留90天。本報告未經本公司書面許可，不可部份複製。

This document is issued by the Company subject to its General Conditions of Service printed overleaf, available on request or accessible at <http://www.sgs.com.tw/Terms-and-Conditions> and for electronic format documents, subject to Terms and Conditions for Electronic Documents at <http://www.sgs.com.tw/Terms-and-Conditions>. Attention is drawn to the limitation of liability, indemnification and jurisdiction issues defined therein. Any holder of this document is advised that information contained herein reflects the Company's findings at the time of its intervention only and within the limits of Client's instructions, if any. The Company's sole responsibility is to its Client and this document does not exonerate parties to a transaction from exercising all their rights and obligations under the transaction documents. This document cannot be reproduced except in full, without prior written approval of the Company. Any unauthorized alteration, forgery or falsification of the content or appearance of this document is unlawful and offenders may be prosecuted to the fullest extent of the law.

Band5\_10MHz+10MHz\_QPSK\_RB50-0\_50-0\_CH20450-20549

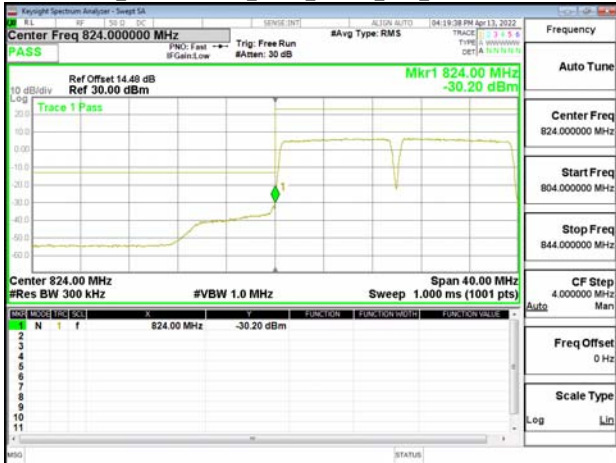

Band66\_20MHz+10MHz\_QPSK\_RB1-99\_1-49\_CH132473-132617

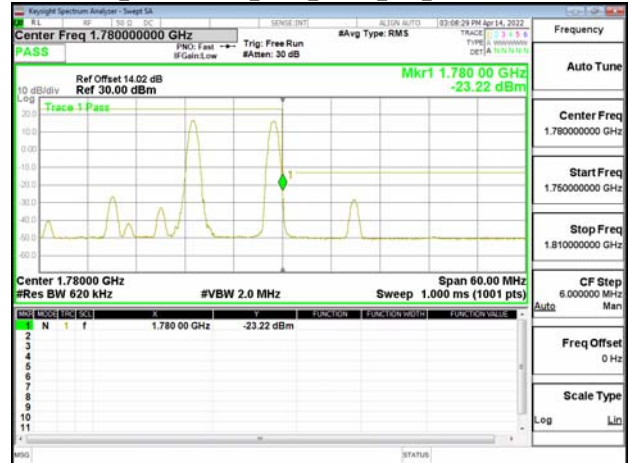

Band5\_10MHz+10MHz\_QPSK\_RB50-0\_50-0\_CH20501-20600



Band66\_20MHz+10MHz\_QPSK\_RB100-0\_50-0\_CH132072-132216



Band66\_20MHz+10MHz\_QPSK\_RB1-0\_1-0\_CH132072-132216

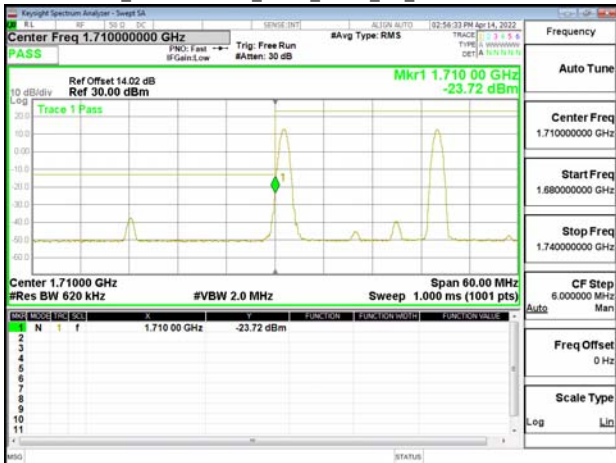

Band66\_20MHz+10MHz\_QPSK\_RB100-0\_50-0\_CH132473-132617

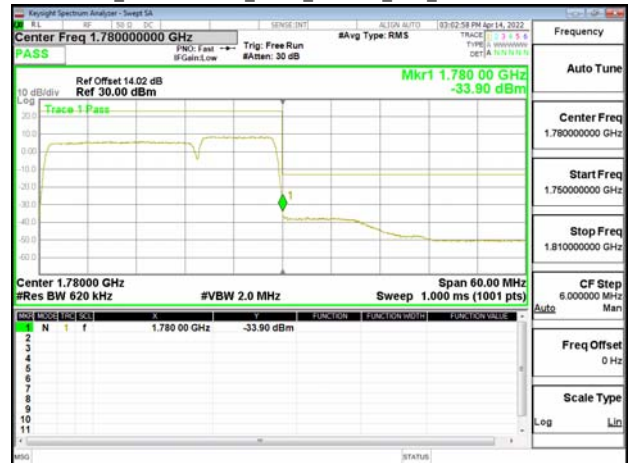

Unless otherwise stated the results shown in this test report refer only to the sample(s) tested and such sample(s) are retained for 90 days only.

除非另有說明，此報告結果僅對測試之樣品負責，同時此樣品僅保留90天。本報告未經本公司書面許可，不可部份複製。

This document is issued by the Company subject to its General Conditions of Service printed overleaf, available on request or accessible at <http://www.sgs.com.tw/Terms-and-Conditions> and for electronic format documents, subject to Terms and Conditions for Electronic Documents at <http://www.sgs.com.tw/Terms-and-Conditions>. Attention is drawn to the limitation of liability, indemnification and jurisdiction issues defined therein. Any holder of this document is advised that information contained herein reflects the Company's findings at the time of its intervention only and within the limits of Client's instructions, if any. The Company's sole responsibility is to its Client and this document does not exonerate parties to a transaction from exercising all their rights and obligations under the transaction documents. This document cannot be reproduced except in full, without prior written approval of the Company. Any unauthorized alteration, forgery or falsification of the content or appearance of this document is unlawful and offenders may be prosecuted to the fullest extent of the law.

Band66\_20MHz+20MHz\_QPSK\_RB1-0\_1-0\_CH132072-132270

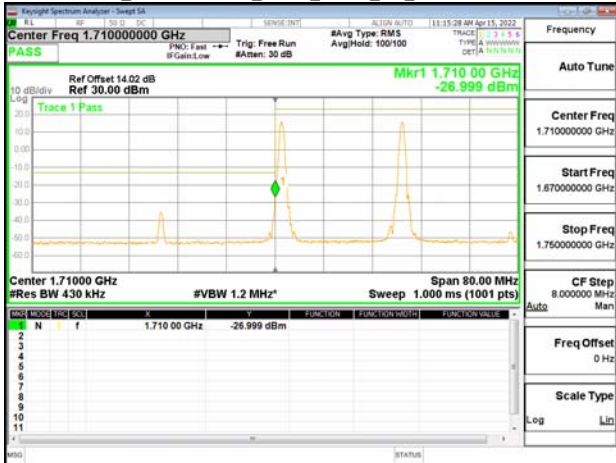

Band66\_20MHz+20MHz\_QPSK\_RB100-0\_100-0\_CH132374-132572



Band66\_20MHz+20MHz\_QPSK\_RB1-99\_1-99\_CH132374-132572

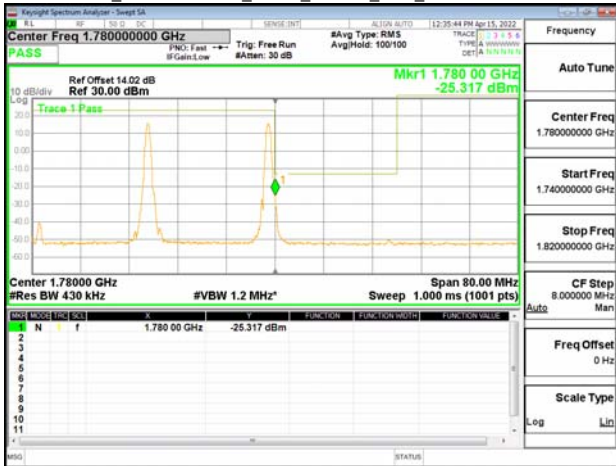

Band66B\_5MHz+5MHz\_QPSK\_RB1-0\_1-0\_CH131997-132045

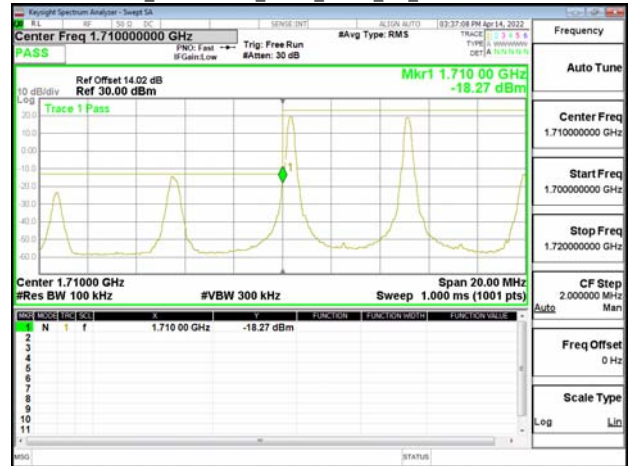

Band66\_20MHz+20MHz\_QPSK\_RB100-0\_100-0\_CH132072-132270

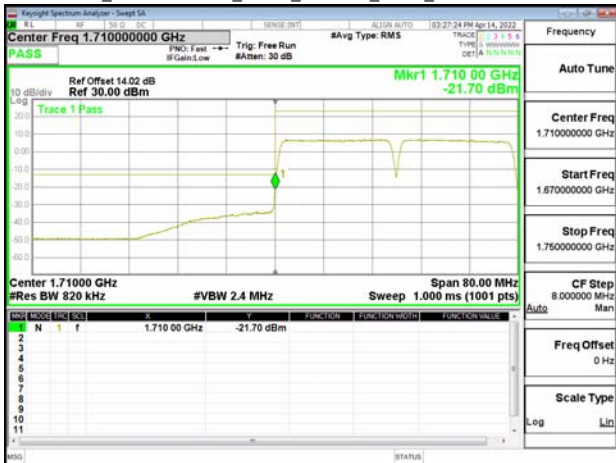

Band66B\_5MHz+5MHz\_QPSK\_RB1-24\_1-24\_CH132599-132647

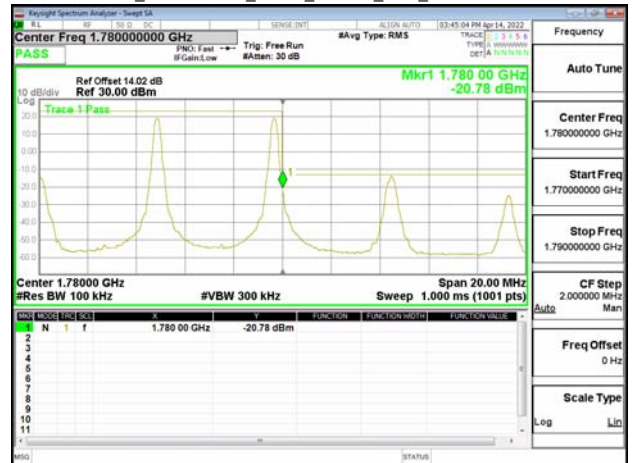

Unless otherwise stated the results shown in this test report refer only to the sample(s) tested and such sample(s) are retained for 90 days only.

除非另有說明，此報告結果僅對測試之樣品負責，同時此樣品僅保留90天。本報告未經本公司書面許可，不可部份複製。

This document is issued by the Company subject to its General Conditions of Service printed overleaf, available on request or accessible at <http://www.sgs.com.tw/Terms-and-Conditions> and for electronic format documents, subject to Terms and Conditions for Electronic Documents at <http://www.sgs.com.tw/Terms-and-Conditions>. Attention is drawn to the limitation of liability, indemnification and jurisdiction issues defined therein. Any holder of this document is advised that information contained herein reflects the Company's findings at the time of its intervention only and within the limits of Client's instructions, if any. The Company's sole responsibility is to its Client and this document does not exonerate parties to a transaction from exercising all their rights and obligations under the transaction documents. This document cannot be reproduced except in full, without prior written approval of the Company. Any unauthorized alteration, forgery or falsification of the content or appearance of this document is unlawful and offenders may be prosecuted to the fullest extent of the law.

Band66B\_5MHz+5MHz\_QPSK\_RB25-0\_25-0\_CH131997-132045

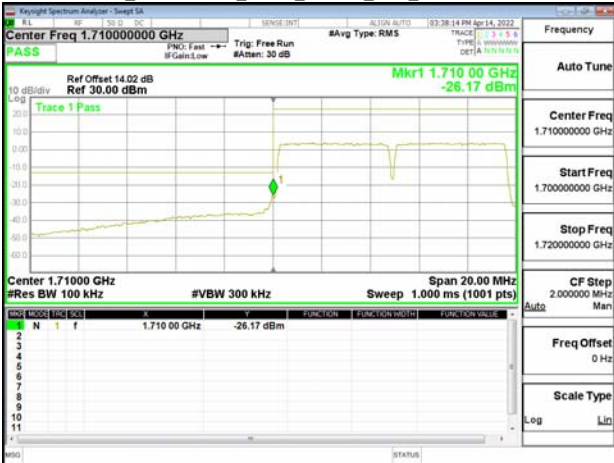

Band66B\_10MHz+10MHz\_QPSK\_RB1-49\_1-49\_CH132523-132622

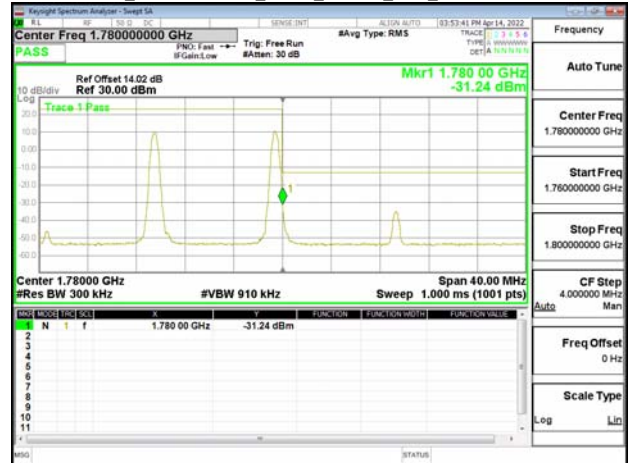

Band66B\_5MHz+5MHz\_QPSK\_RB25-0\_25-0\_CH132599-132647

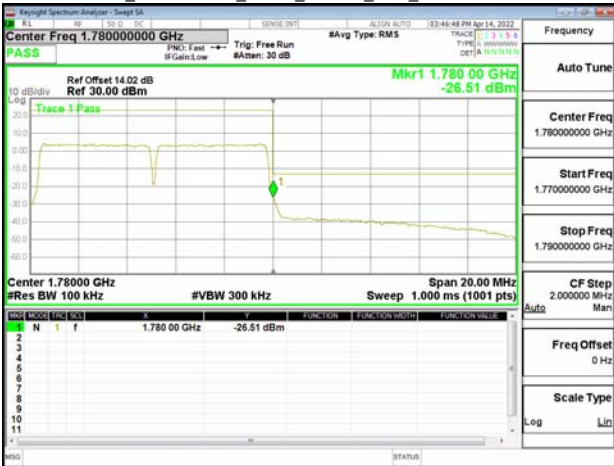

Band66B\_10MHz+10MHz\_QPSK\_RB50-0\_50-0\_CH132022-132121



Band66B\_10MHz+10MHz\_QPSK\_RB1-0\_1-0\_CH132022-132121

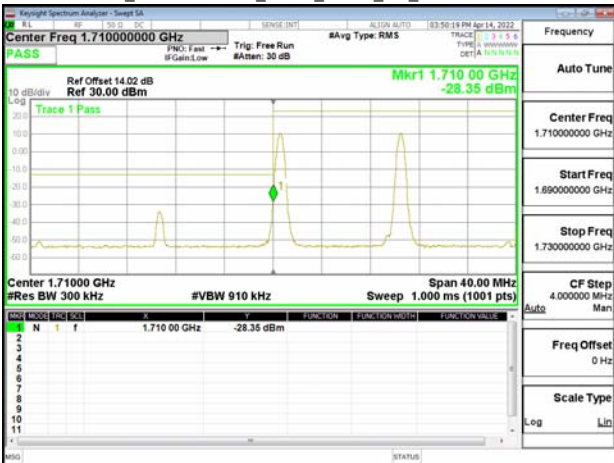

Band66B\_10MHz+10MHz\_QPSK\_RB50-0\_50-0\_CH132523-132622

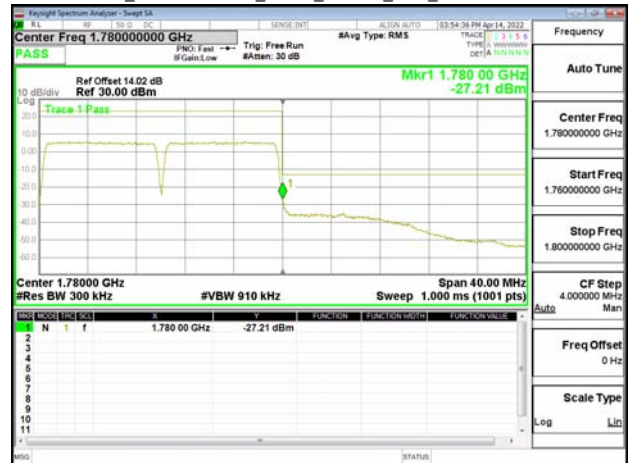

Unless otherwise stated the results shown in this test report refer only to the sample(s) tested and such sample(s) are retained for 90 days only.

除非另有說明，此報告結果僅對測試之樣品負責，同時此樣品僅保留90天。本報告未經本公司書面許可，不可部份複製。

This document is issued by the Company subject to its General Conditions of Service printed overleaf, available on request or accessible at <http://www.sgs.com.tw/Terms-and-Conditions> and for electronic format documents, subject to Terms and Conditions for Electronic Documents at <http://www.sgs.com.tw/Terms-and-Conditions>. Attention is drawn to the limitation of liability, indemnification and jurisdiction issues defined therein. Any holder of this document is advised that information contained herein reflects the Company's findings at the time of its intervention only and within the limits of Client's instructions, if any. The Company's sole responsibility is to its Client and this document does not exonerate parties to a transaction from exercising all their rights and obligations under the transaction documents. This document cannot be reproduced except in full, without prior written approval of the Company. Any unauthorized alteration, forgery or falsification of the content or appearance of this document is unlawful and offenders may be prosecuted to the fullest extent of the law.

## 9.5 Spurious Emission Measurement Result:

Refer to next pages.

Unless otherwise stated the results shown in this test report refer only to the sample(s) tested and such sample(s) are retained for 90 days only.

除非另有說明，此報告結果僅對測試之樣品負責，同時此樣品僅保留90天。本報告未經本公司書面許可，不可部份複製。

This document is issued by the Company subject to its General Conditions of Service printed overleaf, available on request or accessible at <http://www.sgs.com.tw/Terms-and-Conditions> and for electronic format documents, subject to Terms and Conditions for Electronic Documents at <http://www.sgs.com.tw/Terms-and-Conditions>. Attention is drawn to the limitation of liability, indemnification and jurisdiction issues defined therein. Any holder of this document is advised that information contained hereon reflects the Company's findings at the time of its intervention only and within the limits of Client's instructions, if any. The Company's sole responsibility is to its Client and this document does not exonerate parties to a transaction from exercising all their rights and obligations under the transaction documents. This document cannot be reproduced except in full, without prior written approval of the Company. Any unauthorized alteration, forgery or falsification of the content or appearance of this document is unlawful and offenders may be prosecuted to the fullest extent of the law.

Band5\_5MHz+10MHz\_QPSK\_RB1-24\_1-0\_CH20428-20500

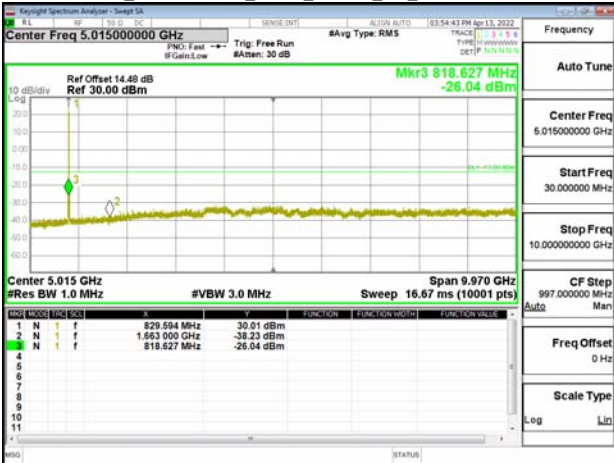

Band5\_10MHz+10MHz\_QPSK\_RB1-49\_1-0\_CH20450-20549

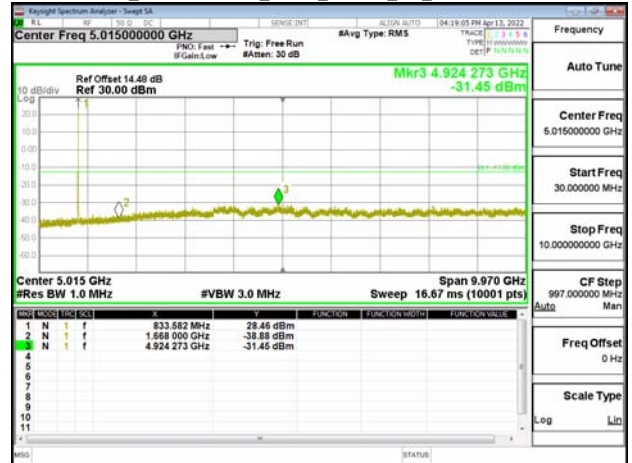

Band5\_5MHz+10MHz\_QPSK\_RB1-24\_1-0\_CH20478-20550



Band5\_10MHz+10MHz\_QPSK\_RB1-49\_1-0\_CH20476-20575

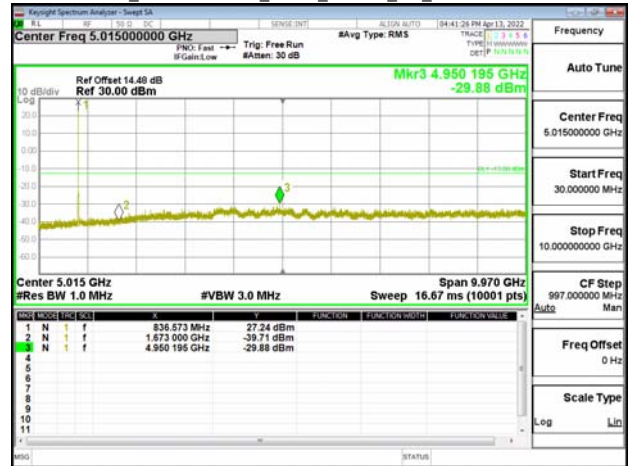

Band5\_5MHz+10MHz\_QPSK\_RB1-24\_1-0\_CH20528-20600



Band5\_10MHz+10MHz\_QPSK\_RB1-49\_1-0\_CH20501-20600



Unless otherwise stated the results shown in this test report refer only to the sample(s) tested and such sample(s) are retained for 90 days only.

除非另有說明，此報告結果僅對測試之樣品負責，同時此樣品僅保留90天。本報告未經本公司書面許可，不可部份複製。

This document is issued by the Company subject to its General Conditions of Service printed overleaf, available on request or accessible at <http://www.sgs.com.tw/Terms-and-Conditions> and for electronic format documents, subject to Terms and Conditions for Electronic Documents at <http://www.sgs.com.tw/Terms-and-Conditions>. Attention is drawn to the limitation of liability, indemnification and jurisdiction issues defined therein. Any holder of this document is advised that information contained herein reflects the Company's findings at the time of its intervention only and within the limits of Client's instructions, if any. The Company's sole responsibility is to its Client and this document does not exonerate parties to a transaction from exercising all their rights and obligations under the transaction documents. This document cannot be reproduced except in full, without prior written approval of the Company. Any unauthorized alteration, forgery or falsification of the content or appearance of this document is unlawful and offenders may be prosecuted to the fullest extent of the law.

Band66\_20MHz+10MHz\_QPSK\_RB1-99\_1-0\_CH132072-132216

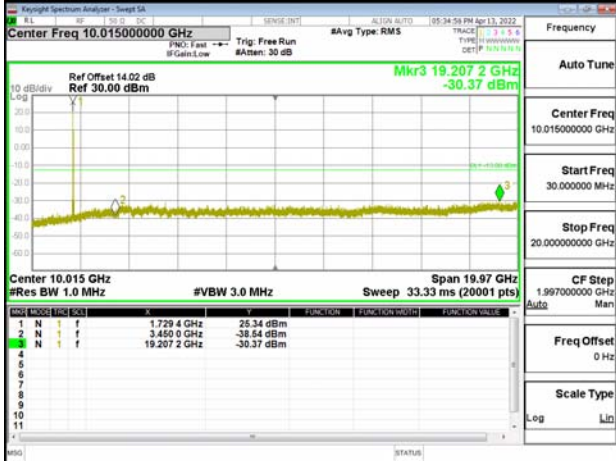

Band66\_20MHz+20MHz\_QPSK\_RB1-99\_1-0\_CH132072-132270

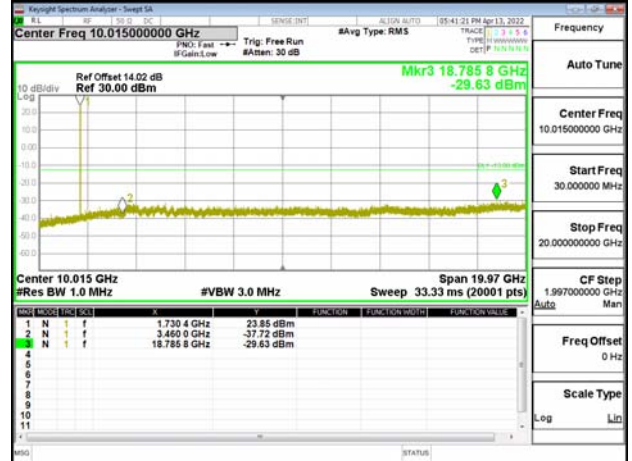

Band66\_20MHz+10MHz\_QPSK\_RB1-99\_1-0\_CH132373-132517

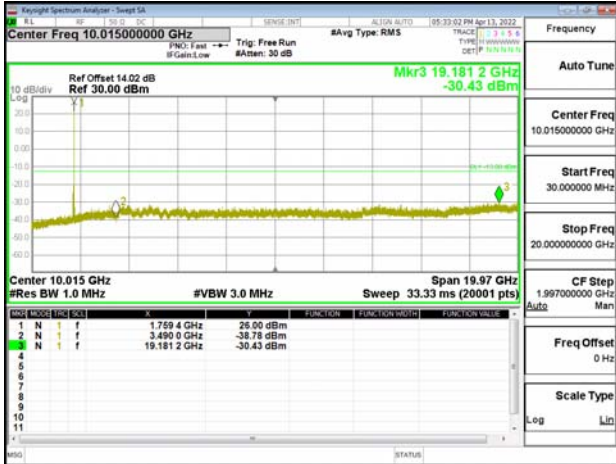

Band66\_20MHz+20MHz\_QPSK\_RB1-99\_1-0\_CH132323-132521

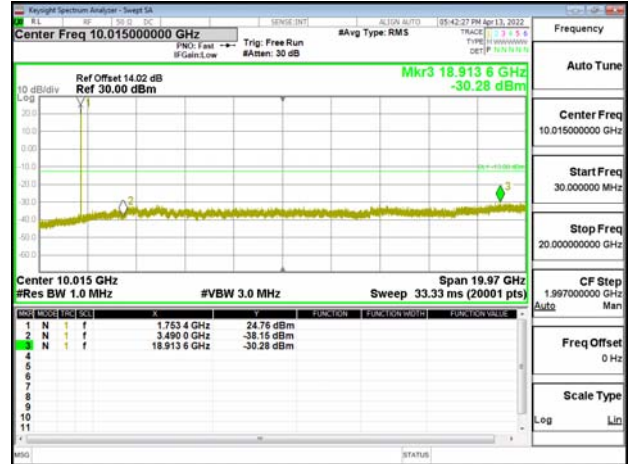

Band66\_20MHz+10MHz\_QPSK\_RB1-99\_1-0\_CH132473-132617

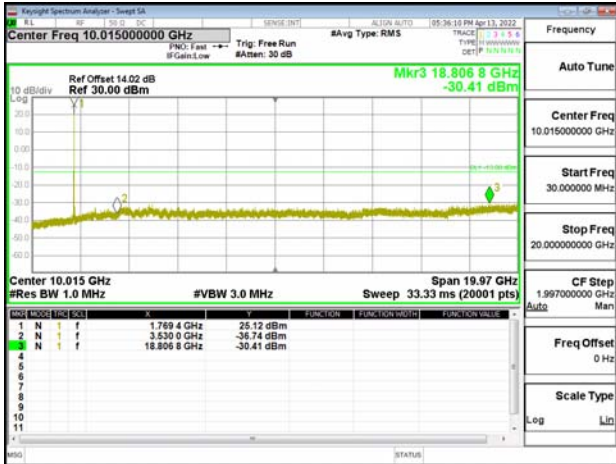

Band66\_20MHz+20MHz\_QPSK\_RB1-99\_1-0\_CH132374-132572

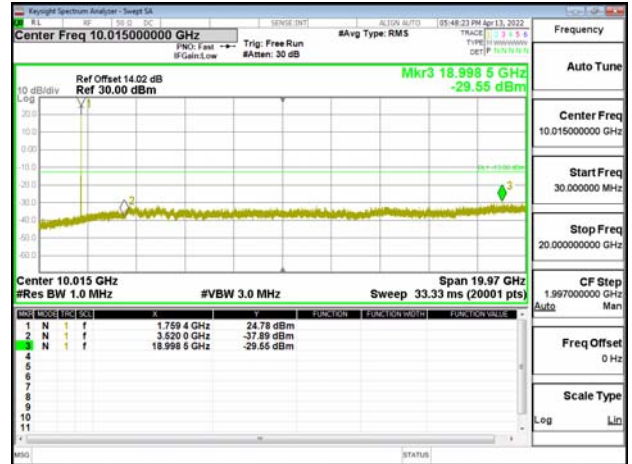

Unless otherwise stated the results shown in this test report refer only to the sample(s) tested and such sample(s) are retained for 90 days only.

除非另有說明，此報告結果僅對測試之樣品負責，同時此樣品僅保留90天。本報告未經本公司書面許可，不可部份複製。

This document is issued by the Company subject to its General Conditions of Service printed overleaf, available on request or accessible at <http://www.sgs.com.tw/Terms-and-Conditions> and for electronic format documents, subject to Terms and Conditions for Electronic Documents at <http://www.sgs.com.tw/Terms-and-Conditions>. Attention is drawn to the limitation of liability, indemnification and jurisdiction issues defined therein. Any holder of this document is advised that information contained herein reflects the Company's findings at the time of its intervention only and within the limits of Client's instructions, if any. The Company's sole responsibility is to its Client and this document does not exonerate parties to a transaction from exercising all their rights and obligations under the transaction documents. This document cannot be reproduced except in full, without prior written approval of the Company. Any unauthorized alteration, forgery or falsification of the content or appearance of this document is unlawful and offenders may be prosecuted to the fullest extent of the law.



Band66B\_5MHz+5MHz\_OPSK\_RB1-24\_1-0\_CH131997-132045

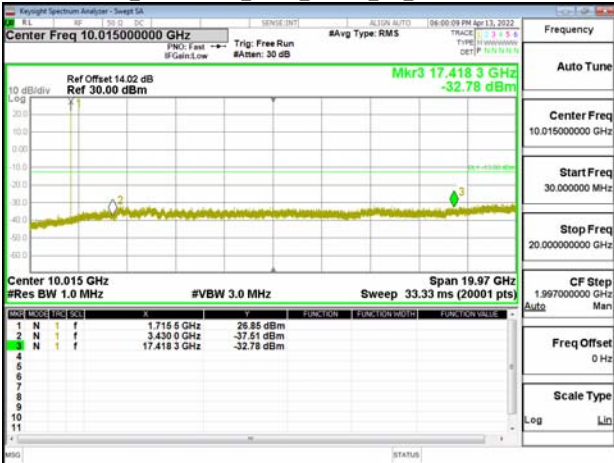

Band66B\_10MHz+10MHz\_OPSK\_RB1-49\_1-0\_CH132022-132121

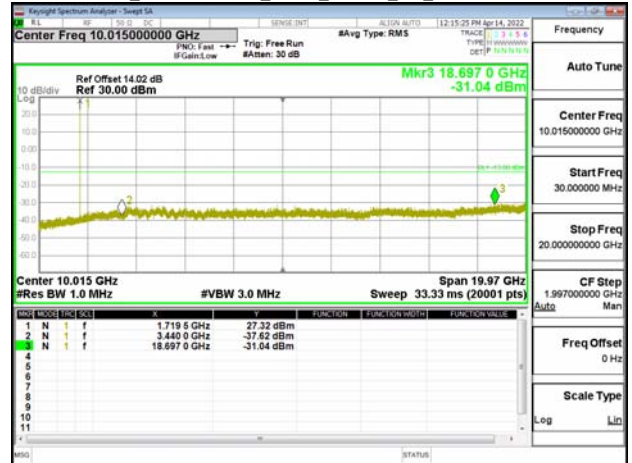

Band66B\_5MHz+5MHz\_OPSK\_RB1-24\_1-0\_CH132398-132446

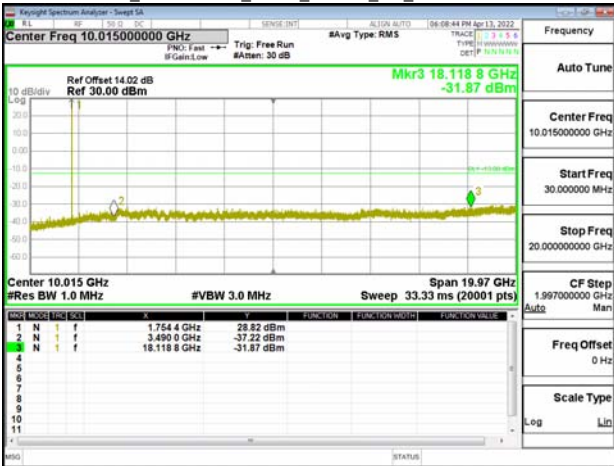

Band66B\_10MHz+10MHz\_OPSK\_RB1-49\_1-0\_CH132373-132472

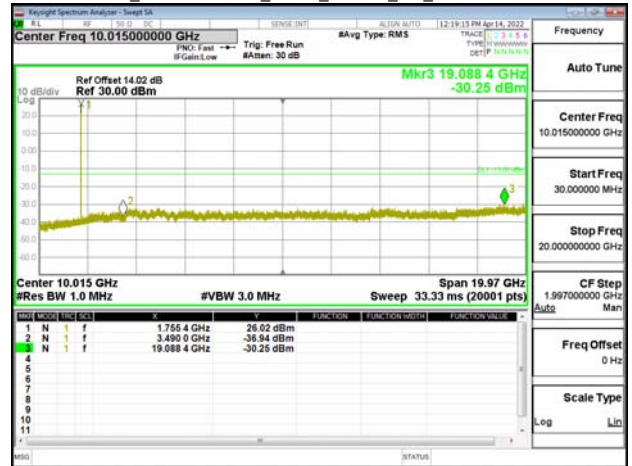

Band66B\_5MHz+5MHz\_OPSK\_RB1-24\_1-0\_CH132599-132647

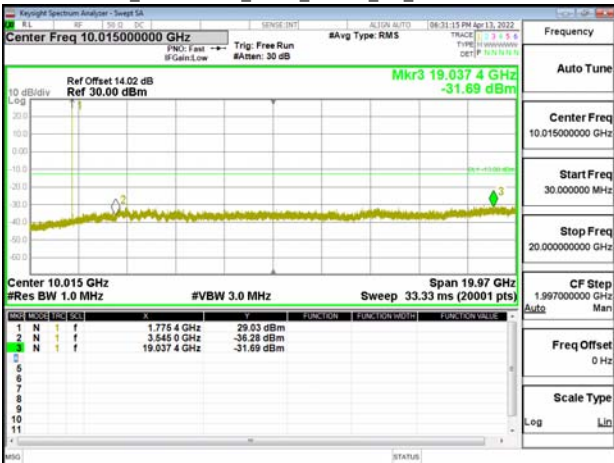

Band66B\_10MHz+10MHz\_OPSK\_RB1-49\_1-0\_CH132523-132622

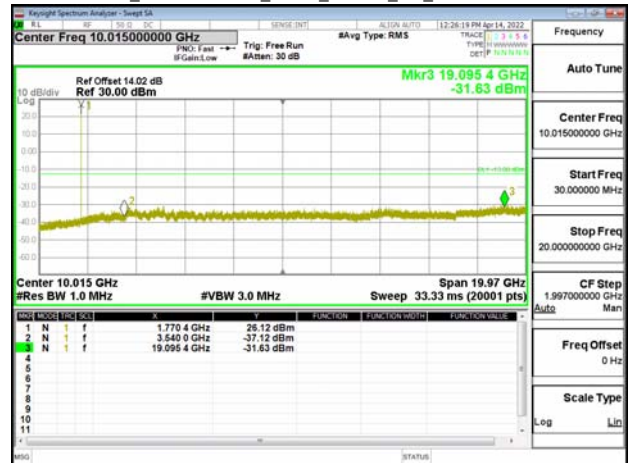

Unless otherwise stated the results shown in this test report refer only to the sample(s) tested and such sample(s) are retained for 90 days only.

除非另有說明，此報告結果僅對測試之樣品負責，同時此樣品僅保留90天。本報告未經本公司書面許可，不可部份複製。

This document is issued by the Company subject to its General Conditions of Service printed overleaf, available on request or accessible at <http://www.sgs.com.tw/Terms-and-Conditions> and for electronic format documents, subject to Terms and Conditions for Electronic Documents at <http://www.sgs.com.tw/Terms-and-Conditions>. Attention is drawn to the limitation of liability, indemnification and jurisdiction issues defined therein. Any holder of this document is advised that information contained herein reflects the Company's findings at the time of its intervention only and within the limits of Client's instructions, if any. The Company's sole responsibility is to its Client and this document does not exonerate parties to a transaction from exercising all their rights and obligations under the transaction documents. This document cannot be reproduced except in full, without prior written approval of the Company. Any unauthorized alteration, forgery or falsification of the content or appearance of this document is unlawful and offenders may be prosecuted to the fullest extent of the law.

## 10 FIELD STRENGTH OF SPURIOUS RADIATION MEASUREMENT

### 10.1 Standard Applicable

According to FCC §2.1053,

**FCC §22.917(a), §27.53(h)**

Out of band emissions. The power of any emission outside of the authorized operating frequency ranges must be attenuated below the transmitting power (P) by a factor of at least  $43 + 10 \log(P)$  dB.

**FCC §27.53(h)(1)**

(h) *AWS emission limits*—(1) *General protection levels*. Except as otherwise specified below, for operations in the 1695-1710 MHz, 1710-1755 MHz, 1755-1780 MHz, 1915-1920 MHz, 1995-2000 MHz, 2000-2020 MHz, 2110-2155 MHz, 2155-2180 MHz, and 2180-2200 bands, the power of any emission outside a licensee's frequency block shall be attenuated below the transmitter power (P) in watts by at least  $43 + 10 \log_{10}(P)$  dB.

Unless otherwise stated the results shown in this test report refer only to the sample(s) tested and such sample(s) are retained for 90 days only.

除非另有說明，此報告結果僅對測試之樣品負責，同時此樣品僅保留90天。本報告未經本公司書面許可，不可部份複製。

This document is issued by the Company subject to its General Conditions of Service printed overleaf, available on request or accessible at <http://www.sgs.com.tw/Terms-and-Conditions> and for electronic format documents, subject to Terms and Conditions for Electronic Documents at <http://www.sgs.com.tw/Terms-and-Conditions>. Attention is drawn to the limitation of liability, indemnification and jurisdiction issues defined therein. Any holder of this document is advised that information contained hereon reflects the Company's findings at the time of its intervention only and within the limits of Client's instructions, if any. The Company's sole responsibility is to its Client and this document does not exonerate parties to a transaction from exercising all their rights and obligations under the transaction documents. This document cannot be reproduced except in full, without prior written approval of the Company. Any unauthorized alteration, forgery or falsification of the content or appearance of this document is unlawful and offenders may be prosecuted to the fullest extent of the law.

## 10.2 EUT Setup

Radiated Emission Test Set-Up, Frequency From 30MHz to 1000MHz.

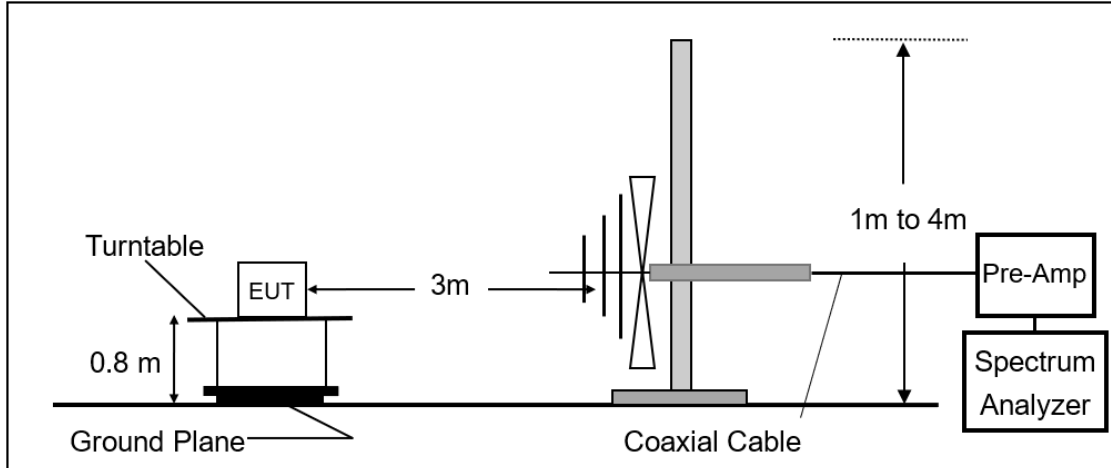

Radiated Emission Test Set-Up, Frequency Above 1GHz.

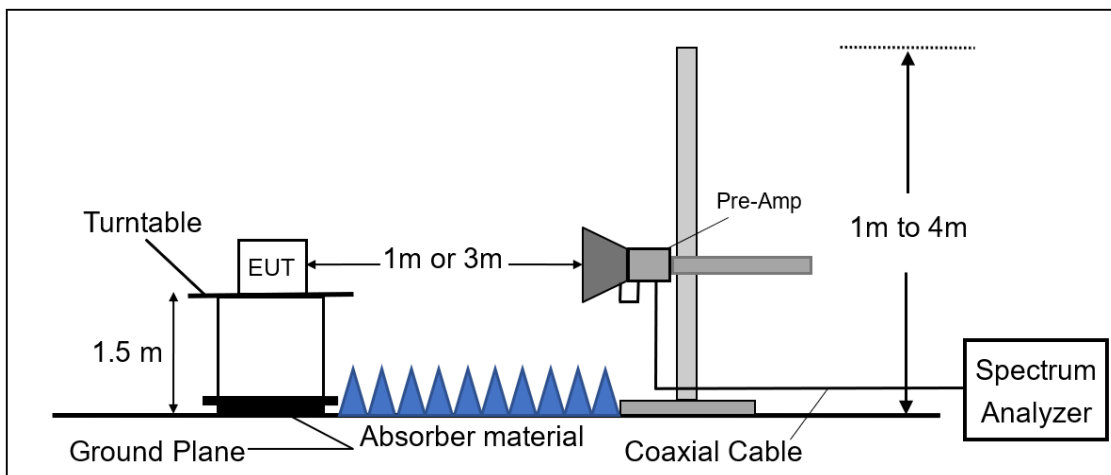

Unless otherwise stated the results shown in this test report refer only to the sample(s) tested and such sample(s) are retained for 90 days only.

除非另有說明，此報告結果僅對測試之樣品負責，同時此樣品僅保留90天。本報告未經本公司書面許可，不可部份複製。

This document is issued by the Company subject to its General Conditions of Service printed overleaf, available on request or accessible at <http://www.sgs.com.tw/Terms-and-Conditions> and for electronic format documents, subject to Terms and Conditions for Electronic Documents at <http://www.sgs.com.tw/Terms-and-Conditions>. Attention is drawn to the limitation of liability, indemnification and jurisdiction issues defined therein. Any holder of this document is advised that information contained hereon reflects the Company's findings at the time of its intervention only and within the limits of Client's instructions, if any. The Company's sole responsibility is to its Client and this document does not exonerate parties to a transaction from exercising all their rights and obligations under the transaction documents. This document cannot be reproduced except in full, without prior written approval of the Company. Any unauthorized alteration, forgery or falsification of the content or appearance of this document is unlawful and offenders may be prosecuted to the fullest extent of the law.

### 10.3 Measurement Procedure:

The EUT was placed on a non-conductive; the measurement antenna was placed at a distance of 3 meters from the EUT. During the tests, the antenna height and the EUT azimuth were varied in order to identify the maximum level of emissions from the EUT. This maximization process was repeated with the EUT positioned in each of its three orthogonal orientations.

The frequency range up to tenth harmonic was investigated for each of three fundamental frequencies (low, middle and high channels). Once spurious emission was identified, the power of the emission was determined using the substitution method.

The spurious emissions attenuation was calculated as the difference between radiated power at the fundamental frequency and the spurious emissions frequency.

ERP (dBm) = SG Level(dBm) + Antenna Gain(dBd) + Cable Loss(dB)

EIRP (dBm) = SG Level(dBm) + Antenna Gain(dBi) + Cable Loss(dB)

Unless otherwise stated the results shown in this test report refer only to the sample(s) tested and such sample(s) are retained for 90 days only.

除非另有說明，此報告結果僅對測試之樣品負責，同時此樣品僅保留90天。本報告未經本公司書面許可，不可部份複製。

This document is issued by the Company subject to its General Conditions of Service printed overleaf, available on request or accessible at <http://www.sgs.com.tw/Terms-and-Conditions> and for electronic format documents, subject to Terms and Conditions for Electronic Documents at <http://www.sgs.com.tw/Terms-and-Conditions>. Attention is drawn to the limitation of liability, indemnification and jurisdiction issues defined therein. Any holder of this document is advised that information contained hereon reflects the Company's findings at the time of its intervention only and within the limits of Client's instructions, if any. The Company's sole responsibility is to its Client and this document does not exonerate parties to a transaction from exercising all their rights and obligations under the transaction documents. This document cannot be reproduced except in full, without prior written approval of the Company. Any unauthorized alteration, forgery or falsification of the content or appearance of this document is unlawful and offenders may be prosecuted to the fullest extent of the law.

### 10.4 Measurement Result:

Report Number :ER/2022/30083  
 Operation Mode :LTE 5B  
 Test Mode :Tx CH Low  
 EUT Pol :H Plane  
 Test Frequency :830.4 MHz

Test Site :SAC 1  
 Test Date :2022-05-10  
 Temp./Humi. :22.5/69  
 Antenna Pol. :Vertical  
 Engineer :GN Lin

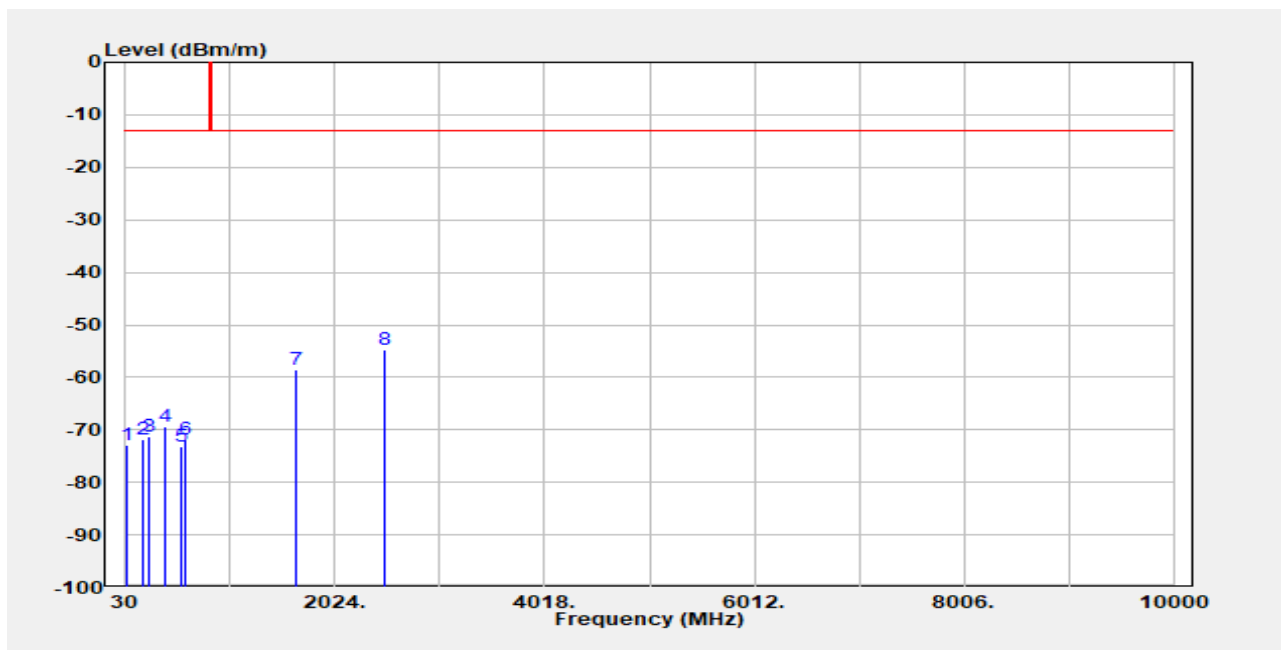

Freq. MHz	EIRP/ERP dBm	SG Output Level dBm	Antenna Gain dBi/dBd	Cable Loss dB	Limit dBm	Margin dB
48.43	-72.84	-60.01	-12.13	-0.70	-13.00	-59.84
194.90	-71.76	-74.20	3.88	-1.43	-13.00	-58.76
251.16	-71.39	-74.13	4.33	-1.59	-13.00	-58.39
398.60	-69.30	-71.50	4.32	-2.12	-13.00	-56.30
558.65	-73.20	-74.88	4.25	-2.57	-13.00	-60.20
588.72	-71.88	-73.03	3.80	-2.66	-13.00	-58.88
1660.80	-58.47	-63.72	9.52	-4.27	-13.00	-45.47
2491.20	-54.67	-60.07	10.58	-5.18	-13.00	-41.67

Unless otherwise stated the results shown in this test report refer only to the sample(s) tested and such sample(s) are retained for 90 days only.

除非另有說明，此報告結果僅對測試之樣品負責，同時此樣品僅保留90天。本報告未經本公司書面許可，不可部份複製。

This document is issued by the Company subject to its General Conditions of Service printed overleaf, available on request or accessible at <http://www.sgs.com.tw/Terms-and-Conditions> and for electronic format documents, subject to Terms and Conditions for Electronic Documents at <http://www.sgs.com.tw/Terms-and-Conditions>. Attention is drawn to the limitation of liability, indemnification and jurisdiction issues defined therein. Any holder of this document is advised that information contained hereon reflects the Company's findings at the time of its intervention only and within the limits of Client's instructions, if any. The Company's sole responsibility is to its Client and this document does not exonerate parties to a transaction from exercising all their rights and obligations under the transaction documents. This document cannot be reproduced except in full, without prior written approval of the Company. Any unauthorized alteration, forgery or falsification of the content or appearance of this document is unlawful and offenders may be prosecuted to the fullest extent of the law.

Report Number :ER/2022/30083  
 Operation Mode :LTE 5B  
 Test Mode :Tx CH Low  
 EUT Pol :H Plane  
 Test Frequency :830.4 MHz

Test Site :SAC 1  
 Test Date :2022-05-10  
 Temp./Humi. :22.5/69  
 Antenna Pol. :Horizontal  
 Engineer :GN Lin

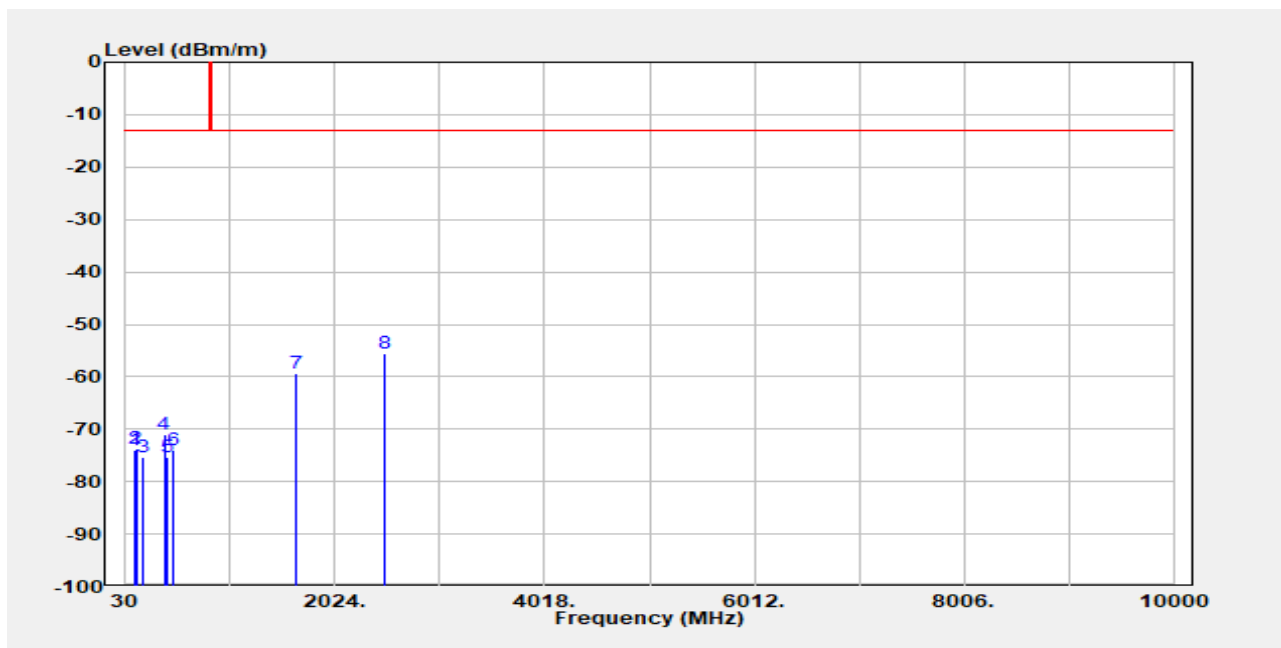

Freq. MHz	EIRP/ERP dBm	SG Output Level dBm	Antenna Gain dBi/dBd	Cable Loss dB	Limit dBm	Margin dB
116.33	-73.86	-71.16	-1.61	-1.10	-13.00	-60.86
127.97	-73.70	-70.66	-1.88	-1.16	-13.00	-60.70
194.90	-75.31	-77.75	3.88	-1.43	-13.00	-62.31
396.66	-71.02	-73.24	4.32	-2.10	-13.00	-58.02
418.00	-75.25	-77.65	4.28	-1.88	-13.00	-62.25
480.08	-73.99	-75.76	4.21	-2.44	-13.00	-60.99
1660.80	-59.25	-64.50	9.52	-4.27	-13.00	-46.25
2491.20	-55.45	-60.85	10.58	-5.18	-13.00	-42.45

Unless otherwise stated the results shown in this test report refer only to the sample(s) tested and such sample(s) are retained for 90 days only.

除非另有說明，此報告結果僅對測試之樣品負責，同時此樣品僅保留90天。本報告未經本公司書面許可，不可部份複製。

This document is issued by the Company subject to its General Conditions of Service printed overleaf, available on request or accessible at <http://www.sgs.com.tw/Terms-and-Conditions> and for electronic format documents, subject to Terms and Conditions for Electronic Documents at <http://www.sgs.com.tw/Terms-and-Conditions>. Attention is drawn to the limitation of liability, indemnification and jurisdiction issues defined therein. Any holder of this document is advised that information contained hereon reflects the Company's findings at the time of its intervention only and within the limits of Client's instructions, if any. The Company's sole responsibility is to its Client and this document does not exonerate parties to a transaction from exercising all their rights and obligations under the transaction documents. This document cannot be reproduced except in full, without prior written approval of the Company. Any unauthorized alteration, forgery or falsification of the content or appearance of this document is unlawful and offenders may be prosecuted to the fullest extent of the law.

Report Number :ER/2022/30083  
 Operation Mode :LTE 5B  
 Test Mode :Tx CH Mid  
 EUT Pol :H Plane  
 Test Frequency :835.4 MHz

Test Site :SAC 1  
 Test Date :2022-05-10  
 Temp./Humi. :22.5/69  
 Antenna Pol. :Vertical  
 Engineer :GN Lin

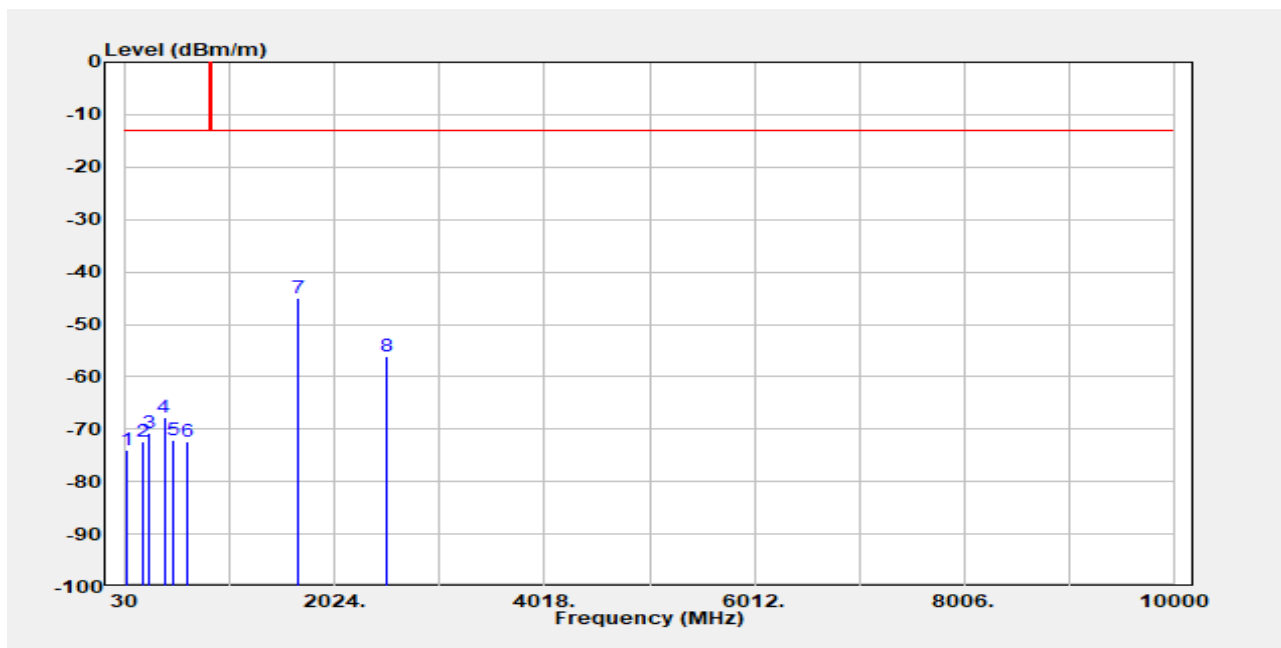

Freq. MHz	EIRP/ERP dBm	SG Output Level dBm	Antenna Gain dBi/dBd	Cable Loss dB	Limit dBm	Margin dB
48.43	-73.85	-61.02	-12.13	-0.70	-13.00	-60.85
193.93	-72.26	-74.66	3.83	-1.43	-13.00	-59.26
253.10	-70.81	-73.53	4.32	-1.60	-13.00	-57.81
396.66	-67.74	-69.96	4.32	-2.10	-13.00	-54.74
480.08	-72.01	-73.77	4.21	-2.44	-13.00	-59.01
608.12	-72.29	-73.30	3.53	-2.53	-13.00	-59.29
1670.80	-44.93	-50.18	9.54	-4.29	-13.00	-31.93
2506.20	-56.10	-61.52	10.61	-5.19	-13.00	-43.10

Unless otherwise stated the results shown in this test report refer only to the sample(s) tested and such sample(s) are retained for 90 days only.

除非另有說明，此報告結果僅對測試之樣品負責，同時此樣品僅保留90天。本報告未經本公司書面許可，不可部份複製。

This document is issued by the Company subject to its General Conditions of Service printed overleaf, available on request or accessible at <http://www.sgs.com.tw/Terms-and-Conditions> and for electronic format documents, subject to Terms and Conditions for Electronic Documents at <http://www.sgs.com.tw/Terms-and-Conditions>. Attention is drawn to the limitation of liability, indemnification and jurisdiction issues defined therein. Any holder of this document is advised that information contained hereon reflects the Company's findings at the time of its intervention only and within the limits of Client's instructions, if any. The Company's sole responsibility is to its Client and this document does not exonerate parties to a transaction from exercising all their rights and obligations under the transaction documents. This document cannot be reproduced except in full, without prior written approval of the Company. Any unauthorized alteration, forgery or falsification of the content or appearance of this document is unlawful and offenders may be prosecuted to the fullest extent of the law.

Report Number :ER/2022/30083  
 Operation Mode :LTE 5B  
 Test Mode :Tx CH Mid  
 EUT Pol :H Plane  
 Test Frequency :835.4 MHz

Test Site :SAC 1  
 Test Date :2022-05-10  
 Temp./Humi. :22.5/69  
 Antenna Pol. :Horizontal  
 Engineer :GN Lin

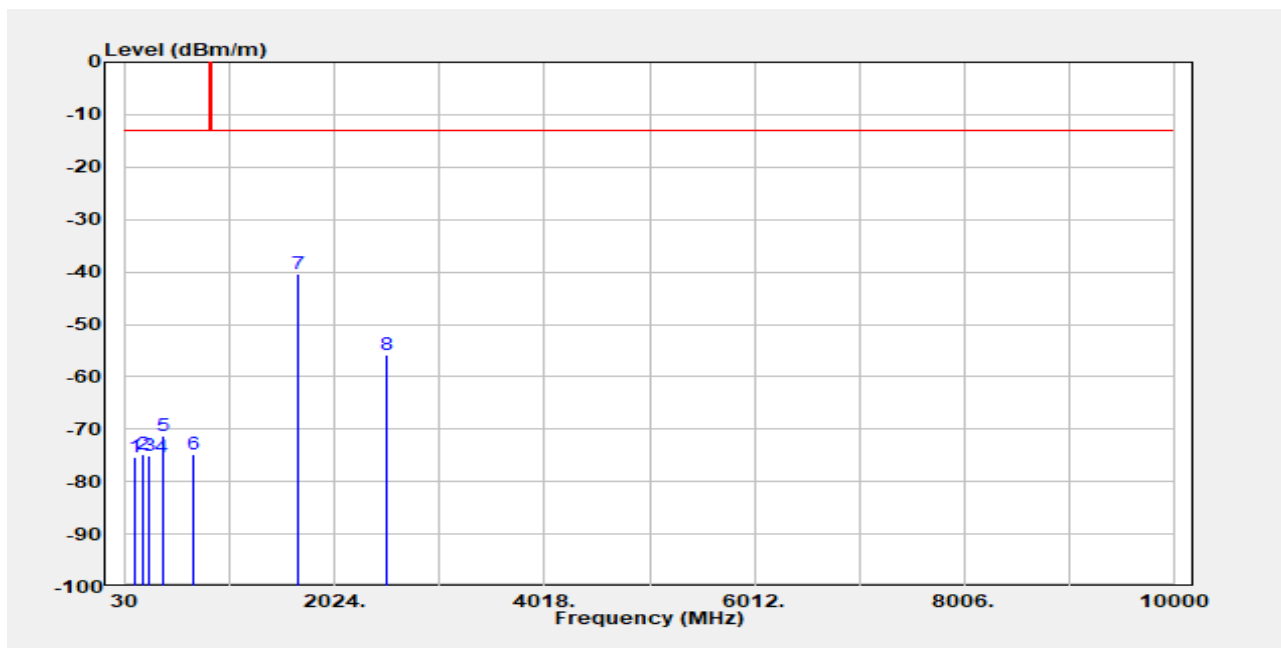

Freq. MHz	EIRP/ERP dBm	SG Output Level dBm	Antenna Gain dBi/dBd	Cable Loss dB	Limit dBm	Margin dB
115.36	-75.38	-72.58	-1.71	-1.10	-13.00	-62.38
195.87	-74.86	-77.44	4.01	-1.43	-13.00	-61.86
253.10	-75.13	-77.84	4.32	-1.60	-13.00	-62.13
377.26	-75.43	-77.80	4.37	-2.01	-13.00	-62.43
395.69	-71.28	-73.50	4.31	-2.09	-13.00	-58.28
672.14	-74.86	-75.51	3.77	-3.12	-13.00	-61.86
1670.80	-40.43	-45.68	9.54	-4.29	-13.00	-27.43
2506.20	-55.92	-61.34	10.61	-5.19	-13.00	-42.92

Unless otherwise stated the results shown in this test report refer only to the sample(s) tested and such sample(s) are retained for 90 days only.

除非另有說明，此報告結果僅對測試之樣品負責，同時此樣品僅保留90天。本報告未經本公司書面許可，不可部份複製。

This document is issued by the Company subject to its General Conditions of Service printed overleaf, available on request or accessible at <http://www.sgs.com.tw/Terms-and-Conditions> and for electronic format documents, subject to Terms and Conditions for Electronic Documents at <http://www.sgs.com.tw/Terms-and-Conditions>. Attention is drawn to the limitation of liability, indemnification and jurisdiction issues defined therein. Any holder of this document is advised that information contained hereon reflects the Company's findings at the time of its intervention only and within the limits of Client's instructions, if any. The Company's sole responsibility is to its Client and this document does not exonerate parties to a transaction from exercising all their rights and obligations under the transaction documents. This document cannot be reproduced except in full, without prior written approval of the Company. Any unauthorized alteration, forgery or falsification of the content or appearance of this document is unlawful and offenders may be prosecuted to the fullest extent of the law.



Report Number :ER/2022/30083  
 Operation Mode :LTE 5B  
 Test Mode :Tx CH High  
 EUT Pol :H Plane  
 Test Frequency :840.4 MHz

Test Site :SAC 1  
 Test Date :2022-05-10  
 Temp./Humi. :22.5/69  
 Antenna Pol. :Vertical  
 Engineer :GN Lin

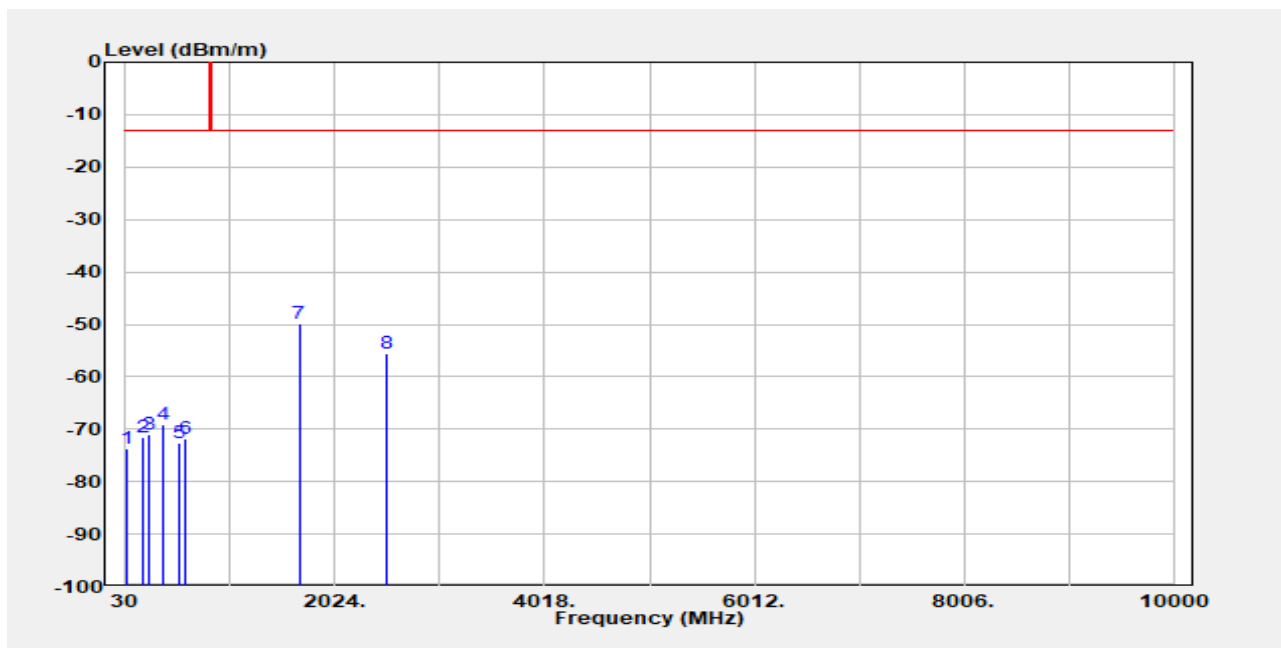

Freq. MHz	EIRP/ERP dBm	SG Output Level dBm	Antenna Gain dBi/dBd	Cable Loss dB	Limit dBm	Margin dB
48.43	-73.70	-60.88	-12.13	-0.70	-13.00	-60.70
195.87	-71.50	-74.08	4.01	-1.43	-13.00	-58.50
252.13	-70.92	-73.65	4.33	-1.60	-13.00	-57.92
395.69	-69.05	-71.27	4.31	-2.09	-13.00	-56.05
545.07	-72.70	-74.59	4.21	-2.32	-13.00	-59.70
601.33	-71.91	-72.92	3.64	-2.63	-13.00	-58.91
1680.80	-49.92	-55.19	9.56	-4.30	-13.00	-36.92
2521.20	-55.52	-60.95	10.64	-5.21	-13.00	-42.52

Unless otherwise stated the results shown in this test report refer only to the sample(s) tested and such sample(s) are retained for 90 days only.

除非另有說明，此報告結果僅對測試之樣品負責，同時此樣品僅保留90天。本報告未經本公司書面許可，不可部份複製。

This document is issued by the Company subject to its General Conditions of Service printed overleaf, available on request or accessible at <http://www.sgs.com.tw/Terms-and-Conditions> and for electronic format documents, subject to Terms and Conditions for Electronic Documents at <http://www.sgs.com.tw/Terms-and-Conditions>. Attention is drawn to the limitation of liability, indemnification and jurisdiction issues defined therein. Any holder of this document is advised that information contained hereon reflects the Company's findings at the time of its intervention only and within the limits of Client's instructions, if any. The Company's sole responsibility is to its Client and this document does not exonerate parties to a transaction from exercising all their rights and obligations under the transaction documents. This document cannot be reproduced except in full, without prior written approval of the Company. Any unauthorized alteration, forgery or falsification of the content or appearance of this document is unlawful and offenders may be prosecuted to the fullest extent of the law.

Report Number :ER/2022/30083  
 Operation Mode :LTE 5B  
 Test Mode :Tx CH High  
 EUT Pol :H Plane  
 Test Frequency :840.4 MHz

Test Site :SAC 1  
 Test Date :2022-05-10  
 Temp./Humi. :22.5/69  
 Antenna Pol. :Horizontal  
 Engineer :GN Lin

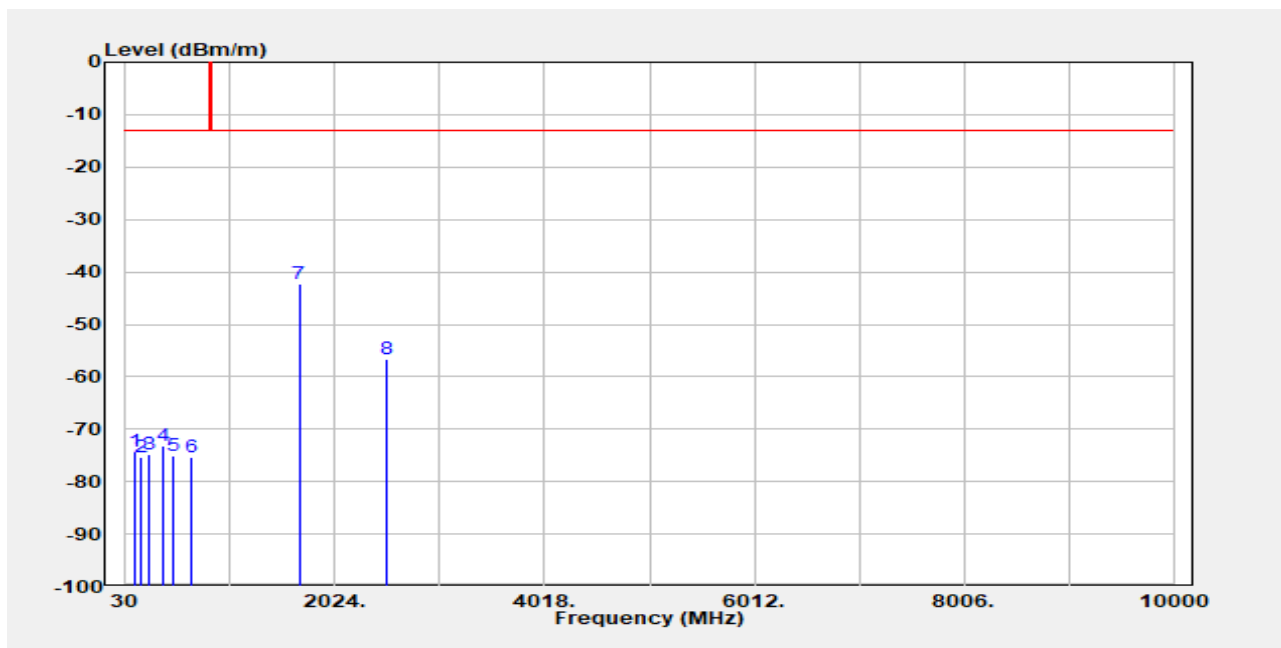

Freq. MHz	EIRP/ERP dBm	SG Output Level dBm	Antenna Gain dBi/dBd	Cable Loss dB	Limit dBm	Margin dB
118.27	-74.18	-71.35	-1.72	-1.12	-13.00	-61.18
170.65	-75.39	-73.91	-0.21	-1.27	-13.00	-62.39
252.13	-74.80	-77.53	4.33	-1.60	-13.00	-61.80
393.75	-73.05	-75.31	4.33	-2.08	-13.00	-60.05
480.08	-75.13	-76.90	4.21	-2.44	-13.00	-62.13
656.62	-75.22	-76.45	3.63	-2.40	-13.00	-62.22
1680.80	-42.38	-47.64	9.56	-4.30	-13.00	-29.38
2521.20	-56.53	-61.96	10.64	-5.21	-13.00	-43.53

Unless otherwise stated the results shown in this test report refer only to the sample(s) tested and such sample(s) are retained for 90 days only.

除非另有說明，此報告結果僅對測試之樣品負責，同時此樣品僅保留90天。本報告未經本公司書面許可，不可部份複製。

This document is issued by the Company subject to its General Conditions of Service printed overleaf, available on request or accessible at <http://www.sgs.com.tw/Terms-and-Conditions> and for electronic format documents, subject to Terms and Conditions for Electronic Documents at <http://www.sgs.com.tw/Terms-and-Conditions>. Attention is drawn to the limitation of liability, indemnification and jurisdiction issues defined therein. Any holder of this document is advised that information contained hereon reflects the Company's findings at the time of its intervention only and within the limits of Client's instructions, if any. The Company's sole responsibility is to its Client and this document does not exonerate parties to a transaction from exercising all their rights and obligations under the transaction documents. This document cannot be reproduced except in full, without prior written approval of the Company. Any unauthorized alteration, forgery or falsification of the content or appearance of this document is unlawful and offenders may be prosecuted to the fullest extent of the law.

Report Number :ER/2022/30083  
 Operation Mode :LTE 66C  
 Test Mode :Tx CH Low  
 EUT Pol :H Plane  
 Test Frequency :1727.2 MHz

Test Site :SAC 1  
 Test Date :2022-05-10  
 Temp./Humi. :22.5/69  
 Antenna Pol. :Vertical  
 Engineer :GN Lin

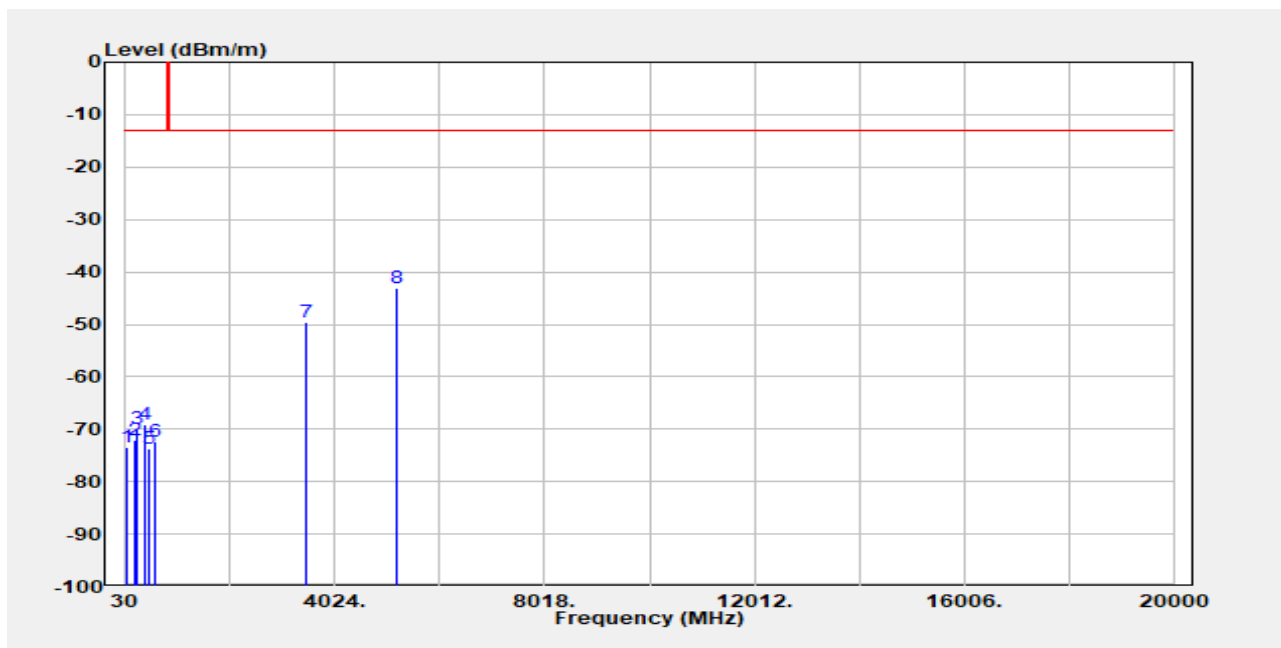

Freq. MHz	EIRP/ERP dBm	SG Output Level dBm	Antenna Gain dBi/dBd	Cable Loss dB	Limit dBm	Margin dB
49.40	-73.47	-60.84	-11.93	-0.70	-13.00	-60.47
194.90	-72.14	-74.59	3.88	-1.43	-13.00	-59.14
252.13	-69.95	-72.68	4.33	-1.60	-13.00	-56.95
397.63	-69.02	-71.22	4.32	-2.11	-13.00	-56.02
480.08	-73.81	-75.57	4.21	-2.44	-13.00	-60.81
585.81	-72.30	-73.44	3.82	-2.67	-13.00	-59.30
3454.40	-49.60	-56.05	12.49	-6.04	-13.00	-36.59
5181.60	-43.08	-47.47	12.29	-7.90	-13.00	-30.07

Unless otherwise stated the results shown in this test report refer only to the sample(s) tested and such sample(s) are retained for 90 days only.

除非另有說明，此報告結果僅對測試之樣品負責，同時此樣品僅保留90天。本報告未經本公司書面許可，不可部份複製。

This document is issued by the Company subject to its General Conditions of Service printed overleaf, available on request or accessible at <http://www.sgs.com.tw/Terms-and-Conditions> and for electronic format documents, subject to Terms and Conditions for Electronic Documents at <http://www.sgs.com.tw/Terms-and-Conditions>. Attention is drawn to the limitation of liability, indemnification and jurisdiction issues defined therein. Any holder of this document is advised that information contained hereon reflects the Company's findings at the time of its intervention only and within the limits of Client's instructions, if any. The Company's sole responsibility is to its Client and this document does not exonerate parties to a transaction from exercising all their rights and obligations under the transaction documents. This document cannot be reproduced except in full, without prior written approval of the Company. Any unauthorized alteration, forgery or falsification of the content or appearance of this document is unlawful and offenders may be prosecuted to the fullest extent of the law.

Report Number :ER/2022/30083  
 Operation Mode :LTE 66C  
 Test Mode :Tx CH Low  
 EUT Pol :H Plane  
 Test Frequency :1727.2 MHz

Test Site :SAC 1  
 Test Date :2022-05-10  
 Temp./Humi. :22.5/69  
 Antenna Pol. :Horizontal  
 Engineer :GN Lin

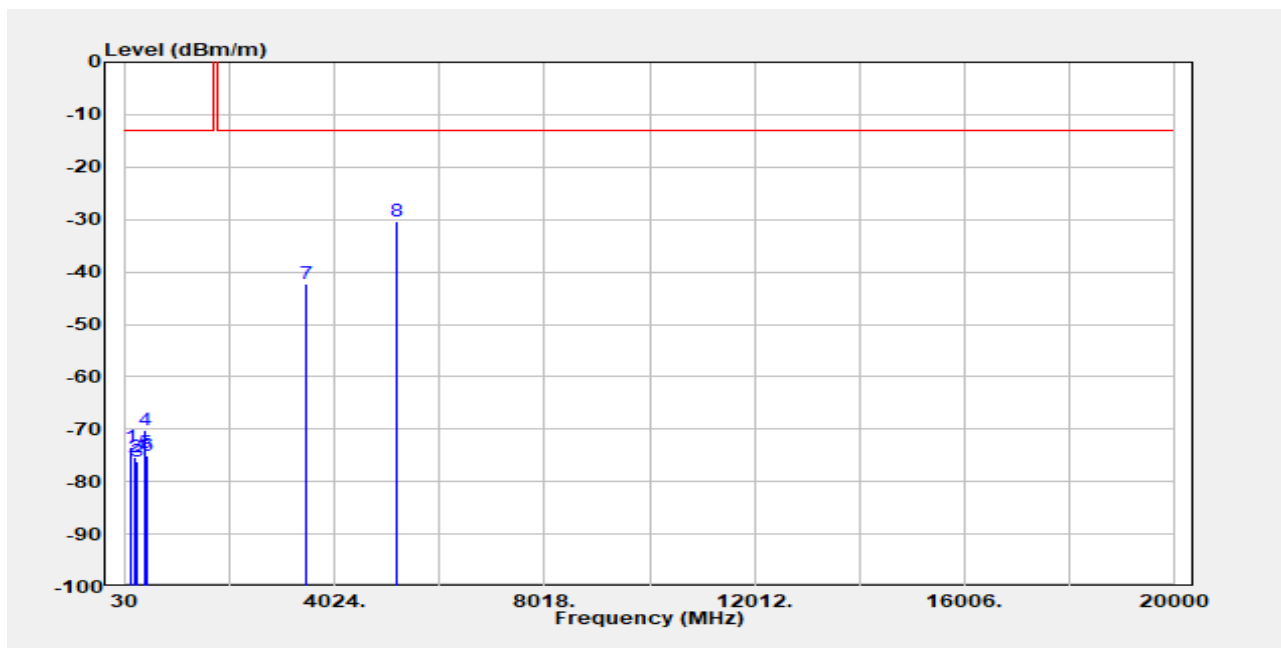

Freq. MHz	EIRP/ERP dBm	SG Output Level dBm	Antenna Gain dBi/dBd	Cable Loss dB	Limit dBm	Margin dB
115.36	-73.52	-70.72	-1.71	-1.10	-13.00	-60.52
199.75	-75.23	-78.09	4.29	-1.43	-13.00	-62.23
253.10	-76.29	-79.00	4.32	-1.60	-13.00	-63.29
398.60	-70.30	-72.50	4.32	-2.12	-13.00	-57.30
415.09	-74.61	-77.08	4.34	-1.87	-13.00	-61.61
440.31	-75.17	-77.01	4.06	-2.22	-13.00	-62.17
3454.40	-42.17	-48.62	12.49	-6.04	-13.00	-29.17
5181.60	-30.23	-34.62	12.29	-7.90	-13.00	-17.23

Unless otherwise stated the results shown in this test report refer only to the sample(s) tested and such sample(s) are retained for 90 days only.

除非另有說明，此報告結果僅對測試之樣品負責，同時此樣品僅保留90天。本報告未經本公司書面許可，不可部份複製。

This document is issued by the Company subject to its General Conditions of Service printed overleaf, available on request or accessible at <http://www.sgs.com.tw/Terms-and-Conditions> and for electronic format documents, subject to Terms and Conditions for Electronic Documents at <http://www.sgs.com.tw/Terms-and-Conditions>. Attention is drawn to the limitation of liability, indemnification and jurisdiction issues defined therein. Any holder of this document is advised that information contained hereon reflects the Company's findings at the time of its intervention only and within the limits of Client's instructions, if any. The Company's sole responsibility is to its Client and this document does not exonerate parties to a transaction from exercising all their rights and obligations under the transaction documents. This document cannot be reproduced except in full, without prior written approval of the Company. Any unauthorized alteration, forgery or falsification of the content or appearance of this document is unlawful and offenders may be prosecuted to the fullest extent of the law.

Report Number :ER/2022/30083  
 Operation Mode :LTE 66C  
 Test Mode :Tx CH Mid  
 EUT Pol :H Plane  
 Test Frequency :1757.3 MHz

Test Site :SAC 1  
 Test Date :2022-05-10  
 Temp./Humi. :22.5/69  
 Antenna Pol. :Vertical  
 Engineer :GN Lin

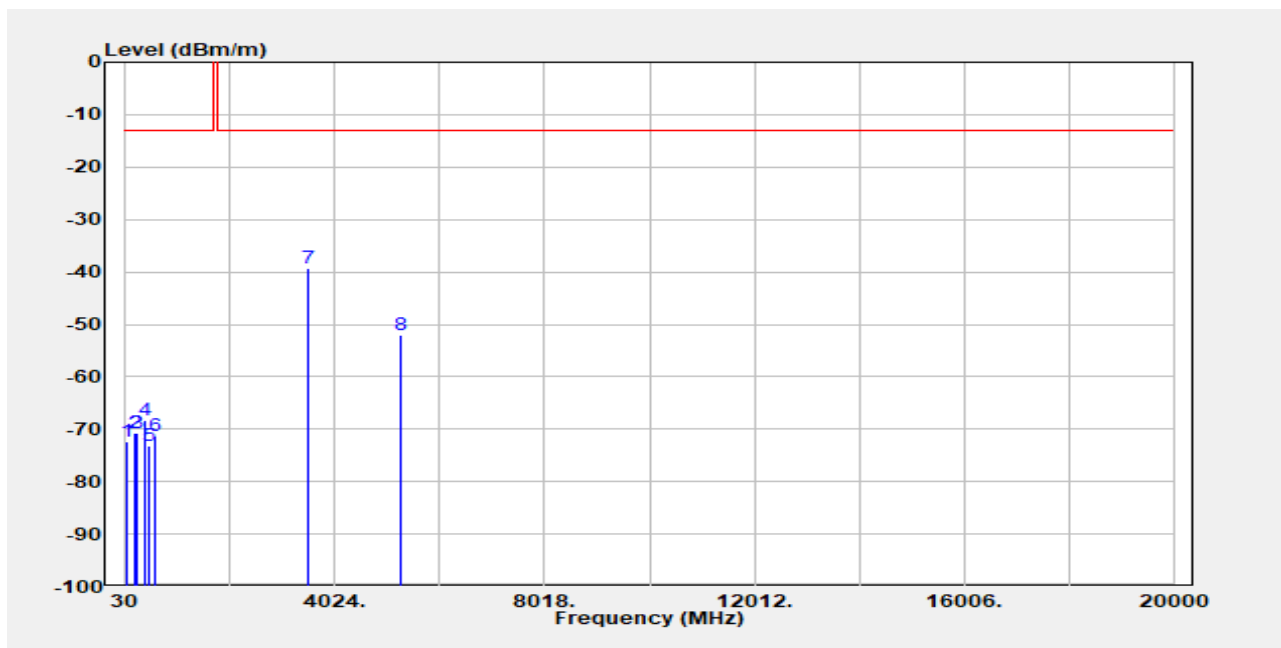

Freq. MHz	EIRP/ERP dBm	SG Output Level dBm	Antenna Gain dBi/dBd	Cable Loss dB	Limit dBm	Margin dB
48.43	-72.38	-59.55	-12.13	-0.70	-13.00	-59.38
195.87	-70.73	-73.30	4.01	-1.43	-13.00	-57.73
253.10	-70.71	-73.42	4.32	-1.60	-13.00	-57.71
399.57	-68.34	-70.53	4.32	-2.13	-13.00	-55.34
480.08	-73.20	-74.96	4.21	-2.44	-13.00	-60.20
598.42	-71.36	-72.40	3.68	-2.64	-13.00	-58.36
3514.60	-39.29	-45.31	12.40	-6.38	-13.00	-26.29
5271.90	-52.14	-56.92	12.89	-8.11	-13.00	-39.14

Unless otherwise stated the results shown in this test report refer only to the sample(s) tested and such sample(s) are retained for 90 days only.

除非另有說明，此報告結果僅對測試之樣品負責，同時此樣品僅保留90天。本報告未經本公司書面許可，不可部份複製。

This document is issued by the Company subject to its General Conditions of Service printed overleaf, available on request or accessible at <http://www.sgs.com.tw/Terms-and-Conditions> and for electronic format documents, subject to Terms and Conditions for Electronic Documents at <http://www.sgs.com.tw/Terms-and-Conditions>. Attention is drawn to the limitation of liability, indemnification and jurisdiction issues defined therein. Any holder of this document is advised that information contained hereon reflects the Company's findings at the time of its intervention only and within the limits of Client's instructions, if any. The Company's sole responsibility is to its Client and this document does not exonerate parties to a transaction from exercising all their rights and obligations under the transaction documents. This document cannot be reproduced except in full, without prior written approval of the Company. Any unauthorized alteration, forgery or falsification of the content or appearance of this document is unlawful and offenders may be prosecuted to the fullest extent of the law.

Report Number :ER/2022/30083  
 Operation Mode :LTE 66C  
 Test Mode :Tx CH Mid  
 EUT Pol :H Plane  
 Test Frequency :1757.3 MHz

Test Site :SAC 1  
 Test Date :2022-05-10  
 Temp./Humi. :22.5/69  
 Antenna Pol. :Horizontal  
 Engineer :GN Lin

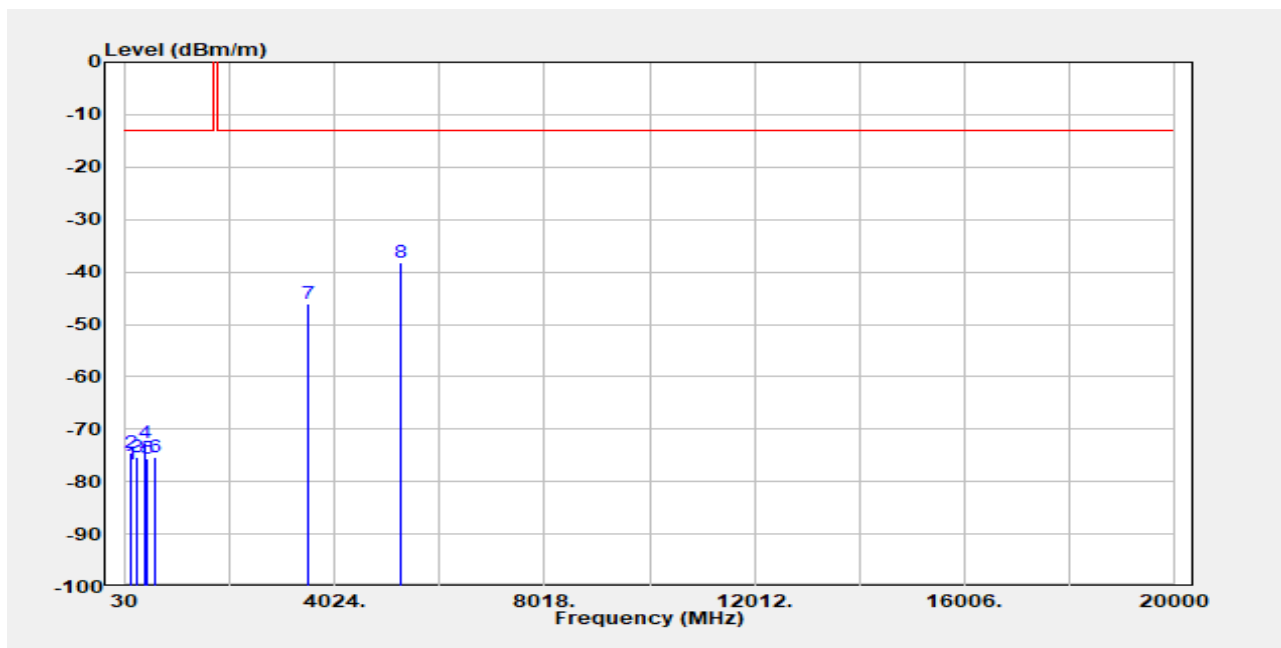

Freq. MHz	EIRP/ERP dBm	SG Output Level dBm	Antenna Gain dBi/dBd	Cable Loss dB	Limit dBm	Margin dB
114.39	-76.62	-73.81	-1.73	-1.09	-13.00	-63.62
130.88	-74.55	-71.37	-1.99	-1.18	-13.00	-61.55
251.16	-75.25	-77.99	4.33	-1.59	-13.00	-62.25
395.69	-72.63	-74.85	4.31	-2.09	-13.00	-59.63
436.43	-75.51	-77.35	3.98	-2.14	-13.00	-62.51
600.36	-75.26	-76.27	3.64	-2.64	-13.00	-62.26
3514.60	-45.97	-51.99	12.40	-6.38	-13.00	-32.97
5271.90	-38.19	-42.97	12.89	-8.11	-13.00	-25.19

Unless otherwise stated the results shown in this test report refer only to the sample(s) tested and such sample(s) are retained for 90 days only.

除非另有說明，此報告結果僅對測試之樣品負責，同時此樣品僅保留90天。本報告未經本公司書面許可，不可部份複製。

This document is issued by the Company subject to its General Conditions of Service printed overleaf, available on request or accessible at <http://www.sgs.com.tw/Terms-and-Conditions> and for electronic format documents, subject to Terms and Conditions for Electronic Documents at <http://www.sgs.com.tw/Terms-and-Conditions>. Attention is drawn to the limitation of liability, indemnification and jurisdiction issues defined therein. Any holder of this document is advised that information contained hereon reflects the Company's findings at the time of its intervention only and within the limits of Client's instructions, if any. The Company's sole responsibility is to its Client and this document does not exonerate parties to a transaction from exercising all their rights and obligations under the transaction documents. This document cannot be reproduced except in full, without prior written approval of the Company. Any unauthorized alteration, forgery or falsification of the content or appearance of this document is unlawful and offenders may be prosecuted to the fullest extent of the law.

Report Number :ER/2022/30083  
 Operation Mode :LTE 66C  
 Test Mode :Tx CH High  
 EUT Pol :H Plane  
 Test Frequency :1767.3 MHz

Test Site :SAC 1  
 Test Date :2022-05-10  
 Temp./Humi. :22.5/69  
 Antenna Pol. :Vertical  
 Engineer :GN Lin

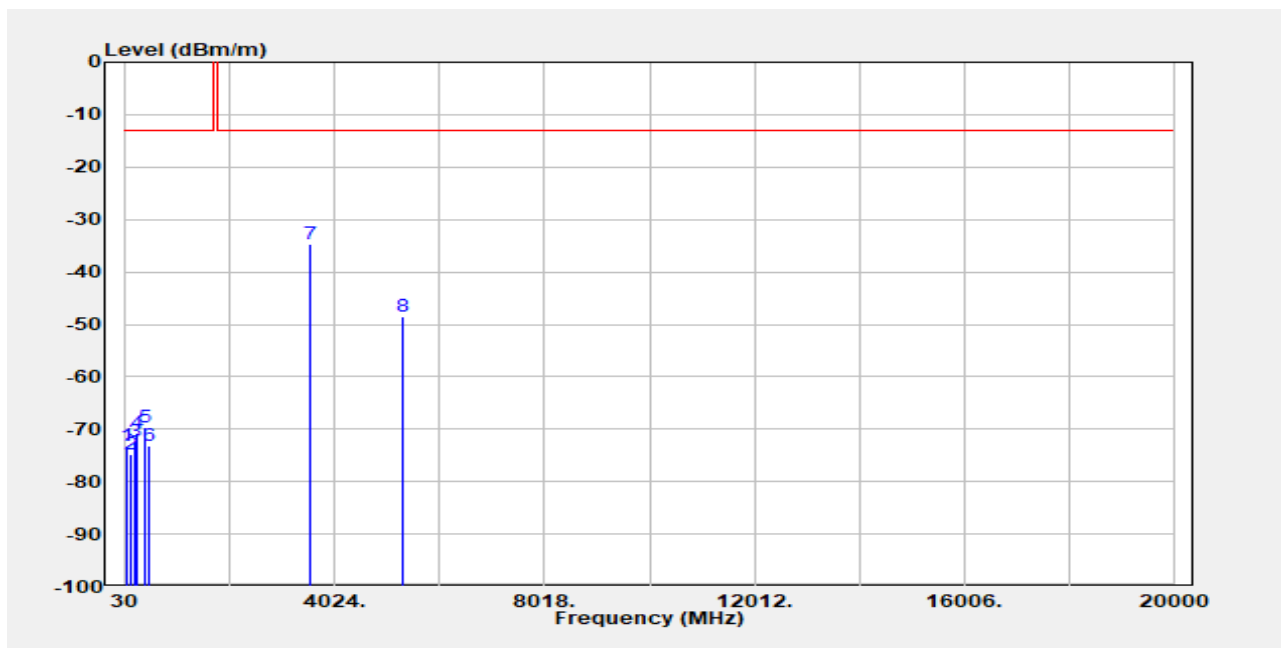

Freq. MHz	EIRP/ERP dBm	SG Output Level dBm	Antenna Gain dBi/dBd	Cable Loss dB	Limit dBm	Margin dB
48.43	-73.26	-60.43	-12.13	-0.70	-13.00	-60.26
119.24	-74.92	-71.99	-1.82	-1.12	-13.00	-61.92
193.93	-72.30	-74.70	3.83	-1.43	-13.00	-59.30
253.10	-70.67	-73.38	4.32	-1.60	-13.00	-57.67
400.54	-69.65	-71.86	4.32	-2.12	-13.00	-56.65
480.08	-73.20	-74.96	4.21	-2.44	-13.00	-60.20
3534.60	-34.66	-40.61	12.40	-6.46	-13.00	-21.66
5301.90	-48.51	-53.29	13.00	-8.22	-13.00	-35.51

Unless otherwise stated the results shown in this test report refer only to the sample(s) tested and such sample(s) are retained for 90 days only.

除非另有說明，此報告結果僅對測試之樣品負責，同時此樣品僅保留90天。本報告未經本公司書面許可，不可部份複製。

This document is issued by the Company subject to its General Conditions of Service printed overleaf, available on request or accessible at <http://www.sgs.com.tw/Terms-and-Conditions> and for electronic format documents, subject to Terms and Conditions for Electronic Documents at <http://www.sgs.com.tw/Terms-and-Conditions>. Attention is drawn to the limitation of liability, indemnification and jurisdiction issues defined therein. Any holder of this document is advised that information contained hereon reflects the Company's findings at the time of its intervention only and within the limits of Client's instructions, if any. The Company's sole responsibility is to its Client and this document does not exonerate parties to a transaction from exercising all their rights and obligations under the transaction documents. This document cannot be reproduced except in full, without prior written approval of the Company. Any unauthorized alteration, forgery or falsification of the content or appearance of this document is unlawful and offenders may be prosecuted to the fullest extent of the law.

Report Number :ER/2022/30083  
 Operation Mode :LTE 66C  
 Test Mode :Tx CH High  
 EUT Pol :H Plane  
 Test Frequency :1767.3 MHz

Test Site :SAC 1  
 Test Date :2022-05-10  
 Temp./Humi. :22.5/69  
 Antenna Pol. :Horizontal  
 Engineer :GN Lin

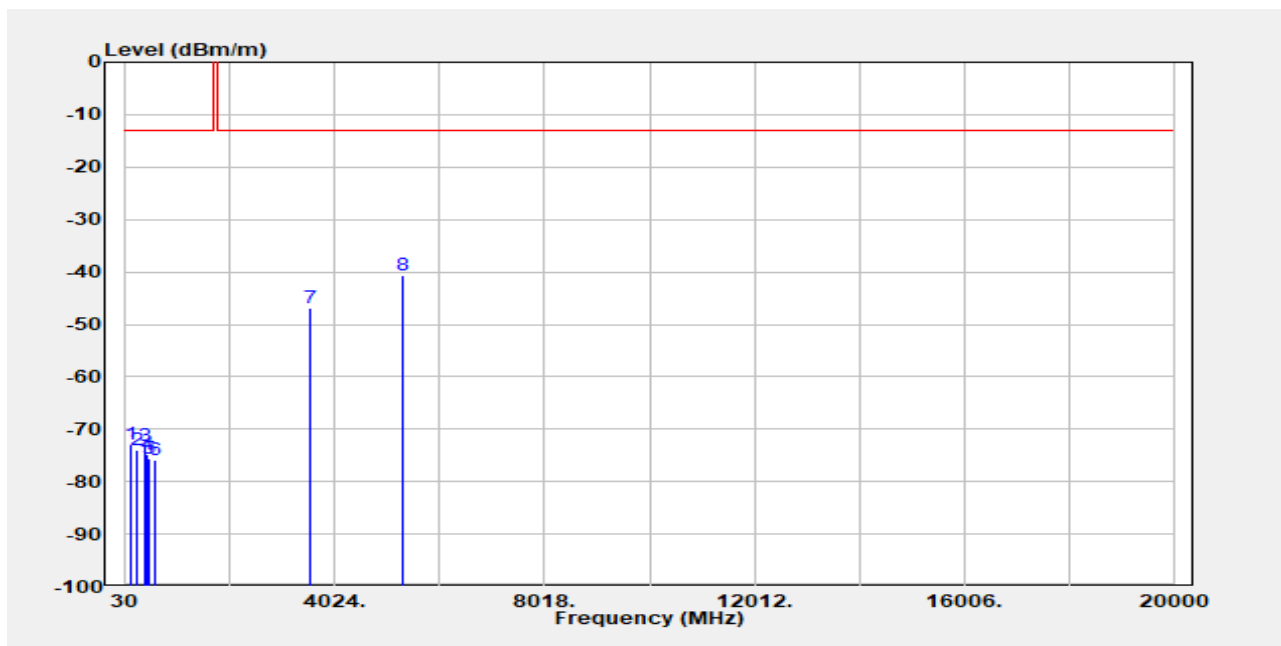

Freq. MHz	EIRP/ERP dBm	SG Output Level dBm	Antenna Gain dBi/dBd	Cable Loss dB	Limit dBm	Margin dB
118.27	-72.98	-70.14	-1.72	-1.12	-13.00	-59.98
252.13	-73.99	-76.72	4.33	-1.60	-13.00	-60.99
395.69	-73.30	-75.52	4.31	-2.09	-13.00	-60.30
419.94	-74.92	-77.27	4.25	-1.89	-13.00	-61.92
480.08	-75.65	-77.41	4.21	-2.44	-13.00	-62.65
600.36	-75.81	-76.82	3.64	-2.64	-13.00	-62.81
3534.60	-46.85	-52.79	12.40	-6.46	-13.00	-33.85
5301.90	-40.68	-45.46	13.00	-8.22	-13.00	-27.68

Unless otherwise stated the results shown in this test report refer only to the sample(s) tested and such sample(s) are retained for 90 days only.

除非另有說明，此報告結果僅對測試之樣品負責，同時此樣品僅保留90天。本報告未經本公司書面許可，不可部份複製。

This document is issued by the Company subject to its General Conditions of Service printed overleaf, available on request or accessible at <http://www.sgs.com.tw/Terms-and-Conditions> and for electronic format documents, subject to Terms and Conditions for Electronic Documents at <http://www.sgs.com.tw/Terms-and-Conditions>. Attention is drawn to the limitation of liability, indemnification and jurisdiction issues defined therein. Any holder of this document is advised that information contained hereon reflects the Company's findings at the time of its intervention only and within the limits of Client's instructions, if any. The Company's sole responsibility is to its Client and this document does not exonerate parties to a transaction from exercising all their rights and obligations under the transaction documents. This document cannot be reproduced except in full, without prior written approval of the Company. Any unauthorized alteration, forgery or falsification of the content or appearance of this document is unlawful and offenders may be prosecuted to the fullest extent of the law.



Report Number :ER/2022/30083  
 Operation Mode :LTE 66B  
 Test Mode :Tx CH Low  
 EUT Pol :H Plane  
 Test Frequency :1714.9 MHz

Test Site :SAC 1  
 Test Date :2022-05-10  
 Temp./Humi. :22.5/69  
 Antenna Pol. :Vertical  
 Engineer :GN Lin

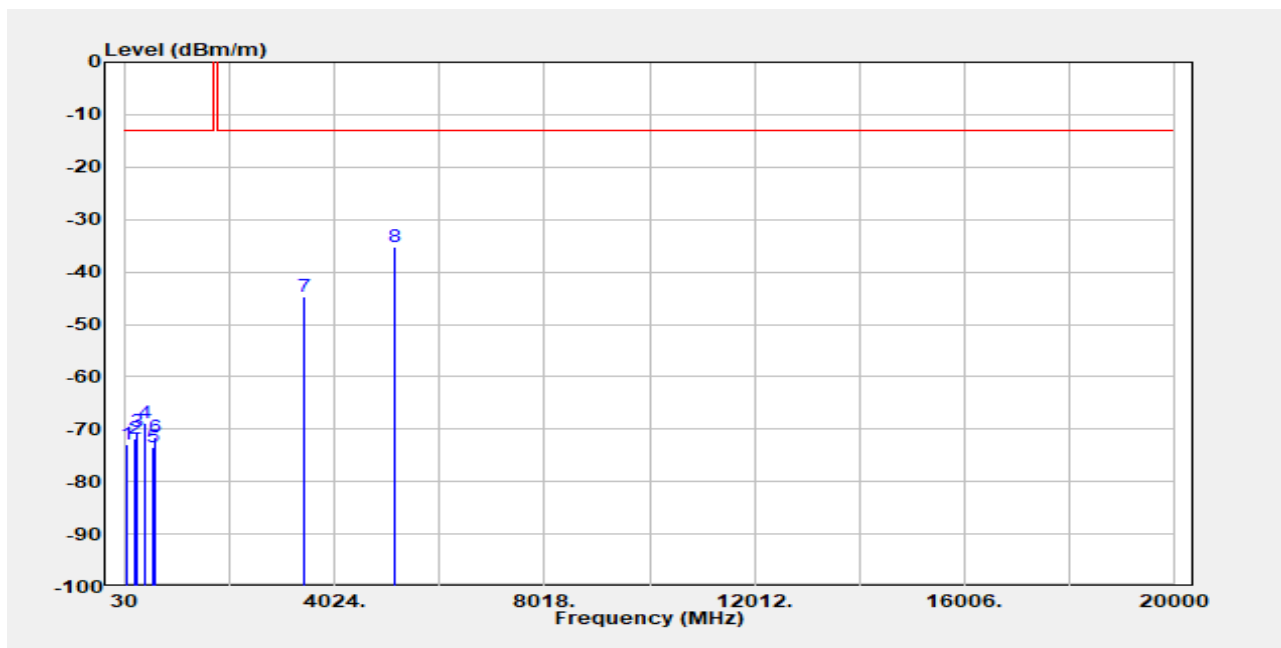

Freq. MHz	EIRP/ERP dBm	SG Output Level dBm	Antenna Gain dBi/dBd	Cable Loss dB	Limit dBm	Margin dB
48.43	-72.77	-59.94	-12.13	-0.70	-13.00	-59.77
196.84	-71.87	-74.50	4.06	-1.43	-13.00	-58.87
253.10	-70.44	-73.15	4.32	-1.60	-13.00	-57.44
394.72	-68.92	-71.16	4.32	-2.08	-13.00	-55.92
545.07	-73.31	-75.20	4.21	-2.32	-13.00	-60.31
599.39	-71.41	-72.42	3.66	-2.64	-13.00	-58.41
3429.80	-44.76	-51.42	12.54	-5.88	-13.00	-31.76
5144.70	-35.16	-39.32	12.10	-7.95	-13.00	-22.16

Unless otherwise stated the results shown in this test report refer only to the sample(s) tested and such sample(s) are retained for 90 days only.

除非另有說明，此報告結果僅對測試之樣品負責，同時此樣品僅保留90天。本報告未經本公司書面許可，不可部份複製。

This document is issued by the Company subject to its General Conditions of Service printed overleaf, available on request or accessible at <http://www.sgs.com.tw/Terms-and-Conditions> and for electronic format documents, subject to Terms and Conditions for Electronic Documents at <http://www.sgs.com.tw/Terms-and-Conditions>. Attention is drawn to the limitation of liability, indemnification and jurisdiction issues defined therein. Any holder of this document is advised that information contained hereon reflects the Company's findings at the time of its intervention only and within the limits of Client's instructions, if any. The Company's sole responsibility is to its Client and this document does not exonerate parties to a transaction from exercising all their rights and obligations under the transaction documents. This document cannot be reproduced except in full, without prior written approval of the Company. Any unauthorized alteration, forgery or falsification of the content or appearance of this document is unlawful and offenders may be prosecuted to the fullest extent of the law.

Report Number :ER/2022/30083  
 Operation Mode :LTE 66B  
 Test Mode :Tx CH Low  
 EUT Pol :H Plane  
 Test Frequency :1714.9 MHz

Test Site :SAC 1  
 Test Date :2022-05-10  
 Temp./Humi. :22.5/69  
 Antenna Pol. :Horizontal  
 Engineer :GN Lin

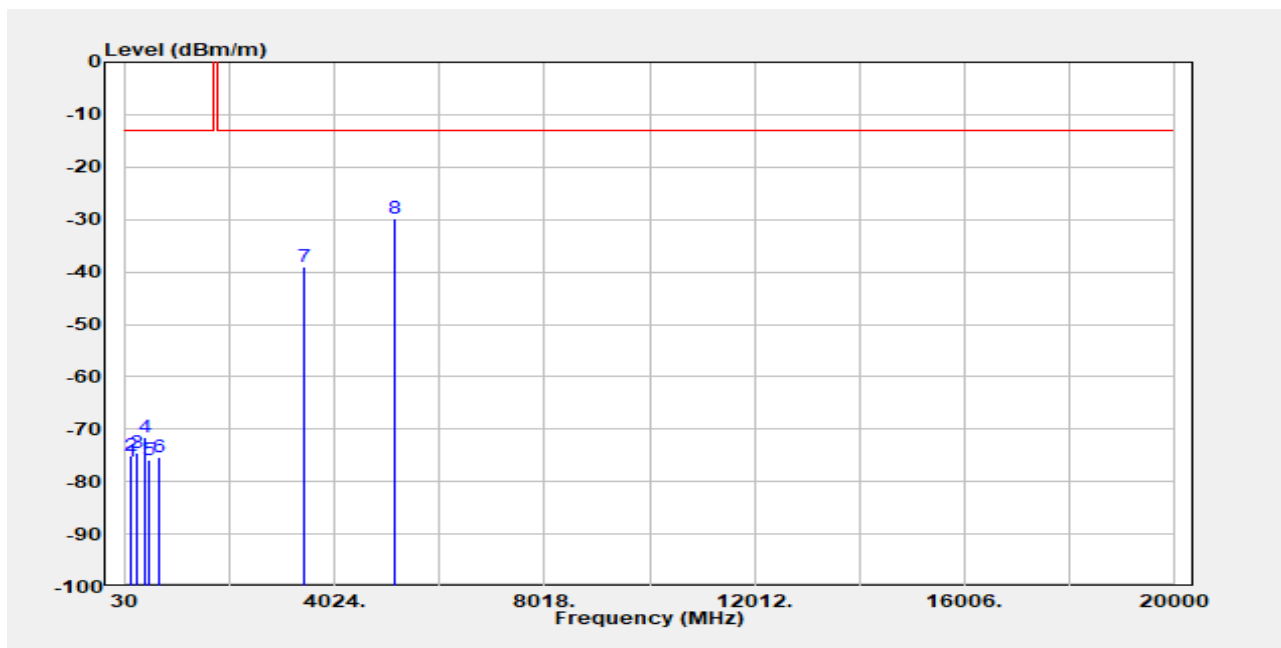

Freq. MHz	EIRP/ERP dBm	SG Output Level dBm	Antenna Gain dBi/dBd	Cable Loss dB	Limit dBm	Margin dB
116.33	-76.21	-73.50	-1.61	-1.10	-13.00	-63.21
130.88	-75.13	-71.95	-1.99	-1.18	-13.00	-62.13
251.16	-74.51	-77.25	4.33	-1.59	-13.00	-61.51
395.69	-71.62	-73.84	4.31	-2.09	-13.00	-58.62
480.08	-75.77	-77.53	4.21	-2.44	-13.00	-62.77
654.68	-75.25	-76.44	3.61	-2.41	-13.00	-62.25
3429.80	-39.04	-45.70	12.54	-5.88	-13.00	-26.04
5144.70	-29.77	-33.92	12.10	-7.95	-13.00	-16.77

Unless otherwise stated the results shown in this test report refer only to the sample(s) tested and such sample(s) are retained for 90 days only.

除非另有說明，此報告結果僅對測試之樣品負責，同時此樣品僅保留90天。本報告未經本公司書面許可，不可部份複製。

This document is issued by the Company subject to its General Conditions of Service printed overleaf, available on request or accessible at <http://www.sgs.com.tw/Terms-and-Conditions> and for electronic format documents, subject to Terms and Conditions for Electronic Documents at <http://www.sgs.com.tw/Terms-and-Conditions>. Attention is drawn to the limitation of liability, indemnification and jurisdiction issues defined therein. Any holder of this document is advised that information contained hereon reflects the Company's findings at the time of its intervention only and within the limits of Client's instructions, if any. The Company's sole responsibility is to its Client and this document does not exonerate parties to a transaction from exercising all their rights and obligations under the transaction documents. This document cannot be reproduced except in full, without prior written approval of the Company. Any unauthorized alteration, forgery or falsification of the content or appearance of this document is unlawful and offenders may be prosecuted to the fullest extent of the law.

Report Number :ER/2022/30083  
 Operation Mode :LTE 66B  
 Test Mode :Tx CH Mid  
 EUT Pol :H Plane  
 Test Frequency :1755 MHz

Test Site :SAC 1  
 Test Date :2022-05-10  
 Temp./Humi. :22.5/69  
 Antenna Pol. :Vertical  
 Engineer :GN Lin

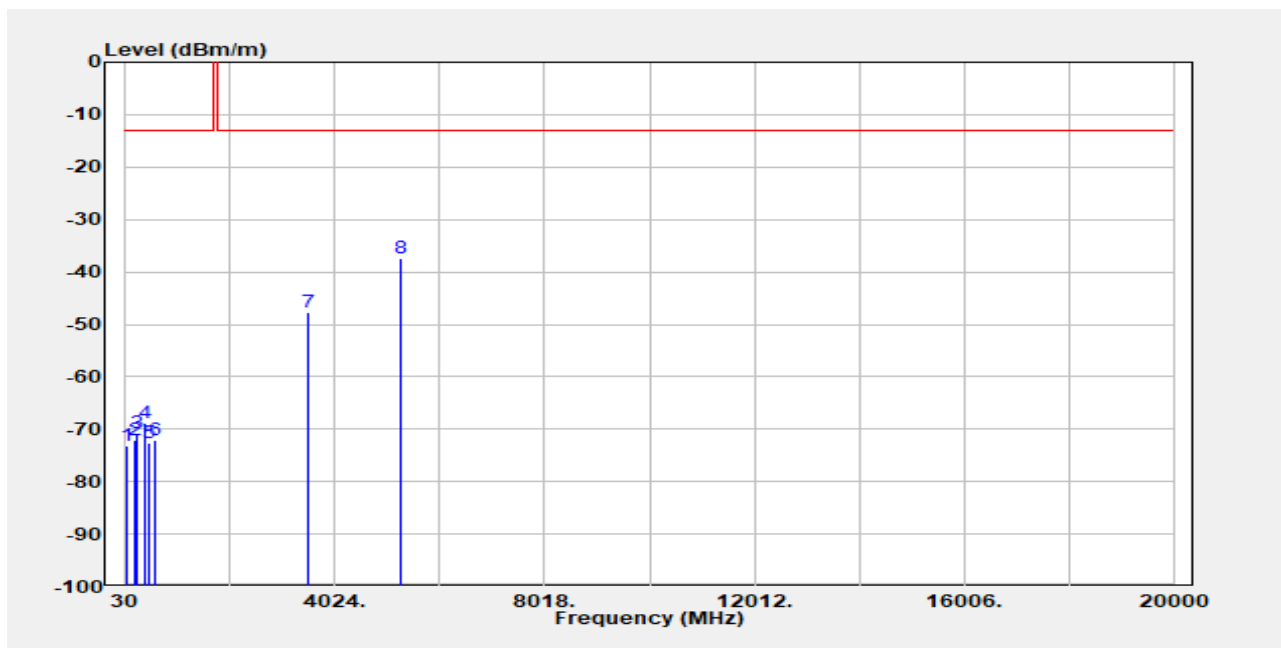

Freq. MHz	EIRP/ERP dBm	SG Output Level dBm	Antenna Gain dBi/dBd	Cable Loss dB	Limit dBm	Margin dB
48.43	-73.26	-60.43	-12.13	-0.70	-13.00	-60.26
195.87	-72.17	-74.75	4.01	-1.43	-13.00	-59.17
253.10	-70.80	-73.52	4.32	-1.60	-13.00	-57.80
394.72	-68.82	-71.05	4.32	-2.08	-13.00	-55.82
480.08	-72.54	-74.30	4.21	-2.44	-13.00	-59.54
603.27	-72.12	-73.14	3.62	-2.60	-13.00	-59.12
3510.00	-47.68	-53.72	12.40	-6.36	-13.00	-34.68
5265.00	-37.37	-42.15	12.86	-8.08	-13.00	-24.37

Unless otherwise stated the results shown in this test report refer only to the sample(s) tested and such sample(s) are retained for 90 days only.

除非另有說明，此報告結果僅對測試之樣品負責，同時此樣品僅保留90天。本報告未經本公司書面許可，不可部份複製。

This document is issued by the Company subject to its General Conditions of Service printed overleaf, available on request or accessible at <http://www.sgs.com.tw/Terms-and-Conditions> and for electronic format documents, subject to Terms and Conditions for Electronic Documents at <http://www.sgs.com.tw/Terms-and-Conditions>. Attention is drawn to the limitation of liability, indemnification and jurisdiction issues defined therein. Any holder of this document is advised that information contained hereon reflects the Company's findings at the time of its intervention only and within the limits of Client's instructions, if any. The Company's sole responsibility is to its Client and this document does not exonerate parties to a transaction from exercising all their rights and obligations under the transaction documents. This document cannot be reproduced except in full, without prior written approval of the Company. Any unauthorized alteration, forgery or falsification of the content or appearance of this document is unlawful and offenders may be prosecuted to the fullest extent of the law.

Report Number :ER/2022/30083  
 Operation Mode :LTE 66B  
 Test Mode :Tx CH Mid  
 EUT Pol :H Plane  
 Test Frequency :1755 MHz

Test Site :SAC 1  
 Test Date :2022-05-10  
 Temp./Humi. :22.5/69  
 Antenna Pol. :Horizontal  
 Engineer :GN Lin

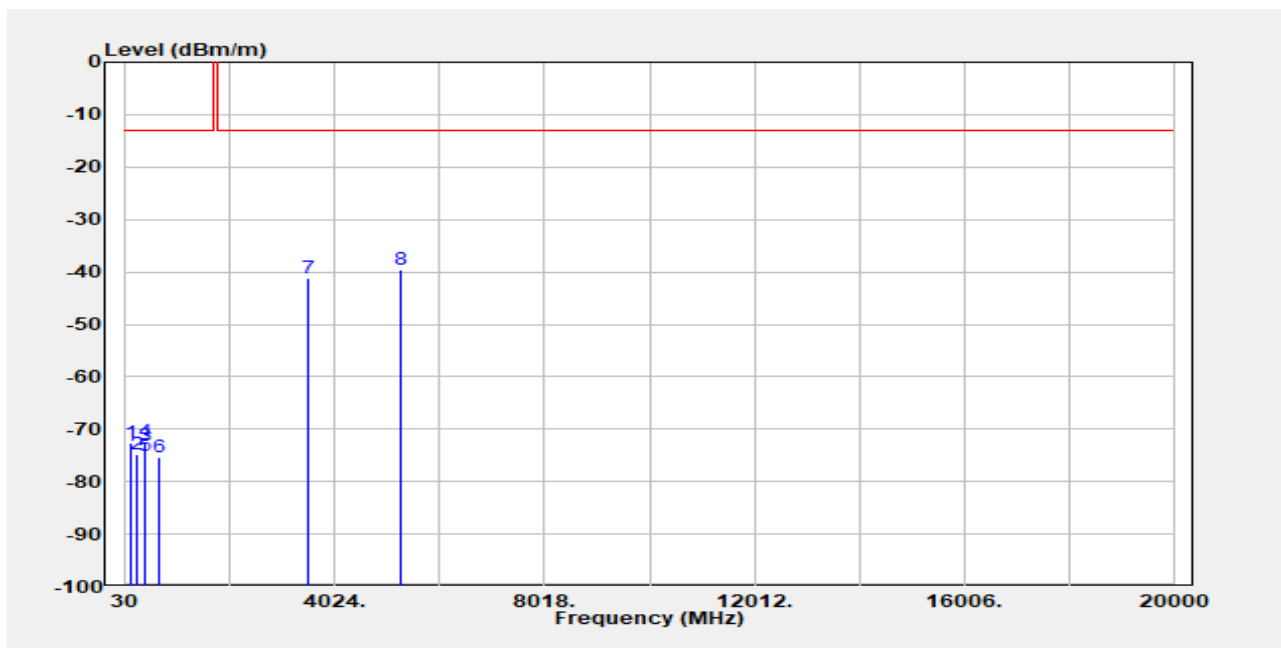

Freq. MHz	EIRP/ERP dBm	SG Output Level dBm	Antenna Gain dBi/dBd	Cable Loss dB	Limit dBm	Margin dB
119.24	-72.66	-69.72	-1.82	-1.12	-13.00	-59.66
252.13	-74.79	-77.52	4.33	-1.60	-13.00	-61.79
384.05	-73.16	-75.52	4.39	-2.02	-13.00	-60.16
397.63	-72.30	-74.51	4.32	-2.11	-13.00	-59.30
412.18	-75.03	-77.58	4.39	-1.85	-13.00	-62.03
660.50	-75.25	-76.51	3.68	-2.41	-13.00	-62.25
3510.00	-41.32	-47.36	12.40	-6.36	-13.00	-28.32
5265.00	-39.55	-44.33	12.86	-8.08	-13.00	-26.55

Unless otherwise stated the results shown in this test report refer only to the sample(s) tested and such sample(s) are retained for 90 days only.

除非另有說明，此報告結果僅對測試之樣品負責，同時此樣品僅保留90天。本報告未經本公司書面許可，不可部份複製。

This document is issued by the Company subject to its General Conditions of Service printed overleaf, available on request or accessible at <http://www.sgs.com.tw/Terms-and-Conditions> and for electronic format documents, subject to Terms and Conditions for Electronic Documents at <http://www.sgs.com.tw/Terms-and-Conditions>. Attention is drawn to the limitation of liability, indemnification and jurisdiction issues defined therein. Any holder of this document is advised that information contained hereon reflects the Company's findings at the time of its intervention only and within the limits of Client's instructions, if any. The Company's sole responsibility is to its Client and this document does not exonerate parties to a transaction from exercising all their rights and obligations under the transaction documents. This document cannot be reproduced except in full, without prior written approval of the Company. Any unauthorized alteration, forgery or falsification of the content or appearance of this document is unlawful and offenders may be prosecuted to the fullest extent of the law.

Report Number :ER/2022/30083  
 Operation Mode :LTE 66B  
 Test Mode :Tx CH High  
 EUT Pol :H Plane  
 Test Frequency :1775.1 MHz

Test Site :SAC 1  
 Test Date :2022-05-10  
 Temp./Humi. :22.5/69  
 Antenna Pol. :Vertical  
 Engineer :GN Lin

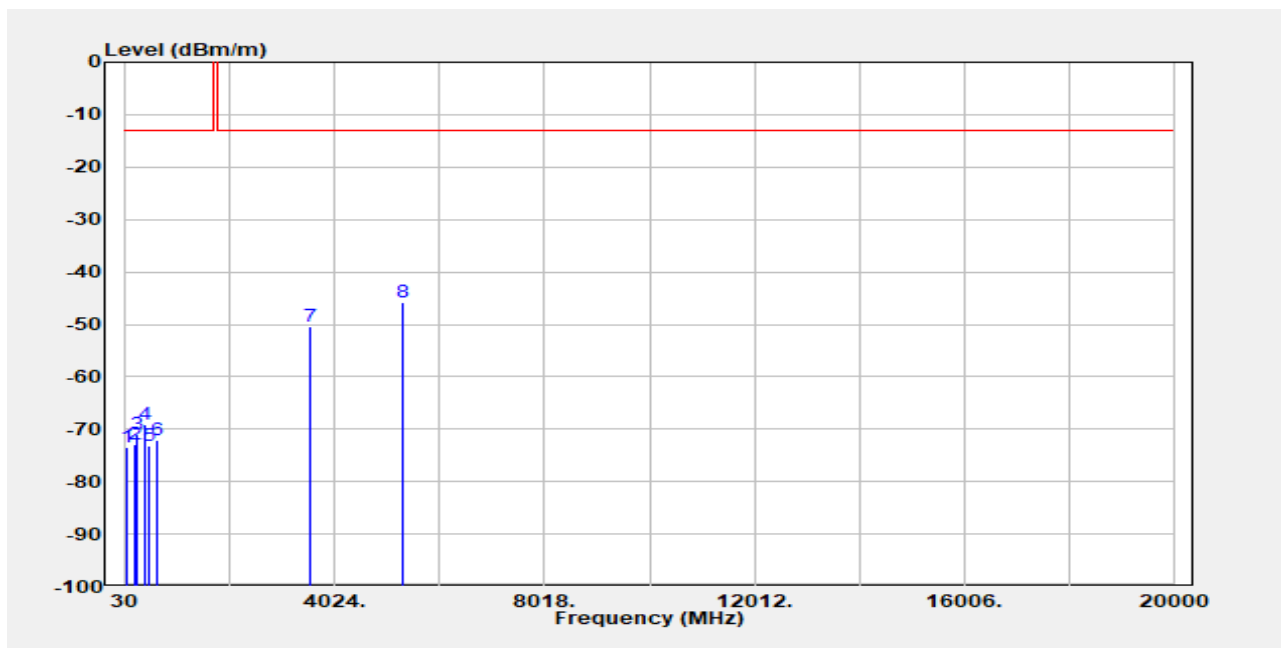

Freq. MHz	EIRP/ERP dBm	SG Output Level dBm	Antenna Gain dBi/dBd	Cable Loss dB	Limit dBm	Margin dB
48.43	-73.38	-60.55	-12.13	-0.70	-13.00	-60.38
195.87	-72.89	-75.46	4.01	-1.43	-13.00	-59.89
253.10	-70.95	-73.67	4.32	-1.60	-13.00	-57.95
398.60	-69.02	-71.22	4.32	-2.12	-13.00	-56.02
480.08	-73.19	-74.95	4.21	-2.44	-13.00	-60.19
641.10	-72.22	-73.54	3.52	-2.19	-13.00	-59.22
3550.20	-50.35	-56.23	12.40	-6.52	-13.00	-37.35
5325.30	-45.77	-50.30	13.00	-8.47	-13.00	-32.77

Unless otherwise stated the results shown in this test report refer only to the sample(s) tested and such sample(s) are retained for 90 days only.

除非另有說明，此報告結果僅對測試之樣品負責，同時此樣品僅保留90天。本報告未經本公司書面許可，不可部份複製。

This document is issued by the Company subject to its General Conditions of Service printed overleaf, available on request or accessible at <http://www.sgs.com.tw/Terms-and-Conditions> and for electronic format documents, subject to Terms and Conditions for Electronic Documents at <http://www.sgs.com.tw/Terms-and-Conditions>. Attention is drawn to the limitation of liability, indemnification and jurisdiction issues defined therein. Any holder of this document is advised that information contained hereon reflects the Company's findings at the time of its intervention only and within the limits of Client's instructions, if any. The Company's sole responsibility is to its Client and this document does not exonerate parties to a transaction from exercising all their rights and obligations under the transaction documents. This document cannot be reproduced except in full, without prior written approval of the Company. Any unauthorized alteration, forgery or falsification of the content or appearance of this document is unlawful and offenders may be prosecuted to the fullest extent of the law.

Report Number :ER/2022/30083  
 Operation Mode :LTE 66B  
 Test Mode :Tx CH High  
 EUT Pol :H Plane  
 Test Frequency :1775.1 MHz

Test Site :SAC 1  
 Test Date :2022-05-10  
 Temp./Humi. :22.5/69  
 Antenna Pol. :Horizontal  
 Engineer :GN Lin

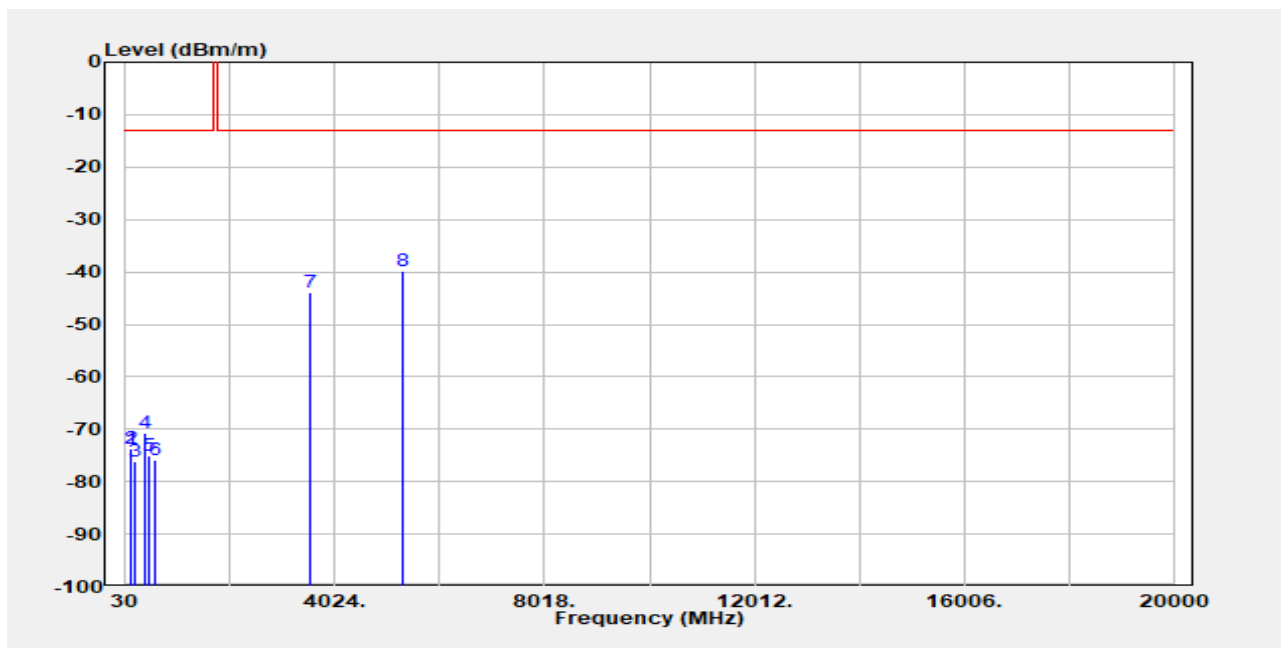

Freq. MHz	EIRP/ERP dBm	SG Output Level dBm	Antenna Gain dBi/dBd	Cable Loss dB	Limit dBm	Margin dB
117.30	-74.05	-71.21	-1.73	-1.11	-13.00	-61.05
128.94	-73.80	-70.64	-2.00	-1.17	-13.00	-60.80
194.90	-76.19	-78.64	3.88	-1.43	-13.00	-63.19
396.66	-70.78	-73.00	4.32	-2.10	-13.00	-57.78
480.08	-74.94	-76.70	4.21	-2.44	-13.00	-61.94
600.36	-75.87	-76.87	3.64	-2.64	-13.00	-62.87
3550.20	-43.99	-49.87	12.40	-6.52	-13.00	-30.99
5325.30	-39.88	-44.41	13.00	-8.47	-13.00	-26.88

Unless otherwise stated the results shown in this test report refer only to the sample(s) tested and such sample(s) are retained for 90 days only.

除非另有說明，此報告結果僅對測試之樣品負責，同時此樣品僅保留90天。本報告未經本公司書面許可，不可部份複製。

This document is issued by the Company subject to its General Conditions of Service printed overleaf, available on request or accessible at <http://www.sgs.com.tw/Terms-and-Conditions> and for electronic format documents, subject to Terms and Conditions for Electronic Documents at <http://www.sgs.com.tw/Terms-and-Conditions>. Attention is drawn to the limitation of liability, indemnification and jurisdiction issues defined therein. Any holder of this document is advised that information contained hereon reflects the Company's findings at the time of its intervention only and within the limits of Client's instructions, if any. The Company's sole responsibility is to its Client and this document does not exonerate parties to a transaction from exercising all their rights and obligations under the transaction documents. This document cannot be reproduced except in full, without prior written approval of the Company. Any unauthorized alteration, forgery or falsification of the content or appearance of this document is unlawful and offenders may be prosecuted to the fullest extent of the law.

Report Number :ER/2022/30083  
 Operation Mode :LTE 2A\_5A  
 Test Mode :Tx CH High\_High  
 EUT Pol :H Plane  
 Test Frequency :1907.5\_846.5 MHz

Test Site :SAC 1  
 Test Date :2022-05-10  
 Temp./Humi. :22.5/69  
 Antenna Pol. :Vertical  
 Engineer :GN Lin

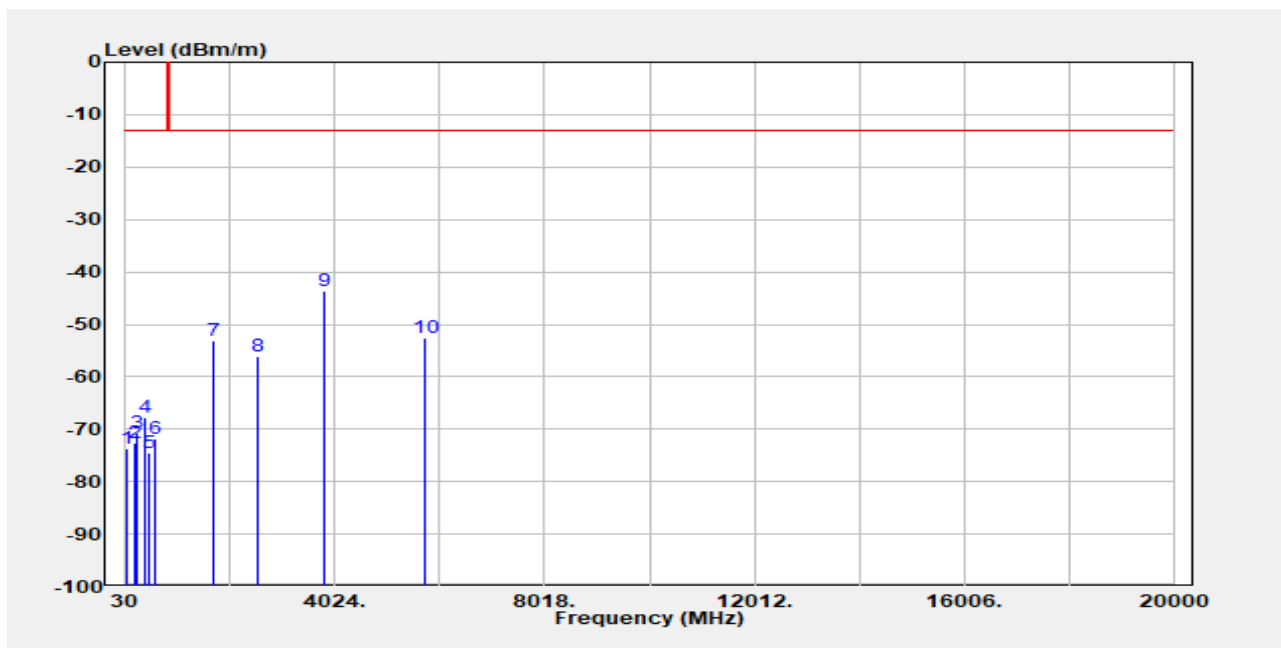

Freq. MHz	EIRP/ERP dBm	SG Output Level dBm	Antenna Gain dBi/dBd	Cable Loss dB	Limit dBm	Margin dB
48.43	-73.61	-60.78	-12.13	-0.70	-13.00	-60.61
194.90	-72.76	-75.21	3.88	-1.43	-13.00	-59.76
252.13	-70.82	-73.55	4.33	-1.60	-13.00	-57.82
395.69	-67.82	-70.04	4.31	-2.09	-13.00	-54.82
480.08	-74.40	-76.16	4.21	-2.44	-13.00	-61.40
606.18	-71.76	-72.78	3.58	-2.56	-13.00	-58.76
1693.00	-53.09	-58.35	9.59	-4.32	-13.00	-40.09
2539.50	-56.02	-61.47	10.68	-5.23	-13.00	-43.02
3815.00	-43.70	-48.41	12.37	-7.66	-13.00	-30.70
5722.50	-52.69	-56.44	12.80	-9.05	-13.00	-39.69

Unless otherwise stated the results shown in this test report refer only to the sample(s) tested and such sample(s) are retained for 90 days only.

除非另有說明，此報告結果僅對測試之樣品負責，同時此樣品僅保留90天。本報告未經本公司書面許可，不可部份複製。

This document is issued by the Company subject to its General Conditions of Service printed overleaf, available on request or accessible at <http://www.sgs.com.tw/Terms-and-Conditions> and for electronic format documents, subject to Terms and Conditions for Electronic Documents at <http://www.sgs.com.tw/Terms-and-Conditions>. Attention is drawn to the limitation of liability, indemnification and jurisdiction issues defined therein. Any holder of this document is advised that information contained hereon reflects the Company's findings at the time of its intervention only and within the limits of Client's instructions, if any. The Company's sole responsibility is to its Client and this document does not exonerate parties to a transaction from exercising all their rights and obligations under the transaction documents. This document cannot be reproduced except in full, without prior written approval of the Company. Any unauthorized alteration, forgery or falsification of the content or appearance of this document is unlawful and offenders may be prosecuted to the fullest extent of the law.

Report Number :ER/2022/30083  
 Operation Mode :LTE 2A\_5A  
 Test Mode :Tx CH High\_High  
 EUT Pol :H Plane  
 Test Frequency :1907.5\_846.5 MHz

Test Site :SAC 1  
 Test Date :2022-05-10  
 Temp./Humi. :22.5/69  
 Antenna Pol. :Horizontal  
 Engineer :GN Lin

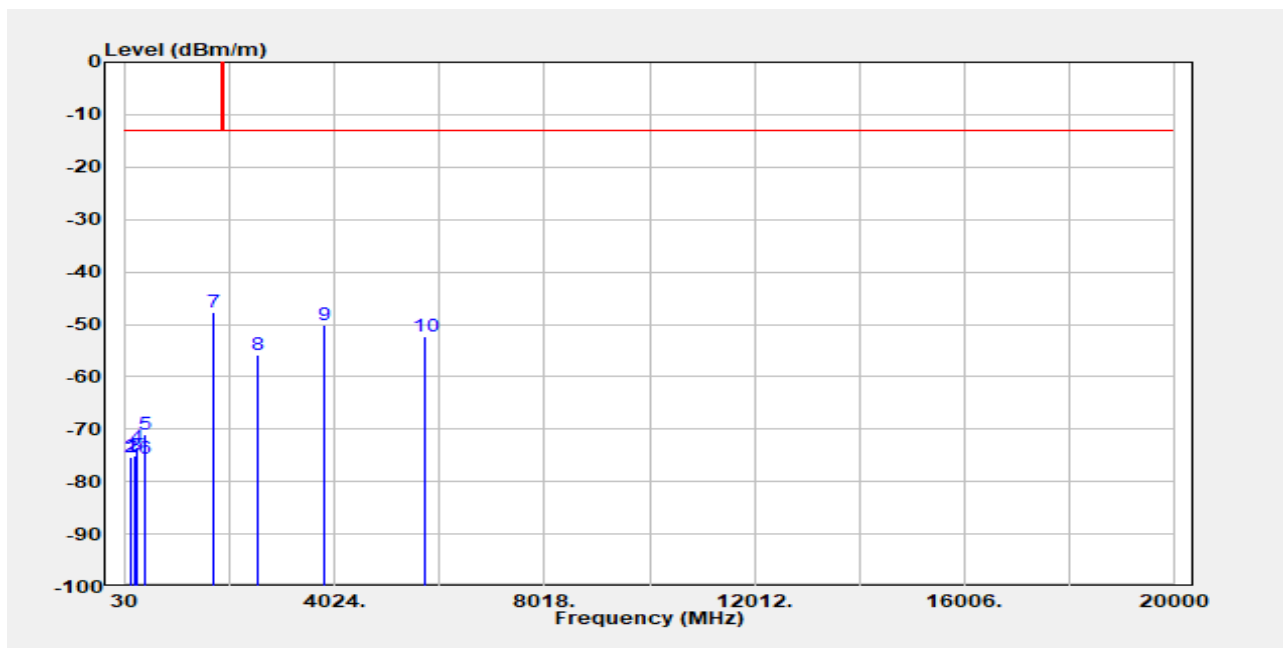

Freq. MHz	EIRP/ERP dBm	SG Output Level dBm	Antenna Gain dBi/dBd	Cable Loss dB	Limit dBm	Margin dB
116.33	-75.29	-72.59	-1.61	-1.10	-13.00	-62.29
130.88	-75.24	-72.06	-1.99	-1.18	-13.00	-62.24
197.81	-75.01	-77.77	4.19	-1.43	-13.00	-62.01
252.13	-73.50	-76.23	4.33	-1.60	-13.00	-60.50
393.75	-71.09	-73.35	4.33	-2.08	-13.00	-58.09
410.24	-75.48	-78.07	4.43	-1.84	-13.00	-62.48
1693.00	-47.62	-52.89	9.59	-4.32	-13.00	-34.62
2539.50	-55.73	-61.18	10.68	-5.23	-13.00	-42.73
3815.00	-50.10	-54.81	12.37	-7.66	-13.00	-37.10
5722.50	-52.33	-56.08	12.80	-9.05	-13.00	-39.33

Unless otherwise stated the results shown in this test report refer only to the sample(s) tested and such sample(s) are retained for 90 days only.

除非另有說明，此報告結果僅對測試之樣品負責，同時此樣品僅保留90天。本報告未經本公司書面許可，不可部份複製。

This document is issued by the Company subject to its General Conditions of Service printed overleaf, available on request or accessible at <http://www.sgs.com.tw/Terms-and-Conditions> and for electronic format documents, subject to Terms and Conditions for Electronic Documents at <http://www.sgs.com.tw/Terms-and-Conditions>. Attention is drawn to the limitation of liability, indemnification and jurisdiction issues defined therein. Any holder of this document is advised that information contained hereon reflects the Company's findings at the time of its intervention only and within the limits of Client's instructions, if any. The Company's sole responsibility is to its Client and this document does not exonerate parties to a transaction from exercising all their rights and obligations under the transaction documents. This document cannot be reproduced except in full, without prior written approval of the Company. Any unauthorized alteration, forgery or falsification of the content or appearance of this document is unlawful and offenders may be prosecuted to the fullest extent of the law.



Report Number :ER/2022/30083  
 Operation Mode :LTE 2A\_13A  
 Test Mode :Tx CH Low\_Mid  
 EUT Pol :H Plane  
 Test Frequency :1852.5\_782 MHz

Test Site :SAC 1  
 Test Date :2022-05-10  
 Temp./Humi. :22.5/69  
 Antenna Pol. :Vertical  
 Engineer :GN Lin

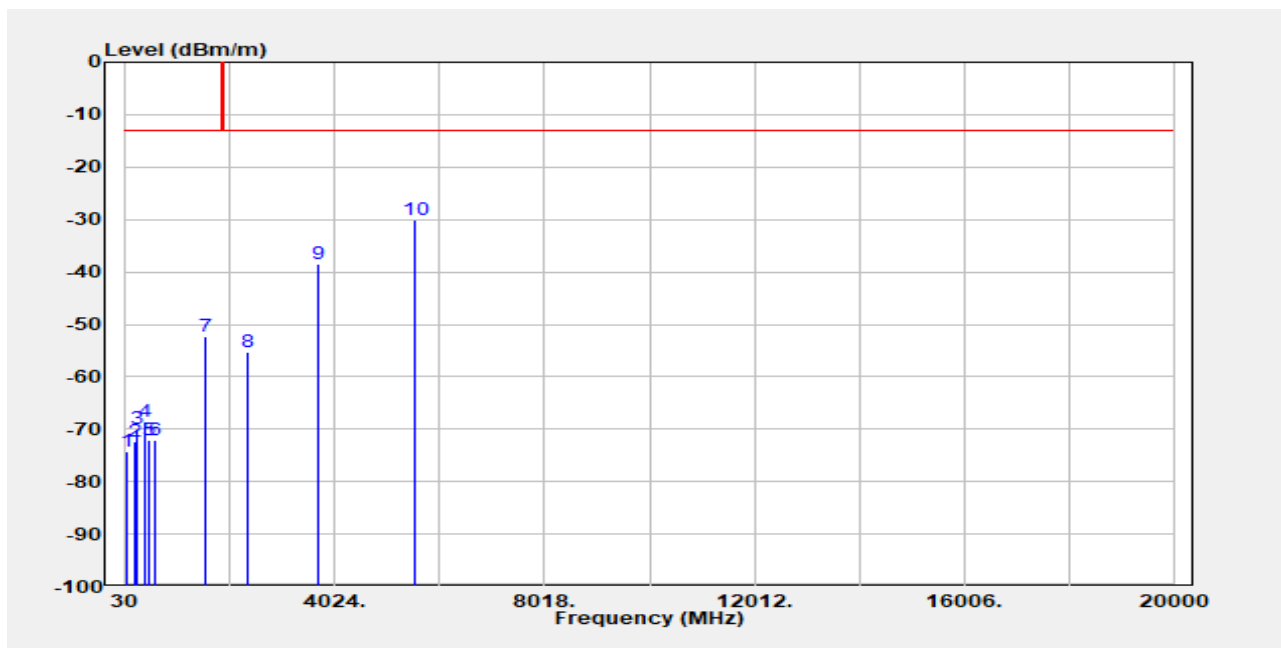

Freq. MHz	EIRP/ERP dBm	SG Output Level dBm	Antenna Gain dBi/dBd	Cable Loss dB	Limit dBm	Margin dB
48.43	-74.20	-61.37	-12.13	-0.70	-13.00	-61.20
197.81	-72.42	-75.18	4.19	-1.43	-13.00	-59.42
253.10	-70.00	-72.72	4.32	-1.60	-13.00	-57.00
398.60	-68.50	-70.70	4.32	-2.12	-13.00	-55.50
480.08	-72.02	-73.78	4.21	-2.44	-13.00	-59.02
591.63	-72.12	-73.26	3.79	-2.65	-13.00	-59.12
1564.00	-52.32	-57.40	9.18	-4.10	-13.00	-39.32
2346.00	-55.35	-60.12	9.78	-5.01	-13.00	-42.35
3705.00	-38.52	-43.58	12.59	-7.53	-13.00	-25.52
5557.50	-30.06	-33.52	13.00	-9.54	-13.00	-17.06

Unless otherwise stated the results shown in this test report refer only to the sample(s) tested and such sample(s) are retained for 90 days only.

除非另有說明，此報告結果僅對測試之樣品負責，同時此樣品僅保留90天。本報告未經本公司書面許可，不可部份複製。

This document is issued by the Company subject to its General Conditions of Service printed overleaf, available on request or accessible at <http://www.sgs.com.tw/Terms-and-Conditions> and for electronic format documents, subject to Terms and Conditions for Electronic Documents at <http://www.sgs.com.tw/Terms-and-Conditions>. Attention is drawn to the limitation of liability, indemnification and jurisdiction issues defined therein. Any holder of this document is advised that information contained hereon reflects the Company's findings at the time of its intervention only and within the limits of Client's instructions, if any. The Company's sole responsibility is to its Client and this document does not exonerate parties to a transaction from exercising all their rights and obligations under the transaction documents. This document cannot be reproduced except in full, without prior written approval of the Company. Any unauthorized alteration, forgery or falsification of the content or appearance of this document is unlawful and offenders may be prosecuted to the fullest extent of the law.

Report Number :ER/2022/30083  
 Operation Mode :LTE 2A\_13A  
 Test Mode :Tx CH Low\_Mid  
 EUT Pol :H Plane  
 Test Frequency :1852.5\_782 MHz

Test Site :SAC 1  
 Test Date :2022-05-10  
 Temp./Humi. :22.5/69  
 Antenna Pol. :Horizontal  
 Engineer :GN Lin

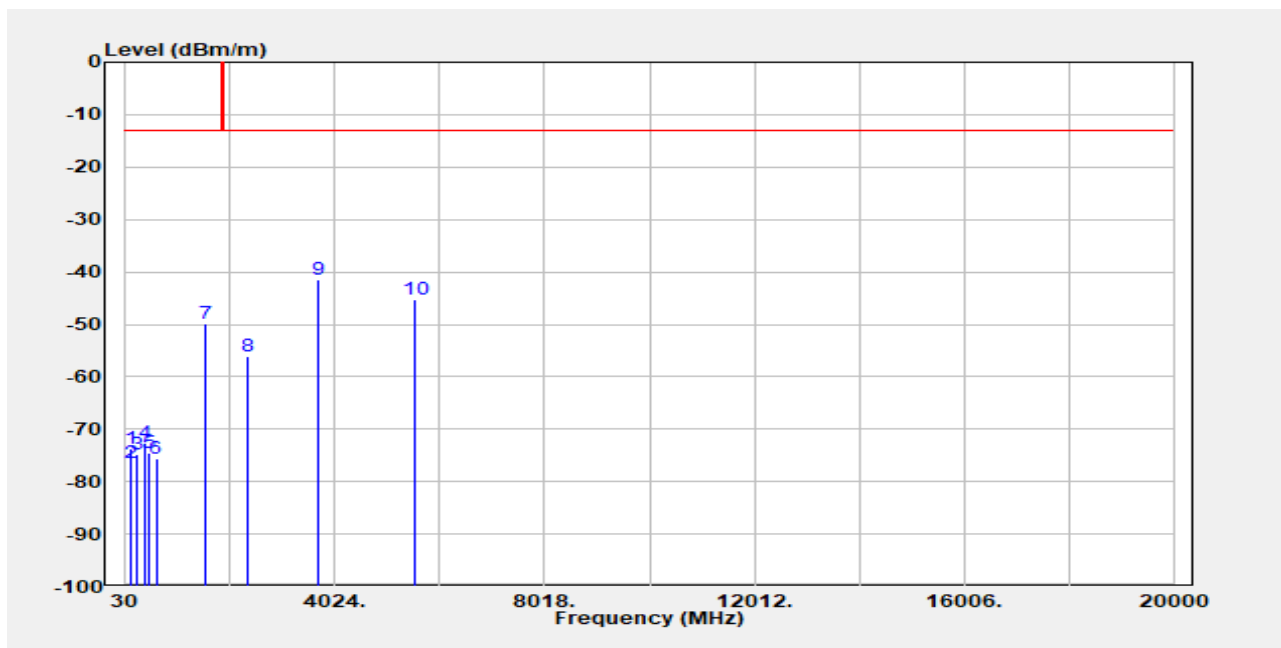

Freq. MHz	EIRP/ERP dBm	SG Output Level dBm	Antenna Gain dBi/dBd	Cable Loss dB	Limit dBm	Margin dB
120.21	-73.72	-70.79	-1.80	-1.13	-13.00	-60.72
131.85	-76.36	-73.07	-2.09	-1.20	-13.00	-63.36
252.13	-74.90	-77.63	4.33	-1.60	-13.00	-61.90
389.87	-72.58	-74.94	4.40	-2.04	-13.00	-59.58
480.08	-74.57	-76.33	4.21	-2.44	-13.00	-61.57
610.06	-75.59	-76.57	3.49	-2.50	-13.00	-62.59
1564.00	-49.90	-54.98	9.18	-4.10	-13.00	-36.90
2346.00	-56.19	-60.96	9.78	-5.01	-13.00	-43.19
3705.00	-41.59	-46.64	12.59	-7.53	-13.00	-28.59
5557.50	-45.15	-48.61	13.00	-9.54	-13.00	-32.15

Unless otherwise stated the results shown in this test report refer only to the sample(s) tested and such sample(s) are retained for 90 days only.

除非另有說明，此報告結果僅對測試之樣品負責，同時此樣品僅保留90天。本報告未經本公司書面許可，不可部份複製。

This document is issued by the Company subject to its General Conditions of Service printed overleaf, available on request or accessible at <http://www.sgs.com.tw/Terms-and-Conditions> and for electronic format documents, subject to Terms and Conditions for Electronic Documents at <http://www.sgs.com.tw/Terms-and-Conditions>. Attention is drawn to the limitation of liability, indemnification and jurisdiction issues defined therein. Any holder of this document is advised that information contained hereon reflects the Company's findings at the time of its intervention only and within the limits of Client's instructions, if any. The Company's sole responsibility is to its Client and this document does not exonerate parties to a transaction from exercising all their rights and obligations under the transaction documents. This document cannot be reproduced except in full, without prior written approval of the Company. Any unauthorized alteration, forgery or falsification of the content or appearance of this document is unlawful and offenders may be prosecuted to the fullest extent of the law.

Report Number :ER/2022/30083  
 Operation Mode :LTE 2A\_66A  
 Test Mode :Tx CH Mid\_Mid  
 EUT Pol :H Plane  
 Test Frequency :1880\_1745 MHz

Test Site :SAC 1  
 Test Date :2022-05-10  
 Temp./Humi. :22.5/69  
 Antenna Pol. :Vertical  
 Engineer :GN Lin

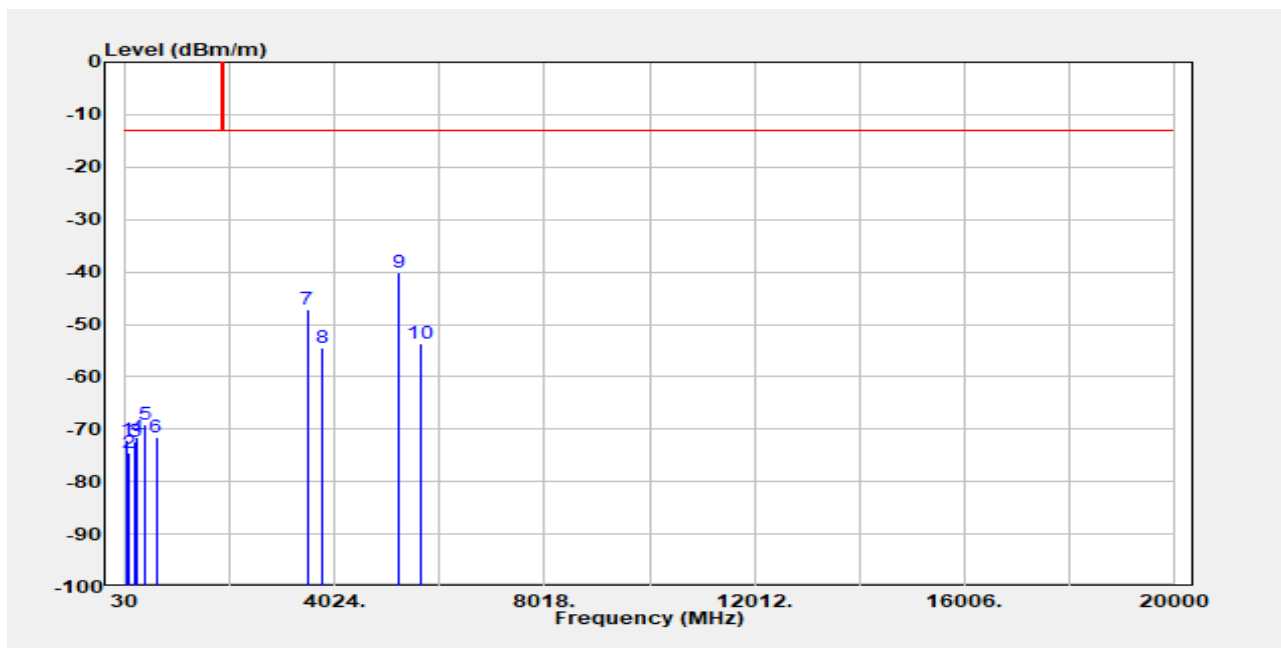

Freq. MHz	EIRP/ERP dBm	SG Output Level dBm	Antenna Gain dBi/dBd	Cable Loss dB	Limit dBm	Margin dB
51.34	-72.21	-60.02	-11.48	-0.71	-13.00	-59.21
102.75	-74.65	-72.54	-1.08	-1.03	-13.00	-61.65
193.93	-72.32	-74.71	3.83	-1.43	-13.00	-59.32
252.13	-71.45	-74.18	4.33	-1.60	-13.00	-58.45
398.60	-69.12	-71.32	4.32	-2.12	-13.00	-56.12
611.03	-71.60	-72.60	3.48	-2.48	-13.00	-58.60
3490.00	-47.11	-53.27	12.42	-6.26	-13.00	-34.11
3760.00	-54.39	-59.16	12.40	-7.63	-13.00	-41.39
5235.00	-40.14	-44.83	12.68	-7.99	-13.00	-27.14
5640.00	-53.55	-57.32	13.00	-9.23	-13.00	-40.55

Unless otherwise stated the results shown in this test report refer only to the sample(s) tested and such sample(s) are retained for 90 days only.

除非另有說明，此報告結果僅對測試之樣品負責，同時此樣品僅保留90天。本報告未經本公司書面許可，不可部份複製。

This document is issued by the Company subject to its General Conditions of Service printed overleaf, available on request or accessible at <http://www.sgs.com.tw/Terms-and-Conditions> and for electronic format documents, subject to Terms and Conditions for Electronic Documents at <http://www.sgs.com.tw/Terms-and-Conditions>. Attention is drawn to the limitation of liability, indemnification and jurisdiction issues defined therein. Any holder of this document is advised that information contained hereon reflects the Company's findings at the time of its intervention only and within the limits of Client's instructions, if any. The Company's sole responsibility is to its Client and this document does not exonerate parties to a transaction from exercising all their rights and obligations under the transaction documents. This document cannot be reproduced except in full, without prior written approval of the Company. Any unauthorized alteration, forgery or falsification of the content or appearance of this document is unlawful and offenders may be prosecuted to the fullest extent of the law.

Report Number :ER/2022/30083  
 Operation Mode :LTE 2A\_66A  
 Test Mode :Tx CH Mid\_Mid  
 EUT Pol :H Plane  
 Test Frequency :1880\_1745 MHz

Test Site :SAC 1  
 Test Date :2022-05-10  
 Temp./Humi. :22.5/69  
 Antenna Pol. :Horizontal  
 Engineer :GN Lin

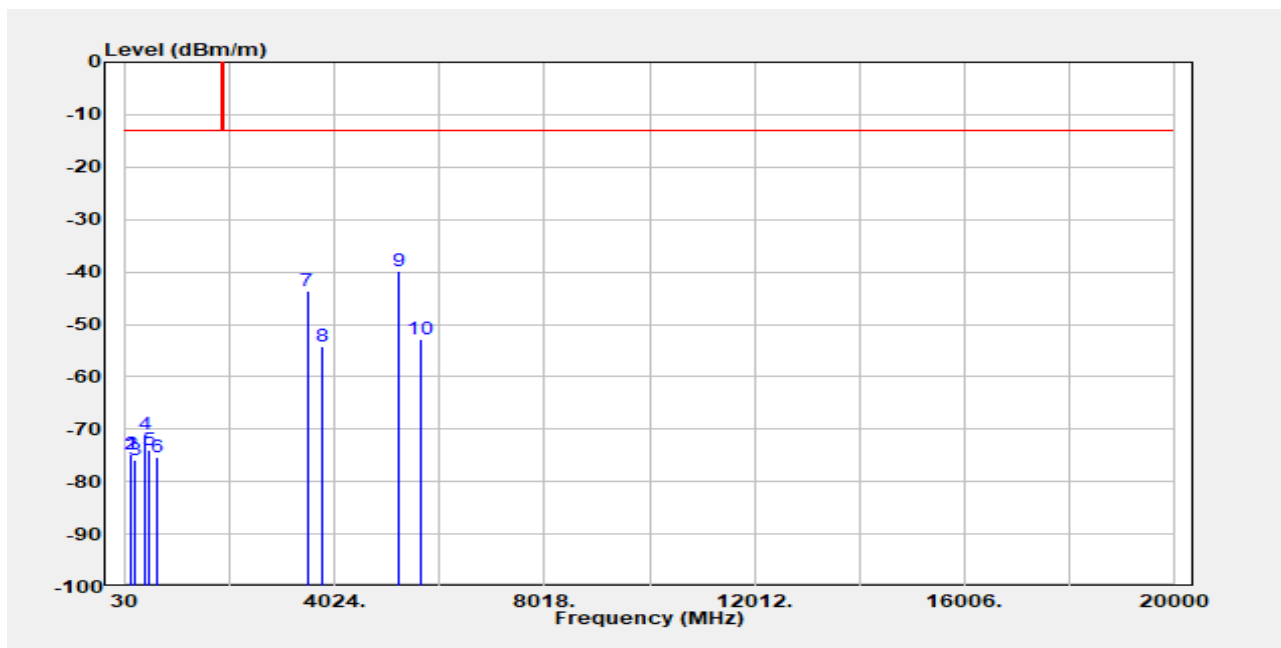

Freq. MHz	EIRP/ERP dBm	SG Output Level dBm	Antenna Gain dBi/dBd	Cable Loss dB	Limit dBm	Margin dB
118.27	-74.75	-71.92	-1.72	-1.12	-13.00	-61.75
127.97	-74.80	-71.76	-1.88	-1.16	-13.00	-61.80
196.84	-75.79	-78.42	4.06	-1.43	-13.00	-62.79
398.60	-71.12	-73.32	4.32	-2.12	-13.00	-58.12
480.08	-74.11	-75.87	4.21	-2.44	-13.00	-61.11
647.89	-75.43	-76.65	3.61	-2.39	-13.00	-62.43
3490.00	-43.74	-49.90	12.42	-6.26	-13.00	-30.74
3760.00	-54.26	-59.03	12.40	-7.63	-13.00	-41.26
5235.00	-39.74	-44.43	12.68	-7.99	-13.00	-26.74
5640.00	-52.72	-56.49	13.00	-9.23	-13.00	-39.72

Unless otherwise stated the results shown in this test report refer only to the sample(s) tested and such sample(s) are retained for 90 days only.

除非另有說明，此報告結果僅對測試之樣品負責，同時此樣品僅保留90天。本報告未經本公司書面許可，不可部份複製。

This document is issued by the Company subject to its General Conditions of Service printed overleaf, available on request or accessible at <http://www.sgs.com.tw/Terms-and-Conditions> and for electronic format documents, subject to Terms and Conditions for Electronic Documents at <http://www.sgs.com.tw/Terms-and-Conditions>. Attention is drawn to the limitation of liability, indemnification and jurisdiction issues defined therein. Any holder of this document is advised that information contained hereon reflects the Company's findings at the time of its intervention only and within the limits of Client's instructions, if any. The Company's sole responsibility is to its Client and this document does not exonerate parties to a transaction from exercising all their rights and obligations under the transaction documents. This document cannot be reproduced except in full, without prior written approval of the Company. Any unauthorized alteration, forgery or falsification of the content or appearance of this document is unlawful and offenders may be prosecuted to the fullest extent of the law.

Report Number :ER/2022/30083  
 Operation Mode :LTE 5A\_66A  
 Test Mode :Tx CH High\_High  
 EUT Pol :H Plane  
 Test Frequency :846.5\_1770 MHz

Test Site :SAC 1  
 Test Date :2022-05-10  
 Temp./Humi. :22.5/69  
 Antenna Pol. :Vertical  
 Engineer :GN Lin

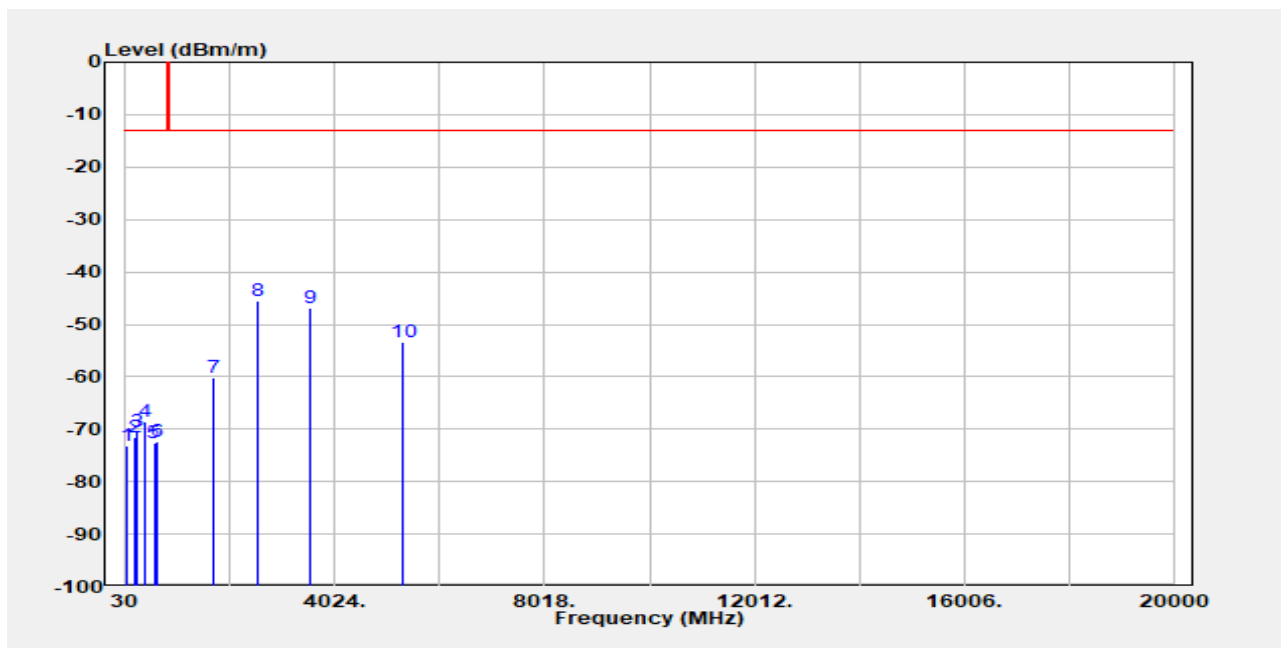

Freq. MHz	EIRP/ERP dBm	SG Output Level dBm	Antenna Gain dBi/dBd	Cable Loss dB	Limit dBm	Margin dB
48.43	-73.15	-60.32	-12.13	-0.70	-13.00	-60.15
195.87	-71.53	-74.10	4.01	-1.43	-13.00	-58.53
252.13	-70.52	-73.25	4.33	-1.60	-13.00	-57.52
394.72	-68.50	-70.74	4.32	-2.08	-13.00	-55.50
572.23	-72.62	-74.03	4.04	-2.64	-13.00	-59.62
612.97	-72.47	-73.50	3.47	-2.44	-13.00	-59.47
1693.00	-60.24	-65.50	9.59	-4.32	-13.00	-47.24
2539.50	-45.56	-51.01	10.68	-5.23	-13.00	-32.56
3540.00	-46.96	-52.88	12.40	-6.48	-13.00	-33.96
5310.00	-53.28	-57.98	13.00	-8.30	-13.00	-40.28

Unless otherwise stated the results shown in this test report refer only to the sample(s) tested and such sample(s) are retained for 90 days only.

除非另有說明，此報告結果僅對測試之樣品負責，同時此樣品僅保留90天。本報告未經本公司書面許可，不可部份複製。

This document is issued by the Company subject to its General Conditions of Service printed overleaf, available on request or accessible at <http://www.sgs.com.tw/Terms-and-Conditions> and for electronic format documents, subject to Terms and Conditions for Electronic Documents at <http://www.sgs.com.tw/Terms-and-Conditions>. Attention is drawn to the limitation of liability, indemnification and jurisdiction issues defined therein. Any holder of this document is advised that information contained hereon reflects the Company's findings at the time of its intervention only and within the limits of Client's instructions, if any. The Company's sole responsibility is to its Client and this document does not exonerate parties to a transaction from exercising all their rights and obligations under the transaction documents. This document cannot be reproduced except in full, without prior written approval of the Company. Any unauthorized alteration, forgery or falsification of the content or appearance of this document is unlawful and offenders may be prosecuted to the fullest extent of the law.

Report Number :ER/2022/30083  
 Operation Mode :LTE 5A\_66A  
 Test Mode :Tx CH High\_High  
 EUT Pol :H Plane  
 Test Frequency :846.5\_1770 MHz

Test Site :SAC 1  
 Test Date :2022-05-10  
 Temp./Humi. :22.5/69  
 Antenna Pol. :Horizontal  
 Engineer :GN Lin

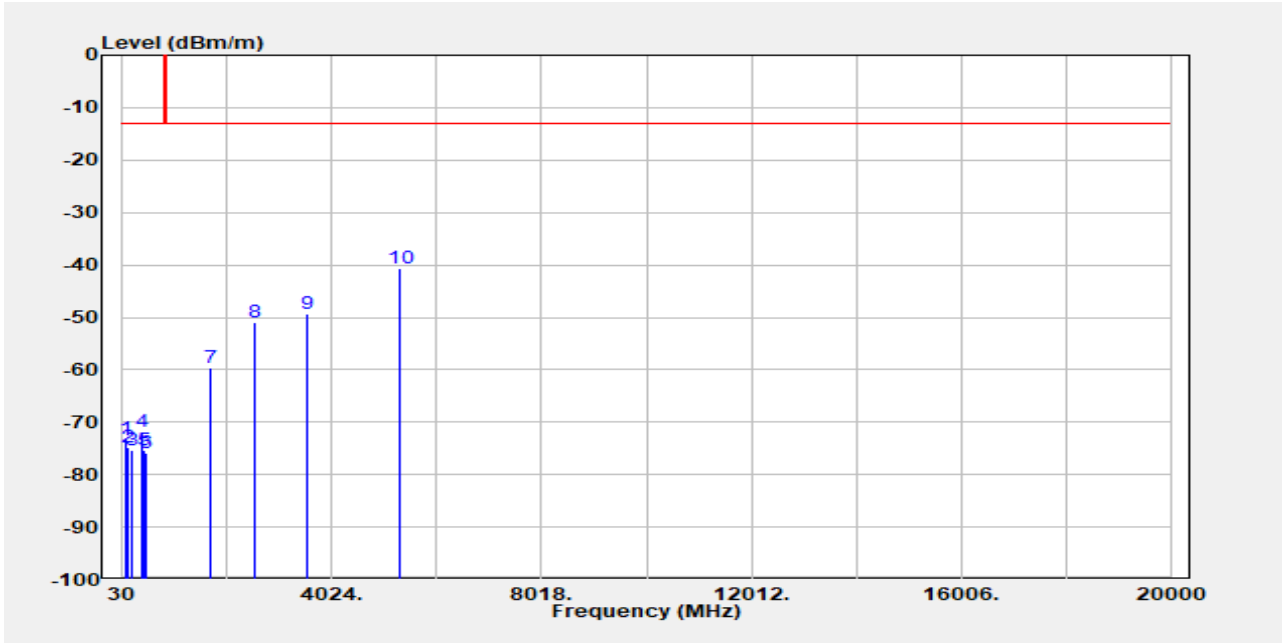

Freq. MHz	EIRP/ERP dBm	SG Output Level dBm	Antenna Gain dBi/dBd	Cable Loss dB	Limit dBm	Margin dB
86.26	-73.08	-71.16	-0.98	-0.95	-13.00	-60.08
116.33	-74.92	-72.21	-1.61	-1.10	-13.00	-61.92
198.78	-75.40	-78.22	4.25	-1.43	-13.00	-62.40
398.60	-71.74	-73.94	4.32	-2.12	-13.00	-58.74
421.88	-75.24	-77.49	4.17	-1.91	-13.00	-62.24
480.08	-76.01	-77.77	4.21	-2.44	-13.00	-63.01
1693.00	-59.70	-64.97	9.59	-4.32	-13.00	-46.70
2539.50	-50.90	-56.35	10.68	-5.23	-13.00	-37.90
3540.00	-49.44	-55.36	12.40	-6.48	-13.00	-36.44
5310.00	-40.63	-45.32	13.00	-8.30	-13.00	-27.63

Unless otherwise stated the results shown in this test report refer only to the sample(s) tested and such sample(s) are retained for 90 days only.

除非另有說明，此報告結果僅對測試之樣品負責，同時此樣品僅保留90天。本報告未經本公司書面許可，不可部份複製。

This document is issued by the Company subject to its General Conditions of Service printed overleaf, available on request or accessible at <http://www.sgs.com.tw/Terms-and-Conditions> and for electronic format documents, subject to Terms and Conditions for Electronic Documents at <http://www.sgs.com.tw/Terms-and-Conditions>. Attention is drawn to the limitation of liability, indemnification and jurisdiction issues defined therein. Any holder of this document is advised that information contained hereon reflects the Company's findings at the time of its intervention only and within the limits of Client's instructions, if any. The Company's sole responsibility is to its Client and this document does not exonerate parties to a transaction from exercising all their rights and obligations under the transaction documents. This document cannot be reproduced except in full, without prior written approval of the Company. Any unauthorized alteration, forgery or falsification of the content or appearance of this document is unlawful and offenders may be prosecuted to the fullest extent of the law.

Report Number :ER/2022/30083  
 Operation Mode :LTE 13A\_66A  
 Test Mode :Tx CH Mid\_Mid  
 EUT Pol :H Plane  
 Test Frequency :782\_1745 MHz

Test Site :SAC 1  
 Test Date :2022-05-10  
 Temp./Humi. :22.5/69  
 Antenna Pol. :Vertical  
 Engineer :GN Lin

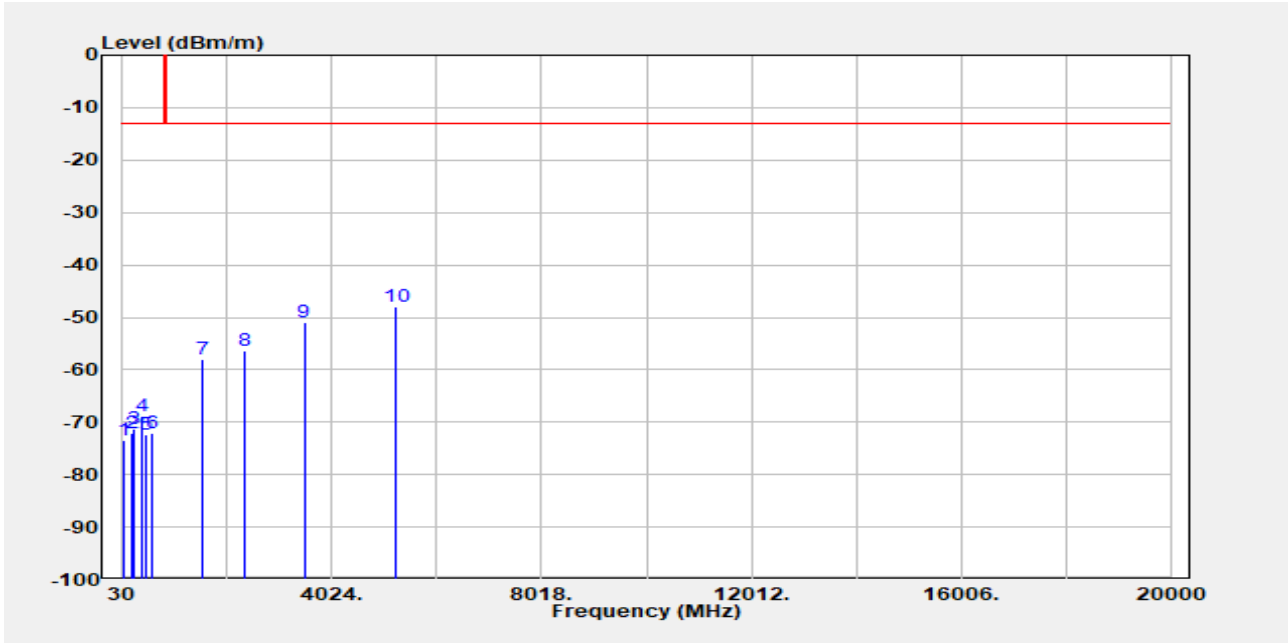

Freq. MHz	EIRP/ERP dBm	SG Output Level dBm	Antenna Gain dBi/dBd	Cable Loss dB	Limit dBm	Margin dB
48.43	-73.54	-60.71	-12.13	-0.70	-13.00	-60.54
194.90	-71.95	-74.40	3.88	-1.43	-13.00	-58.95
253.10	-71.41	-74.12	4.32	-1.60	-13.00	-58.41
394.72	-68.70	-70.94	4.32	-2.08	-13.00	-55.70
480.08	-72.28	-74.05	4.21	-2.44	-13.00	-59.28
593.57	-72.16	-73.29	3.78	-2.65	-13.00	-59.16
1564.00	-57.96	-63.04	9.18	-4.10	-13.00	-44.96
2346.00	-56.48	-61.05	9.58	-5.01	-13.00	-43.48
3490.00	-50.97	-57.12	12.42	-6.26	-13.00	-37.97
5235.00	-47.93	-52.62	12.68	-7.99	-13.00	-34.93

Unless otherwise stated the results shown in this test report refer only to the sample(s) tested and such sample(s) are retained for 90 days only.

除非另有說明，此報告結果僅對測試之樣品負責，同時此樣品僅保留90天。本報告未經本公司書面許可，不可部份複製。

This document is issued by the Company subject to its General Conditions of Service printed overleaf, available on request or accessible at <http://www.sgs.com.tw/Terms-and-Conditions> and for electronic format documents, subject to Terms and Conditions for Electronic Documents at <http://www.sgs.com.tw/Terms-and-Conditions>. Attention is drawn to the limitation of liability, indemnification and jurisdiction issues defined therein. Any holder of this document is advised that information contained hereon reflects the Company's findings at the time of its intervention only and within the limits of Client's instructions, if any. The Company's sole responsibility is to its Client and this document does not exonerate parties to a transaction from exercising all their rights and obligations under the transaction documents. This document cannot be reproduced except in full, without prior written approval of the Company. Any unauthorized alteration, forgery or falsification of the content or appearance of this document is unlawful and offenders may be prosecuted to the fullest extent of the law.

Report Number :ER/2022/30083  
 Operation Mode :LTE 13A\_66A  
 Test Mode :Tx CH Mid\_Mid  
 EUT Pol :H Plane  
 Test Frequency :782\_1745 MHz

Test Site :SAC 1  
 Test Date :2022-05-10  
 Temp./Humi. :22.5/69  
 Antenna Pol. :Horizontal  
 Engineer :GN Lin

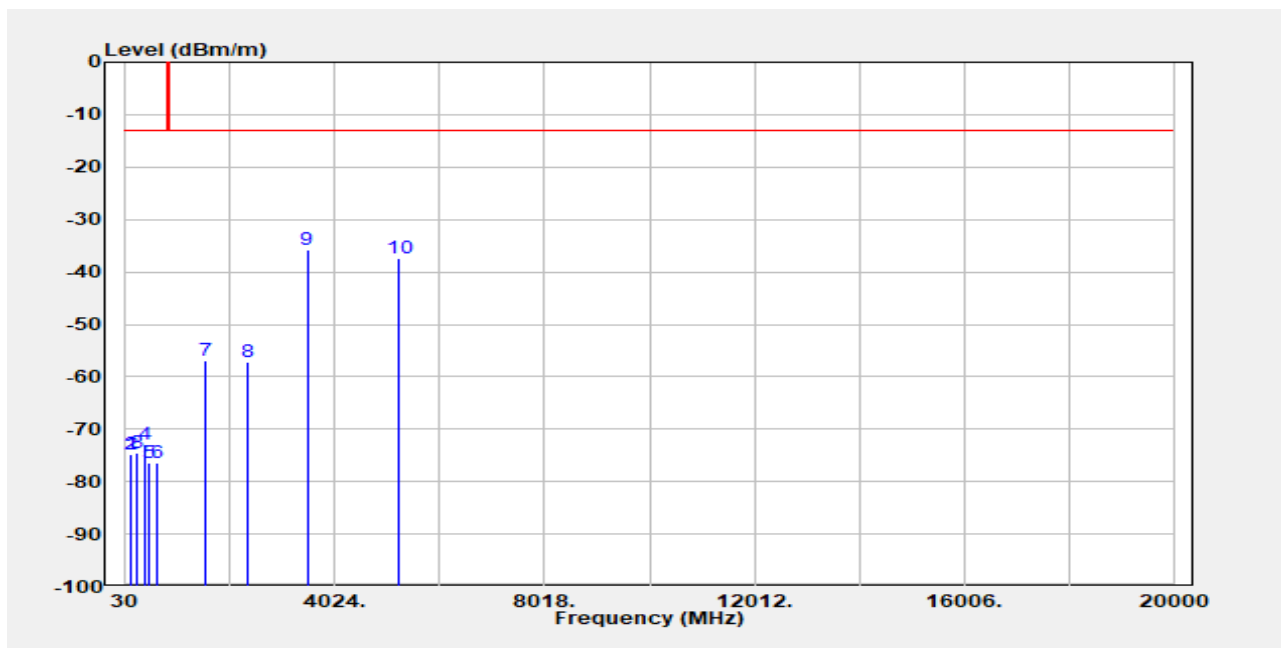

Freq. MHz	EIRP/ERP dBm	SG Output Level dBm	Antenna Gain dBi/dBd	Cable Loss dB	Limit dBm	Margin dB
116.33	-74.78	-72.07	-1.61	-1.10	-13.00	-61.78
128.94	-74.85	-71.68	-2.00	-1.17	-13.00	-61.85
252.13	-74.61	-77.34	4.33	-1.60	-13.00	-61.61
394.72	-72.79	-75.03	4.32	-2.08	-13.00	-59.79
480.08	-76.54	-78.30	4.21	-2.44	-13.00	-63.54
612.97	-76.39	-77.42	3.47	-2.44	-13.00	-63.39
1564.00	-56.90	-61.98	9.18	-4.10	-13.00	-43.90
2346.00	-57.14	-61.71	9.58	-5.01	-13.00	-44.14
3490.00	-35.71	-41.87	12.42	-6.26	-13.00	-22.71
5235.00	-37.52	-42.21	12.68	-7.99	-13.00	-24.52

Unless otherwise stated the results shown in this test report refer only to the sample(s) tested and such sample(s) are retained for 90 days only.

除非另有說明，此報告結果僅對測試之樣品負責，同時此樣品僅保留90天。本報告未經本公司書面許可，不可部份複製。

This document is issued by the Company subject to its General Conditions of Service printed overleaf, available on request or accessible at <http://www.sgs.com.tw/Terms-and-Conditions> and for electronic format documents, subject to Terms and Conditions for Electronic Documents at <http://www.sgs.com.tw/Terms-and-Conditions>. Attention is drawn to the limitation of liability, indemnification and jurisdiction issues defined therein. Any holder of this document is advised that information contained hereon reflects the Company's findings at the time of its intervention only and within the limits of Client's instructions, if any. The Company's sole responsibility is to its Client and this document does not exonerate parties to a transaction from exercising all their rights and obligations under the transaction documents. This document cannot be reproduced except in full, without prior written approval of the Company. Any unauthorized alteration, forgery or falsification of the content or appearance of this document is unlawful and offenders may be prosecuted to the fullest extent of the law.



Report Number :ER/2022/30083  
 Operation Mode :LTE 5A\_13A  
 Test Mode :Tx CH Low\_Mid  
 EUT Pol :H Plane  
 Test Frequency :826.5\_782 MHz

Test Site :SAC 1  
 Test Date :2022-05-10  
 Temp./Humi. :22.5/69  
 Antenna Pol. :Vertical  
 Engineer :GN Lin

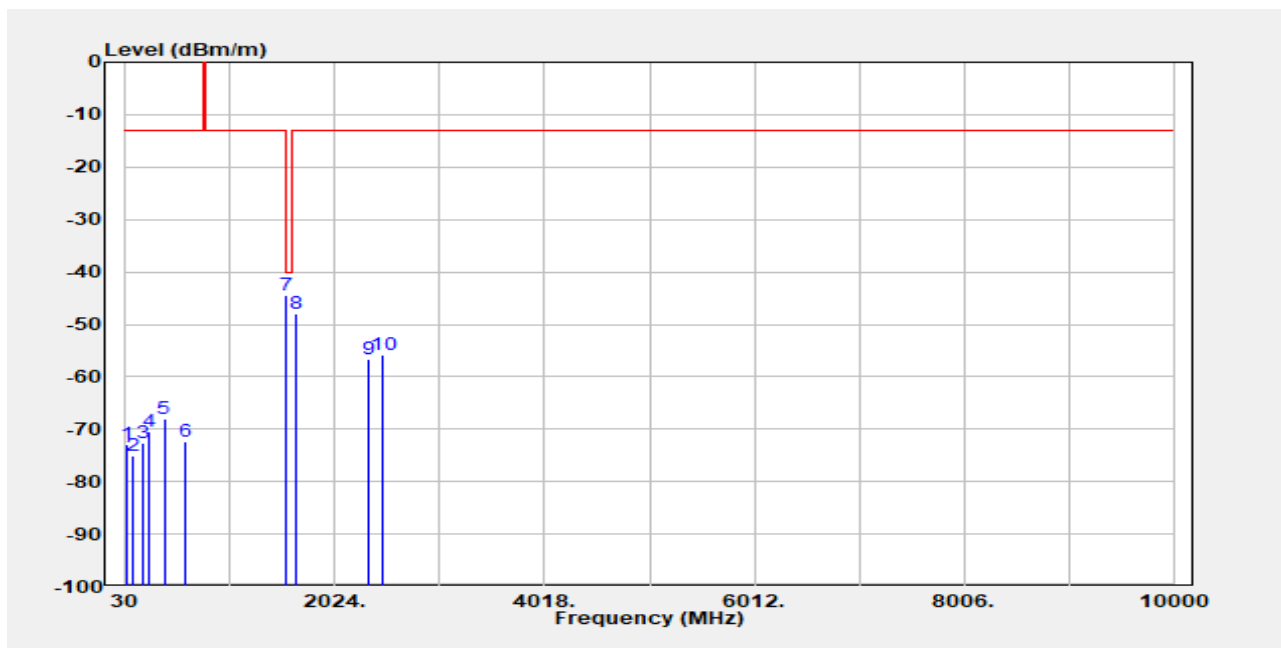

Freq. MHz	EIRP/ERP dBm	SG Output Level dBm	Antenna Gain dBi/dBd	Cable Loss dB	Limit dBm	Margin dB
48.43	-73.02	2.02	-12.13	-0.70	-13.00	-60.02
103.72	-75.19	-0.15	-1.07	-1.03	-13.00	-62.19
196.84	-72.65	-3.89	4.06	-1.43	-13.00	-59.65
253.10	-70.45	-2.89	4.32	-1.60	-13.00	-57.45
396.66	-68.07	-2.40	4.32	-2.10	-13.00	-55.07
600.36	-72.29	3.78	3.64	-2.64	-13.00	-59.29
1564.00	-44.47	-49.55	9.18	-4.10	-40.00	-4.47
1653.00	-47.88	-53.13	9.51	-4.26	-13.00	-34.88
2346.00	-56.59	-61.16	9.58	-5.01	-13.00	-43.59
2479.50	-55.90	-61.29	10.56	-5.17	-13.00	-42.90

Unless otherwise stated the results shown in this test report refer only to the sample(s) tested and such sample(s) are retained for 90 days only.

除非另有說明，此報告結果僅對測試之樣品負責，同時此樣品僅保留90天。本報告未經本公司書面許可，不可部份複製。

This document is issued by the Company subject to its General Conditions of Service printed overleaf, available on request or accessible at <http://www.sgs.com.tw/Terms-and-Conditions> and for electronic format documents, subject to Terms and Conditions for Electronic Documents at <http://www.sgs.com.tw/Terms-and-Conditions>. Attention is drawn to the limitation of liability, indemnification and jurisdiction issues defined therein. Any holder of this document is advised that information contained hereon reflects the Company's findings at the time of its intervention only and within the limits of Client's instructions, if any. The Company's sole responsibility is to its Client and this document does not exonerate parties to a transaction from exercising all their rights and obligations under the transaction documents. This document cannot be reproduced except in full, without prior written approval of the Company. Any unauthorized alteration, forgery or falsification of the content or appearance of this document is unlawful and offenders may be prosecuted to the fullest extent of the law.

Report Number :ER/2022/30083  
 Operation Mode :LTE 5A\_13A  
 Test Mode :Tx CH Low\_Mid  
 EUT Pol :H Plane  
 Test Frequency :826.5\_782 MHz

Test Site :SAC 1  
 Test Date :2022-05-10  
 Temp./Humi. :22.5/69  
 Antenna Pol. :Horizontal  
 Engineer :GN Lin

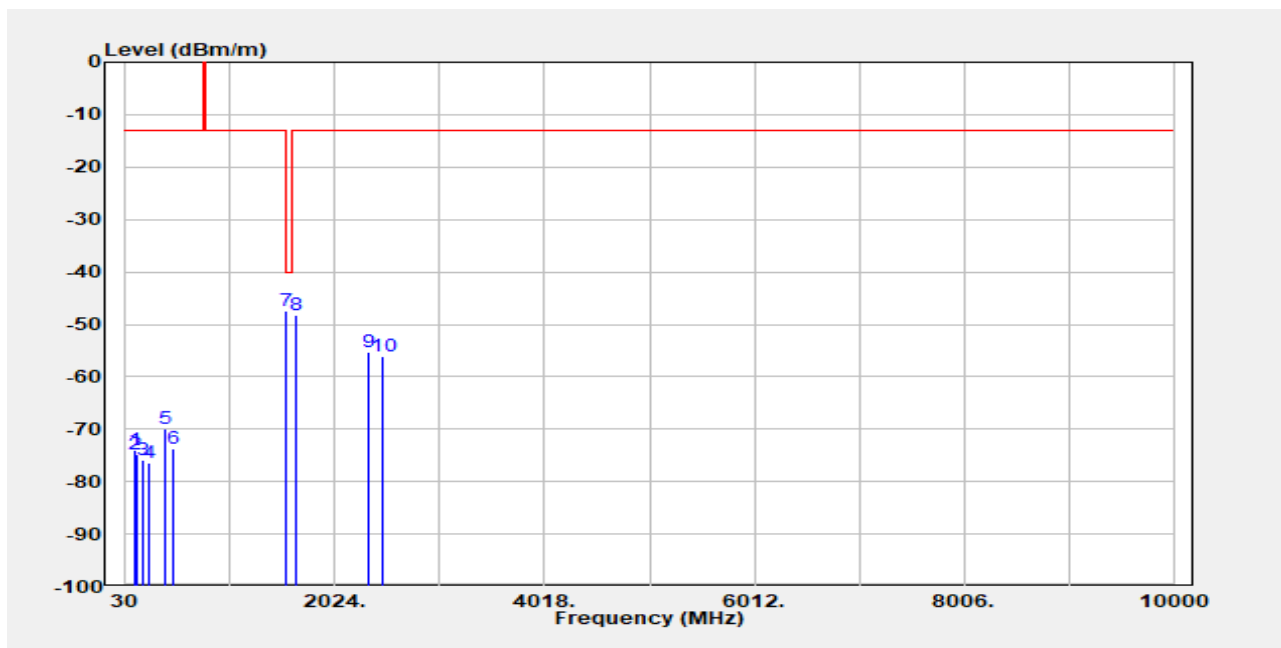

Freq. MHz	EIRP/ERP dBm	SG Output Level dBm	Antenna Gain dBi/dBd	Cable Loss dB	Limit dBm	Margin dB
116.33	-74.05	-71.35	-1.61	-1.10	-13.00	-61.05
127.97	-74.68	-71.64	-1.88	-1.16	-13.00	-61.68
193.93	-75.76	-78.16	3.83	-1.43	-13.00	-62.76
251.16	-76.33	-79.07	4.33	-1.59	-13.00	-63.33
397.63	-69.93	-72.14	4.32	-2.11	-13.00	-56.93
480.08	-73.60	-75.37	4.21	-2.44	-13.00	-60.60
1564.00	-47.34	-52.42	9.18	-4.10	-40.00	-7.34
1653.00	-48.22	-53.46	9.51	-4.26	-13.00	-35.22
2346.00	-55.21	-59.78	9.58	-5.01	-13.00	-42.21
2479.50	-56.12	-61.51	10.56	-5.17	-13.00	-43.12

Unless otherwise stated the results shown in this test report refer only to the sample(s) tested and such sample(s) are retained for 90 days only.

除非另有說明，此報告結果僅對測試之樣品負責，同時此樣品僅保留90天。本報告未經本公司書面許可，不可部份複製。

This document is issued by the Company subject to its General Conditions of Service printed overleaf, available on request or accessible at <http://www.sgs.com.tw/Terms-and-Conditions> and for electronic format documents, subject to Terms and Conditions for Electronic Documents at <http://www.sgs.com.tw/Terms-and-Conditions>. Attention is drawn to the limitation of liability, indemnification and jurisdiction issues defined therein. Any holder of this document is advised that information contained hereon reflects the Company's findings at the time of its intervention only and within the limits of Client's instructions, if any. The Company's sole responsibility is to its Client and this document does not exonerate parties to a transaction from exercising all their rights and obligations under the transaction documents. This document cannot be reproduced except in full, without prior written approval of the Company. Any unauthorized alteration, forgery or falsification of the content or appearance of this document is unlawful and offenders may be prosecuted to the fullest extent of the law.

## 11 FREQUENCY STABILITY MEASUREMENT

### 11.1 Standard Applicabl

The frequency stability shall be sufficient to ensure that the fundamental emission stays within the authorized frequency block.

### 11.2 Test Set-up

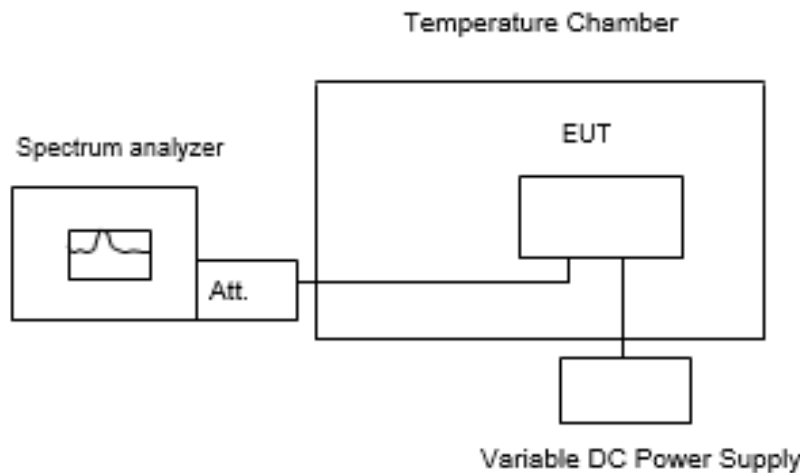

**Note:** Measurement setup for testing on Antenna connector

### 11.3 Measurement Procedure

The equipment under test was connected to an external AC or DC power supply and input rated voltage. RF output was connected to a frequency counter or spectrum analyzer via feed through attenuators. The EUT was placed inside the temperature chamber. Set the spectrum analyzer RBW low enough to obtain the desired frequency resolution and measure EUT 25°C operating frequency as reference frequency. Turn EUT off and set the chamber temperature to -30°C. After the temperature stabilized for approximately 30 minutes recorded the frequency. Repeat step measure with 10°C increased per stage until the highest temperature of +50°C reached.

Set chamber temperature to 25°C. Use a variable AC power supply / DC power source to power the EUT and set the voltage to rated voltage. Set the spectrum analyzer RBW low enough to obtain the desired frequency resolution and recorded the frequency. Reduce the input voltage to specify extreme voltage variation (+/- 15%) and endpoint as declared by the manufacturer, record the maximum frequency change.

Unless otherwise stated the results shown in this test report refer only to the sample(s) tested and such sample(s) are retained for 90 days only.

除非另有說明，此報告結果僅對測試之樣品負責，同時此樣品僅保留90天。本報告未經本公司書面許可，不可部份複製。

This document is issued by the Company subject to its General Conditions of Service printed overleaf, available on request or accessible at <http://www.sgs.com.tw/Terms-and-Conditions> and for electronic format documents, subject to Terms and Conditions for Electronic Documents at <http://www.sgs.com.tw/Terms-and-Conditions>. Attention is drawn to the limitation of liability, indemnification and jurisdiction issues defined therein. Any holder of this document is advised that information contained hereon reflects the Company's findings at the time of its intervention only and within the limits of Client's instructions, if any. The Company's sole responsibility is to its Client and this document does not exonerate parties to a transaction from exercising all their rights and obligations under the transaction documents. This document cannot be reproduced except in full, without prior written approval of the Company. Any unauthorized alteration, forgery or falsification of the content or appearance of this document is unlawful and offenders may be prosecuted to the fullest extent of the law.

### 11.4 Measurement Result

**Note:** The power is rated 120V

Reference Freq.:	LTE CAB5: Mid Channel (MHz)		836.5
	Channel Bandwidth:		10MHz+10MHz
Power Supply Vdc	Temp. (°C)	Frequency (MHz)	Frequency Error (ppm)
<b>Freq. ERROR vs. VOLTAGE</b>			
138	25	836.500017	0.0197
120	25	836.499991	-0.0113
102	25	836.499990	-0.0124
62	25	836.500008	0.0022
(End Point)			
<b>Freq. ERROR vs. Temp.</b>			
120	-30	836.499991	-8.9300
120	-20	836.499984	-16.1100
120	-10	836.500014	13.7900
120	0	836.500014	14.4000
120	10	836.500015	14.7800
120	20	836.499992	-7.6200
120	30	836.500015	14.9700
120	40	836.500007	6.8300
120	50	836.499988	-11.9900

Unless otherwise stated the results shown in this test report refer only to the sample(s) tested and such sample(s) are retained for 90 days only.

除非另有說明，此報告結果僅對測試之樣品負責，同時此樣品僅保留90天。本報告未經本公司書面許可，不可部份複製。

This document is issued by the Company subject to its General Conditions of Service printed overleaf, available on request or accessible at <http://www.sgs.com.tw/Terms-and-Conditions> and for electronic format documents, subject to Terms and Conditions for Electronic Documents at <http://www.sgs.com.tw/Terms-and-Conditions>. Attention is drawn to the limitation of liability, indemnification and jurisdiction issues defined therein. Any holder of this document is advised that information contained hereon reflects the Company's findings at the time of its intervention only and within the limits of Client's instructions, if any. The Company's sole responsibility is to its Client and this document does not exonerate parties to a transaction from exercising all their rights and obligations under the transaction documents. This document cannot be reproduced except in full, without prior written approval of the Company. Any unauthorized alteration, forgery or falsification of the content or appearance of this document is unlawful and offenders may be prosecuted to the fullest extent of the law.

Reference Freq.:	LTE CAB66: Mid Channel (MHz)		1745
	Channel Bandwidth:		20MHz+20MHz
Power Supply Vdc	Temp. (°C)	Frequency (MHz)	Frequency Error (ppm)
<b>Freq. ERROR vs. VOLTAGE</b>			
138	25	1745.000014	0.0082
120	25	1745.000010	0.0059
102	25	1744.999991	-0.0050
62	25	1744.999992	-0.0045
(End Point)			
<b>Freq. ERROR vs. Temp.</b>			
120	-30	1745.000001	0.8000
120	-20	1745.000010	10.1100
120	-10	1745.000009	9.2400
120	0	1745.000003	3.2600
120	10	1745.000004	4.2100
120	20	1745.000007	7.0600
120	30	1745.000018	17.5000
120	40	1744.999989	-10.7600
120	50	1744.999987	-13.0000

Unless otherwise stated the results shown in this test report refer only to the sample(s) tested and such sample(s) are retained for 90 days only.

除非另有說明，此報告結果僅對測試之樣品負責，同時此樣品僅保留90天。本報告未經本公司書面許可，不可部份複製。

This document is issued by the Company subject to its General Conditions of Service printed overleaf, available on request or accessible at <http://www.sgs.com.tw/Terms-and-Conditions> and for electronic format documents, subject to Terms and Conditions for Electronic Documents at <http://www.sgs.com.tw/Terms-and-Conditions>. Attention is drawn to the limitation of liability, indemnification and jurisdiction issues defined therein. Any holder of this document is advised that information contained hereon reflects the Company's findings at the time of its intervention only and within the limits of Client's instructions, if any. The Company's sole responsibility is to its Client and this document does not exonerate parties to a transaction from exercising all their rights and obligations under the transaction documents. This document cannot be reproduced except in full, without prior written approval of the Company. Any unauthorized alteration, forgery or falsification of the content or appearance of this document is unlawful and offenders may be prosecuted to the fullest extent of the law.

## 12 PEAK TO AVERAGE RATIO

### 12.1 Standard Applicable

The peak-to-average ratio (PAR) of the transmission may not exceed 13dB.

### 12.2 Test SET-UP

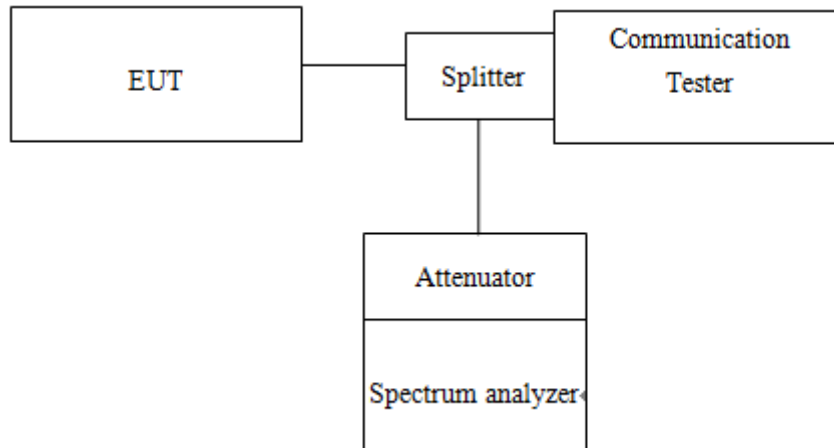

### 12.3 Measurement Procedure

1. KDB 971168 D01 is employed as the following procedure is proper adjusted accordingly:
2. Set resolution/measurement bandwidth  $\geq$  signal's occupied bandwidth; & internal =1ms
3. Set the number of counts to a value that stabilizes the measured CCDF curve.

### 12.4 Measurement Result

#### LTE BAND 5B

Band	Bandwidth	RB Allocation/RB Offset	Frequency (MHz)	PAPR (dB)	
				64QAM	Limit
LTE BAND 5B	5MHz + 10MHz	25/0 + 50/0	836.5	7.22	13
LTE BAND 5B	10MHz + 5MHz	50/0 + 25/0	836.5	7.11	13
LTE BAND 5B	10MHz + 10MHz	50/0 + 50/0	836.5	7.55	13

Unless otherwise stated the results shown in this test report refer only to the sample(s) tested and such sample(s) are retained for 90 days only.

除非另有說明，此報告結果僅對測試之樣品負責，同時此樣品僅保留90天。本報告未經本公司書面許可，不可部份複製。

This document is issued by the Company subject to its General Conditions of Service printed overleaf, available on request or accessible at <http://www.sgs.com.tw/Terms-and-Conditions> and for electronic format documents, subject to Terms and Conditions for Electronic Documents at <http://www.sgs.com.tw/Terms-and-Conditions>. Attention is drawn to the limitation of liability, indemnification and jurisdiction issues defined therein. Any holder of this document is advised that information contained hereon reflects the Company's findings at the time of its intervention only and within the limits of Client's instructions, if any. The Company's sole responsibility is to its Client and this document does not exonerate parties to a transaction from exercising all their rights and obligations under the transaction documents. This document cannot be reproduced except in full, without prior written approval of the Company. Any unauthorized alteration, forgery or falsification of the content or appearance of this document is unlawful and offenders may be prosecuted to the fullest extent of the law.

**LTE BAND 66B**

Band	Bandwidth	RB Allocation/RB Offset	Frequency (MHz)	PAPR (dB)	
				64QAM	Limit
LTE BAND 66B	5MHz + 5MHz	25/0 + 25/0	1745.0	7.310	13
LTE BAND 66B	5MHz + 10MHz	25/0 + 50/0	1745.0	6.980	13
LTE BAND 66B	10MHz + 5MHz	50/0 + 25/0	1745.0	6.620	13
LTE BAND 66B	5MHz + 15MHz	25/0 + 75/0	1745.0	6.990	13
LTE BAND 66B	15MHz + 5MHz	75/0 + 25/0	1745.0	6.660	13
LTE BAND 66B	10MHz + 10MHz	50/0 + 50/0	1745.0	6.710	13

**LTE BAND 66C**

Band	Bandwidth	RB Allocation/RB Offset	Frequency (MHz)	PAPR (dB)	
				64QAM	Limit
LTE BAND 66C	5MHz + 20MHz	25/0 + 100/0	1745.0	6.870	13
LTE BAND 66C	20MHz + 5MHz	100/0 + 25/0	1745.0	7.610	13
LTE BAND 66C	10MHz + 15MHz	50/0 + 75/0	1745.0	6.890	13
LTE BAND 66C	15MHz + 10MHz	75/0 + 50/0	1745.0	6.900	13
LTE BAND 66C	10MHz + 20MHz	50/0 + 100/0	1745.0	6.430	13
LTE BAND 66C	20MHz + 10MHz	100/0 + 50/0	1745.0	7.310	13
LTE BAND 66C	15MHz + 15MHz	75/0 + 75/0	1745.0	6.590	13
LTE BAND 66C	15MHz + 20MHz	75/0 + 100/0	1745.0	6.380	13
LTE BAND 66C	20MHz + 15MHz	100/0 + 75/0	1745.0	6.890	13
LTE BAND 66C	20MHz + 20MHz	100/0 + 100/0	1745.0	6.910	13

Unless otherwise stated the results shown in this test report refer only to the sample(s) tested and such sample(s) are retained for 90 days only.

除非另有說明，此報告結果僅對測試之樣品負責，同時此樣品僅保留90天。本報告未經本公司書面許可，不可部份複製。

This document is issued by the Company subject to its General Conditions of Service printed overleaf, available on request or accessible at <http://www.sgs.com.tw/Terms-and-Conditions> and for electronic format documents, subject to Terms and Conditions for Electronic Documents at <http://www.sgs.com.tw/Terms-and-Conditions>. Attention is drawn to the limitation of liability, indemnification and jurisdiction issues defined therein. Any holder of this document is advised that information contained hereon reflects the Company's findings at the time of its intervention only and within the limits of Client's instructions, if any. The Company's sole responsibility is to its Client and this document does not exonerate parties to a transaction from exercising all their rights and obligations under the transaction documents. This document cannot be reproduced except in full, without prior written approval of the Company. Any unauthorized alteration, forgery or falsification of the content or appearance of this document is unlawful and offenders may be prosecuted to the fullest extent of the law.

Band5\_5MHz+10MHz\_64QAM\_RB25-0+RB50-0\_CH20478+CH20550

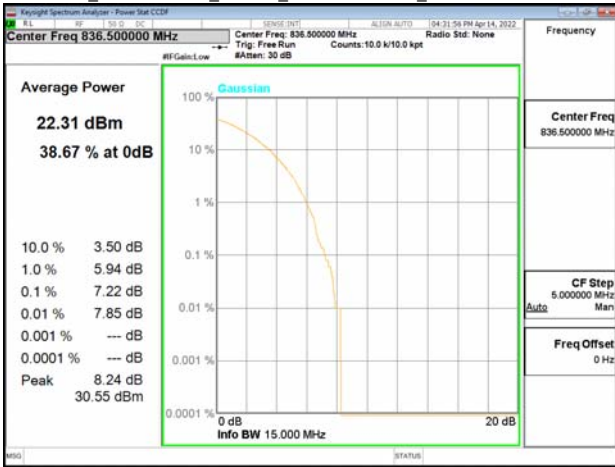

Band66\_5MHz+20MHz\_64QAM\_RB25-0+RB100-0\_CH132330+CH132447

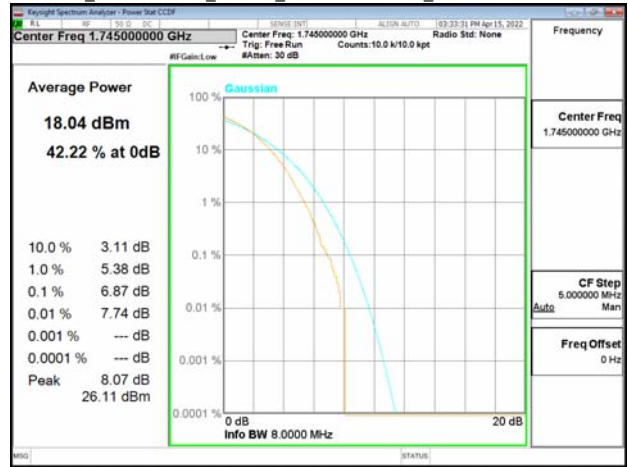

Band5\_10MHz+5MHz\_64QAM\_RB50-0+RB25-0\_CH20500+CH20572

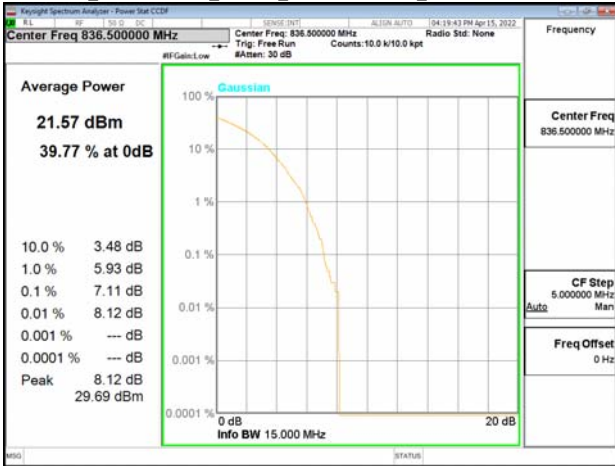

Band66\_10MHz+15MHz\_64QAM\_RB50-0+RB75-0\_CH132351+CH132471

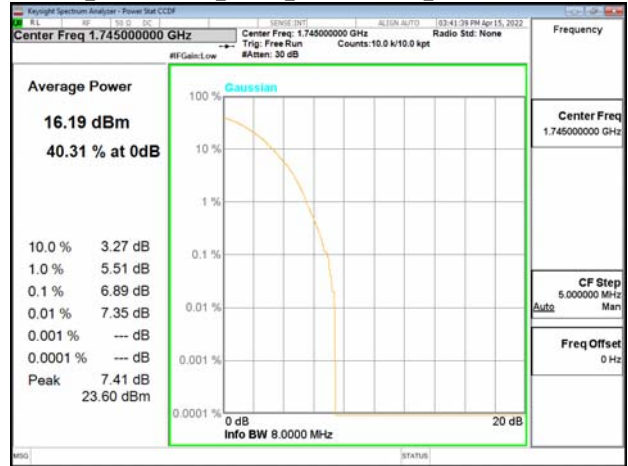

Band5\_10MHz+10MHz\_64QAM\_RB50-0+RB50-0\_CH20476+CH20575

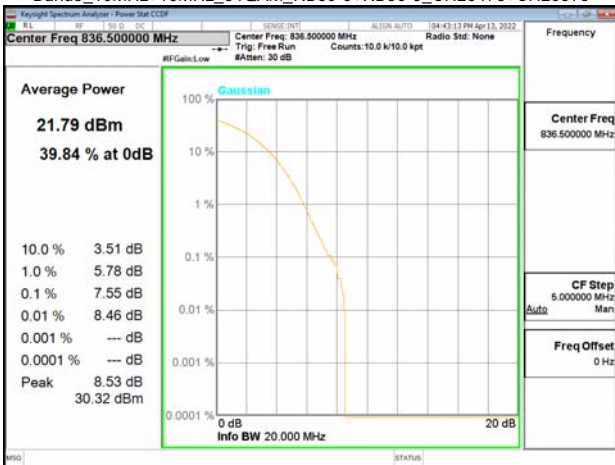

Band66\_15MHz+10MHz\_64QAM\_RB75-0+RB50-0\_CH132373+CH132493



Unless otherwise stated the results shown in this test report refer only to the sample(s) tested and such sample(s) are retained for 90 days only.

除非另有說明，此報告結果僅對測試之樣品負責，同時此樣品僅保留90天。本報告未經本公司書面許可，不可部份複製。

This document is issued by the Company subject to its General Conditions of Service printed overleaf, available on request or accessible at <http://www.sgs.com.tw/Terms-and-Conditions> and for electronic format documents, subject to Terms and Conditions for Electronic Documents at <http://www.sgs.com.tw/Terms-and-Conditions>. Attention is drawn to the limitation of liability, indemnification and jurisdiction issues defined therein. Any holder of this document is advised that information contained herein reflects the Company's findings at the time of its intervention only and within the limits of Client's instructions, if any. The Company's sole responsibility is to its Client and this document does not exonerate parties to a transaction from exercising all their rights and obligations under the transaction documents. This document cannot be reproduced except in full, without prior written approval of the Company. Any unauthorized alteration, forgery or falsification of the content or appearance of this document is unlawful and offenders may be prosecuted to the fullest extent of the law.



Band66\_20MHz+5MHz\_64QAM\_RB100-0+RB25-0\_CH132397+CH132514

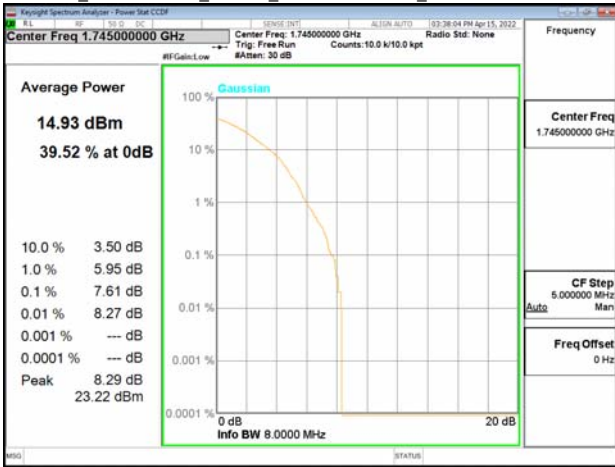

Band66\_20MHz+10MHz\_64QAM\_RB100-0+RB50-0\_CH132373+CH132517

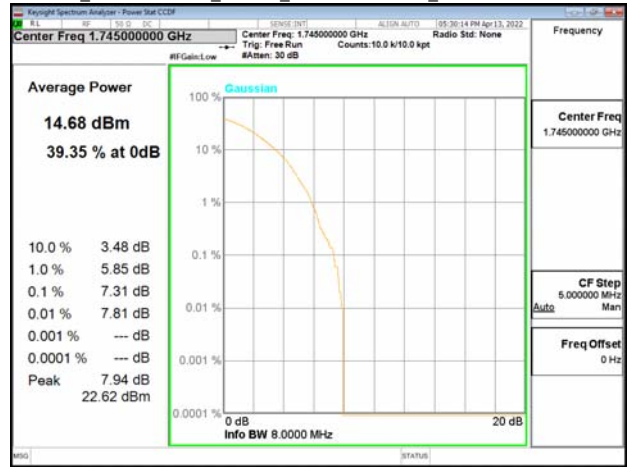

Band66\_10MHz+20MHz\_64QAM\_RB50-0+RB100-0\_CH132328+CH132472

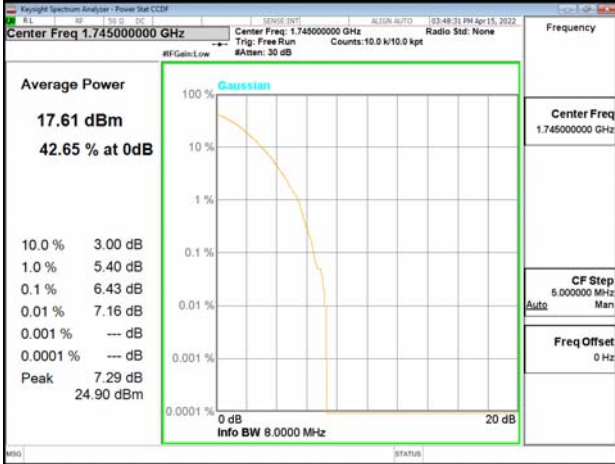

Band66\_15MHz+20MHz\_64QAM\_RB75-0+RB100-0\_CH132325+CH132496

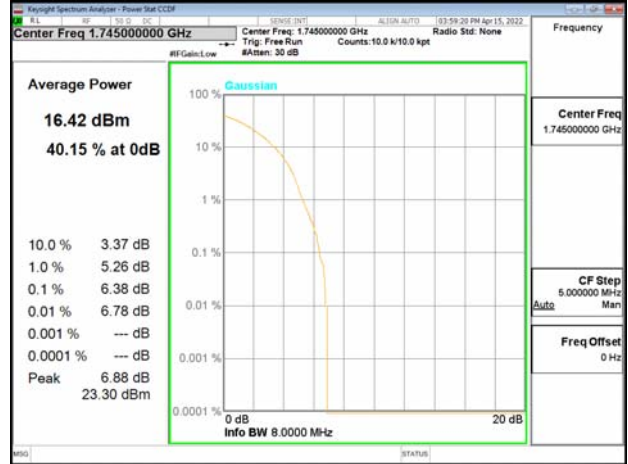

Band66\_15MHz+15MHz\_64QAM\_RB75-0+RB75-0\_CH132347+CH132497



Band66\_20MHz+15MHz\_64QAM\_RB100-0+RB75-0\_CH132348+CH132519

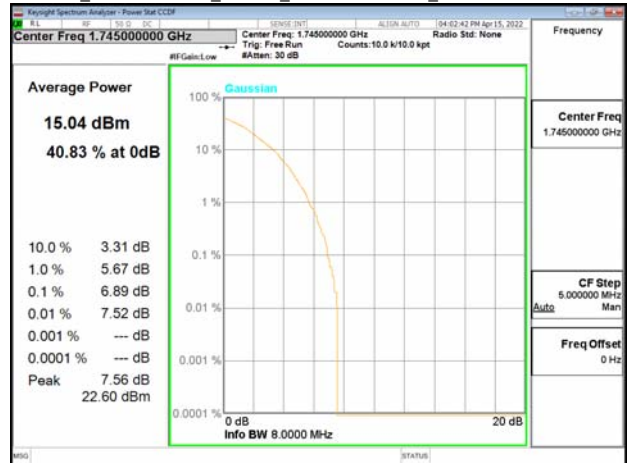

Unless otherwise stated the results shown in this test report refer only to the sample(s) tested and such sample(s) are retained for 90 days only.

除非另有說明，此報告結果僅對測試之樣品負責，同時此樣品僅保留90天。本報告未經本公司書面許可，不可部份複製。

This document is issued by the Company subject to its General Conditions of Service printed overleaf, available on request or accessible at <http://www.sgs.com.tw/Terms-and-Conditions> and for electronic format documents, subject to Terms and Conditions for Electronic Documents at <http://www.sgs.com.tw/Terms-and-Conditions>. Attention is drawn to the limitation of liability, indemnification and jurisdiction issues defined therein. Any holder of this document is advised that information contained herein reflects the Company's findings at the time of its intervention only and within the limits of Client's instructions, if any. The Company's sole responsibility is to its Client and this document does not exonerate parties to a transaction from exercising all their rights and obligations under the transaction documents. This document cannot be reproduced except in full, without prior written approval of the Company. Any unauthorized alteration, forgery or falsification of the content or appearance of this document is unlawful and offenders may be prosecuted to the fullest extent of the law.

Band66\_20MHz+20MHz\_64QAM\_RB100-0+RB100-0\_CH132323+CH132521

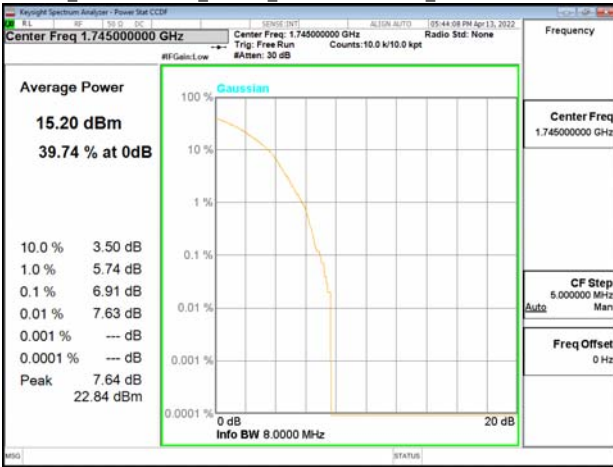

Band66B\_10MHz+5MHz\_64QAM\_RB50-0+RB25-0\_CH132397+CH132469

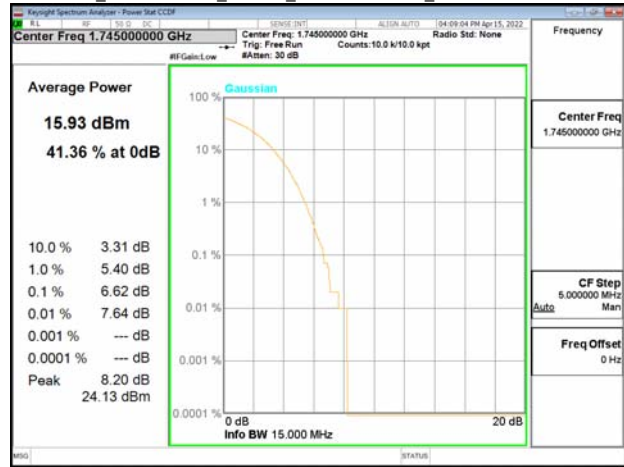

Band66B\_5MHz+5MHz\_64QAM\_RB25-0+RB25-0\_CH132398+CH132446

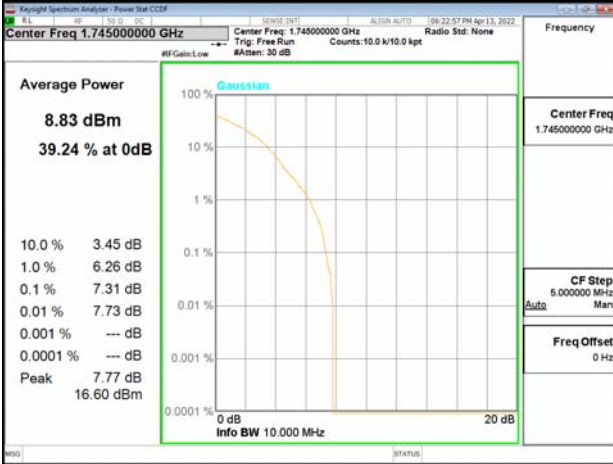

Band66B\_5MHz+15MHz\_64QAM\_RB25-0+RB75-0\_CH132353+CH132446

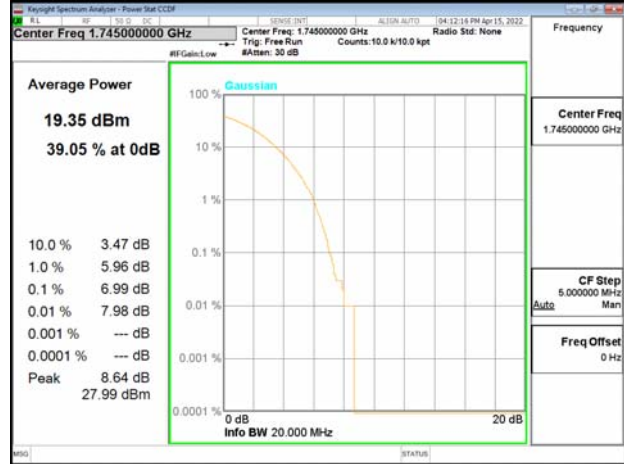

Band66B\_5MHz+10MHz\_64QAM\_RB25-0+RB50-0\_CH132375+CH132447

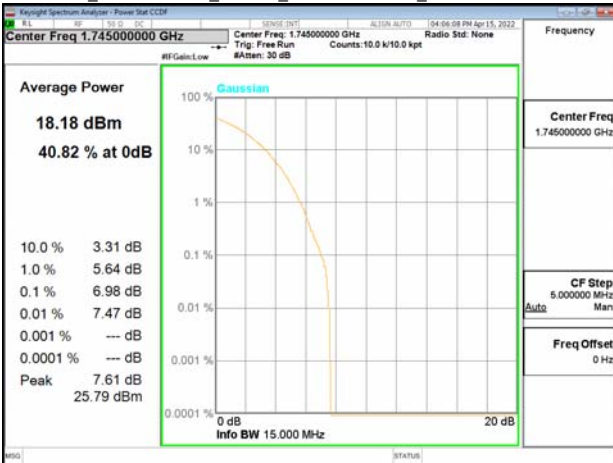

Band66B\_15MHz+5MHz\_64QAM\_RB75-0+RB25-0\_CH132398+CH132491

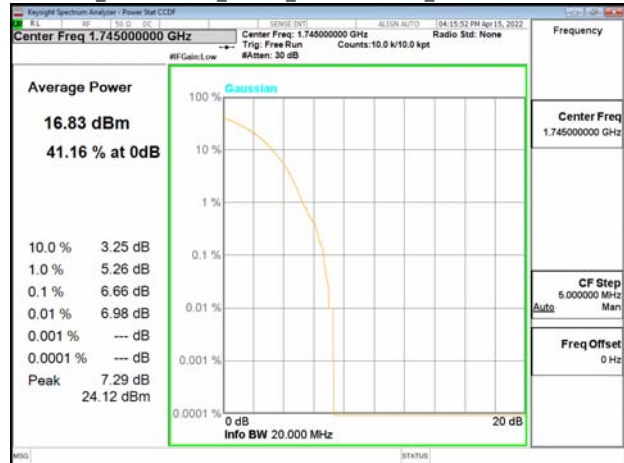

Unless otherwise stated the results shown in this test report refer only to the sample(s) tested and such sample(s) are retained for 90 days only.

除非另有說明，此報告結果僅對測試之樣品負責，同時此樣品僅保留90天。本報告未經本公司書面許可，不可部份複製。

This document is issued by the Company subject to its General Conditions of Service printed overleaf, available on request or accessible at <http://www.sgs.com.tw/Terms-and-Conditions> and for electronic format documents, subject to Terms and Conditions for Electronic Documents at <http://www.sgs.com.tw/Terms-and-Conditions>. Attention is drawn to the limitation of liability, indemnification and jurisdiction issues defined therein. Any holder of this document is advised that information contained herein reflects the Company's findings at the time of its intervention only and within the limits of Client's instructions, if any. The Company's sole responsibility is to its Client and this document does not exonerate parties to a transaction from exercising all their rights and obligations under the transaction documents. This document cannot be reproduced except in full, without prior written approval of the Company. Any unauthorized alteration, forgery or falsification of the content or appearance of this document is unlawful and offenders may be prosecuted to the fullest extent of the law.

Band66B\_10MHz+10MHz\_64QAM\_RB50-0+RB50-0\_CH132373+CH132472

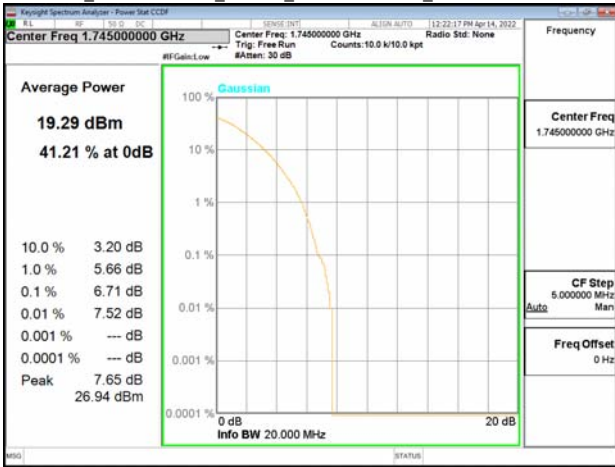

~ End of Report ~

Unless otherwise stated the results shown in this test report refer only to the sample(s) tested and such sample(s) are retained for 90 days only.

除非另有說明，此報告結果僅對測試之樣品負責，同時此樣品僅保留90天。本報告未經本公司書面許可，不可部份複製。

This document is issued by the Company subject to its General Conditions of Service printed overleaf, available on request or accessible at <http://www.sgs.com.tw/Terms-and-Conditions> and for electronic format documents, subject to Terms and Conditions for Electronic Documents at <http://www.sgs.com.tw/Terms-and-Conditions>. Attention is drawn to the limitation of liability, indemnification and jurisdiction issues defined therein. Any holder of this document is advised that information contained hereon reflects the Company's findings at the time of its intervention only and within the limits of Client's instructions, if any. The Company's sole responsibility is to its Client and this document does not exonerate parties to a transaction from exercising all their rights and obligations under the transaction documents. This document cannot be reproduced except in full, without prior written approval of the Company. Any unauthorized alteration, forgery or falsification of the content or appearance of this document is unlawful and offenders may be prosecuted to the fullest extent of the law.