

Band77-Part27\_40MHz\_CP\_OFDM\_SCS30kHz\_OPSK\_RB106\_0\_CH664000

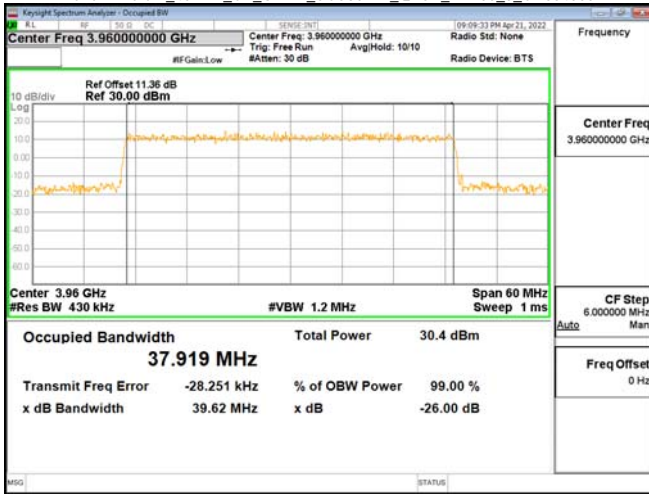

Band77-Part27\_40MHz\_CP\_OFDM\_SCS30kHz\_16QAM\_RB106\_0\_CH664000

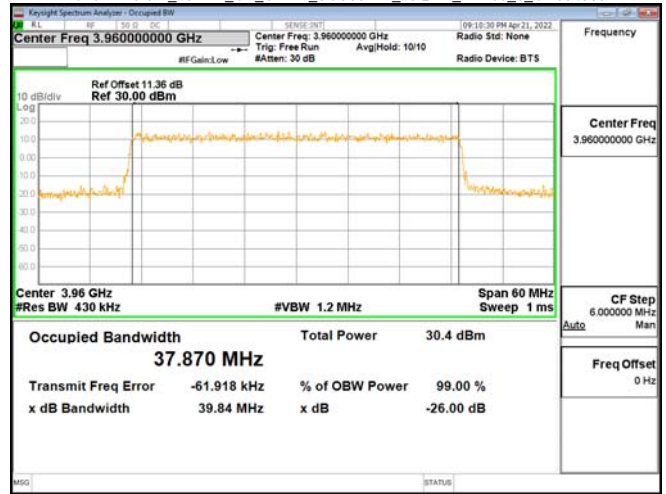

Band77-Part27\_40MHz\_CP\_OFDM\_SCS30kHz\_16QAM\_RB106\_0\_CH648000

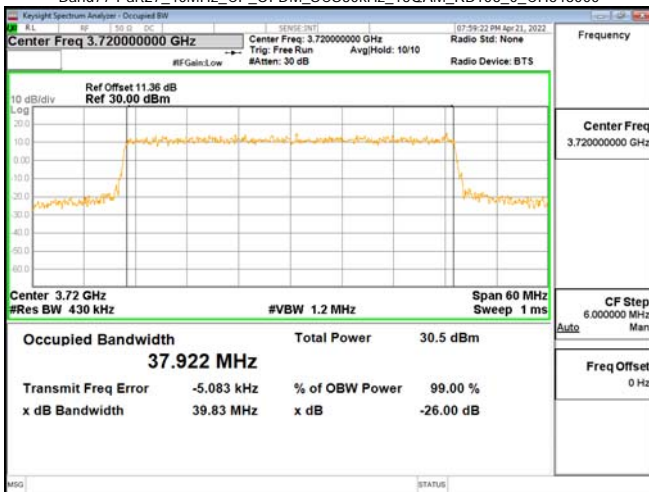

Band77-Part27\_40MHz\_CP\_OFDM\_SCS30kHz\_64QAM\_RB106\_0\_CH648000

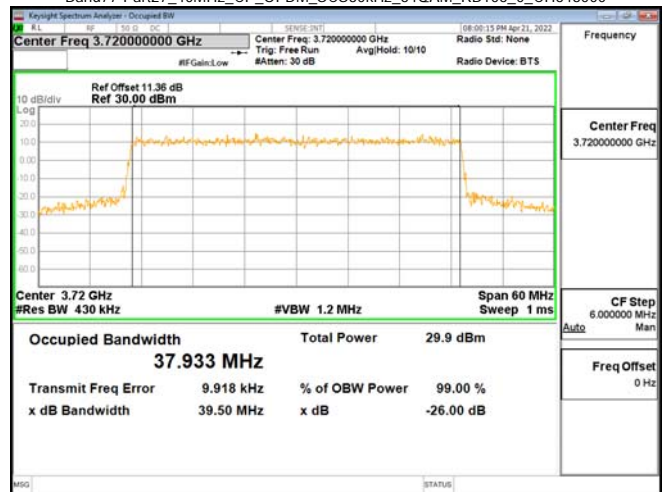

Band77-Part27\_40MHz\_CP\_OFDM\_SCS30kHz\_16QAM\_RB106\_0\_CH656000

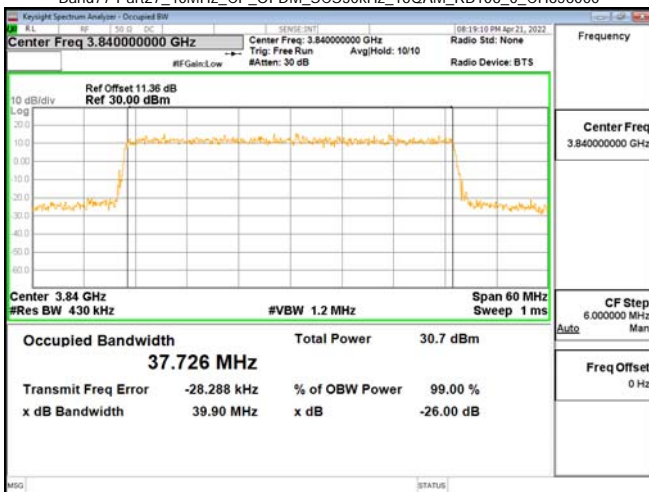

Band77-Part27\_40MHz\_CP\_OFDM\_SCS30kHz\_64QAM\_RB106\_0\_CH656000

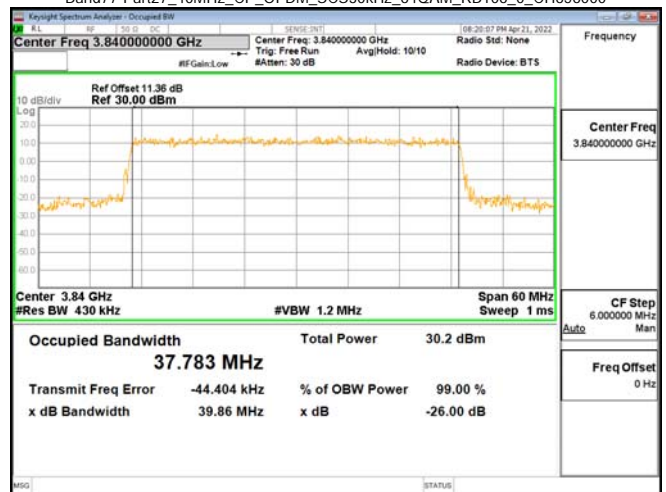

Unless otherwise stated the results shown in this test report refer only to the sample(s) tested and such sample(s) are retained for 90 days only.

除非另有說明，此報告結果僅對測試之樣品負責，同時此樣品僅保留90天。本報告未經本公司書面許可，不可部份複製。

This document is issued by the Company subject to its General Conditions of Service printed overleaf, available on request or accessible at <http://www.sgs.com.tw/Terms-and-Conditions> and for electronic format documents, subject to Terms and Conditions for Electronic Documents at <http://www.sgs.com.tw/Terms-and-Conditions>. Attention is drawn to the limitation of liability, indemnification and jurisdiction issues defined therein. Any holder of this document is advised that information contained herein reflects the Company's findings at the time of its intervention only and within the limits of Client's instructions, if any. The Company's sole responsibility is to its Client and this document does not exonerate parties to a transaction from exercising all their rights and obligations under the transaction documents. This document cannot be reproduced except in full, without prior written approval of the Company. Any unauthorized alteration, forgery or falsification of the content or appearance of this document is unlawful and offenders may be prosecuted to the fullest extent of the law.

Band77-Part27\_40MHz\_CP\_OFDM\_SCS30kHz\_64QAM\_RB106\_0\_CH664000

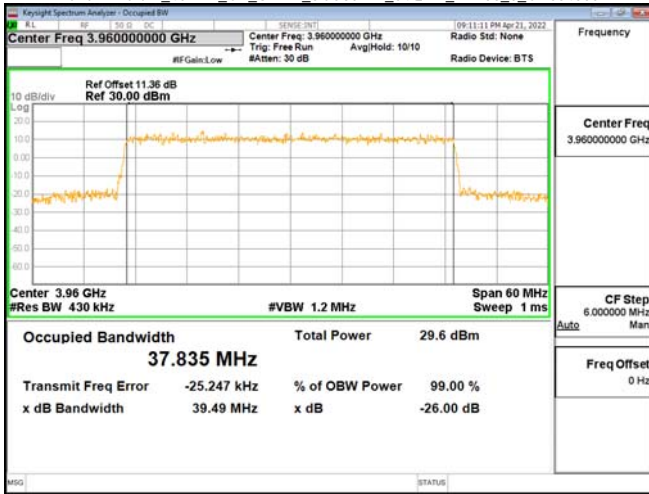

Band77-Part27\_40MHz\_CP\_OFDM\_SCS30kHz\_256QAM\_RB106\_0\_CH664000

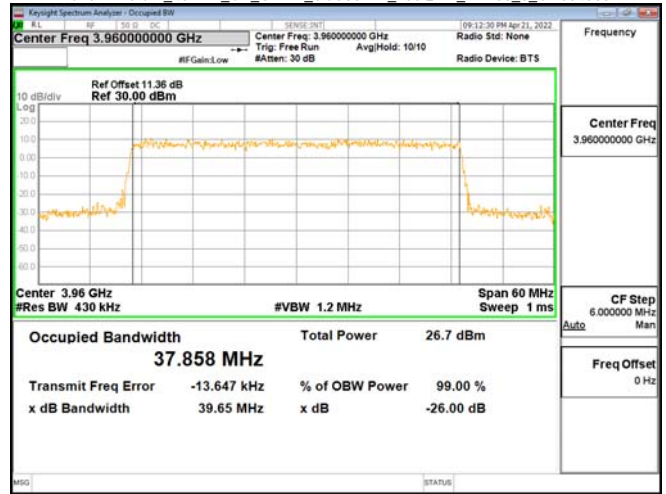

Band77-Part27\_40MHz\_CP\_OFDM\_SCS30kHz\_256QAM\_RB106\_0\_CH648000

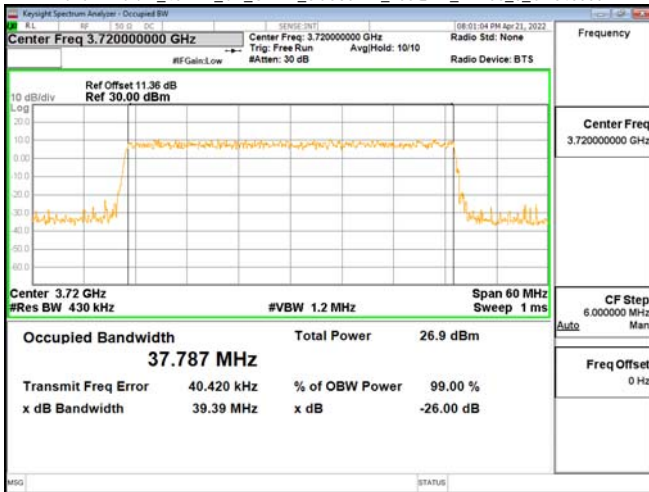

Band77-Part27\_60MHz\_CP\_OFDM\_SCS30kHz\_OPSK\_RB162\_0\_CH648668

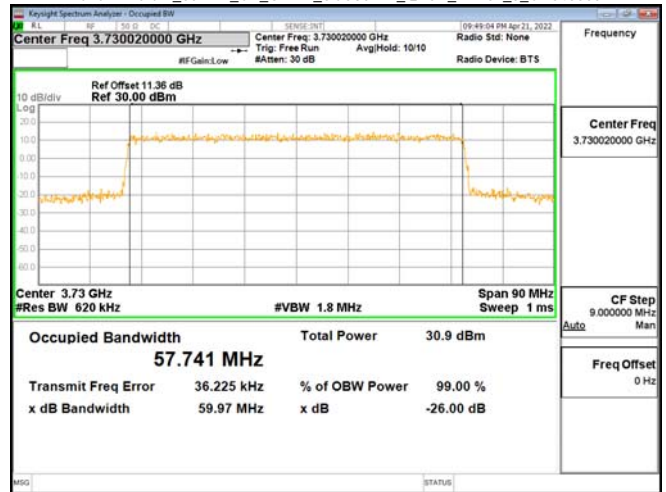

Band77-Part27\_40MHz\_CP\_OFDM\_SCS30kHz\_256QAM\_RB106\_0\_CH656000

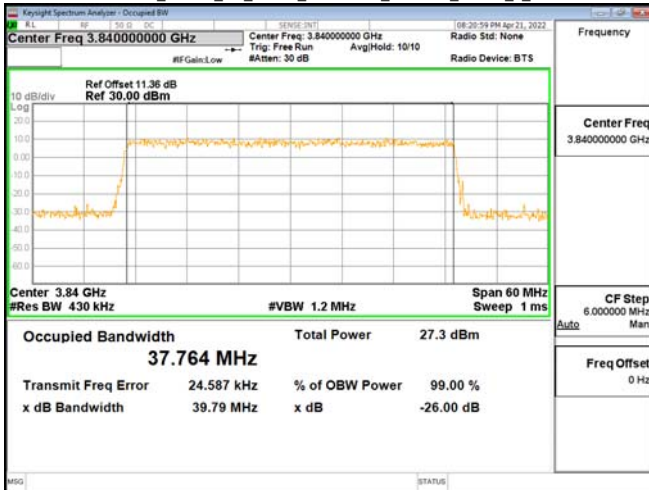

Band77-Part27\_60MHz\_CP\_OFDM\_SCS30kHz\_OPSK\_RB162\_0\_CH656000

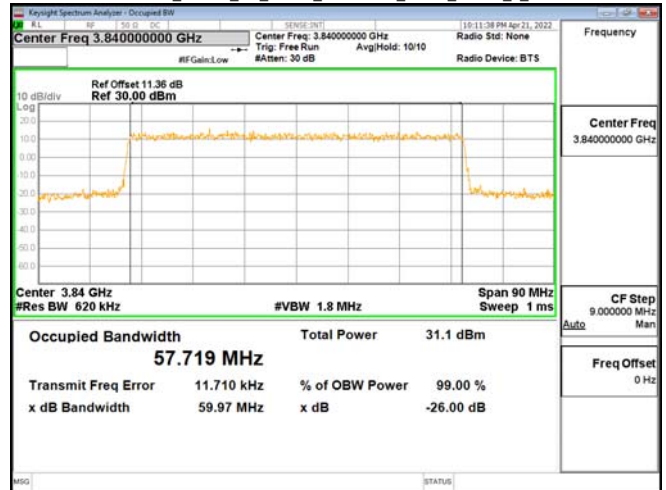

Unless otherwise stated the results shown in this test report refer only to the sample(s) tested and such sample(s) are retained for 90 days only.

除非另有說明，此報告結果僅對測試之樣品負責，同時此樣品僅保留90天。本報告未經本公司書面許可，不可部份複製。

This document is issued by the Company subject to its General Conditions of Service printed overleaf, available on request or accessible at <http://www.sgs.com.tw/Terms-and-Conditions> and for electronic format documents, subject to Terms and Conditions for Electronic Documents at <http://www.sgs.com.tw/Terms-and-Conditions>. Attention is drawn to the limitation of liability, indemnification and jurisdiction issues defined therein. Any holder of this document is advised that information contained herein reflects the Company's findings at the time of its intervention only and within the limits of Client's instructions, if any. The Company's sole responsibility is to its Client and this document does not exonerate parties to a transaction from exercising all their rights and obligations under the transaction documents. This document cannot be reproduced except in full, without prior written approval of the Company. Any unauthorized alteration, forgery or falsification of the content or appearance of this document is unlawful and offenders may be prosecuted to the fullest extent of the law.

Band77-Part27\_60MHz\_CP\_OFDM\_SCS30kHz\_OPSK\_RB162\_0\_CH663332

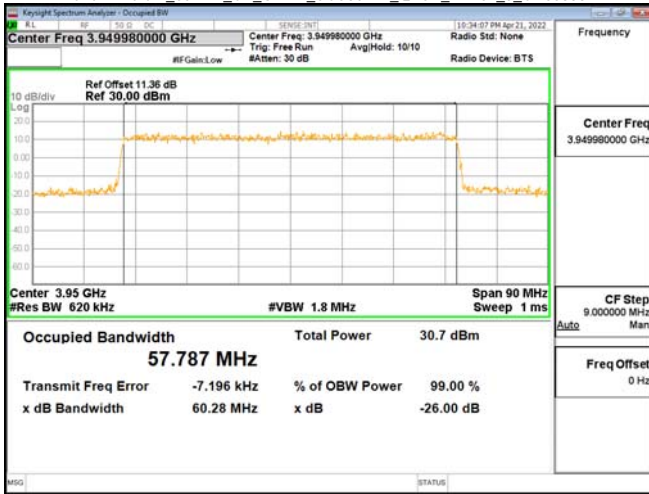

Band77-Part27\_60MHz\_CP\_OFDM\_SCS30kHz\_16QAM\_RB162\_0\_CH663332

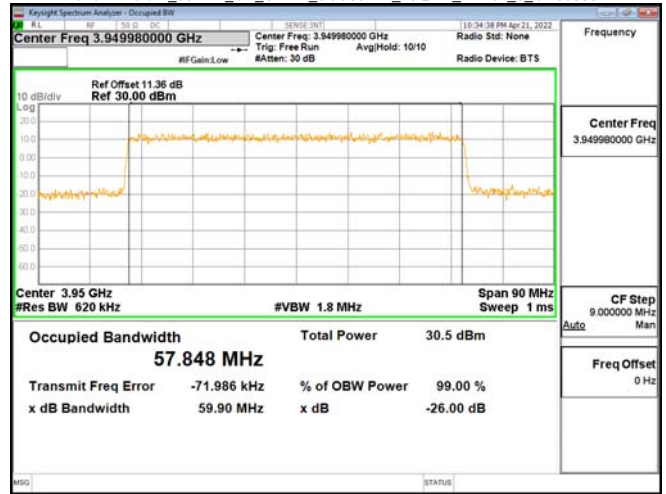

Band77-Part27\_60MHz\_CP\_OFDM\_SCS30kHz\_16QAM\_RB162\_0\_CH648668

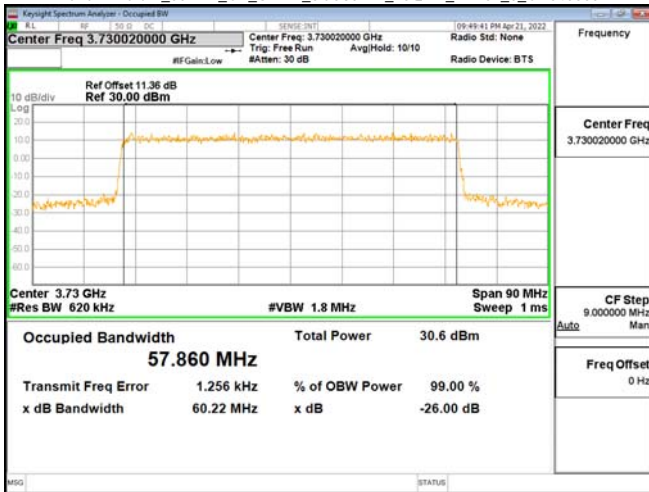

Band77-Part27\_60MHz\_CP\_OFDM\_SCS30kHz\_64QAM\_RB162\_0\_CH648668

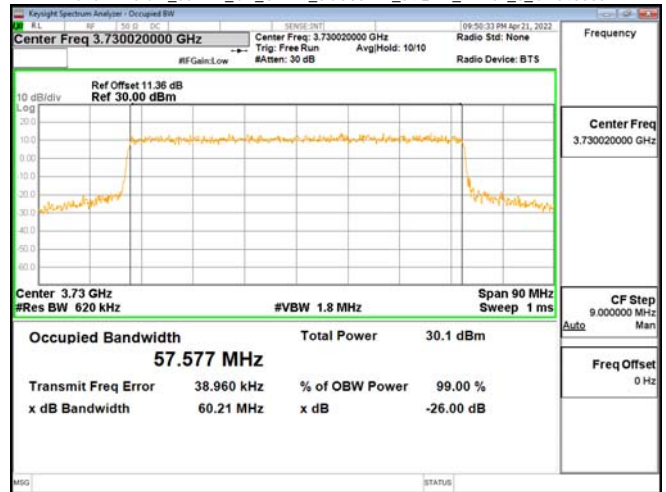

Band77-Part27\_60MHz\_CP\_OFDM\_SCS30kHz\_16QAM\_RB162\_0\_CH656000

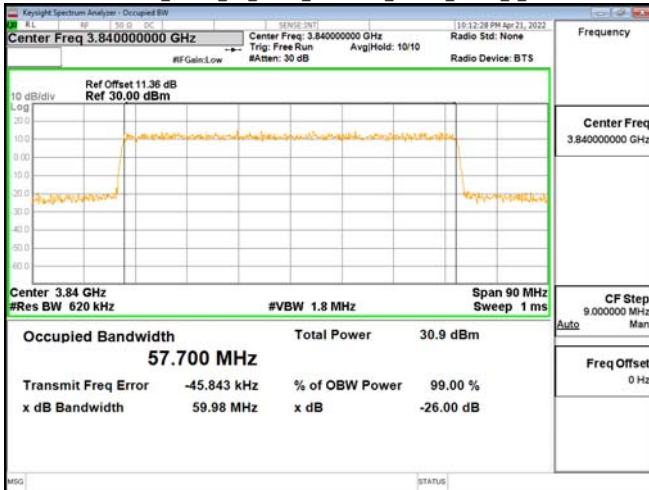

Band77-Part27\_60MHz\_CP\_OFDM\_SCS30kHz\_64QAM\_RB162\_0\_CH656000

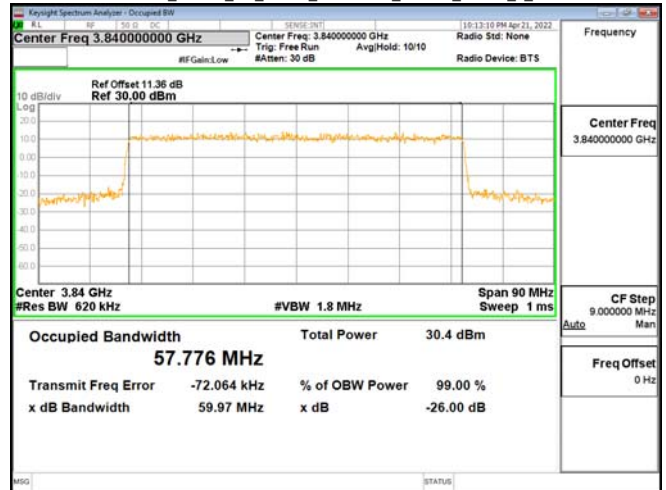

Unless otherwise stated the results shown in this test report refer only to the sample(s) tested and such sample(s) are retained for 90 days only.

除非另有說明，此報告結果僅對測試之樣品負責，同時此樣品僅保留90天。本報告未經本公司書面許可，不可部份複製。

This document is issued by the Company subject to its General Conditions of Service printed overleaf, available on request or accessible at <http://www.sgs.com.tw/Terms-and-Conditions> and for electronic format documents, subject to Terms and Conditions for Electronic Documents at <http://www.sgs.com.tw/Terms-and-Conditions>. Attention is drawn to the limitation of liability, indemnification and jurisdiction issues defined therein. Any holder of this document is advised that information contained herein reflects the Company's findings at the time of its intervention only and within the limits of Client's instructions, if any. The Company's sole responsibility is to its Client and this document does not exonerate parties to a transaction from exercising all their rights and obligations under the transaction documents. This document cannot be reproduced except in full, without prior written approval of the Company. Any unauthorized alteration, forgery or falsification of the content or appearance of this document is unlawful and offenders may be prosecuted to the fullest extent of the law.

Band77-Part27\_60MHz\_CP\_OFDM\_SCS30kHz\_64QAM\_RB162\_0\_CH663332

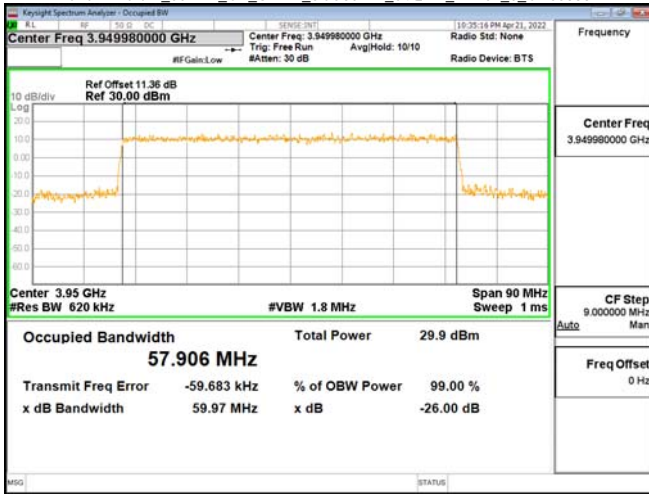

Band77-Part27\_60MHz\_CP\_OFDM\_SCS30kHz\_256QAM\_RB162\_0\_CH663332

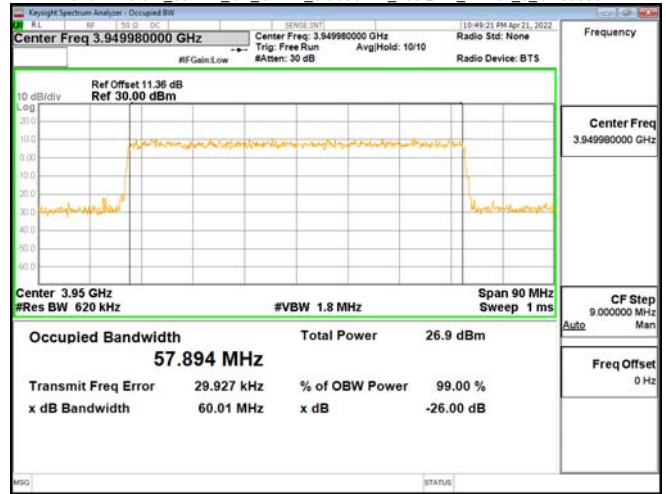

Band77-Part27\_60MHz\_CP\_OFDM\_SCS30kHz\_256QAM\_RB162\_0\_CH648668

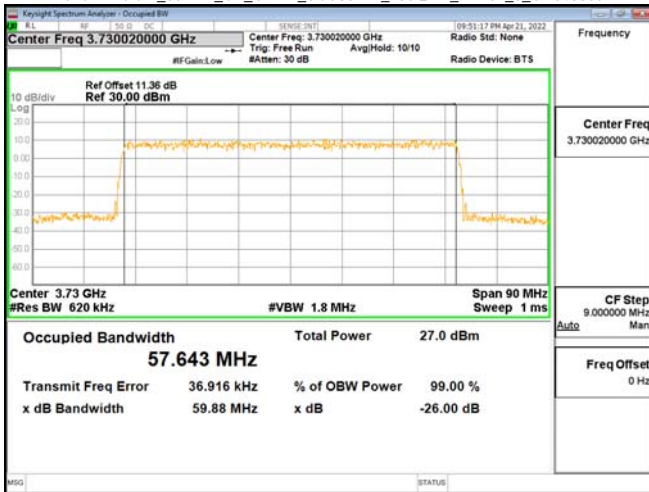

Band77-Part27\_80MHz\_CP\_OFDM\_SCS30kHz\_QPSK\_RB217\_0\_CH649334

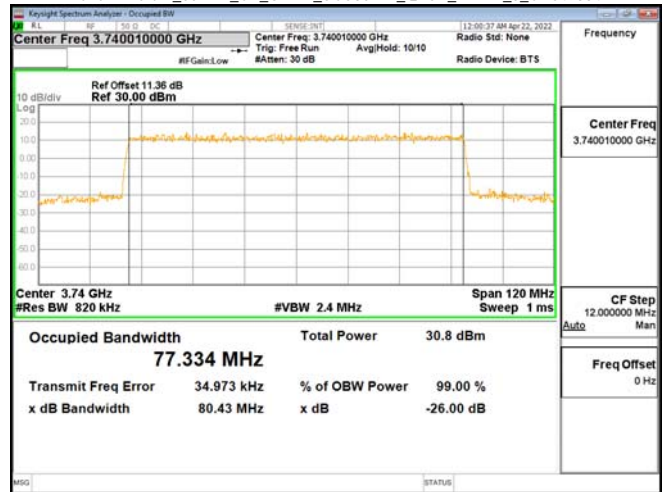

Band77-Part27\_60MHz\_CP\_OFDM\_SCS30kHz\_256QAM\_RB162\_0\_CH656000

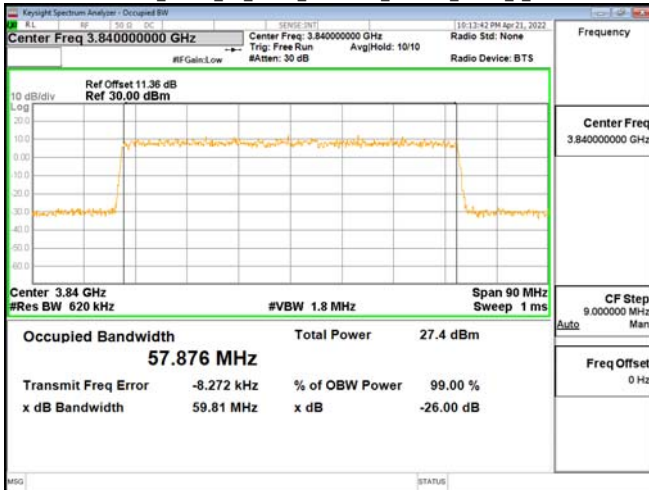

Band77-Part27\_80MHz\_CP\_OFDM\_SCS30kHz\_QPSK\_RB217\_0\_CH656000

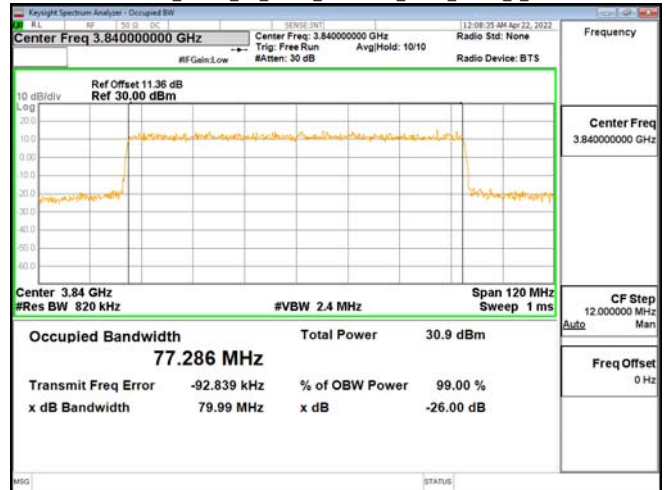

Unless otherwise stated the results shown in this test report refer only to the sample(s) tested and such sample(s) are retained for 90 days only.

除非另有說明，此報告結果僅對測試之樣品負責，同時此樣品僅保留90天。本報告未經本公司書面許可，不可部份複製。

This document is issued by the Company subject to its General Conditions of Service printed overleaf, available on request or accessible at <http://www.sgs.com.tw/Terms-and-Conditions> and for electronic format documents, subject to Terms and Conditions for Electronic Documents at <http://www.sgs.com.tw/Terms-and-Conditions>. Attention is drawn to the limitation of liability, indemnification and jurisdiction issues defined therein. Any holder of this document is advised that information contained herein reflects the Company's findings at the time of its intervention only and within the limits of Client's instructions, if any. The Company's sole responsibility is to its Client and this document does not exonerate parties to a transaction from exercising all their rights and obligations under the transaction documents. This document cannot be reproduced except in full, without prior written approval of the Company. Any unauthorized alteration, forgery or falsification of the content or appearance of this document is unlawful and offenders may be prosecuted to the fullest extent of the law.

Band77-Part27\_80MHz\_CP\_OFDM\_SCS30kHz\_OPSK\_RB217\_0\_CH662666

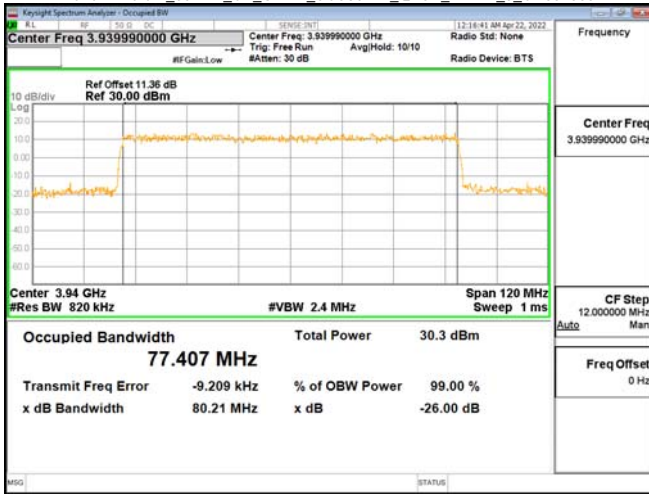

Band77-Part27\_80MHz\_CP\_OFDM\_SCS30kHz\_16QAM\_RB217\_0\_CH662666

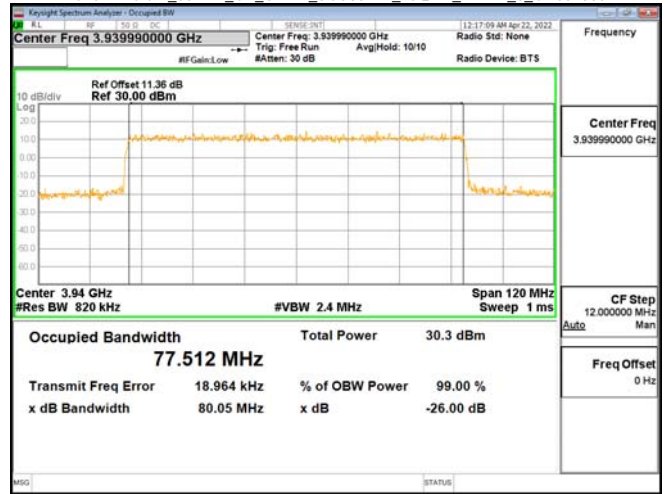

Band77-Part27\_80MHz\_CP\_OFDM\_SCS30kHz\_16QAM\_RB217\_0\_CH649334

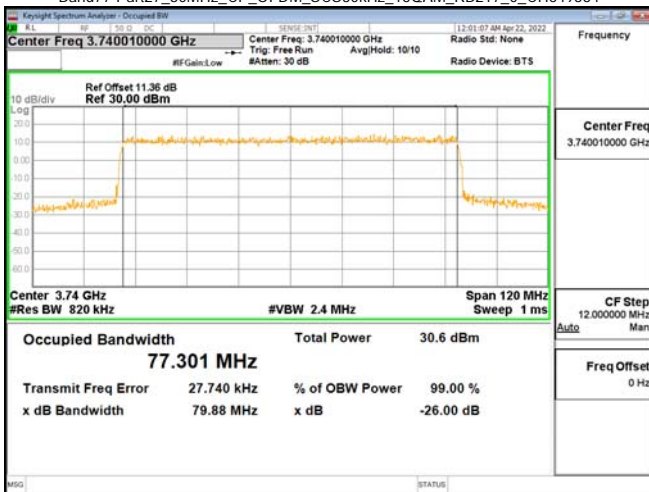

Band77-Part27\_80MHz\_CP\_OFDM\_SCS30kHz\_64QAM\_RB217\_0\_CH649334

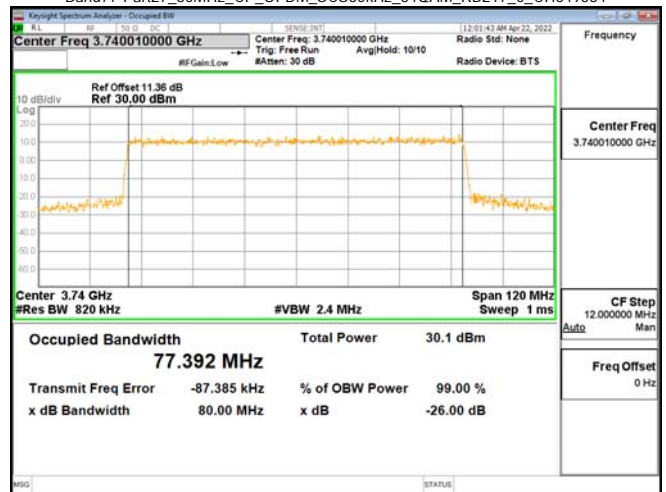

Band77-Part27\_80MHz\_CP\_OFDM\_SCS30kHz\_16QAM\_RB217\_0\_CH656000

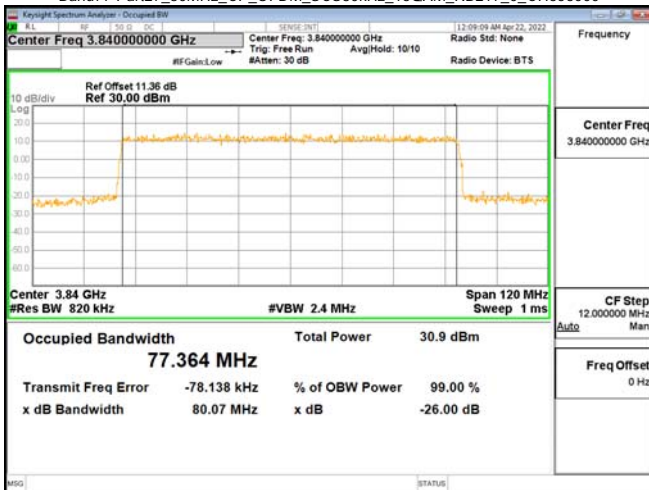

Band77-Part27\_80MHz\_CP\_OFDM\_SCS30kHz\_64QAM\_RB217\_0\_CH656000

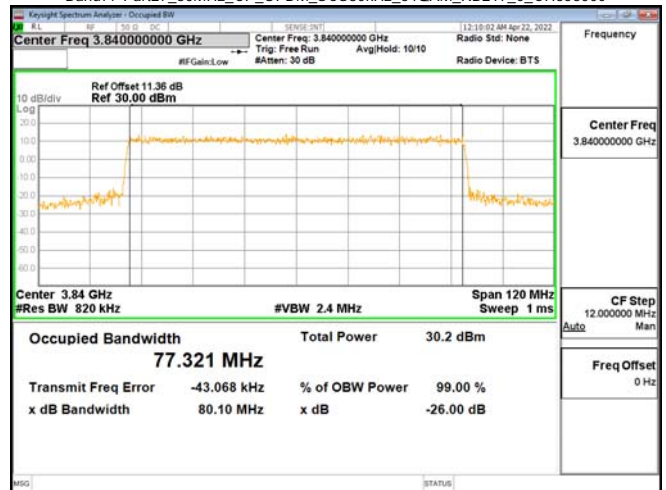

Unless otherwise stated the results shown in this test report refer only to the sample(s) tested and such sample(s) are retained for 90 days only.

除非另有說明，此報告結果僅對測試之樣品負責，同時此樣品僅保留90天。本報告未經本公司書面許可，不可部份複製。

This document is issued by the Company subject to its General Conditions of Service printed overleaf, available on request or accessible at <http://www.sgs.com.tw/Terms-and-Conditions> and for electronic format documents, subject to Terms and Conditions for Electronic Documents at <http://www.sgs.com.tw/Terms-and-Conditions>. Attention is drawn to the limitation of liability, indemnification and jurisdiction issues defined therein. Any holder of this document is advised that information contained herein reflects the Company's findings at the time of its intervention only and within the limits of Client's instructions, if any. The Company's sole responsibility is to its Client and this document does not exonerate parties to a transaction from exercising all their rights and obligations under the transaction documents. This document cannot be reproduced except in full, without prior written approval of the Company. Any unauthorized alteration, forgery or falsification of the content or appearance of this document is unlawful and offenders may be prosecuted to the fullest extent of the law.

Band77-Part27\_80MHz\_CP\_OFDM\_SCS30kHz\_64QAM\_RB217\_0\_CH662666

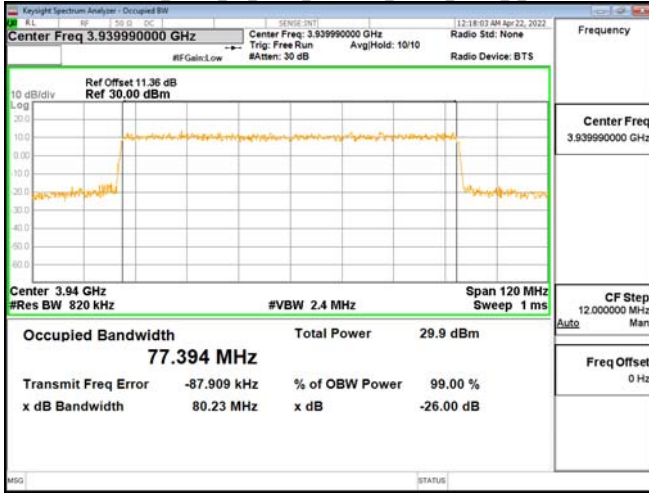

Band77-Part27\_80MHz\_CP\_OFDM\_SCS30kHz\_256QAM\_RB217\_0\_CH662666

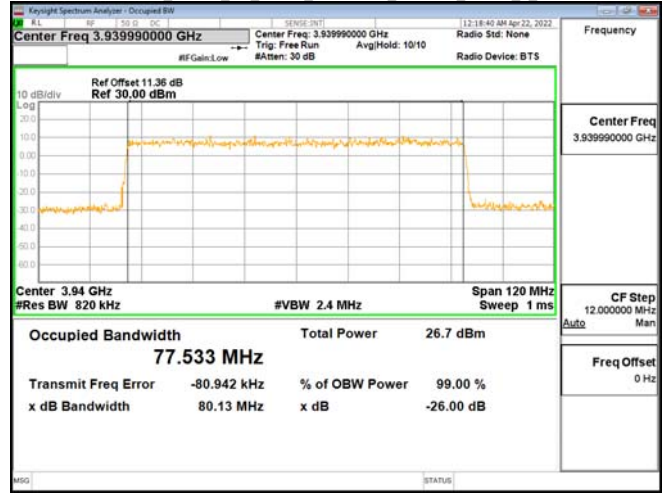

Band77-Part27\_80MHz\_CP\_OFDM\_SCS30kHz\_256QAM\_RB217\_0\_CH649334

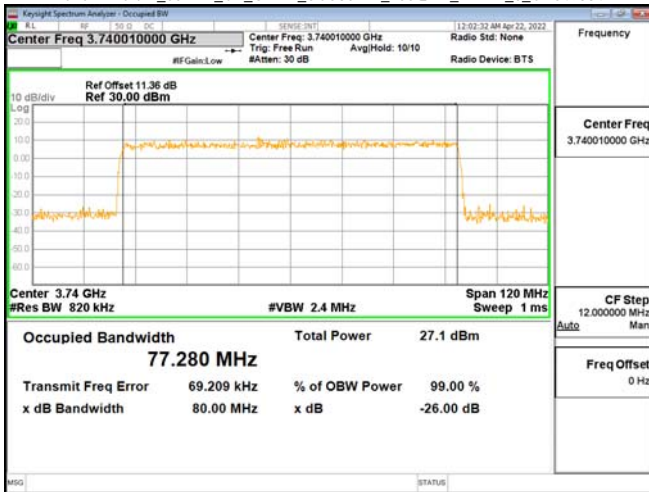

Band77-Part27\_100MHz\_CP\_OFDM\_SCS30kHz\_QPSK\_RB273\_0\_CH650000

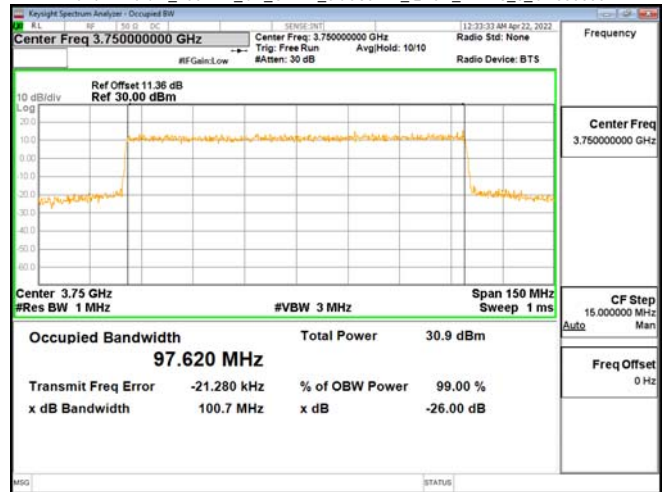

Band77-Part27\_80MHz\_CP\_OFDM\_SCS30kHz\_256QAM\_RB217\_0\_CH656000

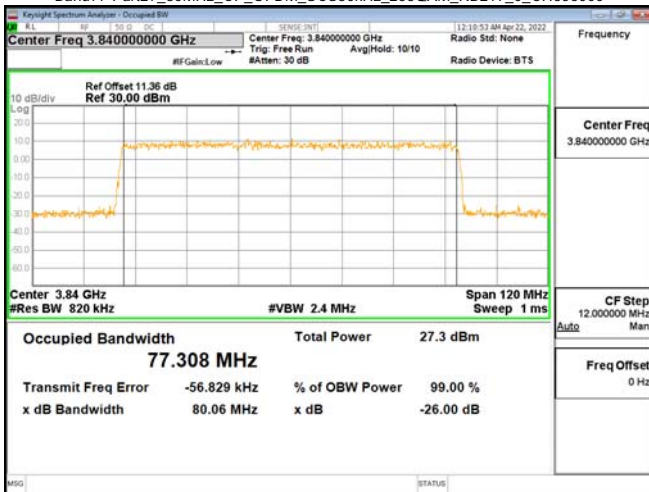

Band77-Part27\_100MHz\_CP\_OFDM\_SCS30kHz\_QPSK\_RB273\_0\_CH656000

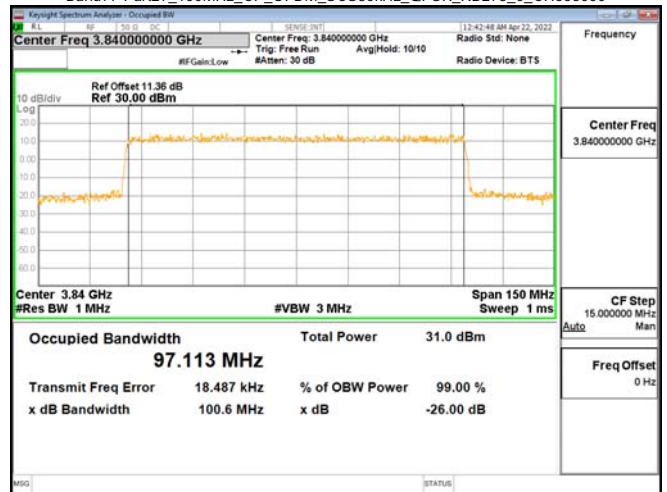

Unless otherwise stated the results shown in this test report refer only to the sample(s) tested and such sample(s) are retained for 90 days only.

除非另有說明，此報告結果僅對測試之樣品負責，同時此樣品僅保留90天。本報告未經本公司書面許可，不可部份複製。

This document is issued by the Company subject to its General Conditions of Service printed overleaf, available on request or accessible at <http://www.sgs.com.tw/Terms-and-Conditions> and for electronic format documents, subject to Terms and Conditions for Electronic Documents at <http://www.sgs.com.tw/Terms-and-Conditions>. Attention is drawn to the limitation of liability, indemnification and jurisdiction issues defined therein. Any holder of this document is advised that information contained herein reflects the Company's findings at the time of its intervention only and within the limits of Client's instructions, if any. The Company's sole responsibility is to its Client and this document does not exonerate parties to a transaction from exercising all their rights and obligations under the transaction documents. This document cannot be reproduced except in full, without prior written approval of the Company. Any unauthorized alteration, forgery or falsification of the content or appearance of this document is unlawful and offenders may be prosecuted to the fullest extent of the law.

Band77-Part27\_100MHz\_CP\_OFDM\_SCS30kHz\_QPSK\_RB273\_0\_CH662000

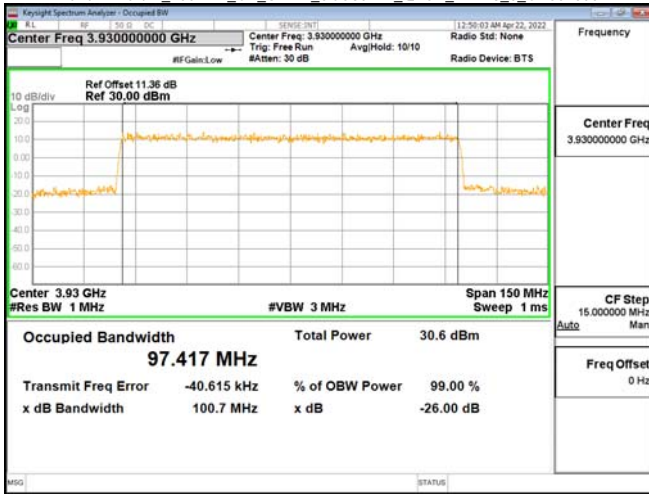

Band77-Part27\_100MHz\_CP\_OFDM\_SCS30kHz\_16QAM\_RB273\_0\_CH662000

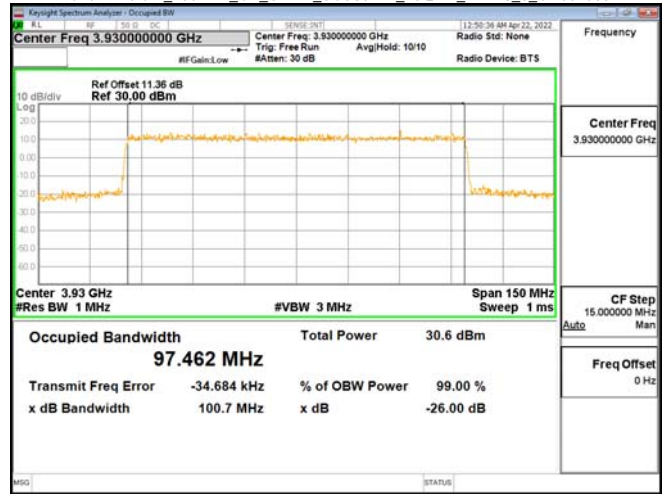

Band77-Part27\_100MHz\_CP\_OFDM\_SCS30kHz\_16QAM\_RB273\_0\_CH650000

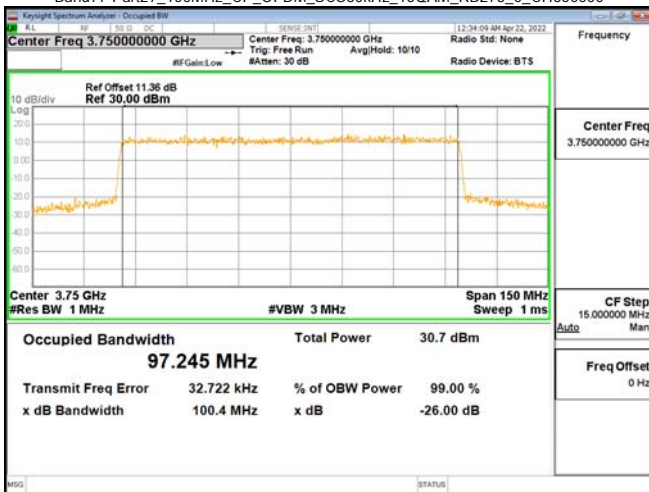

Band77-Part27\_100MHz\_CP\_OFDM\_SCS30kHz\_64QAM\_RB273\_0\_CH650000

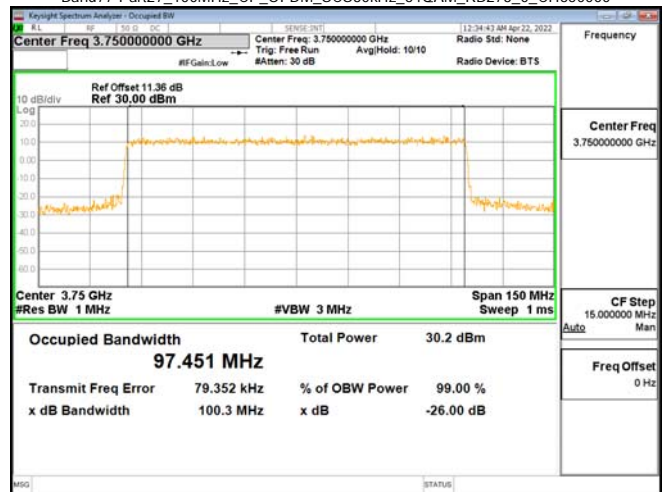

Band77-Part27\_100MHz\_CP\_OFDM\_SCS30kHz\_16QAM\_RB273\_0\_CH656000

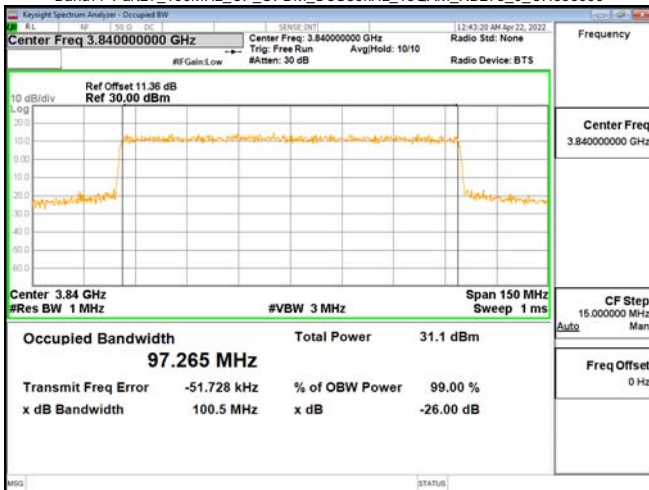

Band77-Part27\_100MHz\_CP\_OFDM\_SCS30kHz\_64QAM\_RB273\_0\_CH656000

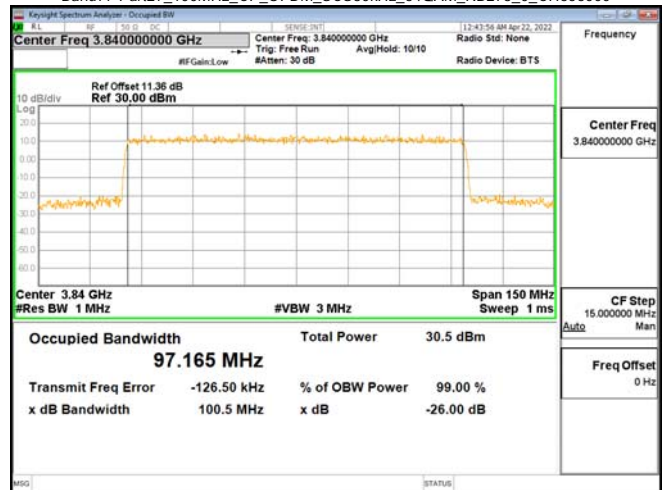

Unless otherwise stated the results shown in this test report refer only to the sample(s) tested and such sample(s) are retained for 90 days only.

除非另有說明，此報告結果僅對測試之樣品負責，同時此樣品僅保留90天。本報告未經本公司書面許可，不可部份複製。

This document is issued by the Company subject to its General Conditions of Service printed overleaf, available on request or accessible at <http://www.sgs.com.tw/Terms-and-Conditions> and for electronic format documents, subject to Terms and Conditions for Electronic Documents at <http://www.sgs.com.tw/Terms-and-Conditions>. Attention is drawn to the limitation of liability, indemnification and jurisdiction issues defined therein. Any holder of this document is advised that information contained herein reflects the Company's findings at the time of its intervention only and within the limits of Client's instructions, if any. The Company's sole responsibility is to its Client and this document does not exonerate parties to a transaction from exercising all their rights and obligations under the transaction documents. This document cannot be reproduced except in full, without prior written approval of the Company. Any unauthorized alteration, forgery or falsification of the content or appearance of this document is unlawful and offenders may be prosecuted to the fullest extent of the law.

Band77-Part27\_100MHz\_CP\_OFDM\_SCS30kHz\_64QAM\_RB273\_0\_CH662000

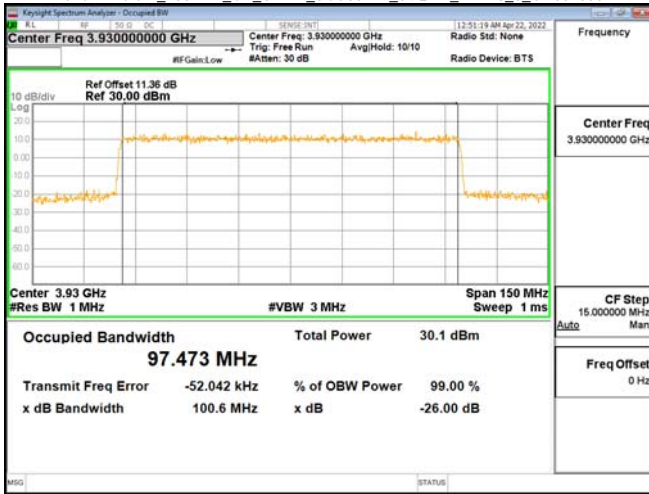

Band77-Part27\_100MHz\_CP\_OFDM\_SCS30kHz\_256QAM\_RB273\_0\_CH662000

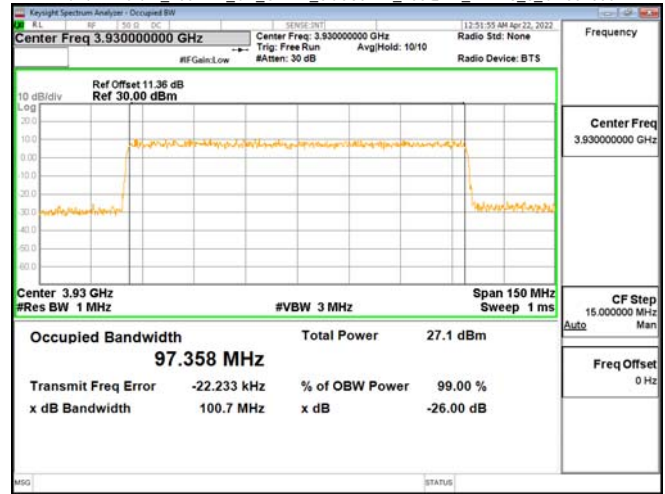

Band77-Part27\_100MHz\_CP\_OFDM\_SCS30kHz\_256QAM\_RB273\_0\_CH650000

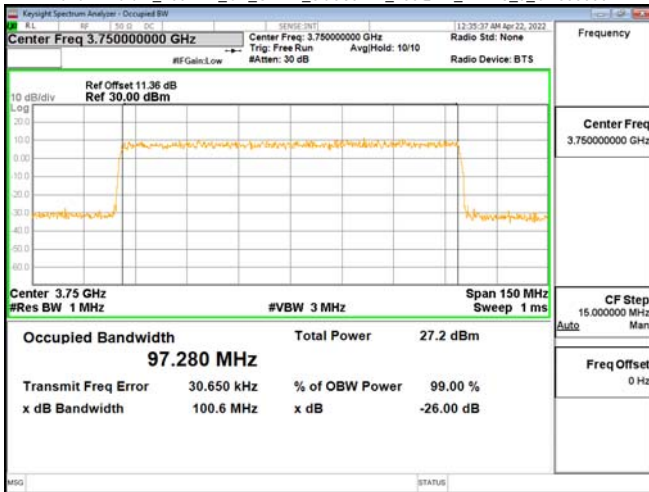

Band77-Part27\_100MHz\_CP\_OFDM\_SCS30kHz\_256QAM\_RB273\_0\_CH656000



Unless otherwise stated the results shown in this test report refer only to the sample(s) tested and such sample(s) are retained for 90 days only.

除非另有說明，此報告結果僅對測試之樣品負責，同時此樣品僅保留90天。本報告未經本公司書面許可，不可部份複製。

This document is issued by the Company subject to its General Conditions of Service printed overleaf, available on request or accessible at <http://www.sgs.com.tw/Terms-and-Conditions> and for electronic format documents, subject to Terms and Conditions for Electronic Documents at <http://www.sgs.com.tw/Terms-and-Conditions>. Attention is drawn to the limitation of liability, indemnification and jurisdiction issues defined therein. Any holder of this document is advised that information contained hereon reflects the Company's findings at the time of its intervention only and within the limits of Client's instructions, if any. The Company's sole responsibility is to its Client and this document does not exonerate parties to a transaction from exercising all their rights and obligations under the transaction documents. This document cannot be reproduced except in full, without prior written approval of the Company. Any unauthorized alteration, forgery or falsification of the content or appearance of this document is unlawful and offenders may be prosecuted to the fullest extent of the law.



## 9 OUT OF BAND EMISSION AT ANTENNA TERMINALS

### 9.1 Standard Applicable

#### FCC §22.917(a), §24.238(a), §27.53(h)

Out of band emissions. The power of any emission outside of the authorized operating frequency ranges must be attenuated below the transmitting power (P) by a factor of at least  $43 + 10 \log(P)$  dB.

#### FCC §27.53(h)

(h) *AWS emission limits*—(1) *General protection levels*. Except as otherwise specified below, for operations in the 1695-1710 MHz, 1710-1755 MHz, 1755-1780 MHz, 1915-1920 MHz, 1995-2000 MHz, 2000-2020 MHz, 2110-2155 MHz, 2155-2180 MHz, and 2180-2200 bands, the power of any emission outside a licensee's frequency block shall be attenuated below the transmitter power (P) in watts by at least  $43 + 10 \log_{10}(P)$  dB.

#### FCC §27.53(l)

(2) For mobile operations in the 3700-3980 MHz band, the conducted power of any emission outside the licensee's authorized bandwidth shall not exceed  $-13$  dBm/MHz. Compliance with this paragraph (l)(2) is based on the use of measurement instrumentation employing a resolution bandwidth of 1 megahertz or greater. However, in the 1 megahertz bands immediately outside and adjacent to the licensee's frequency block, the minimum resolution bandwidth for the measurement shall be either one percent of the emission bandwidth of the fundamental emission of the transmitter or 350 kHz. In the bands between 1 and 5 MHz removed from the licensee's frequency block, the minimum resolution bandwidth for the measurement shall be 500 kHz. The emission bandwidth is defined as the width of the signal between two points, one below the carrier center frequency and one above the carrier center frequency, outside of which all emissions are attenuated at least 26 dB below the transmitter power.

#### FCC §27.53(n)

(2) For mobile operations in the 3450-3550 MHz band, the conducted power of any emission outside the licensee's authorized bandwidth shall not exceed  $-13$  dBm/MHz. Compliance with this paragraph (n)(2) is based on the use of measurement instrumentation employing a resolution bandwidth of 1 megahertz or greater. However, in the 1 megahertz bands immediately outside and adjacent to the licensee's frequency block, a resolution bandwidth of at least one percent of the emission bandwidth of the fundamental emission of the transmitter may be employed, but limited to a maximum of 200 kHz. In the bands between 1 and 5 MHz removed from the licensee's frequency block, the minimum resolution bandwidth for the measurement shall be 500 kHz. The emission bandwidth is defined as the width of the signal between two points, one below the carrier center frequency and one above the carrier center frequency, outside of which all emissions are attenuated at least 26 dB below the transmitter power.

Unless otherwise stated the results shown in this test report refer only to the sample(s) tested and such sample(s) are retained for 90 days only.

除非另有說明，此報告結果僅對測試之樣品負責，同時此樣品僅保留90天。本報告未經本公司書面許可，不可部份複製。

This document is issued by the Company subject to its General Conditions of Service printed overleaf, available on request or accessible at <http://www.sgs.com.tw/Terms-and-Conditions> and for electronic format documents, subject to Terms and Conditions for Electronic Documents at <http://www.sgs.com.tw/Terms-and-Conditions>. Attention is drawn to the limitation of liability, indemnification and jurisdiction issues defined therein. Any holder of this document is advised that information contained hereon reflects the Company's findings at the time of its intervention only and within the limits of Client's instructions, if any. The Company's sole responsibility is to its Client and this document does not exonerate parties to a transaction from exercising all their rights and obligations under the transaction documents. This document cannot be reproduced except in full, without prior written approval of the Company. Any unauthorized alteration, forgery or falsification of the content or appearance of this document is unlawful and offenders may be prosecuted to the fullest extent of the law.

## 9.2 Test SET-UP

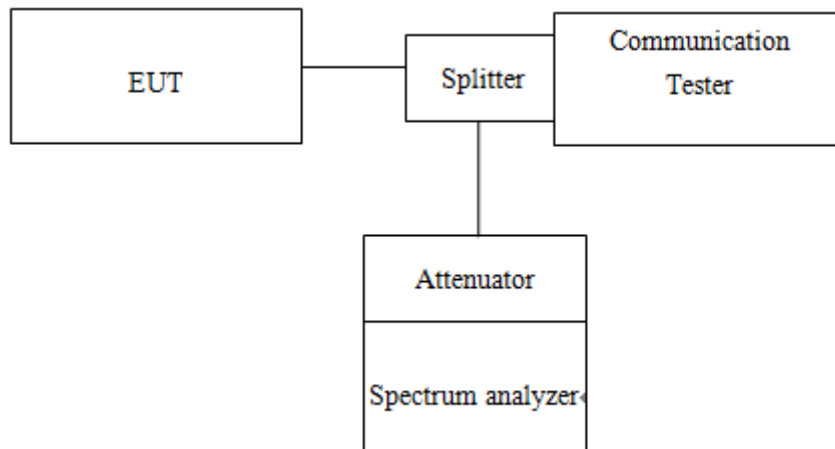

## 9.3 Measurement Procedure

### 9.3.1 Conducted Emission

The RF output of the transceiver was connected to a spectrum analyzer through appropriate attenuation. The resolution bandwidth of the spectrum analyzer was set at 1MHz, sufficient scans were taken to show the out of band Emissions if any up to 10th harmonic.

1. To connect Antenna Port of EUT to Spectrum.
2. Set RBW = 1MHz & VBW = 1MHz on Spectrum.
3. Allow trace to fully stabilize
4. Repeat above procedures until all default test channel measured were complete.

### 9.3.2 Band Edge

1. To connect Antenna Port of EUT to Spectrum.
2. The band edge of low and high channels for the highest RF powers was measured. Setting  $RBW \geq 1\% EBW$ .
3. Allow trace to fully stabilize
4. Repeat above procedures until all default test channel measured were complete.

## 9.4 Band Edge Measurement Result:

Refer to next pages.

Unless otherwise stated the results shown in this test report refer only to the sample(s) tested and such sample(s) are retained for 90 days only.

除非另有說明，此報告結果僅對測試之樣品負責，同時此樣品僅保留90天。本報告未經本公司書面許可，不可部份複製。

This document is issued by the Company subject to its General Conditions of Service printed overleaf, available on request or accessible at <http://www.sgs.com.tw/Terms-and-Conditions> and for electronic format documents, subject to Terms and Conditions for Electronic Documents at <http://www.sgs.com.tw/Terms-and-Conditions>. Attention is drawn to the limitation of liability, indemnification and jurisdiction issues defined therein. Any holder of this document is advised that information contained hereon reflects the Company's findings at the time of its intervention only and within the limits of Client's instructions, if any. The Company's sole responsibility is to its Client and this document does not exonerate parties to a transaction from exercising all their rights and obligations under the transaction documents. This document cannot be reproduced except in full, without prior written approval of the Company. Any unauthorized alteration, forgery or falsification of the content or appearance of this document is unlawful and offenders may be prosecuted to the fullest extent of the law.

Band2\_5MHz\_DFT\_s\_OFDM\_SCS15kHz\_BPSK\_RB1\_0\_CH370500



Band2\_5MHz\_DFT\_s\_OFDM\_SCS15kHz\_BPSK\_RB25\_0\_CH381500



Band2\_5MHz\_DFT\_s\_OFDM\_SCS15kHz\_BPSK\_RB1\_24\_CH381500



Band2\_5MHz\_CP\_OFDM\_SCS15kHz\_QPSK\_RB1\_0\_CH370500

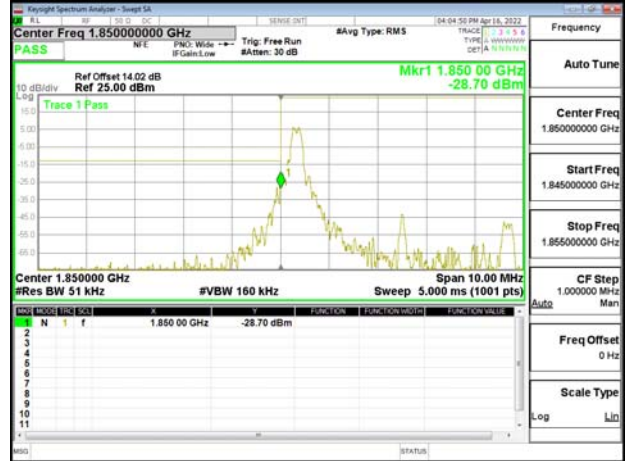

Band2\_5MHz\_DFT\_s\_OFDM\_SCS15kHz\_BPSK\_RB25\_0\_CH370500



Band2\_5MHz\_CP\_OFDM\_SCS15kHz\_QPSK\_RB1\_24\_CH381500

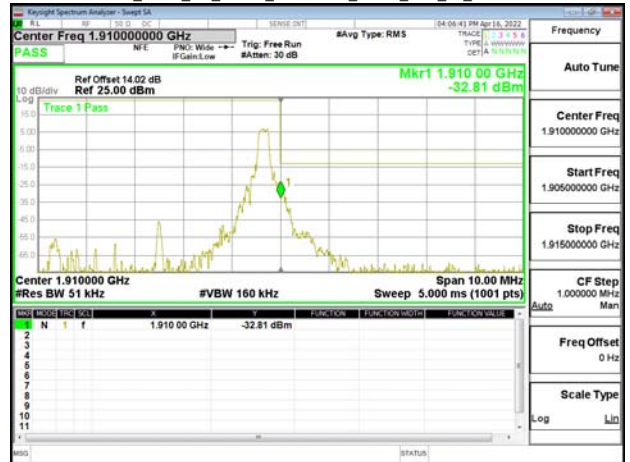

Unless otherwise stated the results shown in this test report refer only to the sample(s) tested and such sample(s) are retained for 90 days only.

除非另有說明，此報告結果僅對測試之樣品負責，同時此樣品僅保留90天。本報告未經本公司書面許可，不可部份複製。

This document is issued by the Company subject to its General Conditions of Service printed overleaf, available on request or accessible at <http://www.sgs.com.tw/Terms-and-Conditions> and for electronic format documents, subject to Terms and Conditions for Electronic Documents at <http://www.sgs.com.tw/Terms-and-Conditions>. Attention is drawn to the limitation of liability, indemnification and jurisdiction issues defined therein. Any holder of this document is advised that information contained hereon reflects the Company's findings at the time of its intervention only and within the limits of Client's instructions, if any. The Company's sole responsibility is to its Client and this document does not exonerate parties to a transaction from exercising all their rights and obligations under the transaction documents. This document cannot be reproduced except in full, without prior written approval of the Company. Any unauthorized alteration, forgery or falsification of the content or appearance of this document is unlawful and offenders may be prosecuted to the fullest extent of the law.

Band2\_5MHz\_CP\_OFDM\_SCS15kHz\_QPSK\_RB25\_0\_CH370500

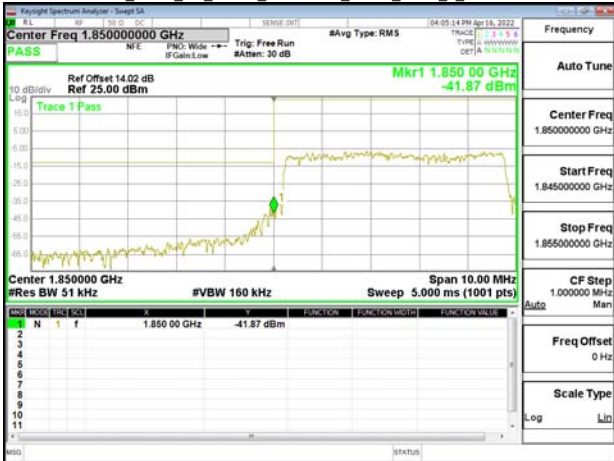

Band2\_10MHz\_DFT\_s\_OFDM\_SCS15kHz\_BPSK\_RB1\_51\_CH381000



Band2\_5MHz\_CP\_OFDM\_SCS15kHz\_QPSK\_RB25\_0\_CH381500

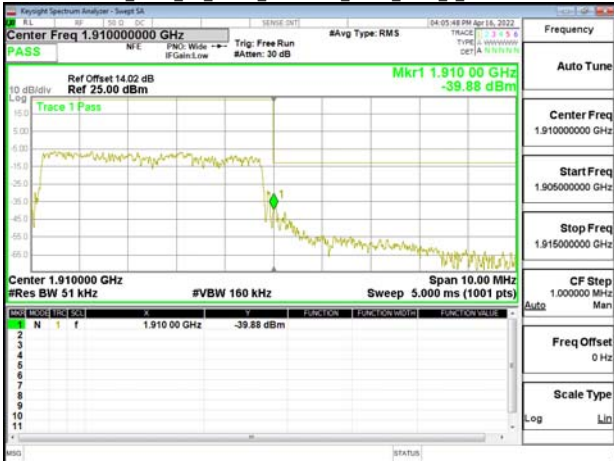

Band2\_10MHz\_DFT\_s\_OFDM\_SCS15kHz\_BPSK\_RB50\_0\_CH371000



Band2\_10MHz\_DFT\_s\_OFDM\_SCS15kHz\_BPSK\_RB1\_0\_CH371000

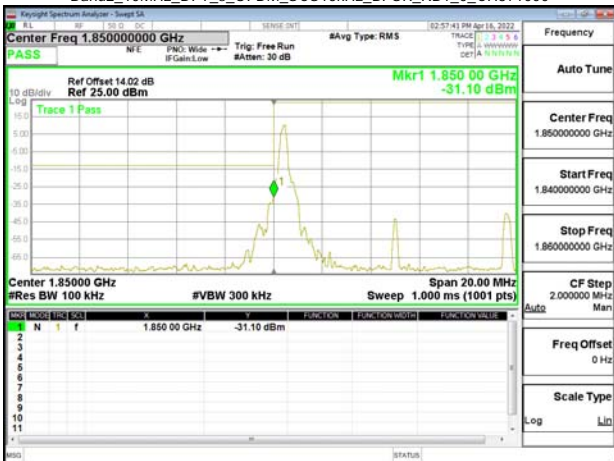

Band2\_10MHz\_DFT\_s\_OFDM\_SCS15kHz\_BPSK\_RB50\_0\_CH381000



Unless otherwise stated the results shown in this test report refer only to the sample(s) tested and such sample(s) are retained for 90 days only.

除非另有說明，此報告結果僅對測試之樣品負責，同時此樣品僅保留90天。本報告未經本公司書面許可，不可部份複製。

This document is issued by the Company subject to its General Conditions of Service printed overleaf, available on request or accessible at <http://www.sgs.com.tw/Terms-and-Conditions> and for electronic format documents, subject to Terms and Conditions for Electronic Documents at <http://www.sgs.com.tw/Terms-and-Conditions>. Attention is drawn to the limitation of liability, indemnification and jurisdiction issues defined therein. Any holder of this document is advised that information contained hereon reflects the Company's findings at the time of its intervention only and within the limits of Client's instructions, if any. The Company's sole responsibility is to its Client and this document does not exonerate parties to a transaction from exercising all their rights and obligations under the transaction documents. This document cannot be reproduced except in full, without prior written approval of the Company. Any unauthorized alteration, forgery or falsification of the content or appearance of this document is unlawful and offenders may be prosecuted to the fullest extent of the law.

Band2\_10MHz\_CP\_OFDM\_SCS15kHz\_OPK\_RB1\_0\_CH371000



Band2\_10MHz\_CP\_OFDM\_SCS15kHz\_OPK\_RB52\_0\_CH381000

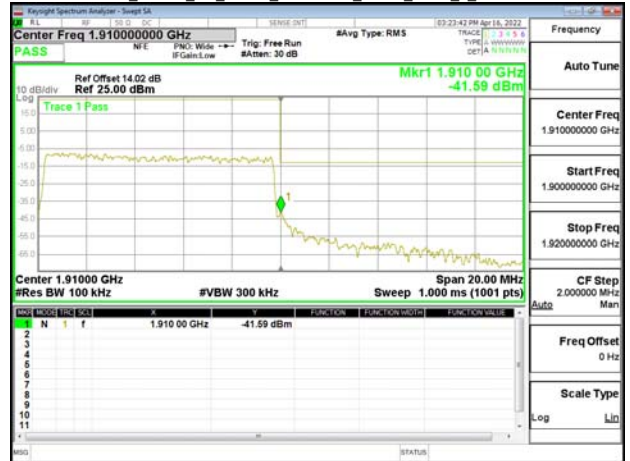

Band2\_10MHz\_CP\_OFDM\_SCS15kHz\_OPK\_RB1\_51\_CH381000

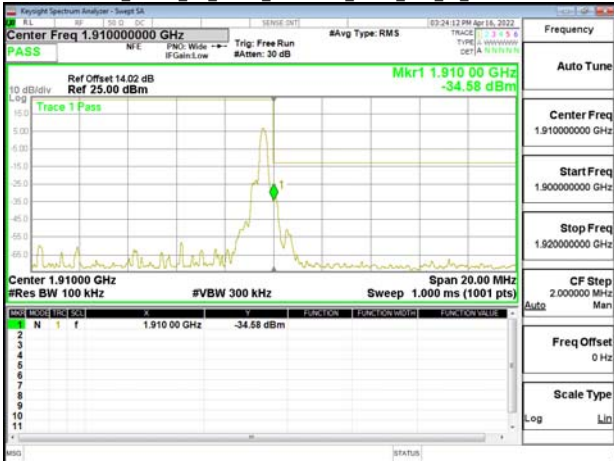

Band2\_15MHz\_DFT\_s\_OFDM\_SCS15kHz\_BPSK\_RB1\_0\_CH371500

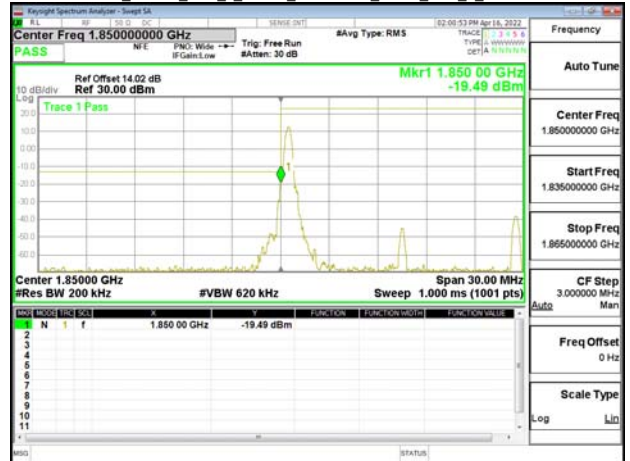

Band2\_10MHz\_CP\_OFDM\_SCS15kHz\_OPK\_RB52\_0\_CH371000

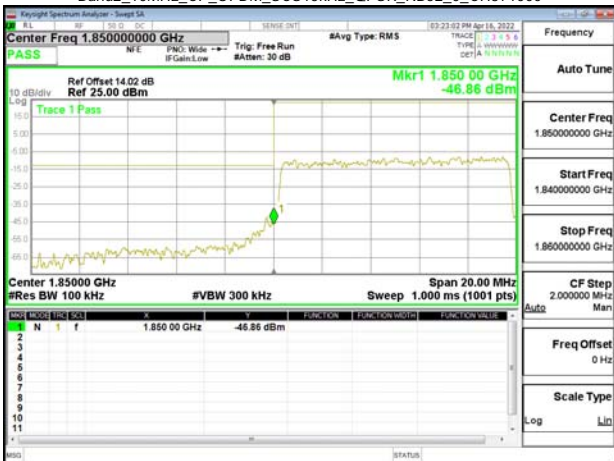

Band2\_15MHz\_DFT\_s\_OFDM\_SCS15kHz\_BPSK\_RB1\_78\_CH380500

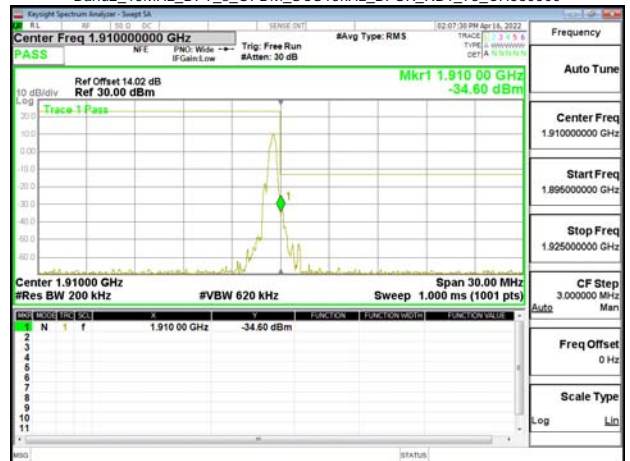

Unless otherwise stated the results shown in this test report refer only to the sample(s) tested and such sample(s) are retained for 90 days only.

除非另有說明，此報告結果僅對測試之樣品負責，同時此樣品僅保留90天。本報告未經本公司書面許可，不可部份複製。

This document is issued by the Company subject to its General Conditions of Service printed overleaf, available on request or accessible at <http://www.sgs.com.tw/Terms-and-Conditions> and for electronic format documents, subject to Terms and Conditions for Electronic Documents at <http://www.sgs.com.tw/Terms-and-Conditions>. Attention is drawn to the limitation of liability, indemnification and jurisdiction issues defined therein. Any holder of this document is advised that information contained hereon reflects the Company's findings at the time of its intervention only and within the limits of Client's instructions, if any. The Company's sole responsibility is to its Client and this document does not exonerate parties to a transaction from exercising all their rights and obligations under the transaction documents. This document cannot be reproduced except in full, without prior written approval of the Company. Any unauthorized alteration, forgery or falsification of the content or appearance of this document is unlawful and offenders may be prosecuted to the fullest extent of the law.

Band2\_15MHz\_DFT\_s\_OFDM\_SCS15kHz\_BPSK\_RB75\_0\_CH371500

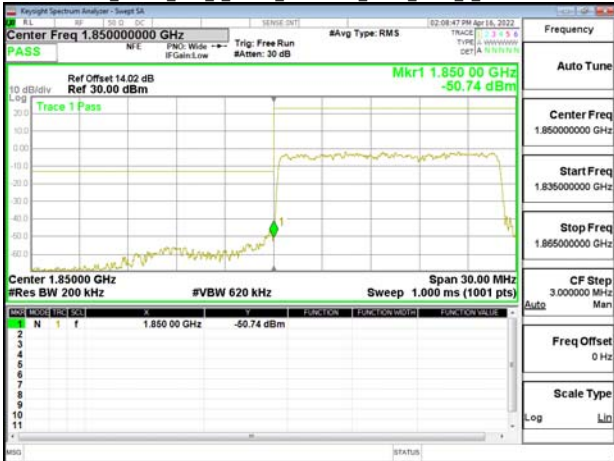

Band2\_15MHz\_CP\_OFDM\_SCS15kHz\_OPK\_RB1\_78\_CH380500



Band2\_15MHz\_DFT\_s\_OFDM\_SCS15kHz\_BPSK\_RB75\_0\_CH380500



Band2\_15MHz\_CP\_OFDM\_SCS15kHz\_OPK\_RB79\_0\_CH371500



Band2\_15MHz\_CP\_OFDM\_SCS15kHz\_OPK\_RB1\_0\_CH371500



Band2\_15MHz\_CP\_OFDM\_SCS15kHz\_OPK\_RB79\_0\_CH380500



Unless otherwise stated the results shown in this test report refer only to the sample(s) tested and such sample(s) are retained for 90 days only.

除非另有說明，此報告結果僅對測試之樣品負責，同時此樣品僅保留90天。本報告未經本公司書面許可，不可部份複製。

This document is issued by the Company subject to its General Conditions of Service printed overleaf, available on request or accessible at <http://www.sgs.com.tw/Terms-and-Conditions> and for electronic format documents, subject to Terms and Conditions for Electronic Documents at <http://www.sgs.com.tw/Terms-and-Conditions>. Attention is drawn to the limitation of liability, indemnification and jurisdiction issues defined therein. Any holder of this document is advised that information contained hereon reflects the Company's findings at the time of its intervention only and within the limits of Client's instructions, if any. The Company's sole responsibility is to its Client and this document does not exonerate parties to a transaction from exercising all their rights and obligations under the transaction documents. This document cannot be reproduced except in full, without prior written approval of the Company. Any unauthorized alteration, forgery or falsification of the content or appearance of this document is unlawful and offenders may be prosecuted to the fullest extent of the law.

Band2\_20MHz\_DFT\_s\_OFDM\_SCS15kHz\_BPSK\_RB100\_0\_CH372000

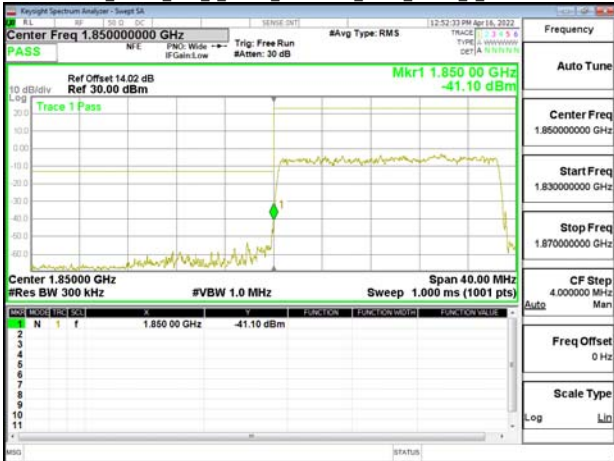

Band2\_20MHz\_DFT\_s\_OFDM\_SCS15kHz\_BPSK\_RB1\_105\_CH380000

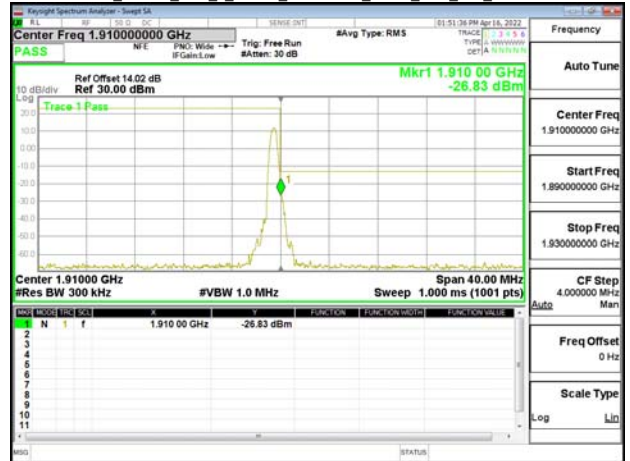

Band2\_20MHz\_DFT\_s\_OFDM\_SCS15kHz\_BPSK\_RB100\_0\_CH380000



Band2\_20MHz\_CP\_OFDM\_SCS15kHz\_QPSK\_RB106\_0\_CH372000



Band2\_20MHz\_DFT\_s\_OFDM\_SCS15kHz\_BPSK\_RB1\_0\_CH372000

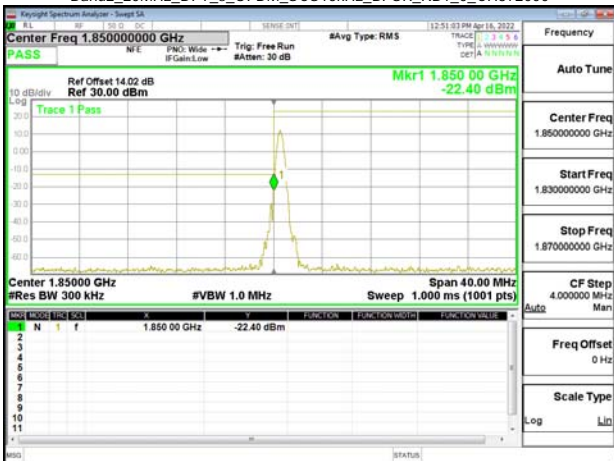

Band2\_20MHz\_CP\_OFDM\_SCS15kHz\_QPSK\_RB106\_0\_CH380000

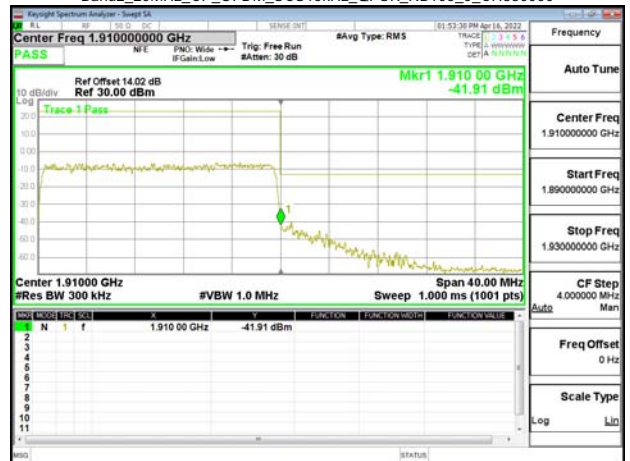

Unless otherwise stated the results shown in this test report refer only to the sample(s) tested and such sample(s) are retained for 90 days only.

除非另有說明，此報告結果僅對測試之樣品負責，同時此樣品僅保留90天。本報告未經本公司書面許可，不可部份複製。

This document is issued by the Company subject to its General Conditions of Service printed overleaf, available on request or accessible at <http://www.sgs.com.tw/Terms-and-Conditions> and for electronic format documents, subject to Terms and Conditions for Electronic Documents at <http://www.sgs.com.tw/Terms-and-Conditions>. Attention is drawn to the limitation of liability, indemnification and jurisdiction issues defined therein. Any holder of this document is advised that information contained hereon reflects the Company's findings at the time of its intervention only and within the limits of Client's instructions, if any. The Company's sole responsibility is to its Client and this document does not exonerate parties to a transaction from exercising all their rights and obligations under the transaction documents. This document cannot be reproduced except in full, without prior written approval of the Company. Any unauthorized alteration, forgery or falsification of the content or appearance of this document is unlawful and offenders may be prosecuted to the fullest extent of the law.

Band2\_20MHz\_CP\_OFDM\_SCS15kHz\_OPK\_RB1\_0\_CH372000



Band5\_5MHz\_DFT\_s\_OFDM\_SCS15kHz\_BPSK\_RB1\_24\_CH169300



Band2\_20MHz\_CP\_OFDM\_SCS15kHz\_QPSK\_RB1\_105\_CH380000

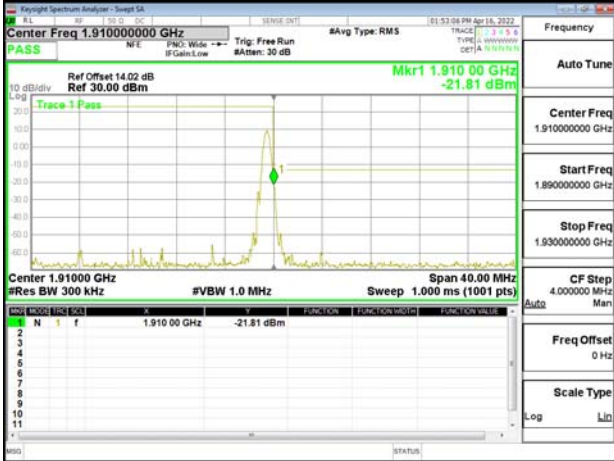

Band5\_5MHz\_DFT\_s\_OFDM\_SCS15kHz\_BPSK\_RB25\_0\_CH165300



Band5\_5MHz\_DFT\_s\_OFDM\_SCS15kHz\_BPSK\_RB1\_0\_CH165300



Band5\_5MHz\_DFT\_s\_OFDM\_SCS15kHz\_BPSK\_RB25\_0\_CH169300



Unless otherwise stated the results shown in this test report refer only to the sample(s) tested and such sample(s) are retained for 90 days only.

除非另有說明，此報告結果僅對測試之樣品負責，同時此樣品僅保留90天。本報告未經本公司書面許可，不可部份複製。

This document is issued by the Company subject to its General Conditions of Service printed overleaf, available on request or accessible at <http://www.sgs.com.tw/Terms-and-Conditions> and for electronic format documents, subject to Terms and Conditions for Electronic Documents at <http://www.sgs.com.tw/Terms-and-Conditions>. Attention is drawn to the limitation of liability, indemnification and jurisdiction issues defined therein. Any holder of this document is advised that information contained hereon reflects the Company's findings at the time of its intervention only and within the limits of Client's instructions, if any. The Company's sole responsibility is to its Client and this document does not exonerate parties to a transaction from exercising all their rights and obligations under the transaction documents. This document cannot be reproduced except in full, without prior written approval of the Company. Any unauthorized alteration, forgery or falsification of the content or appearance of this document is unlawful and offenders may be prosecuted to the fullest extent of the law.



Band5\_5MHz\_CP\_OFDM\_SCS15kHz\_OPSK\_RB1\_0\_CH165300



Band5\_5MHz\_CP\_OFDM\_SCS15kHz\_OPSK\_RB25\_0\_CH169300



Band5\_5MHz\_CP\_OFDM\_SCS15kHz\_OPSK\_RB1\_24\_CH169300

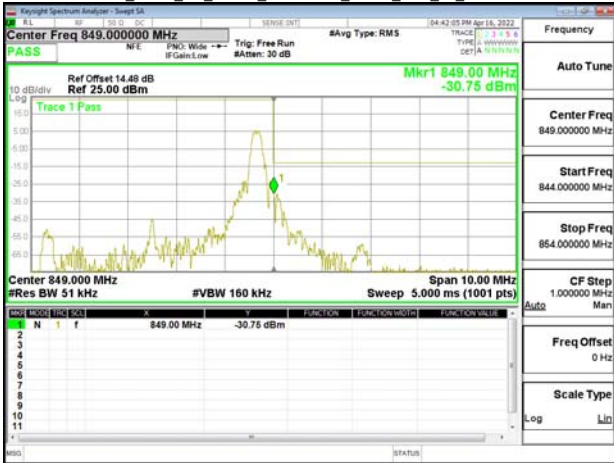

Band5\_10MHz\_DFT\_s\_OFDM\_SCS15kHz\_BPSK\_RB1\_0\_CH165800

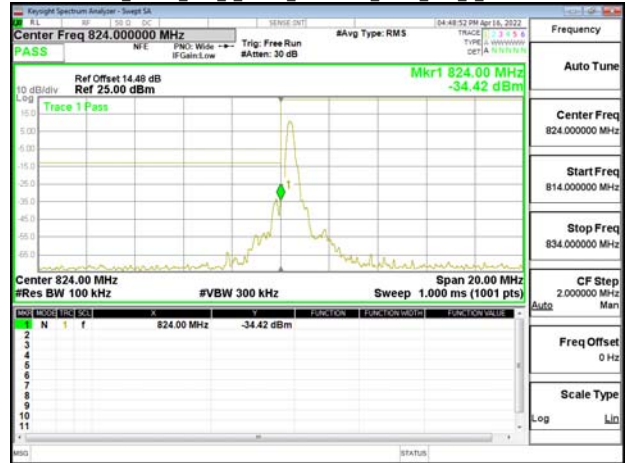

Band5\_5MHz\_CP\_OFDM\_SCS15kHz\_OPSK\_RB25\_0\_CH165300



Band5\_10MHz\_DFT\_s\_OFDM\_SCS15kHz\_BPSK\_RB1\_51\_CH168800

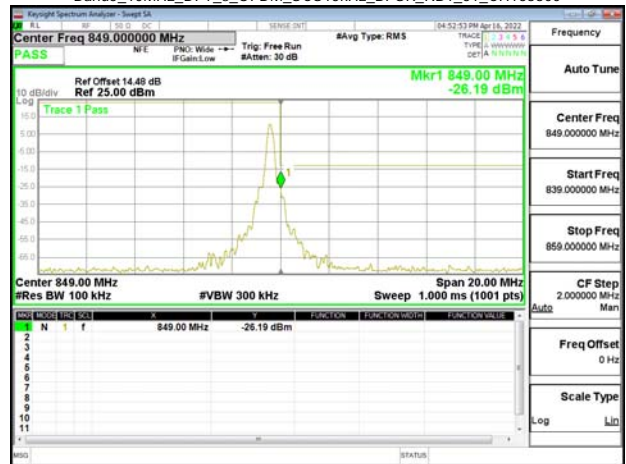

Unless otherwise stated the results shown in this test report refer only to the sample(s) tested and such sample(s) are retained for 90 days only.

除非另有說明，此報告結果僅對測試之樣品負責，同時此樣品僅保留90天。本報告未經本公司書面許可，不可部份複製。

This document is issued by the Company subject to its General Conditions of Service printed overleaf, available on request or accessible at <http://www.sgs.com.tw/Terms-and-Conditions> and for electronic format documents, subject to Terms and Conditions for Electronic Documents at <http://www.sgs.com.tw/Terms-and-Conditions>. Attention is drawn to the limitation of liability, indemnification and jurisdiction issues defined therein. Any holder of this document is advised that information contained hereon reflects the Company's findings at the time of its intervention only and within the limits of Client's instructions, if any. The Company's sole responsibility is to its Client and this document does not exonerate parties to a transaction from exercising all their rights and obligations under the transaction documents. This document cannot be reproduced except in full, without prior written approval of the Company. Any unauthorized alteration, forgery or falsification of the content or appearance of this document is unlawful and offenders may be prosecuted to the fullest extent of the law.

Band5\_10MHz\_DFT\_s\_OFDM\_SCS15kHz\_BPSK\_RB50\_0\_CH165800



Band5\_10MHz\_CP\_OFDM\_SCS15kHz\_OPK\_RB1\_51\_CH168800

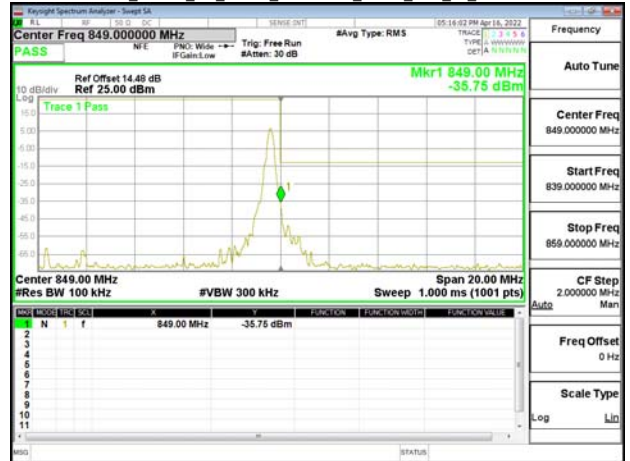

Band5\_10MHz\_DFT\_s\_OFDM\_SCS15kHz\_BPSK\_RB50\_0\_CH168800



Band5\_10MHz\_CP\_OFDM\_SCS15kHz\_OPK\_RB52\_0\_CH165800



Band5\_10MHz\_CP\_OFDM\_SCS15kHz\_OPK\_RB1\_0\_CH165800

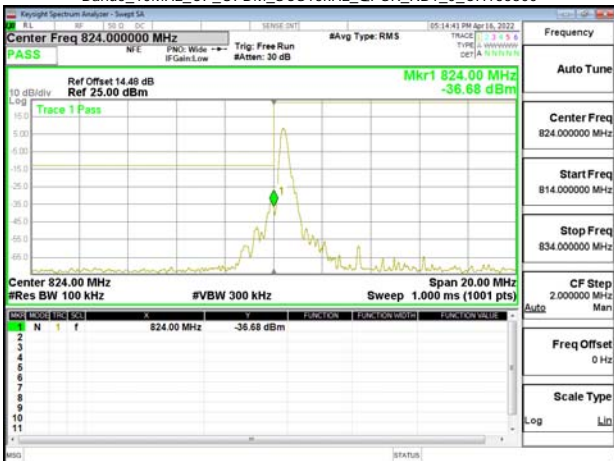

Band5\_10MHz\_CP\_OFDM\_SCS15kHz\_OPK\_RB52\_0\_CH168800



Unless otherwise stated the results shown in this test report refer only to the sample(s) tested and such sample(s) are retained for 90 days only.

除非另有說明，此報告結果僅對測試之樣品負責，同時此樣品僅保留90天。本報告未經本公司書面許可，不可部份複製。

This document is issued by the Company subject to its General Conditions of Service printed overleaf, available on request or accessible at <http://www.sgs.com.tw/Terms-and-Conditions> and for electronic format documents, subject to Terms and Conditions for Electronic Documents at <http://www.sgs.com.tw/Terms-and-Conditions>. Attention is drawn to the limitation of liability, indemnification and jurisdiction issues defined therein. Any holder of this document is advised that information contained hereon reflects the Company's findings at the time of its intervention only and within the limits of Client's instructions, if any. The Company's sole responsibility is to its Client and this document does not exonerate parties to a transaction from exercising all their rights and obligations under the transaction documents. This document cannot be reproduced except in full, without prior written approval of the Company. Any unauthorized alteration, forgery or falsification of the content or appearance of this document is unlawful and offenders may be prosecuted to the fullest extent of the law.

Band5\_15MHz\_DFT\_s\_OFDM\_SCS15kHz\_BPSK\_RB1\_0\_CH166300

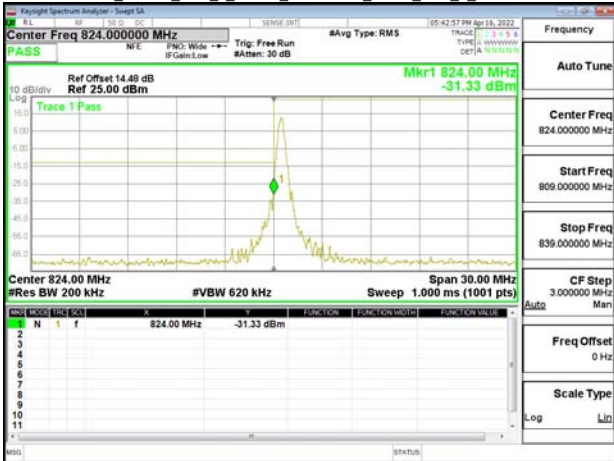

Band5\_15MHz\_DFT\_s\_OFDM\_SCS15kHz\_BPSK\_RB75\_0\_CH168300



Band5\_15MHz\_DFT\_s\_OFDM\_SCS15kHz\_BPSK\_RB1\_78\_CH168300

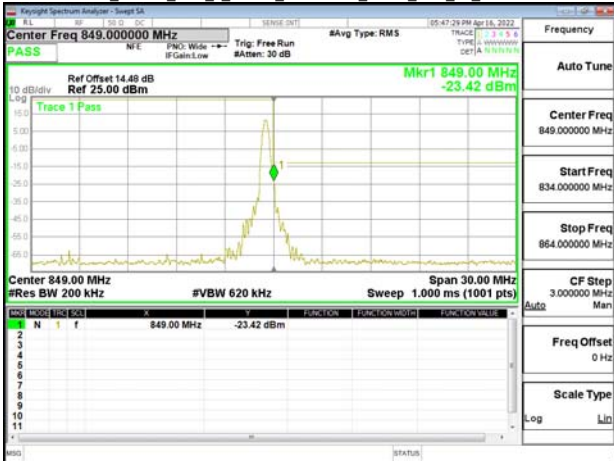

Band5\_15MHz\_CP\_OFDM\_SCS15kHz\_QPSK\_RB1\_0\_CH166300



Band5\_15MHz\_DFT\_s\_OFDM\_SCS15kHz\_BPSK\_RB75\_0\_CH166300

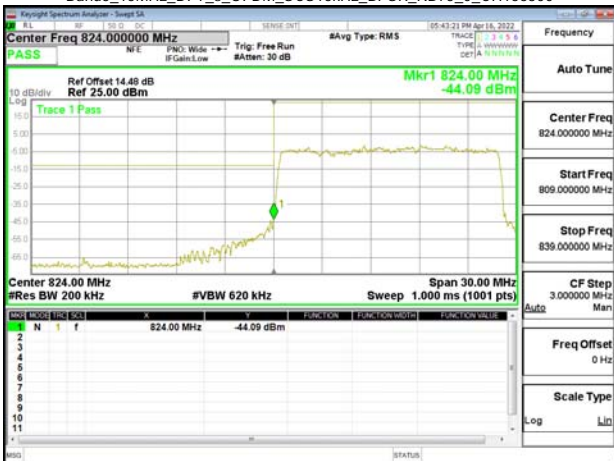

Band5\_15MHz\_CP\_OFDM\_SCS15kHz\_QPSK\_RB1\_78\_CH168300



Unless otherwise stated the results shown in this test report refer only to the sample(s) tested and such sample(s) are retained for 90 days only.

除非另有說明，此報告結果僅對測試之樣品負責，同時此樣品僅保留90天。本報告未經本公司書面許可，不可部份複製。

This document is issued by the Company subject to its General Conditions of Service printed overleaf, available on request or accessible at <http://www.sgs.com.tw/Terms-and-Conditions> and for electronic format documents, subject to Terms and Conditions for Electronic Documents at <http://www.sgs.com.tw/Terms-and-Conditions>. Attention is drawn to the limitation of liability, indemnification and jurisdiction issues defined therein. Any holder of this document is advised that information contained hereon reflects the Company's findings at the time of its intervention only and within the limits of Client's instructions, if any. The Company's sole responsibility is to its Client and this document does not exonerate parties to a transaction from exercising all their rights and obligations under the transaction documents. This document cannot be reproduced except in full, without prior written approval of the Company. Any unauthorized alteration, forgery or falsification of the content or appearance of this document is unlawful and offenders may be prosecuted to the fullest extent of the law.

Band5\_15MHz\_CP\_OFDM\_SCS15kHz\_OPK\_RB79\_0\_CH166300



Band5\_20MHz\_DFT\_s\_OFDM\_SCS15kHz\_BPSK\_RB100\_0\_CH167800



Band5\_15MHz\_CP\_OFDM\_SCS15kHz\_OPK\_RB79\_0\_CH168300

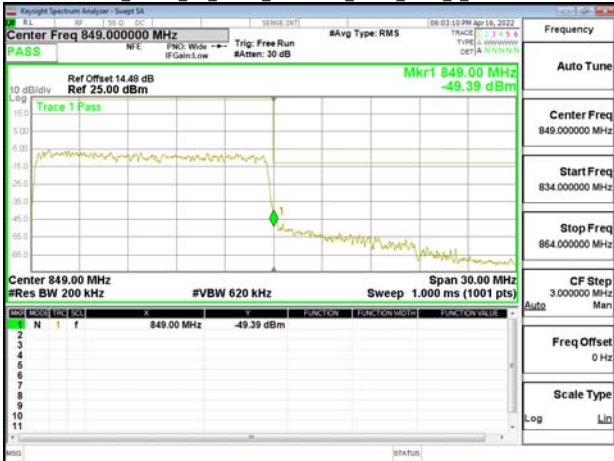

Band5\_20MHz\_DFT\_s\_OFDM\_SCS15kHz\_BPSK\_RB1\_0\_CH166800

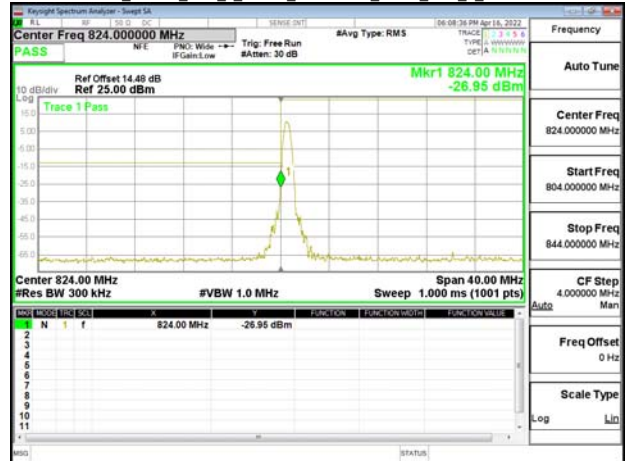

Band5\_20MHz\_DFT\_s\_OFDM\_SCS15kHz\_BPSK\_RB100\_0\_CH166800

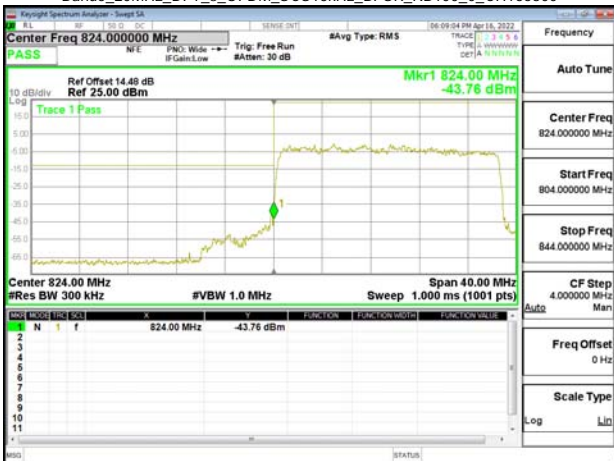

Band5\_20MHz\_DFT\_s\_OFDM\_SCS15kHz\_BPSK\_RB1\_105\_CH167800

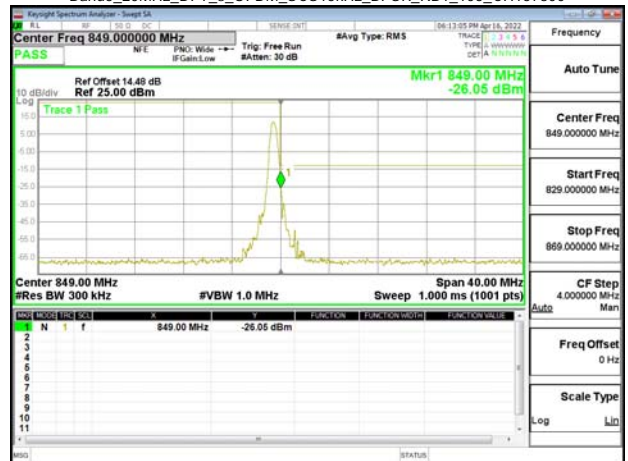

Unless otherwise stated the results shown in this test report refer only to the sample(s) tested and such sample(s) are retained for 90 days only.

除非另有說明，此報告結果僅對測試之樣品負責，同時此樣品僅保留90天。本報告未經本公司書面許可，不可部份複製。

This document is issued by the Company subject to its General Conditions of Service printed overleaf, available on request or accessible at <http://www.sgs.com.tw/Terms-and-Conditions> and for electronic format documents, subject to Terms and Conditions for Electronic Documents at <http://www.sgs.com.tw/Terms-and-Conditions>. Attention is drawn to the limitation of liability, indemnification and jurisdiction issues defined therein. Any holder of this document is advised that information contained hereon reflects the Company's findings at the time of its intervention only and within the limits of Client's instructions, if any. The Company's sole responsibility is to its Client and this document does not exonerate parties to a transaction from exercising all their rights and obligations under the transaction documents. This document cannot be reproduced except in full, without prior written approval of the Company. Any unauthorized alteration, forgery or falsification of the content or appearance of this document is unlawful and offenders may be prosecuted to the fullest extent of the law.

Band5\_20MHz\_CP\_OFDM\_SCS15kHz\_QPSK\_RB106\_0\_CH166800



Band5\_20MHz\_CP\_OFDM\_SCS15kHz\_QPSK\_RB1\_105\_CH167800



Band5\_20MHz\_CP\_OFDM\_SCS15kHz\_QPSK\_RB106\_0\_CH167800



Band66\_5MHz\_DFT\_s\_OFDM\_SCS15kHz\_BPSK\_RB1\_0\_CH342500



Band5\_20MHz\_CP\_OFDM\_SCS15kHz\_QPSK\_RB1\_0\_CH166800

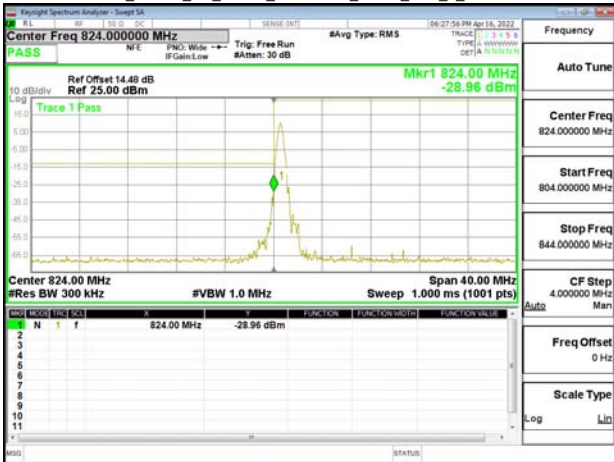

Band66\_5MHz\_DFT\_s\_OFDM\_SCS15kHz\_BPSK\_RB1\_24\_CH355500

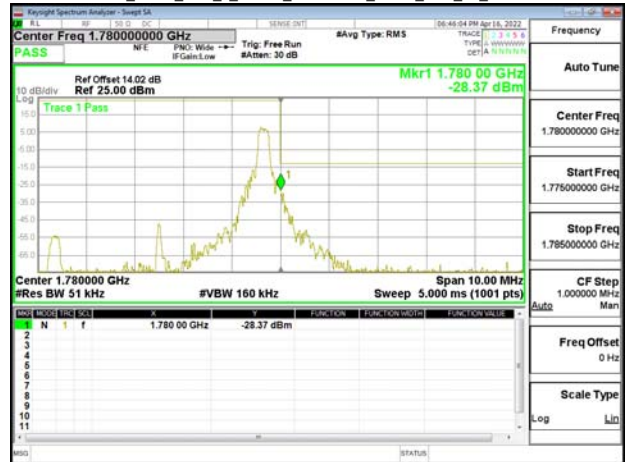

Unless otherwise stated the results shown in this test report refer only to the sample(s) tested and such sample(s) are retained for 90 days only.

除非另有說明，此報告結果僅對測試之樣品負責，同時此樣品僅保留90天。本報告未經本公司書面許可，不可部份複製。

This document is issued by the Company subject to its General Conditions of Service printed overleaf, available on request or accessible at <http://www.sgs.com.tw/Terms-and-Conditions> and for electronic format documents, subject to Terms and Conditions for Electronic Documents at <http://www.sgs.com.tw/Terms-and-Conditions>. Attention is drawn to the limitation of liability, indemnification and jurisdiction issues defined therein. Any holder of this document is advised that information contained hereon reflects the Company's findings at the time of its intervention only and within the limits of Client's instructions, if any. The Company's sole responsibility is to its Client and this document does not exonerate parties to a transaction from exercising all their rights and obligations under the transaction documents. This document cannot be reproduced except in full, without prior written approval of the Company. Any unauthorized alteration, forgery or falsification of the content or appearance of this document is unlawful and offenders may be prosecuted to the fullest extent of the law.

Band66\_5MHz\_DFT\_s\_OFDM\_SCS15kHz\_BPSK\_RB25\_0\_CH342500

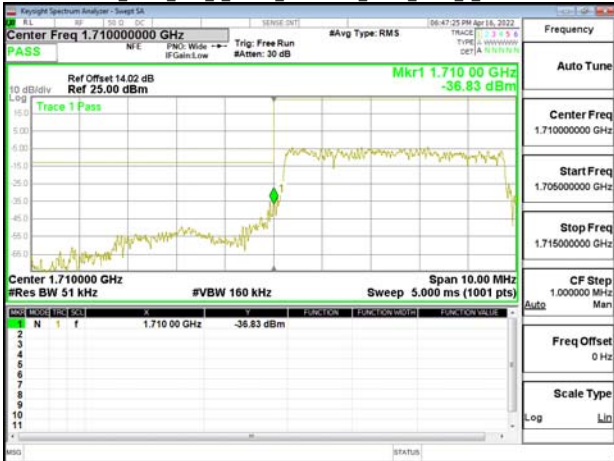

Band66\_5MHz\_CP\_OFDM\_SCS15kHz\_OPK\_RB1\_24\_CH355500



Band66\_5MHz\_DFT\_s\_OFDM\_SCS15kHz\_BPSK\_RB25\_0\_CH355500

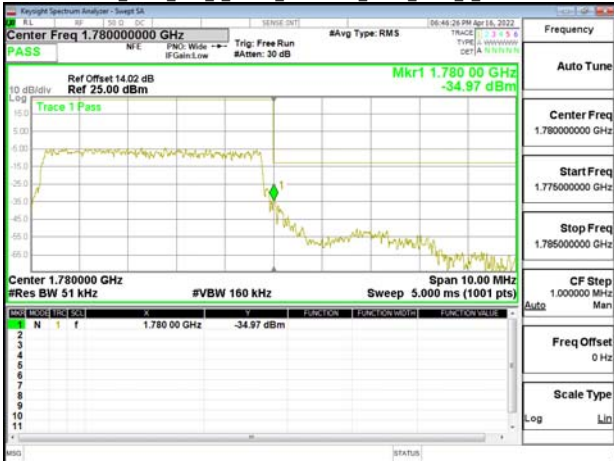

Band66\_5MHz\_CP\_OFDM\_SCS15kHz\_OPK\_RB25\_0\_CH342500



Band66\_5MHz\_CP\_OFDM\_SCS15kHz\_OPK\_RB1\_0\_CH342500



Band66\_5MHz\_CP\_OFDM\_SCS15kHz\_OPK\_RB25\_0\_CH355500



Unless otherwise stated the results shown in this test report refer only to the sample(s) tested and such sample(s) are retained for 90 days only.

除非另有說明，此報告結果僅對測試之樣品負責，同時此樣品僅保留90天。本報告未經本公司書面許可，不可部份複製。

This document is issued by the Company subject to its General Conditions of Service printed overleaf, available on request or accessible at <http://www.sgs.com.tw/Terms-and-Conditions> and for electronic format documents, subject to Terms and Conditions for Electronic Documents at <http://www.sgs.com.tw/Terms-and-Conditions>. Attention is drawn to the limitation of liability, indemnification and jurisdiction issues defined therein. Any holder of this document is advised that information contained hereon reflects the Company's findings at the time of its intervention only and within the limits of Client's instructions, if any. The Company's sole responsibility is to its Client and this document does not exonerate parties to a transaction from exercising all their rights and obligations under the transaction documents. This document cannot be reproduced except in full, without prior written approval of the Company. Any unauthorized alteration, forgery or falsification of the content or appearance of this document is unlawful and offenders may be prosecuted to the fullest extent of the law.

Band66\_10MHz\_DFT\_s\_OFDM\_SCS15kHz\_BPSK\_RB1\_0\_CH343000

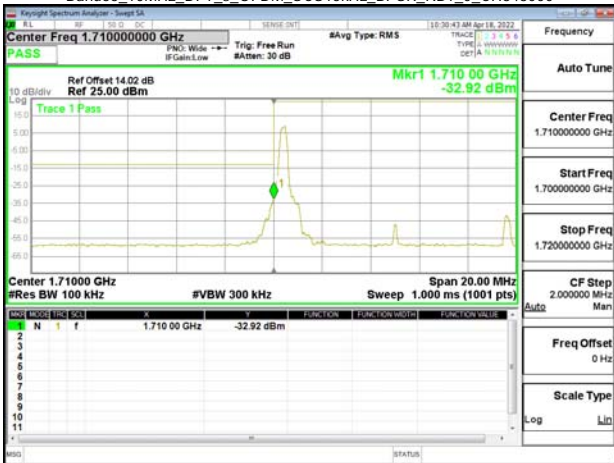

Band66\_10MHz\_DFT\_s\_OFDM\_SCS15kHz\_BPSK\_RB50\_0\_CH355000



Band66\_10MHz\_DFT\_s\_OFDM\_SCS15kHz\_BPSK\_RB1\_51\_CH355000

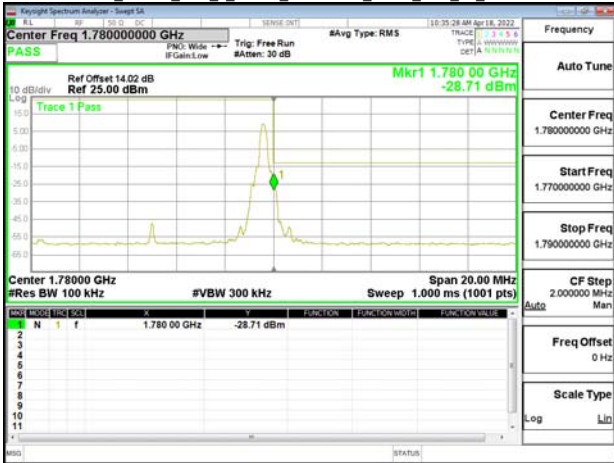

Band66\_10MHz\_CP\_OFDM\_SCS15kHz\_QPSK\_RB1\_0\_CH343000

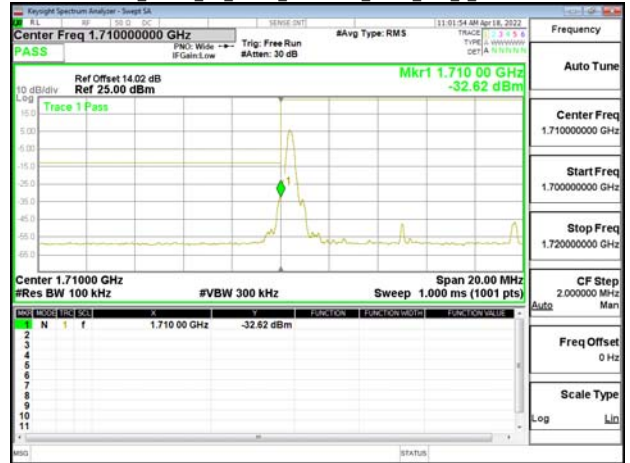

Band66\_10MHz\_DFT\_s\_OFDM\_SCS15kHz\_BPSK\_RB50\_0\_CH343000



Band66\_10MHz\_CP\_OFDM\_SCS15kHz\_QPSK\_RB1\_51\_CH355000



Unless otherwise stated the results shown in this test report refer only to the sample(s) tested and such sample(s) are retained for 90 days only.

除非另有說明，此報告結果僅對測試之樣品負責，同時此樣品僅保留90天。本報告未經本公司書面許可，不可部份複製。

This document is issued by the Company subject to its General Conditions of Service printed overleaf, available on request or accessible at <http://www.sgs.com.tw/Terms-and-Conditions> and for electronic format documents, subject to Terms and Conditions for Electronic Documents at <http://www.sgs.com.tw/Terms-and-Conditions>. Attention is drawn to the limitation of liability, indemnification and jurisdiction issues defined therein. Any holder of this document is advised that information contained hereon reflects the Company's findings at the time of its intervention only and within the limits of Client's instructions, if any. The Company's sole responsibility is to its Client and this document does not exonerate parties to a transaction from exercising all their rights and obligations under the transaction documents. This document cannot be reproduced except in full, without prior written approval of the Company. Any unauthorized alteration, forgery or falsification of the content or appearance of this document is unlawful and offenders may be prosecuted to the fullest extent of the law.

Band66\_10MHz\_CP\_OFDM\_SCS15kHz\_OPK\_RB52\_0\_CH343000



Band66\_15MHz\_DFT\_s\_OFDM\_SCS15kHz\_BPSK\_RB1\_78\_CH354500

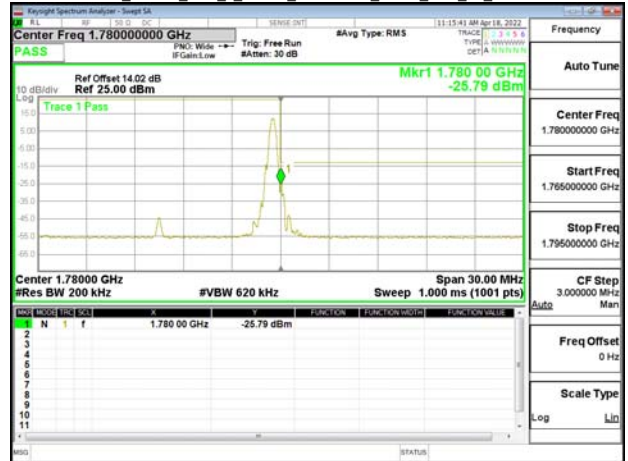

Band66\_10MHz\_CP\_OFDM\_SCS15kHz\_OPK\_RB52\_0\_CH355000

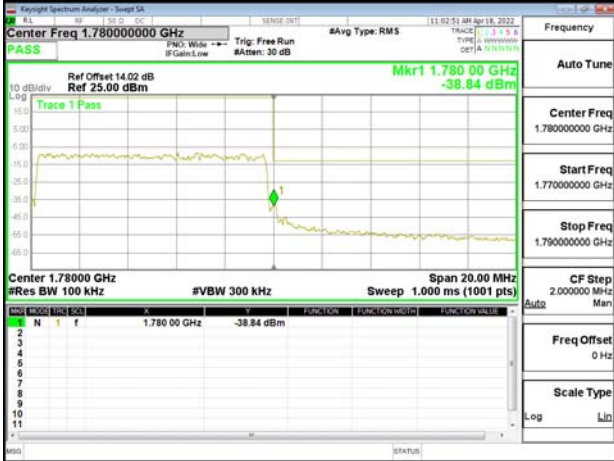

Band66\_15MHz\_DFT\_s\_OFDM\_SCS15kHz\_BPSK\_RB75\_0\_CH343500

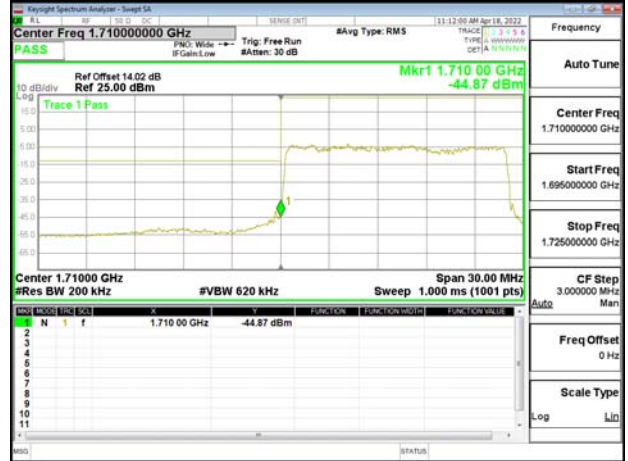

Band66\_15MHz\_DFT\_s\_OFDM\_SCS15kHz\_BPSK\_RB1\_0\_CH343500

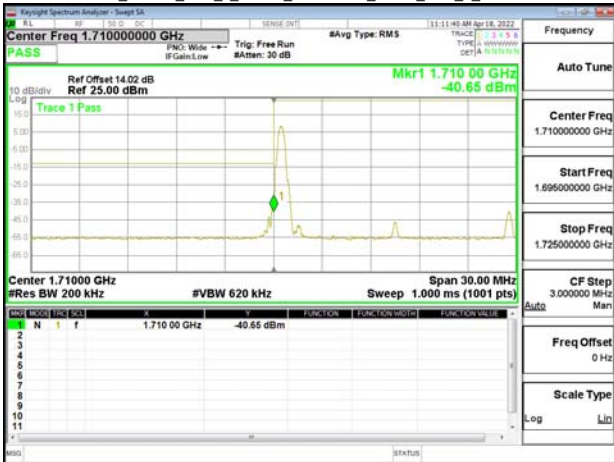

Band66\_15MHz\_DFT\_s\_OFDM\_SCS15kHz\_BPSK\_RB75\_0\_CH354500



Unless otherwise stated the results shown in this test report refer only to the sample(s) tested and such sample(s) are retained for 90 days only.

除非另有說明，此報告結果僅對測試之樣品負責，同時此樣品僅保留90天。本報告未經本公司書面許可，不可部份複製。

This document is issued by the Company subject to its General Conditions of Service printed overleaf, available on request or accessible at <http://www.sgs.com.tw/Terms-and-Conditions> and for electronic format documents, subject to Terms and Conditions for Electronic Documents at <http://www.sgs.com.tw/Terms-and-Conditions>. Attention is drawn to the limitation of liability, indemnification and jurisdiction issues defined therein. Any holder of this document is advised that information contained hereon reflects the Company's findings at the time of its intervention only and within the limits of Client's instructions, if any. The Company's sole responsibility is to its Client and this document does not exonerate parties to a transaction from exercising all their rights and obligations under the transaction documents. This document cannot be reproduced except in full, without prior written approval of the Company. Any unauthorized alteration, forgery or falsification of the content or appearance of this document is unlawful and offenders may be prosecuted to the fullest extent of the law.



Band66\_15MHz\_CP\_OFDM\_SCS15kHz\_OPSK\_RB1\_0\_CH343500

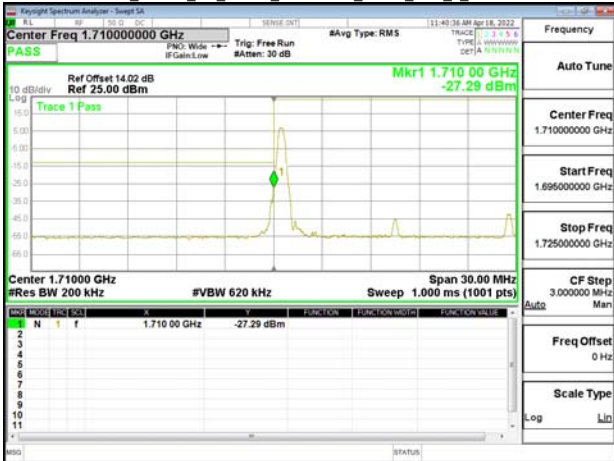

Band66\_15MHz\_CP\_OFDM\_SCS15kHz\_OPSK\_RB79\_0\_CH354500



Band66\_15MHz\_CP\_OFDM\_SCS15kHz\_OPSK\_RB1\_78\_CH354500

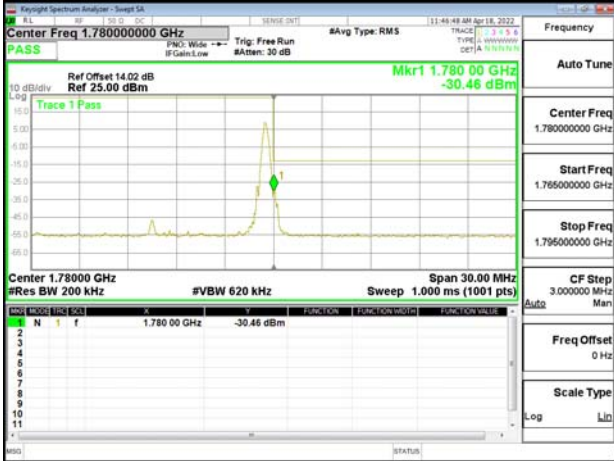

Band66\_20MHz\_DFT\_s\_OFDM\_SCS15kHz\_BPSK\_RB100\_0\_CH344000



Band66\_15MHz\_CP\_OFDM\_SCS15kHz\_OPSK\_RB79\_0\_CH343500

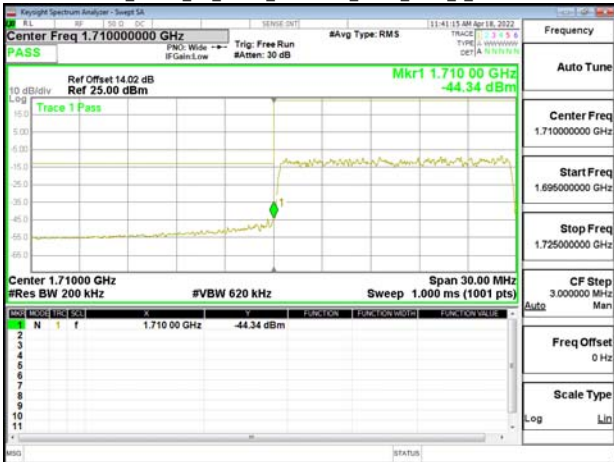

Band66\_20MHz\_DFT\_s\_OFDM\_SCS15kHz\_BPSK\_RB100\_0\_CH354000



Unless otherwise stated the results shown in this test report refer only to the sample(s) tested and such sample(s) are retained for 90 days only.

除非另有說明，此報告結果僅對測試之樣品負責，同時此樣品僅保留90天。本報告未經本公司書面許可，不可部份複製。

This document is issued by the Company subject to its General Conditions of Service printed overleaf, available on request or accessible at <http://www.sgs.com.tw/Terms-and-Conditions> and for electronic format documents, subject to Terms and Conditions for Electronic Documents at <http://www.sgs.com.tw/Terms-and-Conditions>. Attention is drawn to the limitation of liability, indemnification and jurisdiction issues defined therein. Any holder of this document is advised that information contained hereon reflects the Company's findings at the time of its intervention only and within the limits of Client's instructions, if any. The Company's sole responsibility is to its Client and this document does not exonerate parties to a transaction from exercising all their rights and obligations under the transaction documents. This document cannot be reproduced except in full, without prior written approval of the Company. Any unauthorized alteration, forgery or falsification of the content or appearance of this document is unlawful and offenders may be prosecuted to the fullest extent of the law.

Band66\_20MHz\_DFT\_s\_OFDM\_SCS15kHz\_BPSK\_RB1\_0\_CH344000

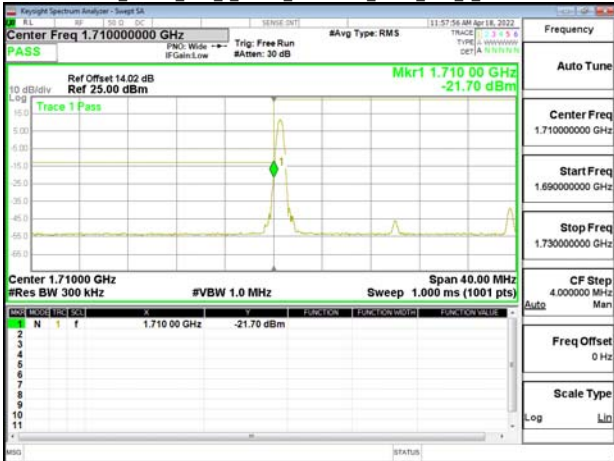

Band66\_20MHz\_CP\_OFDM\_SCS15kHz\_OPK\_RB106\_0\_CH354000



Band66\_20MHz\_DFT\_s\_OFDM\_SCS15kHz\_BPSK\_RB1\_105\_CH354000

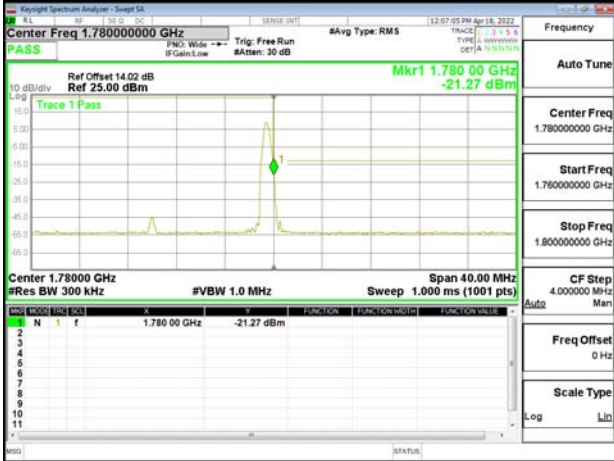

Band66\_20MHz\_CP\_OFDM\_SCS15kHz\_QPSK\_RB1\_0\_CH344000

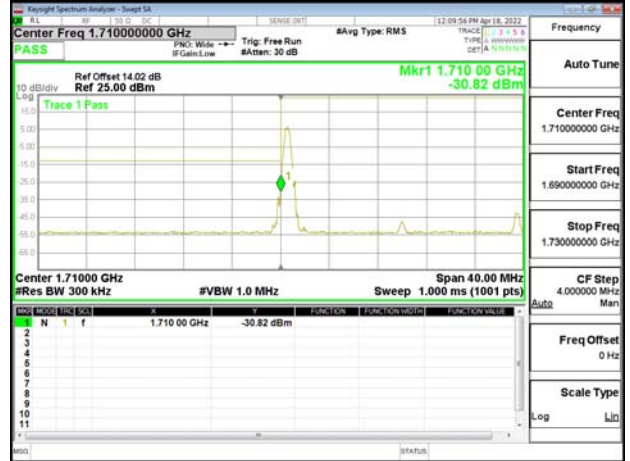

Band66\_20MHz\_CP\_OFDM\_SCS15kHz\_QPSK\_RB106\_0\_CH344000



Band66\_20MHz\_CP\_OFDM\_SCS15kHz\_QPSK\_RB1\_105\_CH354000

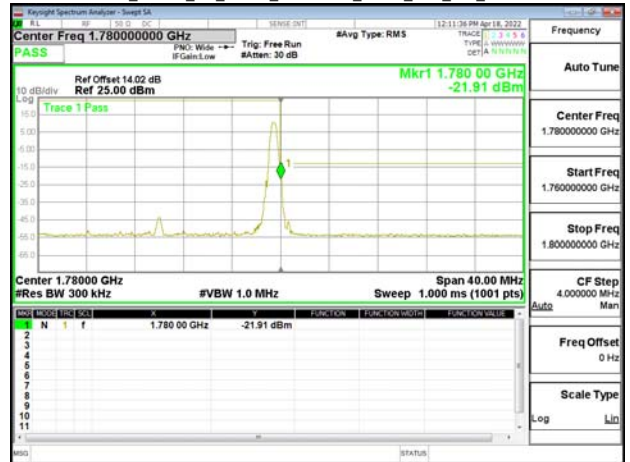

Unless otherwise stated the results shown in this test report refer only to the sample(s) tested and such sample(s) are retained for 90 days only.

除非另有說明，此報告結果僅對測試之樣品負責，同時此樣品僅保留90天。本報告未經本公司書面許可，不可部份複製。

This document is issued by the Company subject to its General Conditions of Service printed overleaf, available on request or accessible at <http://www.sgs.com.tw/Terms-and-Conditions> and for electronic format documents, subject to Terms and Conditions for Electronic Documents at <http://www.sgs.com.tw/Terms-and-Conditions>. Attention is drawn to the limitation of liability, indemnification and jurisdiction issues defined therein. Any holder of this document is advised that information contained hereon reflects the Company's findings at the time of its intervention only and within the limits of Client's instructions, if any. The Company's sole responsibility is to its Client and this document does not exonerate parties to a transaction from exercising all their rights and obligations under the transaction documents. This document cannot be reproduced except in full, without prior written approval of the Company. Any unauthorized alteration, forgery or falsification of the content or appearance of this document is unlawful and offenders may be prosecuted to the fullest extent of the law.

Band66\_30MHz\_DFT\_s\_OFDM\_SCS15kHz\_BPSK\_RB160\_0\_CH345000

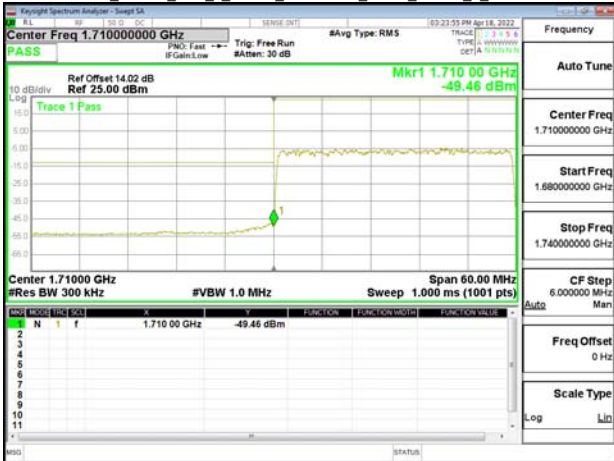

Band66\_30MHz\_DFT\_s\_OFDM\_SCS15kHz\_BPSK\_RB159\_CH353000

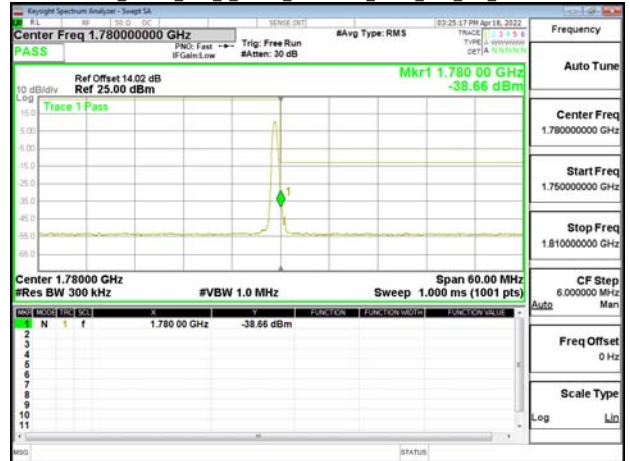

Band66\_30MHz\_DFT\_s\_OFDM\_SCS15kHz\_BPSK\_RB160\_0\_CH353000



Band66\_30MHz\_CP\_OFDM\_SCS15kHz\_QPSK\_RB160\_0\_CH345000

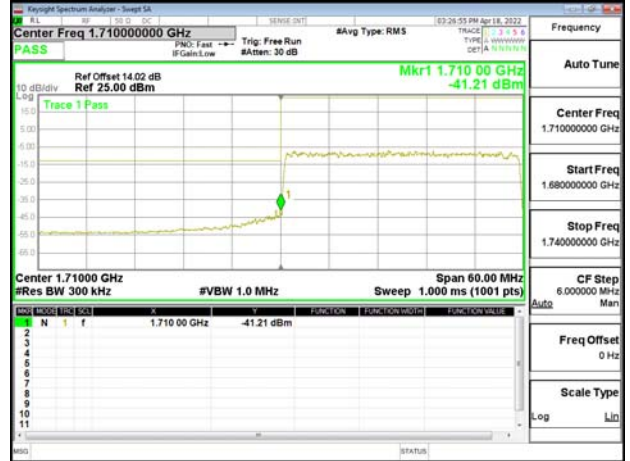

Band66\_30MHz\_DFT\_s\_OFDM\_SCS15kHz\_BPSK\_RB1\_0\_CH345000



Band66\_30MHz\_CP\_OFDM\_SCS15kHz\_QPSK\_RB160\_0\_CH353000



Unless otherwise stated the results shown in this test report refer only to the sample(s) tested and such sample(s) are retained for 90 days only.

除非另有說明，此報告結果僅對測試之樣品負責，同時此樣品僅保留90天。本報告未經本公司書面許可，不可部份複製。

This document is issued by the Company subject to its General Conditions of Service printed overleaf, available on request or accessible at <http://www.sgs.com.tw/Terms-and-Conditions> and for electronic format documents, subject to Terms and Conditions for Electronic Documents at <http://www.sgs.com.tw/Terms-and-Conditions>. Attention is drawn to the limitation of liability, indemnification and jurisdiction issues defined therein. Any holder of this document is advised that information contained hereon reflects the Company's findings at the time of its intervention only and within the limits of Client's instructions, if any. The Company's sole responsibility is to its Client and this document does not exonerate parties to a transaction from exercising all their rights and obligations under the transaction documents. This document cannot be reproduced except in full, without prior written approval of the Company. Any unauthorized alteration, forgery or falsification of the content or appearance of this document is unlawful and offenders may be prosecuted to the fullest extent of the law.