

Band77-Part27_60MHz_CP_OFDM_SCS30kHz_OPSK_RB1_1_CH632000

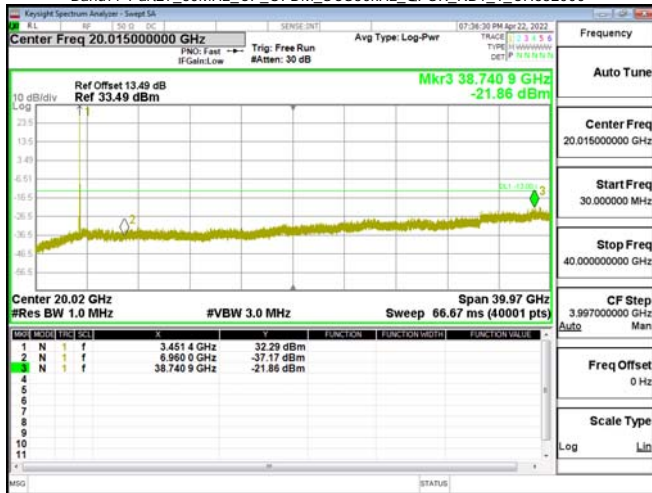

Band77-Part27_60MHz_CP_OFDM_SCS30kHz_OPSK_RB1_1_CH648668



Band77-Part27_60MHz_CP_OFDM_SCS30kHz_OPSK_RB1_1_CH633334

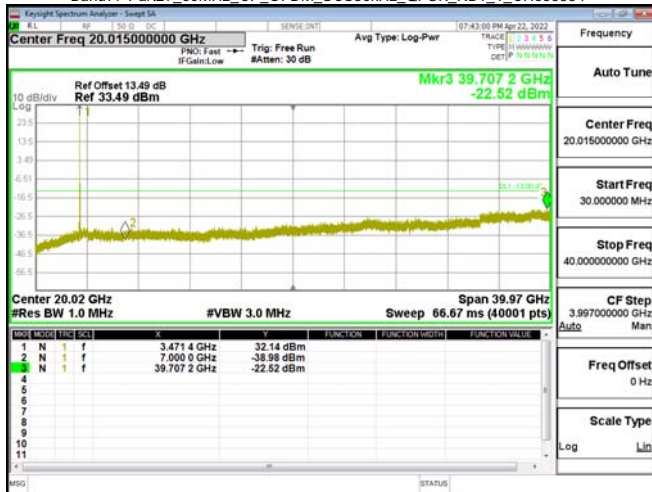

Band77-Part27_60MHz_CP_OFDM_SCS30kHz_OPSK_RB1_1_CH656000

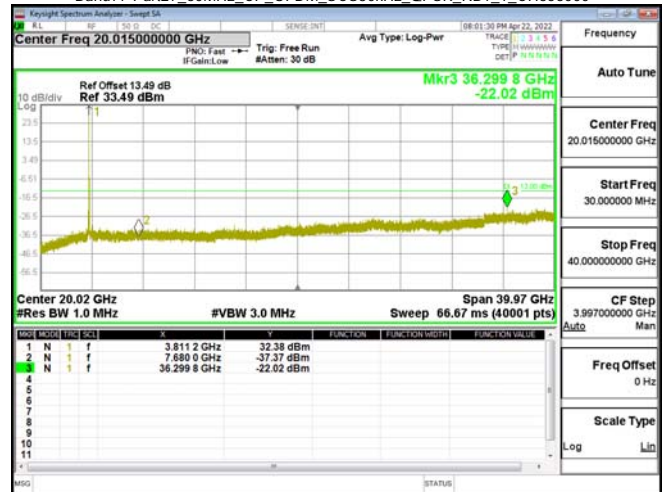

Band77-Part27_60MHz_CP_OFDM_SCS30kHz_OPSK_RB1_1_CH634666

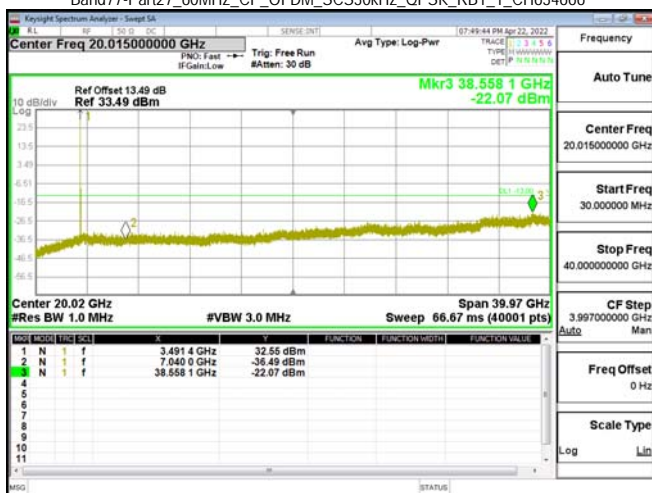

Band77-Part27_60MHz_CP_OFDM_SCS30kHz_OPSK_RB1_1_CH663332

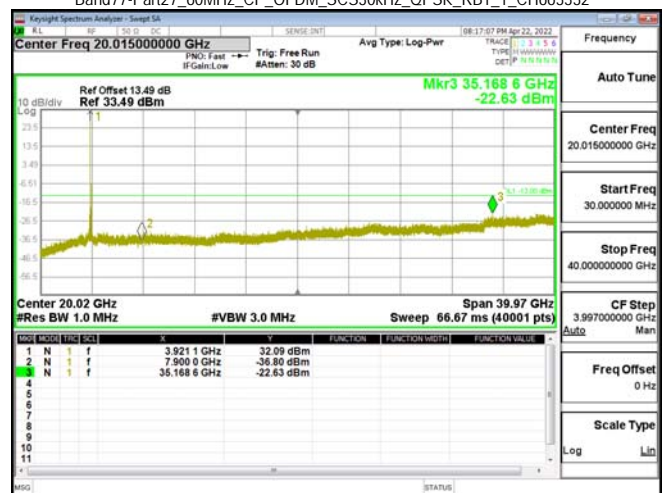

Unless otherwise stated the results shown in this test report refer only to the sample(s) tested and such sample(s) are retained for 90 days only.
除非另有說明，此報告結果僅對測試之樣品負責，同時此樣品僅保留90天。本報告未經本公司書面許可，不可部份複製。
This document is issued by the Company subject to its General Conditions of Service printed overleaf, available on request or accessible at <http://www.sgs.com.tw/Terms-and-Conditions> and for electronic format documents, subject to Terms and Conditions for Electronic Documents at <http://www.sgs.com.tw/Terms-and-Conditions>. Attention is drawn to the limitation of liability, indemnification and jurisdiction issues defined therein. Any holder of this document is advised that information contained hereon reflects the Company's findings at the time of its intervention only and within the limits of Client's instructions, if any. The Company's sole responsibility is to its Client and this document does not exonerate parties to a transaction from exercising all their rights and obligations under the transaction documents. This document cannot be reproduced except in full, without prior written approval of the Company. Any unauthorized alteration, forgery or falsification of the content or appearance of this document is unlawful and offenders may be prosecuted to the fullest extent of the law.

Band77-Part27_80MHz_CP_OFDM_SCS30kHz_OPSK_RB1_1_CH632668



Band77-Part27_80MHz_CP_OFDM_SCS30kHz_OPSK_RB1_1_CH649334



Band77-Part27_80MHz_CP_OFDM_SCS30kHz_OPSK_RB1_1_CH633334

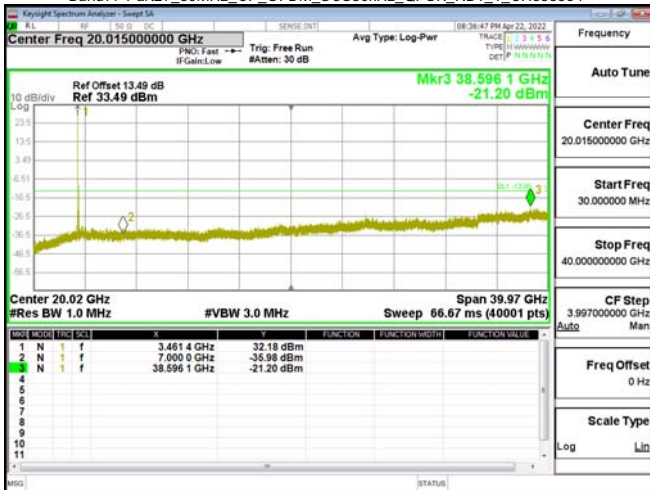

Band77-Part27_80MHz_CP_OFDM_SCS30kHz_OPSK_RB1_1_CH656000



Band77-Part27_80MHz_CP_OFDM_SCS30kHz_OPSK_RB1_1_CH634000

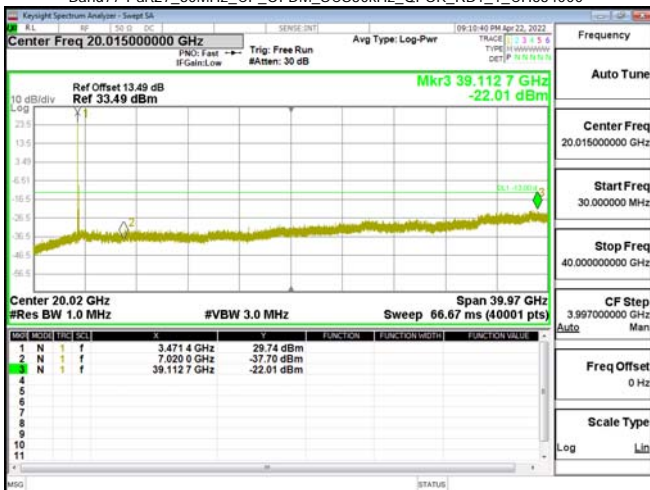

Band77-Part27_80MHz_CP_OFDM_SCS30kHz_OPSK_RB1_1_CH662666



Unless otherwise stated the results shown in this test report refer only to the sample(s) tested and such sample(s) are retained for 90 days only.

除非另有說明，此報告結果僅對測試之樣品負責，同時此樣品僅保留90天。本報告未經本公司書面許可，不可部份複製。

This document is issued by the Company subject to its General Conditions of Service printed overleaf, available on request or accessible at <http://www.sgs.com.tw/Terms-and-Conditions> and for electronic format documents, subject to Terms and Conditions for Electronic Documents at <http://www.sgs.com.tw/Terms-and-Conditions>. Attention is drawn to the limitation of liability, indemnification and jurisdiction issues defined therein. Any holder of this document is advised that information contained hereon reflects the Company's findings at the time of its intervention only and within the limits of Client's instructions, if any. The Company's sole responsibility is to its Client and this document does not exonerate parties to a transaction from exercising all their rights and obligations under the transaction documents. This document cannot be reproduced except in full, without prior written approval of the Company. Any unauthorized alteration, forgery or falsification of the content or appearance of this document is unlawful and offenders may be prosecuted to the fullest extent of the law.

Band77-Part27_100MHz_CP_OFDM_SCS30kHz_OPSK_RB1_1_CH633334

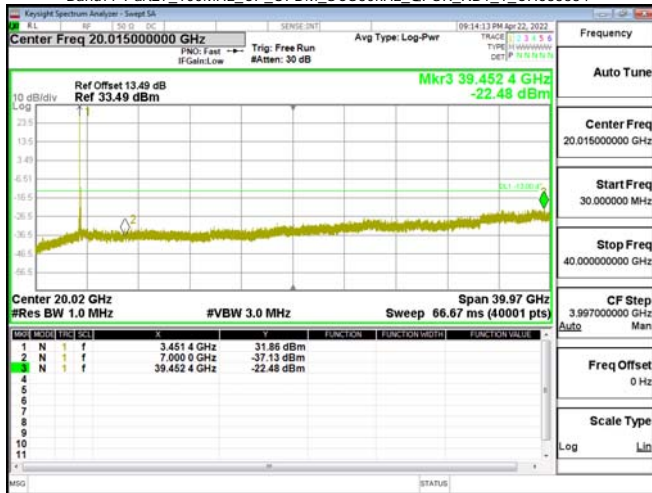

Band77-Part27_100MHz_CP_OFDM_SCS30kHz_OPSK_RB1_1_CH662000



Band77-Part27_100MHz_CP_OFDM_SCS30kHz_OPSK_RB1_1_CH650000

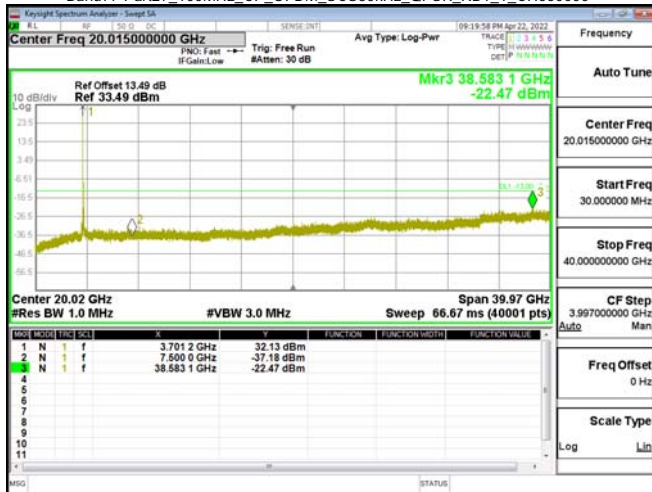

Band77-Part27_100MHz_CP_OFDM_SCS30kHz_OPSK_RB1_1_CH656000

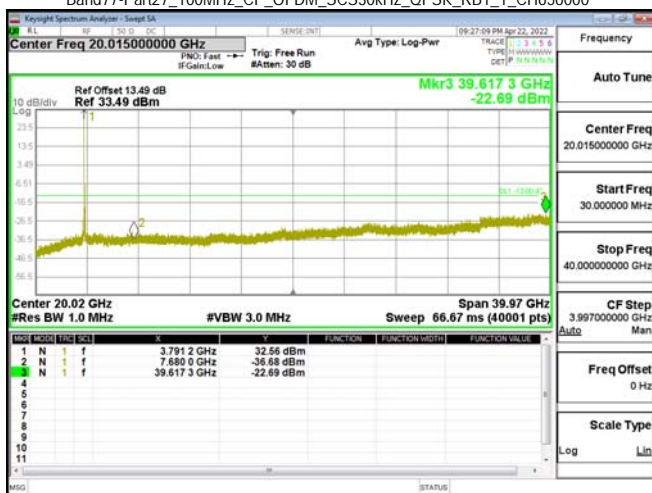

Unless otherwise stated the results shown in this test report refer only to the sample(s) tested and such sample(s) are retained for 90 days only.

除非另有說明，此報告結果僅對測試之樣品負責，同時此樣品僅保留90天。本報告未經本公司書面許可，不可部份複製。

This document is issued by the Company subject to its General Conditions of Service printed overleaf, available on request or accessible at <http://www.sgs.com.tw/Terms-and-Conditions> and for electronic format documents, subject to Terms and Conditions for Electronic Documents at <http://www.sgs.com.tw/Terms-and-Conditions>. Attention is drawn to the limitation of liability, indemnification and jurisdiction issues defined therein. Any holder of this document is advised that information contained herein reflects the Company's findings at the time of its intervention only and within the limits of Client's instructions, if any. The Company's sole responsibility is to its Client and this document does not exonerate parties to a transaction from exercising all their rights and obligations under the transaction documents. This document cannot be reproduced except in full, without prior written approval of the Company. Any unauthorized alteration, forgery or falsification of the content or appearance of this document is unlawful and offenders may be prosecuted to the fullest extent of the law.

10 FIELD STRENGTH OF SPURIOUS RADIATION MEASUREMENT

10.1 Standard Applicable

According to FCC §2.1053,

FCC §22.917(a), §24.238(a), §27.53(h)

Out of band emissions. The power of any emission outside of the authorized operating frequency ranges must be attenuated below the transmitting power (P) by a factor of at least $43 + 10 \log(P)$ dB.

FCC §27.53(h)(1)

(h) *AWS emission limits*—(1) *General protection levels*. Except as otherwise specified below, for operations in the 1695-1710 MHz, 1710-1755 MHz, 1755-1780 MHz, 1915-1920 MHz, 1995-2000 MHz, 2000-2020 MHz, 2110-2155 MHz, 2155-2180 MHz, and 2180-2200 bands, the power of any emission outside a licensee's frequency block shall be attenuated below the transmitter power (P) in watts by at least $43 + 10 \log_{10}(P)$ dB.

FCC §27.53(l)(2)

(2) For mobile operations in the 3700-3980 MHz band, the conducted power of any emission outside the licensee's authorized bandwidth shall not exceed -13 dBm/MHz. Compliance with this paragraph (l)(2) is based on the use of measurement instrumentation employing a resolution bandwidth of 1 megahertz or greater. However, in the 1 megahertz bands immediately outside and adjacent to the licensee's frequency block, the minimum resolution bandwidth for the measurement shall be either one percent of the emission bandwidth of the fundamental emission of the transmitter or 350 kHz. In the bands between 1 and 5 MHz removed from the licensee's frequency block, the minimum resolution bandwidth for the measurement shall be 500 kHz. The emission bandwidth is defined as the width of the signal between two points, one below the carrier center frequency and one above the carrier center frequency, outside of which all emissions are attenuated at least 26 dB below the transmitter power.

FCC §27.53(n)(2)

(2) For mobile operations in the 3450-3550 MHz band, the conducted power of any emission outside the licensee's authorized bandwidth shall not exceed -13 dBm/MHz. Compliance with this paragraph (n)(2) is based on the use of measurement instrumentation employing a resolution bandwidth of 1 megahertz or greater. However, in the 1 megahertz bands immediately outside and adjacent to the licensee's frequency block, a resolution bandwidth of at least one percent of the emission bandwidth of the fundamental emission of the transmitter may be employed, but limited to a maximum of 200 kHz. In the bands between 1 and 5 MHz removed from the licensee's frequency block, the minimum resolution bandwidth for the measurement shall be 500 kHz. The emission bandwidth is defined as the width of the signal between two points, one below the carrier center frequency and one above the carrier center frequency, outside of which all emissions are attenuated at least 26 dB below the transmitter power.

Unless otherwise stated the results shown in this test report refer only to the sample(s) tested and such sample(s) are retained for 90 days only.
除非另有說明，此報告結果僅對測試之樣品負責，同時此樣品僅保留90天。本報告未經本公司書面許可，不可部份複製。

This document is issued by the Company subject to its General Conditions of Service printed overleaf, available on request or accessible at <http://www.sgs.com.tw/Terms-and-Conditions> and for electronic format documents, subject to Terms and Conditions for Electronic Documents at <http://www.sgs.com.tw/Terms-and-Conditions>. Attention is drawn to the limitation of liability, indemnification and jurisdiction issues defined therein. Any holder of this document is advised that information contained hereon reflects the Company's findings at the time of its intervention only and within the limits of Client's instructions, if any. The Company's sole responsibility is to its Client and this document does not exonerate parties to a transaction from exercising all their rights and obligations under the transaction documents. This document cannot be reproduced except in full, without prior written approval of the Company. Any unauthorized alteration, forgery or falsification of the content or appearance of this document is unlawful and offenders may be prosecuted to the fullest extent of the law.

10.2 EUT Setup

Radiated Emission Test Set-Up, Frequency From 30MHz to 1000MHz.

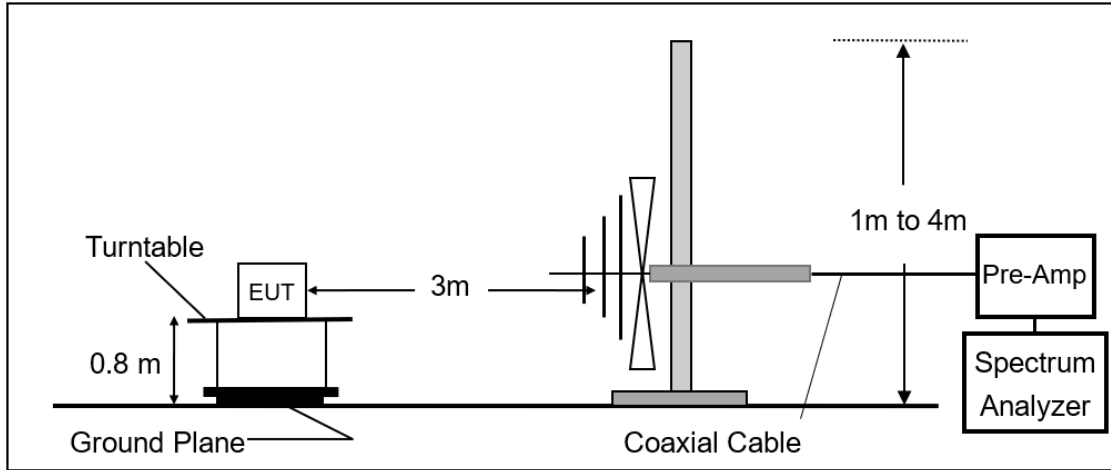

Radiated Emission Test Set-Up, Frequency Above 1GHz.

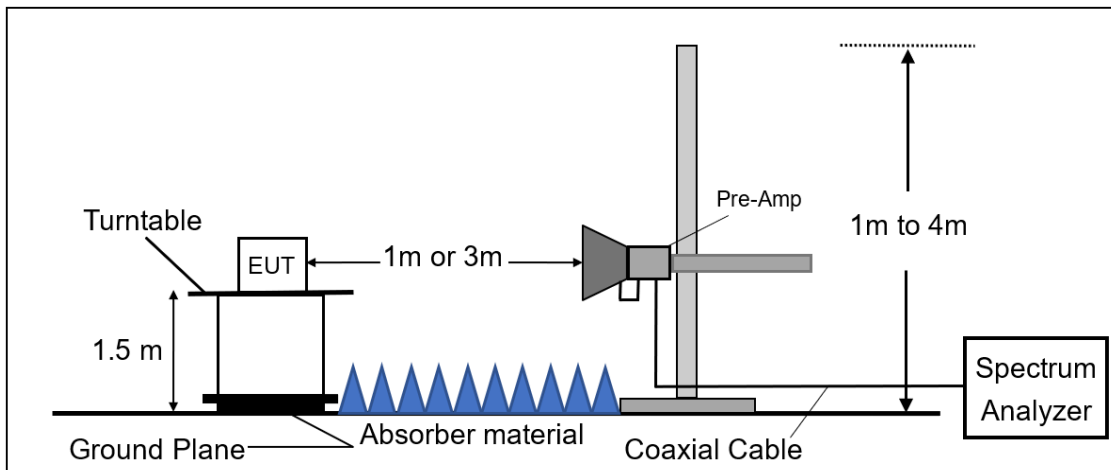

Unless otherwise stated the results shown in this test report refer only to the sample(s) tested and such sample(s) are retained for 90 days only.

除非另有說明，此報告結果僅對測試之樣品負責，同時此樣品僅保留90天。本報告未經本公司書面許可，不可部份複製。

This document is issued by the Company subject to its General Conditions of Service printed overleaf, available on request or accessible at <http://www.sgs.com.tw/Terms-and-Conditions> and for electronic format documents, subject to Terms and Conditions for Electronic Documents at <http://www.sgs.com.tw/Terms-and-Conditions>. Attention is drawn to the limitation of liability, indemnification and jurisdiction issues defined therein. Any holder of this document is advised that information contained hereon reflects the Company's findings at the time of its intervention only and within the limits of Client's instructions, if any. The Company's sole responsibility is to its Client and this document does not exonerate parties to a transaction from exercising all their rights and obligations under the transaction documents. This document cannot be reproduced except in full, without prior written approval of the Company. Any unauthorized alteration, forgery or falsification of the content or appearance of this document is unlawful and offenders may be prosecuted to the fullest extent of the law.

10.3 Measurement Procedure:

The EUT was placed on a non-conductive; the measurement antenna was placed at a distance of 3 meters from the EUT. During the tests, the antenna height and the EUT azimuth were varied in order to identify the maximum level of emissions from the EUT. This maximization process was repeated with the EUT positioned in each of its three orthogonal orientations.

The frequency range up to tenth harmonic was investigated for each of three fundamental frequencies (low, middle and high channels). Once spurious emission was identified, the power of the emission was determined using the substitution method.

The spurious emissions attenuation was calculated as the difference between radiated power at the fundamental frequency and the spurious emissions frequency.

ERP (dBm) = SG Level(dBm) + Antenna Gain(dBd) + Cable Loss(dB)

EIRP (dBm) = SG Level(dBm) + Antenna Gain(dBi) + Cable Loss(dB)

Unless otherwise stated the results shown in this test report refer only to the sample(s) tested and such sample(s) are retained for 90 days only.

除非另有說明，此報告結果僅對測試之樣品負責，同時此樣品僅保留90天。本報告未經本公司書面許可，不可部份複製。

This document is issued by the Company subject to its General Conditions of Service printed overleaf, available on request or accessible at <http://www.sgs.com.tw/Terms-and-Conditions> and for electronic format documents, subject to Terms and Conditions for Electronic Documents at <http://www.sgs.com.tw/Terms-and-Conditions>. Attention is drawn to the limitation of liability, indemnification and jurisdiction issues defined therein. Any holder of this document is advised that information contained hereon reflects the Company's findings at the time of its intervention only and within the limits of Client's instructions, if any. The Company's sole responsibility is to its Client and this document does not exonerate parties to a transaction from exercising all their rights and obligations under the transaction documents. This document cannot be reproduced except in full, without prior written approval of the Company. Any unauthorized alteration, forgery or falsification of the content or appearance of this document is unlawful and offenders may be prosecuted to the fullest extent of the law.

10.4 Measurement Result:

Report Number :ER/2022/30084
 Operation Mode :n2
 Test Mode :Tx CH Low
 EUT Pol :H Plane
 Test Frequency :1857.5 MHz

Test Site :SAC 1
 Test Date :2022-05-11
 Temp./Humi. :20.6/71
 Antenna Pol. :Vertical
 Engineer :GN Lin

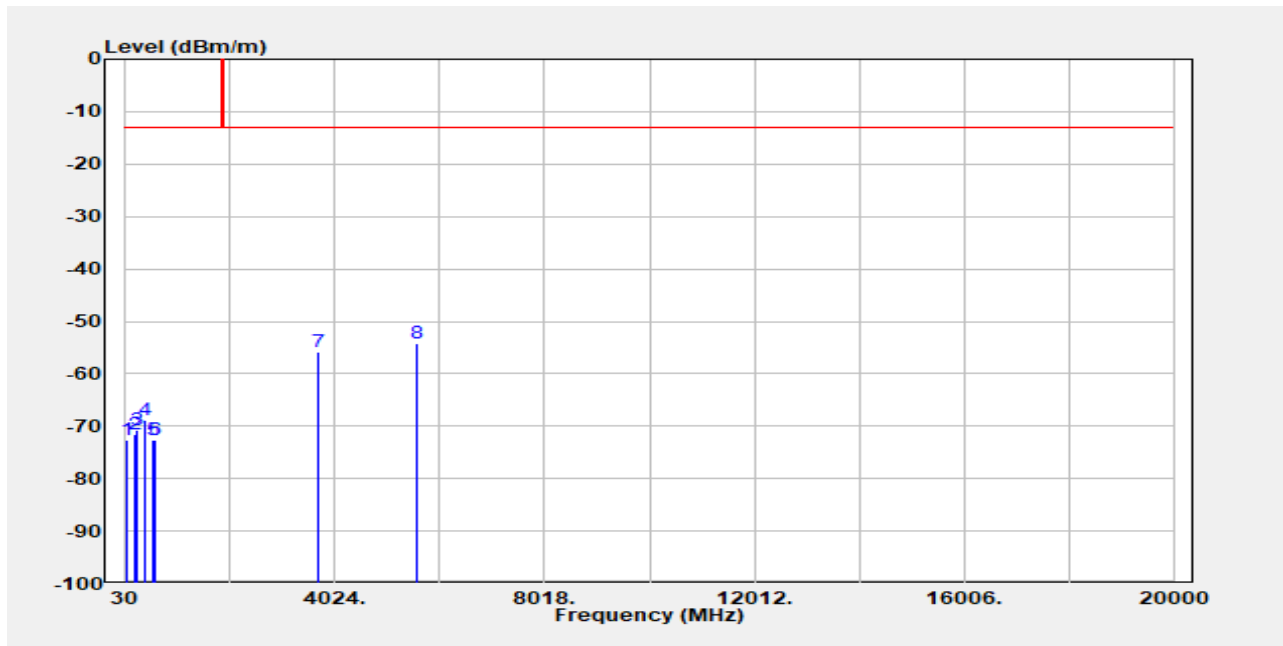

Freq. MHz	EIRP/ERP dBm	SG Output Level dBm	Antenna Gain dBi/dBd	Cable Loss dB	Limit dBm	Margin dB
48.43	-72.57	2.02	-12.13	-0.70	-13.00	-59.57
194.90	-71.57	-3.87	3.88	-1.43	-13.00	-58.57
253.10	-70.60	-2.89	4.32	-1.60	-13.00	-57.60
398.60	-68.79	-2.29	4.32	-2.12	-13.00	-55.79
547.98	-72.60	1.30	4.20	-2.29	-13.00	-59.60
598.42	-72.51	3.77	3.68	-2.64	-13.00	-59.51
3715.00	-55.79	-60.57	12.33	-7.55	-13.00	-42.79
5572.50	-54.07	-57.55	12.95	-9.46	-13.00	-41.07

Unless otherwise stated the results shown in this test report refer only to the sample(s) tested and such sample(s) are retained for 90 days only.

除非另有說明，此報告結果僅對測試之樣品負責，同時此樣品僅保留90天。本報告未經本公司書面許可，不可部份複製。

This document is issued by the Company subject to its General Conditions of Service printed overleaf, available on request or accessible at <http://www.sgs.com.tw/Terms-and-Conditions> and for electronic format documents, subject to Terms and Conditions for Electronic Documents at <http://www.sgs.com.tw/Terms-and-Conditions>. Attention is drawn to the limitation of liability, indemnification and jurisdiction issues defined therein. Any holder of this document is advised that information contained hereon reflects the Company's findings at the time of its intervention only and within the limits of Client's instructions, if any. The Company's sole responsibility is to its Client and this document does not exonerate parties to a transaction from exercising all their rights and obligations under the transaction documents. This document cannot be reproduced except in full, without prior written approval of the Company. Any unauthorized alteration, forgery or falsification of the content or appearance of this document is unlawful and offenders may be prosecuted to the fullest extent of the law.

Report Number :ER/2022/30084
 Operation Mode :n2
 Test Mode :Tx CH Low
 EUT Pol :H Plane
 Test Frequency :1857.5 MHz

Test Site :SAC 1
 Test Date :2022-05-11
 Temp./Humi. :20.6/71
 Antenna Pol. :Horizontal
 Engineer :GN Lin

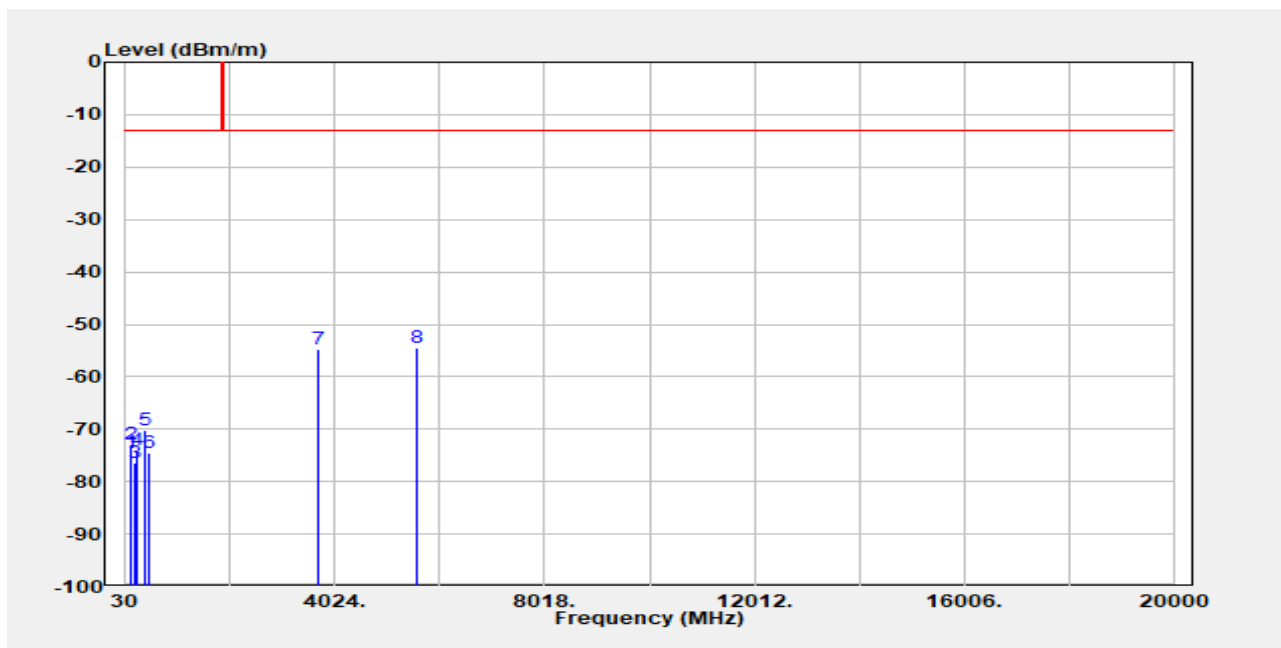

Freq. MHz	EIRP/ERP dBm	SG Output Level dBm	Antenna Gain dBi/dBd	Cable Loss dB	Limit dBm	Margin dB
118.27	-74.47	-71.63	-1.72	-1.12	-13.00	-61.47
127.00	-72.95	-69.74	-2.04	-1.16	-13.00	-59.95
195.87	-76.36	-78.93	4.01	-1.43	-13.00	-63.36
252.13	-74.03	-76.76	4.33	-1.60	-13.00	-61.03
397.63	-70.27	-72.48	4.32	-2.11	-13.00	-57.27
480.08	-74.40	-76.17	4.21	-2.44	-13.00	-61.40
3715.00	-54.67	-59.45	12.33	-7.55	-13.00	-41.67
5572.50	-54.36	-57.85	12.95	-9.46	-13.00	-41.36

Unless otherwise stated the results shown in this test report refer only to the sample(s) tested and such sample(s) are retained for 90 days only.

除非另有說明，此報告結果僅對測試之樣品負責，同時此樣品僅保留90天。本報告未經本公司書面許可，不可部份複製。

This document is issued by the Company subject to its General Conditions of Service printed overleaf, available on request or accessible at <http://www.sgs.com.tw/Terms-and-Conditions> and for electronic format documents, subject to Terms and Conditions for Electronic Documents at <http://www.sgs.com.tw/Terms-and-Conditions>. Attention is drawn to the limitation of liability, indemnification and jurisdiction issues defined therein. Any holder of this document is advised that information contained hereon reflects the Company's findings at the time of its intervention only and within the limits of Client's instructions, if any. The Company's sole responsibility is to its Client and this document does not exonerate parties to a transaction from exercising all their rights and obligations under the transaction documents. This document cannot be reproduced except in full, without prior written approval of the Company. Any unauthorized alteration, forgery or falsification of the content or appearance of this document is unlawful and offenders may be prosecuted to the fullest extent of the law.

Report Number :ER/2022/30084
 Operation Mode :n2
 Test Mode :Tx CH Mid
 EUT Pol :H Plane
 Test Frequency :1880 MHz

Test Site :SAC 1
 Test Date :2022-05-11
 Temp./Humi. :20.6/71
 Antenna Pol. :Vertical
 Engineer :GN Lin

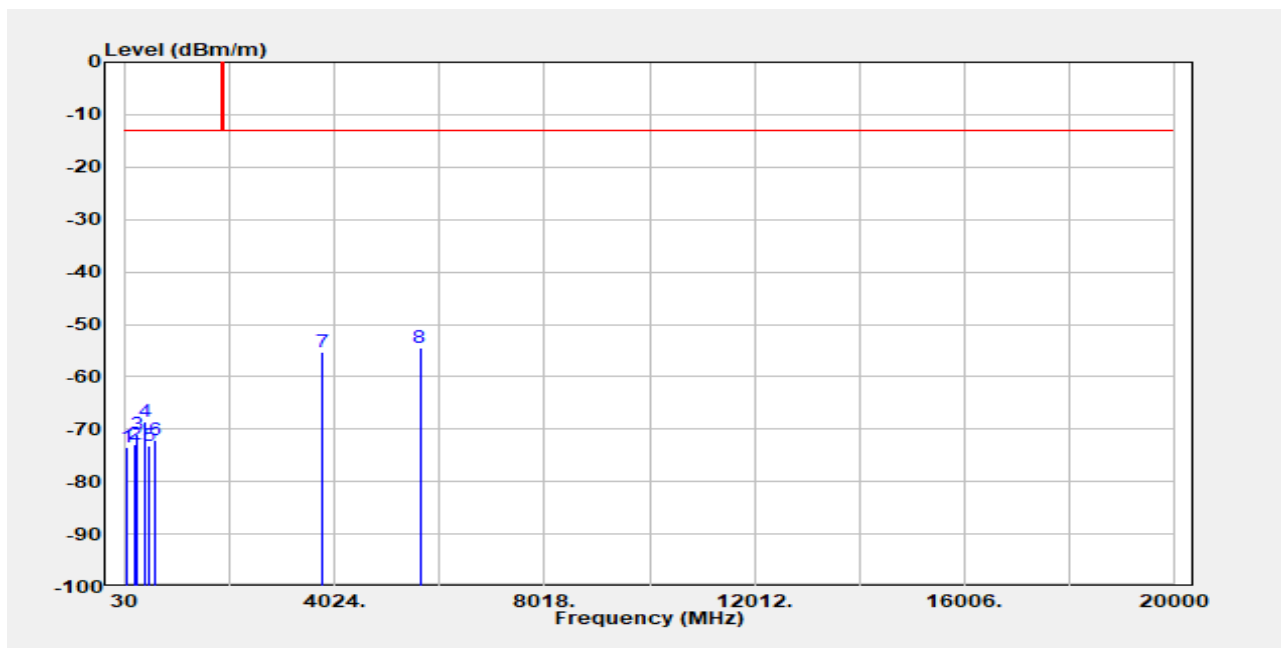

Freq. MHz	EIRP/ERP dBm	SG Output Level dBm	Antenna Gain dBi/dBd	Cable Loss dB	Limit dBm	Margin dB
48.43	-73.51	-60.68	-12.13	-0.70	-13.00	-60.51
194.90	-72.89	-75.33	3.88	-1.43	-13.00	-59.89
253.10	-71.08	-73.80	4.32	-1.60	-13.00	-58.08
394.72	-68.68	-70.91	4.32	-2.08	-13.00	-55.68
480.08	-73.19	-74.95	4.21	-2.44	-13.00	-60.19
601.33	-72.12	-73.13	3.64	-2.63	-13.00	-59.12
3760.00	-55.36	-60.12	12.40	-7.63	-13.00	-42.36
5640.00	-54.37	-58.14	13.00	-9.23	-13.00	-41.37

Unless otherwise stated the results shown in this test report refer only to the sample(s) tested and such sample(s) are retained for 90 days only.

除非另有說明，此報告結果僅對測試之樣品負責，同時此樣品僅保留90天。本報告未經本公司書面許可，不可部份複製。

This document is issued by the Company subject to its General Conditions of Service printed overleaf, available on request or accessible at <http://www.sgs.com.tw/Terms-and-Conditions> and for electronic format documents, subject to Terms and Conditions for Electronic Documents at <http://www.sgs.com.tw/Terms-and-Conditions>. Attention is drawn to the limitation of liability, indemnification and jurisdiction issues defined therein. Any holder of this document is advised that information contained hereon reflects the Company's findings at the time of its intervention only and within the limits of Client's instructions, if any. The Company's sole responsibility is to its Client and this document does not exonerate parties to a transaction from exercising all their rights and obligations under the transaction documents. This document cannot be reproduced except in full, without prior written approval of the Company. Any unauthorized alteration, forgery or falsification of the content or appearance of this document is unlawful and offenders may be prosecuted to the fullest extent of the law.

Report Number :ER/2022/30084
 Operation Mode :n2
 Test Mode :Tx CH Mid
 EUT Pol :H Plane
 Test Frequency :1880 MHz

Test Site :SAC 1
 Test Date :2022-05-11
 Temp./Humi. :20.6/71
 Antenna Pol. :Horizontal
 Engineer :GN Lin

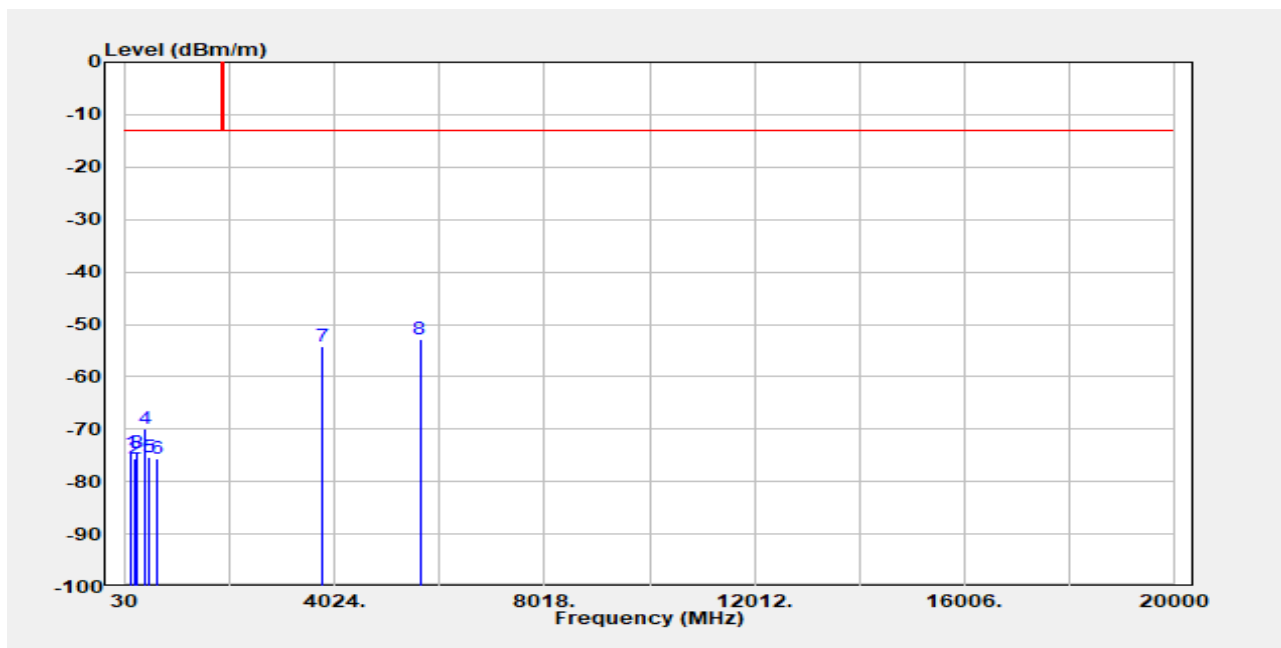

Freq. MHz	EIRP/ERP dBm	SG Output Level dBm	Antenna Gain dBi/dBd	Cable Loss dB	Limit dBm	Margin dB
117.30	-74.56	-71.71	-1.73	-1.11	-13.00	-61.56
192.96	-75.49	-77.74	3.69	-1.43	-13.00	-62.49
252.13	-74.55	-77.28	4.33	-1.60	-13.00	-61.55
397.63	-69.95	-72.16	4.32	-2.11	-13.00	-56.95
480.08	-75.36	-77.12	4.21	-2.44	-13.00	-62.36
639.16	-75.61	-76.92	3.49	-2.18	-13.00	-62.61
3760.00	-54.20	-58.97	12.40	-7.63	-13.00	-41.20
5640.00	-52.83	-56.60	13.00	-9.23	-13.00	-39.83

Unless otherwise stated the results shown in this test report refer only to the sample(s) tested and such sample(s) are retained for 90 days only.

除非另有說明，此報告結果僅對測試之樣品負責，同時此樣品僅保留90天。本報告未經本公司書面許可，不可部份複製。

This document is issued by the Company subject to its General Conditions of Service printed overleaf, available on request or accessible at <http://www.sgs.com.tw/Terms-and-Conditions> and for electronic format documents, subject to Terms and Conditions for Electronic Documents at <http://www.sgs.com.tw/Terms-and-Conditions>. Attention is drawn to the limitation of liability, indemnification and jurisdiction issues defined therein. Any holder of this document is advised that information contained hereon reflects the Company's findings at the time of its intervention only and within the limits of Client's instructions, if any. The Company's sole responsibility is to its Client and this document does not exonerate parties to a transaction from exercising all their rights and obligations under the transaction documents. This document cannot be reproduced except in full, without prior written approval of the Company. Any unauthorized alteration, forgery or falsification of the content or appearance of this document is unlawful and offenders may be prosecuted to the fullest extent of the law.

Report Number :ER/2022/30084
 Operation Mode :n2
 Test Mode :Tx CH High
 EUT Pol :H Plane
 Test Frequency :1902.5 MHz

Test Site :SAC 1
 Test Date :2022-05-11
 Temp./Humi. :20.6/71
 Antenna Pol. :Vertical
 Engineer :GN Lin

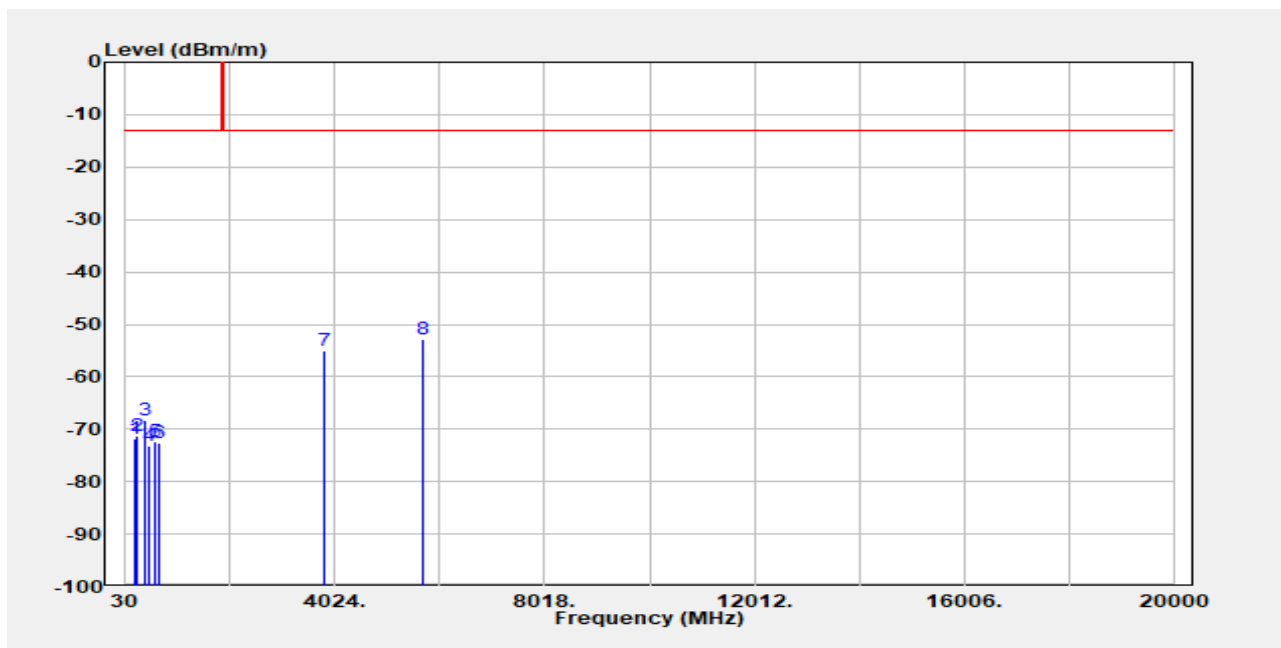

Freq. MHz	EIRP/ERP dBm	SG Output Level dBm	Antenna Gain dBi/dBd	Cable Loss dB	Limit dBm	Margin dB
195.87	-71.89	-74.46	4.01	-1.43	-13.00	-58.89
252.13	-71.22	-73.95	4.33	-1.60	-13.00	-58.22
396.66	-68.18	-70.39	4.32	-2.10	-13.00	-55.18
480.08	-73.06	-74.82	4.21	-2.44	-13.00	-60.06
597.45	-72.42	-73.48	3.71	-2.65	-13.00	-59.42
656.62	-72.56	-73.79	3.63	-2.40	-13.00	-59.56
3805.00	-54.99	-59.69	12.39	-7.69	-13.00	-41.99
5707.50	-52.71	-56.43	12.80	-9.09	-13.00	-39.71

Unless otherwise stated the results shown in this test report refer only to the sample(s) tested and such sample(s) are retained for 90 days only.

除非另有說明，此報告結果僅對測試之樣品負責，同時此樣品僅保留90天。本報告未經本公司書面許可，不可部份複製。

This document is issued by the Company subject to its General Conditions of Service printed overleaf, available on request or accessible at <http://www.sgs.com.tw/Terms-and-Conditions> and for electronic format documents, subject to Terms and Conditions for Electronic Documents at <http://www.sgs.com.tw/Terms-and-Conditions>. Attention is drawn to the limitation of liability, indemnification and jurisdiction issues defined therein. Any holder of this document is advised that information contained hereon reflects the Company's findings at the time of its intervention only and within the limits of Client's instructions, if any. The Company's sole responsibility is to its Client and this document does not exonerate parties to a transaction from exercising all their rights and obligations under the transaction documents. This document cannot be reproduced except in full, without prior written approval of the Company. Any unauthorized alteration, forgery or falsification of the content or appearance of this document is unlawful and offenders may be prosecuted to the fullest extent of the law.

Report Number :ER/2022/30084
 Operation Mode :n2
 Test Mode :Tx CH High
 EUT Pol :H Plane
 Test Frequency :1902.5 MHz

Test Site :SAC 1
 Test Date :2022-05-11
 Temp./Humi. :20.6/71
 Antenna Pol. :Horizontal
 Engineer :GN Lin

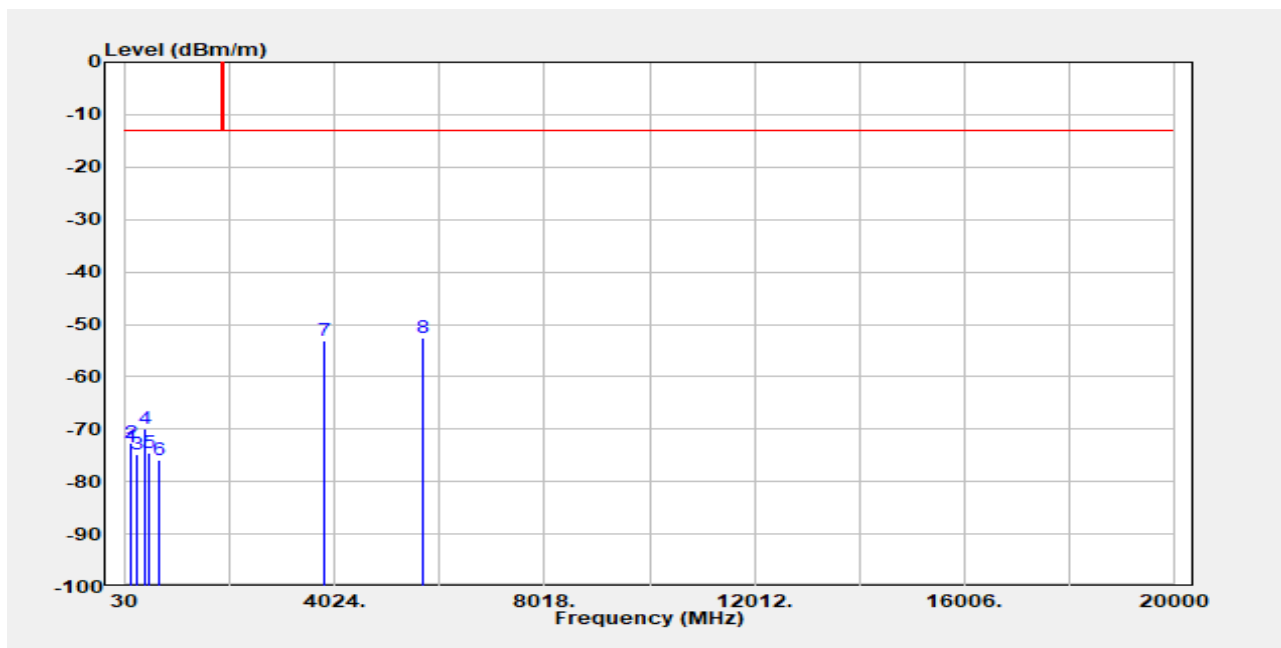

Freq. MHz	EIRP/ERP dBm	SG Output Level dBm	Antenna Gain dBi/dBd	Cable Loss dB	Limit dBm	Margin dB
119.24	-73.36	-70.42	-1.82	-1.12	-13.00	-60.36
128.94	-72.72	-69.55	-2.00	-1.17	-13.00	-59.72
252.13	-74.69	-77.42	4.33	-1.60	-13.00	-61.69
396.66	-69.96	-72.17	4.32	-2.10	-13.00	-56.96
480.08	-74.61	-76.38	4.21	-2.44	-13.00	-61.61
680.87	-75.96	-76.92	3.82	-2.86	-13.00	-62.96
3805.00	-53.25	-57.95	12.39	-7.69	-13.00	-40.25
5707.50	-52.61	-56.32	12.80	-9.09	-13.00	-39.61

Unless otherwise stated the results shown in this test report refer only to the sample(s) tested and such sample(s) are retained for 90 days only.

除非另有說明，此報告結果僅對測試之樣品負責，同時此樣品僅保留90天。本報告未經本公司書面許可，不可部份複製。

This document is issued by the Company subject to its General Conditions of Service printed overleaf, available on request or accessible at <http://www.sgs.com.tw/Terms-and-Conditions> and for electronic format documents, subject to Terms and Conditions for Electronic Documents at <http://www.sgs.com.tw/Terms-and-Conditions>. Attention is drawn to the limitation of liability, indemnification and jurisdiction issues defined therein. Any holder of this document is advised that information contained hereon reflects the Company's findings at the time of its intervention only and within the limits of Client's instructions, if any. The Company's sole responsibility is to its Client and this document does not exonerate parties to a transaction from exercising all their rights and obligations under the transaction documents. This document cannot be reproduced except in full, without prior written approval of the Company. Any unauthorized alteration, forgery or falsification of the content or appearance of this document is unlawful and offenders may be prosecuted to the fullest extent of the law.

Report Number :ER/2022/30084
 Operation Mode :n5
 Test Mode :Tx CH Low
 EUT Pol :H Plane
 Test Frequency :831.5 MHz

Test Site :SAC 1
 Test Date :2022-05-11
 Temp./Humi. :20.6/71
 Antenna Pol. :Vertical
 Engineer :GN Lin

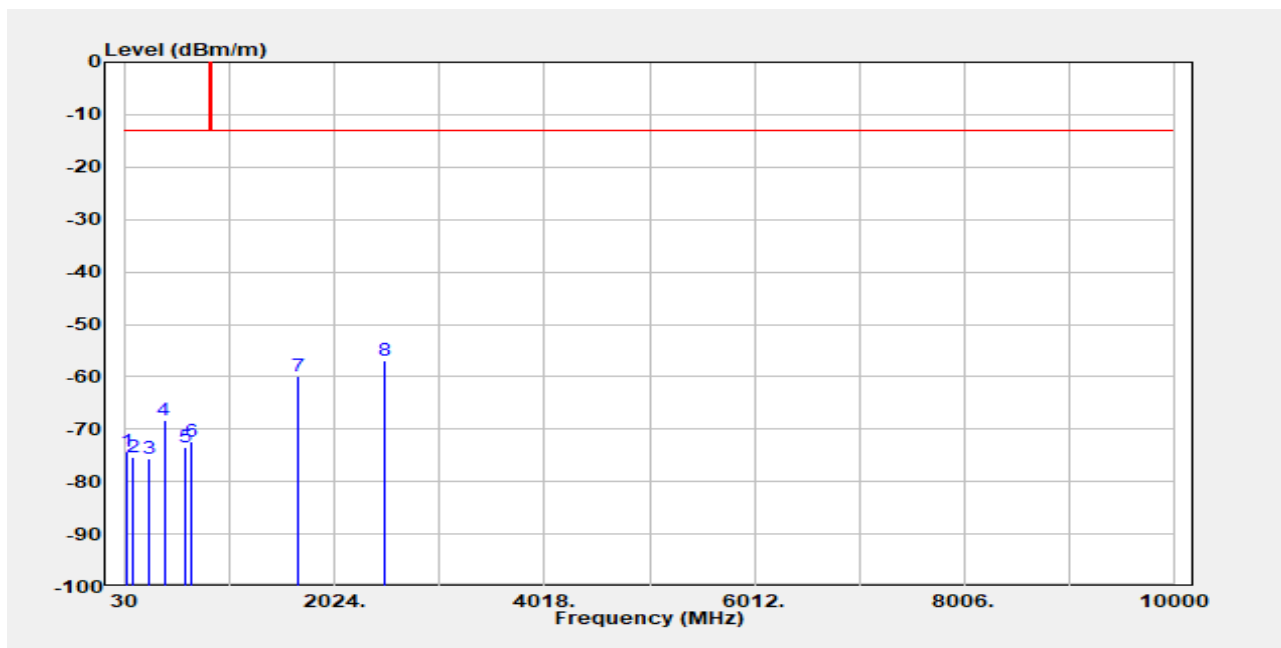

Freq. MHz	EIRP/ERP dBm	SG Output Level dBm	Antenna Gain dBi/dBd	Cable Loss dB	Limit dBm	Margin dB
48.43	-74.32	-61.49	-12.13	-0.70	-13.00	-61.32
103.72	-75.35	-73.24	-1.07	-1.03	-13.00	-62.35
252.13	-75.71	-78.44	4.33	-1.60	-13.00	-62.71
396.66	-68.19	-70.40	4.32	-2.10	-13.00	-55.19
591.63	-73.32	-74.46	3.79	-2.65	-13.00	-60.32
652.74	-72.47	-73.66	3.62	-2.43	-13.00	-59.47
1663.00	-59.97	-65.22	9.53	-4.27	-13.00	-46.97
2494.50	-56.80	-62.21	10.59	-5.18	-13.00	-43.80

Unless otherwise stated the results shown in this test report refer only to the sample(s) tested and such sample(s) are retained for 90 days only.

除非另有說明，此報告結果僅對測試之樣品負責，同時此樣品僅保留90天。本報告未經本公司書面許可，不可部份複製。

This document is issued by the Company subject to its General Conditions of Service printed overleaf, available on request or accessible at <http://www.sgs.com.tw/Terms-and-Conditions> and for electronic format documents, subject to Terms and Conditions for Electronic Documents at <http://www.sgs.com.tw/Terms-and-Conditions>. Attention is drawn to the limitation of liability, indemnification and jurisdiction issues defined therein. Any holder of this document is advised that information contained hereon reflects the Company's findings at the time of its intervention only and within the limits of Client's instructions, if any. The Company's sole responsibility is to its Client and this document does not exonerate parties to a transaction from exercising all their rights and obligations under the transaction documents. This document cannot be reproduced except in full, without prior written approval of the Company. Any unauthorized alteration, forgery or falsification of the content or appearance of this document is unlawful and offenders may be prosecuted to the fullest extent of the law.

Report Number :ER/2022/30084
 Operation Mode :n5
 Test Mode :Tx CH Low
 EUT Pol :H Plane
 Test Frequency :831.5 MHz

Test Site :SAC 1
 Test Date :2022-05-11
 Temp./Humi. :20.6/71
 Antenna Pol. :Horizontal
 Engineer :GN Lin

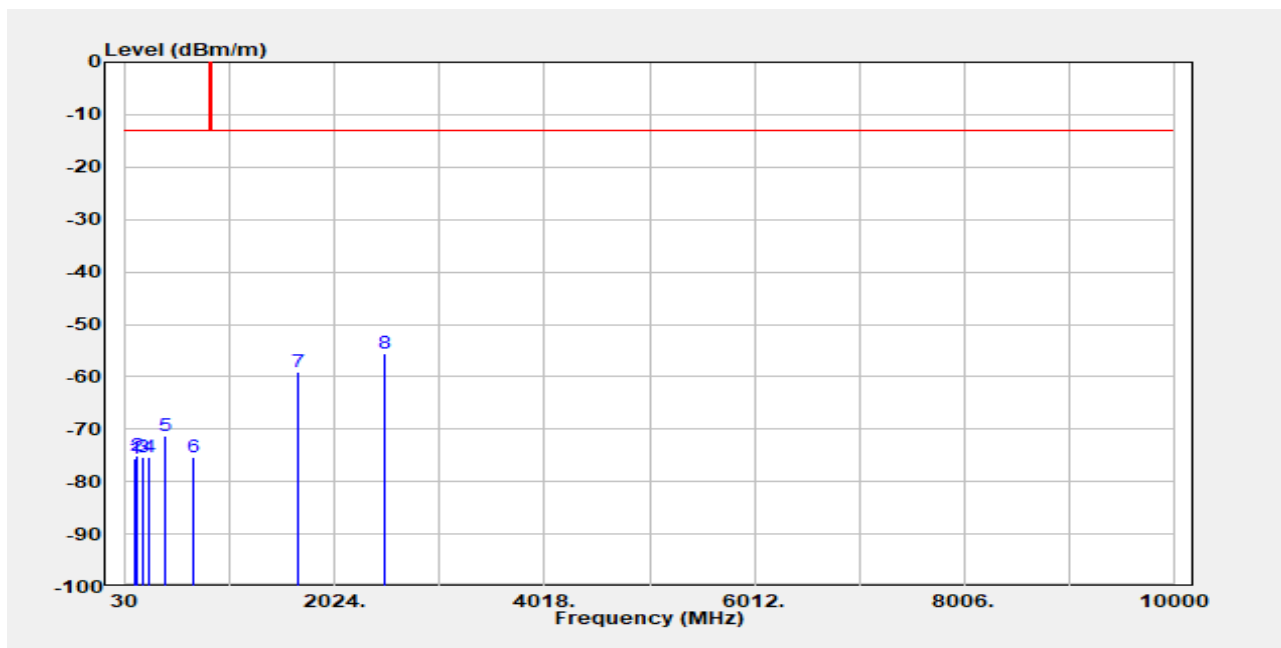

Freq. MHz	EIRP/ERP dBm	SG Output Level dBm	Antenna Gain dBi/dBd	Cable Loss dB	Limit dBm	Margin dB
116.33	-75.71	-73.00	-1.61	-1.10	-13.00	-62.71
130.88	-75.06	-71.88	-1.99	-1.18	-13.00	-62.06
198.78	-75.26	-78.08	4.25	-1.43	-13.00	-62.26
252.13	-75.41	-78.14	4.33	-1.60	-13.00	-62.41
397.63	-71.34	-73.54	4.32	-2.11	-13.00	-58.34
672.14	-75.34	-75.99	3.77	-3.12	-13.00	-62.34
1663.00	-59.18	-64.43	9.53	-4.27	-13.00	-46.18
2494.50	-55.52	-60.93	10.59	-5.18	-13.00	-42.52

Unless otherwise stated the results shown in this test report refer only to the sample(s) tested and such sample(s) are retained for 90 days only.

除非另有說明，此報告結果僅對測試之樣品負責，同時此樣品僅保留90天。本報告未經本公司書面許可，不可部份複製。

This document is issued by the Company subject to its General Conditions of Service printed overleaf, available on request or accessible at <http://www.sgs.com.tw/Terms-and-Conditions> and for electronic format documents, subject to Terms and Conditions for Electronic Documents at <http://www.sgs.com.tw/Terms-and-Conditions>. Attention is drawn to the limitation of liability, indemnification and jurisdiction issues defined therein. Any holder of this document is advised that information contained hereon reflects the Company's findings at the time of its intervention only and within the limits of Client's instructions, if any. The Company's sole responsibility is to its Client and this document does not exonerate parties to a transaction from exercising all their rights and obligations under the transaction documents. This document cannot be reproduced except in full, without prior written approval of the Company. Any unauthorized alteration, forgery or falsification of the content or appearance of this document is unlawful and offenders may be prosecuted to the fullest extent of the law.

Report Number :ER/2022/30084
 Operation Mode :n5
 Test Mode :Tx CH Mid
 EUT Pol :H Plane
 Test Frequency :836.5 MHz

Test Site :SAC 1
 Test Date :2022-05-11
 Temp./Humi. :20.6/71
 Antenna Pol. :Vertical
 Engineer :GN Lin

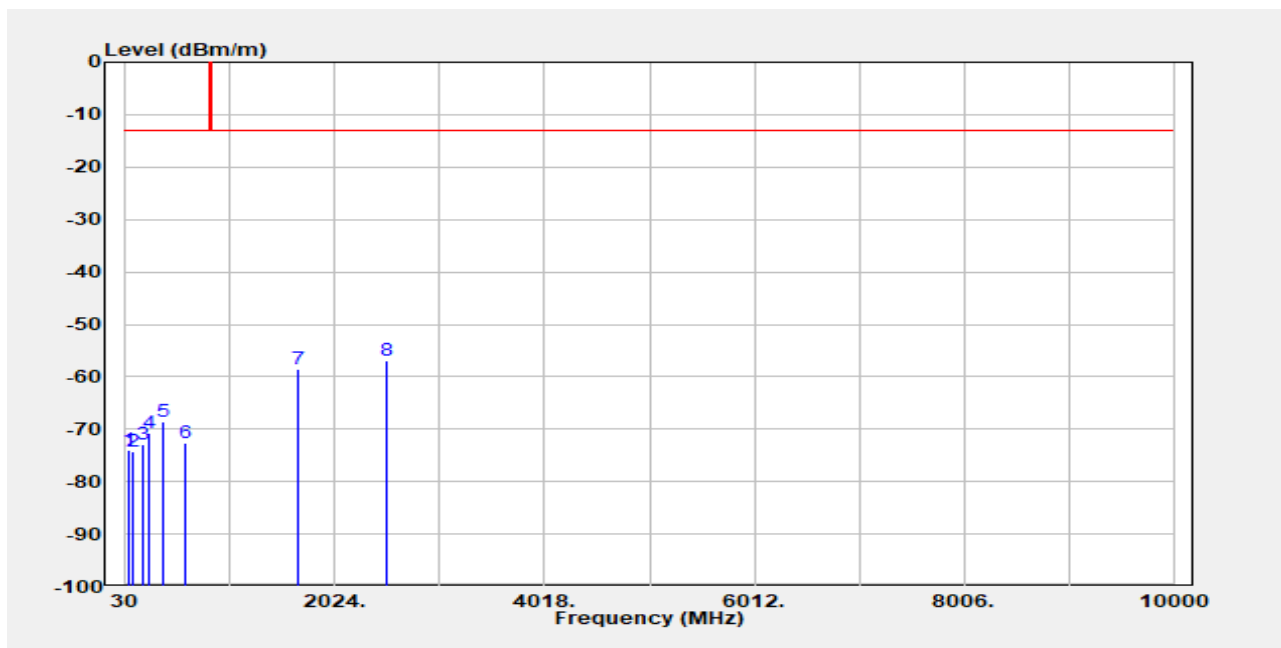

Freq. MHz	EIRP/ERP dBm	SG Output Level dBm	Antenna Gain dBi/dBd	Cable Loss dB	Limit dBm	Margin dB
52.31	-74.09	-62.10	-11.28	-0.71	-13.00	-61.09
103.72	-74.39	-72.28	-1.07	-1.03	-13.00	-61.39
192.96	-72.90	-75.15	3.69	-1.43	-13.00	-59.90
253.10	-70.66	-73.38	4.32	-1.60	-13.00	-57.66
394.72	-68.47	-70.70	4.32	-2.08	-13.00	-55.47
602.30	-72.51	-73.53	3.63	-2.61	-13.00	-59.51
1673.00	-58.45	-63.70	9.55	-4.29	-13.00	-45.45
2509.50	-56.92	-62.35	10.62	-5.20	-13.00	-43.92

Unless otherwise stated the results shown in this test report refer only to the sample(s) tested and such sample(s) are retained for 90 days only.

除非另有說明，此報告結果僅對測試之樣品負責，同時此樣品僅保留90天。本報告未經本公司書面許可，不可部份複製。

This document is issued by the Company subject to its General Conditions of Service printed overleaf, available on request or accessible at <http://www.sgs.com.tw/Terms-and-Conditions> and for electronic format documents, subject to Terms and Conditions for Electronic Documents at <http://www.sgs.com.tw/Terms-and-Conditions>. Attention is drawn to the limitation of liability, indemnification and jurisdiction issues defined therein. Any holder of this document is advised that information contained hereon reflects the Company's findings at the time of its intervention only and within the limits of Client's instructions, if any. The Company's sole responsibility is to its Client and this document does not exonerate parties to a transaction from exercising all their rights and obligations under the transaction documents. This document cannot be reproduced except in full, without prior written approval of the Company. Any unauthorized alteration, forgery or falsification of the content or appearance of this document is unlawful and offenders may be prosecuted to the fullest extent of the law.

Report Number :ER/2022/30084
 Operation Mode :n5
 Test Mode :Tx CH Mid
 EUT Pol :H Plane
 Test Frequency :836.5 MHz

Test Site :SAC 1
 Test Date :2022-05-11
 Temp./Humi. :20.6/71
 Antenna Pol. :Horizontal
 Engineer :GN Lin

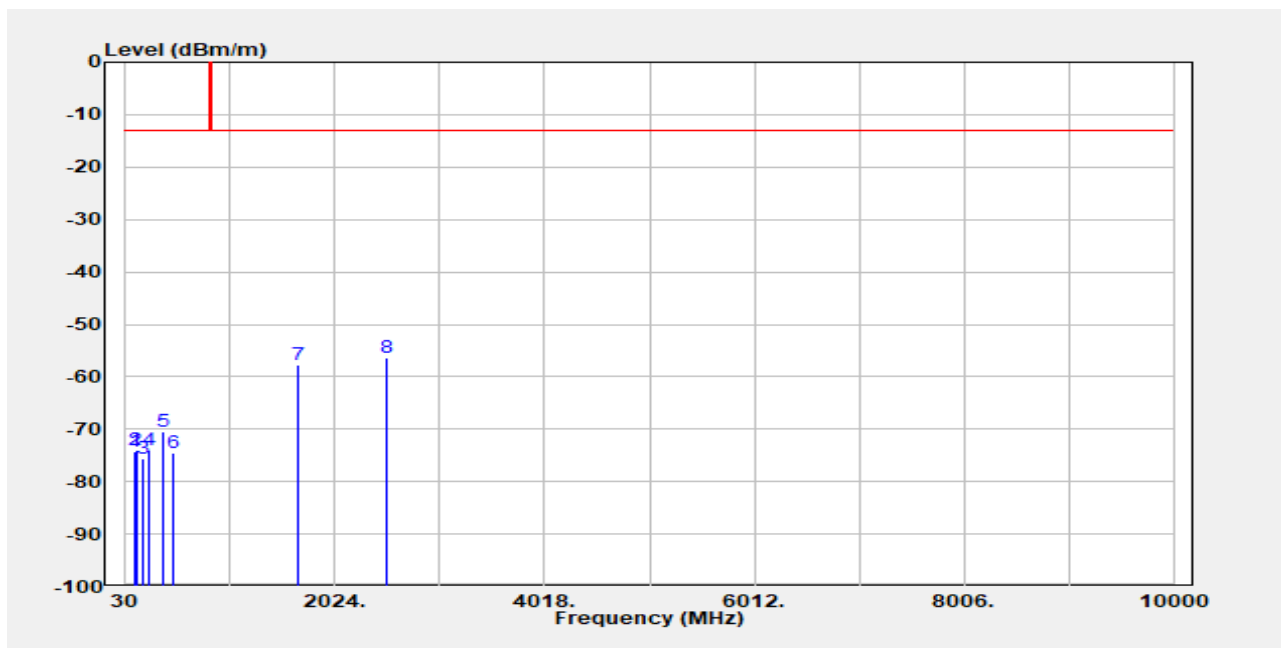

Freq. MHz	EIRP/ERP dBm	SG Output Level dBm	Antenna Gain dBi/dBd	Cable Loss dB	Limit dBm	Margin dB
117.30	-74.21	-71.36	-1.73	-1.11	-13.00	-61.21
127.97	-73.86	-70.82	-1.88	-1.16	-13.00	-60.86
194.90	-75.59	-78.04	3.88	-1.43	-13.00	-62.59
252.13	-73.95	-76.68	4.33	-1.60	-13.00	-60.95
394.72	-70.49	-72.72	4.32	-2.08	-13.00	-57.49
480.08	-74.50	-76.27	4.21	-2.44	-13.00	-61.50
1673.00	-57.73	-62.99	9.55	-4.29	-13.00	-44.73
2509.50	-56.38	-61.80	10.62	-5.20	-13.00	-43.38

Unless otherwise stated the results shown in this test report refer only to the sample(s) tested and such sample(s) are retained for 90 days only.

除非另有說明，此報告結果僅對測試之樣品負責，同時此樣品僅保留90天。本報告未經本公司書面許可，不可部份複製。

This document is issued by the Company subject to its General Conditions of Service printed overleaf, available on request or accessible at <http://www.sgs.com.tw/Terms-and-Conditions> and for electronic format documents, subject to Terms and Conditions for Electronic Documents at <http://www.sgs.com.tw/Terms-and-Conditions>. Attention is drawn to the limitation of liability, indemnification and jurisdiction issues defined therein. Any holder of this document is advised that information contained hereon reflects the Company's findings at the time of its intervention only and within the limits of Client's instructions, if any. The Company's sole responsibility is to its Client and this document does not exonerate parties to a transaction from exercising all their rights and obligations under the transaction documents. This document cannot be reproduced except in full, without prior written approval of the Company. Any unauthorized alteration, forgery or falsification of the content or appearance of this document is unlawful and offenders may be prosecuted to the fullest extent of the law.

Report Number :ER/2022/30084
 Operation Mode :n5
 Test Mode :Tx CH High
 EUT Pol :H Plane
 Test Frequency :841.5 MHz

Test Site :SAC 1
 Test Date :2022-05-11
 Temp./Humi. :20.6/71
 Antenna Pol. :Vertical
 Engineer :GN Lin

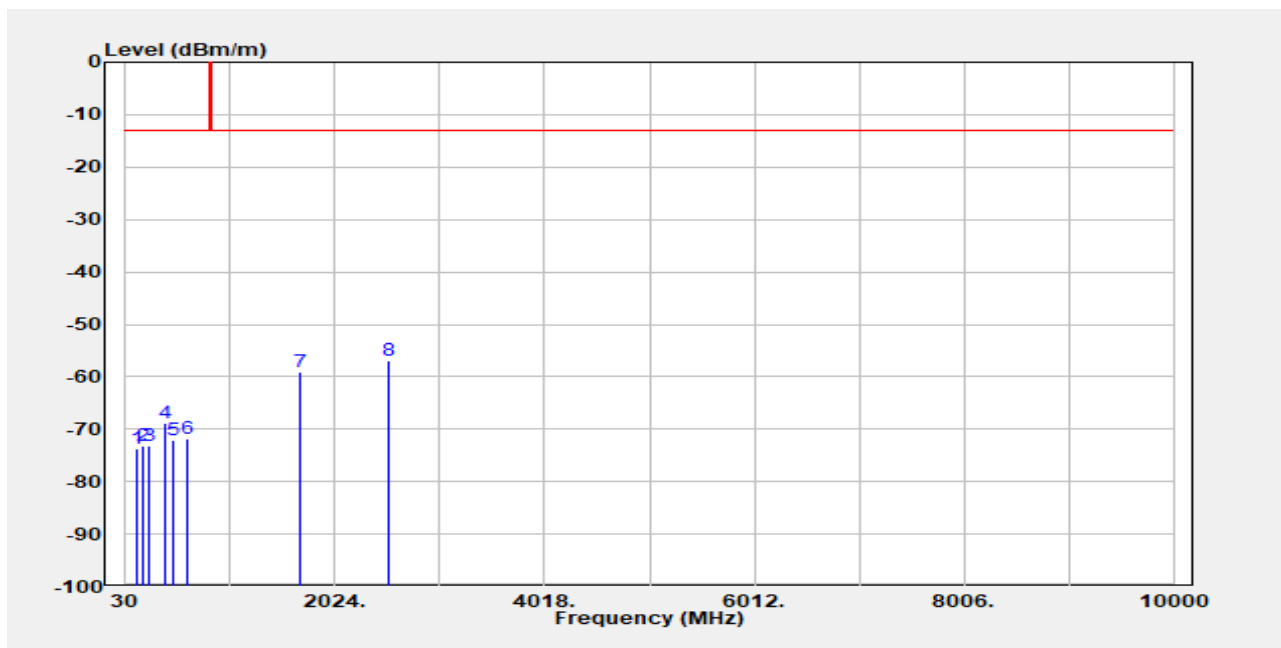

Freq. MHz	EIRP/ERP dBm	SG Output Level dBm	Antenna Gain dBi/dBd	Cable Loss dB	Limit dBm	Margin dB
140.58	-73.77	-70.55	-1.90	-1.31	-13.00	-60.77
196.84	-73.21	-75.84	4.06	-1.43	-13.00	-60.21
256.98	-73.22	-75.93	4.34	-1.63	-13.00	-60.22
399.57	-68.71	-70.90	4.32	-2.13	-13.00	-55.71
480.08	-71.99	-73.75	4.21	-2.44	-13.00	-58.99
618.79	-71.79	-72.91	3.43	-2.31	-13.00	-58.79
1683.00	-59.05	-64.31	9.57	-4.30	-13.00	-46.05
2524.50	-56.95	-62.38	10.65	-5.21	-13.00	-43.95

Unless otherwise stated the results shown in this test report refer only to the sample(s) tested and such sample(s) are retained for 90 days only.

除非另有說明，此報告結果僅對測試之樣品負責，同時此樣品僅保留90天。本報告未經本公司書面許可，不可部份複製。

This document is issued by the Company subject to its General Conditions of Service printed overleaf, available on request or accessible at <http://www.sgs.com.tw/Terms-and-Conditions> and for electronic format documents, subject to Terms and Conditions for Electronic Documents at <http://www.sgs.com.tw/Terms-and-Conditions>. Attention is drawn to the limitation of liability, indemnification and jurisdiction issues defined therein. Any holder of this document is advised that information contained hereon reflects the Company's findings at the time of its intervention only and within the limits of Client's instructions, if any. The Company's sole responsibility is to its Client and this document does not exonerate parties to a transaction from exercising all their rights and obligations under the transaction documents. This document cannot be reproduced except in full, without prior written approval of the Company. Any unauthorized alteration, forgery or falsification of the content or appearance of this document is unlawful and offenders may be prosecuted to the fullest extent of the law.

Report Number :ER/2022/30084
 Operation Mode :n5
 Test Mode :Tx CH High
 EUT Pol :H Plane
 Test Frequency :841.5 MHz

Test Site :SAC 1
 Test Date :2022-05-11
 Temp./Humi. :20.6/71
 Antenna Pol. :Horizontal
 Engineer :GN Lin

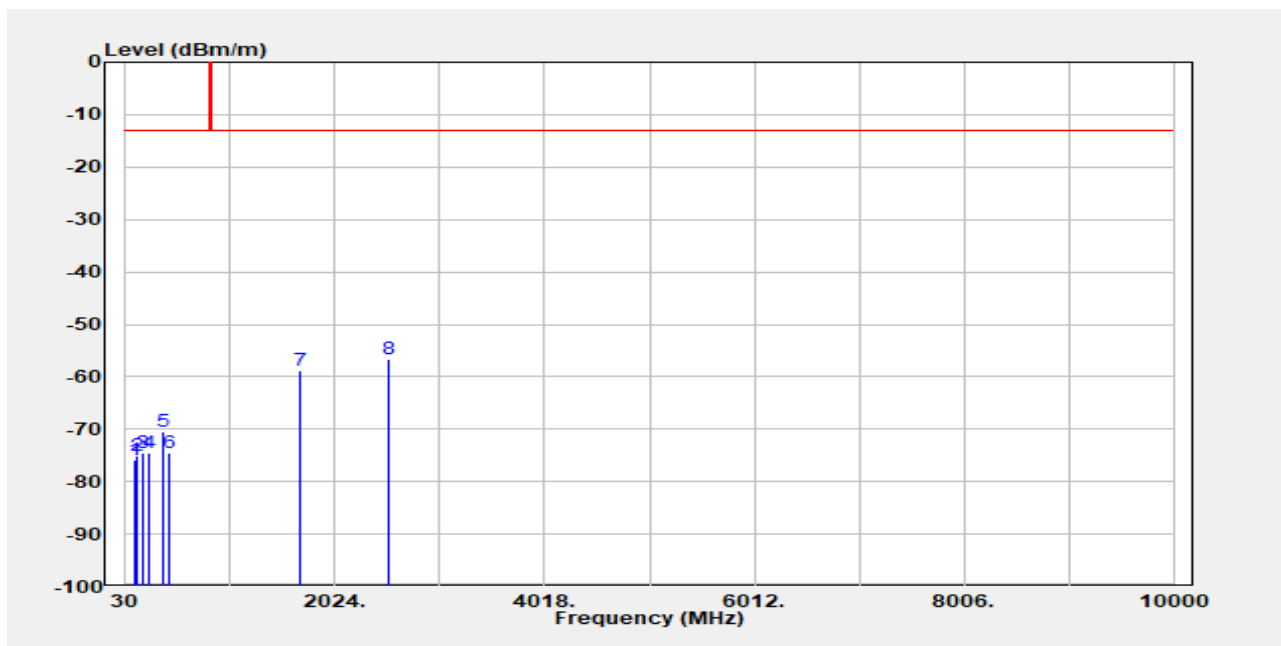

Freq. MHz	EIRP/ERP dBm	SG Output Level dBm	Antenna Gain dBi/dBd	Cable Loss dB	Limit dBm	Margin dB
115.36	-75.89	-73.09	-1.71	-1.10	-13.00	-62.89
130.88	-75.20	-72.03	-1.99	-1.18	-13.00	-62.20
197.81	-74.45	-77.21	4.19	-1.43	-13.00	-61.45
253.10	-74.59	-77.30	4.32	-1.60	-13.00	-61.59
394.72	-70.35	-72.59	4.32	-2.08	-13.00	-57.35
446.13	-74.61	-76.56	4.15	-2.20	-13.00	-61.61
1683.00	-58.82	-64.08	9.57	-4.30	-13.00	-45.82
2524.50	-56.75	-62.18	10.65	-5.21	-13.00	-43.75

Unless otherwise stated the results shown in this test report refer only to the sample(s) tested and such sample(s) are retained for 90 days only.

除非另有說明，此報告結果僅對測試之樣品負責，同時此樣品僅保留90天。本報告未經本公司書面許可，不可部份複製。

This document is issued by the Company subject to its General Conditions of Service printed overleaf, available on request or accessible at <http://www.sgs.com.tw/Terms-and-Conditions> and for electronic format documents, subject to Terms and Conditions for Electronic Documents at <http://www.sgs.com.tw/Terms-and-Conditions>. Attention is drawn to the limitation of liability, indemnification and jurisdiction issues defined therein. Any holder of this document is advised that information contained hereon reflects the Company's findings at the time of its intervention only and within the limits of Client's instructions, if any. The Company's sole responsibility is to its Client and this document does not exonerate parties to a transaction from exercising all their rights and obligations under the transaction documents. This document cannot be reproduced except in full, without prior written approval of the Company. Any unauthorized alteration, forgery or falsification of the content or appearance of this document is unlawful and offenders may be prosecuted to the fullest extent of the law.

Report Number :ER/2022/30084
 Operation Mode :n66
 Test Mode :Tx CH Low
 EUT Pol :H Plane
 Test Frequency :1717.5 MHz

Test Site :SAC 1
 Test Date :2022-05-11
 Temp./Humi. :20.6/71
 Antenna Pol. :Vertical
 Engineer :GN Lin

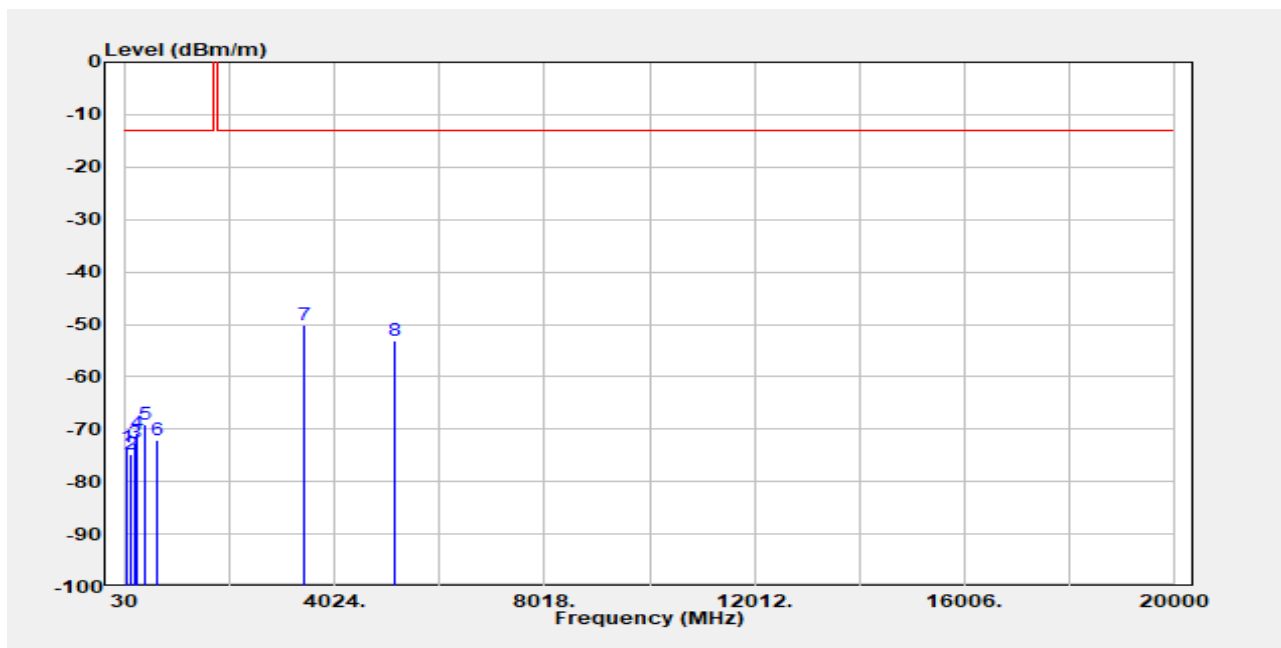

Freq. MHz	EIRP/ERP dBm	SG Output Level dBm	Antenna Gain dBi/dBd	Cable Loss dB	Limit dBm	Margin dB
48.43	-73.52	2.02	-12.13	-0.70	-13.00	-60.52
117.30	-74.73	-0.99	-1.73	-1.11	-13.00	-61.73
195.87	-72.72	-3.88	4.01	-1.43	-13.00	-59.72
252.13	-70.78	-2.91	4.33	-1.60	-13.00	-57.78
396.66	-69.07	-2.40	4.32	-2.10	-13.00	-56.07
615.88	-72.04	3.25	3.45	-2.38	-13.00	-59.04
3435.00	-50.14	-56.76	12.53	-5.91	-13.00	-37.14
5152.50	-53.18	-57.36	12.12	-7.94	-13.00	-40.18

Unless otherwise stated the results shown in this test report refer only to the sample(s) tested and such sample(s) are retained for 90 days only.

除非另有說明，此報告結果僅對測試之樣品負責，同時此樣品僅保留90天。本報告未經本公司書面許可，不可部份複製。

This document is issued by the Company subject to its General Conditions of Service printed overleaf, available on request or accessible at <http://www.sgs.com.tw/Terms-and-Conditions> and for electronic format documents, subject to Terms and Conditions for Electronic Documents at <http://www.sgs.com.tw/Terms-and-Conditions>. Attention is drawn to the limitation of liability, indemnification and jurisdiction issues defined therein. Any holder of this document is advised that information contained hereon reflects the Company's findings at the time of its intervention only and within the limits of Client's instructions, if any. The Company's sole responsibility is to its Client and this document does not exonerate parties to a transaction from exercising all their rights and obligations under the transaction documents. This document cannot be reproduced except in full, without prior written approval of the Company. Any unauthorized alteration, forgery or falsification of the content or appearance of this document is unlawful and offenders may be prosecuted to the fullest extent of the law.

Report Number :ER/2022/30084
 Operation Mode :n66
 Test Mode :Tx CH Low
 EUT Pol :H Plane
 Test Frequency :1717.5 MHz

Test Site :SAC 1
 Test Date :2022-05-11
 Temp./Humi. :20.6/71
 Antenna Pol. :Horizontal
 Engineer :GN Lin

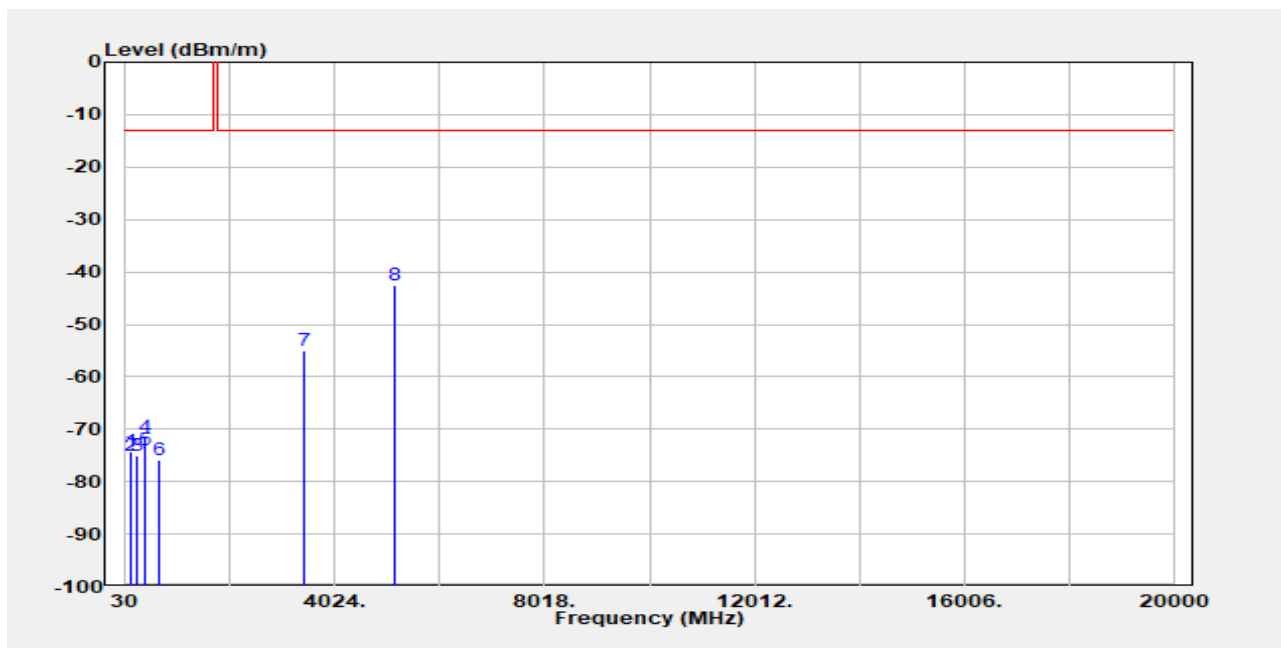

Freq. MHz	EIRP/ERP dBm	SG Output Level dBm	Antenna Gain dBi/dBd	Cable Loss dB	Limit dBm	Margin dB
116.33	-74.23	-71.53	-1.61	-1.10	-13.00	-61.23
130.88	-75.08	-71.90	-1.99	-1.18	-13.00	-62.08
252.13	-75.00	-77.73	4.33	-1.60	-13.00	-62.00
397.63	-71.68	-73.88	4.32	-2.11	-13.00	-58.68
416.06	-74.02	-76.47	4.32	-1.87	-13.00	-61.02
659.53	-75.81	-77.10	3.66	-2.38	-13.00	-62.81
3435.00	-55.10	-61.71	12.53	-5.91	-13.00	-42.10
5152.50	-42.49	-46.67	12.12	-7.94	-13.00	-29.49

Unless otherwise stated the results shown in this test report refer only to the sample(s) tested and such sample(s) are retained for 90 days only.

除非另有說明，此報告結果僅對測試之樣品負責，同時此樣品僅保留90天。本報告未經本公司書面許可，不可部份複製。

This document is issued by the Company subject to its General Conditions of Service printed overleaf, available on request or accessible at <http://www.sgs.com.tw/Terms-and-Conditions> and for electronic format documents, subject to Terms and Conditions for Electronic Documents at <http://www.sgs.com.tw/Terms-and-Conditions>. Attention is drawn to the limitation of liability, indemnification and jurisdiction issues defined therein. Any holder of this document is advised that information contained hereon reflects the Company's findings at the time of its intervention only and within the limits of Client's instructions, if any. The Company's sole responsibility is to its Client and this document does not exonerate parties to a transaction from exercising all their rights and obligations under the transaction documents. This document cannot be reproduced except in full, without prior written approval of the Company. Any unauthorized alteration, forgery or falsification of the content or appearance of this document is unlawful and offenders may be prosecuted to the fullest extent of the law.

Report Number :ER/2022/30084
 Operation Mode :n66
 Test Mode :Tx CH Mid
 EUT Pol :H Plane
 Test Frequency :1745 MHz

Test Site :SAC 1
 Test Date :2022-05-11
 Temp./Humi. :20.6/71
 Antenna Pol. :Vertical
 Engineer :GN Lin

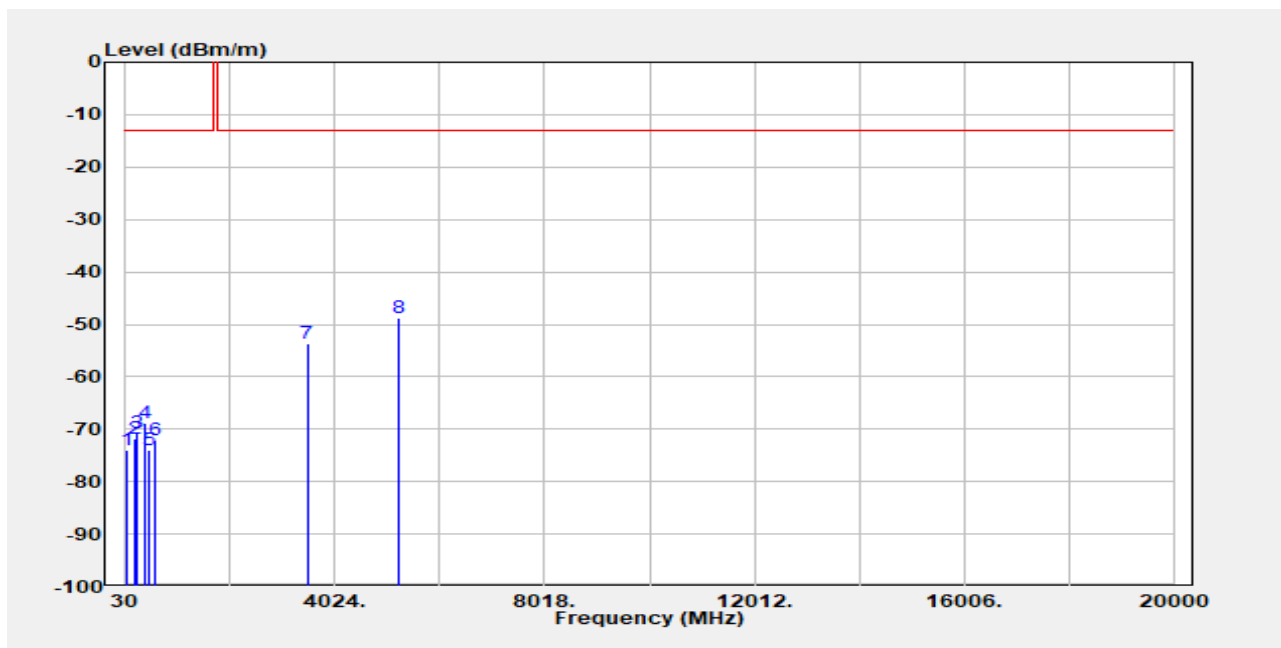

Freq. MHz	EIRP/ERP dBm	SG Output Level dBm	Antenna Gain dBi/dBd	Cable Loss dB	Limit dBm	Margin dB
48.43	-74.00	-61.17	-12.13	-0.70	-13.00	-61.00
196.84	-71.81	-74.44	4.06	-1.43	-13.00	-58.81
253.10	-70.82	-73.54	4.32	-1.60	-13.00	-57.82
397.63	-68.84	-71.05	4.32	-2.11	-13.00	-55.84
480.08	-73.99	-75.75	4.21	-2.44	-13.00	-60.99
601.33	-72.01	-73.02	3.64	-2.63	-13.00	-59.01
3490.00	-53.73	-59.89	12.42	-6.26	-13.00	-40.73
5235.00	-48.71	-53.41	12.68	-7.99	-13.00	-35.71

Unless otherwise stated the results shown in this test report refer only to the sample(s) tested and such sample(s) are retained for 90 days only.

除非另有說明，此報告結果僅對測試之樣品負責，同時此樣品僅保留90天。本報告未經本公司書面許可，不可部份複製。

This document is issued by the Company subject to its General Conditions of Service printed overleaf, available on request or accessible at <http://www.sgs.com.tw/Terms-and-Conditions> and for electronic format documents, subject to Terms and Conditions for Electronic Documents at <http://www.sgs.com.tw/Terms-and-Conditions>. Attention is drawn to the limitation of liability, indemnification and jurisdiction issues defined therein. Any holder of this document is advised that information contained hereon reflects the Company's findings at the time of its intervention only and within the limits of Client's instructions, if any. The Company's sole responsibility is to its Client and this document does not exonerate parties to a transaction from exercising all their rights and obligations under the transaction documents. This document cannot be reproduced except in full, without prior written approval of the Company. Any unauthorized alteration, forgery or falsification of the content or appearance of this document is unlawful and offenders may be prosecuted to the fullest extent of the law.

Report Number :ER/2022/30084
 Operation Mode :n66
 Test Mode :Tx CH Mid
 EUT Pol :H Plane
 Test Frequency :1745 MHz

Test Site :SAC 1
 Test Date :2022-05-11
 Temp./Humi. :20.6/71
 Antenna Pol. :Horizontal
 Engineer :GN Lin

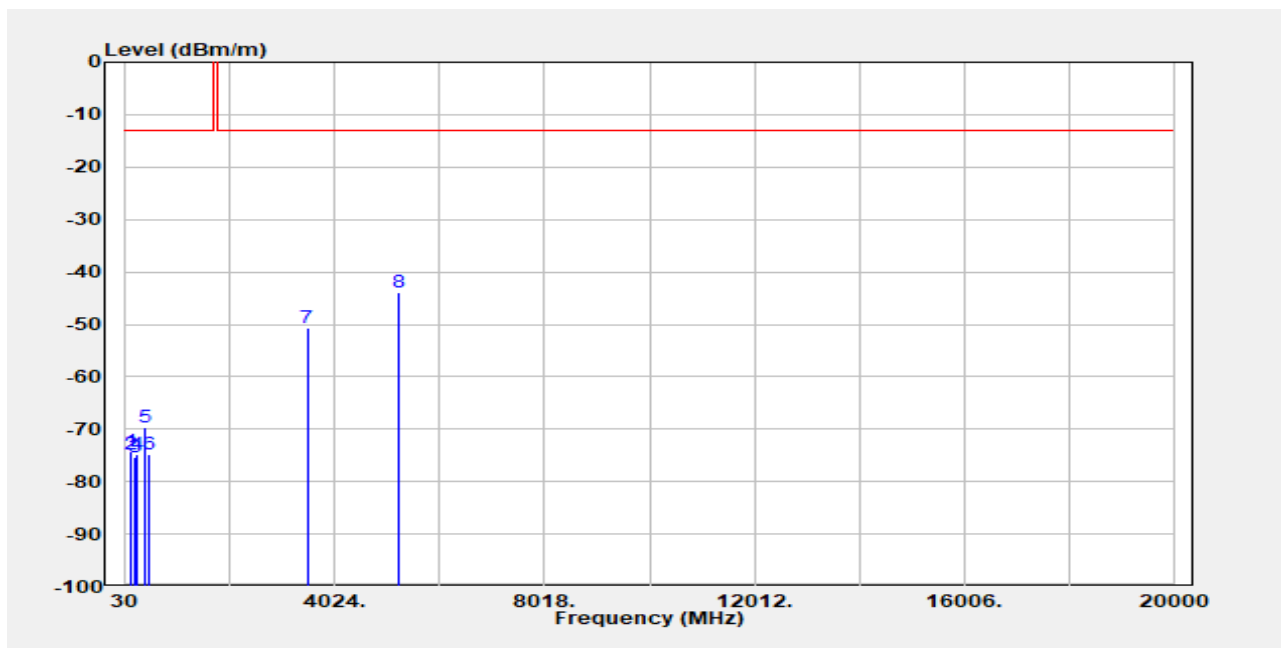

Freq. MHz	EIRP/ERP dBm	SG Output Level dBm	Antenna Gain dBi/dBd	Cable Loss dB	Limit dBm	Margin dB
116.33	-74.32	-71.62	-1.61	-1.10	-13.00	-61.32
127.00	-74.74	-71.54	-2.04	-1.16	-13.00	-61.74
194.90	-75.39	-77.83	3.88	-1.43	-13.00	-62.39
253.10	-74.71	-77.43	4.32	-1.60	-13.00	-61.71
395.69	-69.69	-71.91	4.31	-2.09	-13.00	-56.69
480.08	-74.82	-76.58	4.21	-2.44	-13.00	-61.82
3490.00	-50.61	-56.77	12.42	-6.26	-13.00	-37.61
5235.00	-43.90	-48.60	12.68	-7.99	-13.00	-30.90

Unless otherwise stated the results shown in this test report refer only to the sample(s) tested and such sample(s) are retained for 90 days only.

除非另有說明，此報告結果僅對測試之樣品負責，同時此樣品僅保留90天。本報告未經本公司書面許可，不可部份複製。

This document is issued by the Company subject to its General Conditions of Service printed overleaf, available on request or accessible at <http://www.sgs.com.tw/Terms-and-Conditions> and for electronic format documents, subject to Terms and Conditions for Electronic Documents at <http://www.sgs.com.tw/Terms-and-Conditions>. Attention is drawn to the limitation of liability, indemnification and jurisdiction issues defined therein. Any holder of this document is advised that information contained hereon reflects the Company's findings at the time of its intervention only and within the limits of Client's instructions, if any. The Company's sole responsibility is to its Client and this document does not exonerate parties to a transaction from exercising all their rights and obligations under the transaction documents. This document cannot be reproduced except in full, without prior written approval of the Company. Any unauthorized alteration, forgery or falsification of the content or appearance of this document is unlawful and offenders may be prosecuted to the fullest extent of the law.

Report Number :ER/2022/30084
 Operation Mode :n66
 Test Mode :Tx CH High
 EUT Pol :H Plane
 Test Frequency :1772.5 MHz

Test Site :SAC 1
 Test Date :2022-05-11
 Temp./Humi. :20.6/71
 Antenna Pol. :Vertical
 Engineer :GN Lin

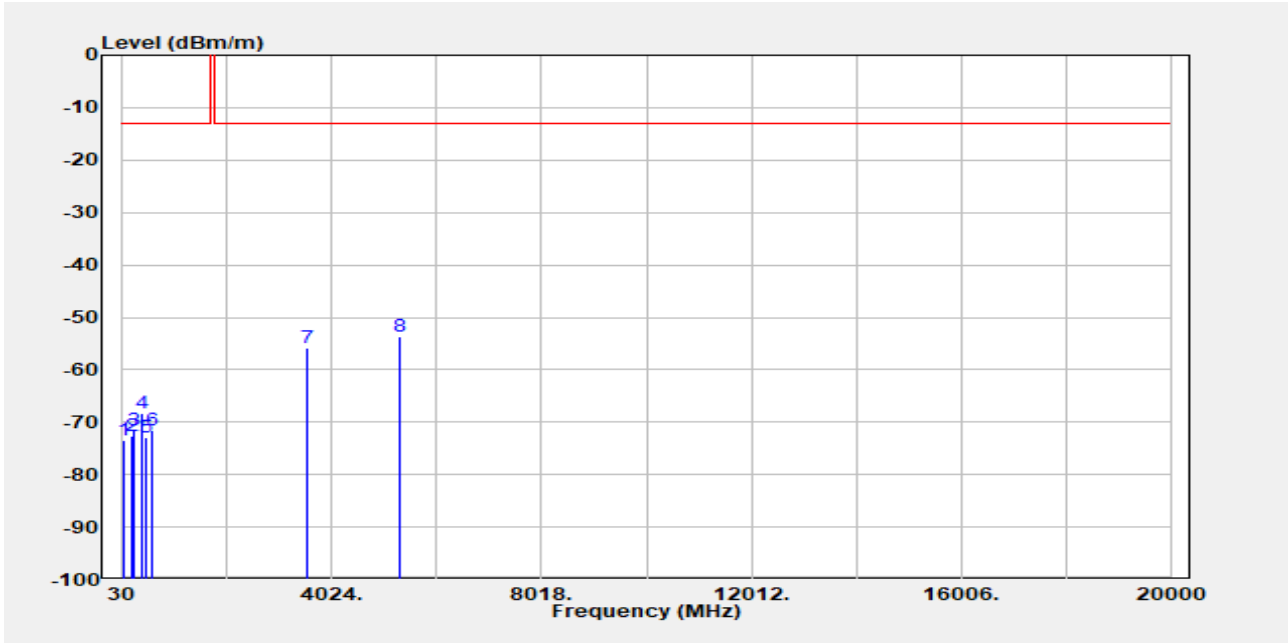

Freq. MHz	EIRP/ERP dBm	SG Output Level dBm	Antenna Gain dBi/dBd	Cable Loss dB	Limit dBm	Margin dB
48.43	-73.47	-60.64	-12.13	-0.70	-13.00	-60.47
194.90	-72.49	-74.94	3.88	-1.43	-13.00	-59.49
251.16	-71.67	-74.40	4.33	-1.59	-13.00	-58.67
398.60	-68.23	-70.43	4.32	-2.12	-13.00	-55.23
480.08	-72.94	-74.70	4.21	-2.44	-13.00	-59.94
590.66	-71.55	-72.69	3.79	-2.65	-13.00	-58.55
3545.00	-55.91	-61.81	12.40	-6.50	-13.00	-42.91
5317.50	-53.53	-58.15	13.00	-8.38	-13.00	-40.53

Unless otherwise stated the results shown in this test report refer only to the sample(s) tested and such sample(s) are retained for 90 days only.

除非另有說明，此報告結果僅對測試之樣品負責，同時此樣品僅保留90天。本報告未經本公司書面許可，不可部份複製。

This document is issued by the Company subject to its General Conditions of Service printed overleaf, available on request or accessible at <http://www.sgs.com.tw/Terms-and-Conditions> and for electronic format documents, subject to Terms and Conditions for Electronic Documents at <http://www.sgs.com.tw/Terms-and-Conditions>. Attention is drawn to the limitation of liability, indemnification and jurisdiction issues defined therein. Any holder of this document is advised that information contained hereon reflects the Company's findings at the time of its intervention only and within the limits of Client's instructions, if any. The Company's sole responsibility is to its Client and this document does not exonerate parties to a transaction from exercising all their rights and obligations under the transaction documents. This document cannot be reproduced except in full, without prior written approval of the Company. Any unauthorized alteration, forgery or falsification of the content or appearance of this document is unlawful and offenders may be prosecuted to the fullest extent of the law.

Report Number :ER/2022/30084
 Operation Mode :n66
 Test Mode :Tx CH High
 EUT Pol :H Plane
 Test Frequency :1772.5 MHz

Test Site :SAC 1
 Test Date :2022-05-11
 Temp./Humi. :20.6/71
 Antenna Pol. :Horizontal
 Engineer :GN Lin

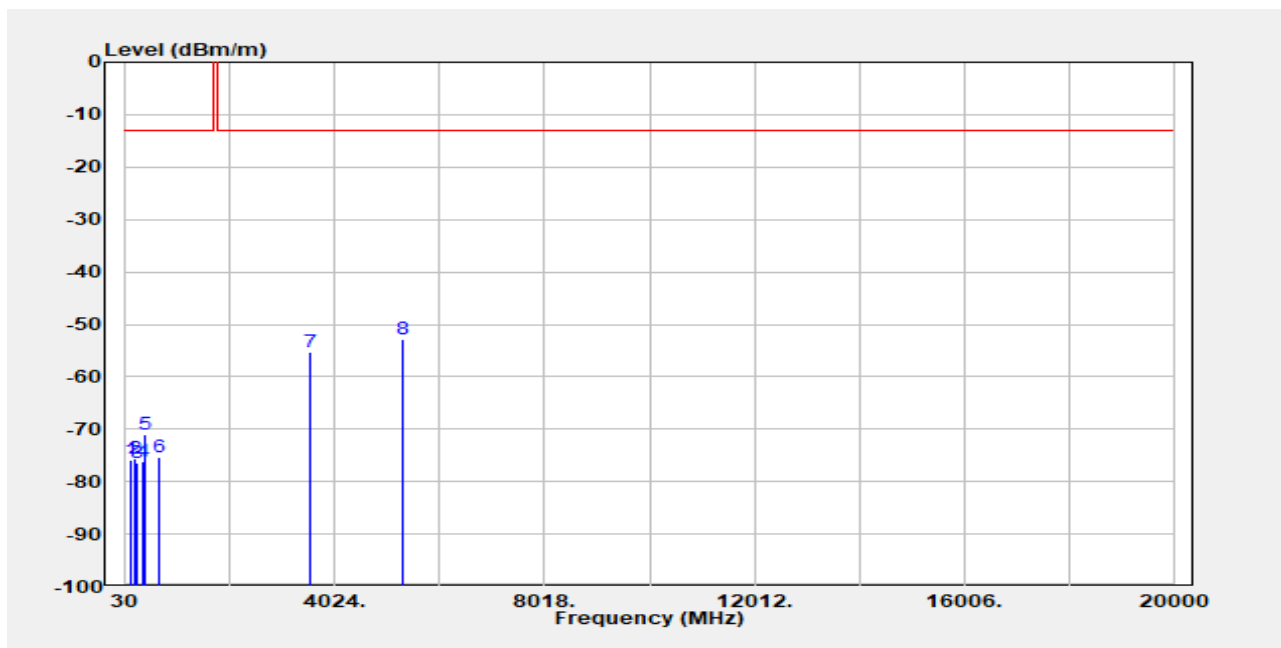

Freq. MHz	EIRP/ERP dBm	SG Output Level dBm	Antenna Gain dBi/dBd	Cable Loss dB	Limit dBm	Margin dB
115.36	-75.75	-72.95	-1.71	-1.10	-13.00	-62.75
196.84	-75.51	-78.14	4.06	-1.43	-13.00	-62.51
252.13	-76.31	-79.04	4.33	-1.60	-13.00	-63.31
348.16	-76.12	-78.63	4.52	-2.01	-13.00	-63.12
397.63	-70.91	-73.12	4.32	-2.11	-13.00	-57.91
664.38	-75.33	-76.33	3.73	-2.73	-13.00	-62.33
3545.00	-55.23	-61.14	12.40	-6.50	-13.00	-42.23
5317.50	-52.94	-57.56	13.00	-8.38	-13.00	-39.94

Unless otherwise stated the results shown in this test report refer only to the sample(s) tested and such sample(s) are retained for 90 days only.

除非另有說明，此報告結果僅對測試之樣品負責，同時此樣品僅保留90天。本報告未經本公司書面許可，不可部份複製。

This document is issued by the Company subject to its General Conditions of Service printed overleaf, available on request or accessible at <http://www.sgs.com.tw/Terms-and-Conditions> and for electronic format documents, subject to Terms and Conditions for Electronic Documents at <http://www.sgs.com.tw/Terms-and-Conditions>. Attention is drawn to the limitation of liability, indemnification and jurisdiction issues defined therein. Any holder of this document is advised that information contained hereon reflects the Company's findings at the time of its intervention only and within the limits of Client's instructions, if any. The Company's sole responsibility is to its Client and this document does not exonerate parties to a transaction from exercising all their rights and obligations under the transaction documents. This document cannot be reproduced except in full, without prior written approval of the Company. Any unauthorized alteration, forgery or falsification of the content or appearance of this document is unlawful and offenders may be prosecuted to the fullest extent of the law.

Report Number :ER/2022/30084
 Operation Mode :n77
 Test Mode :Tx CH Low
 EUT Pol :H Plane
 Test Frequency :3470.01 MHz

Test Site :SAC 1
 Test Date :2022-05-11
 Temp./Humi. :20.6/71
 Antenna Pol. :Vertical
 Engineer :GN Lin

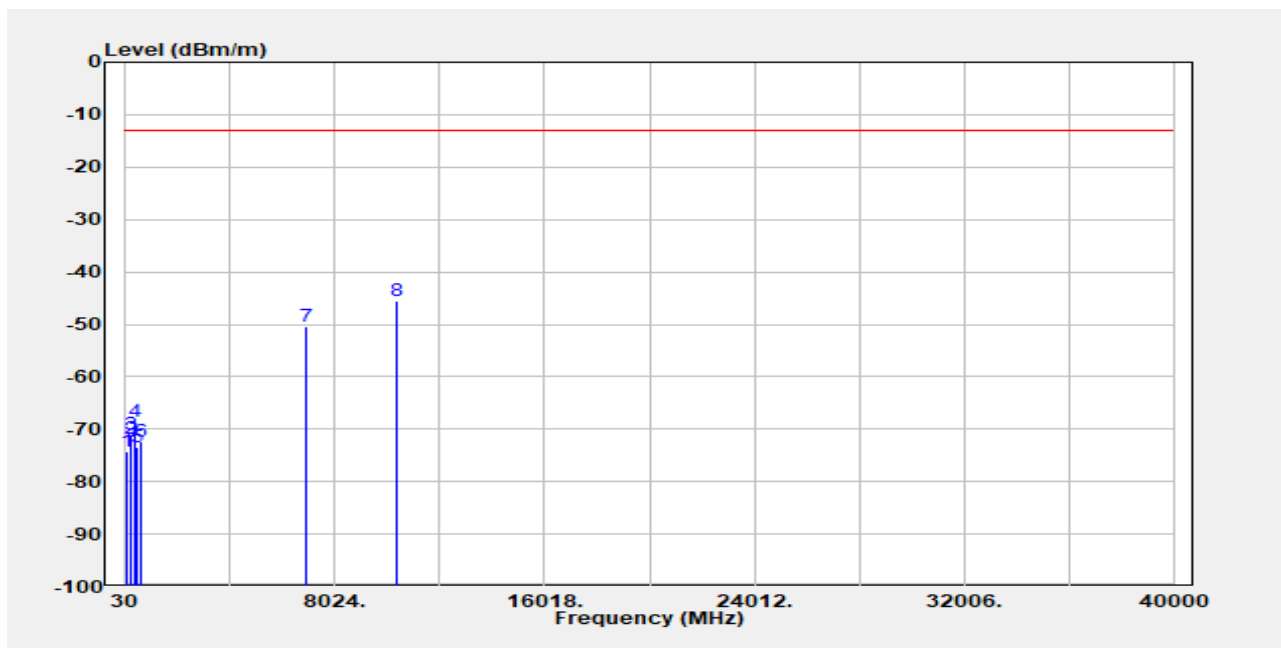

Freq. MHz	EIRP/ERP dBm	SG Output Level dBm	Antenna Gain dBi/dBd	Cable Loss dB	Limit dBm	Margin dB
48.43	-74.36	-61.53	-12.13	-0.70	-13.00	-61.36
195.87	-71.73	-74.30	4.01	-1.43	-13.00	-58.73
252.13	-71.04	-73.76	4.33	-1.60	-13.00	-58.04
394.72	-68.70	-70.93	4.32	-2.08	-13.00	-55.70
480.08	-73.35	-75.11	4.21	-2.44	-13.00	-60.35
600.36	-72.41	-73.42	3.64	-2.64	-13.00	-59.41
6940.02	-50.28	-52.20	11.72	-9.79	-13.00	-37.28
10410.03	-45.42	-46.56	11.29	-10.14	-13.00	-32.42

Unless otherwise stated the results shown in this test report refer only to the sample(s) tested and such sample(s) are retained for 90 days only.

除非另有說明，此報告結果僅對測試之樣品負責，同時此樣品僅保留90天。本報告未經本公司書面許可，不可部份複製。

This document is issued by the Company subject to its General Conditions of Service printed overleaf, available on request or accessible at <http://www.sgs.com.tw/Terms-and-Conditions> and for electronic format documents, subject to Terms and Conditions for Electronic Documents at <http://www.sgs.com.tw/Terms-and-Conditions>. Attention is drawn to the limitation of liability, indemnification and jurisdiction issues defined therein. Any holder of this document is advised that information contained hereon reflects the Company's findings at the time of its intervention only and within the limits of Client's instructions, if any. The Company's sole responsibility is to its Client and this document does not exonerate parties to a transaction from exercising all their rights and obligations under the transaction documents. This document cannot be reproduced except in full, without prior written approval of the Company. Any unauthorized alteration, forgery or falsification of the content or appearance of this document is unlawful and offenders may be prosecuted to the fullest extent of the law.

Report Number :ER/2022/30084
 Operation Mode :n77
 Test Mode :Tx CH Low
 EUT Pol :H Plane
 Test Frequency :3470.01 MHz

Test Site :SAC 1
 Test Date :2022-05-11
 Temp./Humi. :20.6/71
 Antenna Pol. :Horizontal
 Engineer :GN Lin

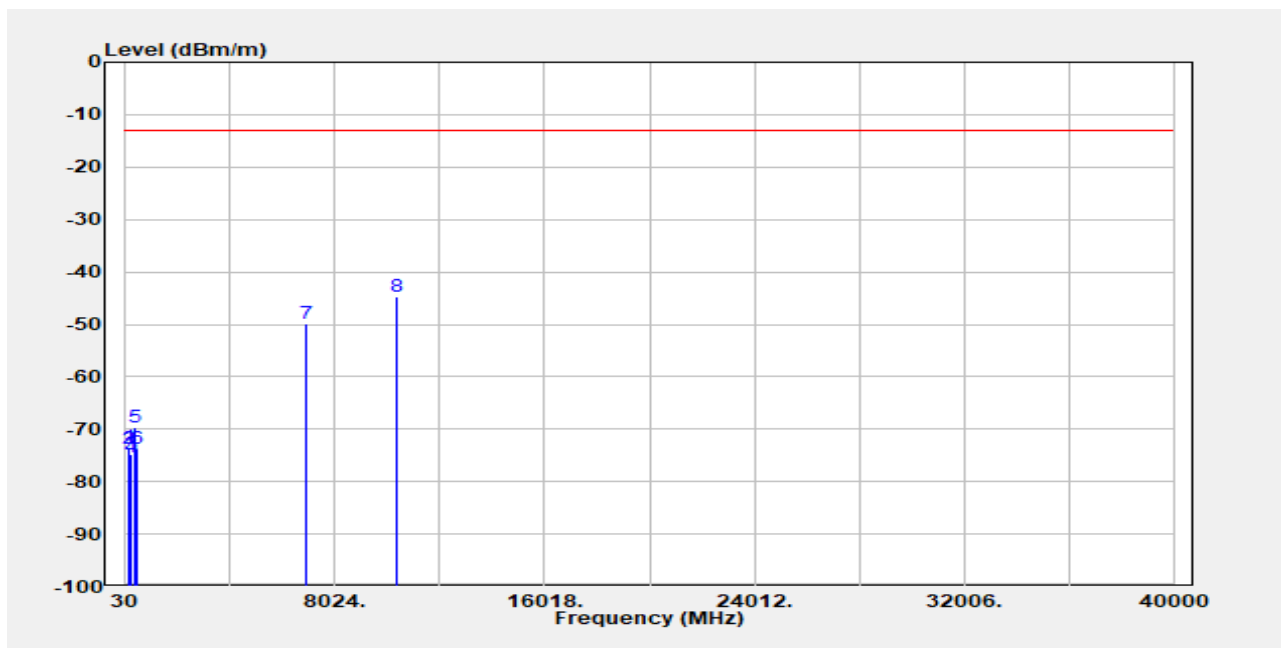

Freq. MHz	EIRP/ERP dBm	SG Output Level dBm	Antenna Gain dBi/dBd	Cable Loss dB	Limit dBm	Margin dB
118.27	-73.40	-70.56	-1.72	-1.12	-13.00	-60.40
127.97	-73.74	-70.69	-1.88	-1.16	-13.00	-60.74
194.90	-74.75	-77.20	3.88	-1.43	-13.00	-61.75
251.16	-75.43	-78.17	4.33	-1.59	-13.00	-62.43
394.72	-69.61	-71.85	4.32	-2.08	-13.00	-56.61
480.08	-73.81	-75.57	4.21	-2.44	-13.00	-60.81
6940.02	-49.81	-51.73	11.72	-9.79	-13.00	-36.81
10410.03	-44.74	-45.88	11.29	-10.14	-13.00	-31.74

Unless otherwise stated the results shown in this test report refer only to the sample(s) tested and such sample(s) are retained for 90 days only.

除非另有說明，此報告結果僅對測試之樣品負責，同時此樣品僅保留90天。本報告未經本公司書面許可，不可部份複製。

This document is issued by the Company subject to its General Conditions of Service printed overleaf, available on request or accessible at <http://www.sgs.com.tw/Terms-and-Conditions> and for electronic format documents, subject to Terms and Conditions for Electronic Documents at <http://www.sgs.com.tw/Terms-and-Conditions>. Attention is drawn to the limitation of liability, indemnification and jurisdiction issues defined therein. Any holder of this document is advised that information contained hereon reflects the Company's findings at the time of its intervention only and within the limits of Client's instructions, if any. The Company's sole responsibility is to its Client and this document does not exonerate parties to a transaction from exercising all their rights and obligations under the transaction documents. This document cannot be reproduced except in full, without prior written approval of the Company. Any unauthorized alteration, forgery or falsification of the content or appearance of this document is unlawful and offenders may be prosecuted to the fullest extent of the law.

Report Number :ER/2022/30084
 Operation Mode :n77
 Test Mode :Tx CH Mid
 EUT Pol :H Plane
 Test Frequency :3500.01 MHz

Test Site :SAC 1
 Test Date :2022-05-11
 Temp./Humi. :20.6/71
 Antenna Pol. :Vertical
 Engineer :GN Lin

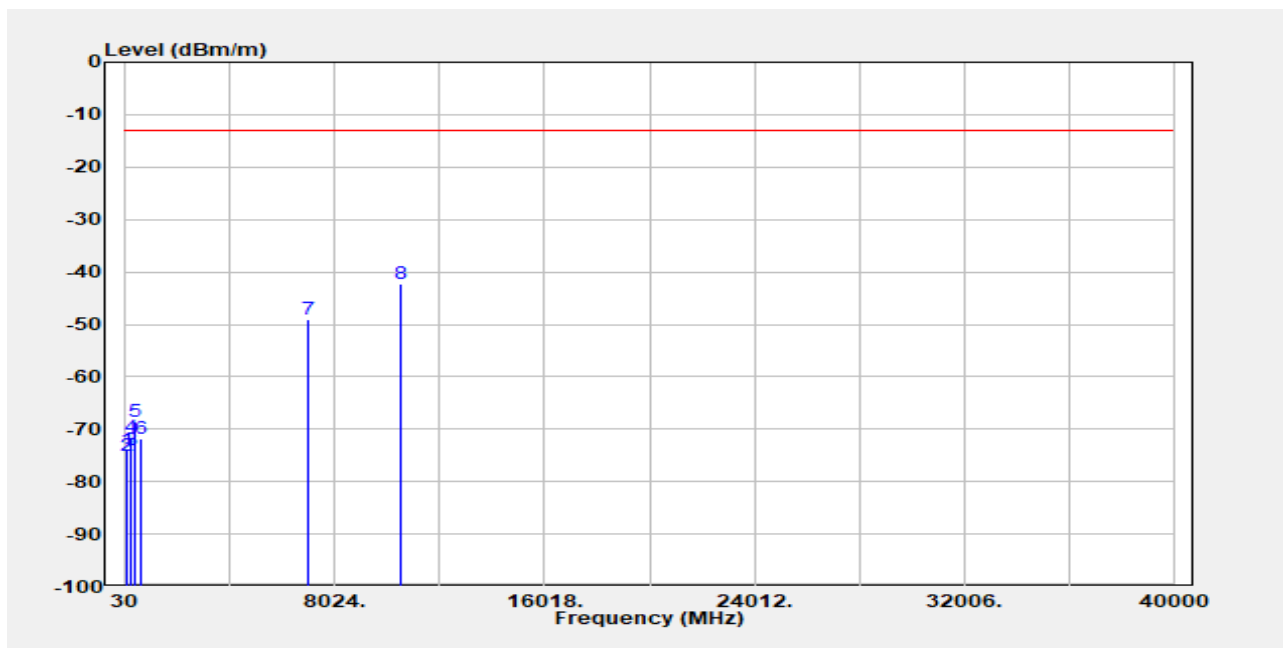

Freq. MHz	EIRP/ERP dBm	SG Output Level dBm	Antenna Gain dBi/dBd	Cable Loss dB	Limit dBm	Margin dB
48.43	-74.09	-61.26	-12.13	-0.70	-13.00	-61.09
103.72	-75.14	-73.03	-1.07	-1.03	-13.00	-62.14
197.81	-74.05	-76.81	4.19	-1.43	-13.00	-61.05
251.16	-71.46	-74.20	4.33	-1.59	-13.00	-58.46
396.66	-68.55	-70.76	4.32	-2.10	-13.00	-55.55
614.91	-71.74	-72.80	3.46	-2.40	-13.00	-58.74
7000.02	-49.06	-50.91	11.50	-9.65	-13.00	-36.06
10500.03	-42.18	-42.47	11.20	-10.92	-13.00	-29.18

Unless otherwise stated the results shown in this test report refer only to the sample(s) tested and such sample(s) are retained for 90 days only.

除非另有說明，此報告結果僅對測試之樣品負責，同時此樣品僅保留90天。本報告未經本公司書面許可，不可部份複製。

This document is issued by the Company subject to its General Conditions of Service printed overleaf, available on request or accessible at <http://www.sgs.com.tw/Terms-and-Conditions> and for electronic format documents, subject to Terms and Conditions for Electronic Documents at <http://www.sgs.com.tw/Terms-and-Conditions>. Attention is drawn to the limitation of liability, indemnification and jurisdiction issues defined therein. Any holder of this document is advised that information contained hereon reflects the Company's findings at the time of its intervention only and within the limits of Client's instructions, if any. The Company's sole responsibility is to its Client and this document does not exonerate parties to a transaction from exercising all their rights and obligations under the transaction documents. This document cannot be reproduced except in full, without prior written approval of the Company. Any unauthorized alteration, forgery or falsification of the content or appearance of this document is unlawful and offenders may be prosecuted to the fullest extent of the law.

Report Number :ER/2022/30084
 Operation Mode :n77
 Test Mode :Tx CH Mid
 EUT Pol :H Plane
 Test Frequency :3500.01 MHz

Test Site :SAC 1
 Test Date :2022-05-11
 Temp./Humi. :20.6/71
 Antenna Pol. :Horizontal
 Engineer :GN Lin

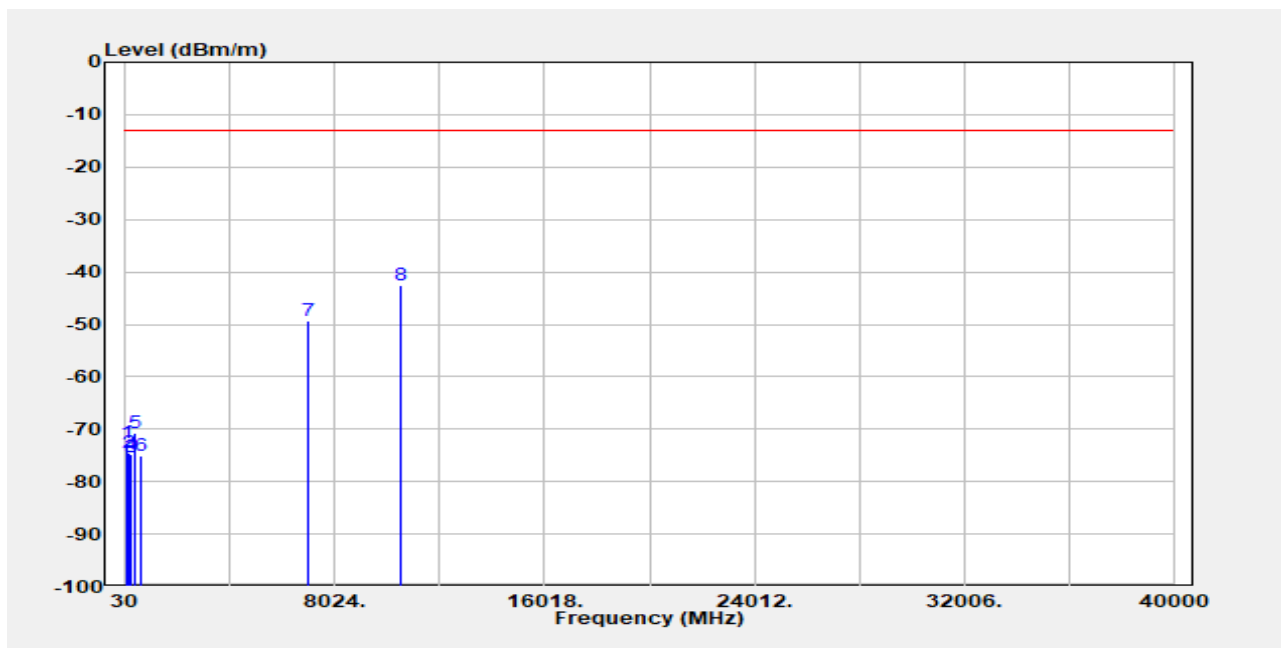

Freq. MHz	EIRP/ERP dBm	SG Output Level dBm	Antenna Gain dBi/dBd	Cable Loss dB	Limit dBm	Margin dB
102.75	-72.60	-70.49	-1.08	-1.03	-13.00	-59.60
128.94	-74.60	-71.44	-2.00	-1.17	-13.00	-61.60
197.81	-75.37	-78.13	4.19	-1.43	-13.00	-62.37
251.16	-74.87	-77.61	4.33	-1.59	-13.00	-61.87
396.66	-70.70	-72.91	4.32	-2.10	-13.00	-57.70
614.91	-75.16	-76.23	3.46	-2.40	-13.00	-62.16
7000.02	-49.38	-51.23	11.50	-9.65	-13.00	-36.38
10500.03	-42.63	-42.91	11.20	-10.92	-13.00	-29.63

Unless otherwise stated the results shown in this test report refer only to the sample(s) tested and such sample(s) are retained for 90 days only.

除非另有說明，此報告結果僅對測試之樣品負責，同時此樣品僅保留90天。本報告未經本公司書面許可，不可部份複製。

This document is issued by the Company subject to its General Conditions of Service printed overleaf, available on request or accessible at <http://www.sgs.com.tw/Terms-and-Conditions> and for electronic format documents, subject to Terms and Conditions for Electronic Documents at <http://www.sgs.com.tw/Terms-and-Conditions>. Attention is drawn to the limitation of liability, indemnification and jurisdiction issues defined therein. Any holder of this document is advised that information contained hereon reflects the Company's findings at the time of its intervention only and within the limits of Client's instructions, if any. The Company's sole responsibility is to its Client and this document does not exonerate parties to a transaction from exercising all their rights and obligations under the transaction documents. This document cannot be reproduced except in full, without prior written approval of the Company. Any unauthorized alteration, forgery or falsification of the content or appearance of this document is unlawful and offenders may be prosecuted to the fullest extent of the law.

Report Number :ER/2022/30084
 Operation Mode :n77
 Test Mode :Tx CH High
 EUT Pol :H Plane
 Test Frequency :3529.98 MHz

Test Site :SAC 1
 Test Date :2022-05-11
 Temp./Humi. :20.6/71
 Antenna Pol. :Vertical
 Engineer :GN Lin

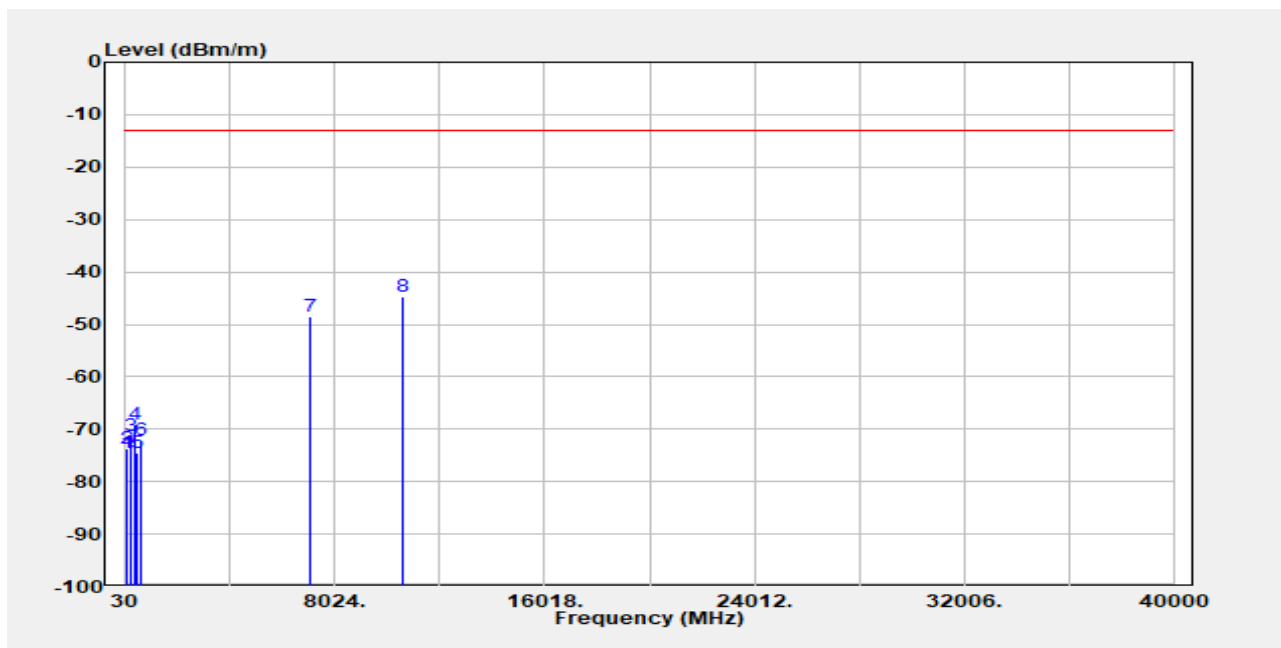

Freq. MHz	EIRP/ERP dBm	SG Output Level dBm	Antenna Gain dBi/dBd	Cable Loss dB	Limit dBm	Margin dB
48.43	-74.59	-61.76	-12.13	-0.70	-13.00	-61.59
103.72	-73.78	-71.68	-1.07	-1.03	-13.00	-60.78
195.87	-71.23	-73.81	4.01	-1.43	-13.00	-58.23
398.60	-68.98	-71.18	4.32	-2.12	-13.00	-55.98
480.08	-74.50	-76.26	4.21	-2.44	-13.00	-61.50
599.39	-71.98	-72.99	3.66	-2.64	-13.00	-58.98
7059.96	-48.48	-49.95	11.24	-9.77	-13.00	-35.48
10589.94	-44.62	-44.49	11.29	-11.42	-13.00	-31.62

Unless otherwise stated the results shown in this test report refer only to the sample(s) tested and such sample(s) are retained for 90 days only.

除非另有說明，此報告結果僅對測試之樣品負責，同時此樣品僅保留90天。本報告未經本公司書面許可，不可部份複製。

This document is issued by the Company subject to its General Conditions of Service printed overleaf, available on request or accessible at <http://www.sgs.com.tw/Terms-and-Conditions> and for electronic format documents, subject to Terms and Conditions for Electronic Documents at <http://www.sgs.com.tw/Terms-and-Conditions>. Attention is drawn to the limitation of liability, indemnification and jurisdiction issues defined therein. Any holder of this document is advised that information contained hereon reflects the Company's findings at the time of its intervention only and within the limits of Client's instructions, if any. The Company's sole responsibility is to its Client and this document does not exonerate parties to a transaction from exercising all their rights and obligations under the transaction documents. This document cannot be reproduced except in full, without prior written approval of the Company. Any unauthorized alteration, forgery or falsification of the content or appearance of this document is unlawful and offenders may be prosecuted to the fullest extent of the law.

Report Number :ER/2022/30084
 Operation Mode :n77
 Test Mode :Tx CH High
 EUT Pol :H Plane
 Test Frequency :3529.98 MHz

Test Site :SAC 1
 Test Date :2022-05-11
 Temp./Humi. :20.6/71
 Antenna Pol. :Horizontal
 Engineer :GN Lin

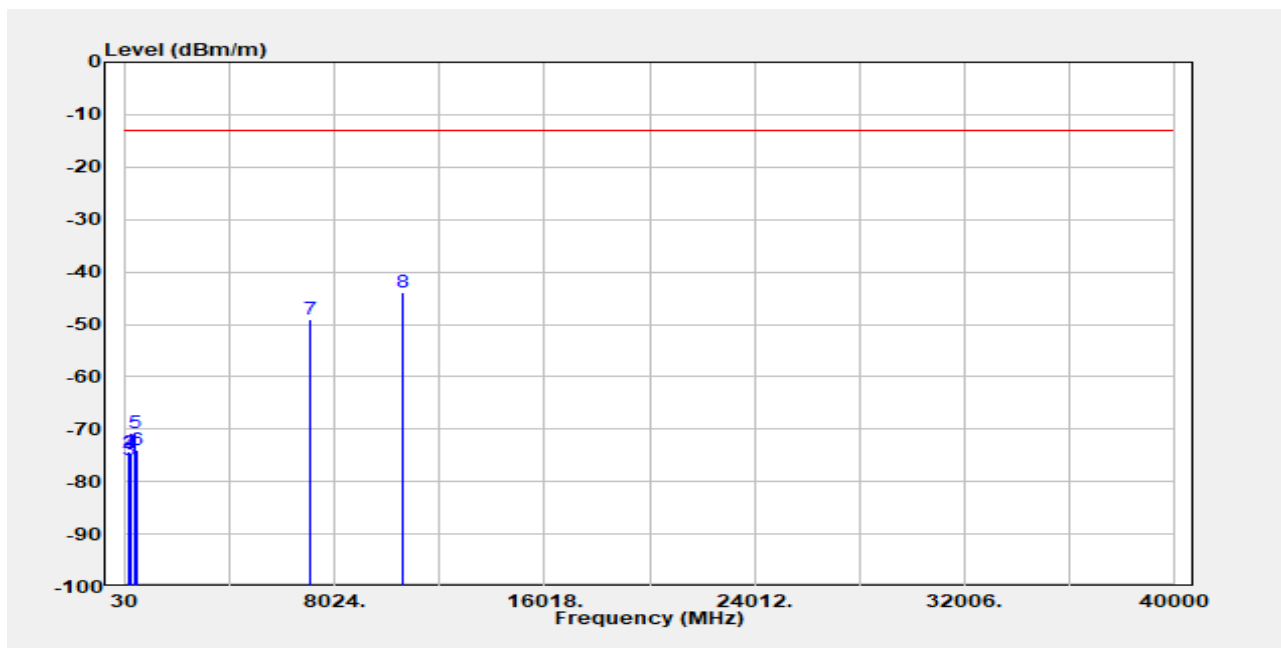

Freq. MHz	EIRP/ERP dBm	SG Output Level dBm	Antenna Gain dBi/dBd	Cable Loss dB	Limit dBm	Margin dB
118.27	-74.23	-71.39	-1.72	-1.12	-13.00	-61.23
127.97	-74.46	-71.41	-1.88	-1.16	-13.00	-61.46
192.96	-75.77	-78.02	3.69	-1.43	-13.00	-62.77
252.13	-74.65	-77.38	4.33	-1.60	-13.00	-61.65
398.60	-70.64	-72.84	4.32	-2.12	-13.00	-57.64
480.08	-74.03	-75.79	4.21	-2.44	-13.00	-61.03
7059.96	-49.06	-50.53	11.24	-9.77	-13.00	-36.06
10589.94	-44.01	-43.88	11.29	-11.42	-13.00	-31.01

Unless otherwise stated the results shown in this test report refer only to the sample(s) tested and such sample(s) are retained for 90 days only.

除非另有說明，此報告結果僅對測試之樣品負責，同時此樣品僅保留90天。本報告未經本公司書面許可，不可部份複製。

This document is issued by the Company subject to its General Conditions of Service printed overleaf, available on request or accessible at <http://www.sgs.com.tw/Terms-and-Conditions> and for electronic format documents, subject to Terms and Conditions for Electronic Documents at <http://www.sgs.com.tw/Terms-and-Conditions>. Attention is drawn to the limitation of liability, indemnification and jurisdiction issues defined therein. Any holder of this document is advised that information contained hereon reflects the Company's findings at the time of its intervention only and within the limits of Client's instructions, if any. The Company's sole responsibility is to its Client and this document does not exonerate parties to a transaction from exercising all their rights and obligations under the transaction documents. This document cannot be reproduced except in full, without prior written approval of the Company. Any unauthorized alteration, forgery or falsification of the content or appearance of this document is unlawful and offenders may be prosecuted to the fullest extent of the law.

Report Number :ER/2022/30084
 Operation Mode :n77
 Test Mode :Tx CH Low
 EUT Pol :H Plane
 Test Frequency :3715.02 MHz

Test Site :SAC 1
 Test Date :2022-05-11
 Temp./Humi. :20.6/71
 Antenna Pol. :Vertical
 Engineer :GN Lin

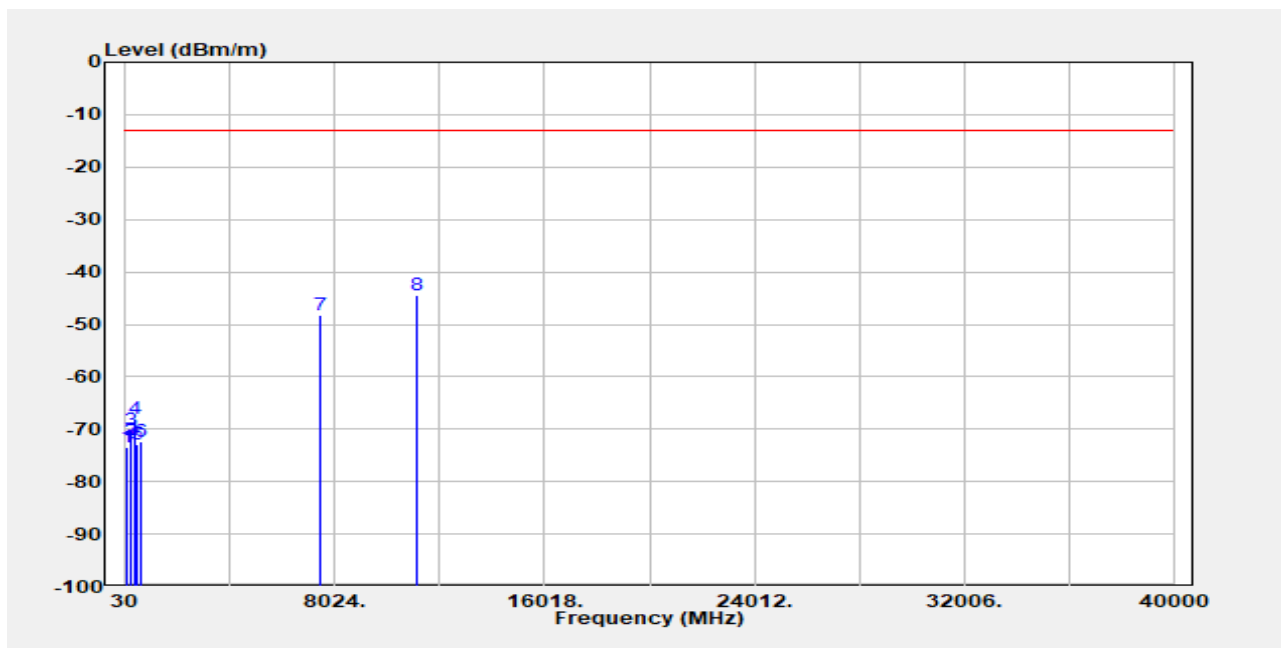

Freq. MHz	EIRP/ERP dBm	SG Output Level dBm	Antenna Gain dBi/dBd	Cable Loss dB	Limit dBm	Margin dB
52.31	-73.31	-61.32	-11.28	-0.71	-13.00	-60.31
196.84	-71.96	-74.59	4.06	-1.43	-13.00	-58.96
252.13	-70.21	-72.94	4.33	-1.60	-13.00	-57.21
396.66	-67.97	-70.18	4.32	-2.10	-13.00	-54.97
480.08	-72.95	-74.71	4.21	-2.44	-13.00	-59.95
595.51	-72.38	-73.49	3.76	-2.65	-13.00	-59.38
7430.04	-48.14	-50.03	10.94	-9.04	-13.00	-35.14
11145.06	-44.41	-43.50	11.49	-12.40	-13.00	-31.41

Unless otherwise stated the results shown in this test report refer only to the sample(s) tested and such sample(s) are retained for 90 days only.

除非另有說明，此報告結果僅對測試之樣品負責，同時此樣品僅保留90天。本報告未經本公司書面許可，不可部份複製。

This document is issued by the Company subject to its General Conditions of Service printed overleaf, available on request or accessible at <http://www.sgs.com.tw/Terms-and-Conditions> and for electronic format documents, subject to Terms and Conditions for Electronic Documents at <http://www.sgs.com.tw/Terms-and-Conditions>. Attention is drawn to the limitation of liability, indemnification and jurisdiction issues defined therein. Any holder of this document is advised that information contained hereon reflects the Company's findings at the time of its intervention only and within the limits of Client's instructions, if any. The Company's sole responsibility is to its Client and this document does not exonerate parties to a transaction from exercising all their rights and obligations under the transaction documents. This document cannot be reproduced except in full, without prior written approval of the Company. Any unauthorized alteration, forgery or falsification of the content or appearance of this document is unlawful and offenders may be prosecuted to the fullest extent of the law.

Report Number :ER/2022/30084
 Operation Mode :n77
 Test Mode :Tx CH Low
 EUT Pol :H Plane
 Test Frequency :3715.02 MHz

Test Site :SAC 1
 Test Date :2022-05-11
 Temp./Humi. :20.6/71
 Antenna Pol. :Horizontal
 Engineer :GN Lin

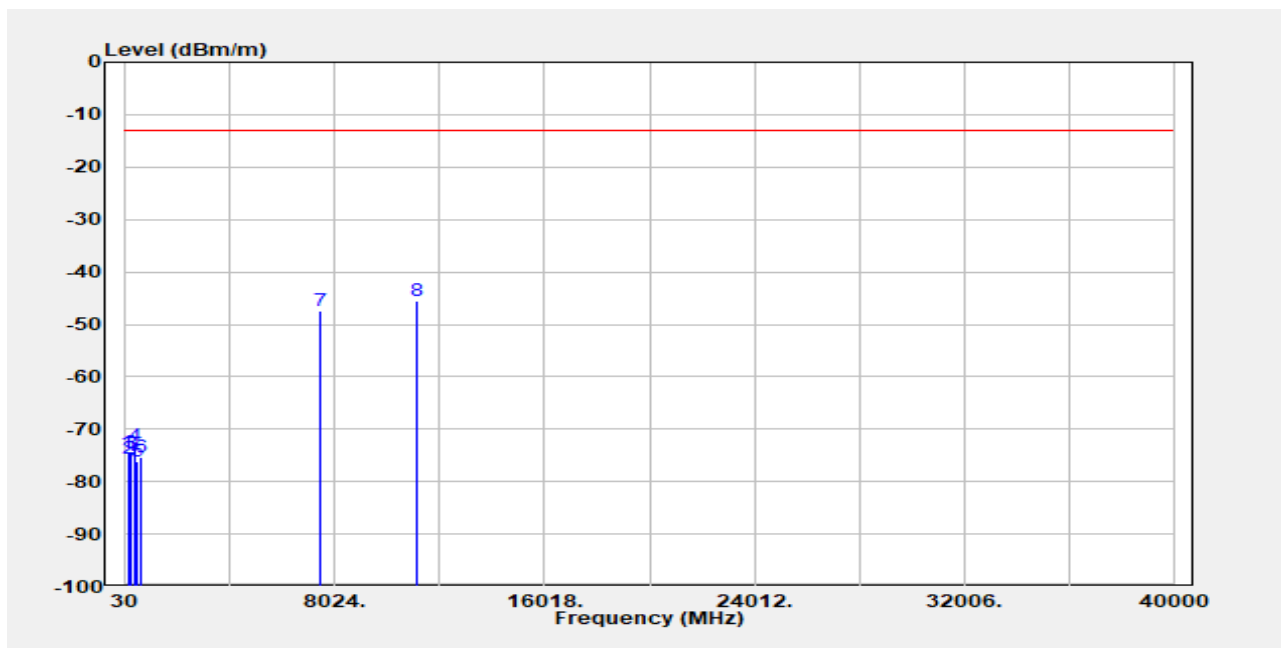

Freq. MHz	EIRP/ERP dBm	SG Output Level dBm	Antenna Gain dBi/dBd	Cable Loss dB	Limit dBm	Margin dB
117.30	-74.58	-71.73	-1.73	-1.11	-13.00	-61.58
132.82	-75.68	-72.50	-1.97	-1.21	-13.00	-62.68
252.13	-74.54	-77.27	4.33	-1.60	-13.00	-61.54
395.69	-73.27	-75.49	4.31	-2.09	-13.00	-60.27
490.75	-76.13	-78.14	4.27	-2.26	-13.00	-63.13
616.85	-75.31	-76.40	3.45	-2.35	-13.00	-62.31
7430.04	-47.36	-49.25	10.94	-9.04	-13.00	-34.36
11145.06	-45.60	-44.69	11.49	-12.40	-13.00	-32.60

Unless otherwise stated the results shown in this test report refer only to the sample(s) tested and such sample(s) are retained for 90 days only.

除非另有說明，此報告結果僅對測試之樣品負責，同時此樣品僅保留90天。本報告未經本公司書面許可，不可部份複製。

This document is issued by the Company subject to its General Conditions of Service printed overleaf, available on request or accessible at <http://www.sgs.com.tw/Terms-and-Conditions> and for electronic format documents, subject to Terms and Conditions for Electronic Documents at <http://www.sgs.com.tw/Terms-and-Conditions>. Attention is drawn to the limitation of liability, indemnification and jurisdiction issues defined therein. Any holder of this document is advised that information contained hereon reflects the Company's findings at the time of its intervention only and within the limits of Client's instructions, if any. The Company's sole responsibility is to its Client and this document does not exonerate parties to a transaction from exercising all their rights and obligations under the transaction documents. This document cannot be reproduced except in full, without prior written approval of the Company. Any unauthorized alteration, forgery or falsification of the content or appearance of this document is unlawful and offenders may be prosecuted to the fullest extent of the law.

Report Number :ER/2022/30084
 Operation Mode :n77
 Test Mode :Tx CH Mid
 EUT Pol :H Plane
 Test Frequency :3840 MHz

Test Site :SAC 1
 Test Date :2022-05-11
 Temp./Humi. :20.6/71
 Antenna Pol. :Vertical
 Engineer :GN Lin

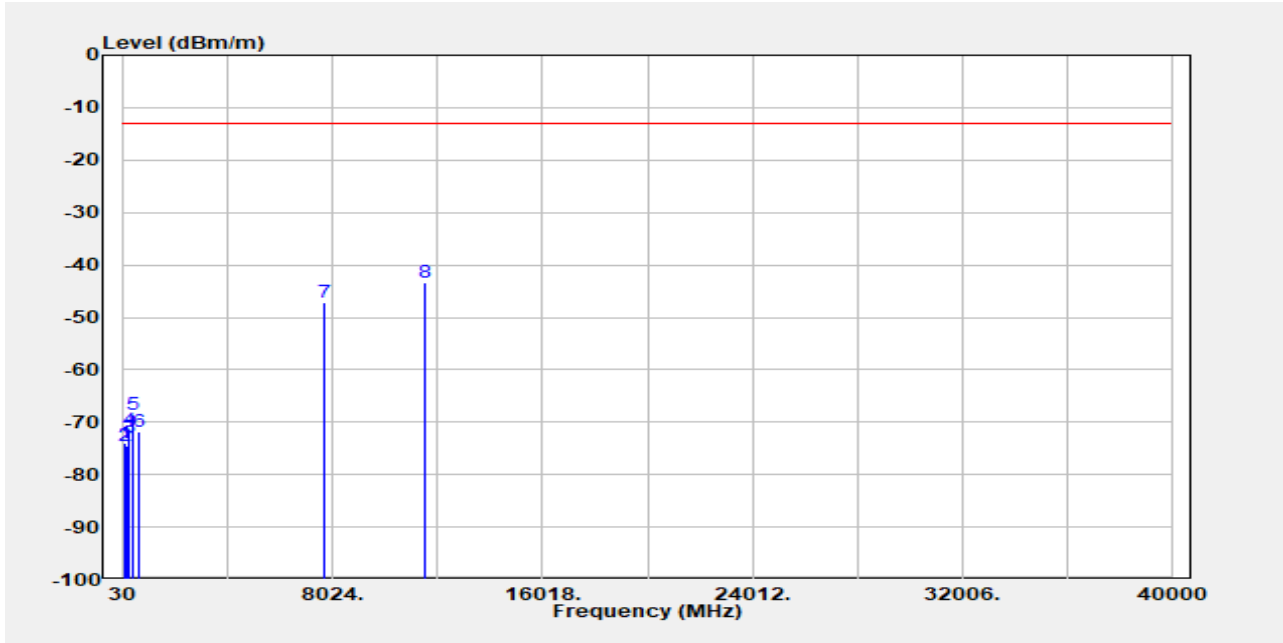

Freq. MHz	EIRP/ERP dBm	SG Output Level dBm	Antenna Gain dBi/dBd	Cable Loss dB	Limit dBm	Margin dB
48.43	-74.11	-61.28	-12.13	-0.70	-13.00	-61.11
115.36	-74.51	-71.71	-1.71	-1.10	-13.00	-61.51
194.90	-72.80	-75.25	3.88	-1.43	-13.00	-59.80
251.16	-71.57	-74.31	4.33	-1.59	-13.00	-58.57
395.69	-68.69	-70.91	4.31	-2.09	-13.00	-55.69
647.89	-71.94	-73.16	3.61	-2.39	-13.00	-58.94
7680.00	-47.23	-48.77	11.42	-9.88	-13.00	-34.23
11520.00	-43.42	-42.43	11.36	-12.35	-13.00	-30.42

Unless otherwise stated the results shown in this test report refer only to the sample(s) tested and such sample(s) are retained for 90 days only.

除非另有說明，此報告結果僅對測試之樣品負責，同時此樣品僅保留90天。本報告未經本公司書面許可，不可部份複製。

This document is issued by the Company subject to its General Conditions of Service printed overleaf, available on request or accessible at <http://www.sgs.com.tw/Terms-and-Conditions> and for electronic format documents, subject to Terms and Conditions for Electronic Documents at <http://www.sgs.com.tw/Terms-and-Conditions>. Attention is drawn to the limitation of liability, indemnification and jurisdiction issues defined therein. Any holder of this document is advised that information contained hereon reflects the Company's findings at the time of its intervention only and within the limits of Client's instructions, if any. The Company's sole responsibility is to its Client and this document does not exonerate parties to a transaction from exercising all their rights and obligations under the transaction documents. This document cannot be reproduced except in full, without prior written approval of the Company. Any unauthorized alteration, forgery or falsification of the content or appearance of this document is unlawful and offenders may be prosecuted to the fullest extent of the law.

Report Number :ER/2022/30084
 Operation Mode :n77
 Test Mode :Tx CH Mid
 EUT Pol :H Plane
 Test Frequency :3840 MHz

Test Site :SAC 1
 Test Date :2022-05-11
 Temp./Humi. :20.6/71
 Antenna Pol. :Horizontal
 Engineer :GN Lin

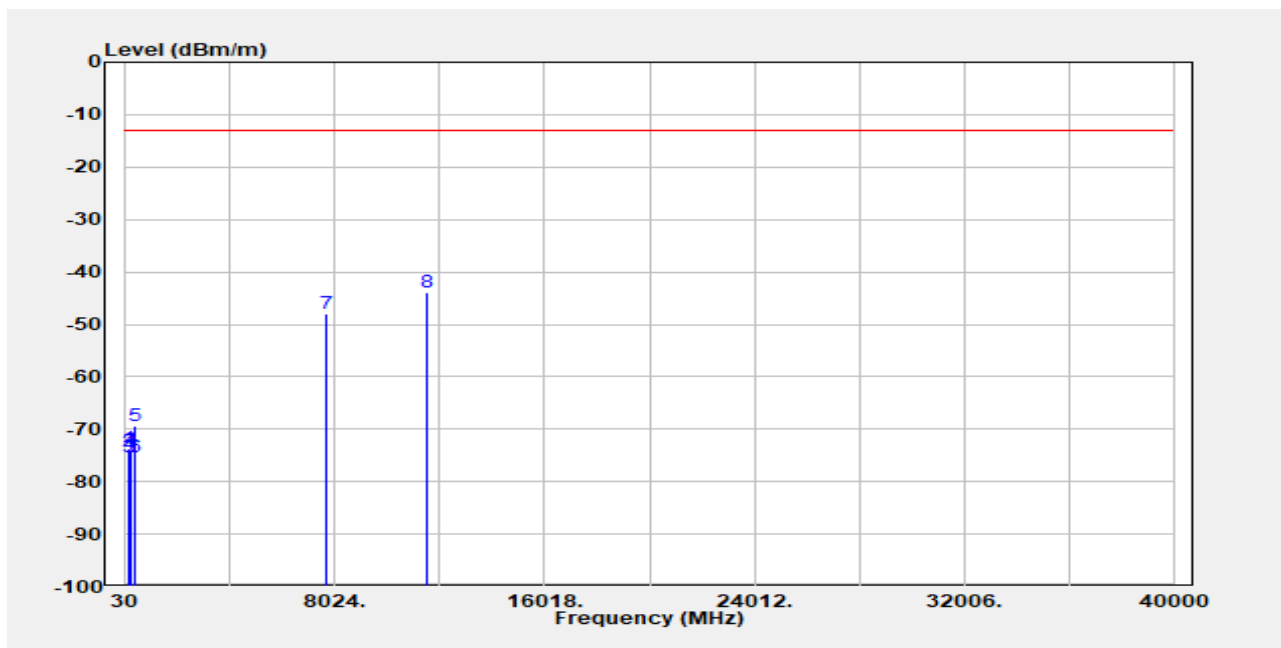

Freq. MHz	EIRP/ERP dBm	SG Output Level dBm	Antenna Gain dBi/dBd	Cable Loss dB	Limit dBm	Margin dB
119.24	-73.77	-70.83	-1.82	-1.12	-13.00	-60.77
127.00	-74.33	-71.13	-2.04	-1.16	-13.00	-61.33
191.99	-75.44	-77.55	3.54	-1.43	-13.00	-62.44
251.16	-74.01	-76.75	4.33	-1.59	-13.00	-61.01
395.69	-69.34	-71.56	4.31	-2.09	-13.00	-56.34
419.94	-75.25	-77.61	4.25	-1.89	-13.00	-62.25
7680.00	-47.98	-49.52	11.42	-9.88	-13.00	-34.98
11520.00	-43.78	-42.78	11.36	-12.35	-13.00	-30.78

Unless otherwise stated the results shown in this test report refer only to the sample(s) tested and such sample(s) are retained for 90 days only.

除非另有說明，此報告結果僅對測試之樣品負責，同時此樣品僅保留90天。本報告未經本公司書面許可，不可部份複製。

This document is issued by the Company subject to its General Conditions of Service printed overleaf, available on request or accessible at <http://www.sgs.com.tw/Terms-and-Conditions> and for electronic format documents, subject to Terms and Conditions for Electronic Documents at <http://www.sgs.com.tw/Terms-and-Conditions>. Attention is drawn to the limitation of liability, indemnification and jurisdiction issues defined therein. Any holder of this document is advised that information contained hereon reflects the Company's findings at the time of its intervention only and within the limits of Client's instructions, if any. The Company's sole responsibility is to its Client and this document does not exonerate parties to a transaction from exercising all their rights and obligations under the transaction documents. This document cannot be reproduced except in full, without prior written approval of the Company. Any unauthorized alteration, forgery or falsification of the content or appearance of this document is unlawful and offenders may be prosecuted to the fullest extent of the law.

Report Number :ER/2022/30084
 Operation Mode :n77
 Test Mode :Tx CH High
 EUT Pol :H Plane
 Test Frequency :3964.98 MHz

Test Site :SAC 1
 Test Date :2022-05-11
 Temp./Humi. :20.6/71
 Antenna Pol. :Vertical
 Engineer :GN Lin

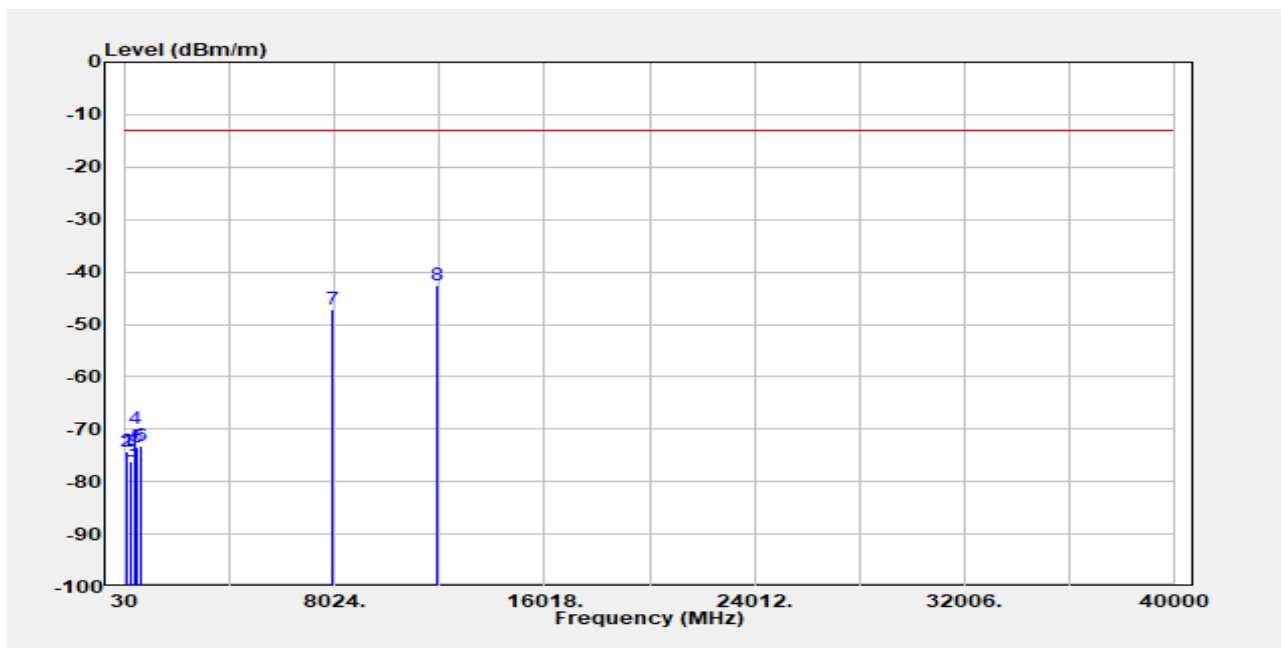

Freq. MHz	EIRP/ERP dBm	SG Output Level dBm	Antenna Gain dBi/dBd	Cable Loss dB	Limit dBm	Margin dB
48.43	-74.35	-61.52	-12.13	-0.70	-13.00	-61.35
107.60	-74.22	-71.75	-1.42	-1.04	-13.00	-61.22
195.87	-76.26	-78.84	4.01	-1.43	-13.00	-63.26
396.66	-69.90	-72.12	4.32	-2.10	-13.00	-56.90
480.08	-73.38	-75.14	4.21	-2.44	-13.00	-60.38
607.15	-73.13	-74.14	3.56	-2.54	-13.00	-60.13
7929.96	-47.14	-47.55	11.08	-10.67	-13.00	-34.14
11894.94	-42.66	-43.10	12.78	-12.34	-13.00	-29.66

Unless otherwise stated the results shown in this test report refer only to the sample(s) tested and such sample(s) are retained for 90 days only.

除非另有說明，此報告結果僅對測試之樣品負責，同時此樣品僅保留90天。本報告未經本公司書面許可，不可部份複製。

This document is issued by the Company subject to its General Conditions of Service printed overleaf, available on request or accessible at <http://www.sgs.com.tw/Terms-and-Conditions> and for electronic format documents, subject to Terms and Conditions for Electronic Documents at <http://www.sgs.com.tw/Terms-and-Conditions>. Attention is drawn to the limitation of liability, indemnification and jurisdiction issues defined therein. Any holder of this document is advised that information contained hereon reflects the Company's findings at the time of its intervention only and within the limits of Client's instructions, if any. The Company's sole responsibility is to its Client and this document does not exonerate parties to a transaction from exercising all their rights and obligations under the transaction documents. This document cannot be reproduced except in full, without prior written approval of the Company. Any unauthorized alteration, forgery or falsification of the content or appearance of this document is unlawful and offenders may be prosecuted to the fullest extent of the law.

Report Number :ER/2022/30084
 Operation Mode :n77
 Test Mode :Tx CH High
 EUT Pol :H Plane
 Test Frequency :3964.98 MHz

Test Site :SAC 1
 Test Date :2022-05-11
 Temp./Humi. :20.6/71
 Antenna Pol. :Horizontal
 Engineer :GN Lin

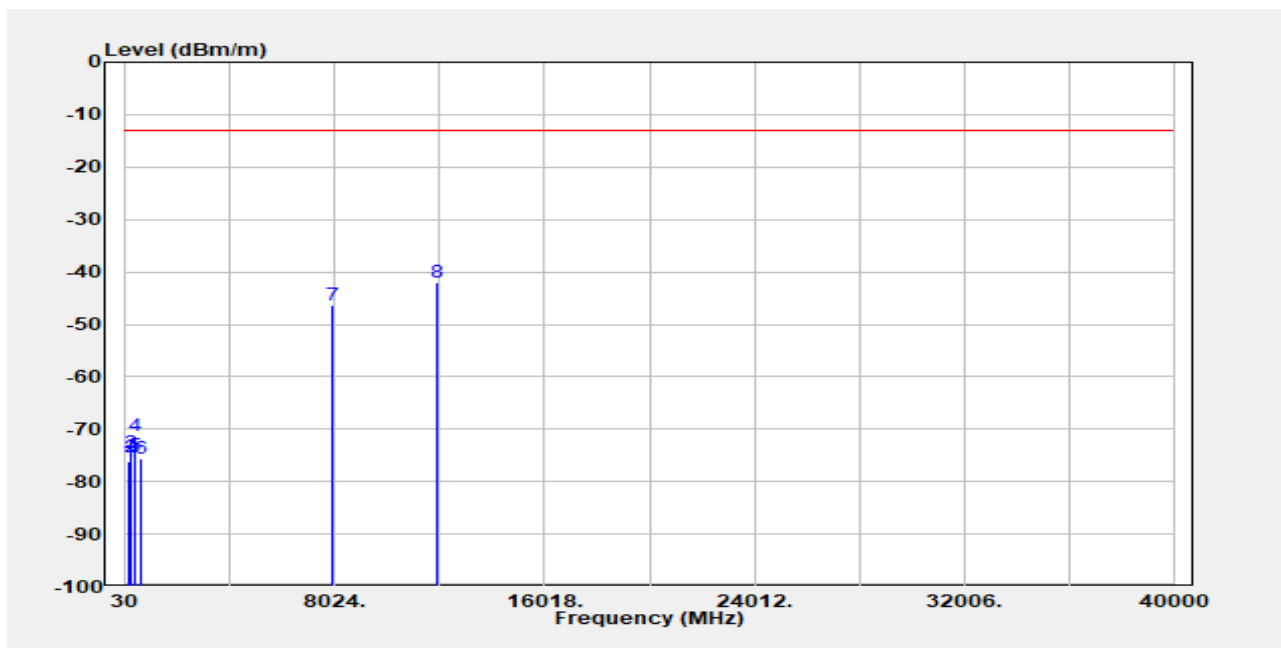

Freq. MHz	EIRP/ERP dBm	SG Output Level dBm	Antenna Gain dBi/dBd	Cable Loss dB	Limit dBm	Margin dB
128.94	-76.06	-72.89	-2.00	-1.17	-13.00	-63.06
195.87	-75.32	-77.89	4.01	-1.43	-13.00	-62.32
252.13	-74.53	-77.25	4.33	-1.60	-13.00	-61.53
398.60	-71.37	-73.57	4.32	-2.12	-13.00	-58.37
417.03	-75.09	-77.51	4.30	-1.88	-13.00	-62.09
598.42	-75.49	-76.53	3.68	-2.64	-13.00	-62.49
7929.96	-46.34	-46.75	11.08	-10.67	-13.00	-33.34
11894.94	-41.94	-42.38	12.78	-12.34	-13.00	-28.94

Unless otherwise stated the results shown in this test report refer only to the sample(s) tested and such sample(s) are retained for 90 days only.

除非另有說明，此報告結果僅對測試之樣品負責，同時此樣品僅保留90天。本報告未經本公司書面許可，不可部份複製。
 This document is issued by the Company subject to its General Conditions of Service printed overleaf, available on request or accessible at <http://www.sgs.com.tw/Terms-and-Conditions> and for electronic format documents, subject to Terms and Conditions for Electronic Documents at <http://www.sgs.com.tw/Terms-and-Conditions>. Attention is drawn to the limitation of liability, indemnification and jurisdiction issues defined therein. Any holder of this document is advised that information contained hereon reflects the Company's findings at the time of its intervention only and within the limits of Client's instructions, if any. The Company's sole responsibility is to its Client and this document does not exonerate parties to a transaction from exercising all their rights and obligations under the transaction documents. This document cannot be reproduced except in full, without prior written approval of the Company. Any unauthorized alteration, forgery or falsification of the content or appearance of this document is unlawful and offenders may be prosecuted to the fullest extent of the law.

MIMO

Report Number :ER/2022/30084
 Operation Mode :n77
 Test Mode :Tx CH Low
 EUT Pol :H Plane
 Test Frequency :3470.01 MHz

Test Site :SAC 1
 Test Date :2022-05-11
 Temp./Humi. :20.6/71
 Antenna Pol. :Vertical
 Engineer :GN Lin

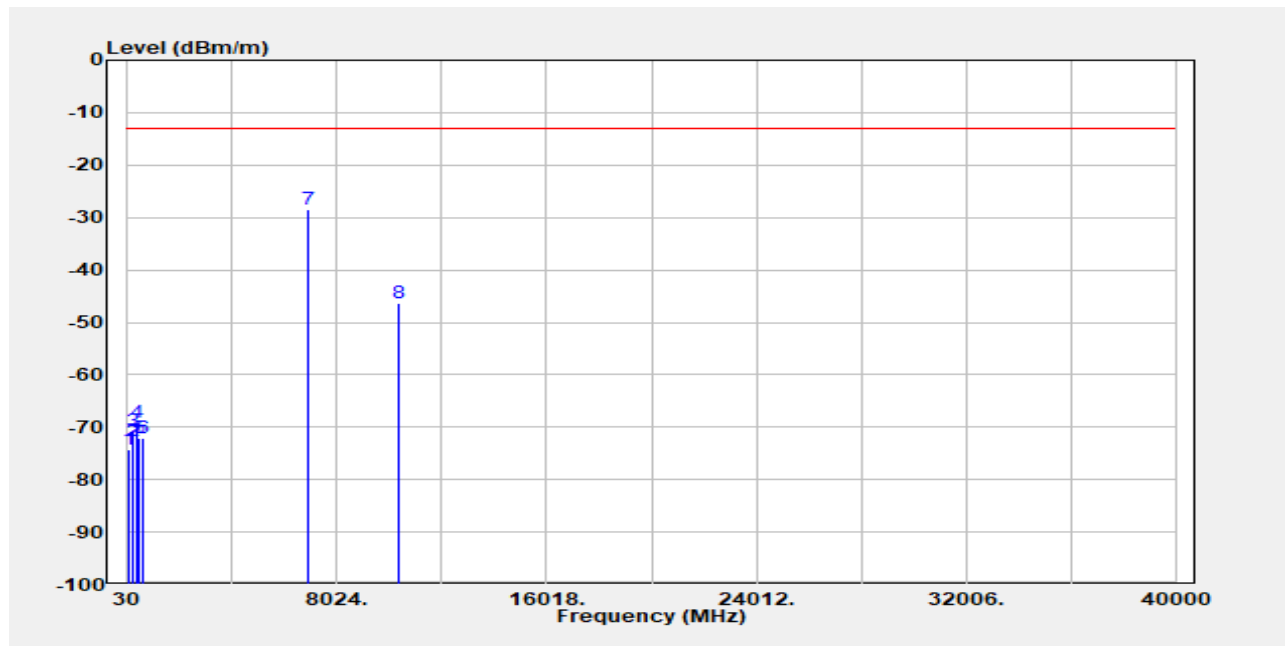

Freq. MHz	EIRP/ERP dBm	SG Output Level dBm	Antenna Gain dBi/dBd	Cable Loss dB	Limit dBm	Margin dB
48.43	-74.18	-61.35	-12.13	-0.70	-13.00	-61.18
194.90	-72.55	-74.99	3.88	-1.43	-13.00	-59.55
252.13	-70.74	-73.47	4.33	-1.60	-13.00	-57.74
398.60	-69.20	-71.40	4.32	-2.12	-13.00	-56.20
480.08	-72.21	-73.98	4.21	-2.44	-13.00	-59.21
593.57	-71.99	-73.12	3.78	-2.65	-13.00	-58.99
6940.02	-28.57	-30.50	11.72	-9.79	-13.00	-15.57
10410.03	-46.22	-47.37	11.29	-10.14	-13.00	-33.22

Unless otherwise stated the results shown in this test report refer only to the sample(s) tested and such sample(s) are retained for 90 days only.

除非另有說明，此報告結果僅對測試之樣品負責，同時此樣品僅保留90天。本報告未經本公司書面許可，不可部份複製。

This document is issued by the Company subject to its General Conditions of Service printed overleaf, available on request or accessible at <http://www.sgs.com.tw/Terms-and-Conditions> and for electronic format documents, subject to Terms and Conditions for Electronic Documents at <http://www.sgs.com.tw/Terms-and-Conditions>. Attention is drawn to the limitation of liability, indemnification and jurisdiction issues defined therein. Any holder of this document is advised that information contained hereon reflects the Company's findings at the time of its intervention only and within the limits of Client's instructions, if any. The Company's sole responsibility is to its Client and this document does not exonerate parties to a transaction from exercising all their rights and obligations under the transaction documents. This document cannot be reproduced except in full, without prior written approval of the Company. Any unauthorized alteration, forgery or falsification of the content or appearance of this document is unlawful and offenders may be prosecuted to the fullest extent of the law.

Report Number :ER/2022/30084
 Operation Mode :n77
 Test Mode :Tx CH Low
 EUT Pol :H Plane
 Test Frequency :3470.01 MHz

Test Site :SAC 1
 Test Date :2022-05-11
 Temp./Humi. :20.6/71
 Antenna Pol. :Horizontal
 Engineer :GN Lin

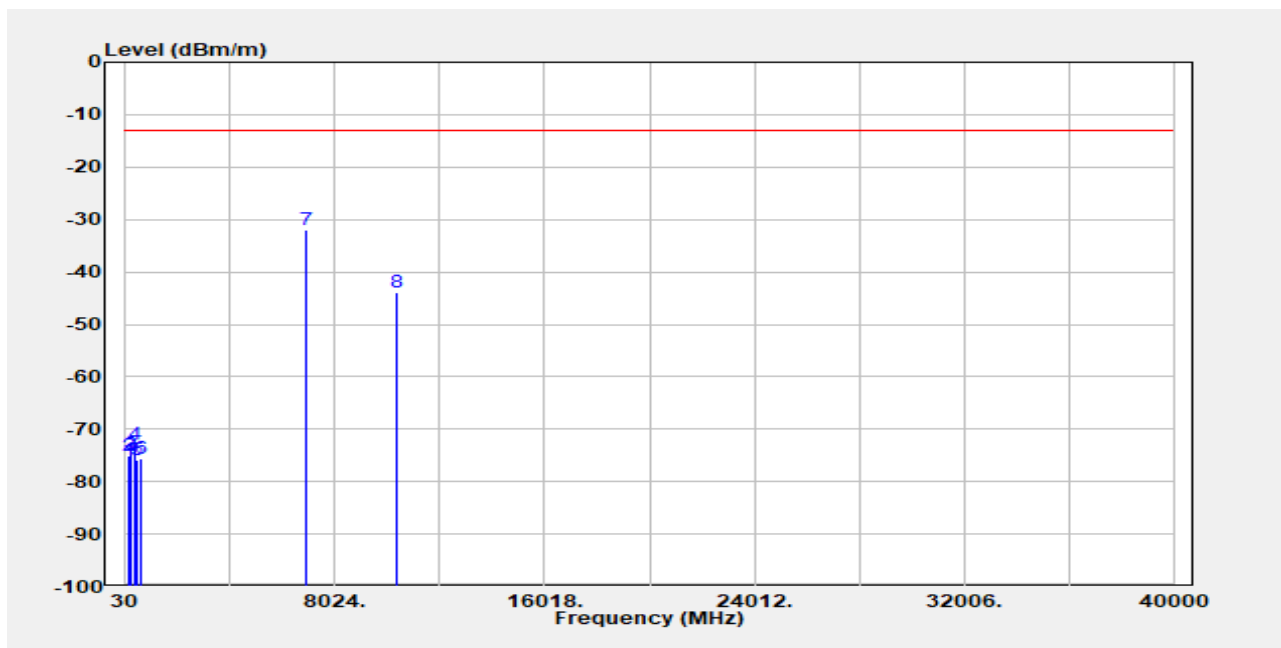

Freq. MHz	EIRP/ERP dBm	SG Output Level dBm	Antenna Gain dBi/dBd	Cable Loss dB	Limit dBm	Margin dB
118.27	-76.00	-73.17	-1.72	-1.12	-13.00	-63.00
130.88	-75.17	-72.00	-1.99	-1.18	-13.00	-62.17
252.13	-74.71	-77.44	4.33	-1.60	-13.00	-61.71
394.72	-72.88	-75.11	4.32	-2.08	-13.00	-59.88
480.08	-75.91	-77.67	4.21	-2.44	-13.00	-62.91
604.24	-75.53	-76.57	3.62	-2.58	-13.00	-62.53
6940.02	-31.97	-33.90	11.72	-9.79	-13.00	-18.97
10410.03	-43.96	-45.11	11.29	-10.14	-13.00	-30.96

Unless otherwise stated the results shown in this test report refer only to the sample(s) tested and such sample(s) are retained for 90 days only.

除非另有說明，此報告結果僅對測試之樣品負責，同時此樣品僅保留90天。本報告未經本公司書面許可，不可部份複製。

This document is issued by the Company subject to its General Conditions of Service printed overleaf, available on request or accessible at <http://www.sgs.com.tw/Terms-and-Conditions> and for electronic format documents, subject to Terms and Conditions for Electronic Documents at <http://www.sgs.com.tw/Terms-and-Conditions>. Attention is drawn to the limitation of liability, indemnification and jurisdiction issues defined therein. Any holder of this document is advised that information contained hereon reflects the Company's findings at the time of its intervention only and within the limits of Client's instructions, if any. The Company's sole responsibility is to its Client and this document does not exonerate parties to a transaction from exercising all their rights and obligations under the transaction documents. This document cannot be reproduced except in full, without prior written approval of the Company. Any unauthorized alteration, forgery or falsification of the content or appearance of this document is unlawful and offenders may be prosecuted to the fullest extent of the law.

Report Number :ER/2022/30084
 Operation Mode :n77
 Test Mode :Tx CH Mid
 EUT Pol :H Plane
 Test Frequency :3500.01 MHz

Test Site :SAC 1
 Test Date :2022-05-11
 Temp./Humi. :20.6/71
 Antenna Pol. :Vertical
 Engineer :GN Lin

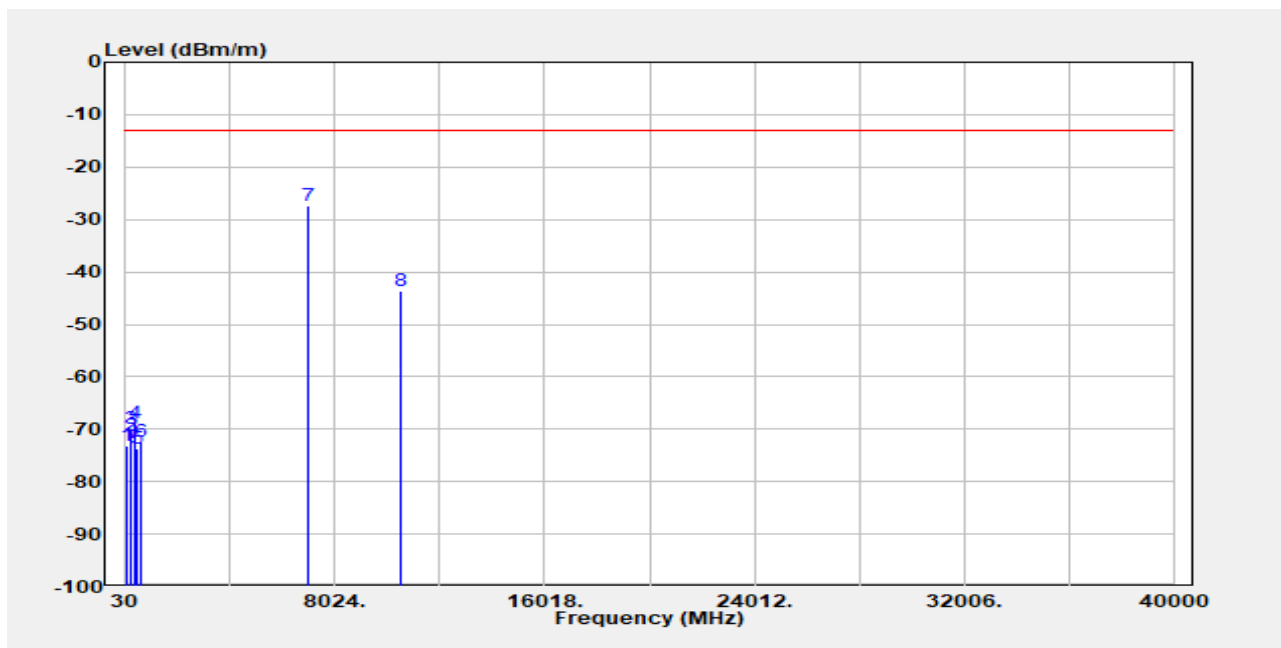

Freq. MHz	EIRP/ERP dBm	SG Output Level dBm	Antenna Gain dBi/dBd	Cable Loss dB	Limit dBm	Margin dB
48.43	-73.28	-60.45	-12.13	-0.70	-13.00	-60.28
196.84	-71.22	-73.85	4.06	-1.43	-13.00	-58.22
252.13	-69.93	-72.66	4.33	-1.60	-13.00	-56.93
398.60	-68.94	-71.14	4.32	-2.12	-13.00	-55.94
480.08	-73.62	-75.38	4.21	-2.44	-13.00	-60.62
640.13	-72.34	-73.68	3.51	-2.16	-13.00	-59.34
7000.02	-27.48	-29.33	11.50	-9.65	-13.00	-14.48
10500.03	-43.60	-43.89	11.20	-10.92	-13.00	-30.60

Unless otherwise stated the results shown in this test report refer only to the sample(s) tested and such sample(s) are retained for 90 days only.

除非另有說明，此報告結果僅對測試之樣品負責，同時此樣品僅保留90天。本報告未經本公司書面許可，不可部份複製。

This document is issued by the Company subject to its General Conditions of Service printed overleaf, available on request or accessible at <http://www.sgs.com.tw/Terms-and-Conditions> and for electronic format documents, subject to Terms and Conditions for Electronic Documents at <http://www.sgs.com.tw/Terms-and-Conditions>. Attention is drawn to the limitation of liability, indemnification and jurisdiction issues defined therein. Any holder of this document is advised that information contained hereon reflects the Company's findings at the time of its intervention only and within the limits of Client's instructions, if any. The Company's sole responsibility is to its Client and this document does not exonerate parties to a transaction from exercising all their rights and obligations under the transaction documents. This document cannot be reproduced except in full, without prior written approval of the Company. Any unauthorized alteration, forgery or falsification of the content or appearance of this document is unlawful and offenders may be prosecuted to the fullest extent of the law.

Report Number :ER/2022/30084
 Operation Mode :n77
 Test Mode :Tx CH Mid
 EUT Pol :H Plane
 Test Frequency :3500.01 MHz

Test Site :SAC 1
 Test Date :2022-05-11
 Temp./Humi. :20.6/71
 Antenna Pol. :Horizontal
 Engineer :GN Lin

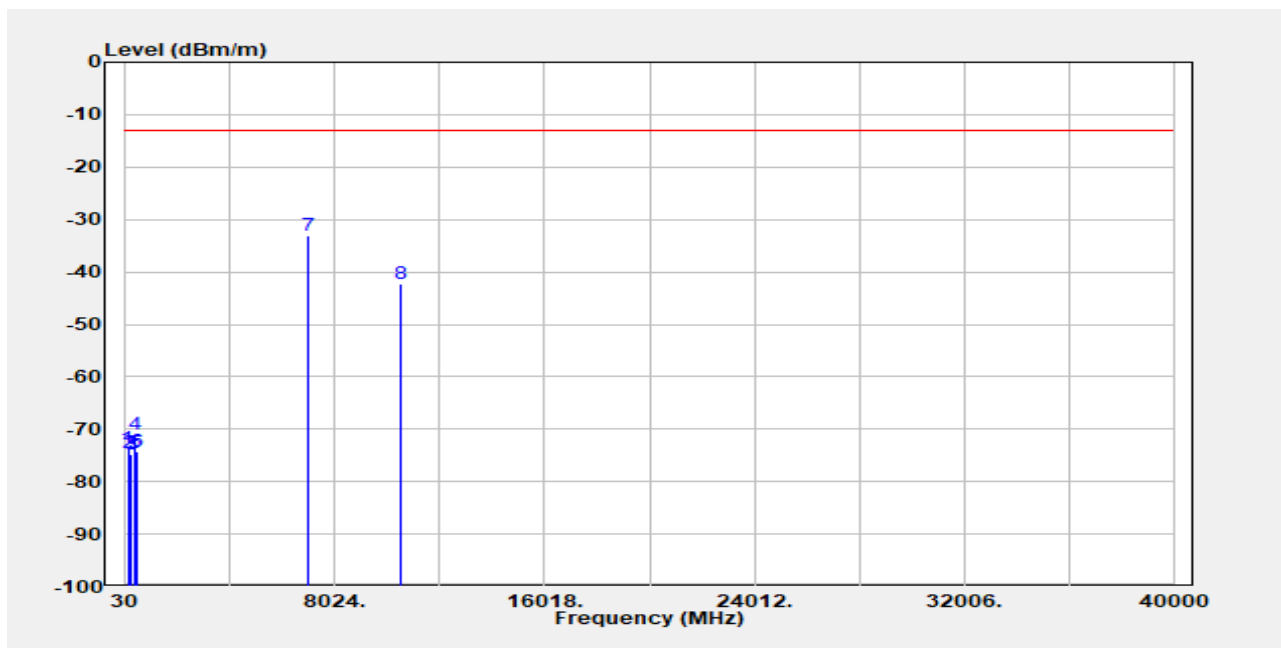

Freq. MHz	EIRP/ERP dBm	SG Output Level dBm	Antenna Gain dBi/dBd	Cable Loss dB	Limit dBm	Margin dB
116.33	-73.76	-71.05	-1.61	-1.10	-13.00	-60.76
128.94	-74.66	-71.49	-2.00	-1.17	-13.00	-61.66
252.13	-74.81	-77.54	4.33	-1.60	-13.00	-61.81
394.72	-70.96	-73.20	4.32	-2.08	-13.00	-57.96
424.79	-74.56	-76.67	4.06	-1.95	-13.00	-61.56
480.08	-74.39	-76.15	4.21	-2.44	-13.00	-61.39
7000.02	-32.94	-34.79	11.50	-9.65	-13.00	-19.94
10500.03	-42.37	-42.65	11.20	-10.92	-13.00	-29.37

Unless otherwise stated the results shown in this test report refer only to the sample(s) tested and such sample(s) are retained for 90 days only.

除非另有說明，此報告結果僅對測試之樣品負責，同時此樣品僅保留90天。本報告未經本公司書面許可，不可部份複製。

This document is issued by the Company subject to its General Conditions of Service printed overleaf, available on request or accessible at <http://www.sgs.com.tw/Terms-and-Conditions> and for electronic format documents, subject to Terms and Conditions for Electronic Documents at <http://www.sgs.com.tw/Terms-and-Conditions>. Attention is drawn to the limitation of liability, indemnification and jurisdiction issues defined therein. Any holder of this document is advised that information contained hereon reflects the Company's findings at the time of its intervention only and within the limits of Client's instructions, if any. The Company's sole responsibility is to its Client and this document does not exonerate parties to a transaction from exercising all their rights and obligations under the transaction documents. This document cannot be reproduced except in full, without prior written approval of the Company. Any unauthorized alteration, forgery or falsification of the content or appearance of this document is unlawful and offenders may be prosecuted to the fullest extent of the law.

Report Number :ER/2022/30084
 Operation Mode :n77
 Test Mode :Tx CH High
 EUT Pol :H Plane
 Test Frequency :3529.98 MHz

Test Site :SAC 1
 Test Date :2022-05-11
 Temp./Humi. :20.6/71
 Antenna Pol. :Vertical
 Engineer :GN Lin

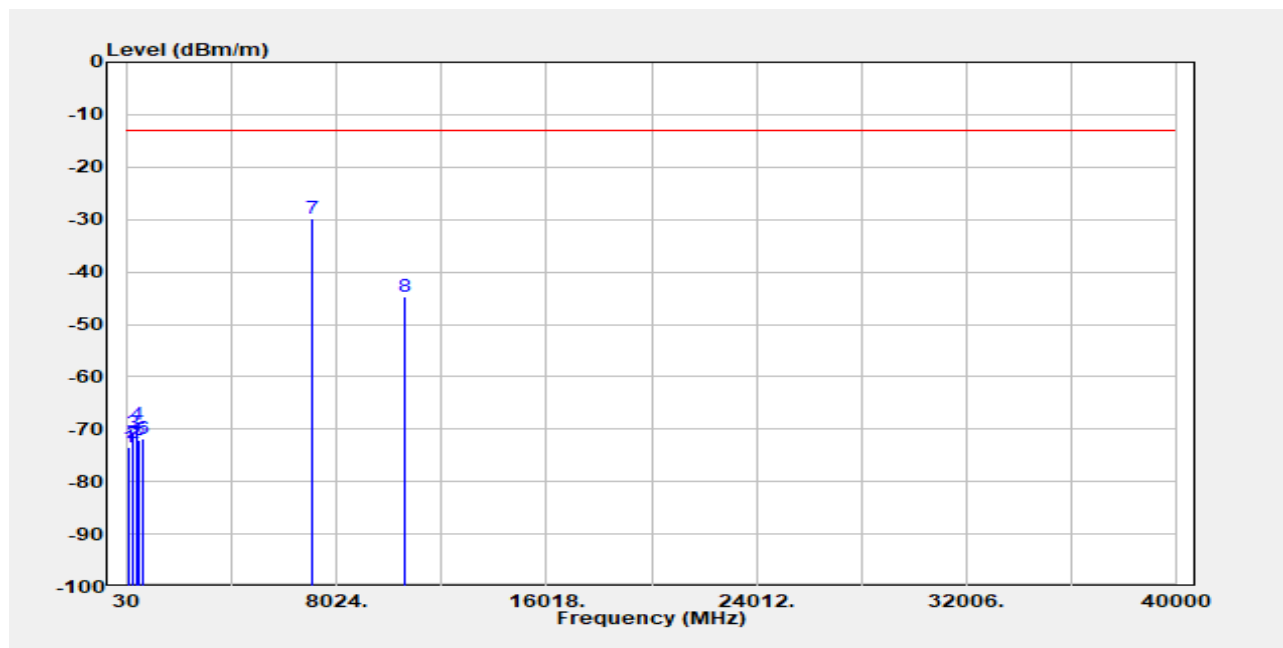

Freq. MHz	EIRP/ERP dBm	SG Output Level dBm	Antenna Gain dBi/dBd	Cable Loss dB	Limit dBm	Margin dB
48.43	-73.41	-60.58	-12.13	-0.70	-13.00	-60.41
194.90	-72.62	-75.07	3.88	-1.43	-13.00	-59.62
252.13	-70.81	-73.54	4.33	-1.60	-13.00	-57.81
402.48	-68.99	-71.26	4.33	-2.06	-13.00	-55.99
480.08	-72.10	-73.86	4.21	-2.44	-13.00	-59.10
600.36	-71.87	-72.87	3.64	-2.64	-13.00	-58.87
7059.96	-29.87	-31.34	11.24	-9.77	-13.00	-16.87
10589.94	-44.70	-44.58	11.29	-11.42	-13.00	-31.70

Unless otherwise stated the results shown in this test report refer only to the sample(s) tested and such sample(s) are retained for 90 days only.

除非另有說明，此報告結果僅對測試之樣品負責，同時此樣品僅保留90天。本報告未經本公司書面許可，不可部份複製。

This document is issued by the Company subject to its General Conditions of Service printed overleaf, available on request or accessible at <http://www.sgs.com.tw/Terms-and-Conditions> and for electronic format documents, subject to Terms and Conditions for Electronic Documents at <http://www.sgs.com.tw/Terms-and-Conditions>. Attention is drawn to the limitation of liability, indemnification and jurisdiction issues defined therein. Any holder of this document is advised that information contained hereon reflects the Company's findings at the time of its intervention only and within the limits of Client's instructions, if any. The Company's sole responsibility is to its Client and this document does not exonerate parties to a transaction from exercising all their rights and obligations under the transaction documents. This document cannot be reproduced except in full, without prior written approval of the Company. Any unauthorized alteration, forgery or falsification of the content or appearance of this document is unlawful and offenders may be prosecuted to the fullest extent of the law.

Report Number :ER/2022/30084
 Operation Mode :n77
 Test Mode :Tx CH High
 EUT Pol :H Plane
 Test Frequency :3529.98 MHz

Test Site :SAC 1
 Test Date :2022-05-11
 Temp./Humi. :20.6/71
 Antenna Pol. :Horizontal
 Engineer :GN Lin

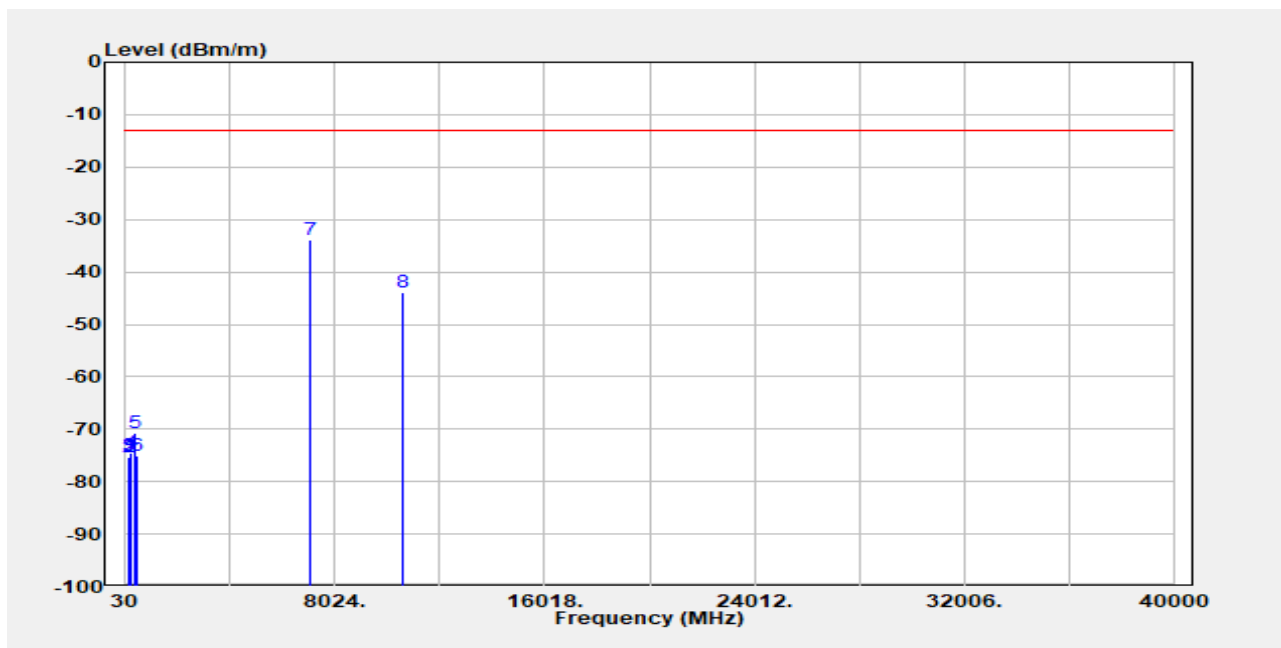

Freq. MHz	EIRP/ERP dBm	SG Output Level dBm	Antenna Gain dBi/dBd	Cable Loss dB	Limit dBm	Margin dB
118.27	-75.30	-72.47	-1.72	-1.12	-13.00	-62.30
128.94	-75.27	-72.11	-2.00	-1.17	-13.00	-62.27
191.99	-74.97	-77.08	3.54	-1.43	-13.00	-61.97
252.13	-74.55	-77.28	4.33	-1.60	-13.00	-61.55
397.63	-70.69	-72.89	4.32	-2.11	-13.00	-57.69
480.08	-75.10	-76.87	4.21	-2.44	-13.00	-62.10
7059.96	-33.97	-35.43	11.24	-9.77	-13.00	-20.97
10589.94	-43.87	-43.74	11.29	-11.42	-13.00	-30.87

Unless otherwise stated the results shown in this test report refer only to the sample(s) tested and such sample(s) are retained for 90 days only.

除非另有說明，此報告結果僅對測試之樣品負責，同時此樣品僅保留90天。本報告未經本公司書面許可，不可部份複製。

This document is issued by the Company subject to its General Conditions of Service printed overleaf, available on request or accessible at <http://www.sgs.com.tw/Terms-and-Conditions> and for electronic format documents, subject to Terms and Conditions for Electronic Documents at <http://www.sgs.com.tw/Terms-and-Conditions>. Attention is drawn to the limitation of liability, indemnification and jurisdiction issues defined therein. Any holder of this document is advised that information contained hereon reflects the Company's findings at the time of its intervention only and within the limits of Client's instructions, if any. The Company's sole responsibility is to its Client and this document does not exonerate parties to a transaction from exercising all their rights and obligations under the transaction documents. This document cannot be reproduced except in full, without prior written approval of the Company. Any unauthorized alteration, forgery or falsification of the content or appearance of this document is unlawful and offenders may be prosecuted to the fullest extent of the law.

Report Number :ER/2022/30084
 Operation Mode :n77
 Test Mode :Tx CH Low
 EUT Pol :H Plane
 Test Frequency :3750 MHz

Test Site :SAC 1
 Test Date :2022-05-11
 Temp./Humi. :20.6/71
 Antenna Pol. :Vertical
 Engineer :GN Lin

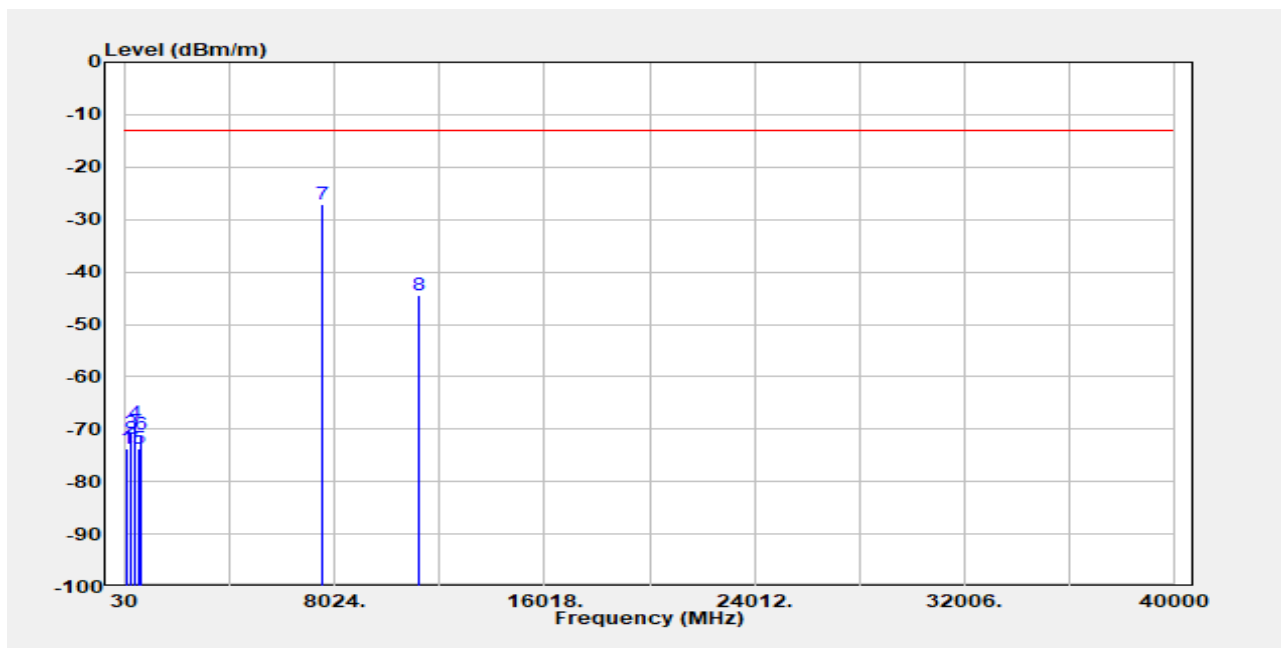

Freq. MHz	EIRP/ERP dBm	SG Output Level dBm	Antenna Gain dBi/dBd	Cable Loss dB	Limit dBm	Margin dB
49.40	-73.80	-61.17	-11.93	-0.70	-13.00	-60.80
197.81	-71.71	-74.47	4.19	-1.43	-13.00	-58.71
253.10	-70.84	-73.56	4.32	-1.60	-13.00	-57.84
395.69	-68.74	-70.96	4.31	-2.09	-13.00	-55.74
539.25	-73.66	-75.72	4.40	-2.34	-13.00	-60.66
604.24	-71.00	-72.03	3.62	-2.58	-13.00	-58.00
7500.00	-27.23	-29.05	11.00	-9.18	-13.00	-14.23
11250.00	-44.48	-43.95	11.60	-12.13	-13.00	-31.48

Unless otherwise stated the results shown in this test report refer only to the sample(s) tested and such sample(s) are retained for 90 days only.

除非另有說明，此報告結果僅對測試之樣品負責，同時此樣品僅保留90天。本報告未經本公司書面許可，不可部份複製。

This document is issued by the Company subject to its General Conditions of Service printed overleaf, available on request or accessible at <http://www.sgs.com.tw/Terms-and-Conditions> and for electronic format documents, subject to Terms and Conditions for Electronic Documents at <http://www.sgs.com.tw/Terms-and-Conditions>. Attention is drawn to the limitation of liability, indemnification and jurisdiction issues defined therein. Any holder of this document is advised that information contained hereon reflects the Company's findings at the time of its intervention only and within the limits of Client's instructions, if any. The Company's sole responsibility is to its Client and this document does not exonerate parties to a transaction from exercising all their rights and obligations under the transaction documents. This document cannot be reproduced except in full, without prior written approval of the Company. Any unauthorized alteration, forgery or falsification of the content or appearance of this document is unlawful and offenders may be prosecuted to the fullest extent of the law.

Report Number :ER/2022/30084
 Operation Mode :n77
 Test Mode :Tx CH Low
 EUT Pol :H Plane
 Test Frequency :3750 MHz

Test Site :SAC 1
 Test Date :2022-05-11
 Temp./Humi. :20.6/71
 Antenna Pol. :Horizontal
 Engineer :GN Lin

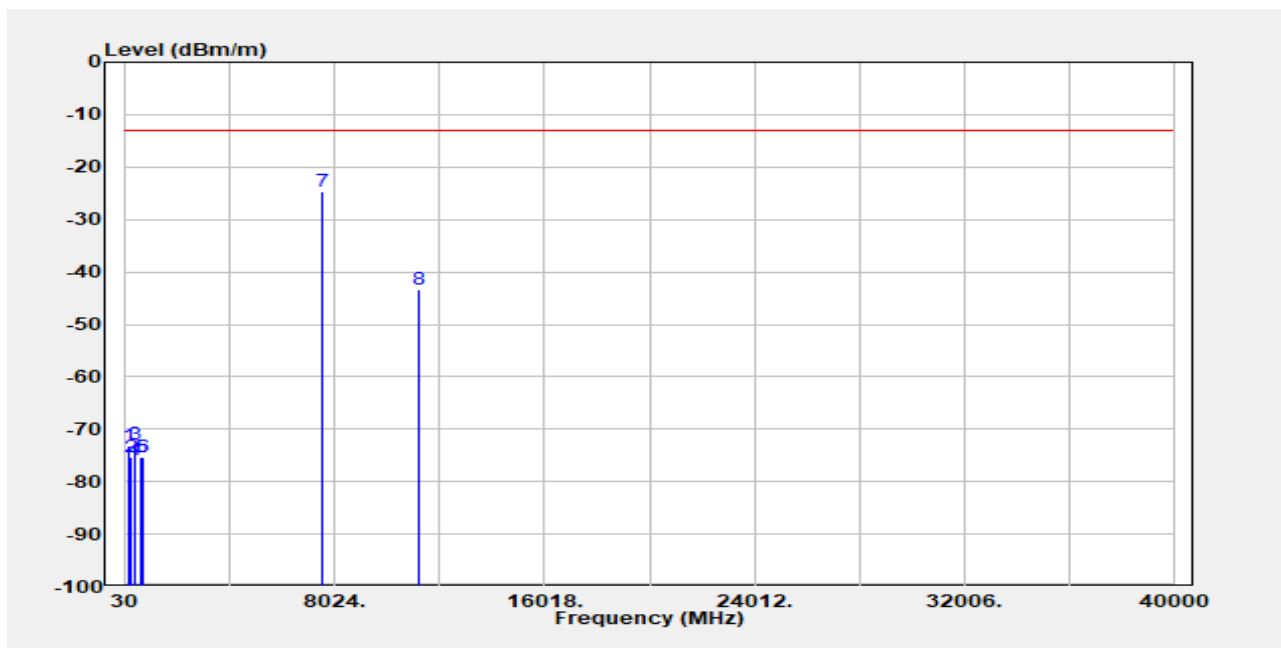

Freq. MHz	EIRP/ERP dBm	SG Output Level dBm	Antenna Gain dBi/dBd	Cable Loss dB	Limit dBm	Margin dB
118.27	-73.18	-70.35	-1.72	-1.12	-13.00	-60.18
253.10	-75.27	-77.99	4.32	-1.60	-13.00	-62.27
394.72	-72.80	-75.04	4.32	-2.08	-13.00	-59.80
420.91	-75.80	-78.11	4.21	-1.90	-13.00	-62.80
604.24	-75.47	-76.50	3.62	-2.58	-13.00	-62.47
690.57	-75.44	-76.18	3.75	-3.02	-13.00	-62.44
7500.00	-24.69	-26.52	11.00	-9.18	-13.00	-11.69
11250.00	-43.45	-42.92	11.60	-12.13	-13.00	-30.45

Unless otherwise stated the results shown in this test report refer only to the sample(s) tested and such sample(s) are retained for 90 days only.

除非另有說明，此報告結果僅對測試之樣品負責，同時此樣品僅保留90天。本報告未經本公司書面許可，不可部份複製。

This document is issued by the Company subject to its General Conditions of Service printed overleaf, available on request or accessible at <http://www.sgs.com.tw/Terms-and-Conditions> and for electronic format documents, subject to Terms and Conditions for Electronic Documents at <http://www.sgs.com.tw/Terms-and-Conditions>. Attention is drawn to the limitation of liability, indemnification and jurisdiction issues defined therein. Any holder of this document is advised that information contained hereon reflects the Company's findings at the time of its intervention only and within the limits of Client's instructions, if any. The Company's sole responsibility is to its Client and this document does not exonerate parties to a transaction from exercising all their rights and obligations under the transaction documents. This document cannot be reproduced except in full, without prior written approval of the Company. Any unauthorized alteration, forgery or falsification of the content or appearance of this document is unlawful and offenders may be prosecuted to the fullest extent of the law.

Report Number :ER/2022/30084
 Operation Mode :n77
 Test Mode :Tx CH Mid
 EUT Pol :H Plane
 Test Frequency :3840 MHz

Test Site :SAC 1
 Test Date :2022-05-11
 Temp./Humi. :20.6/71
 Antenna Pol. :Vertical
 Engineer :GN Lin

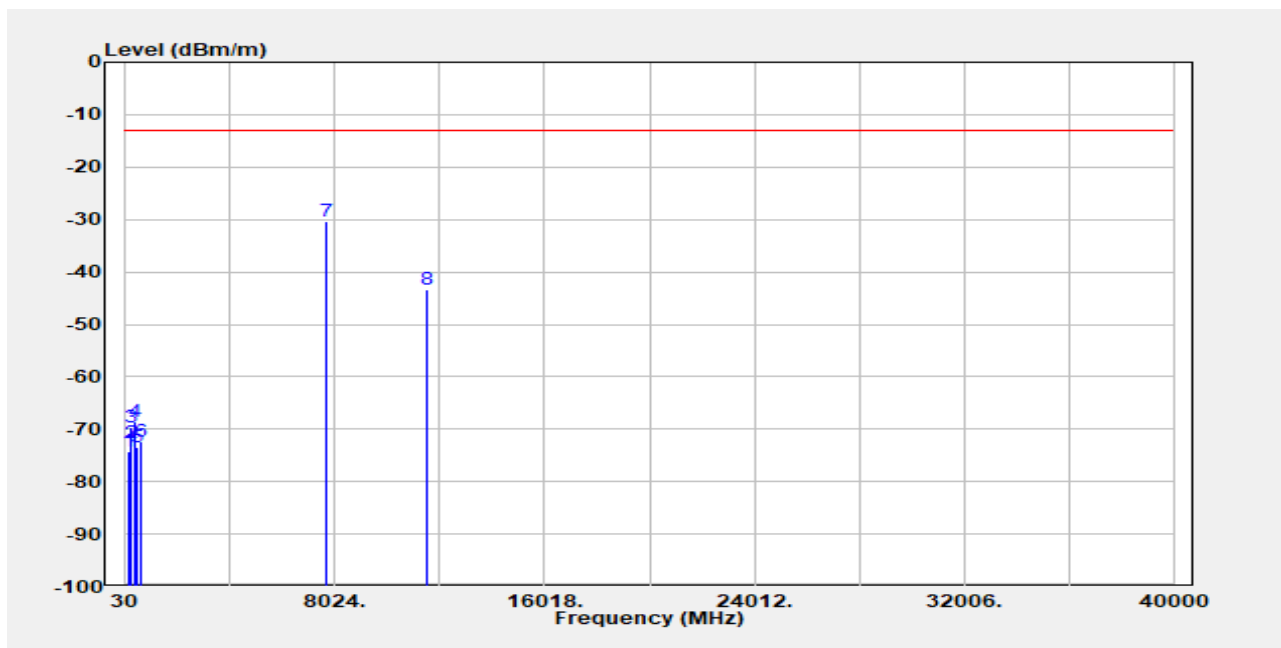

Freq. MHz	EIRP/ERP dBm	SG Output Level dBm	Antenna Gain dBi/dBd	Cable Loss dB	Limit dBm	Margin dB
120.21	-74.28	-71.35	-1.80	-1.13	-13.00	-61.28
195.87	-72.58	-75.16	4.01	-1.43	-13.00	-59.58
253.10	-69.75	-72.46	4.32	-1.60	-13.00	-56.75
398.60	-68.66	-70.86	4.32	-2.12	-13.00	-55.66
480.08	-73.33	-75.09	4.21	-2.44	-13.00	-60.33
591.63	-72.23	-73.37	3.79	-2.65	-13.00	-59.23
7680.00	-30.38	-31.92	11.42	-9.88	-13.00	-17.38
11520.00	-43.48	-42.49	11.36	-12.35	-13.00	-30.48

Unless otherwise stated the results shown in this test report refer only to the sample(s) tested and such sample(s) are retained for 90 days only.

除非另有說明，此報告結果僅對測試之樣品負責，同時此樣品僅保留90天。本報告未經本公司書面許可，不可部份複製。

This document is issued by the Company subject to its General Conditions of Service printed overleaf, available on request or accessible at <http://www.sgs.com.tw/Terms-and-Conditions> and for electronic format documents, subject to Terms and Conditions for Electronic Documents at <http://www.sgs.com.tw/Terms-and-Conditions>. Attention is drawn to the limitation of liability, indemnification and jurisdiction issues defined therein. Any holder of this document is advised that information contained hereon reflects the Company's findings at the time of its intervention only and within the limits of Client's instructions, if any. The Company's sole responsibility is to its Client and this document does not exonerate parties to a transaction from exercising all their rights and obligations under the transaction documents. This document cannot be reproduced except in full, without prior written approval of the Company. Any unauthorized alteration, forgery or falsification of the content or appearance of this document is unlawful and offenders may be prosecuted to the fullest extent of the law.

Report Number :ER/2022/30084
 Operation Mode :n77
 Test Mode :Tx CH Mid
 EUT Pol :H Plane
 Test Frequency :3840 MHz

Test Site :SAC 1
 Test Date :2022-05-11
 Temp./Humi. :20.6/71
 Antenna Pol. :Horizontal
 Engineer :GN Lin

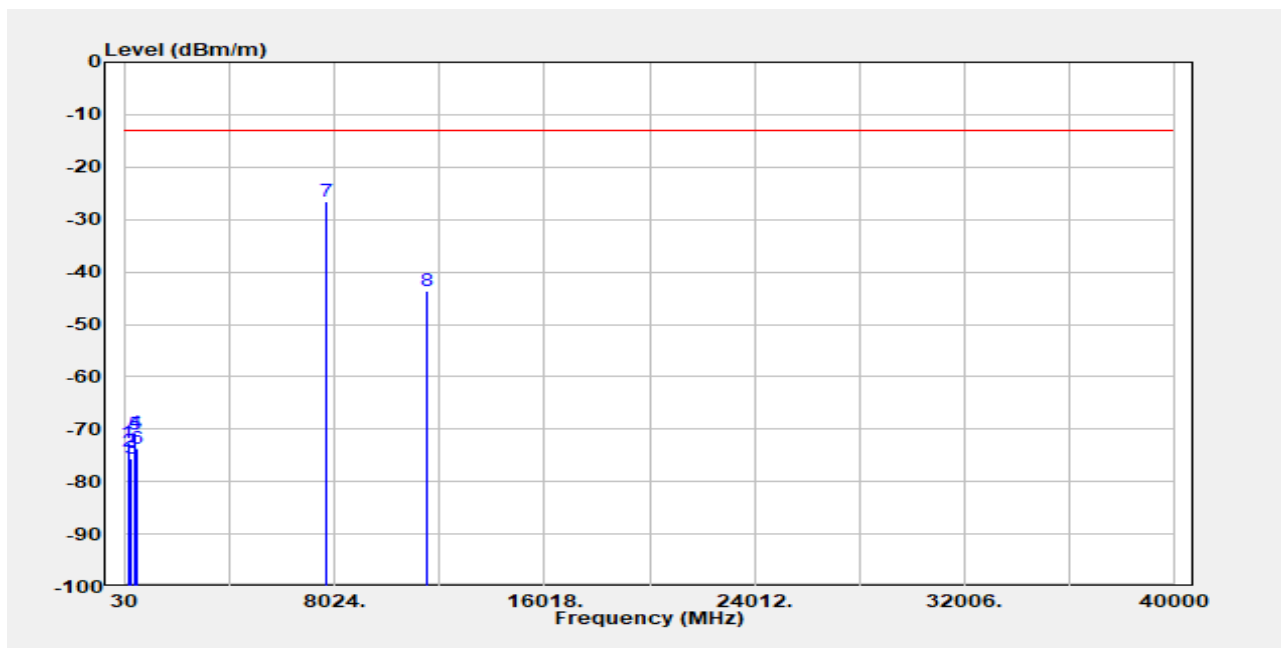

Freq. MHz	EIRP/ERP dBm	SG Output Level dBm	Antenna Gain dBi/dBd	Cable Loss dB	Limit dBm	Margin dB
116.33	-72.58	-69.87	-1.61	-1.10	-13.00	-59.58
127.97	-74.14	-71.09	-1.88	-1.16	-13.00	-61.14
194.90	-75.66	-78.11	3.88	-1.43	-13.00	-62.66
393.75	-70.64	-72.90	4.33	-2.08	-13.00	-57.64
399.57	-71.04	-73.23	4.32	-2.13	-13.00	-58.04
480.08	-73.72	-75.48	4.21	-2.44	-13.00	-60.72
7680.00	-26.54	-28.09	11.42	-9.88	-13.00	-13.54
11520.00	-43.64	-42.65	11.36	-12.35	-13.00	-30.64

Unless otherwise stated the results shown in this test report refer only to the sample(s) tested and such sample(s) are retained for 90 days only.

除非另有說明，此報告結果僅對測試之樣品負責，同時此樣品僅保留90天。本報告未經本公司書面許可，不可部份複製。

This document is issued by the Company subject to its General Conditions of Service printed overleaf, available on request or accessible at <http://www.sgs.com.tw/Terms-and-Conditions> and for electronic format documents, subject to Terms and Conditions for Electronic Documents at <http://www.sgs.com.tw/Terms-and-Conditions>. Attention is drawn to the limitation of liability, indemnification and jurisdiction issues defined therein. Any holder of this document is advised that information contained hereon reflects the Company's findings at the time of its intervention only and within the limits of Client's instructions, if any. The Company's sole responsibility is to its Client and this document does not exonerate parties to a transaction from exercising all their rights and obligations under the transaction documents. This document cannot be reproduced except in full, without prior written approval of the Company. Any unauthorized alteration, forgery or falsification of the content or appearance of this document is unlawful and offenders may be prosecuted to the fullest extent of the law.

Report Number :ER/2022/30084
 Operation Mode :n77
 Test Mode :Tx CH High
 EUT Pol :H Plane
 Test Frequency :3930 MHz

Test Site :SAC 1
 Test Date :2022-05-11
 Temp./Humi. :20.6/71
 Antenna Pol. :Vertical
 Engineer :GN Lin

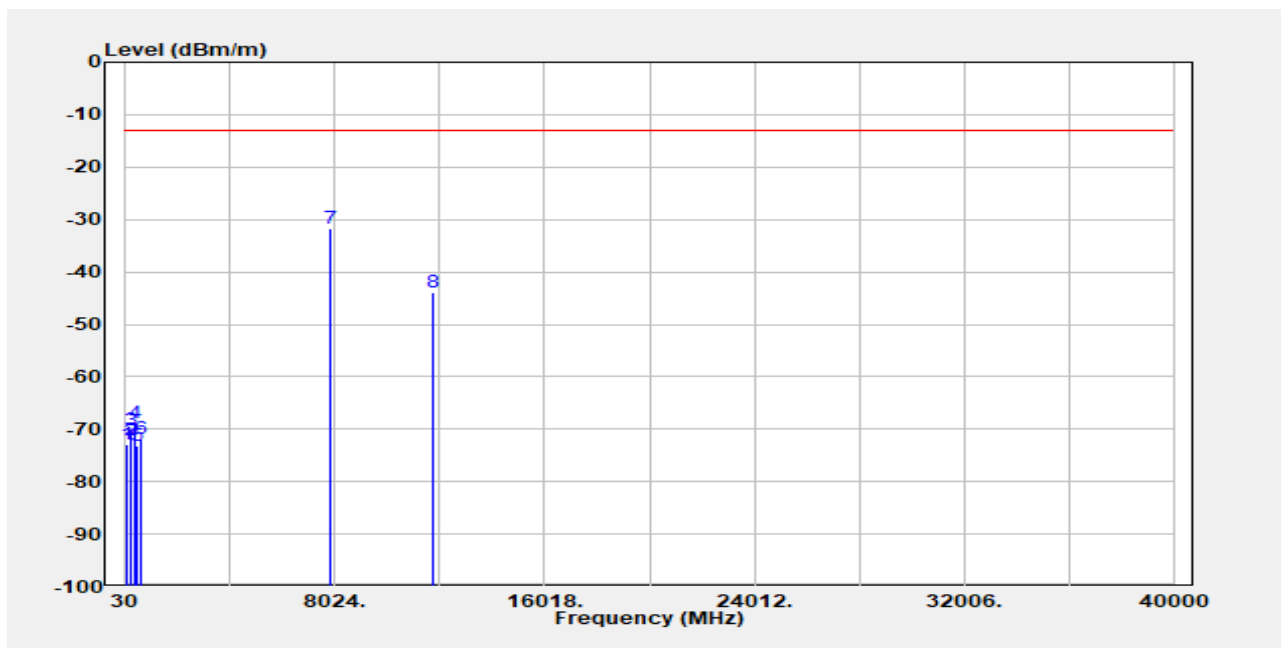

Freq. MHz	EIRP/ERP dBm	SG Output Level dBm	Antenna Gain dBi/dBd	Cable Loss dB	Limit dBm	Margin dB
48.43	-72.92	-60.09	-12.13	-0.70	-13.00	-59.92
195.87	-72.10	-74.67	4.01	-1.43	-13.00	-59.10
253.10	-70.10	-72.81	4.32	-1.60	-13.00	-57.10
397.63	-68.91	-71.12	4.32	-2.11	-13.00	-55.91
480.08	-73.13	-74.89	4.21	-2.44	-13.00	-60.13
595.51	-71.80	-72.91	3.76	-2.65	-13.00	-58.80
7860.00	-31.59	-32.24	11.28	-10.62	-13.00	-18.59
11790.00	-43.87	-44.06	12.47	-12.28	-13.00	-30.87

Unless otherwise stated the results shown in this test report refer only to the sample(s) tested and such sample(s) are retained for 90 days only.

除非另有說明，此報告結果僅對測試之樣品負責，同時此樣品僅保留90天。本報告未經本公司書面許可，不可部份複製。

This document is issued by the Company subject to its General Conditions of Service printed overleaf, available on request or accessible at <http://www.sgs.com.tw/Terms-and-Conditions> and for electronic format documents, subject to Terms and Conditions for Electronic Documents at <http://www.sgs.com.tw/Terms-and-Conditions>. Attention is drawn to the limitation of liability, indemnification and jurisdiction issues defined therein. Any holder of this document is advised that information contained hereon reflects the Company's findings at the time of its intervention only and within the limits of Client's instructions, if any. The Company's sole responsibility is to its Client and this document does not exonerate parties to a transaction from exercising all their rights and obligations under the transaction documents. This document cannot be reproduced except in full, without prior written approval of the Company. Any unauthorized alteration, forgery or falsification of the content or appearance of this document is unlawful and offenders may be prosecuted to the fullest extent of the law.

Report Number :ER/2022/30084
 Operation Mode :n77
 Test Mode :Tx CH High
 EUT Pol :H Plane
 Test Frequency :3930 MHz

Test Site :SAC 1
 Test Date :2022-05-11
 Temp./Humi. :20.6/71
 Antenna Pol. :Horizontal
 Engineer :GN Lin

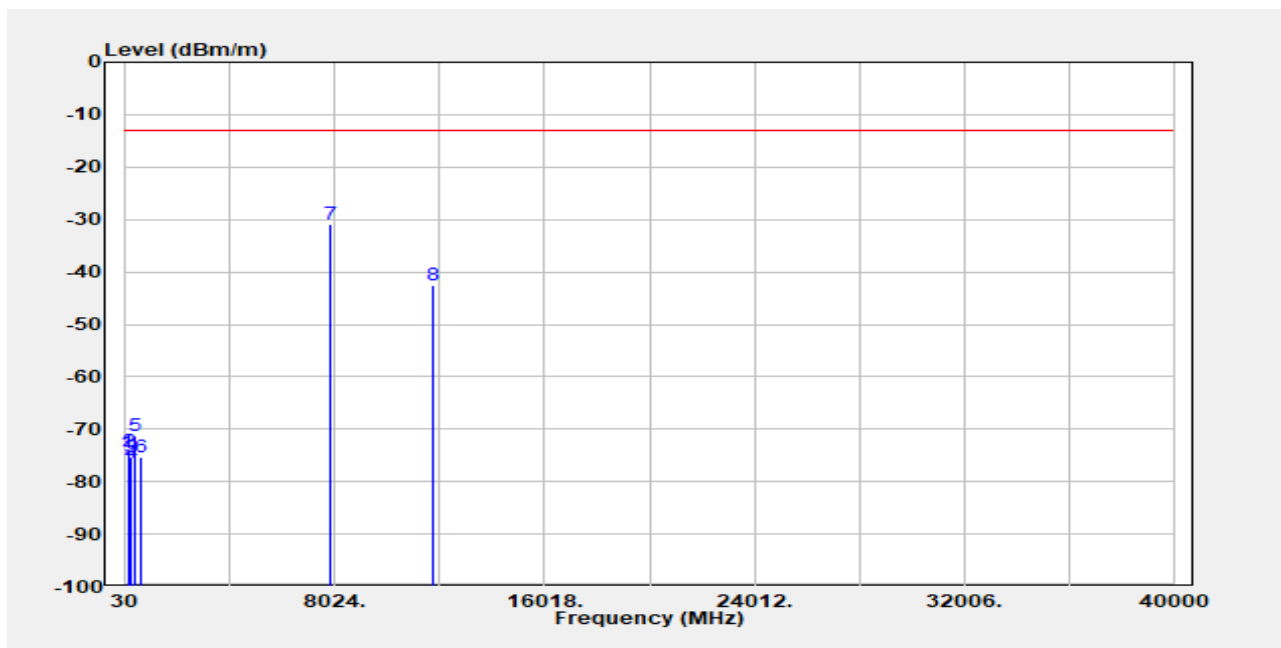

Freq. MHz	EIRP/ERP dBm	SG Output Level dBm	Antenna Gain dBi/dBd	Cable Loss dB	Limit dBm	Margin dB
115.36	-74.50	-71.70	-1.71	-1.10	-13.00	-61.50
161.92	-74.31	-72.03	-1.03	-1.25	-13.00	-61.31
197.81	-75.22	-77.98	4.19	-1.43	-13.00	-62.22
252.13	-76.33	-79.05	4.33	-1.60	-13.00	-63.33
393.75	-71.21	-73.47	4.33	-2.08	-13.00	-58.21
644.01	-75.37	-76.65	3.56	-2.28	-13.00	-62.37
7860.00	-30.88	-31.53	11.28	-10.62	-13.00	-17.88
11790.00	-42.63	-42.82	12.47	-12.28	-13.00	-29.63

Unless otherwise stated the results shown in this test report refer only to the sample(s) tested and such sample(s) are retained for 90 days only.

除非另有說明，此報告結果僅對測試之樣品負責，同時此樣品僅保留90天。本報告未經本公司書面許可，不可部份複製。

This document is issued by the Company subject to its General Conditions of Service printed overleaf, available on request or accessible at <http://www.sgs.com.tw/Terms-and-Conditions> and for electronic format documents, subject to Terms and Conditions for Electronic Documents at <http://www.sgs.com.tw/Terms-and-Conditions>. Attention is drawn to the limitation of liability, indemnification and jurisdiction issues defined therein. Any holder of this document is advised that information contained hereon reflects the Company's findings at the time of its intervention only and within the limits of Client's instructions, if any. The Company's sole responsibility is to its Client and this document does not exonerate parties to a transaction from exercising all their rights and obligations under the transaction documents. This document cannot be reproduced except in full, without prior written approval of the Company. Any unauthorized alteration, forgery or falsification of the content or appearance of this document is unlawful and offenders may be prosecuted to the fullest extent of the law.

ENDC

Report Number :ER/2022/30084
 Operation Mode :5A_n2A
 Test Mode :Tx CH Low_Mid
 EUT Pol :H Plane
 Test Frequency :829_1880 MHz

Test Site :SAC 1
 Test Date :2022-05-12
 Temp./Humi. :25.7/70
 Antenna Pol. :Vertical
 Engineer :GN Lin

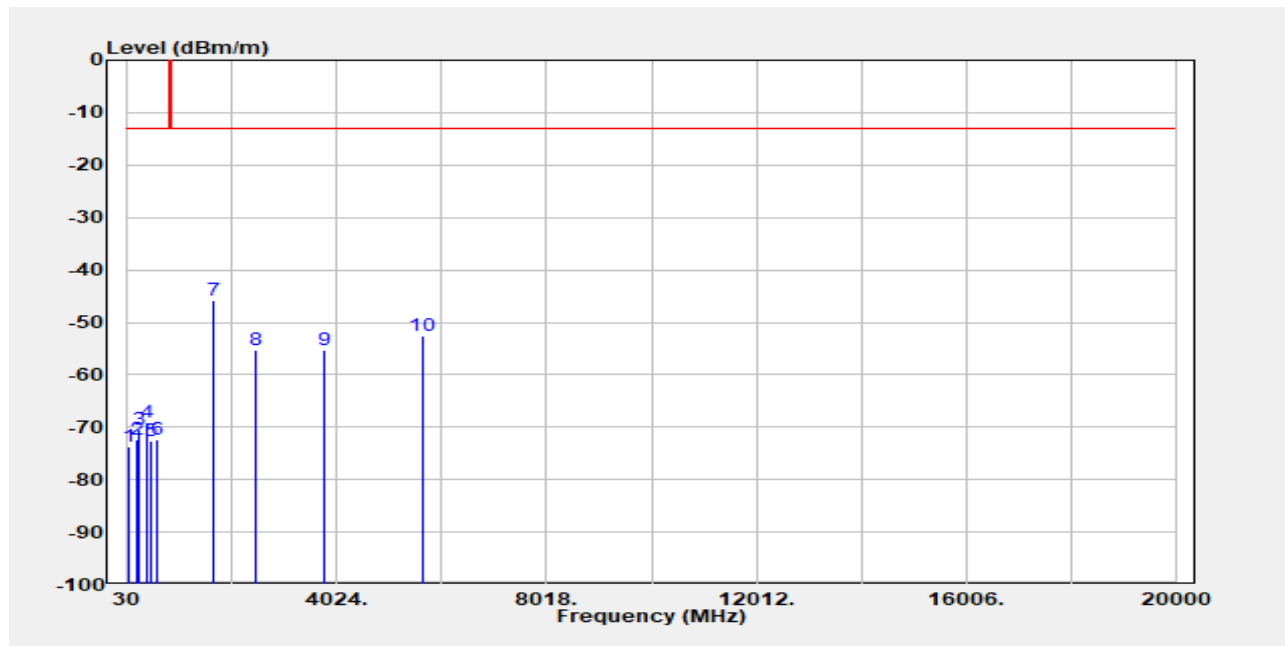

Freq. MHz	EIRP/ERP dBm	SG Output Level dBm	Antenna Gain dBi/dBd	Cable Loss dB	Limit dBm	Margin dB
48.43	-73.62	-60.79	-12.13	-0.70	-13.00	-60.62
194.90	-72.44	-74.88	3.88	-1.43	-13.00	-59.44
252.13	-70.48	-73.20	4.33	-1.60	-13.00	-57.48
394.72	-68.97	-71.20	4.32	-2.08	-13.00	-55.97
480.08	-72.57	-74.33	4.21	-2.44	-13.00	-59.57
607.15	-72.33	-73.35	3.56	-2.54	-13.00	-59.33
1658.00	-45.89	-51.14	9.52	-4.27	-13.00	-32.89
2487.00	-55.33	-60.73	10.57	-5.18	-13.00	-42.32
3760.00	-55.39	-60.16	12.40	-7.63	-13.00	-42.38
5640.00	-52.60	-56.37	13.00	-9.23	-13.00	-39.59

Unless otherwise stated the results shown in this test report refer only to the sample(s) tested and such sample(s) are retained for 90 days only.

除非另有說明，此報告結果僅對測試之樣品負責，同時此樣品僅保留90天。本報告未經本公司書面許可，不可部份複製。

This document is issued by the Company subject to its General Conditions of Service printed overleaf, available on request or accessible at <http://www.sgs.com.tw/Terms-and-Conditions> and for electronic format documents, subject to Terms and Conditions for Electronic Documents at <http://www.sgs.com.tw/Terms-and-Conditions>. Attention is drawn to the limitation of liability, indemnification and jurisdiction issues defined therein. Any holder of this document is advised that information contained hereon reflects the Company's findings at the time of its intervention only and within the limits of Client's instructions, if any. The Company's sole responsibility is to its Client and this document does not exonerate parties to a transaction from exercising all their rights and obligations under the transaction documents. This document cannot be reproduced except in full, without prior written approval of the Company. Any unauthorized alteration, forgery or falsification of the content or appearance of this document is unlawful and offenders may be prosecuted to the fullest extent of the law.

Report Number :ER/2022/30084
 Operation Mode :5A_n2A
 Test Mode :Tx CH Low_Mid
 EUT Pol :H Plane
 Test Frequency :829_1880 MHz

Test Site :SAC 1
 Test Date :2022-05-12
 Temp./Humi. :25.7/70
 Antenna Pol. :Horizontal
 Engineer :GN Lin

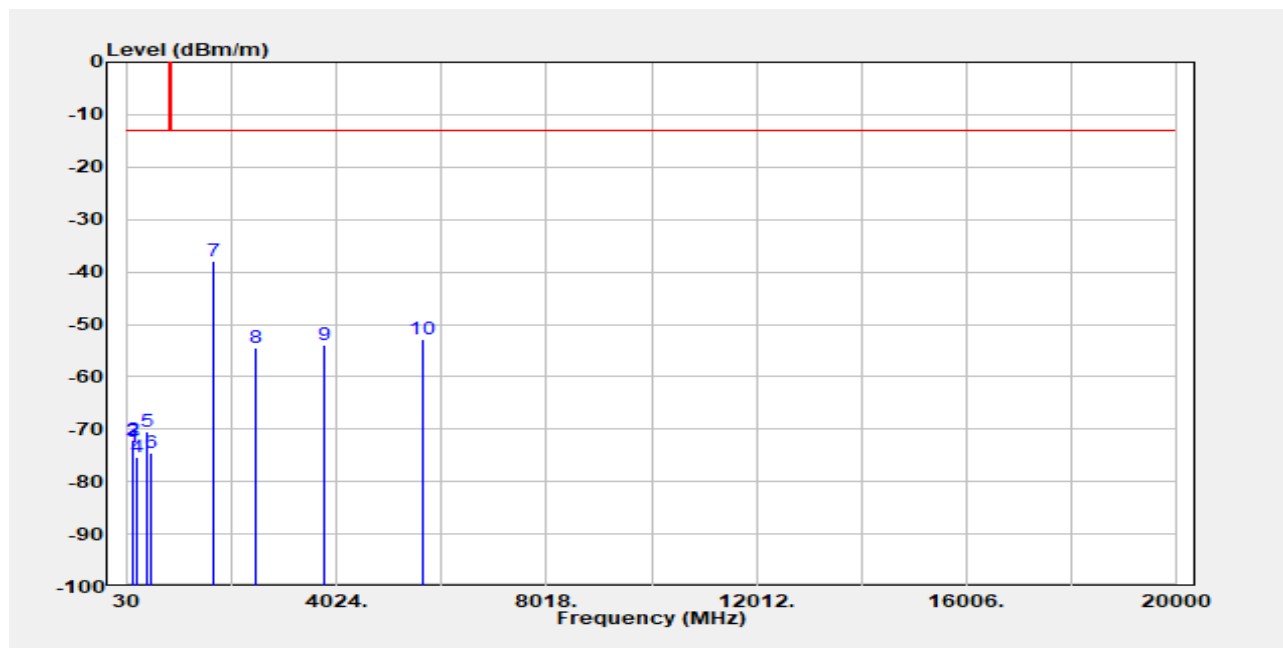

Freq. MHz	EIRP/ERP dBm	SG Output Level dBm	Antenna Gain dBi/dBd	Cable Loss dB	Limit dBm	Margin dB
116.33	-73.57	-70.86	-1.61	-1.10	-13.00	-60.57
139.61	-72.13	-68.79	-2.02	-1.32	-13.00	-59.13
147.37	-72.31	-69.27	-1.85	-1.19	-13.00	-59.31
194.90	-75.37	-77.81	3.88	-1.43	-13.00	-62.37
397.63	-70.40	-72.61	4.32	-2.11	-13.00	-57.40
480.08	-74.66	-76.42	4.21	-2.44	-13.00	-61.66
1658.00	-37.81	-43.06	9.52	-4.27	-13.00	-24.81
2487.00	-54.54	-59.93	10.57	-5.18	-13.00	-41.54
3760.00	-53.94	-58.70	12.40	-7.63	-13.00	-40.94
5640.00	-52.78	-56.55	13.00	-9.23	-13.00	-39.78

Unless otherwise stated the results shown in this test report refer only to the sample(s) tested and such sample(s) are retained for 90 days only.

除非另有說明，此報告結果僅對測試之樣品負責，同時此樣品僅保留90天。本報告未經本公司書面許可，不可部份複製。

This document is issued by the Company subject to its General Conditions of Service printed overleaf, available on request or accessible at <http://www.sgs.com.tw/Terms-and-Conditions> and for electronic format documents, subject to Terms and Conditions for Electronic Documents at <http://www.sgs.com.tw/Terms-and-Conditions>. Attention is drawn to the limitation of liability, indemnification and jurisdiction issues defined therein. Any holder of this document is advised that information contained hereon reflects the Company's findings at the time of its intervention only and within the limits of Client's instructions, if any. The Company's sole responsibility is to its Client and this document does not exonerate parties to a transaction from exercising all their rights and obligations under the transaction documents. This document cannot be reproduced except in full, without prior written approval of the Company. Any unauthorized alteration, forgery or falsification of the content or appearance of this document is unlawful and offenders may be prosecuted to the fullest extent of the law.

Report Number :ER/2022/30084
 Operation Mode :13A_n2A
 Test Mode :Tx CH Mid_Mid
 EUT Pol :H Plane
 Test Frequency :782_1880 MHz

Test Site :SAC 1
 Test Date :2022-05-12
 Temp./Humi. :25.7/70
 Antenna Pol. :Vertical
 Engineer :GN Lin

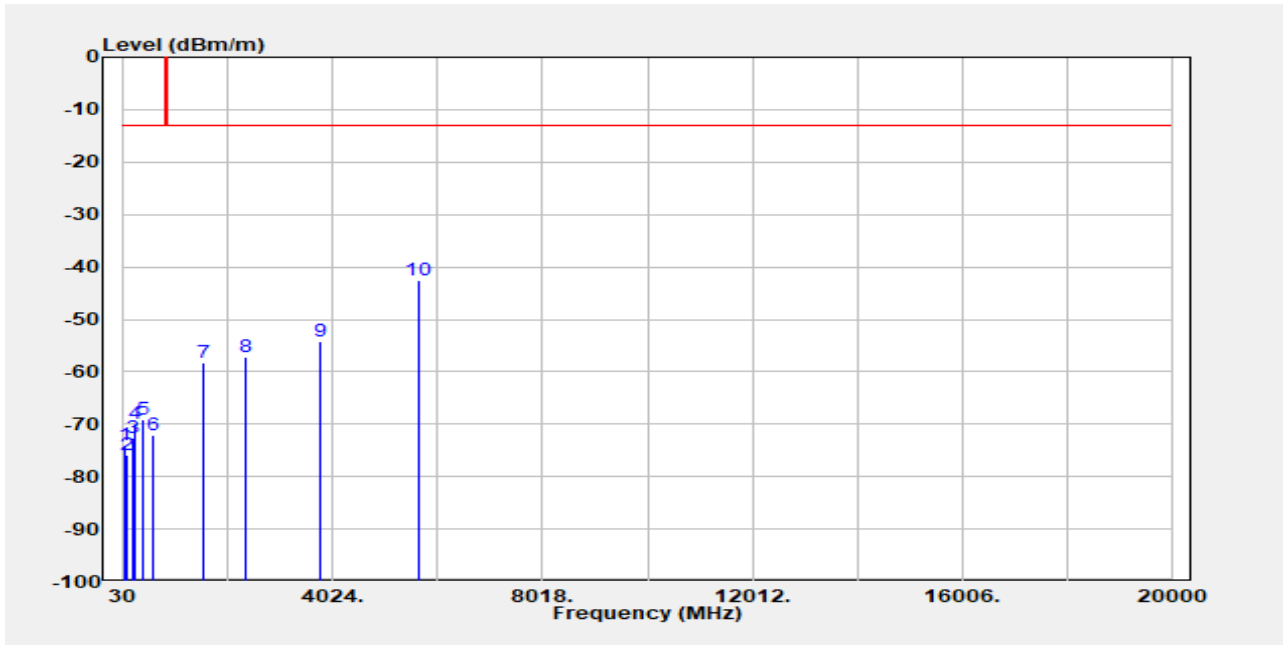

Freq. MHz	EIRP/ERP dBm	SG Output Level dBm	Antenna Gain dBi/dBd	Cable Loss dB	Limit dBm	Margin dB
48.43	-73.94	-61.11	-12.13	-0.70	-13.00	-60.94
103.72	-75.78	-73.67	-1.07	-1.03	-13.00	-62.78
194.90	-72.65	-75.09	3.88	-1.43	-13.00	-59.65
252.13	-69.90	-72.63	4.33	-1.60	-13.00	-56.90
399.57	-69.15	-71.34	4.32	-2.13	-13.00	-56.15
594.54	-72.21	-73.34	3.77	-2.65	-13.00	-59.21
1564.00	-58.30	-63.38	9.18	-4.10	-13.00	-45.30
2346.00	-57.31	-61.88	9.58	-5.01	-13.00	-44.31
3760.00	-54.23	-59.00	12.40	-7.63	-13.00	-41.23
5640.00	-42.43	-46.20	13.00	-9.23	-13.00	-29.43

Unless otherwise stated the results shown in this test report refer only to the sample(s) tested and such sample(s) are retained for 90 days only.

除非另有說明，此報告結果僅對測試之樣品負責，同時此樣品僅保留90天。本報告未經本公司書面許可，不可部份複製。

This document is issued by the Company subject to its General Conditions of Service printed overleaf, available on request or accessible at <http://www.sgs.com.tw/Terms-and-Conditions> and for electronic format documents, subject to Terms and Conditions for Electronic Documents at <http://www.sgs.com.tw/Terms-and-Conditions>. Attention is drawn to the limitation of liability, indemnification and jurisdiction issues defined therein. Any holder of this document is advised that information contained hereon reflects the Company's findings at the time of its intervention only and within the limits of Client's instructions, if any. The Company's sole responsibility is to its Client and this document does not exonerate parties to a transaction from exercising all their rights and obligations under the transaction documents. This document cannot be reproduced except in full, without prior written approval of the Company. Any unauthorized alteration, forgery or falsification of the content or appearance of this document is unlawful and offenders may be prosecuted to the fullest extent of the law.

Report Number :ER/2022/30084
 Operation Mode :13A_n2A
 Test Mode :Tx CH Mid_Mid
 EUT Pol :H Plane
 Test Frequency :782_1880 MHz

Test Site :SAC 1
 Test Date :2022-05-12
 Temp./Humi. :25.7/70
 Antenna Pol. :Horizontal
 Engineer :GN Lin

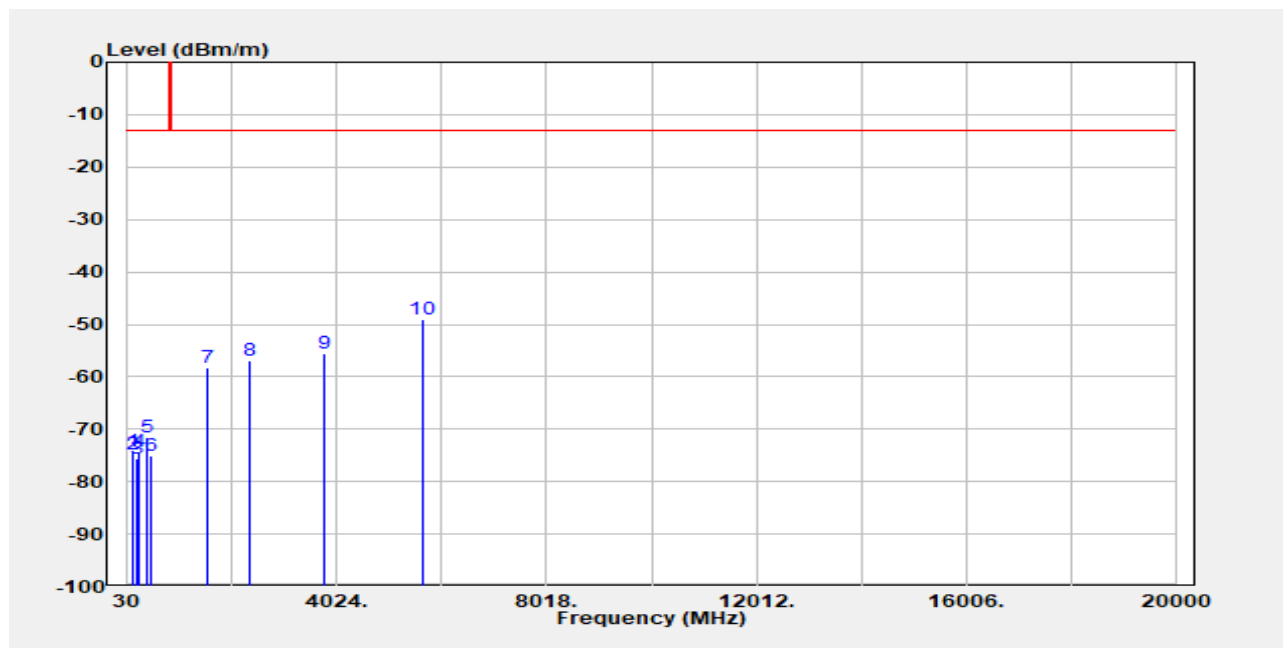

Freq. MHz	EIRP/ERP dBm	SG Output Level dBm	Antenna Gain dBi/dBd	Cable Loss dB	Limit dBm	Margin dB
115.36	-74.15	-71.35	-1.71	-1.10	-13.00	-61.15
132.82	-74.87	-71.68	-1.97	-1.21	-13.00	-61.87
197.81	-75.60	-78.35	4.19	-1.43	-13.00	-62.60
253.10	-74.27	-76.98	4.32	-1.60	-13.00	-61.27
393.75	-71.52	-73.77	4.33	-2.08	-13.00	-58.52
480.08	-75.18	-76.94	4.21	-2.44	-13.00	-62.18
1564.00	-58.14	-63.22	9.18	-4.10	-13.00	-45.14
2346.00	-56.81	-61.38	9.58	-5.01	-13.00	-43.81
3760.00	-55.43	-60.20	12.40	-7.63	-13.00	-42.43
5640.00	-48.94	-52.71	13.00	-9.23	-13.00	-35.94

Unless otherwise stated the results shown in this test report refer only to the sample(s) tested and such sample(s) are retained for 90 days only.

除非另有說明，此報告結果僅對測試之樣品負責，同時此樣品僅保留90天。本報告未經本公司書面許可，不可部份複製。

This document is issued by the Company subject to its General Conditions of Service printed overleaf, available on request or accessible at <http://www.sgs.com.tw/Terms-and-Conditions> and for electronic format documents, subject to Terms and Conditions for Electronic Documents at <http://www.sgs.com.tw/Terms-and-Conditions>. Attention is drawn to the limitation of liability, indemnification and jurisdiction issues defined therein. Any holder of this document is advised that information contained hereon reflects the Company's findings at the time of its intervention only and within the limits of Client's instructions, if any. The Company's sole responsibility is to its Client and this document does not exonerate parties to a transaction from exercising all their rights and obligations under the transaction documents. This document cannot be reproduced except in full, without prior written approval of the Company. Any unauthorized alteration, forgery or falsification of the content or appearance of this document is unlawful and offenders may be prosecuted to the fullest extent of the law.

Report Number :ER/2022/30084
 Operation Mode :66A_n2A
 Test Mode :Tx CH Low_Mid
 EUT Pol :H Plane
 Test Frequency :1720_1880 MHz

Test Site :SAC 1
 Test Date :2022-05-12
 Temp./Humi. :25.7/70
 Antenna Pol. :Vertical
 Engineer :GN Lin

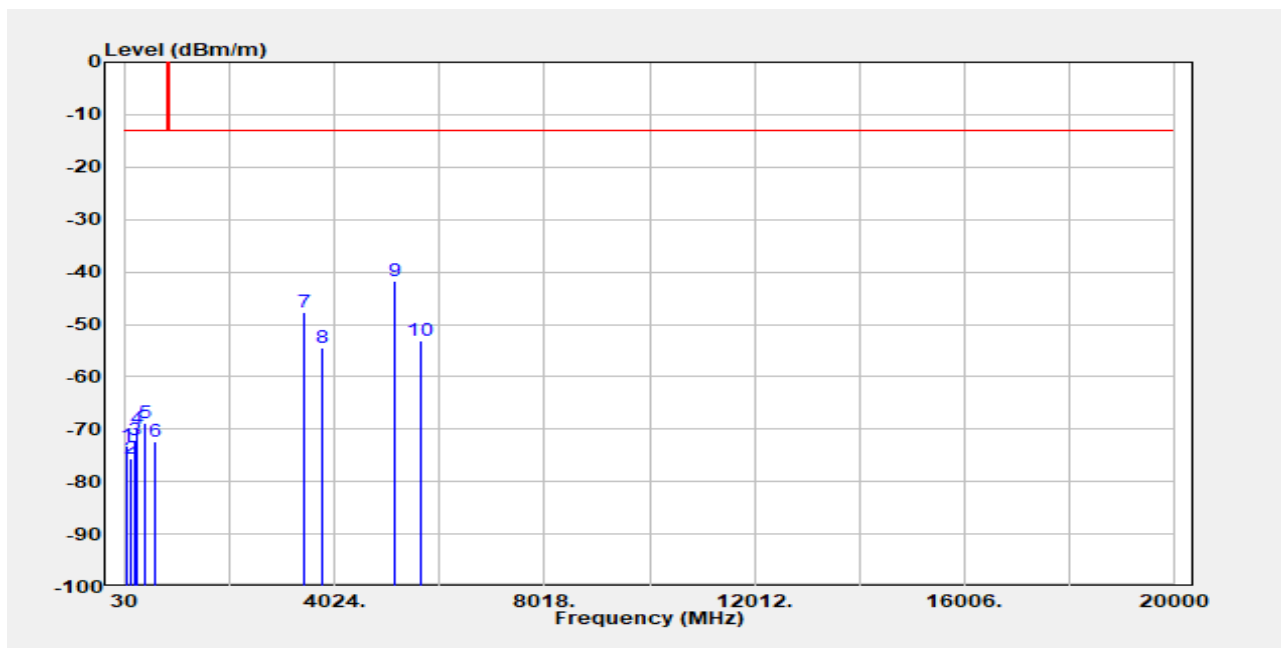

Freq. MHz	EIRP/ERP dBm	SG Output Level dBm	Antenna Gain dBi/dBd	Cable Loss dB	Limit dBm	Margin dB
48.43	-73.07	-60.24	-12.13	-0.70	-13.00	-60.07
124.09	-75.72	-72.72	-1.85	-1.15	-13.00	-62.72
195.87	-72.00	-74.58	4.01	-1.43	-13.00	-59.00
252.13	-69.96	-72.69	4.33	-1.60	-13.00	-56.96
398.60	-68.76	-70.96	4.32	-2.12	-13.00	-55.76
597.45	-72.39	-73.45	3.71	-2.65	-13.00	-59.39
3440.00	-47.79	-54.37	12.52	-5.95	-13.00	-34.79
3760.00	-54.35	-59.12	12.40	-7.63	-13.00	-41.35
5160.00	-41.74	-45.97	12.16	-7.93	-13.00	-28.74
5640.00	-53.03	-56.80	13.00	-9.23	-13.00	-40.03

Unless otherwise stated the results shown in this test report refer only to the sample(s) tested and such sample(s) are retained for 90 days only.

除非另有說明，此報告結果僅對測試之樣品負責，同時此樣品僅保留90天。本報告未經本公司書面許可，不可部份複製。

This document is issued by the Company subject to its General Conditions of Service printed overleaf, available on request or accessible at <http://www.sgs.com.tw/Terms-and-Conditions> and for electronic format documents, subject to Terms and Conditions for Electronic Documents at <http://www.sgs.com.tw/Terms-and-Conditions>. Attention is drawn to the limitation of liability, indemnification and jurisdiction issues defined therein. Any holder of this document is advised that information contained hereon reflects the Company's findings at the time of its intervention only and within the limits of Client's instructions, if any. The Company's sole responsibility is to its Client and this document does not exonerate parties to a transaction from exercising all their rights and obligations under the transaction documents. This document cannot be reproduced except in full, without prior written approval of the Company. Any unauthorized alteration, forgery or falsification of the content or appearance of this document is unlawful and offenders may be prosecuted to the fullest extent of the law.

Report Number :ER/2022/30084
 Operation Mode :66A_n2A
 Test Mode :Tx CH Low_Mid
 EUT Pol :H Plane
 Test Frequency :1720_1880 MHz

Test Site :SAC 1
 Test Date :2022-05-12
 Temp./Humi. :25.7/70
 Antenna Pol. :Horizontal
 Engineer :GN Lin

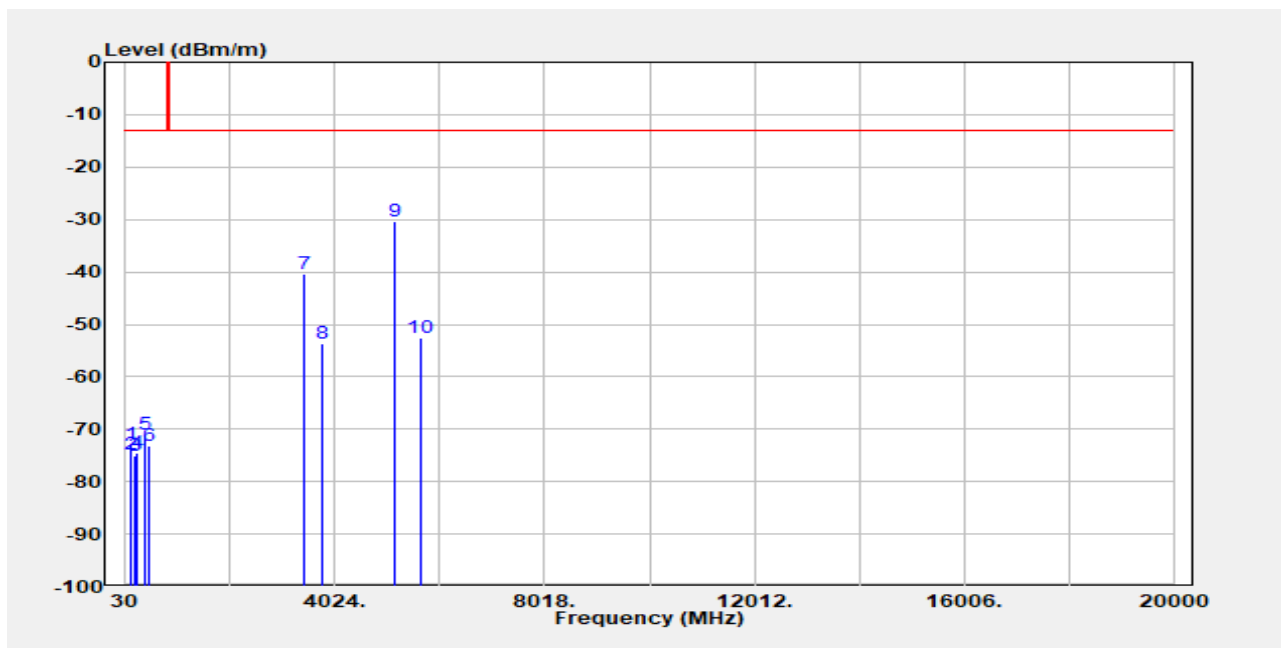

Freq. MHz	EIRP/ERP dBm	SG Output Level dBm	Antenna Gain dBi/dBd	Cable Loss dB	Limit dBm	Margin dB
119.24	-72.79	-69.85	-1.82	-1.12	-13.00	-59.79
128.94	-74.86	-71.69	-2.00	-1.17	-13.00	-61.86
194.90	-74.96	-77.40	3.88	-1.43	-13.00	-61.96
252.13	-74.59	-77.32	4.33	-1.60	-13.00	-61.59
393.75	-70.99	-73.24	4.33	-2.08	-13.00	-57.99
480.08	-73.14	-74.90	4.21	-2.44	-13.00	-60.14
3440.00	-40.49	-47.06	12.52	-5.95	-13.00	-27.49
3760.00	-53.63	-58.39	12.40	-7.63	-13.00	-40.63
5160.00	-30.38	-34.61	12.16	-7.93	-13.00	-17.38
5640.00	-52.70	-56.47	13.00	-9.23	-13.00	-39.70

Unless otherwise stated the results shown in this test report refer only to the sample(s) tested and such sample(s) are retained for 90 days only.

除非另有說明，此報告結果僅對測試之樣品負責，同時此樣品僅保留90天。本報告未經本公司書面許可，不可部份複製。

This document is issued by the Company subject to its General Conditions of Service printed overleaf, available on request or accessible at <http://www.sgs.com.tw/Terms-and-Conditions> and for electronic format documents, subject to Terms and Conditions for Electronic Documents at <http://www.sgs.com.tw/Terms-and-Conditions>. Attention is drawn to the limitation of liability, indemnification and jurisdiction issues defined therein. Any holder of this document is advised that information contained hereon reflects the Company's findings at the time of its intervention only and within the limits of Client's instructions, if any. The Company's sole responsibility is to its Client and this document does not exonerate parties to a transaction from exercising all their rights and obligations under the transaction documents. This document cannot be reproduced except in full, without prior written approval of the Company. Any unauthorized alteration, forgery or falsification of the content or appearance of this document is unlawful and offenders may be prosecuted to the fullest extent of the law.

Report Number :ER/2022/30084
 Operation Mode :2A_n5A
 Test Mode :Tx CH Low_Low
 EUT Pol :H Plane
 Test Frequency :1860_831.5 MHz

Test Site :SAC 1
 Test Date :2022-05-12
 Temp./Humi. :25.7/70
 Antenna Pol. :Vertical
 Engineer :GN Lin

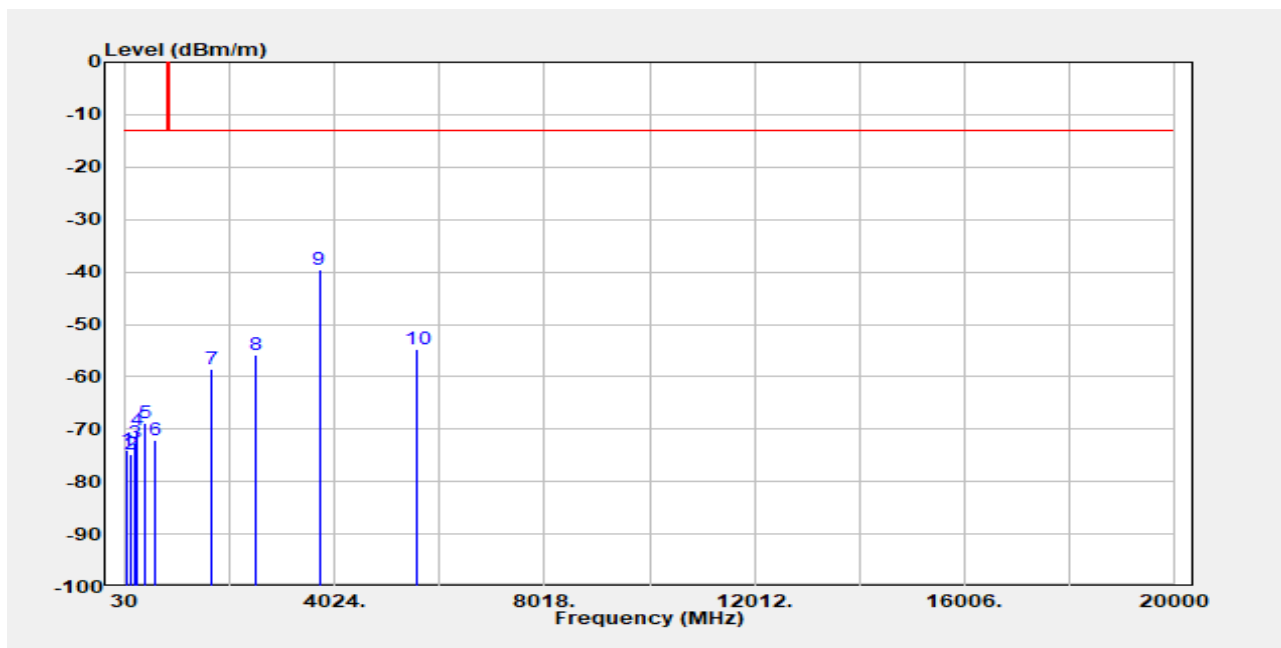

Freq. MHz	EIRP/ERP dBm	SG Output Level dBm	Antenna Gain dBi/dBd	Cable Loss dB	Limit dBm	Margin dB
48.43	-73.88	-61.05	-12.13	-0.70	-13.00	-60.88
117.30	-74.76	-71.92	-1.73	-1.11	-13.00	-61.76
194.90	-72.57	-75.02	3.88	-1.43	-13.00	-59.57
253.10	-70.31	-73.03	4.32	-1.60	-13.00	-57.31
397.63	-68.80	-71.00	4.32	-2.11	-13.00	-55.80
603.27	-71.96	-72.99	3.62	-2.60	-13.00	-58.96
1663.00	-58.64	-63.90	9.53	-4.27	-13.00	-45.64
2494.50	-55.91	-61.32	10.59	-5.18	-13.00	-42.91
3720.00	-39.59	-44.37	12.34	-7.56	-13.00	-26.59
5580.00	-54.74	-58.28	12.96	-9.42	-13.00	-41.74

Unless otherwise stated the results shown in this test report refer only to the sample(s) tested and such sample(s) are retained for 90 days only.

除非另有說明，此報告結果僅對測試之樣品負責，同時此樣品僅保留90天。本報告未經本公司書面許可，不可部份複製。

This document is issued by the Company subject to its General Conditions of Service printed overleaf, available on request or accessible at <http://www.sgs.com.tw/Terms-and-Conditions> and for electronic format documents, subject to Terms and Conditions for Electronic Documents at <http://www.sgs.com.tw/Terms-and-Conditions>. Attention is drawn to the limitation of liability, indemnification and jurisdiction issues defined therein. Any holder of this document is advised that information contained hereon reflects the Company's findings at the time of its intervention only and within the limits of Client's instructions, if any. The Company's sole responsibility is to its Client and this document does not exonerate parties to a transaction from exercising all their rights and obligations under the transaction documents. This document cannot be reproduced except in full, without prior written approval of the Company. Any unauthorized alteration, forgery or falsification of the content or appearance of this document is unlawful and offenders may be prosecuted to the fullest extent of the law.

Report Number :ER/2022/30084
 Operation Mode :2A_n5A
 Test Mode :Tx CH Low_Low
 EUT Pol :H Plane
 Test Frequency :1860_831.5 MHz

Test Site :SAC 1
 Test Date :2022-05-12
 Temp./Humi. :25.7/70
 Antenna Pol. :Horizontal
 Engineer :GN Lin

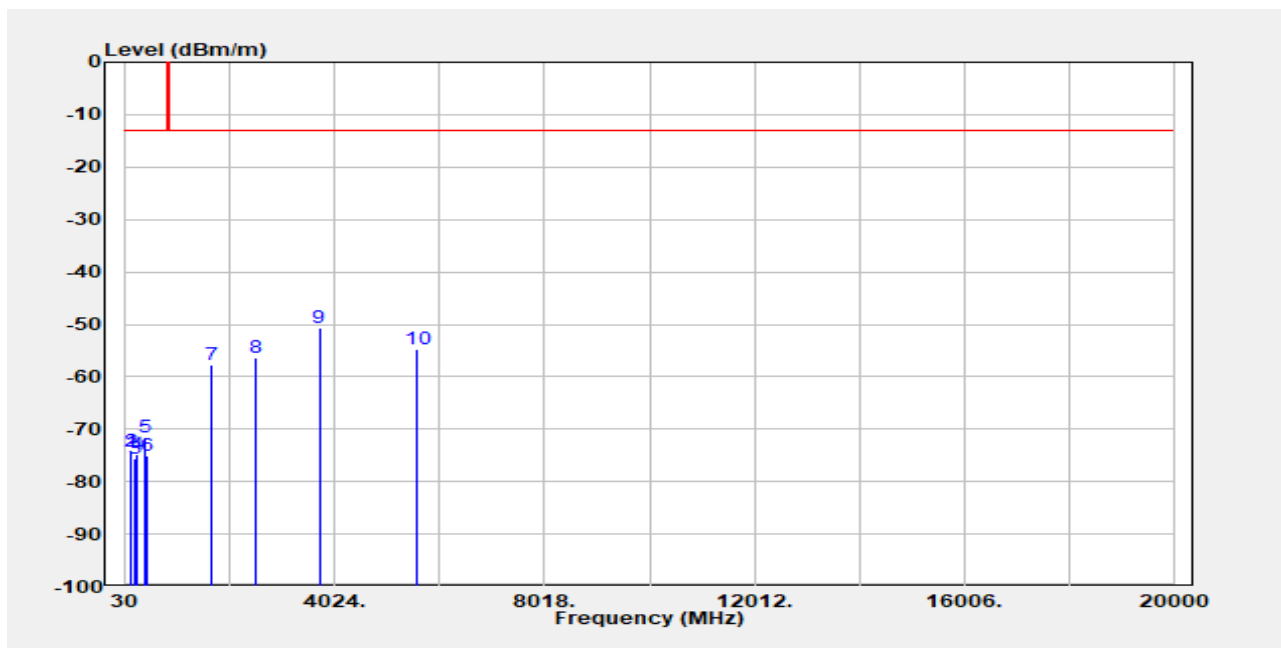

Freq. MHz	EIRP/ERP dBm	SG Output Level dBm	Antenna Gain dBi/dBd	Cable Loss dB	Limit dBm	Margin dB
115.36	-74.46	-71.66	-1.71	-1.10	-13.00	-61.46
130.88	-74.16	-70.98	-1.99	-1.18	-13.00	-61.16
196.84	-75.55	-78.19	4.06	-1.43	-13.00	-62.55
252.13	-74.73	-77.46	4.33	-1.60	-13.00	-61.73
394.72	-71.44	-73.67	4.32	-2.08	-13.00	-58.44
442.25	-75.01	-76.89	4.09	-2.21	-13.00	-62.01
1663.00	-57.72	-62.97	9.53	-4.27	-13.00	-44.72
2494.50	-56.38	-61.79	10.59	-5.18	-13.00	-43.38
3720.00	-50.64	-55.42	12.34	-7.56	-13.00	-37.64
5580.00	-54.61	-58.15	12.96	-9.42	-13.00	-41.61

Unless otherwise stated the results shown in this test report refer only to the sample(s) tested and such sample(s) are retained for 90 days only.

除非另有說明，此報告結果僅對測試之樣品負責，同時此樣品僅保留90天。本報告未經本公司書面許可，不可部份複製。

This document is issued by the Company subject to its General Conditions of Service printed overleaf, available on request or accessible at <http://www.sgs.com.tw/Terms-and-Conditions> and for electronic format documents, subject to Terms and Conditions for Electronic Documents at <http://www.sgs.com.tw/Terms-and-Conditions>. Attention is drawn to the limitation of liability, indemnification and jurisdiction issues defined therein. Any holder of this document is advised that information contained hereon reflects the Company's findings at the time of its intervention only and within the limits of Client's instructions, if any. The Company's sole responsibility is to its Client and this document does not exonerate parties to a transaction from exercising all their rights and obligations under the transaction documents. This document cannot be reproduced except in full, without prior written approval of the Company. Any unauthorized alteration, forgery or falsification of the content or appearance of this document is unlawful and offenders may be prosecuted to the fullest extent of the law.

Report Number :ER/2022/30084
 Operation Mode :48A_n5A
 Test Mode :Tx CH Low_Low
 EUT Pol :H Plane
 Test Frequency :3560_831.5 MHz

Test Site :SAC 1
 Test Date :2022-05-12
 Temp./Humi. :25.7/70
 Antenna Pol. :Vertical
 Engineer :GN Lin

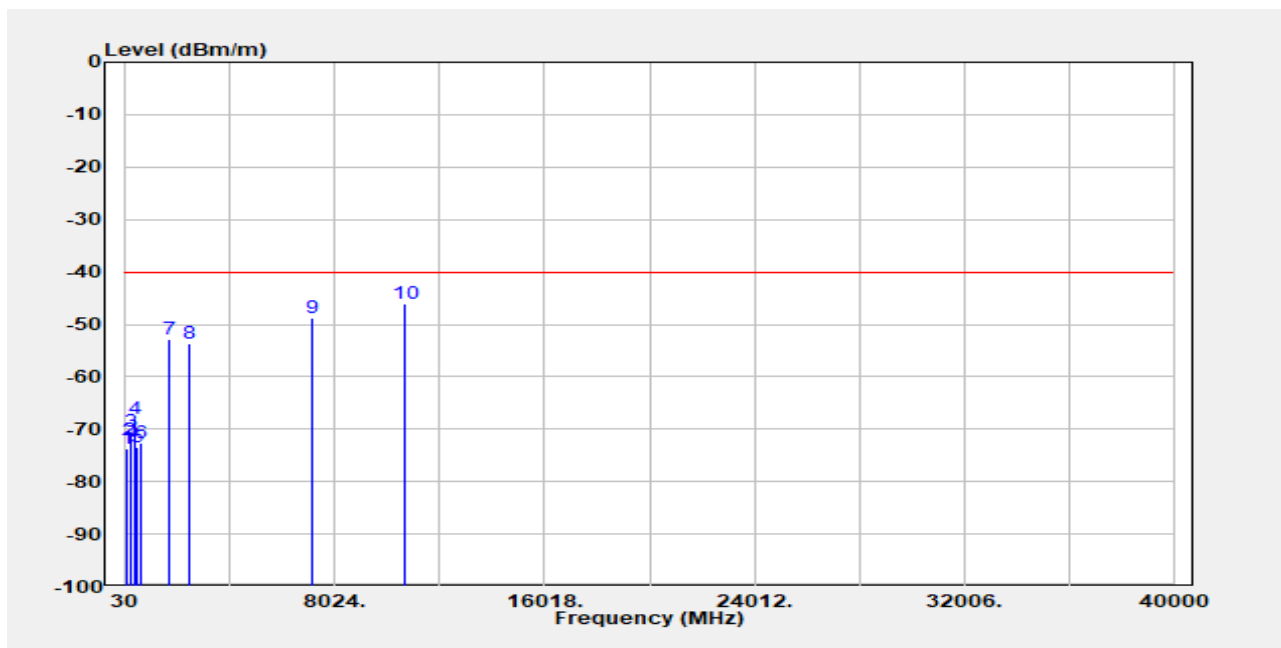

Freq. MHz	EIRP/ERP dBm	SG Output Level dBm	Antenna Gain dBi/dBd	Cable Loss dB	Limit dBm	Margin dB
49.40	-73.78	-61.15	-11.93	-0.70	-40.00	-33.78
193.93	-72.03	-74.43	3.83	-1.43	-40.00	-32.03
252.13	-70.37	-73.10	4.33	-1.60	-40.00	-30.37
399.57	-67.99	-70.18	4.32	-2.13	-40.00	-27.99
480.08	-73.38	-75.14	4.21	-2.44	-40.00	-33.38
590.66	-72.70	-73.85	3.79	-2.65	-40.00	-32.70
1663.00	-52.83	-58.08	9.53	-4.27	-40.00	-12.83
2494.50	-53.59	-59.00	10.59	-5.18	-40.00	-13.59
7120.00	-48.70	-49.84	10.96	-9.82	-40.00	-8.70
10680.00	-46.15	-45.82	11.22	-11.55	-40.00	-6.15

Unless otherwise stated the results shown in this test report refer only to the sample(s) tested and such sample(s) are retained for 90 days only.

除非另有說明，此報告結果僅對測試之樣品負責，同時此樣品僅保留90天。本報告未經本公司書面許可，不可部份複製。
 This document is issued by the Company subject to its General Conditions of Service printed overleaf, available on request or accessible at <http://www.sgs.com.tw/Terms-and-Conditions> and for electronic format documents, subject to Terms and Conditions for Electronic Documents at <http://www.sgs.com.tw/Terms-and-Conditions>. Attention is drawn to the limitation of liability, indemnification and jurisdiction issues defined therein. Any holder of this document is advised that information contained hereon reflects the Company's findings at the time of its intervention only and within the limits of Client's instructions, if any. The Company's sole responsibility is to its Client and this document does not exonerate parties to a transaction from exercising all their rights and obligations under the transaction documents. This document cannot be reproduced except in full, without prior written approval of the Company. Any unauthorized alteration, forgery or falsification of the content or appearance of this document is unlawful and offenders may be prosecuted to the fullest extent of the law.

Report Number :ER/2022/30084
 Operation Mode :48A_n5A
 Test Mode :Tx CH Low_Low
 EUT Pol :H Plane
 Test Frequency :3560_831.5 MHz

Test Site :SAC 1
 Test Date :2022-05-12
 Temp./Humi. :25.7/70
 Antenna Pol. :Horizontal
 Engineer :GN Lin

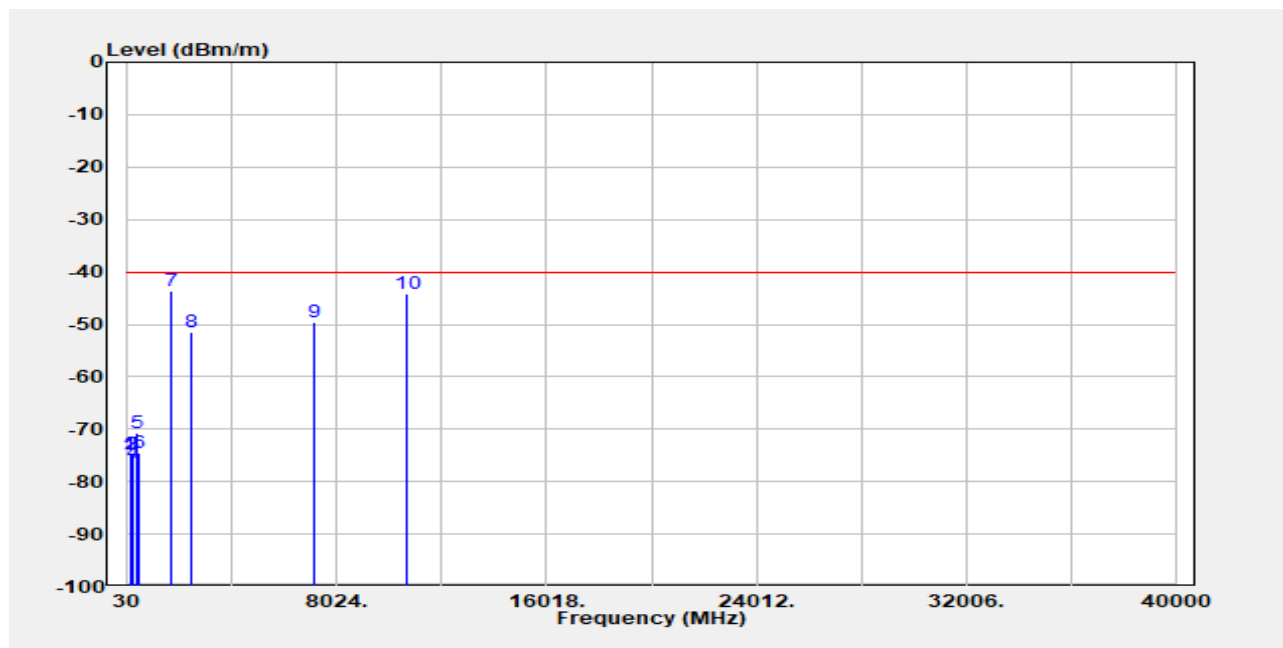

Freq. MHz	EIRP/ERP dBm	SG Output Level dBm	Antenna Gain dBi/dBd	Cable Loss dB	Limit dBm	Margin dB
117.30	-74.96	-72.11	-1.73	-1.11	-40.00	-34.96
127.97	-74.83	-71.79	-1.88	-1.16	-40.00	-34.83
195.87	-74.82	-77.40	4.01	-1.43	-40.00	-34.82
252.13	-76.54	-79.27	4.33	-1.60	-40.00	-36.54
394.72	-70.65	-72.89	4.32	-2.08	-40.00	-30.65
480.08	-74.44	-76.20	4.21	-2.44	-40.00	-34.44
1663.00	-43.73	-48.98	9.53	-4.27	-40.00	-3.73
2494.50	-51.39	-56.79	10.59	-5.18	-40.00	-11.39
7120.00	-49.66	-50.80	10.96	-9.82	-40.00	-9.66
10680.00	-44.10	-43.77	11.22	-11.55	-40.00	-4.10

Unless otherwise stated the results shown in this test report refer only to the sample(s) tested and such sample(s) are retained for 90 days only.

除非另有說明，此報告結果僅對測試之樣品負責，同時此樣品僅保留90天。本報告未經本公司書面許可，不可部份複製。
 This document is issued by the Company subject to its General Conditions of Service printed overleaf, available on request or accessible at <http://www.sgs.com.tw/Terms-and-Conditions> and for electronic format documents, subject to Terms and Conditions for Electronic Documents at <http://www.sgs.com.tw/Terms-and-Conditions>. Attention is drawn to the limitation of liability, indemnification and jurisdiction issues defined therein. Any holder of this document is advised that information contained hereon reflects the Company's findings at the time of its intervention only and within the limits of Client's instructions, if any. The Company's sole responsibility is to its Client and this document does not exonerate parties to a transaction from exercising all their rights and obligations under the transaction documents. This document cannot be reproduced except in full, without prior written approval of the Company. Any unauthorized alteration, forgery or falsification of the content or appearance of this document is unlawful and offenders may be prosecuted to the fullest extent of the law.

Report Number :ER/2022/30084
 Operation Mode :66A_n5A
 Test Mode :Tx CH Low_Low
 EUT Pol :H Plane
 Test Frequency :1720_831.5 MHz

Test Site :SAC 1
 Test Date :2022-05-12
 Temp./Humi. :25.7/70
 Antenna Pol. :Vertical
 Engineer :GN Lin

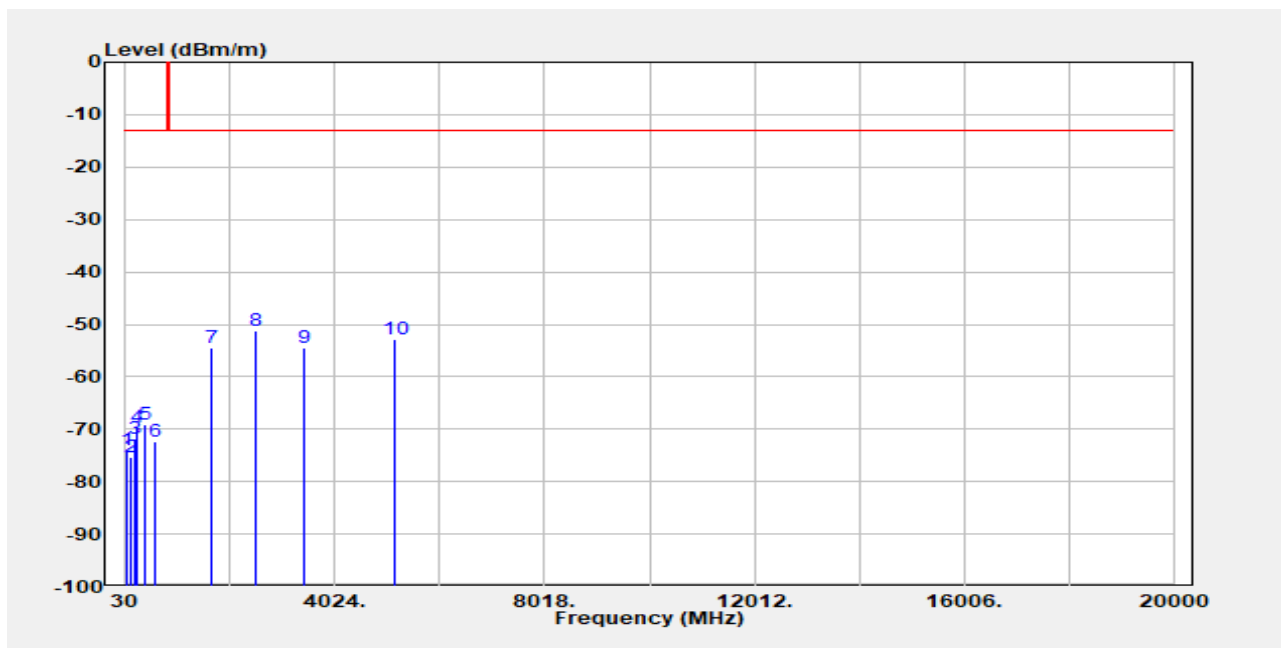

Freq. MHz	EIRP/ERP dBm	SG Output Level dBm	Antenna Gain dBi/dBd	Cable Loss dB	Limit dBm	Margin dB
48.43	-73.97	-61.14	-12.13	-0.70	-13.00	-60.97
126.03	-75.35	-72.37	-1.82	-1.15	-13.00	-62.35
195.87	-71.74	-74.32	4.01	-1.43	-13.00	-58.74
251.16	-69.77	-72.51	4.33	-1.59	-13.00	-56.77
394.72	-68.99	-71.23	4.32	-2.08	-13.00	-55.99
597.45	-72.27	-73.33	3.71	-2.65	-13.00	-59.27
1663.00	-54.56	-59.81	9.53	-4.27	-13.00	-41.56
2494.50	-51.23	-56.64	10.59	-5.18	-13.00	-38.23
3440.00	-54.43	-61.00	12.52	-5.95	-13.00	-41.43
5160.00	-52.97	-57.21	12.16	-7.93	-13.00	-39.97

Unless otherwise stated the results shown in this test report refer only to the sample(s) tested and such sample(s) are retained for 90 days only.

除非另有說明，此報告結果僅對測試之樣品負責，同時此樣品僅保留90天。本報告未經本公司書面許可，不可部份複製。

This document is issued by the Company subject to its General Conditions of Service printed overleaf, available on request or accessible at <http://www.sgs.com.tw/Terms-and-Conditions> and for electronic format documents, subject to Terms and Conditions for Electronic Documents at <http://www.sgs.com.tw/Terms-and-Conditions>. Attention is drawn to the limitation of liability, indemnification and jurisdiction issues defined therein. Any holder of this document is advised that information contained hereon reflects the Company's findings at the time of its intervention only and within the limits of Client's instructions, if any. The Company's sole responsibility is to its Client and this document does not exonerate parties to a transaction from exercising all their rights and obligations under the transaction documents. This document cannot be reproduced except in full, without prior written approval of the Company. Any unauthorized alteration, forgery or falsification of the content or appearance of this document is unlawful and offenders may be prosecuted to the fullest extent of the law.

Report Number :ER/2022/30084
 Operation Mode :66A_n5A
 Test Mode :Tx CH Low_Low
 EUT Pol :H Plane
 Test Frequency :1720_831.5 MHz

Test Site :SAC 1
 Test Date :2022-05-12
 Temp./Humi. :25.7/70
 Antenna Pol. :Horizontal
 Engineer :GN Lin

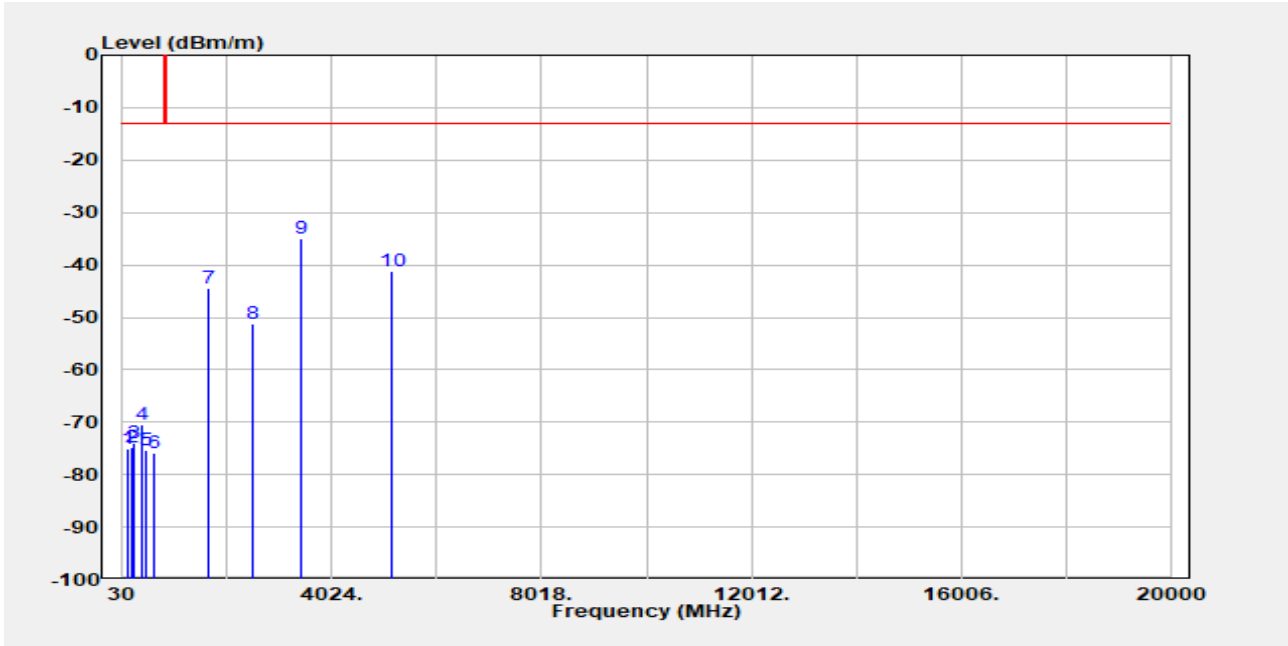

Freq. MHz	EIRP/ERP dBm	SG Output Level dBm	Antenna Gain dBi/dBd	Cable Loss dB	Limit dBm	Margin dB
117.30	-75.10	-72.26	-1.73	-1.11	-13.00	-62.10
198.78	-74.83	-77.65	4.25	-1.43	-13.00	-61.83
252.13	-73.95	-76.68	4.33	-1.60	-13.00	-60.95
398.60	-70.58	-72.77	4.32	-2.12	-13.00	-57.58
480.08	-75.29	-77.05	4.21	-2.44	-13.00	-62.29
612.97	-75.79	-76.82	3.47	-2.44	-13.00	-62.79
1663.00	-44.32	-49.57	9.53	-4.27	-13.00	-31.32
2494.50	-51.28	-56.69	10.59	-5.18	-13.00	-38.28
3440.00	-35.05	-41.63	12.52	-5.95	-13.00	-22.05
5160.00	-41.18	-45.42	12.16	-7.93	-13.00	-28.18

Unless otherwise stated the results shown in this test report refer only to the sample(s) tested and such sample(s) are retained for 90 days only.

除非另有說明，此報告結果僅對測試之樣品負責，同時此樣品僅保留90天。本報告未經本公司書面許可，不可部份複製。

This document is issued by the Company subject to its General Conditions of Service printed overleaf, available on request or accessible at <http://www.sgs.com.tw/Terms-and-Conditions> and for electronic format documents, subject to Terms and Conditions for Electronic Documents at <http://www.sgs.com.tw/Terms-and-Conditions>. Attention is drawn to the limitation of liability, indemnification and jurisdiction issues defined therein. Any holder of this document is advised that information contained hereon reflects the Company's findings at the time of its intervention only and within the limits of Client's instructions, if any. The Company's sole responsibility is to its Client and this document does not exonerate parties to a transaction from exercising all their rights and obligations under the transaction documents. This document cannot be reproduced except in full, without prior written approval of the Company. Any unauthorized alteration, forgery or falsification of the content or appearance of this document is unlawful and offenders may be prosecuted to the fullest extent of the law.

Report Number :ER/2022/30084
 Operation Mode :2A_n66A
 Test Mode :Tx CH Low_Low
 EUT Pol :H Plane
 Test Frequency :1860_1717.5 MHz

Test Site :SAC 1
 Test Date :2022-05-12
 Temp./Humi. :25.7/70
 Antenna Pol. :Vertical
 Engineer :GN Lin

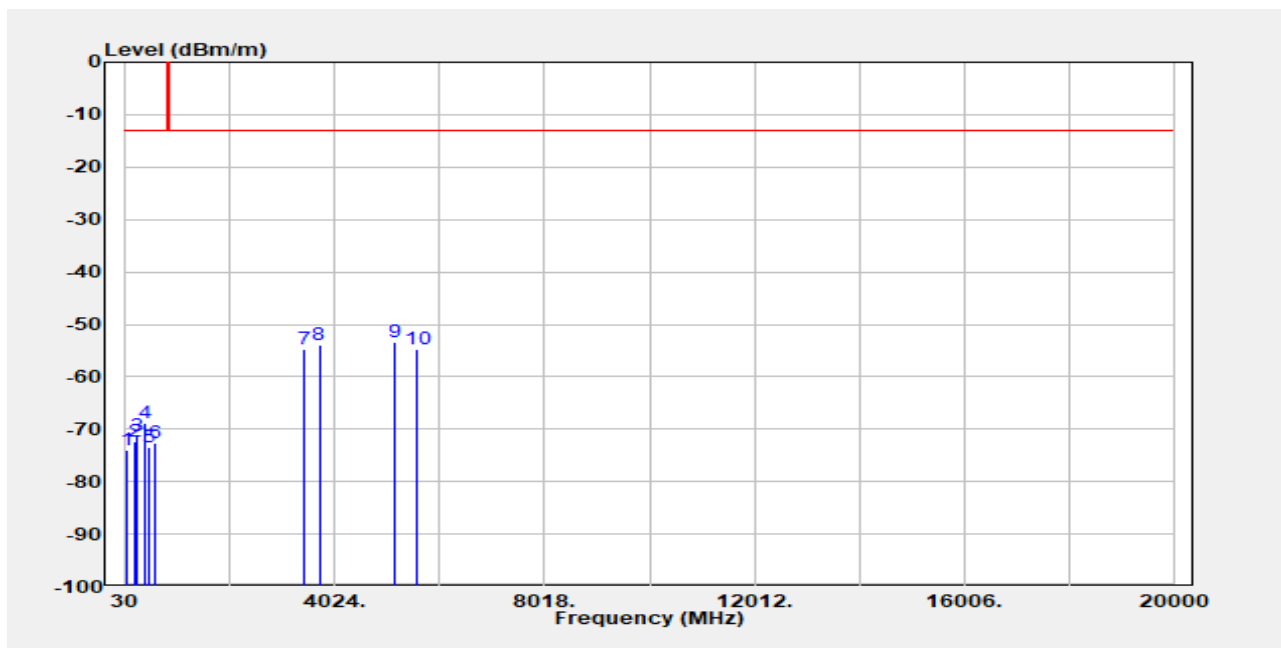

Freq. MHz	EIRP/ERP dBm	SG Output Level dBm	Antenna Gain dBi/dBd	Cable Loss dB	Limit dBm	Margin dB
48.43	-73.86	-61.03	-12.13	-0.70	-13.00	-60.86
195.87	-72.29	-74.87	4.01	-1.43	-13.00	-59.29
252.13	-71.39	-74.12	4.33	-1.60	-13.00	-58.39
395.69	-68.75	-70.97	4.31	-2.09	-13.00	-55.75
480.08	-73.50	-75.26	4.21	-2.44	-13.00	-60.50
601.33	-72.61	-73.62	3.64	-2.63	-13.00	-59.61
3435.00	-54.80	-61.42	12.53	-5.91	-13.00	-41.80
3720.00	-53.93	-58.71	12.34	-7.56	-13.00	-40.93
5152.50	-53.30	-57.48	12.12	-7.94	-13.00	-40.30
5580.00	-54.78	-58.32	12.96	-9.42	-13.00	-41.78

Unless otherwise stated the results shown in this test report refer only to the sample(s) tested and such sample(s) are retained for 90 days only.

除非另有說明，此報告結果僅對測試之樣品負責，同時此樣品僅保留90天。本報告未經本公司書面許可，不可部份複製。

This document is issued by the Company subject to its General Conditions of Service printed overleaf, available on request or accessible at <http://www.sgs.com.tw/Terms-and-Conditions> and for electronic format documents, subject to Terms and Conditions for Electronic Documents at <http://www.sgs.com.tw/Terms-and-Conditions>. Attention is drawn to the limitation of liability, indemnification and jurisdiction issues defined therein. Any holder of this document is advised that information contained hereon reflects the Company's findings at the time of its intervention only and within the limits of Client's instructions, if any. The Company's sole responsibility is to its Client and this document does not exonerate parties to a transaction from exercising all their rights and obligations under the transaction documents. This document cannot be reproduced except in full, without prior written approval of the Company. Any unauthorized alteration, forgery or falsification of the content or appearance of this document is unlawful and offenders may be prosecuted to the fullest extent of the law.

Report Number :ER/2022/30084
 Operation Mode :2A_n66A
 Test Mode :Tx CH Low_Low
 EUT Pol :H Plane
 Test Frequency :1860_1717.5 MHz

Test Site :SAC 1
 Test Date :2022-05-12
 Temp./Humi. :25.7/70
 Antenna Pol. :Horizontal
 Engineer :GN Lin

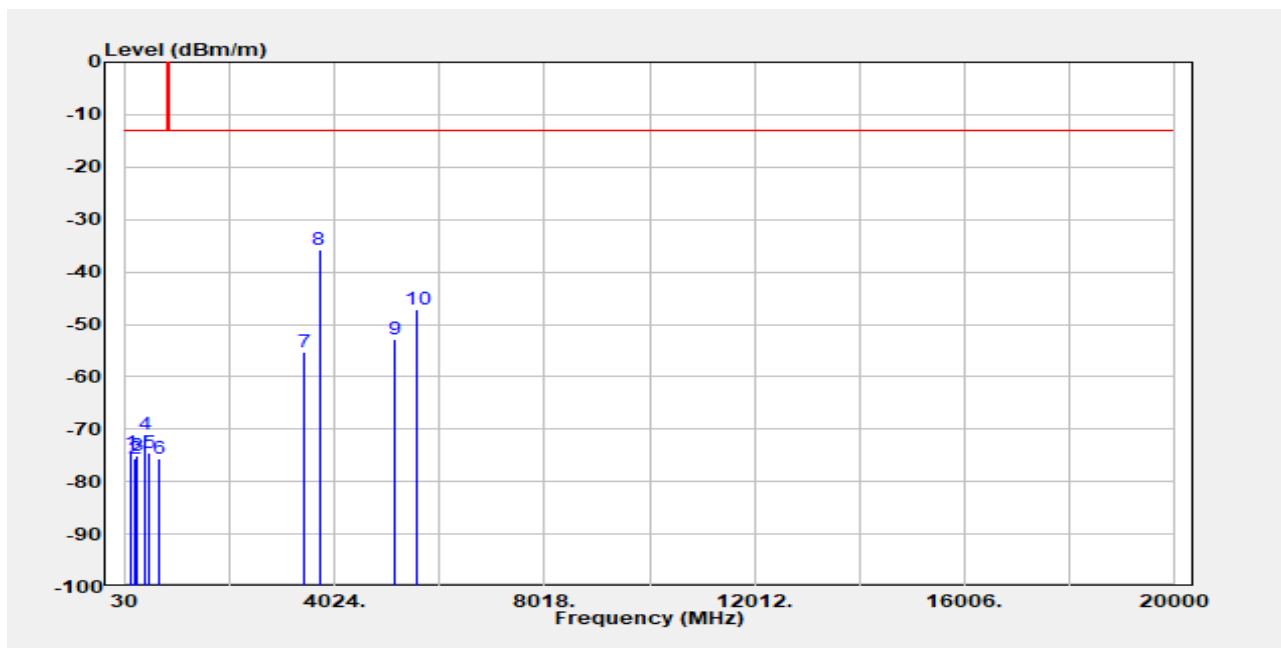

Freq. MHz	EIRP/ERP dBm	SG Output Level dBm	Antenna Gain dBi/dBd	Cable Loss dB	Limit dBm	Margin dB
116.33	-74.59	-71.88	-1.61	-1.10	-13.00	-61.59
196.84	-75.50	-78.14	4.06	-1.43	-13.00	-62.50
252.13	-75.03	-77.75	4.33	-1.60	-13.00	-62.03
393.75	-71.10	-73.36	4.33	-2.08	-13.00	-58.10
480.08	-74.65	-76.41	4.21	-2.44	-13.00	-61.65
664.38	-75.52	-76.52	3.73	-2.73	-13.00	-62.52
3435.00	-55.31	-61.93	12.53	-5.91	-13.00	-42.31
3720.00	-35.90	-40.68	12.34	-7.56	-13.00	-22.90
5152.50	-52.94	-57.12	12.12	-7.94	-13.00	-39.94
5580.00	-47.11	-50.65	12.96	-9.42	-13.00	-34.11

Unless otherwise stated the results shown in this test report refer only to the sample(s) tested and such sample(s) are retained for 90 days only.

除非另有說明，此報告結果僅對測試之樣品負責，同時此樣品僅保留90天。本報告未經本公司書面許可，不可部份複製。

This document is issued by the Company subject to its General Conditions of Service printed overleaf, available on request or accessible at <http://www.sgs.com.tw/Terms-and-Conditions> and for electronic format documents, subject to Terms and Conditions for Electronic Documents at <http://www.sgs.com.tw/Terms-and-Conditions>. Attention is drawn to the limitation of liability, indemnification and jurisdiction issues defined therein. Any holder of this document is advised that information contained hereon reflects the Company's findings at the time of its intervention only and within the limits of Client's instructions, if any. The Company's sole responsibility is to its Client and this document does not exonerate parties to a transaction from exercising all their rights and obligations under the transaction documents. This document cannot be reproduced except in full, without prior written approval of the Company. Any unauthorized alteration, forgery or falsification of the content or appearance of this document is unlawful and offenders may be prosecuted to the fullest extent of the law.

Report Number :ER/2022/30084
 Operation Mode :5A_n66A
 Test Mode :Tx CH Low_Low
 EUT Pol :H Plane
 Test Frequency :829_1717.5 MHz

Test Site :SAC 1
 Test Date :2022-05-12
 Temp./Humi. :25.7/70
 Antenna Pol. :Vertical
 Engineer :GN Lin

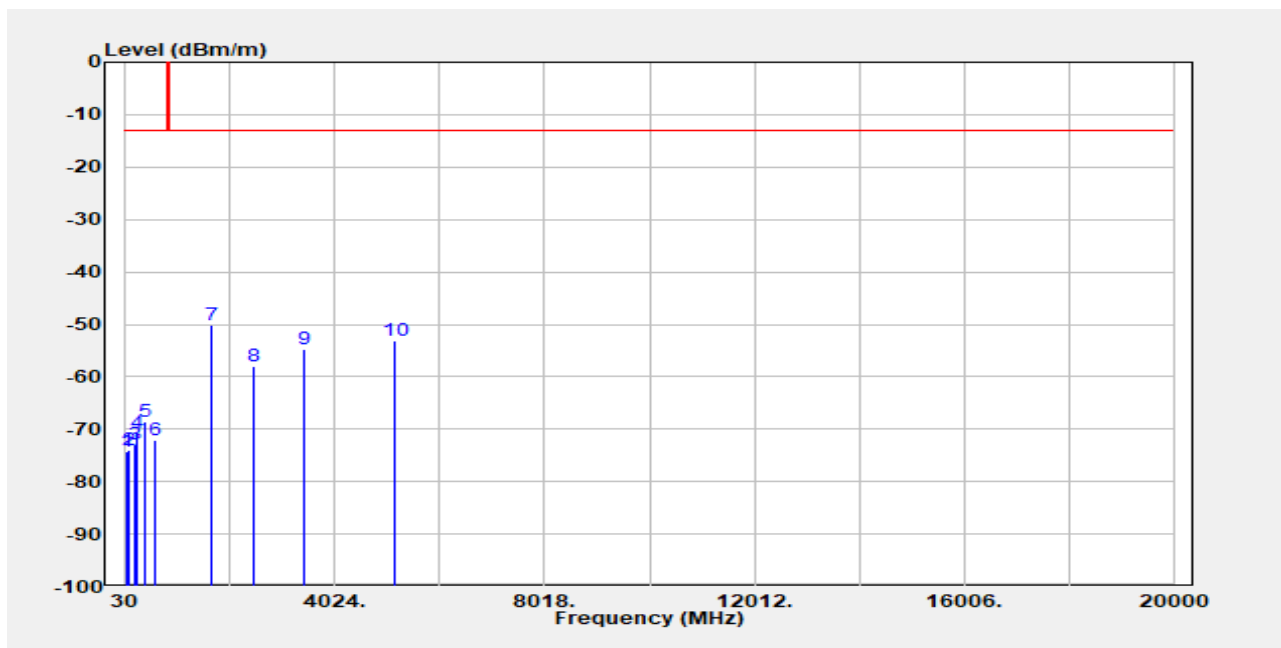

Freq. MHz	EIRP/ERP dBm	SG Output Level dBm	Antenna Gain dBi/dBd	Cable Loss dB	Limit dBm	Margin dB
48.43	-74.23	-61.40	-12.13	-0.70	-13.00	-61.23
103.72	-73.94	-71.84	-1.07	-1.03	-13.00	-60.94
193.93	-72.79	-75.18	3.83	-1.43	-13.00	-59.79
253.10	-70.70	-73.41	4.32	-1.60	-13.00	-57.70
396.66	-68.48	-70.69	4.32	-2.10	-13.00	-55.48
598.42	-72.18	-73.22	3.68	-2.64	-13.00	-59.18
1658.00	-50.11	-55.36	9.52	-4.27	-13.00	-37.11
2487.00	-58.04	-63.44	10.57	-5.18	-13.00	-45.04
3435.00	-54.74	-61.35	12.53	-5.91	-13.00	-41.74
5152.50	-53.22	-57.40	12.12	-7.94	-13.00	-40.22

Unless otherwise stated the results shown in this test report refer only to the sample(s) tested and such sample(s) are retained for 90 days only.

除非另有說明，此報告結果僅對測試之樣品負責，同時此樣品僅保留90天。本報告未經本公司書面許可，不可部份複製。

This document is issued by the Company subject to its General Conditions of Service printed overleaf, available on request or accessible at <http://www.sgs.com.tw/Terms-and-Conditions> and for electronic format documents, subject to Terms and Conditions for Electronic Documents at <http://www.sgs.com.tw/Terms-and-Conditions>. Attention is drawn to the limitation of liability, indemnification and jurisdiction issues defined therein. Any holder of this document is advised that information contained hereon reflects the Company's findings at the time of its intervention only and within the limits of Client's instructions, if any. The Company's sole responsibility is to its Client and this document does not exonerate parties to a transaction from exercising all their rights and obligations under the transaction documents. This document cannot be reproduced except in full, without prior written approval of the Company. Any unauthorized alteration, forgery or falsification of the content or appearance of this document is unlawful and offenders may be prosecuted to the fullest extent of the law.

Report Number :ER/2022/30084
 Operation Mode :5A_n66A
 Test Mode :Tx CH Low_Low
 EUT Pol :H Plane
 Test Frequency :829_1717.5 MHz

Test Site :SAC 1
 Test Date :2022-05-12
 Temp./Humi. :25.7/70
 Antenna Pol. :Horizontal
 Engineer :GN Lin

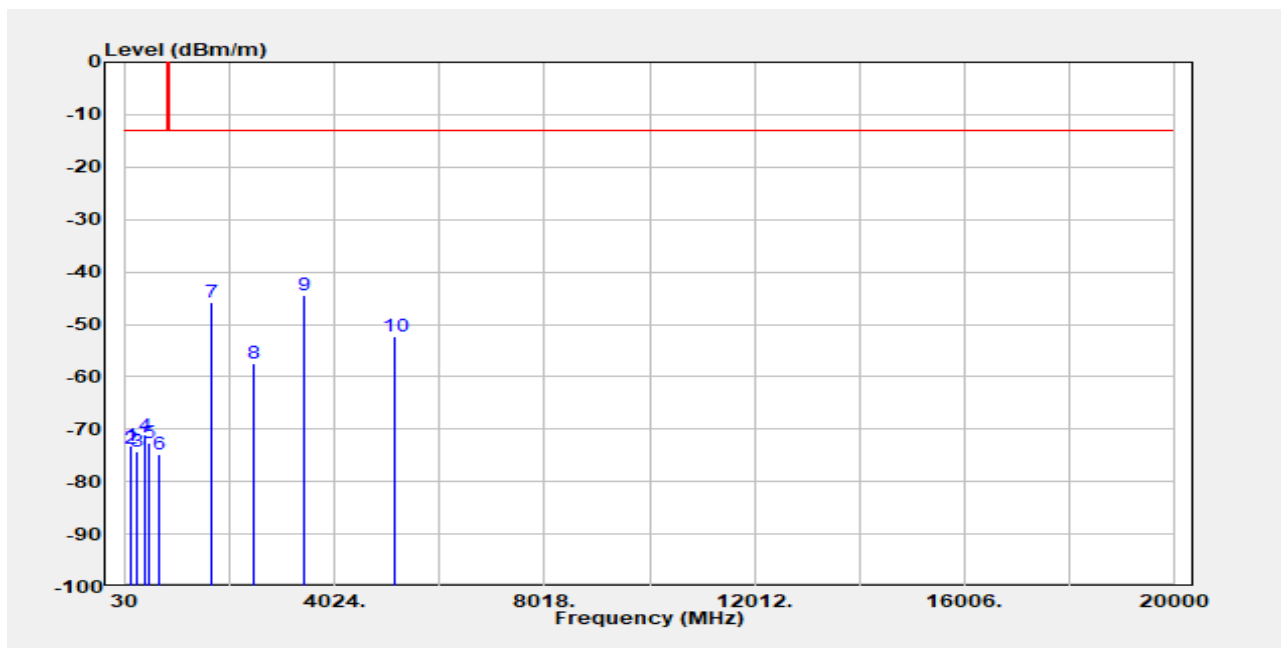

Freq. MHz	EIRP/ERP dBm	SG Output Level dBm	Antenna Gain dBi/dBd	Cable Loss dB	Limit dBm	Margin dB
117.30	-73.04	-70.20	-1.73	-1.11	-13.00	-60.04
127.97	-73.83	-70.79	-1.88	-1.16	-13.00	-60.83
252.13	-74.13	-76.86	4.33	-1.60	-13.00	-61.13
398.60	-71.14	-73.34	4.32	-2.12	-13.00	-58.14
480.08	-72.76	-74.52	4.21	-2.44	-13.00	-59.76
651.77	-74.78	-75.97	3.63	-2.44	-13.00	-61.78
1658.00	-45.73	-50.98	9.52	-4.27	-13.00	-32.73
2487.00	-57.32	-62.72	10.57	-5.18	-13.00	-44.32
3435.00	-44.48	-51.10	12.53	-5.91	-13.00	-31.48
5152.50	-52.30	-56.47	12.12	-7.94	-13.00	-39.30

Unless otherwise stated the results shown in this test report refer only to the sample(s) tested and such sample(s) are retained for 90 days only.

除非另有說明，此報告結果僅對測試之樣品負責，同時此樣品僅保留90天。本報告未經本公司書面許可，不可部份複製。

This document is issued by the Company subject to its General Conditions of Service printed overleaf, available on request or accessible at <http://www.sgs.com.tw/Terms-and-Conditions> and for electronic format documents, subject to Terms and Conditions for Electronic Documents at <http://www.sgs.com.tw/Terms-and-Conditions>. Attention is drawn to the limitation of liability, indemnification and jurisdiction issues defined therein. Any holder of this document is advised that information contained hereon reflects the Company's findings at the time of its intervention only and within the limits of Client's instructions, if any. The Company's sole responsibility is to its Client and this document does not exonerate parties to a transaction from exercising all their rights and obligations under the transaction documents. This document cannot be reproduced except in full, without prior written approval of the Company. Any unauthorized alteration, forgery or falsification of the content or appearance of this document is unlawful and offenders may be prosecuted to the fullest extent of the law.

Report Number :ER/2022/30084
 Operation Mode :13A_n66A
 Test Mode :Tx CH Mid_Low
 EUT Pol :H Plane
 Test Frequency :782_1717.5 MHz

Test Site :SAC 1
 Test Date :2022-05-12
 Temp./Humi. :25.7/70
 Antenna Pol. :Vertical
 Engineer :GN Lin

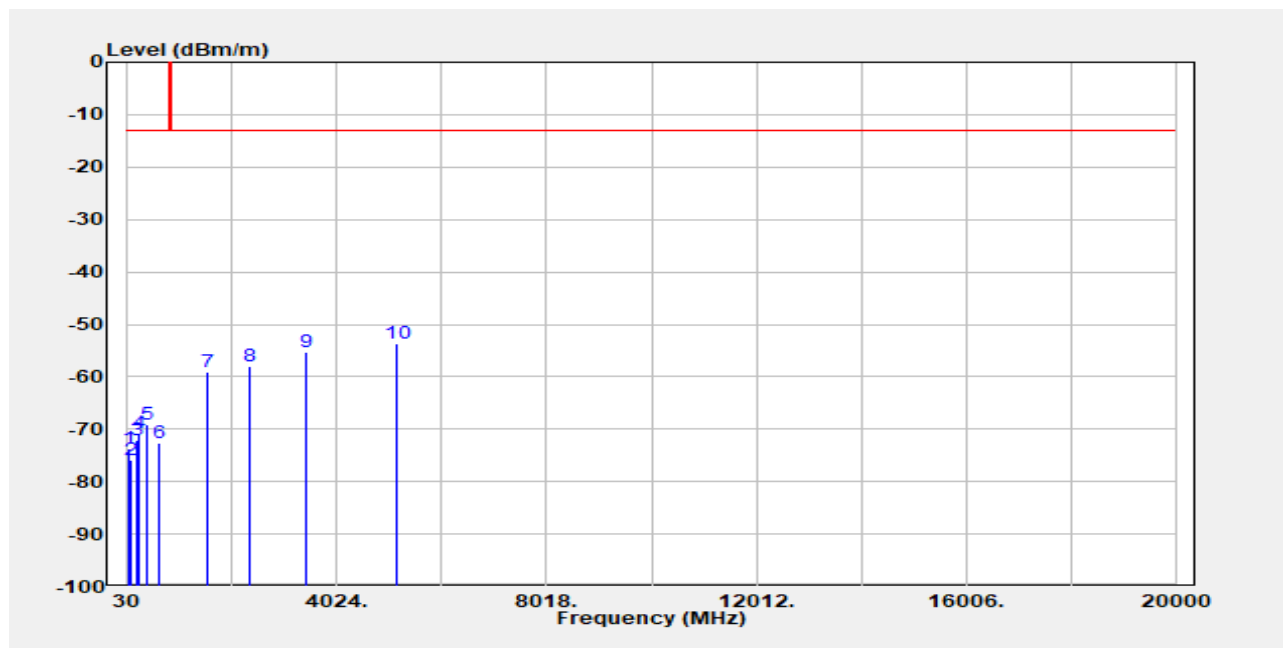

Freq. MHz	EIRP/ERP dBm	SG Output Level dBm	Antenna Gain dBi/dBd	Cable Loss dB	Limit dBm	Margin dB
48.43	-73.68	-60.85	-12.13	-0.70	-13.00	-60.68
102.75	-75.86	-73.75	-1.08	-1.03	-13.00	-62.86
194.90	-72.07	-74.51	3.88	-1.43	-13.00	-59.07
252.13	-70.62	-73.35	4.33	-1.60	-13.00	-57.62
396.66	-69.01	-71.22	4.32	-2.10	-13.00	-56.01
647.89	-72.65	-73.87	3.61	-2.39	-13.00	-59.65
1564.00	-59.04	-64.12	9.18	-4.10	-13.00	-46.04
2346.00	-57.95	-62.53	9.58	-5.01	-13.00	-44.95
3435.00	-55.27	-61.88	12.53	-5.91	-13.00	-42.27
5152.50	-53.58	-57.76	12.12	-7.94	-13.00	-40.58

Unless otherwise stated the results shown in this test report refer only to the sample(s) tested and such sample(s) are retained for 90 days only.

除非另有說明，此報告結果僅對測試之樣品負責，同時此樣品僅保留90天。本報告未經本公司書面許可，不可部份複製。

This document is issued by the Company subject to its General Conditions of Service printed overleaf, available on request or accessible at <http://www.sgs.com.tw/Terms-and-Conditions> and for electronic format documents, subject to Terms and Conditions for Electronic Documents at <http://www.sgs.com.tw/Terms-and-Conditions>. Attention is drawn to the limitation of liability, indemnification and jurisdiction issues defined therein. Any holder of this document is advised that information contained hereon reflects the Company's findings at the time of its intervention only and within the limits of Client's instructions, if any. The Company's sole responsibility is to its Client and this document does not exonerate parties to a transaction from exercising all their rights and obligations under the transaction documents. This document cannot be reproduced except in full, without prior written approval of the Company. Any unauthorized alteration, forgery or falsification of the content or appearance of this document is unlawful and offenders may be prosecuted to the fullest extent of the law.

Report Number :ER/2022/30084
 Operation Mode :13A_n66A
 Test Mode :Tx CH Mid_Low
 EUT Pol :H Plane
 Test Frequency :782_1717.5 MHz

Test Site :SAC 1
 Test Date :2022-05-12
 Temp./Humi. :25.7/70
 Antenna Pol. :Horizontal
 Engineer :GN Lin

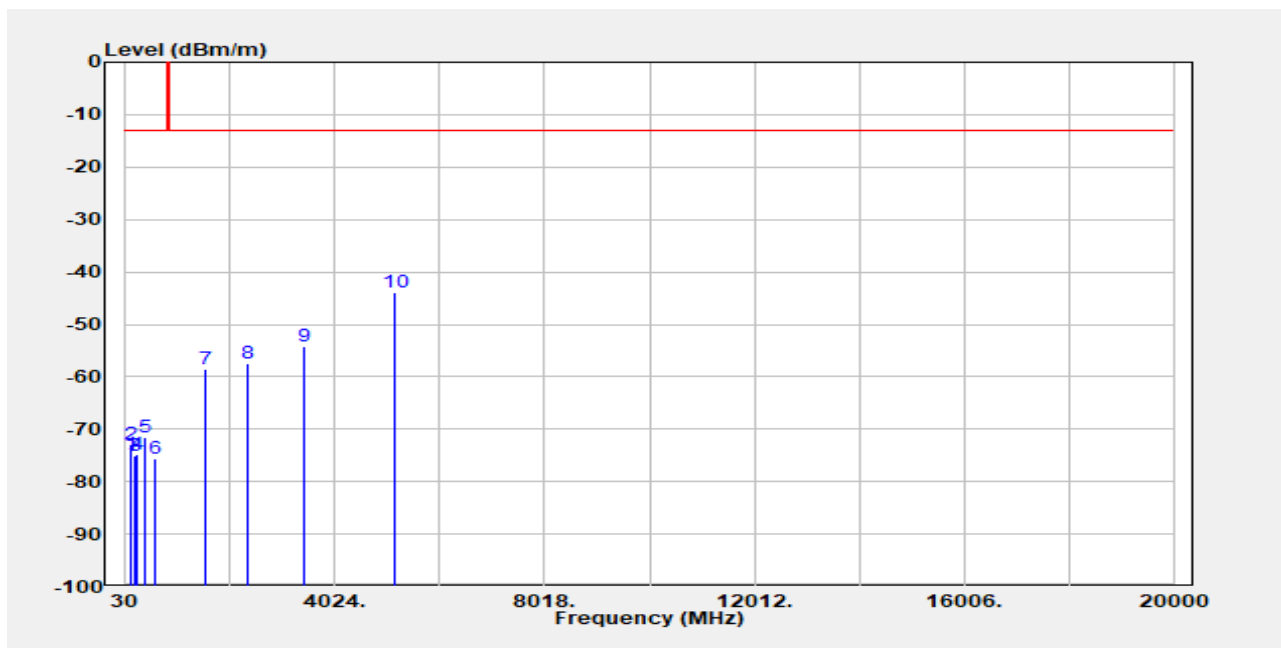

Freq. MHz	EIRP/ERP dBm	SG Output Level dBm	Antenna Gain dBi/dBd	Cable Loss dB	Limit dBm	Margin dB
117.30	-74.67	-71.82	-1.73	-1.11	-13.00	-61.67
141.55	-73.03	-69.82	-1.91	-1.29	-13.00	-60.03
190.05	-75.20	-77.03	3.26	-1.44	-13.00	-62.20
253.10	-74.69	-77.41	4.32	-1.60	-13.00	-61.69
398.60	-71.64	-73.84	4.32	-2.12	-13.00	-58.64
600.36	-75.64	-76.65	3.64	-2.64	-13.00	-62.64
1564.00	-58.44	-63.52	9.18	-4.10	-13.00	-45.44
2346.00	-57.51	-62.09	9.58	-5.01	-13.00	-44.51
3435.00	-54.23	-60.84	12.53	-5.91	-13.00	-41.23
5152.50	-43.89	-48.07	12.12	-7.94	-13.00	-30.89

Unless otherwise stated the results shown in this test report refer only to the sample(s) tested and such sample(s) are retained for 90 days only.

除非另有說明，此報告結果僅對測試之樣品負責，同時此樣品僅保留90天。本報告未經本公司書面許可，不可部份複製。

This document is issued by the Company subject to its General Conditions of Service printed overleaf, available on request or accessible at <http://www.sgs.com.tw/Terms-and-Conditions> and for electronic format documents, subject to Terms and Conditions for Electronic Documents at <http://www.sgs.com.tw/Terms-and-Conditions>. Attention is drawn to the limitation of liability, indemnification and jurisdiction issues defined therein. Any holder of this document is advised that information contained hereon reflects the Company's findings at the time of its intervention only and within the limits of Client's instructions, if any. The Company's sole responsibility is to its Client and this document does not exonerate parties to a transaction from exercising all their rights and obligations under the transaction documents. This document cannot be reproduced except in full, without prior written approval of the Company. Any unauthorized alteration, forgery or falsification of the content or appearance of this document is unlawful and offenders may be prosecuted to the fullest extent of the law.

Report Number :ER/2022/30084
 Operation Mode :2A_n77A
 Test Mode :Tx CH Low_High
 EUT Pol :H Plane
 Test Frequency :1860_3964.98 MHz

Test Site :SAC 1
 Test Date :2022-05-12
 Temp./Humi. :25.7/70
 Antenna Pol. :Vertical
 Engineer :GN Lin

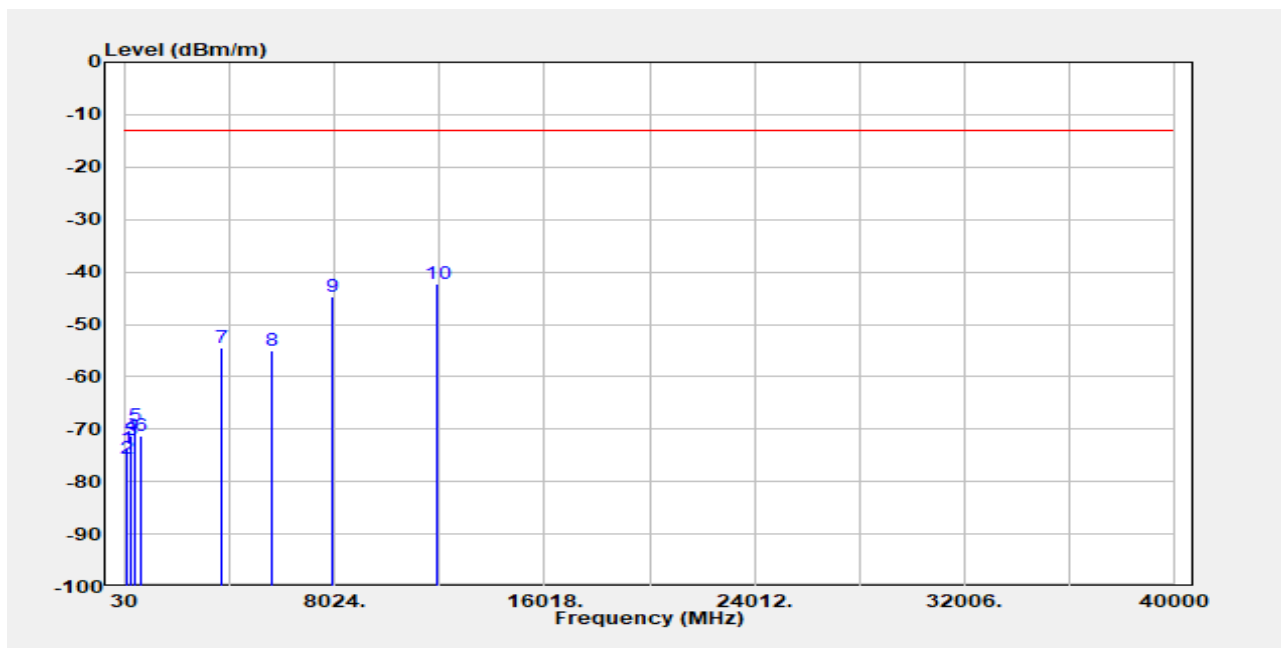

Freq. MHz	EIRP/ERP dBm	SG Output Level dBm	Antenna Gain dBi/dBd	Cable Loss dB	Limit dBm	Margin dB
49.40	-73.70	-61.07	-11.93	-0.70	-13.00	-60.70
102.75	-75.56	-73.45	-1.08	-1.03	-13.00	-62.56
194.90	-72.04	-74.49	3.88	-1.43	-13.00	-59.04
252.13	-71.21	-73.94	4.33	-1.60	-13.00	-58.21
397.63	-69.35	-71.56	4.32	-2.11	-13.00	-56.35
644.01	-71.38	-72.66	3.56	-2.28	-13.00	-58.38
3720.00	-54.42	-59.20	12.34	-7.56	-13.00	-41.42
5580.00	-54.99	-58.52	12.96	-9.42	-13.00	-41.99
7929.96	-44.79	-45.20	11.08	-10.67	-13.00	-31.79
11894.94	-42.32	-42.76	12.78	-12.34	-13.00	-29.32

Unless otherwise stated the results shown in this test report refer only to the sample(s) tested and such sample(s) are retained for 90 days only.

除非另有說明，此報告結果僅對測試之樣品負責，同時此樣品僅保留90天。本報告未經本公司書面許可，不可部份複製。

This document is issued by the Company subject to its General Conditions of Service printed overleaf, available on request or accessible at <http://www.sgs.com.tw/Terms-and-Conditions> and for electronic format documents, subject to Terms and Conditions for Electronic Documents at <http://www.sgs.com.tw/Terms-and-Conditions>. Attention is drawn to the limitation of liability, indemnification and jurisdiction issues defined therein. Any holder of this document is advised that information contained hereon reflects the Company's findings at the time of its intervention only and within the limits of Client's instructions, if any. The Company's sole responsibility is to its Client and this document does not exonerate parties to a transaction from exercising all their rights and obligations under the transaction documents. This document cannot be reproduced except in full, without prior written approval of the Company. Any unauthorized alteration, forgery or falsification of the content or appearance of this document is unlawful and offenders may be prosecuted to the fullest extent of the law.

Report Number :ER/2022/30084
 Operation Mode :2A_n77A
 Test Mode :Tx CH Low_High
 EUT Pol :H Plane
 Test Frequency :1860_3964.98 MHz

Test Site :SAC 1
 Test Date :2022-05-12
 Temp./Humi. :25.7/70
 Antenna Pol. :Horizontal
 Engineer :GN Lin

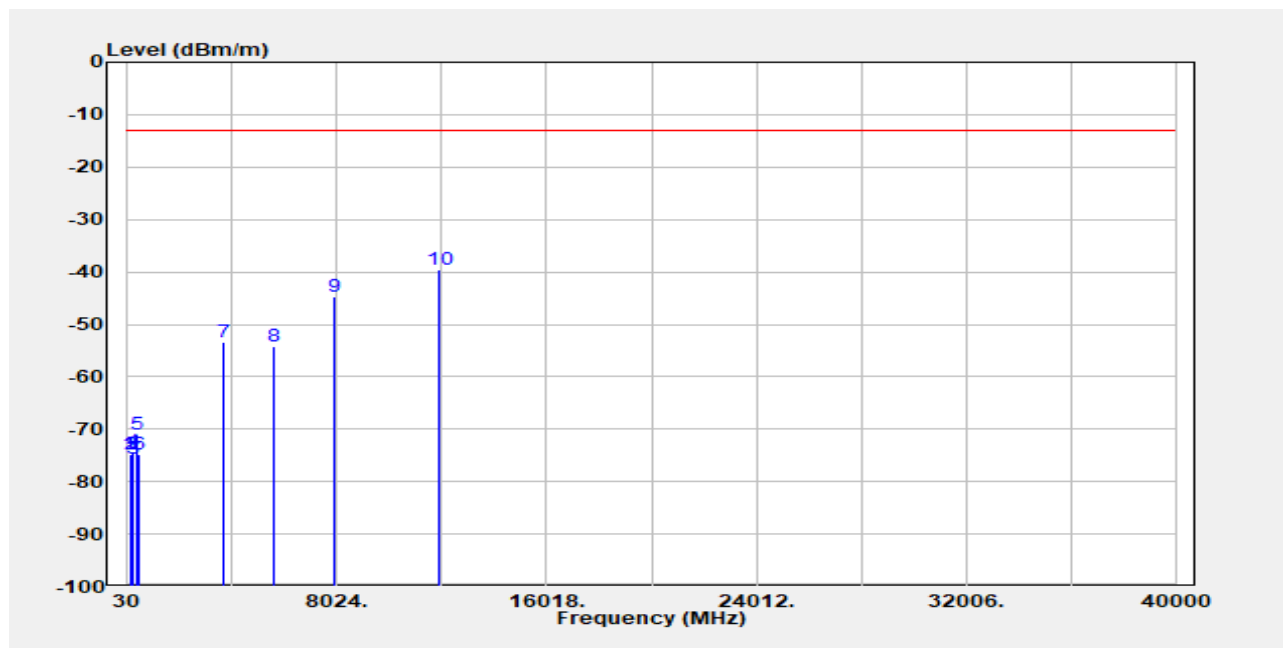

Freq. MHz	EIRP/ERP dBm	SG Output Level dBm	Antenna Gain dBi/dBd	Cable Loss dB	Limit dBm	Margin dB
115.36	-74.74	-71.94	-1.71	-1.10	-13.00	-61.74
132.82	-74.86	-71.68	-1.97	-1.21	-13.00	-61.86
194.90	-75.48	-77.92	3.88	-1.43	-13.00	-62.48
252.13	-74.25	-76.97	4.33	-1.60	-13.00	-61.25
396.66	-70.94	-73.15	4.32	-2.10	-13.00	-57.94
480.08	-74.74	-76.50	4.21	-2.44	-13.00	-61.74
3720.00	-53.49	-58.27	12.34	-7.56	-13.00	-40.49
5580.00	-54.12	-57.65	12.96	-9.42	-13.00	-41.12
7929.96	-44.65	-45.05	11.08	-10.67	-13.00	-31.65
11894.94	-39.50	-39.94	12.78	-12.34	-13.00	-26.50

Unless otherwise stated the results shown in this test report refer only to the sample(s) tested and such sample(s) are retained for 90 days only.

除非另有說明，此報告結果僅對測試之樣品負責，同時此樣品僅保留90天。本報告未經本公司書面許可，不可部份複製。

This document is issued by the Company subject to its General Conditions of Service printed overleaf, available on request or accessible at <http://www.sgs.com.tw/Terms-and-Conditions> and for electronic format documents, subject to Terms and Conditions for Electronic Documents at <http://www.sgs.com.tw/Terms-and-Conditions>. Attention is drawn to the limitation of liability, indemnification and jurisdiction issues defined therein. Any holder of this document is advised that information contained hereon reflects the Company's findings at the time of its intervention only and within the limits of Client's instructions, if any. The Company's sole responsibility is to its Client and this document does not exonerate parties to a transaction from exercising all their rights and obligations under the transaction documents. This document cannot be reproduced except in full, without prior written approval of the Company. Any unauthorized alteration, forgery or falsification of the content or appearance of this document is unlawful and offenders may be prosecuted to the fullest extent of the law.

Report Number :ER/2022/30084
 Operation Mode :5A_n77A
 Test Mode :Tx CH Low_High
 EUT Pol :H Plane
 Test Frequency :829_3964.98 MHz

Test Site :SAC 1
 Test Date :2022-05-12
 Temp./Humi. :25.7/70
 Antenna Pol. :Vertical
 Engineer :GN Lin

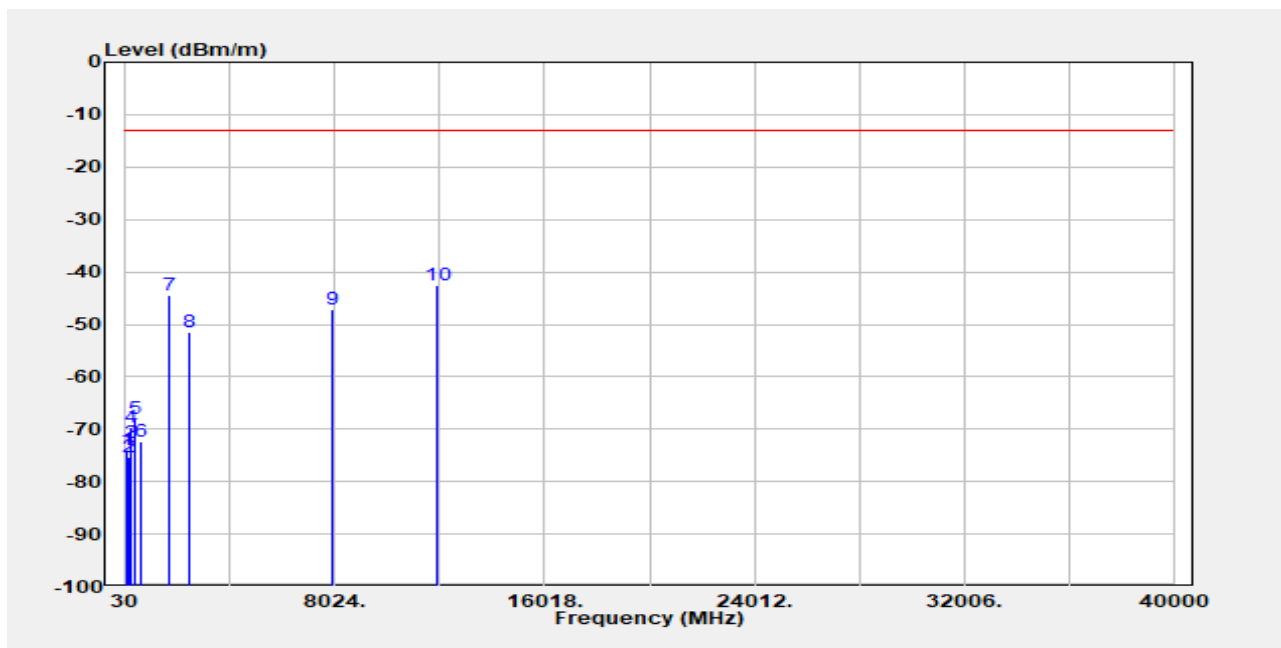

Freq. MHz	EIRP/ERP dBm	SG Output Level dBm	Antenna Gain dBi/dBd	Cable Loss dB	Limit dBm	Margin dB
48.43	-73.87	-61.04	-12.13	-0.70	-13.00	-60.87
127.00	-75.23	-72.03	-2.04	-1.16	-13.00	-62.23
195.87	-72.52	-75.09	4.01	-1.43	-13.00	-59.52
252.13	-69.78	-72.51	4.33	-1.60	-13.00	-56.78
398.60	-67.98	-70.18	4.32	-2.12	-13.00	-54.98
601.33	-72.31	-73.32	3.64	-2.63	-13.00	-59.31
1658.00	-44.52	-49.77	9.52	-4.27	-13.00	-31.52
2487.00	-51.54	-56.94	10.57	-5.18	-13.00	-38.54
7929.96	-47.25	-47.66	11.08	-10.67	-13.00	-34.25
11894.94	-42.56	-43.00	12.78	-12.34	-13.00	-29.56

Unless otherwise stated the results shown in this test report refer only to the sample(s) tested and such sample(s) are retained for 90 days only.

除非另有說明，此報告結果僅對測試之樣品負責，同時此樣品僅保留90天。本報告未經本公司書面許可，不可部份複製。

This document is issued by the Company subject to its General Conditions of Service printed overleaf, available on request or accessible at <http://www.sgs.com.tw/Terms-and-Conditions> and for electronic format documents, subject to Terms and Conditions for Electronic Documents at <http://www.sgs.com.tw/Terms-and-Conditions>. Attention is drawn to the limitation of liability, indemnification and jurisdiction issues defined therein. Any holder of this document is advised that information contained hereon reflects the Company's findings at the time of its intervention only and within the limits of Client's instructions, if any. The Company's sole responsibility is to its Client and this document does not exonerate parties to a transaction from exercising all their rights and obligations under the transaction documents. This document cannot be reproduced except in full, without prior written approval of the Company. Any unauthorized alteration, forgery or falsification of the content or appearance of this document is unlawful and offenders may be prosecuted to the fullest extent of the law.

Report Number :ER/2022/30084
 Operation Mode :5A_n77A
 Test Mode :Tx CH Low_High
 EUT Pol :H Plane
 Test Frequency :829_3964.98 MHz

Test Site :SAC 1
 Test Date :2022-05-12
 Temp./Humi. :25.7/70
 Antenna Pol. :Horizontal
 Engineer :GN Lin

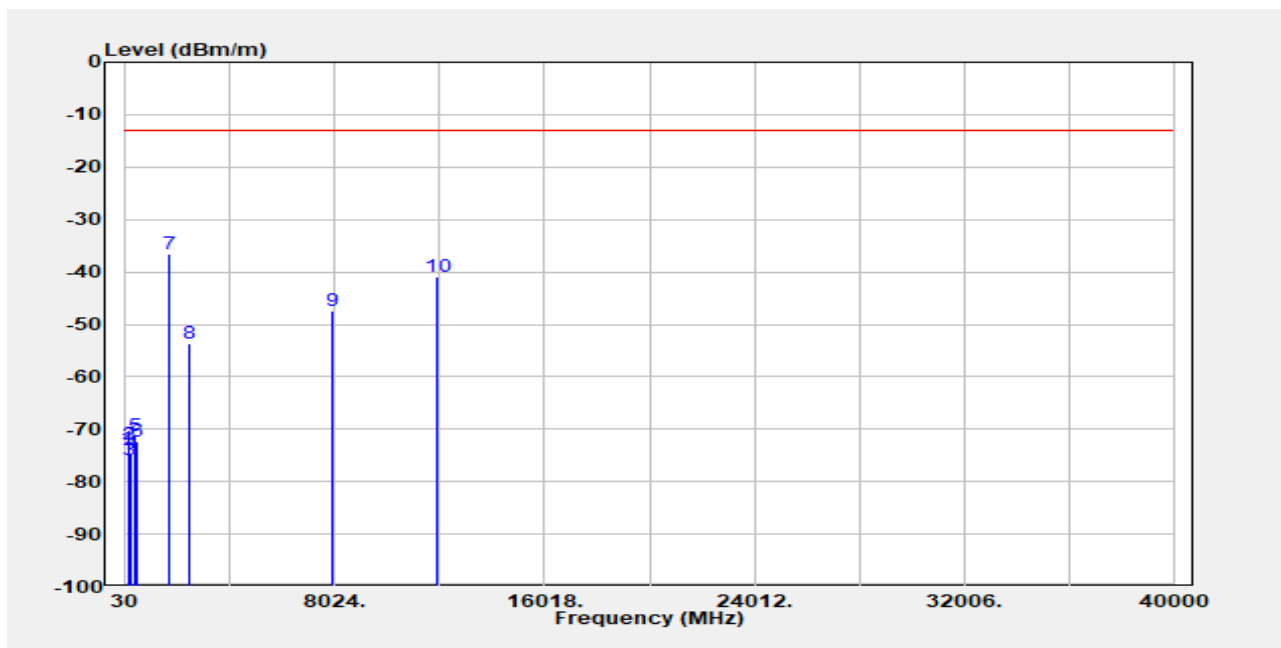

Freq. MHz	EIRP/ERP dBm	SG Output Level dBm	Antenna Gain dBi/dBd	Cable Loss dB	Limit dBm	Margin dB
116.33	-73.59	-70.88	-1.61	-1.10	-13.00	-60.59
127.00	-72.99	-69.78	-2.04	-1.16	-13.00	-59.99
193.93	-75.93	-78.32	3.83	-1.43	-13.00	-62.93
252.13	-74.57	-77.30	4.33	-1.60	-13.00	-61.57
394.72	-71.21	-73.44	4.32	-2.08	-13.00	-58.21
480.08	-72.43	-74.20	4.21	-2.44	-13.00	-59.43
1658.00	-36.48	-41.73	9.52	-4.27	-13.00	-23.48
2487.00	-53.64	-59.04	10.57	-5.18	-13.00	-40.64
7929.96	-47.47	-47.88	11.08	-10.67	-13.00	-34.47
11894.94	-41.01	-41.46	12.78	-12.34	-13.00	-28.01

Unless otherwise stated the results shown in this test report refer only to the sample(s) tested and such sample(s) are retained for 90 days only.

除非另有說明，此報告結果僅對測試之樣品負責，同時此樣品僅保留90天。本報告未經本公司書面許可，不可部份複製。

This document is issued by the Company subject to its General Conditions of Service printed overleaf, available on request or accessible at <http://www.sgs.com.tw/Terms-and-Conditions> and for electronic format documents, subject to Terms and Conditions for Electronic Documents at <http://www.sgs.com.tw/Terms-and-Conditions>. Attention is drawn to the limitation of liability, indemnification and jurisdiction issues defined therein. Any holder of this document is advised that information contained hereon reflects the Company's findings at the time of its intervention only and within the limits of Client's instructions, if any. The Company's sole responsibility is to its Client and this document does not exonerate parties to a transaction from exercising all their rights and obligations under the transaction documents. This document cannot be reproduced except in full, without prior written approval of the Company. Any unauthorized alteration, forgery or falsification of the content or appearance of this document is unlawful and offenders may be prosecuted to the fullest extent of the law.

Report Number :ER/2022/30084
 Operation Mode :13A_n77A
 Test Mode :Tx CH Mid_High
 EUT Pol :H Plane
 Test Frequency :782_3964.98 MHz

Test Site :SAC 1
 Test Date :2022-05-12
 Temp./Humi. :25.7/70
 Antenna Pol. :Vertical
 Engineer :GN Lin

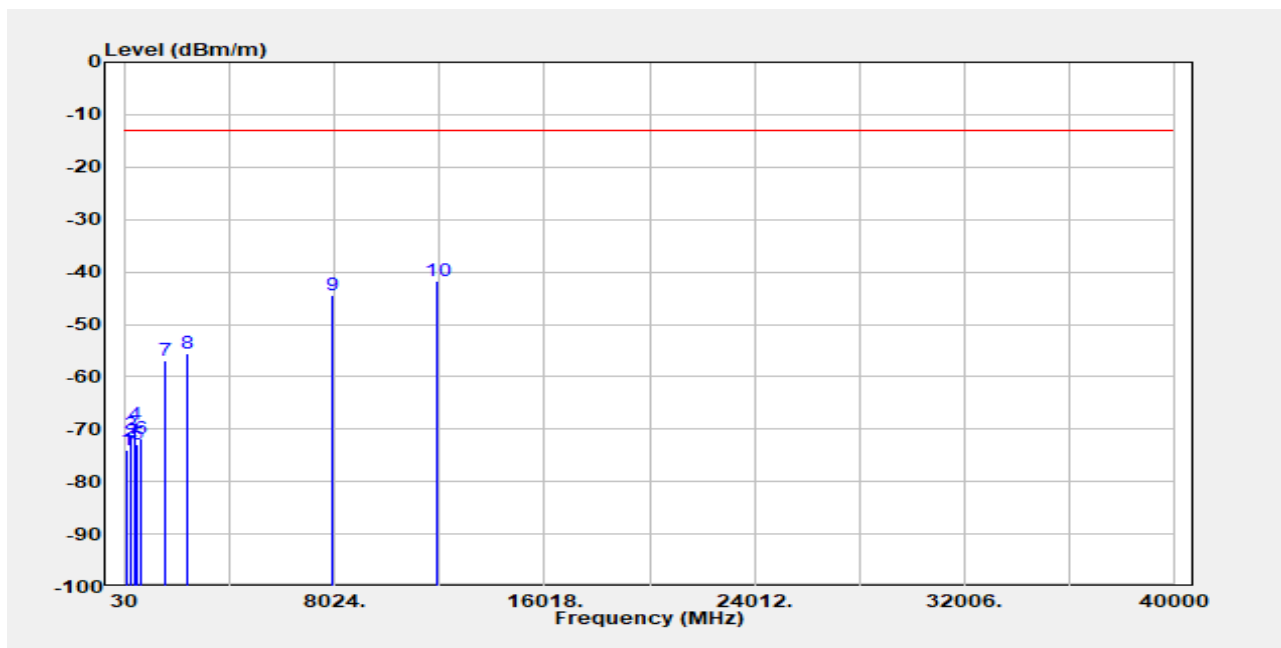

Freq. MHz	EIRP/ERP dBm	SG Output Level dBm	Antenna Gain dBi/dBd	Cable Loss dB	Limit dBm	Margin dB
48.43	-73.97	-61.14	-12.13	-0.70	-13.00	-60.97
194.90	-72.36	-74.80	3.88	-1.43	-13.00	-59.36
252.13	-71.06	-73.78	4.33	-1.60	-13.00	-58.06
396.66	-69.20	-71.41	4.32	-2.10	-13.00	-56.20
480.08	-72.94	-74.70	4.21	-2.44	-13.00	-59.94
600.36	-71.77	-72.77	3.64	-2.64	-13.00	-58.77
1564.00	-57.03	-62.11	9.18	-4.10	-13.00	-44.03
2346.00	-55.47	-60.24	9.78	-5.01	-13.00	-42.47
7929.96	-44.46	-44.87	11.08	-10.67	-13.00	-31.46
11894.94	-41.83	-42.27	12.78	-12.34	-13.00	-28.83

Unless otherwise stated the results shown in this test report refer only to the sample(s) tested and such sample(s) are retained for 90 days only.

除非另有說明，此報告結果僅對測試之樣品負責，同時此樣品僅保留90天。本報告未經本公司書面許可，不可部份複製。

This document is issued by the Company subject to its General Conditions of Service printed overleaf, available on request or accessible at <http://www.sgs.com.tw/Terms-and-Conditions> and for electronic format documents, subject to Terms and Conditions for Electronic Documents at <http://www.sgs.com.tw/Terms-and-Conditions>. Attention is drawn to the limitation of liability, indemnification and jurisdiction issues defined therein. Any holder of this document is advised that information contained hereon reflects the Company's findings at the time of its intervention only and within the limits of Client's instructions, if any. The Company's sole responsibility is to its Client and this document does not exonerate parties to a transaction from exercising all their rights and obligations under the transaction documents. This document cannot be reproduced except in full, without prior written approval of the Company. Any unauthorized alteration, forgery or falsification of the content or appearance of this document is unlawful and offenders may be prosecuted to the fullest extent of the law.

Report Number :ER/2022/30084
 Operation Mode :13A_n77A
 Test Mode :Tx CH Mid_High
 EUT Pol :H Plane
 Test Frequency :782_3964.98 MHz

Test Site :SAC 1
 Test Date :2022-05-12
 Temp./Humi. :25.7/70
 Antenna Pol. :Horizontal
 Engineer :GN Lin

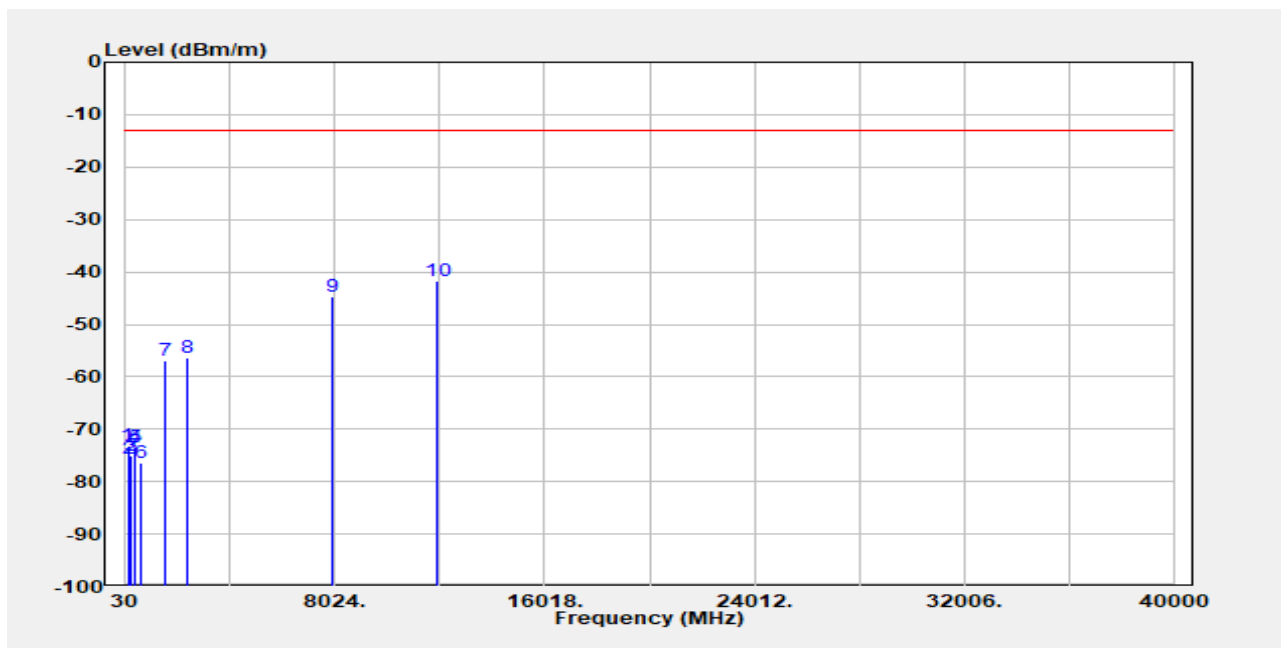

Freq. MHz	EIRP/ERP dBm	SG Output Level dBm	Antenna Gain dBi/dBd	Cable Loss dB	Limit dBm	Margin dB
116.33	-73.27	-70.56	-1.61	-1.10	-13.00	-60.27
130.88	-75.63	-72.46	-1.99	-1.18	-13.00	-62.63
251.16	-75.00	-77.74	4.33	-1.59	-13.00	-62.00
384.05	-73.54	-75.91	4.39	-2.02	-13.00	-60.54
394.72	-73.48	-75.71	4.32	-2.08	-13.00	-60.48
609.09	-76.42	-77.41	3.51	-2.52	-13.00	-63.42
1564.00	-56.81	-61.89	9.18	-4.10	-13.00	-43.81
2346.00	-56.25	-61.02	9.78	-5.01	-13.00	-43.25
7905.96	-44.80	-45.34	11.18	-10.64	-13.00	-31.80
11894.94	-41.85	-42.29	12.78	-12.34	-13.00	-28.85

Unless otherwise stated the results shown in this test report refer only to the sample(s) tested and such sample(s) are retained for 90 days only.

除非另有說明，此報告結果僅對測試之樣品負責，同時此樣品僅保留90天。本報告未經本公司書面許可，不可部份複製。

This document is issued by the Company subject to its General Conditions of Service printed overleaf, available on request or accessible at <http://www.sgs.com.tw/Terms-and-Conditions> and for electronic format documents, subject to Terms and Conditions for Electronic Documents at <http://www.sgs.com.tw/Terms-and-Conditions>. Attention is drawn to the limitation of liability, indemnification and jurisdiction issues defined therein. Any holder of this document is advised that information contained hereon reflects the Company's findings at the time of its intervention only and within the limits of Client's instructions, if any. The Company's sole responsibility is to its Client and this document does not exonerate parties to a transaction from exercising all their rights and obligations under the transaction documents. This document cannot be reproduced except in full, without prior written approval of the Company. Any unauthorized alteration, forgery or falsification of the content or appearance of this document is unlawful and offenders may be prosecuted to the fullest extent of the law.

Report Number :ER/2022/30084
 Operation Mode :66A_n77A
 Test Mode :Tx CH Low_High
 EUT Pol :H Plane
 Test Frequency :1720_3964.98 MHz

Test Site :SAC 1
 Test Date :2022-05-12
 Temp./Humi. :25.7/70
 Antenna Pol. :Vertical
 Engineer :GN Lin

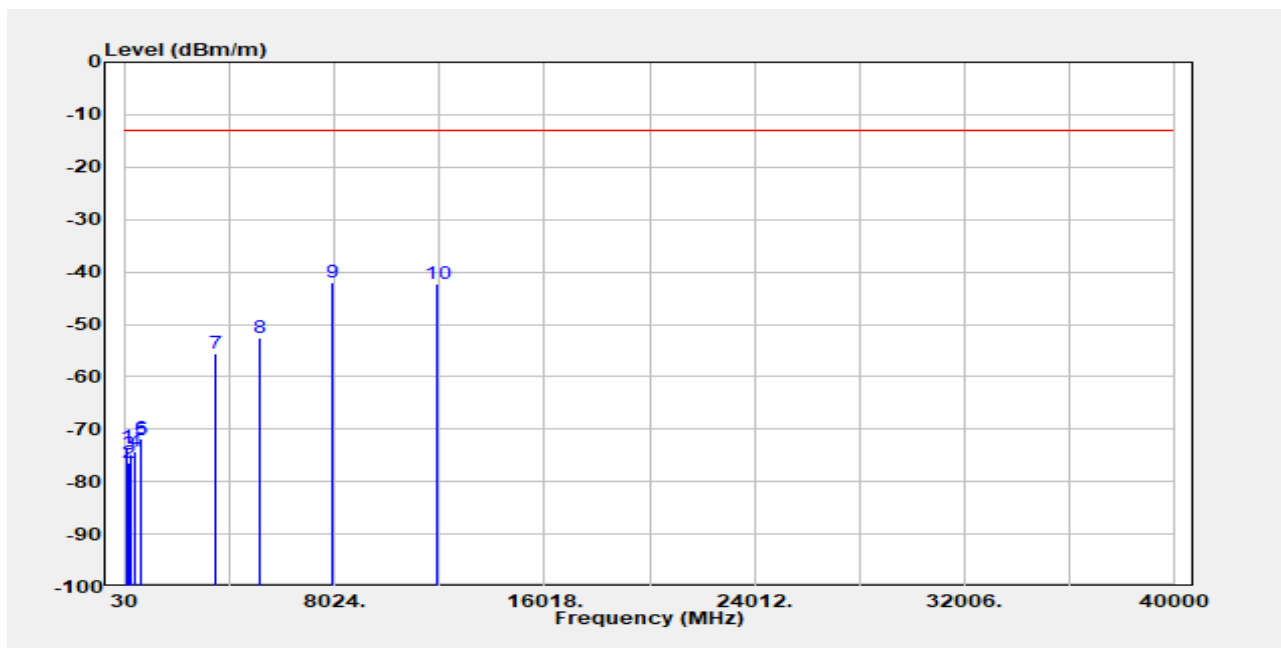

Freq. MHz	EIRP/ERP dBm	SG Output Level dBm	Antenna Gain dBi/dBd	Cable Loss dB	Limit dBm	Margin dB
48.43	-73.50	-60.67	-12.13	-0.70	-13.00	-60.50
122.15	-76.36	-73.33	-1.88	-1.14	-13.00	-63.36
191.99	-74.90	-77.01	3.54	-1.43	-13.00	-61.90
397.63	-74.34	-76.54	4.32	-2.11	-13.00	-61.34
596.48	-72.14	-73.23	3.73	-2.65	-13.00	-59.14
606.18	-71.71	-72.73	3.58	-2.56	-13.00	-58.71
3440.00	-55.61	-62.19	12.52	-5.95	-13.00	-42.61
5160.00	-52.69	-56.92	12.16	-7.93	-13.00	-39.69
7929.96	-41.93	-42.33	11.08	-10.67	-13.00	-28.93
11894.94	-42.34	-42.78	12.78	-12.34	-13.00	-29.34

Unless otherwise stated the results shown in this test report refer only to the sample(s) tested and such sample(s) are retained for 90 days only.

除非另有說明，此報告結果僅對測試之樣品負責，同時此樣品僅保留90天。本報告未經本公司書面許可，不可部份複製。

This document is issued by the Company subject to its General Conditions of Service printed overleaf, available on request or accessible at <http://www.sgs.com.tw/Terms-and-Conditions> and for electronic format documents, subject to Terms and Conditions for Electronic Documents at <http://www.sgs.com.tw/Terms-and-Conditions>. Attention is drawn to the limitation of liability, indemnification and jurisdiction issues defined therein. Any holder of this document is advised that information contained hereon reflects the Company's findings at the time of its intervention only and within the limits of Client's instructions, if any. The Company's sole responsibility is to its Client and this document does not exonerate parties to a transaction from exercising all their rights and obligations under the transaction documents. This document cannot be reproduced except in full, without prior written approval of the Company. Any unauthorized alteration, forgery or falsification of the content or appearance of this document is unlawful and offenders may be prosecuted to the fullest extent of the law.

Report Number :ER/2022/30084
 Operation Mode :66A_n77A
 Test Mode :Tx CH Low_High
 EUT Pol :H Plane
 Test Frequency :1720_3964.98 MHz

Test Site :SAC 1
 Test Date :2022-05-12
 Temp./Humi. :25.7/70
 Antenna Pol. :Horizontal
 Engineer :GN Lin

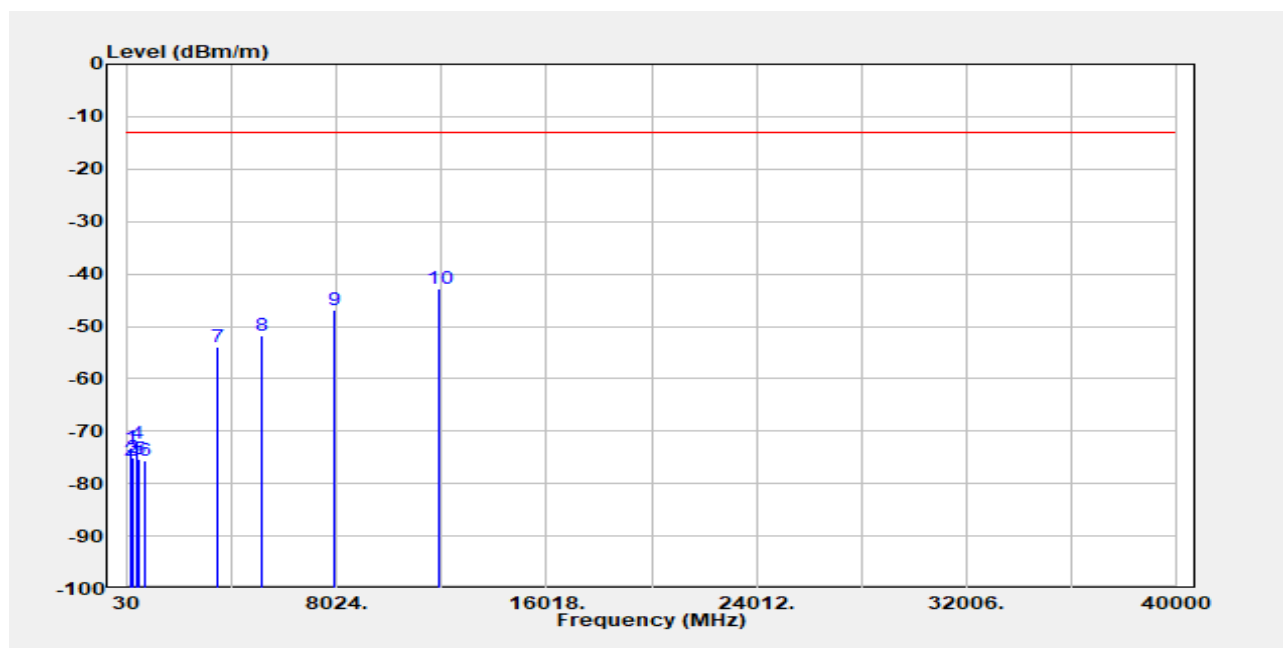

Freq. MHz	EIRP/ERP dBm	SG Output Level dBm	Antenna Gain dBi/dBd	Cable Loss dB	Limit dBm	Margin dB
118.27	-73.10	-70.27	-1.72	-1.12	-13.00	-60.10
131.85	-75.74	-72.46	-2.09	-1.20	-13.00	-62.74
251.16	-74.99	-77.73	4.33	-1.59	-13.00	-61.99
394.72	-72.23	-74.46	4.32	-2.08	-13.00	-59.23
480.08	-75.21	-76.98	4.21	-2.44	-13.00	-62.21
676.99	-75.65	-76.55	3.85	-2.95	-13.00	-62.65
3440.00	-53.87	-60.44	12.52	-5.95	-13.00	-40.87
5160.00	-51.65	-55.89	12.16	-7.93	-13.00	-38.65
7929.96	-46.79	-47.20	11.08	-10.67	-13.00	-33.79
11894.94	-42.72	-43.17	12.78	-12.34	-13.00	-29.72

Unless otherwise stated the results shown in this test report refer only to the sample(s) tested and such sample(s) are retained for 90 days only.

除非另有說明，此報告結果僅對測試之樣品負責，同時此樣品僅保留90天。本報告未經本公司書面許可，不可部份複製。

This document is issued by the Company subject to its General Conditions of Service printed overleaf, available on request or accessible at <http://www.sgs.com.tw/Terms-and-Conditions> and for electronic format documents, subject to Terms and Conditions for Electronic Documents at <http://www.sgs.com.tw/Terms-and-Conditions>. Attention is drawn to the limitation of liability, indemnification and jurisdiction issues defined therein. Any holder of this document is advised that information contained hereon reflects the Company's findings at the time of its intervention only and within the limits of Client's instructions, if any. The Company's sole responsibility is to its Client and this document does not exonerate parties to a transaction from exercising all their rights and obligations under the transaction documents. This document cannot be reproduced except in full, without prior written approval of the Company. Any unauthorized alteration, forgery or falsification of the content or appearance of this document is unlawful and offenders may be prosecuted to the fullest extent of the law.

11 FREQUENCY STABILITY MEASUREMENT

11.1 Standard Applicabl

The frequency stability shall be sufficient to ensure that the fundamental emission stays within the authorized frequency block.

11.2 Test Set-up

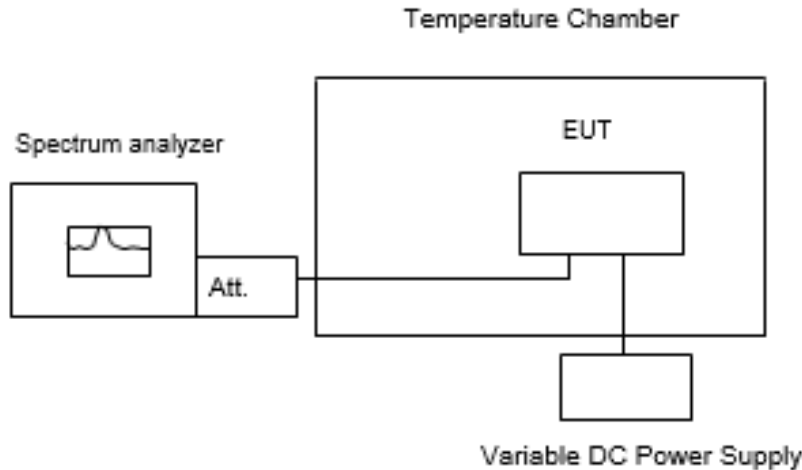

Note: Measurement setup for testing on Antenna connector

11.3 Measurement Procedure

The equipment under test was connected to an external AC or DC power supply and input rated voltage. RF output was connected to a frequency counter or spectrum analyzer via feed through attenuators. The EUT was placed inside the temperature chamber. Set the spectrum analyzer RBW low enough to obtain the desired frequency resolution and measure EUT 25°C operating frequency as reference frequency. Turn EUT off and set the chamber temperature to -30°C. After the temperature stabilized for approximately 30 minutes recorded the frequency. Repeat step measure with 10°C increased per stage until the highest temperature of +50°C reached.

Set chamber temperature to 25°C. Use a variable AC power supply / DC power source to power the EUT and set the voltage to rated voltage. Set the spectrum analyzer RBW low enough to obtain the desired frequency resolution and recorded the frequency.

Reduce the input voltage to specify extreme voltage variation (+/- 15%) and endpoint as declared by the manufacturer, record the maximum frequency change.

11.4 Measurement Result

Note: The power is rated 120V.

Unless otherwise stated the results shown in this test report refer only to the sample(s) tested and such sample(s) are retained for 90 days only.

除非另有說明，此報告結果僅對測試之樣品負責，同時此樣品僅保留90天。本報告未經本公司書面許可，不可部份複製。

This document is issued by the Company subject to its General Conditions of Service printed overleaf, available on request or accessible at <http://www.sgs.com.tw/Terms-and-Conditions> and for electronic format documents, subject to Terms and Conditions for Electronic Documents at <http://www.sgs.com.tw/Terms-and-Conditions>. Attention is drawn to the limitation of liability, indemnification and jurisdiction issues defined therein. Any holder of this document is advised that information contained hereon reflects the Company's findings at the time of its intervention only and within the limits of Client's instructions, if any. The Company's sole responsibility is to its Client and this document does not exonerate parties to a transaction from exercising all their rights and obligations under the transaction documents. This document cannot be reproduced except in full, without prior written approval of the Company. Any unauthorized alteration, forgery or falsification of the content or appearance of this document is unlawful and offenders may be prosecuted to the fullest extent of the law.

5G NR BAND n2				
Reference Freq.:		Modulation.:		CP-OFDM QPSK
SCS.:	15 kHz	Bandwidth:		20MHz
CH	376000	Frequency(MHz):		1880.00
Freq. ERROR vs. VOLTAGE				
Power Supply Vdc	Temp. (°C)	Freq. (MHz)	Delta (Hz)	Limit = +/- 2.5 ppm (Hz)
138	25	1879.999990	-10	4700
120	25	1879.999981	-19	4700
102	25	1880.000008	8	4700
62 (End Point)	25	1880.000012	12	4700
Freq. ERROR vs. Temp.				
Power Supply Vdc	Temp. (°C)	Freq. (MHz)	Delta (Hz)	Limit = +/- 2.5 ppm (Hz)
120	-30	1879.999988	-12	4700
120	-20	1879.999983	-17	4700
120	-10	1880.000012	12	4700
120	0	1879.999994	-6	4700
120	10	1880.000019	19	4700
120	20	1879.999986	-14	4700
120	30	1880.000018	18	4700
120	40	1880.000012	12	4700
120	50	1880.000006	6	4700

Unless otherwise stated the results shown in this test report refer only to the sample(s) tested and such sample(s) are retained for 90 days only.

除非另有說明，此報告結果僅對測試之樣品負責，同時此樣品僅保留90天。本報告未經本公司書面許可，不可部份複製。

This document is issued by the Company subject to its General Conditions of Service printed overleaf, available on request or accessible at <http://www.sgs.com.tw/Terms-and-Conditions> and for electronic format documents, subject to Terms and Conditions for Electronic Documents at <http://www.sgs.com.tw/Terms-and-Conditions>. Attention is drawn to the limitation of liability, indemnification and jurisdiction issues defined therein. Any holder of this document is advised that information contained hereon reflects the Company's findings at the time of its intervention only and within the limits of Client's instructions, if any. The Company's sole responsibility is to its Client and this document does not exonerate parties to a transaction from exercising all their rights and obligations under the transaction documents. This document cannot be reproduced except in full, without prior written approval of the Company. Any unauthorized alteration, forgery or falsification of the content or appearance of this document is unlawful and offenders may be prosecuted to the fullest extent of the law.

5G NR BAND n5				
Reference Freq.:		Modulation.:		CP-OFDM QPSK
SCS.:	15 kHz	Bandwidth:		20MHz
CH	167300	Frequency(MHz):		836.50
Freq. ERROR vs. VOLTAGE				
Power Supply Vdc	Temp. (°C)	Freq. (MHz)	Delta (Hz)	Limit = +/- 2.5 ppm (Hz)
138	25	836.500015	15	2091
120	25	836.500012	12	2091
102	25	836.499990	-10	2091
62 (End Point)	25	836.499984	-16	2091
Freq. ERROR vs. Temp.				
Power Supply Vdc	Temp. (°C)	Freq. (MHz)	Delta (Hz)	Limit = +/- 2.5 ppm (Hz)
120	-30	836.499990	-10	2091
120	-20	836.499993	-7	2091
120	-10	836.500014	14	2091
120	0	836.499990	-10	2091
120	10	836.500012	12	2091
120	20	836.500003	3	2091
120	30	836.499980	-20	2091
120	40	836.500019	19	2091
120	50	836.500015	15	2091

Unless otherwise stated the results shown in this test report refer only to the sample(s) tested and such sample(s) are retained for 90 days only.

除非另有說明，此報告結果僅對測試之樣品負責，同時此樣品僅保留90天。本報告未經本公司書面許可，不可部份複製。

This document is issued by the Company subject to its General Conditions of Service printed overleaf, available on request or accessible at <http://www.sgs.com.tw/Terms-and-Conditions> and for electronic format documents, subject to Terms and Conditions for Electronic Documents at <http://www.sgs.com.tw/Terms-and-Conditions>. Attention is drawn to the limitation of liability, indemnification and jurisdiction issues defined therein. Any holder of this document is advised that information contained hereon reflects the Company's findings at the time of its intervention only and within the limits of Client's instructions, if any. The Company's sole responsibility is to its Client and this document does not exonerate parties to a transaction from exercising all their rights and obligations under the transaction documents. This document cannot be reproduced except in full, without prior written approval of the Company. Any unauthorized alteration, forgery or falsification of the content or appearance of this document is unlawful and offenders may be prosecuted to the fullest extent of the law.

5G NR BAND n66				
Reference Freq.:		Modulation.:		CP-OFDM QPSK
SCS.:	15 kHz	Bandwidth:		40MHz
CH	349000	Frequency(MHz):		1745.00
Freq. ERROR vs. VOLTAGE				
Power Supply Vdc	Temp. (°C)	Freq. (MHz)	Delta (Hz)	Limit = +/- 2.5 ppm (Hz)
138	25	1744.999983	-17	4363
120	25	1745.000010	10	4363
102	25	1745.000001	1	4363
62 (End Point)	25	1744.999996	-4	4363
Freq. ERROR vs. Temp.				
Power Supply Vdc	Temp. (°C)	Freq. (MHz)	Delta (Hz)	Limit = +/- 2.5 ppm (Hz)
120	-30	1745.000012	12	4363
120	-20	1745.000005	5	4363
120	-10	1745.000002	2	4363
120	0	1744.999997	-3	4363
120	10	1745.000005	5	4363
120	20	1744.999990	-10	4363
120	30	1744.999990	-10	4363
120	40	1744.999996	-4	4363
120	50	1745.000001	1	4363

Unless otherwise stated the results shown in this test report refer only to the sample(s) tested and such sample(s) are retained for 90 days only.

除非另有說明，此報告結果僅對測試之樣品負責，同時此樣品僅保留90天。本報告未經本公司書面許可，不可部份複製。

This document is issued by the Company subject to its General Conditions of Service printed overleaf, available on request or accessible at <http://www.sgs.com.tw/Terms-and-Conditions> and for electronic format documents, subject to Terms and Conditions for Electronic Documents at <http://www.sgs.com.tw/Terms-and-Conditions>. Attention is drawn to the limitation of liability, indemnification and jurisdiction issues defined therein. Any holder of this document is advised that information contained hereon reflects the Company's findings at the time of its intervention only and within the limits of Client's instructions, if any. The Company's sole responsibility is to its Client and this document does not exonerate parties to a transaction from exercising all their rights and obligations under the transaction documents. This document cannot be reproduced except in full, without prior written approval of the Company. Any unauthorized alteration, forgery or falsification of the content or appearance of this document is unlawful and offenders may be prosecuted to the fullest extent of the law.

5G NR BAND n77 Part27				
Reference Freq.:		Modulation.:		CP-OFDM QPSK
SCS.:	30 kHz	Bandwidth:		100MHz
CH	656000	Frequency(MHz):		3840.00
Freq. ERROR vs. VOLTAGE				
Power Supply Vdc	Temp. (°C)	Freq. (MHz)	Delta (Hz)	Limit = +/- 2.5 ppm (Hz)
138	25	3840.000013	13	9600
120	25	3839.999991	-9	9600
102	25	3840.000007	7	9600
62 (End Point)	25	3839.999993	-7	9600
Freq. ERROR vs. Temp.				
Power Supply Vdc	Temp. (°C)	Freq. (MHz)	Delta (Hz)	Limit = +/- 2.5 ppm (Hz)
120	-30	3839.999995	-5	9600
120	-20	3839.999985	-15	9600
120	-10	3840.000004	4	9600
120	0	3840.000000	0	9600
120	10	3840.000018	18	9600
120	20	3840.000009	9	9600
120	30	3839.999998	-2	9600
120	40	3840.000004	4	9600
120	50	3839.999998	-2	9600

Unless otherwise stated the results shown in this test report refer only to the sample(s) tested and such sample(s) are retained for 90 days only.

除非另有說明，此報告結果僅對測試之樣品負責，同時此樣品僅保留90天。本報告未經本公司書面許可，不可部份複製。

This document is issued by the Company subject to its General Conditions of Service printed overleaf, available on request or accessible at <http://www.sgs.com.tw/Terms-and-Conditions> and for electronic format documents, subject to Terms and Conditions for Electronic Documents at <http://www.sgs.com.tw/Terms-and-Conditions>. Attention is drawn to the limitation of liability, indemnification and jurisdiction issues defined therein. Any holder of this document is advised that information contained hereon reflects the Company's findings at the time of its intervention only and within the limits of Client's instructions, if any. The Company's sole responsibility is to its Client and this document does not exonerate parties to a transaction from exercising all their rights and obligations under the transaction documents. This document cannot be reproduced except in full, without prior written approval of the Company. Any unauthorized alteration, forgery or falsification of the content or appearance of this document is unlawful and offenders may be prosecuted to the fullest extent of the law.

5G NR BAND n77 Part27				
Reference Freq.:		Modulation.:		CP-OFDM QPSK
SCS.:	30	kHz	Bandwidth:	100MHz
CH	633334		Freqency(MHz):	3500.01
Freq. ERROR vs. VOLTAGE				
Power Supply Vdc	Temp. (°C)	Freq. (MHz)	Delta (Hz)	Limit = +/- 2.5 ppm (Hz)
138	25	3500.010005	5	8750
120	25	3500.010011	11	8750
102	25	3500.009982	-18	8750
0 (End Point)	25	3500.009995	-5	8750
Freq. ERROR vs. Temp.				
Power Supply Vdc	Temp. (°C)	Freq. (MHz)	Delta (Hz)	Limit = +/- 2.5 ppm (Hz)
120	-30	3500.010018	18	8750
120	-20	3500.010006	6	8750
120	-10	3500.009996	-4	8750
120	0	3500.010010	10	8750
120	10	3500.009995	-5	8750
120	20	3500.010002	2	8750
120	30	3500.010009	9	8750
120	40	3500.010015	15	8750
120	50	3500.009984	-16	8750

Unless otherwise stated the results shown in this test report refer only to the sample(s) tested and such sample(s) are retained for 90 days only.

除非另有說明，此報告結果僅對測試之樣品負責，同時此樣品僅保留90天。本報告未經本公司書面許可，不可部份複製。

This document is issued by the Company subject to its General Conditions of Service printed overleaf, available on request or accessible at <http://www.sgs.com.tw/Terms-and-Conditions> and for electronic format documents, subject to Terms and Conditions for Electronic Documents at <http://www.sgs.com.tw/Terms-and-Conditions>. Attention is drawn to the limitation of liability, indemnification and jurisdiction issues defined therein. Any holder of this document is advised that information contained hereon reflects the Company's findings at the time of its intervention only and within the limits of Client's instructions, if any. The Company's sole responsibility is to its Client and this document does not exonerate parties to a transaction from exercising all their rights and obligations under the transaction documents. This document cannot be reproduced except in full, without prior written approval of the Company. Any unauthorized alteration, forgery or falsification of the content or appearance of this document is unlawful and offenders may be prosecuted to the fullest extent of the law.

MIMO

5G NR BAND n77 Part27				
Reference Freq.:		Modulation.:		CP-OFDM QPSK
SCS.:	30 kHz	Bandwidth:		100MHz
CH	633334	Frequency(MHz):		3500.01
Freq. ERROR vs. VOLTAGE				
Power Supply Vdc	Temp. (°C)	Freq. (MHz)	Delta (Hz)	Limit = +/- 2.5 ppm (Hz)
138	25	3500.010008	8	8750
120	25	3500.009986	-14	8750
102	25	3500.010003	3	8750
0 (End Point)	25	3500.009999	-1	8750
Freq. ERROR vs. Temp.				
Power Supply Vdc	Temp. (°C)	Freq. (MHz)	Delta (Hz)	Limit = +/- 2.5 ppm (Hz)
120	-30	3500.009992	-8	8750
120	-20	3500.009990	-10	8750
120	-10	3500.010009	9	8750
120	0	3500.010005	5	8750
120	10	3500.009998	-2	8750
120	20	3500.010001	1	8750
120	30	3500.009998	-2	8750
120	40	3500.010004	4	8750
120	50	3500.010006	6	8750

Unless otherwise stated the results shown in this test report refer only to the sample(s) tested and such sample(s) are retained for 90 days only.

除非另有說明，此報告結果僅對測試之樣品負責，同時此樣品僅保留90天。本報告未經本公司書面許可，不可部份複製。

This document is issued by the Company subject to its General Conditions of Service printed overleaf, available on request or accessible at <http://www.sgs.com.tw/Terms-and-Conditions> and for electronic format documents, subject to Terms and Conditions for Electronic Documents at <http://www.sgs.com.tw/Terms-and-Conditions>. Attention is drawn to the limitation of liability, indemnification and jurisdiction issues defined therein. Any holder of this document is advised that information contained hereon reflects the Company's findings at the time of its intervention only and within the limits of Client's instructions, if any. The Company's sole responsibility is to its Client and this document does not exonerate parties to a transaction from exercising all their rights and obligations under the transaction documents. This document cannot be reproduced except in full, without prior written approval of the Company. Any unauthorized alteration, forgery or falsification of the content or appearance of this document is unlawful and offenders may be prosecuted to the fullest extent of the law.

5G NR BAND n77 Part27				
Reference Freq.:		Modulation.:		CP-OFDM QPSK
SCS.:	30 kHz	Bandwidth:		100MHz
CH	656000	Frequency(MHz):		3840.00
Freq. ERROR vs. VOLTAGE				
Power SupplyVdc	Temp. (°C)	Freq. (MHz)	Delta (Hz)	Limit = +/- 2.5 ppm (Hz)
138	25	3840.000009	9	9600
120	25	3840.000008	8	9600
102	25	3839.999985	-15	9600
62 (End Point)	25	3839.999989	-11	9600
Freq. ERROR vs. Temp.				
Power SupplyVdc	Temp. (°C)	Freq. (MHz)	Delta (Hz)	Limit = +/- 2.5 ppm (Hz)
120	-30	3840.000006	6	9600
120	-20	3839.999990	-10	9600
120	-10	3840.000009	9	9600
120	0	3840.000005	5	9600
120	10	3839.999987	-13	9600
120	20	3839.999991	-9	9600
120	30	3840.000004	4	9600
120	40	3839.999989	-11	9600
120	50	3839.999992	-8	9600

Unless otherwise stated the results shown in this test report refer only to the sample(s) tested and such sample(s) are retained for 90 days only.

除非另有說明，此報告結果僅對測試之樣品負責，同時此樣品僅保留90天。本報告未經本公司書面許可，不可部份複製。

This document is issued by the Company subject to its General Conditions of Service printed overleaf, available on request or accessible at <http://www.sgs.com.tw/Terms-and-Conditions> and for electronic format documents, subject to Terms and Conditions for Electronic Documents at <http://www.sgs.com.tw/Terms-and-Conditions>. Attention is drawn to the limitation of liability, indemnification and jurisdiction issues defined therein. Any holder of this document is advised that information contained hereon reflects the Company's findings at the time of its intervention only and within the limits of Client's instructions, if any. The Company's sole responsibility is to its Client and this document does not exonerate parties to a transaction from exercising all their rights and obligations under the transaction documents. This document cannot be reproduced except in full, without prior written approval of the Company. Any unauthorized alteration, forgery or falsification of the content or appearance of this document is unlawful and offenders may be prosecuted to the fullest extent of the law.

12 PEAK TO AVERAGE RATIO

12.1 Standard Applicable

The peak-to-average ratio (PAR) of the transmission may not exceed 13dB.

12.2 Test SET-UP

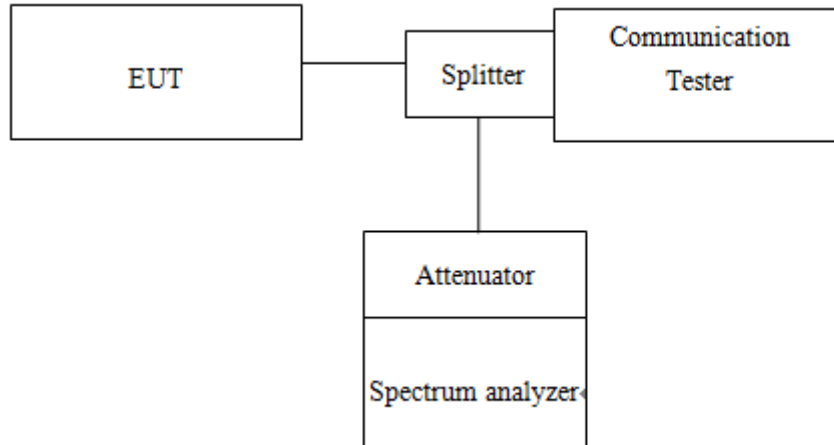

12.3 Measurement Procedure

1. KDB 971168 D01 is employed as the following procedure is proper adjusted accordingly:
2. Set resolution/measurement bandwidth \geq signal's occupied bandwidth; & internal =1ms
3. Set the number of counts to a value that stabilizes the measured CCDF curve.

Unless otherwise stated the results shown in this test report refer only to the sample(s) tested and such sample(s) are retained for 90 days only.

除非另有說明，此報告結果僅對測試之樣品負責，同時此樣品僅保留90天。本報告未經本公司書面許可，不可部份複製。

This document is issued by the Company subject to its General Conditions of Service printed overleaf, available on request or accessible at <http://www.sgs.com.tw/Terms-and-Conditions> and for electronic format documents, subject to Terms and Conditions for Electronic Documents at <http://www.sgs.com.tw/Terms-and-Conditions>. Attention is drawn to the limitation of liability, indemnification and jurisdiction issues defined therein. Any holder of this document is advised that information contained hereon reflects the Company's findings at the time of its intervention only and within the limits of Client's instructions, if any. The Company's sole responsibility is to its Client and this document does not exonerate parties to a transaction from exercising all their rights and obligations under the transaction documents. This document cannot be reproduced except in full, without prior written approval of the Company. Any unauthorized alteration, forgery or falsification of the content or appearance of this document is unlawful and offenders may be prosecuted to the fullest extent of the law.

12.4 Measurement Result

5G NR BAND n2							
DFT-S-OFDM_SCS 15 kHz							
Channel bandwidth: 5MHz				Channel bandwidth: 10MHz			
Freq. (MHz)	CH	PAPR (dB)		Freq. (MHz)	CH	PAPR (dB)	
		256QAM	Limit			256QAM	Limit
1852.50	370500	7.10	13	1855.00	371000	9.28	13
1880.00	376000	6.87	13	1880.00	376000	9.67	13
1907.50	381500	6.98	13	1905.00	381000	8.89	13
5G NR BAND n2							
DFT-S-OFDM_SCS 15 kHz							
Channel bandwidth: 15MHz				Channel bandwidth: 20MHz			
Freq. (MHz)	CH	PAPR (dB)		Freq. (MHz)	CH	PAPR (dB)	
		256QAM	Limit			256QAM	Limit
1857.50	371500	9.03	13	1860.00	372000	9.09	13
1880.00	376000	9.67	13	1880.00	376000	10.11	13
1902.50	380500	9.14	13	1900.00	380000	9.06	13
5G NR BAND n5							
DFT-S-OFDM_SCS 15 kHz							
Channel bandwidth: 5MHz				Channel bandwidth: 10MHz			
Freq. (MHz)	CH	PAPR (dB)		Freq. (MHz)	CH	PAPR (dB)	
		256QAM	Limit			256QAM	Limit
826.50	165300	7.48	13	829.00	165800	10.17	13
836.50	167300	7.44	13	836.50	167300	9.87	13
846.50	169300	7.58	13	844.00	168800	9.76	13
5G NR BAND n5							
DFT-S-OFDM_SCS 15 kHz							
Channel bandwidth: 15MHz				Channel bandwidth: 20MHz			
Freq. (MHz)	CH	PAPR (dB)		Freq. (MHz)	CH	PAPR (dB)	
		256QAM	Limit			256QAM	Limit
831.50	166300	9.67	13	834.00	166800	10.46	13
836.50	167300	9.13	13	836.50	167300	9.86	13
841.50	168300	10.27	13	839.00	167800	9.58	13
5G NR BAND n66							
DFT-S-OFDM_SCS 15 kHz							
Channel bandwidth: 5MHz				Channel bandwidth: 10MHz			
Freq. (MHz)	CH	PAPR (dB)		Freq. (MHz)	CH	PAPR (dB)	
		256QAM	Limit			256QAM	Limit
1712.50	342500	7.78	13	1715.00	343000	9.18	13
1745.00	349000	7.89	13	1745.00	349000	9.87	13
1777.50	355500	7.79	13	1775.00	355000	9.48	13
5G NR BAND n66							
DFT-S-OFDM_SCS 15 kHz							
Channel bandwidth: 15MHz				Channel bandwidth: 20MHz			
Freq. (MHz)	CH	PAPR (dB)		Freq. (MHz)	CH	PAPR (dB)	
		256QAM	Limit			256QAM	Limit
1717.50	343500	9.08	13	1720.00	344000	9.00	13
1745.00	349000	8.74	13	1745.00	349000	10.16	13
1772.50	354500	9.31	13	1770.00	354000	9.48	13

Unless otherwise stated the results shown in this test report refer only to the sample(s) tested and such sample(s) are retained for 90 days only.

除非另有說明，此報告結果僅對測試之樣品負責，同時此樣品僅保留90天。本報告未經本公司書面許可，不可部份複製。

This document is issued by the Company subject to its General Conditions of Service printed overleaf, available on request or accessible at <http://www.sgs.com.tw/Terms-and-Conditions> and for electronic format documents, subject to Terms and Conditions for Electronic Documents at <http://www.sgs.com.tw/Terms-and-Conditions>. Attention is drawn to the limitation of liability, indemnification and jurisdiction issues defined therein. Any holder of this document is advised that information contained hereon reflects the Company's findings at the time of its intervention only and within the limits of Client's instructions, if any. The Company's sole responsibility is to its Client and this document does not exonerate parties to a transaction from exercising all their rights and obligations under the transaction documents. This document cannot be reproduced except in full, without prior written approval of the Company. Any unauthorized alteration, forgery or falsification of the content or appearance of this document is unlawful and offenders may be prosecuted to the fullest extent of the law.

5G NR BAND n66							
DFT-S-OFDM_SCS 15 kHz							
Channel bandwidth: 30MHz							
Freq. (MHz)	CH	PAPR (dB)					
		256QAM	Limit				
1725.00	345000	11.19	13				
1745.00	349000	11.17	13				
1765.00	353000	11.17	13				
5G NR BAND n66							
DFT-S-OFDM_SCS 15 kHz							
Channel bandwidth: 40MHz							
Freq. (MHz)	CH	PAPR (dB)					
		256QAM	Limit				
1730.00	346000	10.88	13				
1745.00	349000	11.15	13				
1760.00	352000	11.11	13				
5G NR BAND n77 Part27(3700 to 3980 MHz)							
DFT-S-OFDM_SCS 30 kHz							
Channel bandwidth: 20MHz							
Freq. (MHz)	CH	PAPR (dB)					
		256QAM	Limit				
3710.01	647334	9.27	13				
3840.00	656000	11.43	13				
3969.99	664666	9.44	13				
5G NR BAND n77 Part27(3700 to 3980 MHz)							
DFT-S-OFDM_SCS 30 kHz							
Channel bandwidth: 30MHz				Channel bandwidth: 40MHz			
Freq. (MHz)	CH	PAPR (dB)		Freq. (MHz)	CH	PAPR (dB)	
		256QAM	Limit			256QAM	Limit
3715.02	647668	10.58	13	3720.00	648000	10.13	13
3840.00	656000	9.85	13	3840.00	656000	10.08	13
3964.98	664332	10.67	13	3960.00	664000	10.18	13
5G NR BAND n77 Part27(3700 to 3980 MHz)							
DFT-S-OFDM_SCS 30 kHz							
Channel bandwidth: 80MHz							
Freq. (MHz)	CH	PAPR (dB)					
		256QAM	Limit				
3740.01	649334	11.50	13				
3840.00	656000	11.46	13				
3939.99	662666	11.40	13				
5G NR BAND n77 Part27(3700 to 3980 MHz)							
DFT-S-OFDM_SCS 30 kHz							
Channel bandwidth: 100MHz							
Freq. (MHz)	CH	PAPR (dB)					
		256QAM	Limit				
3750.00	650000	11.21	13				
3840.00	656000	11.53	13				
3930.00	662000	10.71	13				

Unless otherwise stated the results shown in this test report refer only to the sample(s) tested and such sample(s) are retained for 90 days only.

除非另有說明，此報告結果僅對測試之樣品負責，同時此樣品僅保留90天。本報告未經本公司書面許可，不可部份複製。

This document is issued by the Company subject to its General Conditions of Service printed overleaf, available on request or accessible at <http://www.sgs.com.tw/Terms-and-Conditions> and for electronic format documents, subject to Terms and Conditions for Electronic Documents at <http://www.sgs.com.tw/Terms-and-Conditions>. Attention is drawn to the limitation of liability, indemnification and jurisdiction issues defined therein. Any holder of this document is advised that information contained hereon reflects the Company's findings at the time of its intervention only and within the limits of Client's instructions, if any. The Company's sole responsibility is to its Client and this document does not exonerate parties to a transaction from exercising all their rights and obligations under the transaction documents. This document cannot be reproduced except in full, without prior written approval of the Company. Any unauthorized alteration, forgery or falsification of the content or appearance of this document is unlawful and offenders may be prosecuted to the fullest extent of the law.

5G NR BAND n77 Part27(3450 to 3550 MHz)			
DFT-S-OFDM_SCS 30 kHz			
Channel bandwidth: 20MHz			
Freq. (MHz)	CH	PAPR (dB)	
		256QAM	Limit
3460.02	630668	12.83	13
3500.01	633334	10.09	13
3540.00	636000	9.62	13

5G NR BAND n77 Part27(3450 to 3550 MHz)			
DFT-S-OFDM_SCS 30 kHz			
Channel bandwidth: 30MHz			
Freq. (MHz)	CH	PAPR (dB)	
		256QAM	Limit
3465.00	631000	11.40	13
3500.01	633334	10.09	13
3534.99	635666	10.49	13

5G NR BAND n77 Part27(3450 to 3550 MHz)			
DFT-S-OFDM_SCS 30 kHz			
Channel bandwidth: 80MHz			
Freq. (MHz)	CH	PAPR (dB)	
		256QAM	Limit
3490.02	632668	12.29	13
3500.01	633334	11.49	13
3510.00	634000	10.83	13

5G NR BAND n77 Part27(3450 to 3550 MHz)			
DFT-S-OFDM_SCS 30 kHz			
Channel bandwidth: 100MHz			
Freq. (MHz)	CH	PAPR (dB)	
		256QAM	Limit
3500.01	633334	11.60	13

Unless otherwise stated the results shown in this test report refer only to the sample(s) tested and such sample(s) are retained for 90 days only.

除非另有說明，此報告結果僅對測試之樣品負責，同時此樣品僅保留90天。本報告未經本公司書面許可，不可部份複製。

This document is issued by the Company subject to its General Conditions of Service printed overleaf, available on request or accessible at <http://www.sgs.com.tw/Terms-and-Conditions> and for electronic format documents, subject to Terms and Conditions for Electronic Documents at <http://www.sgs.com.tw/Terms-and-Conditions>. Attention is drawn to the limitation of liability, indemnification and jurisdiction issues defined therein. Any holder of this document is advised that information contained hereon reflects the Company's findings at the time of its intervention only and within the limits of Client's instructions, if any. The Company's sole responsibility is to its Client and this document does not exonerate parties to a transaction from exercising all their rights and obligations under the transaction documents. This document cannot be reproduced except in full, without prior written approval of the Company. Any unauthorized alteration, forgery or falsification of the content or appearance of this document is unlawful and offenders may be prosecuted to the fullest extent of the law.

MIMO

5G NR BAND n77 Part27(3450 to 3550 MHz)							
CP_OFDM_SCS 30 kHz							
Channel bandwidth: 20MHz							
Freq. (MHz)	CH	PAPR (dB)					
		256QAM	Limit				
3460.02	630668	12.42	13				
3500.01	633334	12.39	13				
3540.00	636000	12.95	13				
5G NR BAND n77 Part27(3450 to 3550 MHz)							
CP_OFDM_SCS 30 kHz							
Channel bandwidth: 30MHz				Channel bandwidth: 40MHz			
Freq. (MHz)	CH	PAPR (dB)		Freq. (MHz)	CH	PAPR (dB)	
		256QAM	Limit			256QAM	Limit
3465.00	631000	12.67	13	3470.01	631334	12.78	13
3500.01	633334	12.40	13	3500.01	633334	12.78	13
3534.99	635666	11.98	13	3529.98	635332	12.37	13
5G NR BAND n77 Part27(3450 to 3550 MHz)							
CP_OFDM_SCS 30 kHz							
				Channel bandwidth: 60MHz			
Freq. (MHz)	CH	PAPR (dB)					
		256QAM	Limit				
3480.00	632000	12.46	13				
3500.01	633334	12.02	13				
3519.99	634666	11.71	13				
5G NR BAND n77 Part27(3450 to 3550 MHz)							
CP_OFDM_SCS 30 kHz							
				Channel bandwidth: 80MHz			
Freq. (MHz)	CH	PAPR (dB)					
		256QAM	Limit				
3490.02	632668	12.41	13				
3500.01	633334	12.93	13				
3510.00	634000	12.60	13				

Unless otherwise stated the results shown in this test report refer only to the sample(s) tested and such sample(s) are retained for 90 days only.

除非另有說明，此報告結果僅對測試之樣品負責，同時此樣品僅保留90天。本報告未經本公司書面許可，不可部份複製。

This document is issued by the Company subject to its General Conditions of Service printed overleaf, available on request or accessible at <http://www.sgs.com.tw/Terms-and-Conditions> and for electronic format documents, subject to Terms and Conditions for Electronic Documents at <http://www.sgs.com.tw/Terms-and-Conditions>. Attention is drawn to the limitation of liability, indemnification and jurisdiction issues defined therein. Any holder of this document is advised that information contained hereon reflects the Company's findings at the time of its intervention only and within the limits of Client's instructions, if any. The Company's sole responsibility is to its Client and this document does not exonerate parties to a transaction from exercising all their rights and obligations under the transaction documents. This document cannot be reproduced except in full, without prior written approval of the Company. Any unauthorized alteration, forgery or falsification of the content or appearance of this document is unlawful and offenders may be prosecuted to the fullest extent of the law.

5G NR BAND n77 Part27(3450 to 3550 MHz)			
CP_OFDM_SCS 30 kHz			
Channel bandwidth: 100MHz			
Freq. (MHz)	CH	PAPR (dB)	
		256QAM	Limit
3500.01	633334	12.12	13

5G NR BAND n77 Part27(3700 to 3980 MHz)			
CP_OFDM_SCS 30 kHz			
Channel bandwidth: 20MHz			
Freq. (MHz)	CH	PAPR (dB)	
		256QAM	Limit
3710.01	647334	12.33	13
3840.00	656000	11.43	13
3969.99	664666	12.93	13

5G NR BAND n77 Part27(3700 to 3980 MHz)							
CP_OFDM_SCS 30 kHz							
Channel bandwidth: 30MHz				Channel bandwidth: 40MHz			
Freq. (MHz)	CH	PAPR (dB)		Freq. (MHz)	CH	PAPR (dB)	
		256QAM	Limit			256QAM	Limit
3715.02	647668	12.52	13	3720.00	648000	11.84	13
3840.00	656000	12.76	13	3840.00	656000	11.53	13
3964.98	664332	11.92	13	3960.00	664000	12.25	13

5G NR BAND n77 Part27(3700 to 3980 MHz)			
CP_OFDM_SCS 30 kHz			
Channel bandwidth: 60MHz			
Freq. (MHz)	CH	PAPR (dB)	
		256QAM	Limit
3730.02	648668	12.12	13
3840.00	656000	11.76	13
3949.98	663332	11.92	13

Unless otherwise stated the results shown in this test report refer only to the sample(s) tested and such sample(s) are retained for 90 days only.

除非另有說明，此報告結果僅對測試之樣品負責，同時此樣品僅保留90天。本報告未經本公司書面許可，不可部份複製。

This document is issued by the Company subject to its General Conditions of Service printed overleaf, available on request or accessible at <http://www.sgs.com.tw/Terms-and-Conditions> and for electronic format documents, subject to Terms and Conditions for Electronic Documents at <http://www.sgs.com.tw/Terms-and-Conditions>. Attention is drawn to the limitation of liability, indemnification and jurisdiction issues defined therein. Any holder of this document is advised that information contained hereon reflects the Company's findings at the time of its intervention only and within the limits of Client's instructions, if any. The Company's sole responsibility is to its Client and this document does not exonerate parties to a transaction from exercising all their rights and obligations under the transaction documents. This document cannot be reproduced except in full, without prior written approval of the Company. Any unauthorized alteration, forgery or falsification of the content or appearance of this document is unlawful and offenders may be prosecuted to the fullest extent of the law.

5G NR BAND n77 Part27(3700 to 3980 MHz)			
CP_OFDM_SCS 30 kHz			
Channel bandwidth: 80MHz			
Freq. (MHz)	CH	PAPR (dB)	
		256QAM	Limit
3740.01	649334	12.88	13
3840.00	656000	12.26	13
3939.99	662666	12.92	13

5G NR BAND n77 Part27(3700 to 3980 MHz)			
CP_OFDM_SCS 30 kHz			
Channel bandwidth: 100MHz			
Freq. (MHz)	CH	PAPR (dB)	
		256QAM	Limit
3750.00	650000	11.94	13
3840.00	656000	12.33	13
3930.00	662000	11.38	13

Unless otherwise stated the results shown in this test report refer only to the sample(s) tested and such sample(s) are retained for 90 days only.

除非另有說明，此報告結果僅對測試之樣品負責，同時此樣品僅保留90天。本報告未經本公司書面許可，不可部份複製。

This document is issued by the Company subject to its General Conditions of Service printed overleaf, available on request or accessible at <http://www.sgs.com.tw/Terms-and-Conditions> and for electronic format documents, subject to Terms and Conditions for Electronic Documents at <http://www.sgs.com.tw/Terms-and-Conditions>. Attention is drawn to the limitation of liability, indemnification and jurisdiction issues defined therein. Any holder of this document is advised that information contained hereon reflects the Company's findings at the time of its intervention only and within the limits of Client's instructions, if any. The Company's sole responsibility is to its Client and this document does not exonerate parties to a transaction from exercising all their rights and obligations under the transaction documents. This document cannot be reproduced except in full, without prior written approval of the Company. Any unauthorized alteration, forgery or falsification of the content or appearance of this document is unlawful and offenders may be prosecuted to the fullest extent of the law.

Band2_5MHz_DFT_s_OFDM_SCS15kHz_256QAM_RB25_0_CH370500

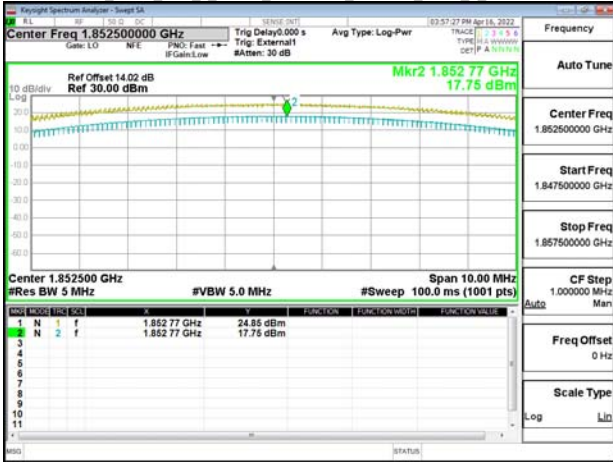

Band2_10MHz_DFT_s_OFDM_SCS15kHz_256QAM_RB50_0_CH371000

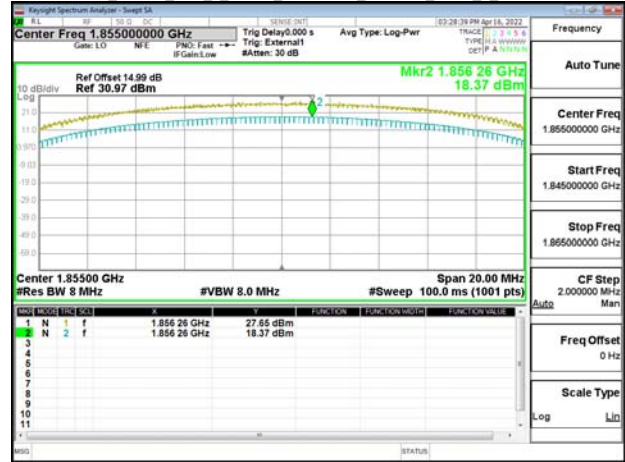

Band2_5MHz_DFT_s_OFDM_SCS15kHz_256QAM_RB25_0_CH376000

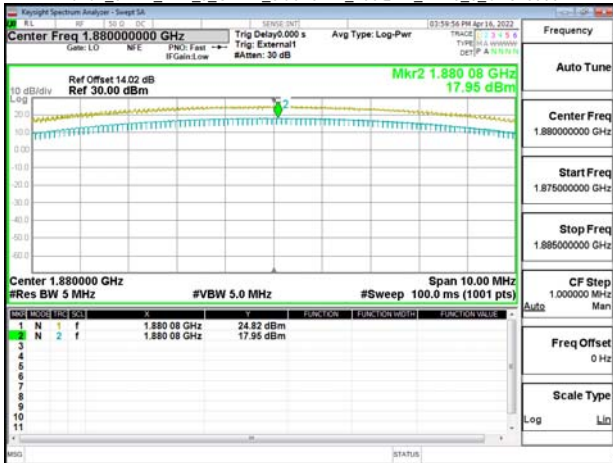

Band2_10MHz_DFT_s_OFDM_SCS15kHz_256QAM_RB50_0_CH376000

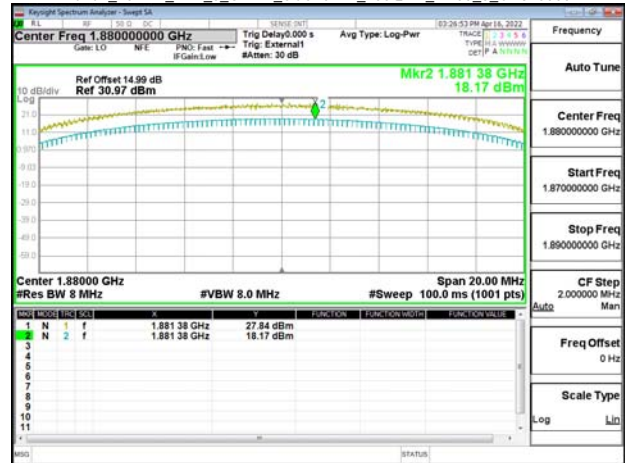

Band2_5MHz_DFT_s_OFDM_SCS15kHz_256QAM_RB25_0_CH381500

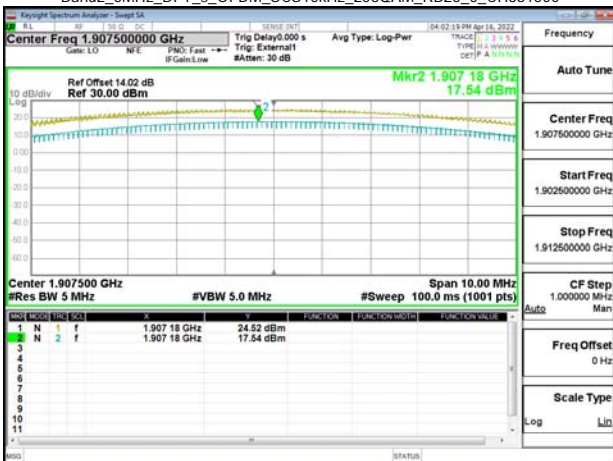

Band2_10MHz_DFT_s_OFDM_SCS15kHz_256QAM_RB50_0_CH381000

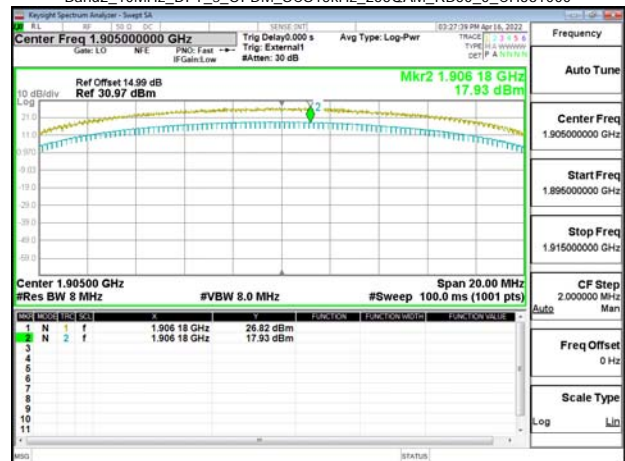

Unless otherwise stated the results shown in this test report refer only to the sample(s) tested and such sample(s) are retained for 90 days only.

除非另有說明，此報告結果僅對測試之樣品負責，同時此樣品僅保留90天。本報告未經本公司書面許可，不可部份複製。

This document is issued by the Company subject to its General Conditions of Service printed overleaf, available on request or accessible at <http://www.sgs.com.tw/Terms-and-Conditions> and for electronic format documents, subject to Terms and Conditions for Electronic Documents at <http://www.sgs.com.tw/Terms-and-Conditions>. Attention is drawn to the limitation of liability, indemnification and jurisdiction issues defined therein. Any holder of this document is advised that information contained hereon reflects the Company's findings at the time of its intervention only and within the limits of Client's instructions, if any. The Company's sole responsibility is to its Client and this document does not exonerate parties to a transaction from exercising all their rights and obligations under the transaction documents. This document cannot be reproduced except in full, without prior written approval of the Company. Any unauthorized alteration, forgery or falsification of the content or appearance of this document is unlawful and offenders may be prosecuted to the fullest extent of the law.

Band2_15MHz_DFT_s_OFDM_SCS15kHz_256QAM_RB75_0_CH371500



Band2_20MHz_DFT_s_OFDM_SCS15kHz_256QAM_RB100_0_CH372000



Band2_15MHz_DFT_s_OFDM_SCS15kHz_256QAM_RB75_0_CH376000

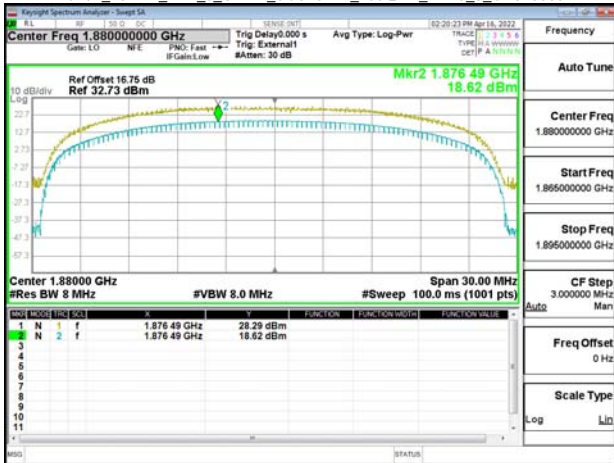

Band2_20MHz_DFT_s_OFDM_SCS15kHz_256QAM_RB100_0_CH376000

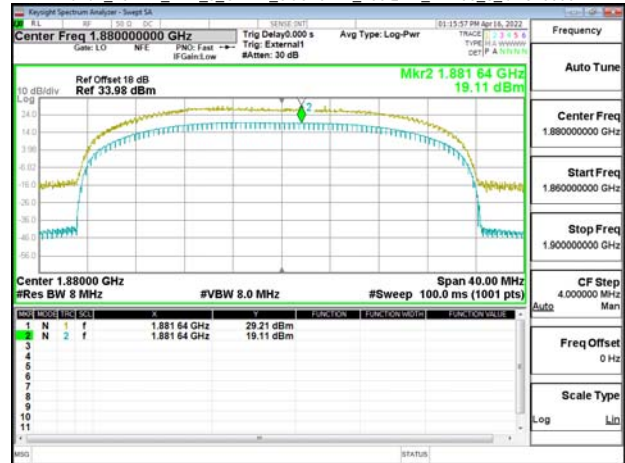

Band2_15MHz_DFT_s_OFDM_SCS15kHz_256QAM_RB75_0_CH380500

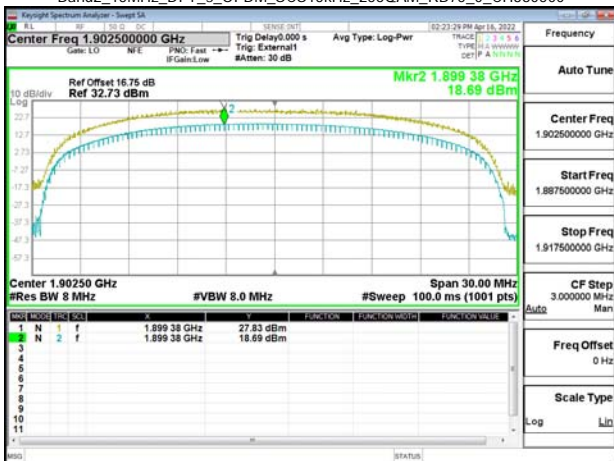

Band2_20MHz_DFT_s_OFDM_SCS15kHz_256QAM_RB100_0_CH380000

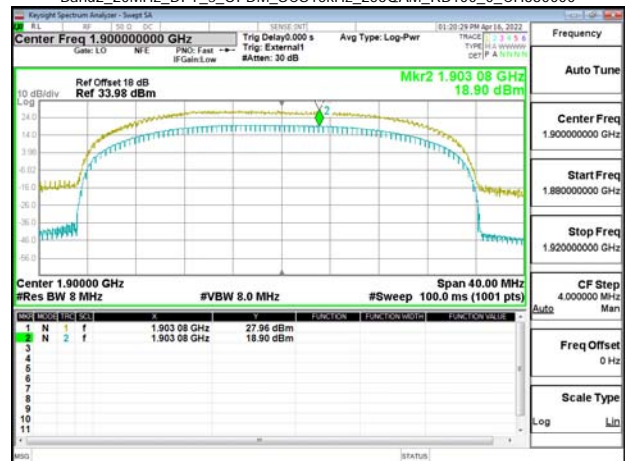

Unless otherwise stated the results shown in this test report refer only to the sample(s) tested and such sample(s) are retained for 90 days only.

除非另有說明，此報告結果僅對測試之樣品負責，同時此樣品僅保留90天。本報告未經本公司書面許可，不可部份複製。

This document is issued by the Company subject to its General Conditions of Service printed overleaf, available on request or accessible at <http://www.sgs.com.tw/Terms-and-Conditions> and for electronic format documents, subject to Terms and Conditions for Electronic Documents at <http://www.sgs.com.tw/Terms-and-Conditions>. Attention is drawn to the limitation of liability, indemnification and jurisdiction issues defined therein. Any holder of this document is advised that information contained hereon reflects the Company's findings at the time of its intervention only and within the limits of Client's instructions, if any. The Company's sole responsibility is to its Client and this document does not exonerate parties to a transaction from exercising all their rights and obligations under the transaction documents. This document cannot be reproduced except in full, without prior written approval of the Company. Any unauthorized alteration, forgery or falsification of the content or appearance of this document is unlawful and offenders may be prosecuted to the fullest extent of the law.

Band66_5MHz_DFT_s_OFDM_SCS15kHz_256QAM_RB25_0_CH342500

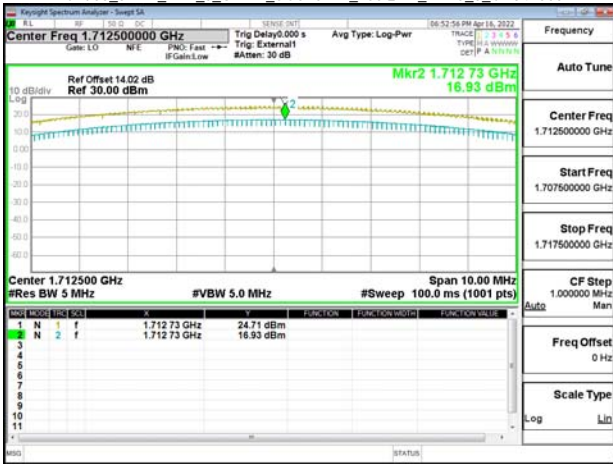

Band66_10MHz_DFT_s_OFDM_SCS15kHz_256QAM_RB50_0_CH343000



Band66_5MHz_DFT_s_OFDM_SCS15kHz_256QAM_RB25_0_CH349000



Band66_10MHz_DFT_s_OFDM_SCS15kHz_256QAM_RB50_0_CH349000

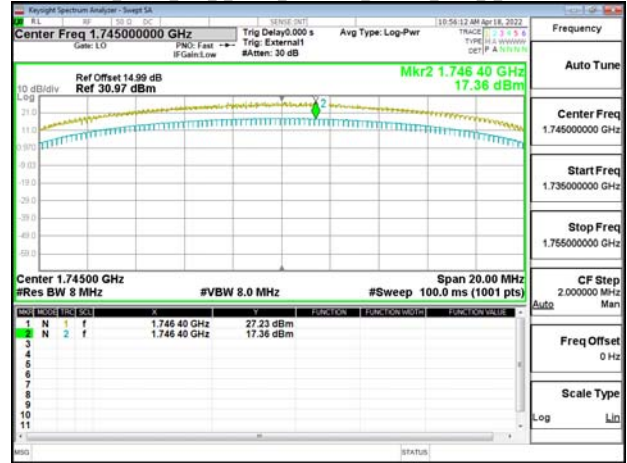

Band66_5MHz_DFT_s_OFDM_SCS15kHz_256QAM_RB25_0_CH355500

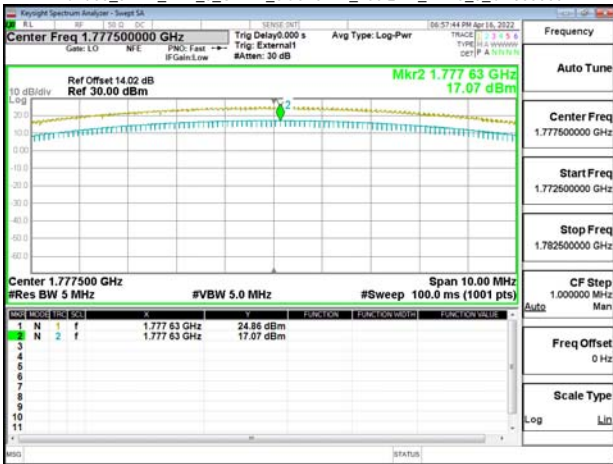

Band66_10MHz_DFT_s_OFDM_SCS15kHz_256QAM_RB50_0_CH355500

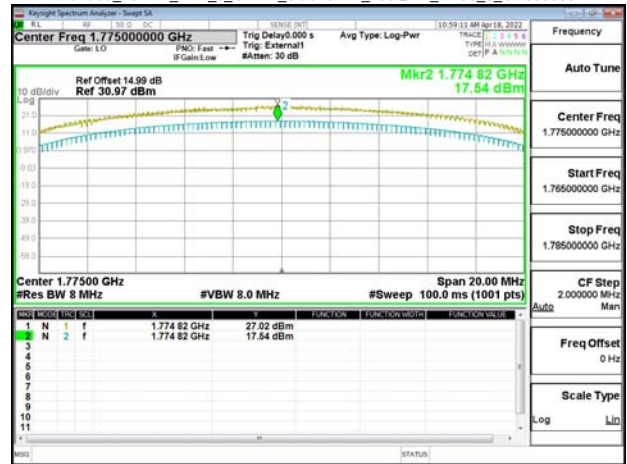

Unless otherwise stated the results shown in this test report refer only to the sample(s) tested and such sample(s) are retained for 90 days only.

除非另有說明，此報告結果僅對測試之樣品負責，同時此樣品僅保留90天。本報告未經本公司書面許可，不可部份複製。

This document is issued by the Company subject to its General Conditions of Service printed overleaf, available on request or accessible at <http://www.sgs.com.tw/Terms-and-Conditions> and for electronic format documents, subject to Terms and Conditions for Electronic Documents at <http://www.sgs.com.tw/Terms-and-Conditions>. Attention is drawn to the limitation of liability, indemnification and jurisdiction issues defined therein. Any holder of this document is advised that information contained hereon reflects the Company's findings at the time of its intervention only and within the limits of Client's instructions, if any. The Company's sole responsibility is to its Client and this document does not exonerate parties to a transaction from exercising all their rights and obligations under the transaction documents. This document cannot be reproduced except in full, without prior written approval of the Company. Any unauthorized alteration, forgery or falsification of the content or appearance of this document is unlawful and offenders may be prosecuted to the fullest extent of the law.

Band66_15MHz_DFT_s_OFDM_SCS15kHz_256QAM_RB75_0_CH343500

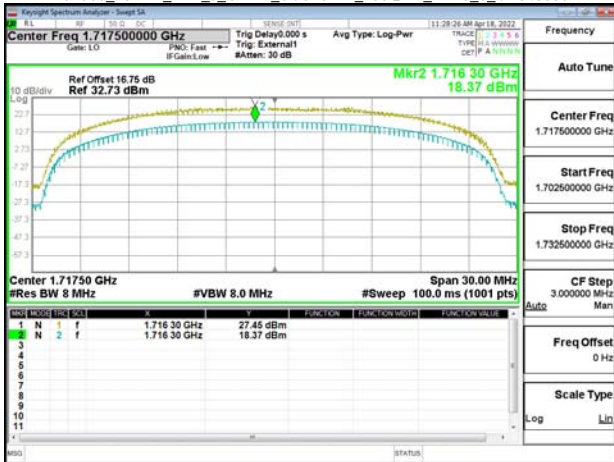

Band66_20MHz_DFT_s_OFDM_SCS15kHz_256QAM_RB100_0_CH344000

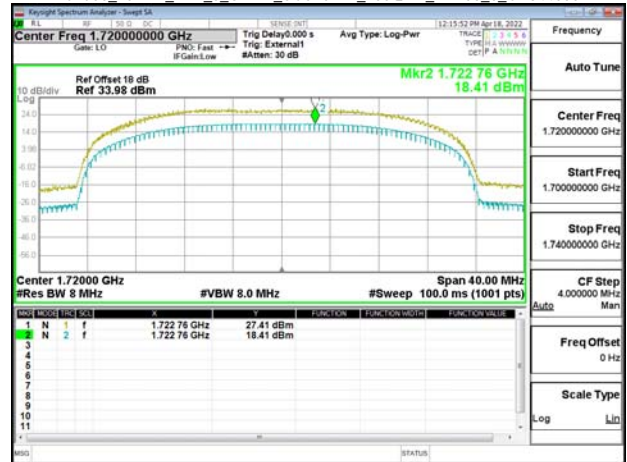

Band66_15MHz_DFT_s_OFDM_SCS15kHz_256QAM_RB75_0_CH349000

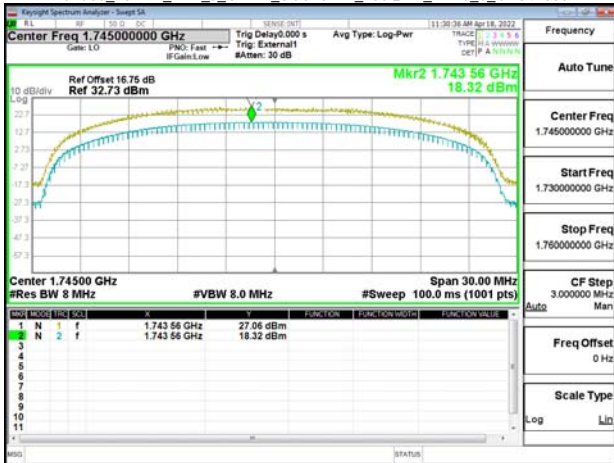

Band66_20MHz_DFT_s_OFDM_SCS15kHz_256QAM_RB100_0_CH349000



Band66_15MHz_DFT_s_OFDM_SCS15kHz_256QAM_RB75_0_CH354500

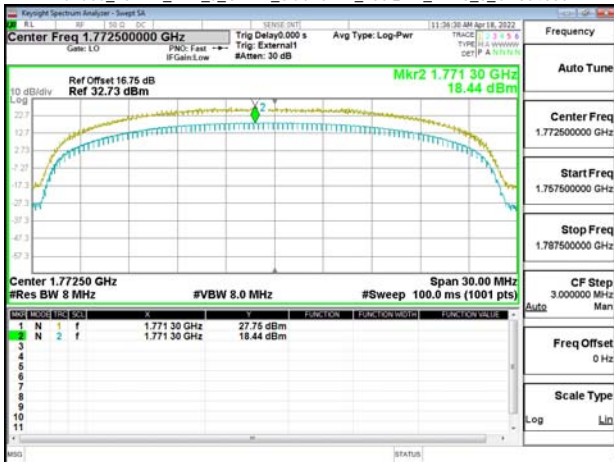

Band66_20MHz_DFT_s_OFDM_SCS15kHz_256QAM_RB100_0_CH354000

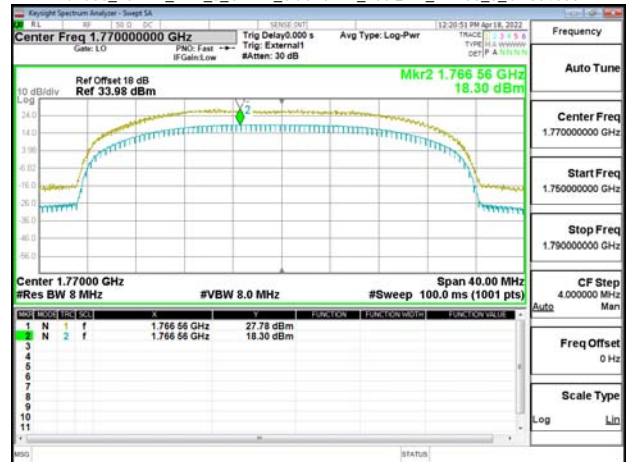

Unless otherwise stated the results shown in this test report refer only to the sample(s) tested and such sample(s) are retained for 90 days only.

除非另有說明，此報告結果僅對測試之樣品負責，同時此樣品僅保留90天。本報告未經本公司書面許可，不可部份複製。

This document is issued by the Company subject to its General Conditions of Service printed overleaf, available on request or accessible at <http://www.sgs.com.tw/Terms-and-Conditions> and for electronic format documents, subject to Terms and Conditions for Electronic Documents at <http://www.sgs.com.tw/Terms-and-Conditions>. Attention is drawn to the limitation of liability, indemnification and jurisdiction issues defined therein. Any holder of this document is advised that information contained hereon reflects the Company's findings at the time of its intervention only and within the limits of Client's instructions, if any. The Company's sole responsibility is to its Client and this document does not exonerate parties to a transaction from exercising all their rights and obligations under the transaction documents. This document cannot be reproduced except in full, without prior written approval of the Company. Any unauthorized alteration, forgery or falsification of the content or appearance of this document is unlawful and offenders may be prosecuted to the fullest extent of the law.

Band66_30MHz_DFT_s_OFDM_SCS15kHz_256QAM_RB160_0_CH345000

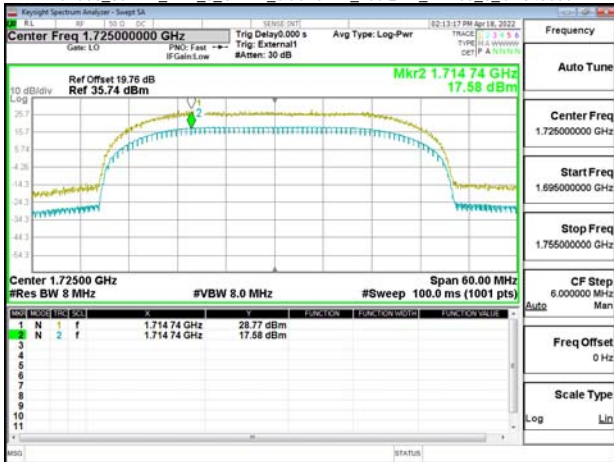

Band66_40MHz_DFT_s_OFDM_SCS15kHz_256QAM_RB216_0_CH346000

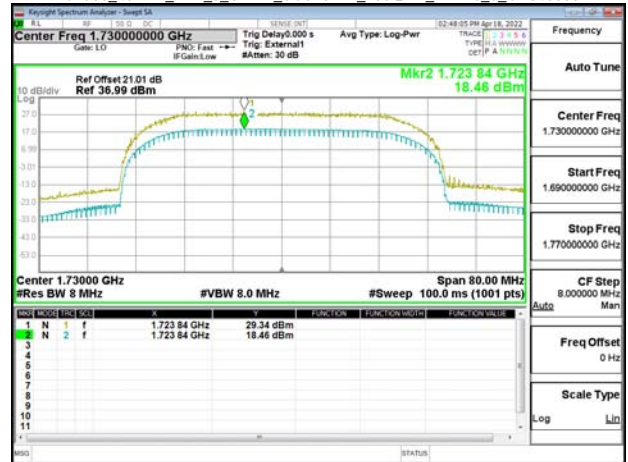

Band66_30MHz_DFT_s_OFDM_SCS15kHz_256QAM_RB160_0_CH349000

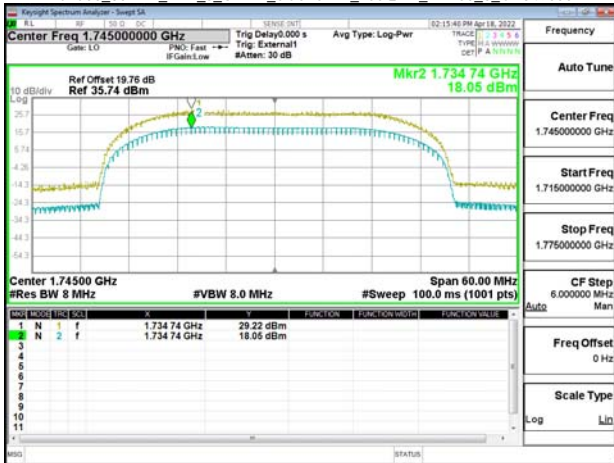

Band66_40MHz_DFT_s_OFDM_SCS15kHz_256QAM_RB216_0_CH349000

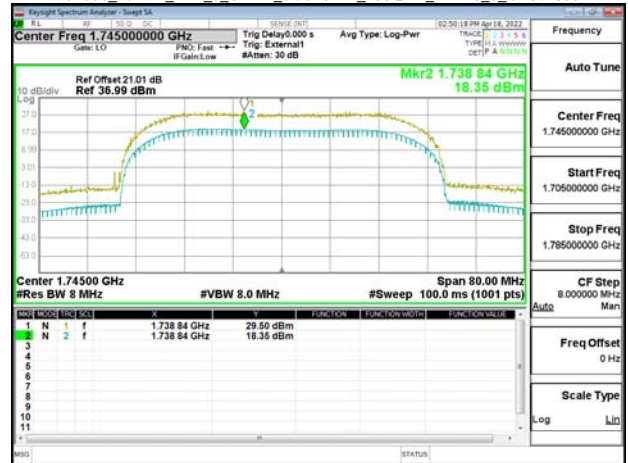

Band66_30MHz_DFT_s_OFDM_SCS15kHz_256QAM_RB160_0_CH353000

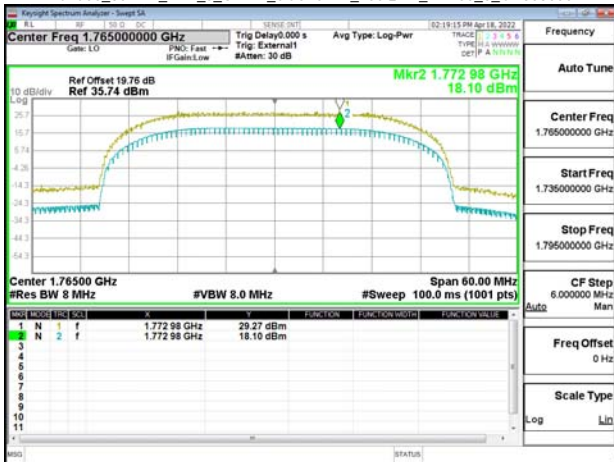

Band66_40MHz_DFT_s_OFDM_SCS15kHz_256QAM_RB216_0_CH352000

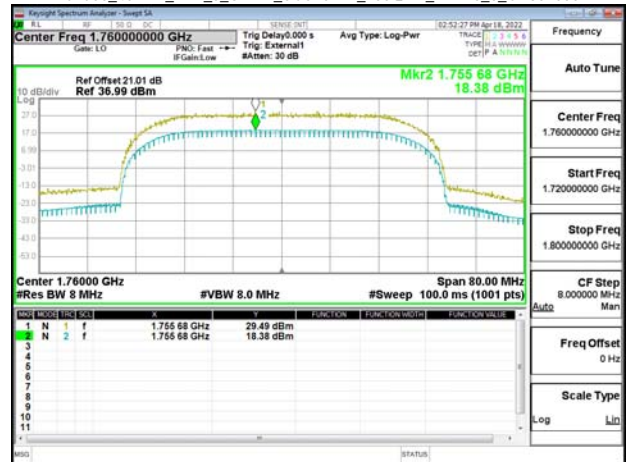

Unless otherwise stated the results shown in this test report refer only to the sample(s) tested and such sample(s) are retained for 90 days only.

除另有說明，此報告結果僅對測試之樣品負責，同時此樣品僅保留90天。本報告未經本公司書面許可，不可部份複製。

This document is issued by the Company subject to its General Conditions of Service printed overleaf, available on request or accessible at <http://www.sgs.com.tw/Terms-and-Conditions> and for electronic format documents, subject to Terms and Conditions for Electronic Documents at <http://www.sgs.com.tw/Terms-and-Conditions>. Attention is drawn to the limitation of liability, indemnification and jurisdiction issues defined therein. Any holder of this document is advised that information contained hereon reflects the Company's findings at the time of its intervention only and within the limits of Client's instructions, if any. The Company's sole responsibility is to its Client and this document does not exonerate parties to a transaction from exercising all their rights and obligations under the transaction documents. This document cannot be reproduced except in full, without prior written approval of the Company. Any unauthorized alteration, forgery or falsification of the content or appearance of this document is unlawful and offenders may be prosecuted to the fullest extent of the law.

Band77-Part27_20MHz_DFT_s_OFDM_SCS30kHz_256QAM_RB50_0_CH630668

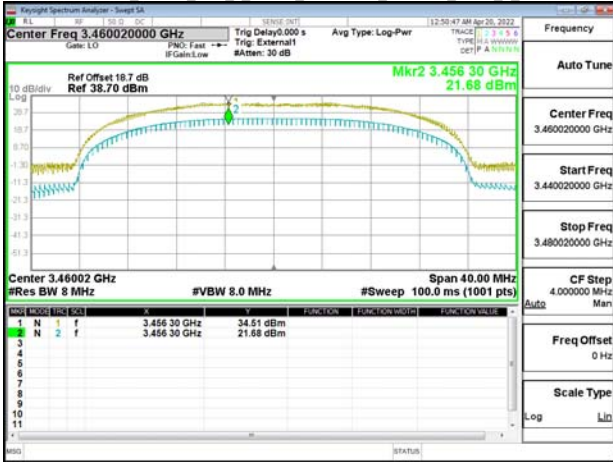

Band77-Part27_30MHz_DFT_s_OFDM_SCS30kHz_256QAM_RB75_0_CH631000

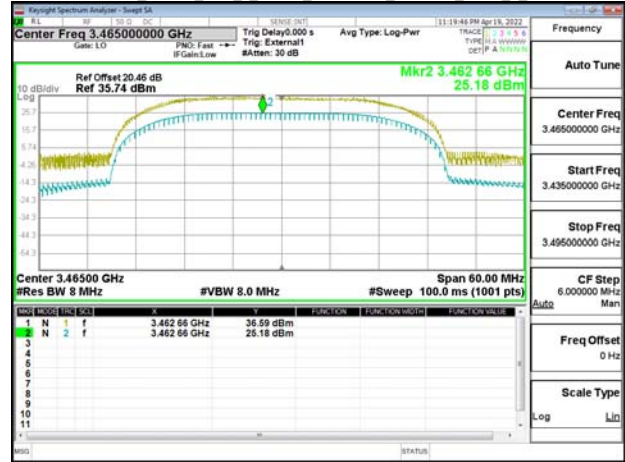

Band77-Part27_20MHz_DFT_s_OFDM_SCS30kHz_256QAM_RB50_0_CH633334



Band77-Part27_30MHz_DFT_s_OFDM_SCS30kHz_256QAM_RB75_0_CH633334



Band77-Part27_20MHz_DFT_s_OFDM_SCS30kHz_256QAM_RB50_0_CH636000

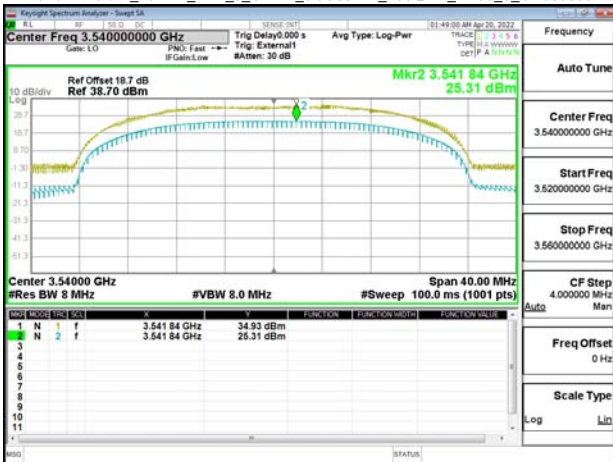

Band77-Part27_30MHz_DFT_s_OFDM_SCS30kHz_256QAM_RB75_0_CH635666

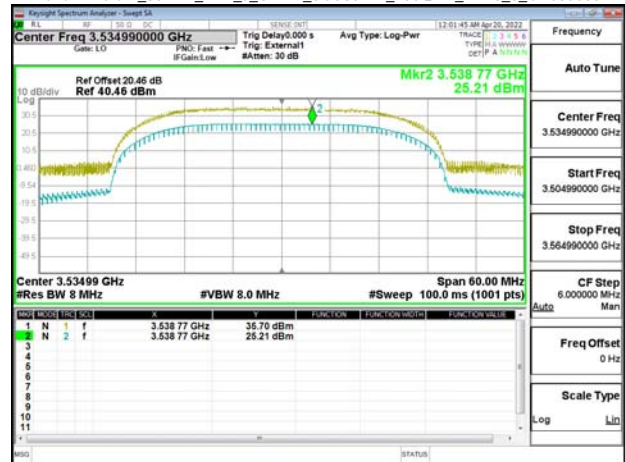

Unless otherwise stated the results shown in this test report refer only to the sample(s) tested and such sample(s) are retained for 90 days only.

除非另有說明，此報告結果僅對測試之樣品負責，同時此樣品僅保留90天。本報告未經本公司書面許可，不可部份複製。

This document is issued by the Company subject to its General Conditions of Service printed overleaf, available on request or accessible at <http://www.sgs.com.tw/Terms-and-Conditions> and for electronic format documents, subject to Terms and Conditions for Electronic Documents at <http://www.sgs.com.tw/Terms-and-Conditions>. Attention is drawn to the limitation of liability, indemnification and jurisdiction issues defined therein. Any holder of this document is advised that information contained hereon reflects the Company's findings at the time of its intervention only and within the limits of Client's instructions, if any. The Company's sole responsibility is to its Client and this document does not exonerate parties to a transaction from exercising all their rights and obligations under the transaction documents. This document cannot be reproduced except in full, without prior written approval of the Company. Any unauthorized alteration, forgery or falsification of the content or appearance of this document is unlawful and offenders may be prosecuted to the fullest extent of the law.

Band77-Part27_40MHz_DFT_s_OFDM_SCS30kHz_256QAM_RB100_0_CH631334

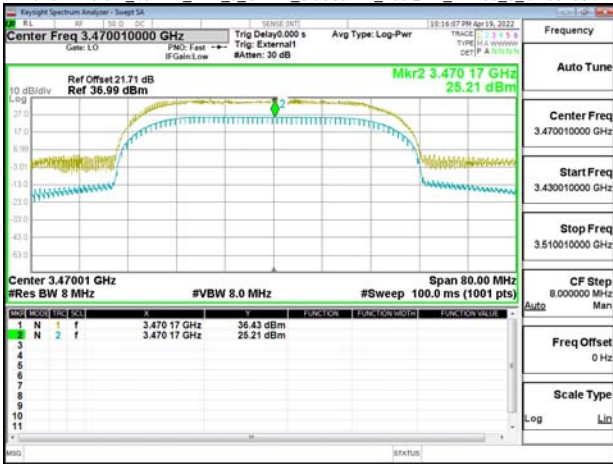

Band77-Part27_60MHz_DFT_s_OFDM_SCS30kHz_256QAM_RB162_0_CH632000

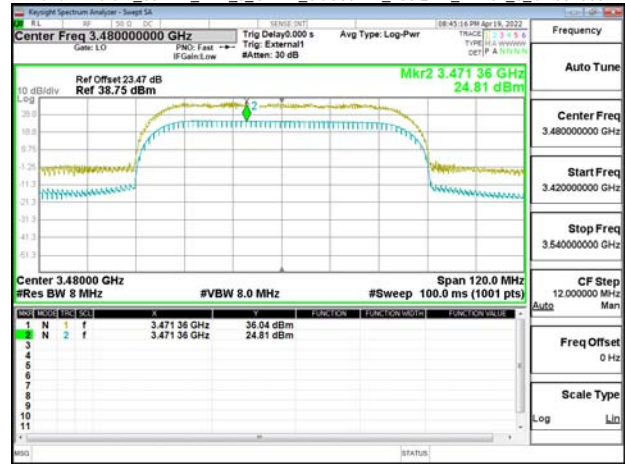

Band77-Part27_40MHz_DFT_s_OFDM_SCS30kHz_256QAM_RB100_0_CH633334

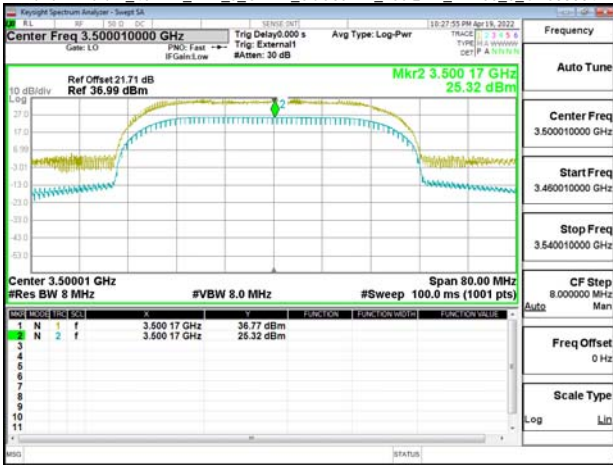

Band77-Part27_60MHz_DFT_s_OFDM_SCS30kHz_256QAM_RB162_0_CH633334



Band77-Part27_40MHz_DFT_s_OFDM_SCS30kHz_256QAM_RB100_0_CH635332

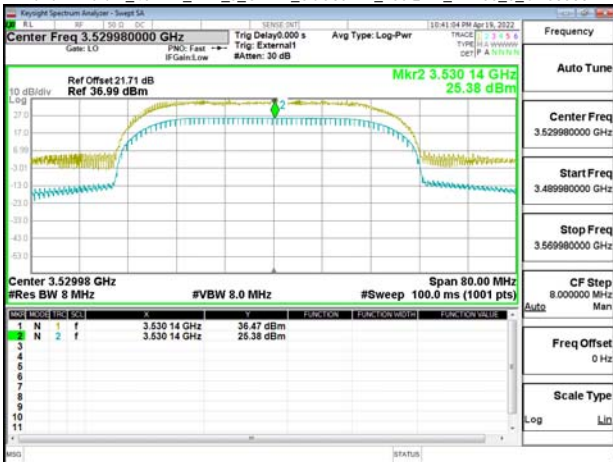

Band77-Part27_60MHz_DFT_s_OFDM_SCS30kHz_256QAM_RB162_0_CH634666

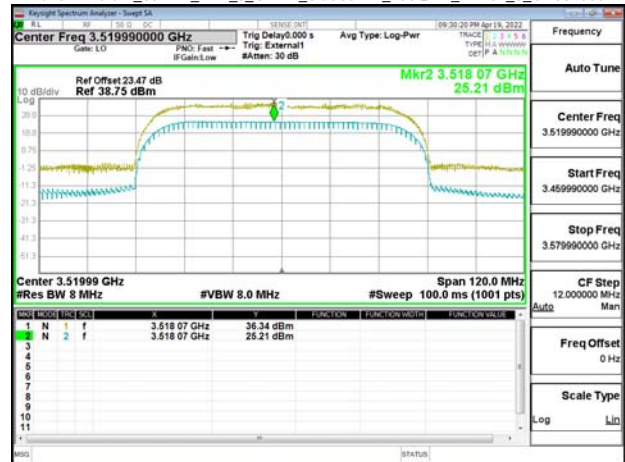

Unless otherwise stated the results shown in this test report refer only to the sample(s) tested and such sample(s) are retained for 90 days only.

除非另有說明，此報告結果僅對測試之樣品負責，同時此樣品僅保留90天。本報告未經本公司書面許可，不可部份複製。

This document is issued by the Company subject to its General Conditions of Service printed overleaf, available on request or accessible at <http://www.sgs.com.tw/Terms-and-Conditions> and for electronic format documents, subject to Terms and Conditions for Electronic Documents at <http://www.sgs.com.tw/Terms-and-Conditions>. Attention is drawn to the limitation of liability, indemnification and jurisdiction issues defined therein. Any holder of this document is advised that information contained hereon reflects the Company's findings at the time of its intervention only and within the limits of Client's instructions, if any. The Company's sole responsibility is to its Client and this document does not exonerate parties to a transaction from exercising all their rights and obligations under the transaction documents. This document cannot be reproduced except in full, without prior written approval of the Company. Any unauthorized alteration, forgery or falsification of the content or appearance of this document is unlawful and offenders may be prosecuted to the fullest extent of the law.

Band77-Part27_80MHz_DFT_s_OFDM_SCS30kHz_256QAM_RB216_0_CH632668



Band77-Part27_100MHz_DFT_s_OFDM_SCS30kHz_256QAM_RB270_0_CH633334



Band77-Part27_80MHz_DFT_s_OFDM_SCS30kHz_256QAM_RB216_0_CH633334



Band77-Part27_20MHz_DFT_s_OFDM_SCS30kHz_256QAM_RB50_0_CH647334



Band77-Part27_80MHz_DFT_s_OFDM_SCS30kHz_256QAM_RB216_0_CH634000



Band77-Part27_20MHz_DFT_s_OFDM_SCS30kHz_256QAM_RB50_0_CH656000



Unless otherwise stated the results shown in this test report refer only to the sample(s) tested and such sample(s) are retained for 90 days only.

除非另有說明，此報告結果僅對測試之樣品負責，同時此樣品僅保留90天。本報告未經本公司書面許可，不可部份複製。

This document is issued by the Company subject to its General Conditions of Service printed overleaf, available on request or accessible at <http://www.sgs.com.tw/Terms-and-Conditions> and for electronic format documents, subject to Terms and Conditions for Electronic Documents at <http://www.sgs.com.tw/Terms-and-Conditions>. Attention is drawn to the limitation of liability, indemnification and jurisdiction issues defined therein. Any holder of this document is advised that information contained hereon reflects the Company's findings at the time of its intervention only and within the limits of Client's instructions, if any. The Company's sole responsibility is to its Client and this document does not exonerate parties to a transaction from exercising all their rights and obligations under the transaction documents. This document cannot be reproduced except in full, without prior written approval of the Company. Any unauthorized alteration, forgery or falsification of the content or appearance of this document is unlawful and offenders may be prosecuted to the fullest extent of the law.

Band77-Part27_20MHz_DFT_s_OFDM_SCS30kHz_256QAM_RB50_0_CH64666



Band77-Part27_30MHz_DFT_s_OFDM_SCS30kHz_256QAM_RB75_0_CH644332



Band77-Part27_30MHz_DFT_s_OFDM_SCS30kHz_256QAM_RB75_0_CH647668

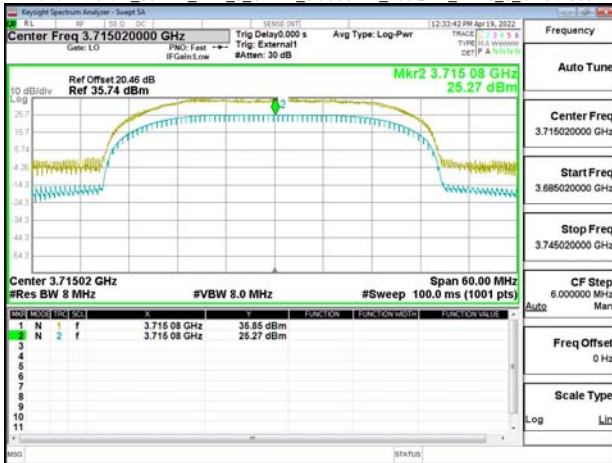

Band77-Part27_40MHz_DFT_s_OFDM_SCS30kHz_256QAM_RB100_0_CH648000

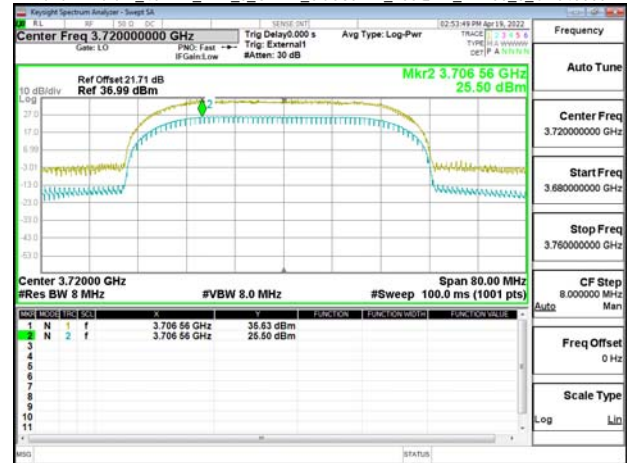

Band77-Part27_30MHz_DFT_s_OFDM_SCS30kHz_256QAM_RB75_0_CH656000

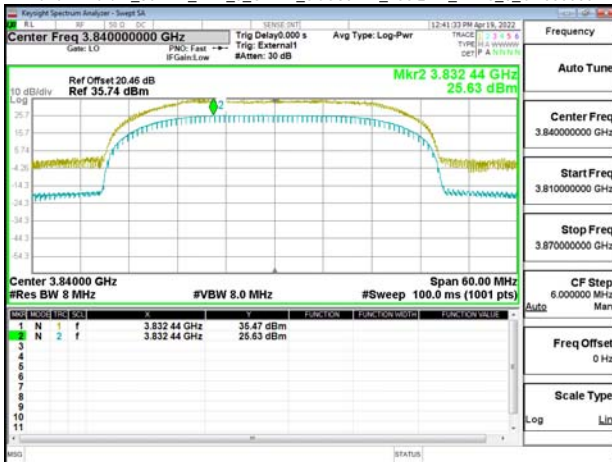

Band77-Part27_40MHz_DFT_s_OFDM_SCS30kHz_256QAM_RB100_0_CH656000

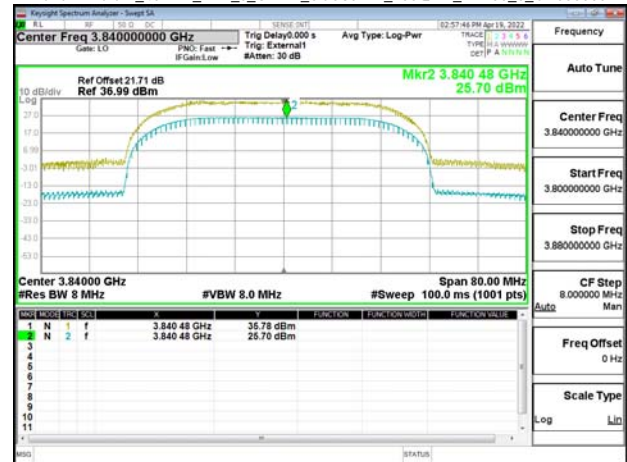

Unless otherwise stated the results shown in this test report refer only to the sample(s) tested and such sample(s) are retained for 90 days only.

除非另有說明，此報告結果僅對測試之樣品負責，同時此樣品僅保留90天。本報告未經本公司書面許可，不可部份複製。
This document is issued by the Company subject to its General Conditions of Service printed overleaf, available on request or accessible at <http://www.sgs.com.tw/Terms-and-Conditions> and for electronic format documents, subject to Terms and Conditions for Electronic Documents at <http://www.sgs.com.tw/Terms-and-Conditions>. Attention is drawn to the limitation of liability, indemnification and jurisdiction issues defined therein. Any holder of this document is advised that information contained hereon reflects the Company's findings at the time of its intervention only and within the limits of Client's instructions, if any. The Company's sole responsibility is to its Client and this document does not exonerate parties to a transaction from exercising all their rights and obligations under the transaction documents. This document cannot be reproduced except in full, without prior written approval of the Company. Any unauthorized alteration, forgery or falsification of the content or appearance of this document is unlawful and offenders may be prosecuted to the fullest extent of the law.

Band77-Part27_40MHz_DFT_s_OFDM_SCS30kHz_256QAM_RB100_0_CH664000



Band77-Part27_60MHz_DFT_s_OFDM_SCS30kHz_256QAM_RB162_0_CH663332



Band77-Part27_60MHz_DFT_s_OFDM_SCS30kHz_256QAM_RB162_0_CH648668



Band77-Part27_80MHz_DFT_s_OFDM_SCS30kHz_256QAM_RB216_0_CH649334



Band77-Part27_60MHz_DFT_s_OFDM_SCS30kHz_256QAM_RB162_0_CH656000



Band77-Part27_80MHz_DFT_s_OFDM_SCS30kHz_256QAM_RB216_0_CH656000



Unless otherwise stated the results shown in this test report refer only to the sample(s) tested and such sample(s) are retained for 90 days only.

除非另有說明，此報告結果僅對測試之樣品負責，同時此樣品僅保留90天。本報告未經本公司書面許可，不可部份複製。

This document is issued by the Company subject to its General Conditions of Service printed overleaf, available on request or accessible at <http://www.sgs.com.tw/Terms-and-Conditions> and for electronic format documents, subject to Terms and Conditions for Electronic Documents at <http://www.sgs.com.tw/Terms-and-Conditions>. Attention is drawn to the limitation of liability, indemnification and jurisdiction issues defined therein. Any holder of this document is advised that information contained hereon reflects the Company's findings at the time of its intervention only and within the limits of Client's instructions, if any. The Company's sole responsibility is to its Client and this document does not exonerate parties to a transaction from exercising all their rights and obligations under the transaction documents. This document cannot be reproduced except in full, without prior written approval of the Company. Any unauthorized alteration, forgery or falsification of the content or appearance of this document is unlawful and offenders may be prosecuted to the fullest extent of the law.

Band77-Part27_80MHz_DFT_s_OFDM_SCS30kHz_256QAM_RB216_0_CH662666



Band77-Part27_100MHz_DFT_s_OFDM_SCS30kHz_256QAM_RB270_0_CH656000



Band77-Part27_100MHz_DFT_s_OFDM_SCS30kHz_256QAM_RB270_0_CH650000

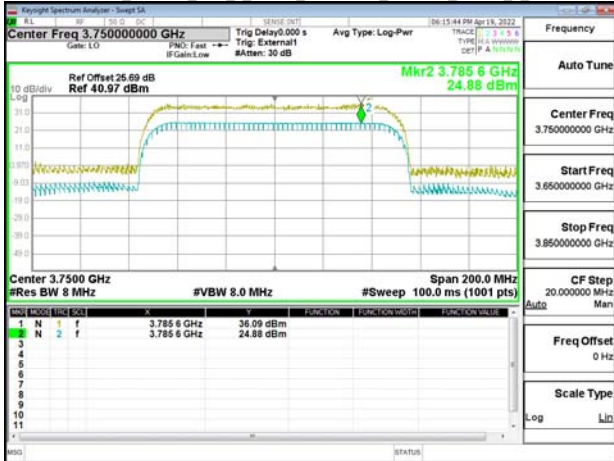

Band77-Part27_100MHz_DFT_s_OFDM_SCS30kHz_256QAM_RB270_0_CH662000

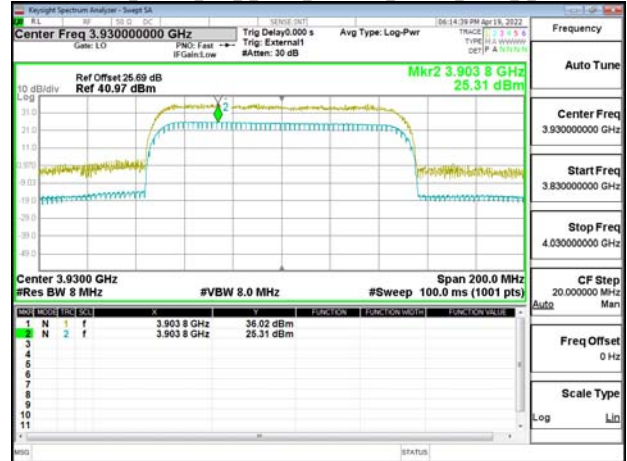

Unless otherwise stated the results shown in this test report refer only to the sample(s) tested and such sample(s) are retained for 90 days only.

除非另有說明，此報告結果僅對測試之樣品負責，同時此樣品僅保留90天。本報告未經本公司書面許可，不可部份複製。

This document is issued by the Company subject to its General Conditions of Service printed overleaf, available on request or accessible at <http://www.sgs.com.tw/Terms-and-Conditions> and for electronic format documents, subject to Terms and Conditions for Electronic Documents at <http://www.sgs.com.tw/Terms-and-Conditions>. Attention is drawn to the limitation of liability, indemnification and jurisdiction issues defined therein. Any holder of this document is advised that information contained hereon reflects the Company's findings at the time of its intervention only and within the limits of Client's instructions, if any. The Company's sole responsibility is to its Client and this document does not exonerate parties to a transaction from exercising all their rights and obligations under the transaction documents. This document cannot be reproduced except in full, without prior written approval of the Company. Any unauthorized alteration, forgery or falsification of the content or appearance of this document is unlawful and offenders may be prosecuted to the fullest extent of the law.

MIMO Band77-Part27_20MHz_CP_OFDM_SCS30kHz_256QAM_RB51_0_CH630668

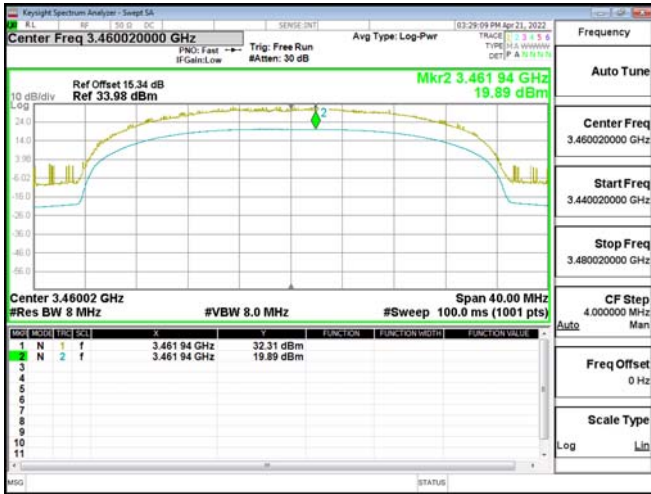

Band77-Part27_30MHz_CP_OFDM_SCS30kHz_256QAM_RB78_0_CH631000



Band77-Part27_20MHz_CP_OFDM_SCS30kHz_256QAM_RB51_0_CH633334

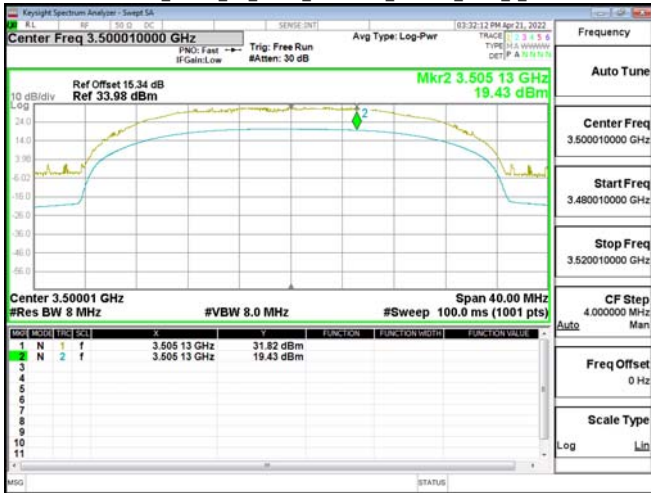

Band77-Part27_30MHz_CP_OFDM_SCS30kHz_256QAM_RB78_0_CH633334



Band77-Part27_20MHz_CP_OFDM_SCS30kHz_256QAM_RB51_0_CH636000

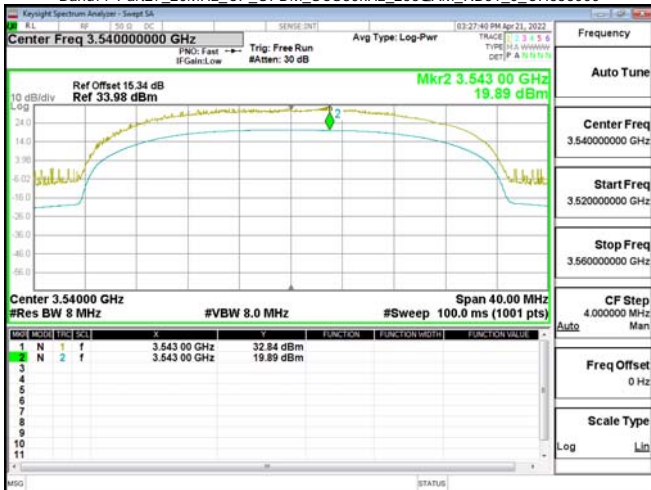

Band77-Part27_30MHz_CP_OFDM_SCS30kHz_256QAM_RB78_0_CH635666

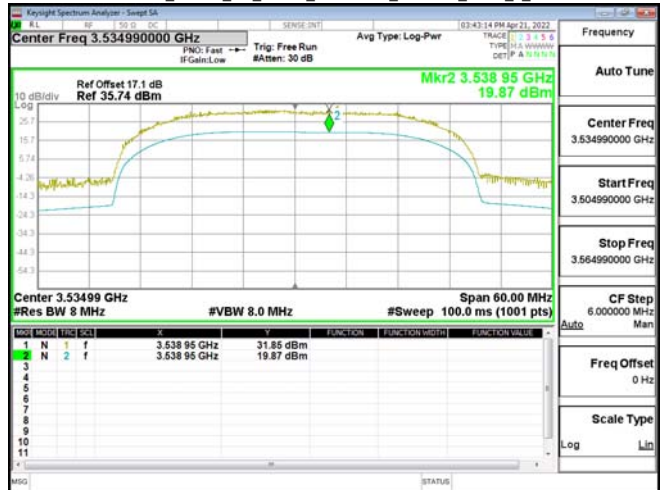

Unless otherwise stated the results shown in this test report refer only to the sample(s) tested and such sample(s) are retained for 90 days only.

除非另有說明，此報告結果僅對測試之樣品負責，同時此樣品僅保留90天。本報告未經本公司書面許可，不可部份複製。

This document is issued by the Company subject to its General Conditions of Service printed overleaf, available on request or accessible at <http://www.sgs.com.tw/Terms-and-Conditions> and for electronic format documents, subject to Terms and Conditions for Electronic Documents at <http://www.sgs.com.tw/Terms-and-Conditions>. Attention is drawn to the limitation of liability, indemnification and jurisdiction issues defined therein. Any holder of this document is advised that information contained hereon reflects the Company's findings at the time of its intervention only and within the limits of Client's instructions, if any. The Company's sole responsibility is to its Client and this document does not exonerate parties to a transaction from exercising all their rights and obligations under the transaction documents. This document cannot be reproduced except in full, without prior written approval of the Company. Any unauthorized alteration, forgery or falsification of the content or appearance of this document is unlawful and offenders may be prosecuted to the fullest extent of the law.

Band77-Part27_40MHz_CP_OFDM_SCS30kHz_256QAM_RB106_0_CH633334

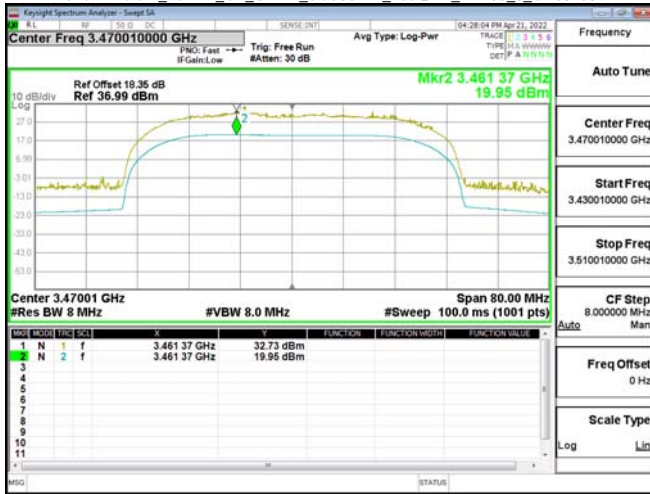

Band77-Part27_60MHz_CP_OFDM_SCS30kHz_256QAM_RB162_0_CH632000



Band77-Part27_40MHz_CP_OFDM_SCS30kHz_256QAM_RB106_0_CH633334



Band77-Part27_60MHz_CP_OFDM_SCS30kHz_256QAM_RB162_0_CH633334



Band77-Part27_40MHz_CP_OFDM_SCS30kHz_256QAM_RB106_0_CH635332

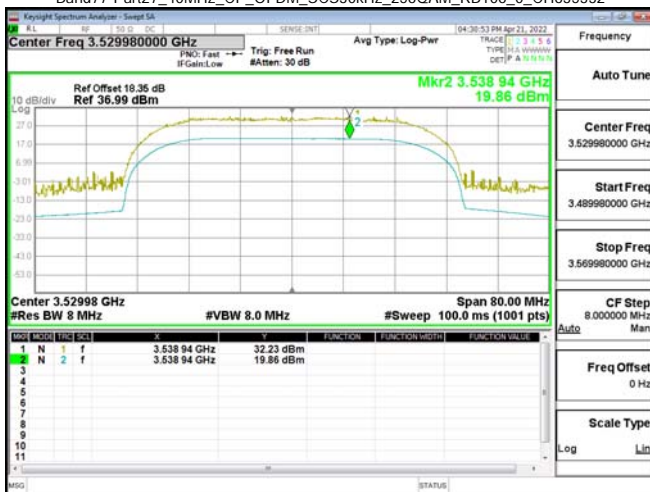

Band77-Part27_60MHz_CP_OFDM_SCS30kHz_256QAM_RB162_0_CH634666



Unless otherwise stated the results shown in this test report refer only to the sample(s) tested and such sample(s) are retained for 90 days only.

除非另有說明，此報告結果僅對測試之樣品負責，同時此樣品僅保留90天。本報告未經本公司書面許可，不可部份複製。

This document is issued by the Company subject to its General Conditions of Service printed overleaf, available on request or accessible at <http://www.sgs.com.tw/Terms-and-Conditions> and for electronic format documents, subject to Terms and Conditions for Electronic Documents at <http://www.sgs.com.tw/Terms-and-Conditions>. Attention is drawn to the limitation of liability, indemnification and jurisdiction issues defined therein. Any holder of this document is advised that information contained hereon reflects the Company's findings at the time of its intervention only and within the limits of Client's instructions, if any. The Company's sole responsibility is to its Client and this document does not exonerate parties to a transaction from exercising all their rights and obligations under the transaction documents. This document cannot be reproduced except in full, without prior written approval of the Company. Any unauthorized alteration, forgery or falsification of the content or appearance of this document is unlawful and offenders may be prosecuted to the fullest extent of the law.

Band77-Part27_80MHz_CP_OFDM_SCS30kHz_256QAM_RB217_0_CH632668

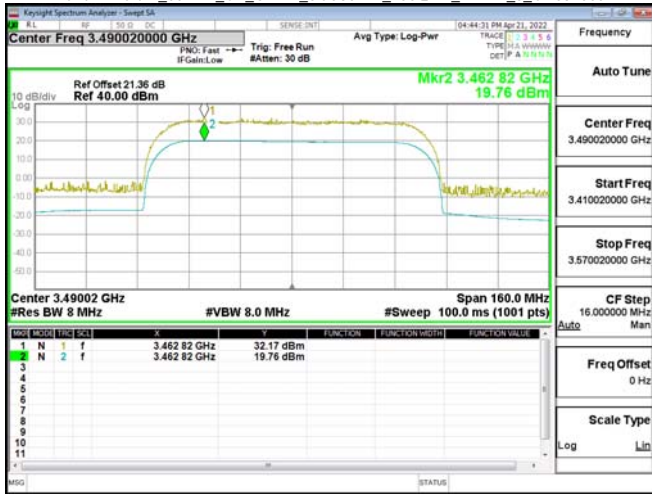

Band77-Part27_100MHz_CP_OFDM_SCS30kHz_256QAM_RB273_0_CH633334

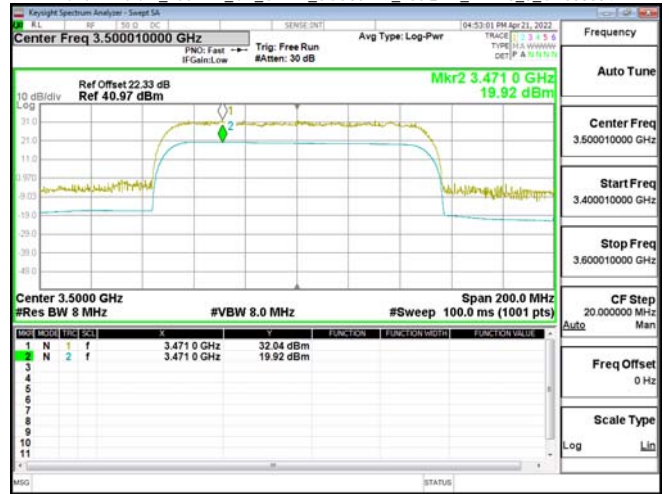

Band77-Part27_80MHz_CP_OFDM_SCS30kHz_256QAM_RB217_0_CH633334



Band77-Part27_20MHz_CP_OFDM_SCS30kHz_256QAM_RB51_0_CH647334



Band77-Part27_80MHz_CP_OFDM_SCS30kHz_256QAM_RB217_0_CH634000



Band77-Part27_20MHz_CP_OFDM_SCS30kHz_256QAM_RB51_0_CH656000

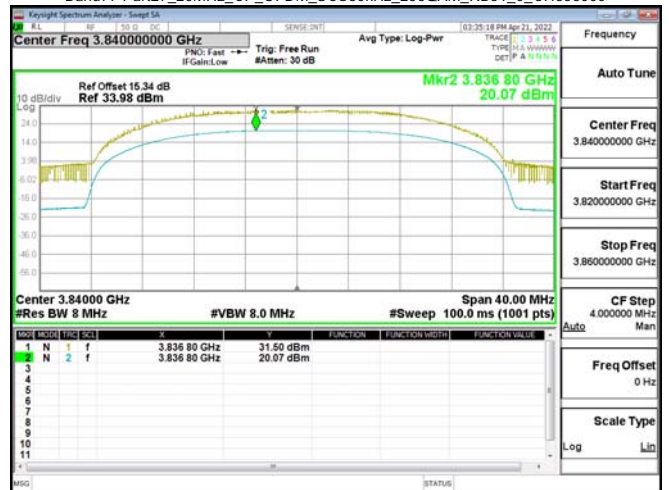

Unless otherwise stated the results shown in this test report refer only to the sample(s) tested and such sample(s) are retained for 90 days only.

除非另有說明，此報告結果僅對測試之樣品負責，同時此樣品僅保留90天。本報告未經本公司書面許可，不可部份複製。

This document is issued by the Company subject to its General Conditions of Service printed overleaf, available on request or accessible at <http://www.sgs.com.tw/Terms-and-Conditions> and for electronic format documents, subject to Terms and Conditions for Electronic Documents at <http://www.sgs.com.tw/Terms-and-Conditions>. Attention is drawn to the limitation of liability, indemnification and jurisdiction issues defined therein. Any holder of this document is advised that information contained hereon reflects the Company's findings at the time of its intervention only and within the limits of Client's instructions, if any. The Company's sole responsibility is to its Client and this document does not exonerate parties to a transaction from exercising all their rights and obligations under the transaction documents. This document cannot be reproduced except in full, without prior written approval of the Company. Any unauthorized alteration, forgery or falsification of the content or appearance of this document is unlawful and offenders may be prosecuted to the fullest extent of the law.

Band77-Part27_20MHz_CP_OFDM_SCS30kHz_256QAM_RB51_0_CH646666

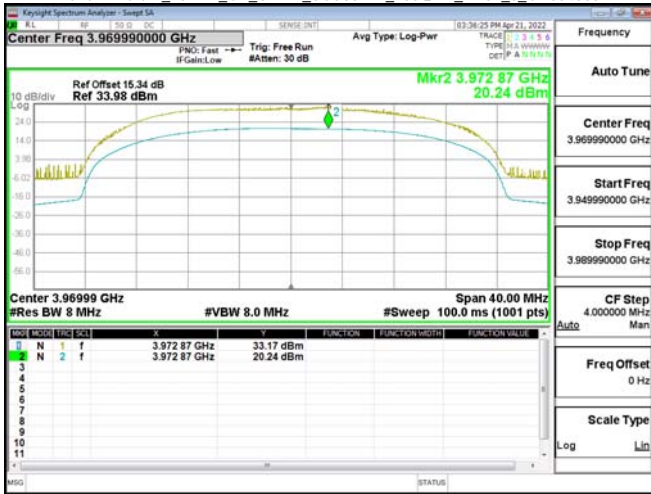

Band77-Part27_30MHz_CP_OFDM_SCS30kHz_256QAM_RB78_0_CH64332



Band77-Part27_30MHz_CP_OFDM_SCS30kHz_256QAM_RB78_0_CH647668

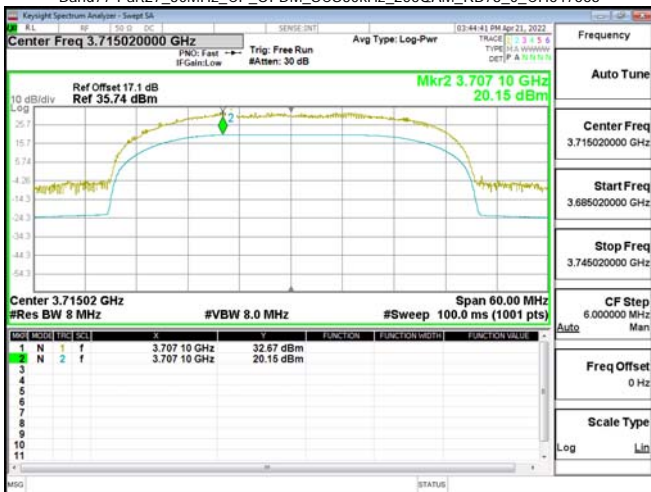

Band77-Part27_40MHz_CP_OFDM_SCS30kHz_256QAM_RB106_0_CH648000



Band77-Part27_30MHz_CP_OFDM_SCS30kHz_256QAM_RB78_0_CH656000

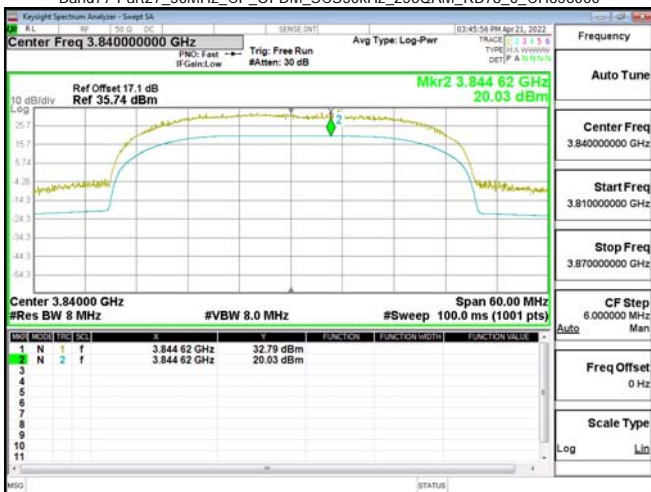

Band77-Part27_40MHz_CP_OFDM_SCS30kHz_256QAM_RB106_0_CH656000

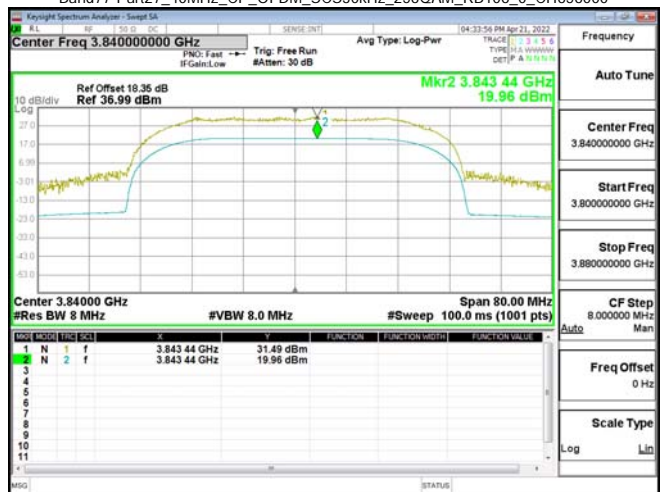

Unless otherwise stated the results shown in this test report refer only to the sample(s) tested and such sample(s) are retained for 90 days only.

除非另有說明，此報告結果僅對測試之樣品負責，同時此樣品僅保留90天。本報告未經本公司書面許可，不可部份複製。

This document is issued by the Company subject to its General Conditions of Service printed overleaf, available on request or accessible at <http://www.sgs.com.tw/Terms-and-Conditions> and for electronic format documents, subject to Terms and Conditions for Electronic Documents at <http://www.sgs.com.tw/Terms-and-Conditions>. Attention is drawn to the limitation of liability, indemnification and jurisdiction issues defined therein. Any holder of this document is advised that information contained hereon reflects the Company's findings at the time of its intervention only and within the limits of Client's instructions, if any. The Company's sole responsibility is to its Client and this document does not exonerate parties to a transaction from exercising all their rights and obligations under the transaction documents. This document cannot be reproduced except in full, without prior written approval of the Company. Any unauthorized alteration, forgery or falsification of the content or appearance of this document is unlawful and offenders may be prosecuted to the fullest extent of the law.

Band77-Part27_40MHz_CP_OFDM_SCS30kHz_256QAM_RB106_0_CH664000

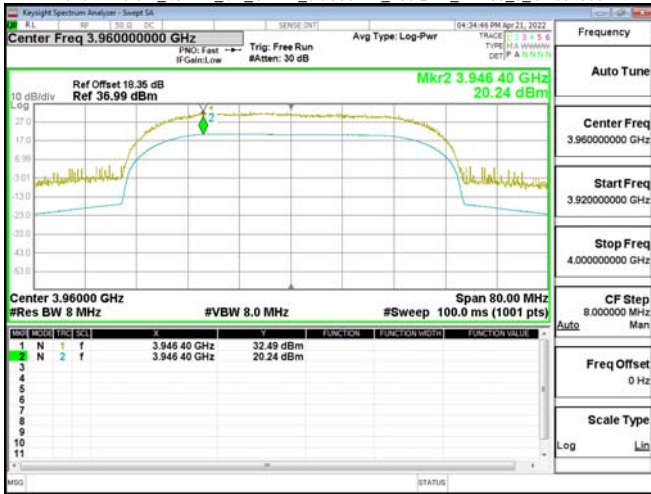

Band77-Part27_60MHz_CP_OFDM_SCS30kHz_256QAM_RB162_0_CH663332

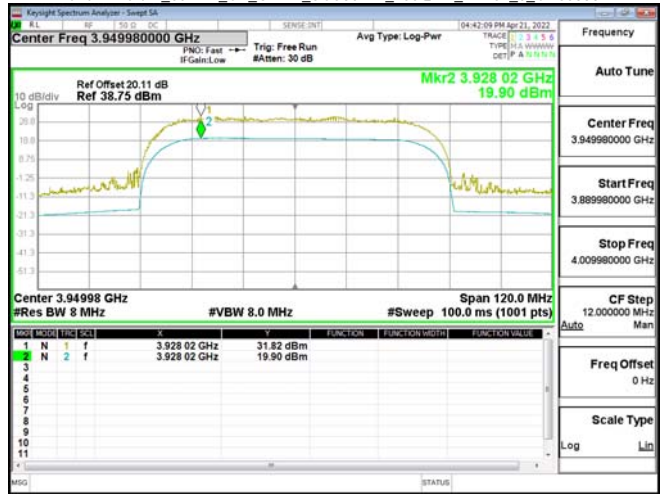

Band77-Part27_60MHz_CP_OFDM_SCS30kHz_256QAM_RB162_0_CH648668



Band77-Part27_80MHz_CP_OFDM_SCS30kHz_256QAM_RB217_0_CH649334



Band77-Part27_60MHz_CP_OFDM_SCS30kHz_256QAM_RB162_0_CH656000

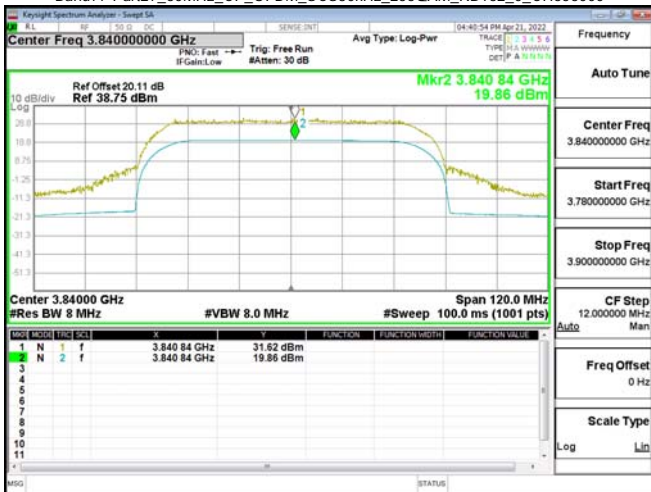

Band77-Part27_80MHz_CP_OFDM_SCS30kHz_256QAM_RB217_0_CH656000

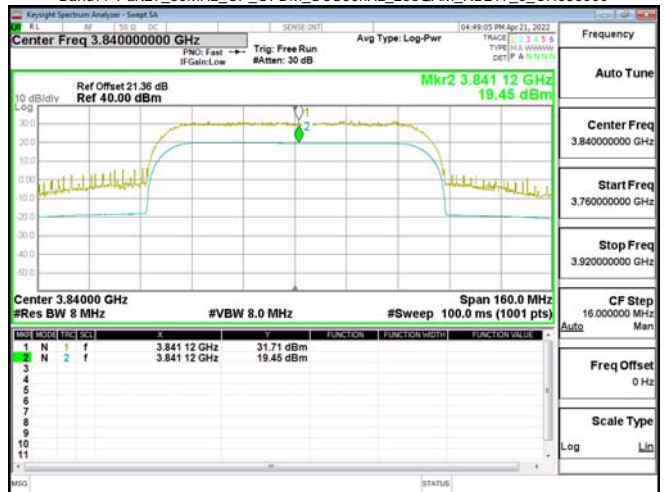

Unless otherwise stated the results shown in this test report refer only to the sample(s) tested and such sample(s) are retained for 90 days only.

除非另有說明，此報告結果僅對測試之樣品負責，同時此樣品僅保留90天。本報告未經本公司書面許可，不可部份複製。

This document is issued by the Company subject to its General Conditions of Service printed overleaf, available on request or accessible at <http://www.sgs.com.tw/Terms-and-Conditions> and for electronic format documents, subject to Terms and Conditions for Electronic Documents at <http://www.sgs.com.tw/Terms-and-Conditions>. Attention is drawn to the limitation of liability, indemnification and jurisdiction issues defined therein. Any holder of this document is advised that information contained hereon reflects the Company's findings at the time of its intervention only and within the limits of Client's instructions, if any. The Company's sole responsibility is to its Client and this document does not exonerate parties to a transaction from exercising all their rights and obligations under the transaction documents. This document cannot be reproduced except in full, without prior written approval of the Company. Any unauthorized alteration, forgery or falsification of the content or appearance of this document is unlawful and offenders may be prosecuted to the fullest extent of the law.

Band77-Part27_80MHz_CP_OFDM_SCS30kHz_256QAM_RB217_0_CH662666

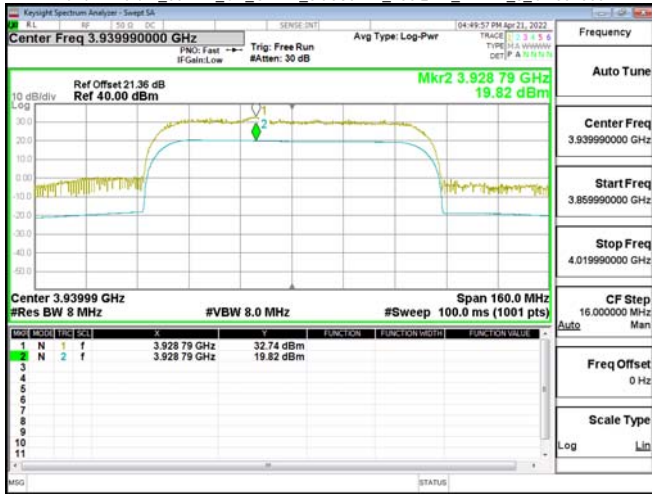

Band77-Part27_100MHz_CP_OFDM_SCS30kHz_256QAM_RB273_0_CH662000

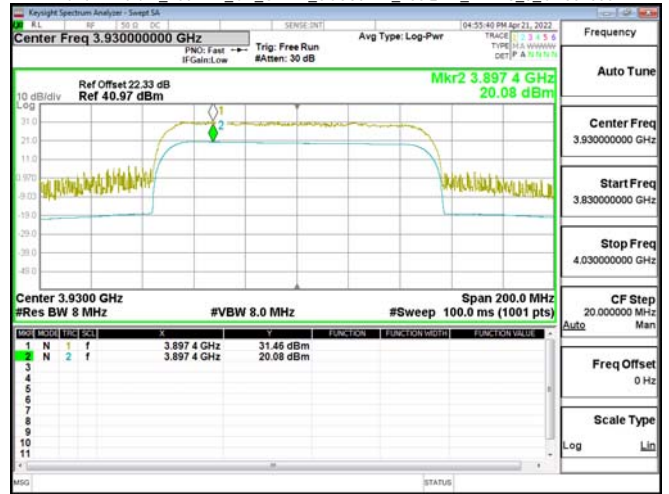

Band77-Part27_100MHz_CP_OFDM_SCS30kHz_256QAM_RB273_0_CH650000

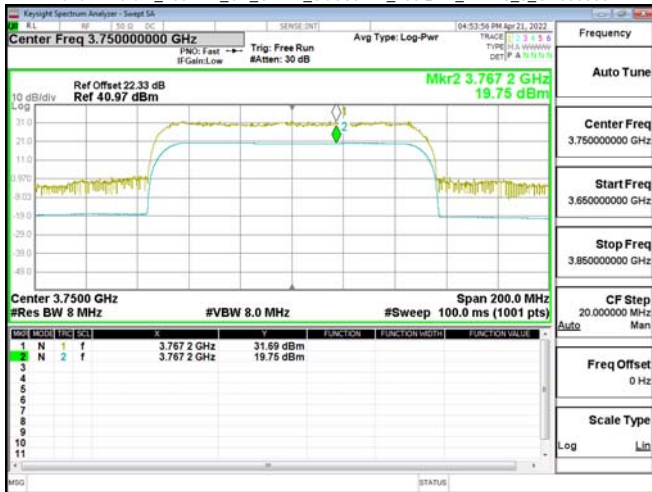

Band77-Part27_100MHz_CP_OFDM_SCS30kHz_256QAM_RB273_0_CH656000

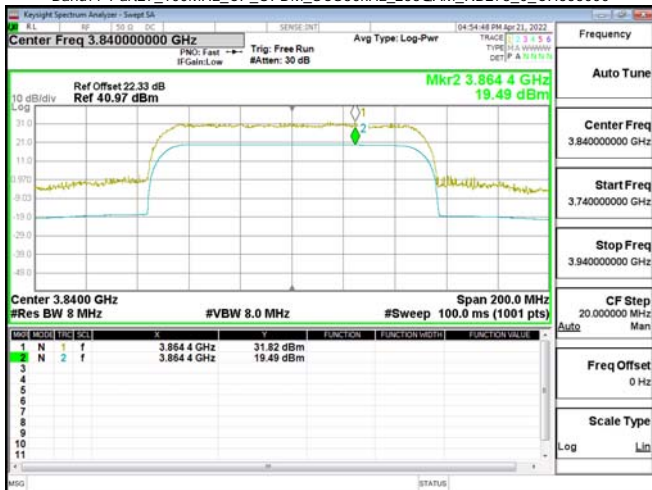

Unless otherwise stated the results shown in this test report refer only to the sample(s) tested and such sample(s) are retained for 90 days only.

除非另有說明，此報告結果僅對測試之樣品負責，同時此樣品僅保留90天。本報告未經本公司書面許可，不可部份複製。

This document is issued by the Company subject to its General Conditions of Service printed overleaf, available on request or accessible at <http://www.sgs.com.tw/Terms-and-Conditions> and for electronic format documents, subject to Terms and Conditions for Electronic Documents at <http://www.sgs.com.tw/Terms-and-Conditions>. Attention is drawn to the limitation of liability, indemnification and jurisdiction issues defined therein. Any holder of this document is advised that information contained herein reflects the Company's findings at the time of its intervention only and within the limits of Client's instructions, if any. The Company's sole responsibility is to its Client and this document does not exonerate parties to a transaction from exercising all their rights and obligations under the transaction documents. This document cannot be reproduced except in full, without prior written approval of the Company. Any unauthorized alteration, forgery or falsification of the content or appearance of this document is unlawful and offenders may be prosecuted to the fullest extent of the law.