



FCC TEST REPORT (PART 22)

REPORT NO.: RF941201L14

MODEL NO.: A320a

RECEIVED: Dec. 02, 2005

TESTED: Dec. 07 ~ Dec. 13, 2005

ISSUED: Dec. 19, 2005

APPLICANT: Amoi Electronics Co., Ltd

ADDRESS: No. 45, Tiyu Road, Xiamen, Fujian, China

ISSUED BY: Advance Data Technology Corporation

LAB ADDRESS: No. 47, 14th Ling, Chia Pau Tsuen, Lin Kou Hsiang
244, Taipei Hsien, Taiwan, R.O.C.

TEST LOCATION: No. 19, Hwa Ya 2nd Rd., Wen Hwa Tsuen, Kwei
Shan Hsiang, Taoyuan Hsien 333, Taiwan, R.O.C.

This test report consists of 69 pages in total. It may be duplicated completely for legal use with the approval of the applicant. It should not be reproduced except in full, without the written approval of our laboratory. The client should not use it to claim product endorsement by CNLA, A2LA or any government agencies. The test results in the report only apply to the tested sample.





TABLE OF CONTENTS

1	CERTIFICATION	4
2	SUMMARY OF TEST RESULTS	5
2.1	MEASUREMENT UNCERTAINTY	6
3	GENERAL INFORMATION	7
3.1	GENERAL DESCRIPTION OF EUT	7
3.2	DESCRIPTION OF TEST MODES	8
3.3	GENERAL DESCRIPTION OF APPLIED STANDARDS	9
3.4	DESCRIPTION OF SUPPORT UNITS	9
4	TEST TYPES AND RESULTS	10
4.1	MODULATION CHARACTERISTICS	10
4.1.1	DESCRIPTION OF MODULATION TECHNIQUE	10
4.1.2	THE ACTIVE TIME SLOT 8 MODULATED FRAME PLOT	11
4.2	OUTPUT POWER MEASUREMENT	13
4.2.1	LIMITS OF OUTPUT POWER MEASUREMENT	13
4.2.2	TEST INSTRUMENTS	14
4.2.3	TEST PROCEDURES	15
4.2.4	TEST SETUP	16
4.2.5	EUT OPERATING CONDITIONS	17
4.2.6	TEST RESULTS	18
4.3	FREQUENCY STABILITY MEASUREMENT	20
4.3.1	LIMITS OF FREQUENCY STABILITY MEASUREMENT	20
4.3.2	TEST INSTRUMENTS	20
4.3.3	TEST PROCEDURE	21
4.3.4	TEST SETUP	21
4.3.5	TEST RESULTS	22
4.4	OCCUPIED BANDWIDTH MEASUREMENT	26
4.4.1	LIMITS OF OCCUPIED BANDWIDTH MEASUREMENT	26
4.4.2	TEST INSTRUMENTS	26
4.4.3	TEST SETUP	26
4.4.4	TEST PROCEDURES	27
4.4.5	EUT OPERATING CONDITION	27
4.4.6	TEST RESULTS	28
4.5	BAND EDGE MEASUREMENT	32
4.5.1	LIMITS OF BAND EDGE MEASUREMENT	32
4.5.2	TEST INSTRUMENTS	32
4.5.3	TEST SETUP	32
4.5.4	TEST PROCEDURES	33
4.5.5	EUT OPERATING CONDITION	33



4.5.6	TEST RESULTS	34
4.6	CONDUCTED SPURIOUS EMISSIONS	36
4.6.1	LIMITS OF CONDUCTED SPURIOUS EMISSIONS MEASUREMENT	36
4.6.2	TEST INSTRUMENTS.....	36
4.6.3	TEST PROCEDURE.....	37
4.6.4	TEST SETUP.....	37
4.6.5	EUT OPERATING CONDITIONS	37
4.6.6	TEST RESULTS	38
4.7	RADIATED EMISSION MEASUREMENT (BELOW 1GHz).....	56
4.7.1	LIMITS OF RADIATED EMISSION MEASUREMENT	56
4.7.2	TEST INSTRUMENTS.....	57
4.7.3	TEST PROCEDURES	58
4.7.4	DEVIATION FROM TEST STANDARD	58
4.7.5	TEST SETUP.....	59
4.7.6	EUT OPERATING CONDITIONS	59
4.7.7	TEST RESULTS	60
4.8	EFFECTIVE RADIATED POWER MEASUREMENT (ABOVE 1GHz).....	61
4.8.1	LIMITS OF RADIATED EMISSION MEASUREMENT	61
4.8.2	TEST INSTRUMENTS.....	62
4.8.3	TEST PROCEDURES	63
4.8.4	DEVIATION FROM TEST STANDARD	63
4.8.5	TEST SETUP.....	64
4.8.6	EUT OPERATING CONDITIONS	64
4.8.7	TEST RESULTS	65
5	PHOTOGRAPHS OF THE TEST CONFIGURATION.....	68
6	INFORMATION ON THE TESTING LABORATORIES	69



1 CERTIFICATION

PRODUCT: Tri Band GSM mobile phone
MODEL: A320a
BRAND: AMOI
APPLICANT: Amoi Electronics Co., Ltd
TESTED: Dec. 07 ~ Dec. 13, 2005
TEST SAMPLE: MASS-PRODUCTION
TEST STANDARDS: **FCC Part 22, Subpart H**
ANSI C63.4-2003

The above equipment has been tested by **Advance Data Technology Corporation**, and found compliance with the requirement of the above standards. The test record, data evaluation & Equipment Under Test (EUT) configurations represented herein are true and accurate accounts of the measurements of the sample's EMC characteristics under the conditions specified in this report.

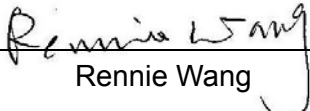
PREPARED BY :  , **DATE:** Dec. 19, 2005
Rennie Wang

TECHNICAL
ACCEPTANCE :  , **DATE:** Dec. 19, 2005
Responsible for RF Gary Chang

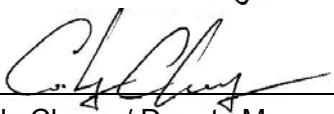
APPROVED BY :  , **DATE:** Dec. 19, 2005
Cody Chang / Deputy Manager



2 SUMMARY OF TEST RESULTS

The EUT has been tested according to the following specifications:

APPLIED STANDARD: FCC Part 22 & Part 2 / IC RSS-132			
STANDARD SECTION	TEST TYPE AND LIMIT	RESULT	REMARK
2.1047 (d)	Modulation Characteristics	PASS	NA
2.1046 22.913 (a)	Maximum Peak Output Power Limit: max. 7 watts e.r.p peak power	PASS	Meet the requirement of limit. Minimum passing margin is 30.33dBm at 848.80MHz.
2.1055	Frequency Stability AFC Freq. Error vs. Voltage AFC Freq. Error vs. Temperature Limit: max. ± 2.5 ppm	PASS	Meet the requirement of limit.
2.1049 (h)	Occupied Bandwidth	PASS	Meet the requirement of limit.
22.917	Band Edge Measurements	PASS	NA
2.1051 22.917	Conducted Spurious Emissions	PASS	Meet the requirement of limit. Minimum passing margin is -21.79 dB at 2548.00MHz.
2.1053 22.917	Radiated Spurious Emissions	PASS	Meet the requirement of limit. Minimum passing margin is -17.36 dB at 883.37MHz.



2.1 MEASUREMENT UNCERTAINTY

Where relevant, the following measurement uncertainty levels have been estimated for tests performed on the EUT as specified in CISPR 16-4:

MEASUREMENT	FREQUENCY	UNCERTAINTY
Conducted emissions	9kHz ~ 30MHz	2.44 dB
Radiated emissions	30MHz ~ 200MHz	3.73 dB
	200MHz ~1000MHz	3.74 dB
	1GHz ~ 18GHz	2.20 dB
	18GHz ~ 40GHz	1.88 dB

This uncertainty represents an expanded uncertainty expressed at approximately the 95% confidence level using a coverage factor of $k=2$.



3 GENERAL INFORMATION

3.1 GENERAL DESCRIPTION OF EUT

PRODUCT	Tri Band GSM mobile phone
MODEL NO.	A320a
POWER SUPPLY	3.70Vdc from rechargeable lithium battery 5.25Vdc from charger
MODULATION TYPE	GMSK
FREQUENCY RANGE	Tx Frequency: 824.2MHz ~ 848.8MHz (GSM band) Rx Frequency: 869.2MHz ~ 893.8MHz (GSM band)
NUMBER OF CHANNEL	124
MAX. CONDUCTED PEAK OUTPUT POWER	GSM Mode: 32.37dBm (1.726Watts) GPRS Mode: 32.20dBm (1.660Watts)
MAX. ERP POWER	GSM Mode: 30.33dBm (1.079Watts) GPRS Mode: 29.92dBm (0.982Watts)
ANTENNA TYPE	Fixed Internal antenna with 0dBi gain (for GSM band)
DATA CABLE	0.92m nonshielded cable for Earphone
I/O PORTS	Refer to user's manual
ASSOCIATED DEVICES	Charger, earphone
EUT EXTREME VOL. RANGE	3.3Vdc to 4.2Vdc

NOTE:

1. The applicant defined the normal working voltage of the battery is from 3.3Vdc to 4.2Vdc.
2. The EUT is a Tri Band GSM mobile phone. This report is only covered the functions of GSM850. The PCS1900 mobile phone function is covered in another test report, which standard used is FCC Part 24.
3. IMEI Code: 357222000000000 ~ 357222999999999.
4. Hardware version: V4.0.
5. Software version: A320a-REL01-051104-DLV23.101-VIM-N-MEX.
6. The EUT was operated with following charger:

BRAND:	AMOI
MODEL:	UTC03-A
INPUT:	100-240Vac, 50-60Hz, 0.15A
OUTPUT:	5.25Vdc, 600mA
POWER LINE:	DC 1.99m non-shielded cable without core

7. The above EUT information was declared by manufacturer and for more detailed features description, please refer to the manufacturer's specifications or User's Manual.



3.2 DESCRIPTION OF TEST MODES

124 channels are provided to this EUT in the GSM850 band. Therefore, the low, middle and high channels are chosen for testing.

	CHANNEL	FREQUENCY	TX MODE
LOW	128	824.2 MHz	GSM
MIDDLE	190	836.6 MHz	GSM
HIGH	251	848.8 MHz	GSM

NOTE:

1. Below 1 GHz, the channel 128, 190, and 251 were pre-tested in chamber. The channel 128 was chosen for final test.
2. Above 1 GHz, the channel 128, 190, and 251 were tested individually.
3. When the Power Control Level set 5, the worst case, was chosen for final test.
4. The channel space is 0.2MHz.
5. Since the EUT is considered a portable unit, it was pre-tested on the positioned of each 3 axis. The worst case was found when positioned on Y-plane. Therefore only the test data of this Y-plane was used for radiated emission measurement test.
6. The EUT is a GPRS class 10 device, which provide 2 up-link / 4 down-link. The up-link with 2 time slots has been chosen for the worst case to do the final test and record.
7. For spurious emissions test, GSM mode has been chosen for the worst case to do the final test and record.



3.3 GENERAL DESCRIPTION OF APPLIED STANDARDS

The EUT is a RF product. According to the specifications of the manufacturer, it must comply with the requirements of the following standards:

FCC 47 CFR Part 2

FCC 47 CFR Part 22

ANSI C63.4-2003

ANSI/TIA/EIA-603-A

NOTE: All test items have been performed and recorded as per the above standards.

3.4 DESCRIPTION OF SUPPORT UNITS

The EUT has been tested as an independent unit together with other necessary accessories or support units. The following support units or accessories were used to form a representative test configuration during the tests.

NO.	PRODUCT	BRAND	MODEL NO.	SERIAL NO.	CAL. DATE
1	Universal Radio Communication Tester	R&S	CMU200	101095	Oct. 06, 2006

NO.	SIGNAL CABLE DESCRIPTION OF THE ABOVE SUPPORT UNITS
1	NA

NOTE: All power cords of the above support units are non shielded (1.8m).



4 TEST TYPES AND RESULTS

4.1 MODULATION CHARACTERISTICS

4.1.1 DESCRIPTION OF MODULATION TECHNIQUE

According to FCC 2.1047(d), the system is used the digital modulation and accomplished with the GSM requirement. It uses narrowband TDMA. Eight simultaneous calls can occupy the same radio frequency.

There are 124 channels and channel space is 200kHz. The frequency band 824.2 ~ 848.8MHz is allocated to the uplink and 869.2 ~ 893.8MHz to the downlink. The uplink and downlink channel space is 45MHz and is duplex at the same time.



4.1.2 THE ACTIVE TIME SLOT 8 MODULATED FRAME PLOT

FOR GSM MODE (UP-LINK WITH 1 TIME SLOT)

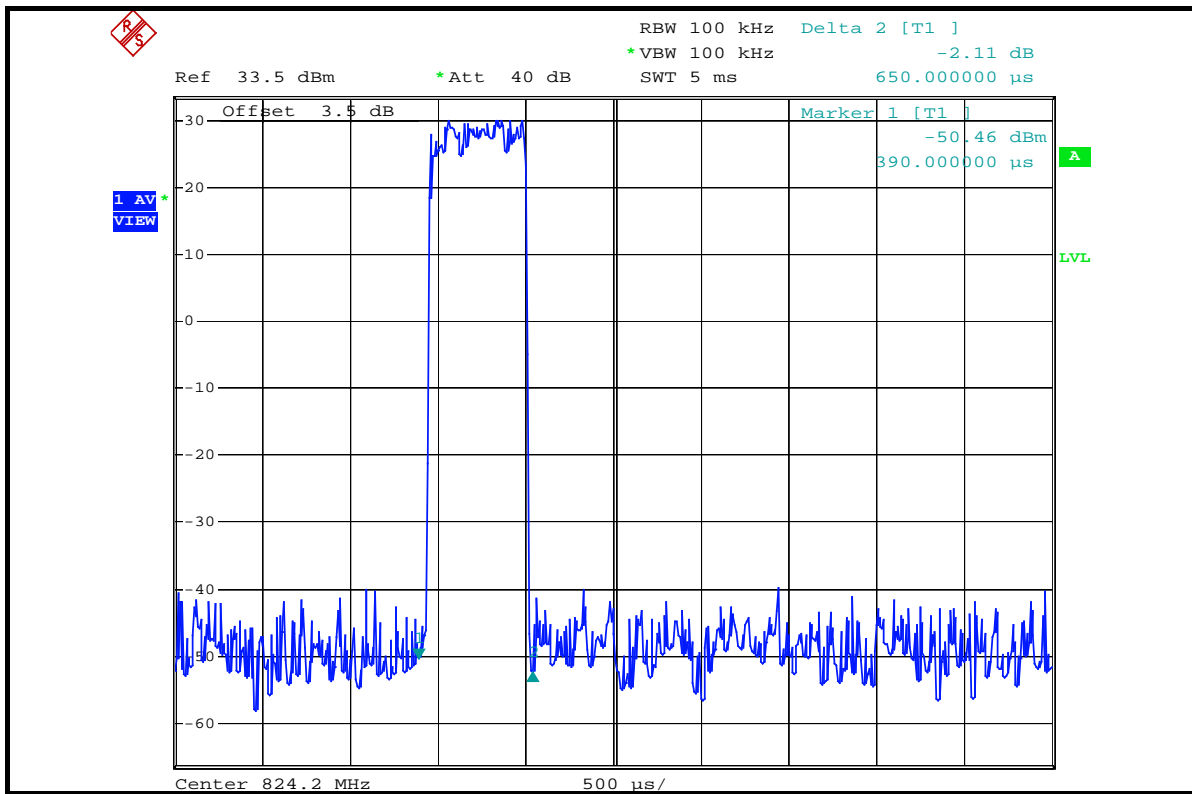
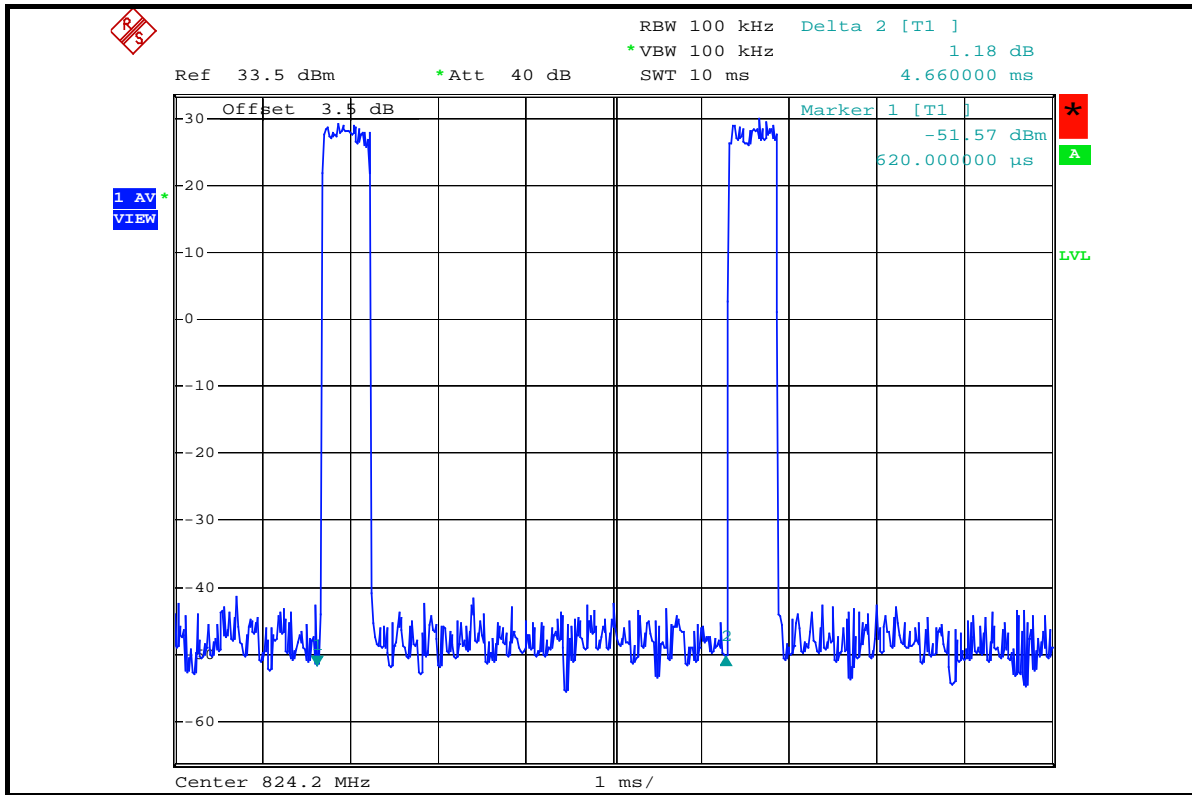



FOR GPRS MODE (UP-LINK WITH 2 TIME SLOTS)

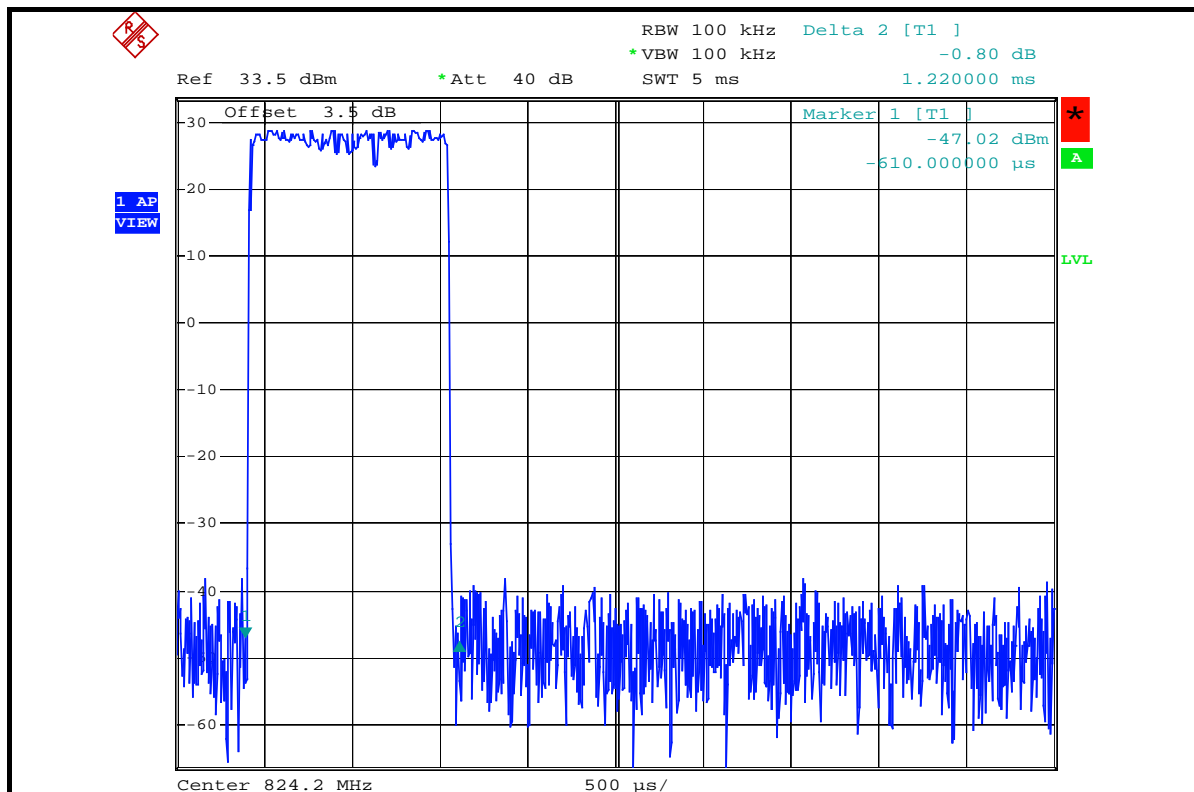
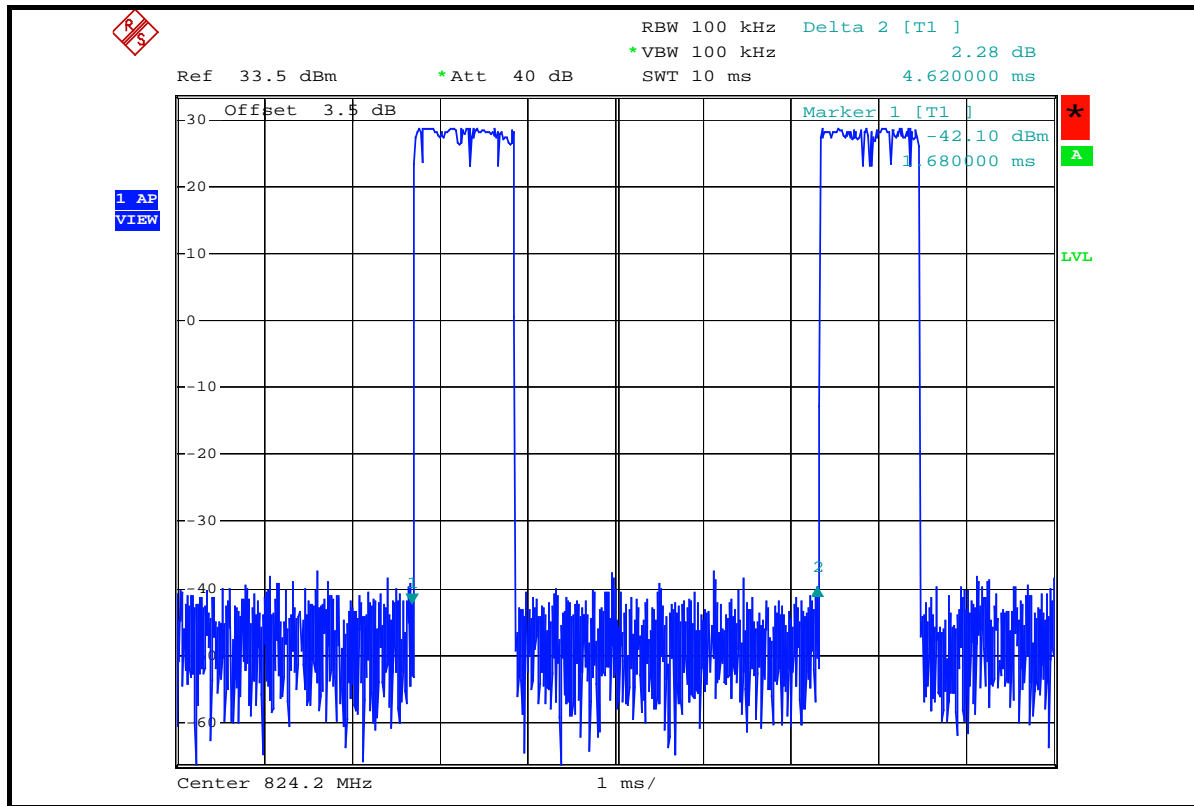



4.2 OUTPUT POWER MEASUREMENT

4.2.1 LIMITS OF OUTPUT POWER MEASUREMENT

The radiated peak output power shall be according to the specific rule Part 22.913 (a) that "Mobile / Portable station are limited to 7 watts e.r.p".



4.2.2 TEST INSTRUMENTS

DESCRIPTION & MANUFACTURER	MODEL NO.	SERIAL NO.	CALIBRATED UNTIL
Test Receiver ROHDE & SCHWARZ	ESIB7	100188	Dec. 19, 2005
Spectrum Analyzer ROHDE & SCHWARZ	FSP40	100039	Nov. 27, 2006
BILOG Antenna SCHWARZBECK	VULB9168	9168-157	Jan. 22, 2006
HORN Antenna SCHWARZBECK	BBHA 9120 D	9120D-407	Jan. 16, 2006
HORN Antenna SCHWARZBECK	BBHA 9170	BBHA 9170241	Feb. 23, 2006
Preamplifier Agilent	8449B	3008A01961	Oct. 23, 2006
Preamplifier Agilent	8447D	2944A10629	Oct. 27, 2006
RF signal cable HUBER+SUHNER	SUCOFLEX 104	218182/4	Feb. 17, 2006
RF signal cable HUBER+SUHNER	SUCOFLEX 104	218194/4	Feb. 17, 2006
Software ADT.	ADT_Radiated_V5.14	NA	NA
Antenna Tower ADT.	AT100	AT93021702	NA
Turn Table ADT.	TT100.	TT93021702	NA
Controller ADT.	SC100.	SC93021702	NA
AGILENT SIGNAL GENERATOR	E8257C	MY43320668	Dec. 07, 2006

- NOTE:**
1. The calibration interval of the above test instruments is 12 months and the calibrations are traceable to NML/ROC and NIST/USA.
 2. The test was performed in HwaYa Chamber 1.
 3. The horn antenna and HP preamplifier (model: 8449B) are used only for the measurement of emission frequency above 1GHz if tested.
 4. The IC Site Registration No. is IC4924-2.



4.2.3 TEST PROCEDURES

- a. The EUT was set up for the maximum peak power with GSM link data modulation. The power was measured with R&S Spectrum Analyzer. All measurements were done at 3 channels, 128, 190 and 251 (low, middle and high operational frequency range.)
- b. The conducted peak output power used the power splitter via EUT RF power connector between simulation base station and spectrum analyzer. The path loss included the splitter loss, cable loss and 20dB pad loss. The spectrum set RB/VB 3MHz, then read peak power value and record to the test. (All transmitted path loss shall be considered in the test report data.)
- c. E.I.R.P peak power measurement. In the fully anechoic chamber, EUT placed on the 1.5m height of Turn Table, rotated the table around 360 degrees to search the maximum radiation power and receiver antenna shall be rotated vertical and horizontal polarization to find the maximum polar radiated power. The "Read Value" is the spectrum reading the maximum power value.
- d. The substitution horn antenna is substituted for EUT at the same position and signals generator export the CW signal to the calibration antenna. Rotated the Turn Table to find the maximum radiation power. "Raw" is the spectrum reading value, "SG" is signal generator export power, "TX Gain" is calibration antenna isotropic gain value, "TX cable" is the transmitted cable loss between the calibration antenna and signal generator. The "Factor" means that the transmission path loss is equal to "SG" - "TX cable" + "TX Gain" - "Raw".
- e. Actually the real E.I.R.P peak power is equal to "Read Value" + "Factor"
- f. E.R.P power can be calculated form E.I.R.P power by subtracting the gain of dipole, E.R.P power = E.I.P.R power - 2.15dBi.

NOTE: The resolution bandwidth and video bandwidth of test receiver/spectrum analyzer is 3MHz for Peak detection (PK)

4.2.4 TEST SETUP

EIRP POWER MEASUREMENT:

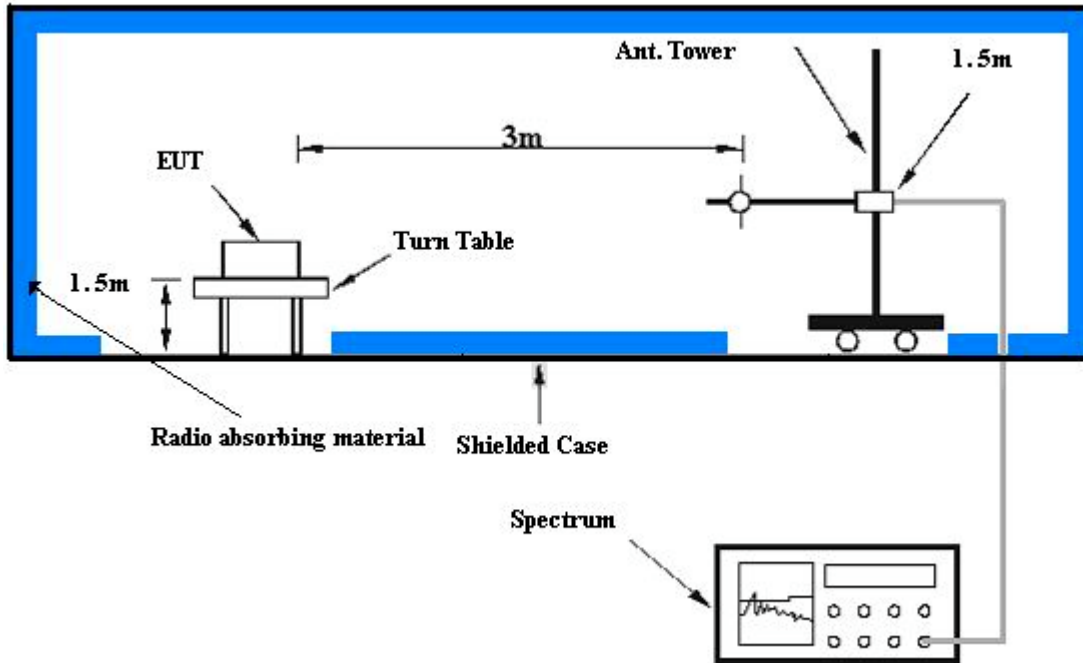

For the actual test configuration, please refer to the related item – Photographs of the Test Configuration.

CONDUCTED POWER MEASUREMENT:

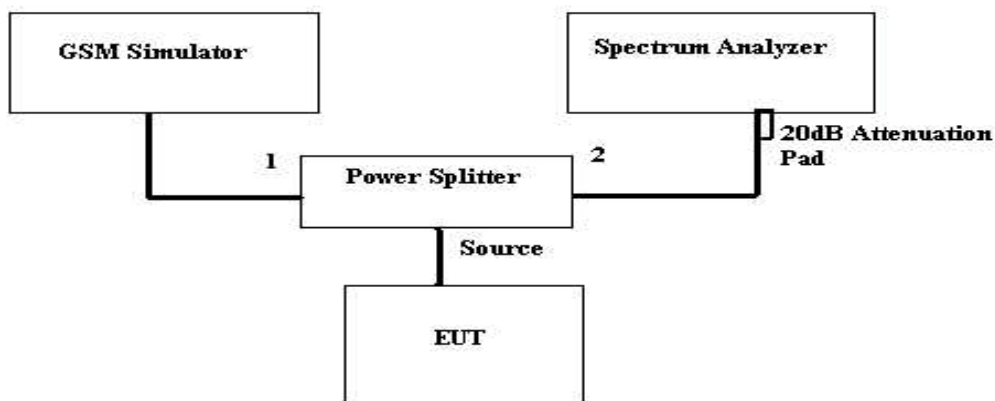

For the actual test configuration, please refer to the related item – Photographs of the Test Configuration.



4.2.5 EUT OPERATING CONDITIONS

- a. The EUT makes a phone call to the GSM simulator.
- b. The GSM simulator station system controlled a EUT to export maximum output power under transmission mode and specific channel frequency.

4.2.6 TEST RESULTS

EUT	Tri Band GSM mobile phone	MODEL	A320a
MODE	TX connected	POWER CONTROL LEVEL	5
INPUT POWER (SYSTEM)	120Vac, 60 Hz	DETECTOR FUNCTION	Peak
ENVIRONMENTAL CONDITIONS	26deg. C, 65%RH, 991hPa	TESTED BY	Long Chen

FOR GSM MODE (UP-LINK WITH 1 TIME SLOT)

CONDUCTED PEAK OUTPUT POWER					
CHANNEL NO.	FREQUENCY (MHz)	RAW VALUE (dBm)	CORRECTION FACTOR (dB)	PEAK OUTPUT POWER	
				dBm	Watt
128	824.20	26.64	3.50	30.14	1.033
190	836.60	27.95	3.50	31.45	1.396
251	848.80	28.87	3.50	32.37	1.726

FOR GPRS MODE (UP-LINK WITH 2 TIME SLOTS)

CONDUCTED PEAK OUTPUT POWER					
CHANNEL NO.	FREQUENCY (MHz)	RAW VALUE (dBm)	CORRECTION FACTOR (dB)	PEAK OUTPUT POWER	
				dBm	Watt
128	824.20	26.52	3.50	30.02	1.005
190	836.60	27.75	3.50	31.25	1.334
251	848.80	28.70	3.50	32.20	1.660

REMARKS: 1. Peak Output Power (dBm) = Raw Value (dBm) + Correction Factor (dB).
 2. Correction Factor (dB) = Power Splitter Loss (dB) + Cable Loss (dB).



EUT	Tri Band GSM mobile phone	MODEL	A320a
MODE	TX connected	POWER CONTROL LEVEL	5
INPUT POWER (SYSTEM)	120Vac, 60 Hz	DETECTOR FUNCTION	Peak
ENVIRONMENTAL CONDITIONS	27deg. C, 60%RH, 991hPa	TESTED BY	Long Chen

FOR GSM MODE (UP-LINK WITH 1 TIME SLOT)

ERP POWER					
CHANNEL NO.	FREQUENCY (MHz)	RAW VALUE (dBm)	CORRECTION FACTOR (dB)	PEAK OUTPUT POWER	
				dBm	Watt
128	824.20	-9.63	40.03	28.25	0.668
190	836.60	-8.61	40.32	29.56	0.904
251	848.80	-8.14	40.62	30.33	1.079

FOR GPRS MODE (UP-LINK WITH 2 TIME SLOTS)

ERP POWER					
CHANNEL NO.	FREQUENCY (MHz)	RAW VALUE (dBm)	CORRECTION FACTOR (dB)	PEAK OUTPUT POWER	
				dBm	Watt
128	824.20	-9.85	40.03	28.03	0.635
190	836.60	-9.03	40.32	29.14	0.820
251	848.80	-8.55	40.62	29.92	0.982

REMARKS: 1. Peak Output Power (dBm) = Raw Value (dBm) + Correction Factor (dB).
 2. Correction Factor (dB) = Receiver Antenna Gain (dBi) + Cable Loss (dB) + Free Space Loss (dB).



4.3 FREQUENCY STABILITY MEASUREMENT

4.3.1 LIMITS OF FREQUENCY STABILITY MEASUREMENT

According to the FCC part 2.4235 shall be tested the frequency stability. The rule is defined that "The frequency stability shall be sufficient to ensure that the fundamental emission stays within the authorized frequency block." The frequency error rate is according to the JTC standard that the frequency error rate shall be accurate to within 2.5ppm of the received frequency from the base station. The test extreme voltage is according to the 2.1055(d)(1) Vary primary supply voltage from 85 to 115 percent of the nominal value for other than hand carried battery equipment and the extreme temperature rule is comply with the 2.1055(a)(1) $-30^{\circ}\text{C} \sim 50^{\circ}\text{C}$.

4.3.2 TEST INSTRUMENTS

DESCRIPTION & MANUFACTURER	MODEL NO.	SERIAL NO.	CALIBRATED UNTIL
* Hewlett Packard RF cable	8120-6192	01428251	NA
* Suhner RF cable	Sucoflex104	204850/4	NA
* WIT Standard Temperature & Humidity Chamber	TH-4S-C	W981030	Jul. 18, 2006

- NOTE:**
1. The calibration interval of the above test instruments is 12 months. And the calibrations are traceable to NML/ROC and NIST/USA.
 2. "*" = These equipments are used for the final measurement.
 3. The test was performed in ADT RF OVEN room.

4.3.3 TEST PROCEDURE

- a. Because of the measure the carrier frequency under the condition of the AFC lock, it shall be used the mobile station in the GSM link mode. This is accomplished with the use of the R&S CMU200 simulator station. The oven room could control the temperatures and humidity. The GSM link channel is the 251.
- b. Power must be removed when changing from one temperature to another or one voltage to another voltage. Power warm up is at least 15 min and power applied should perform before recording frequency error.
- c. EUT is connected the external power supply to control the DC input power. The various Volts from the minimum 3.3 Volts to 4.2 Volts. Each step shall be record the frequency error rate.
- d. The temperature range step is 10 degrees in this test items. All temperature levels shall be hold the $\pm 0.5^{\circ}\text{C}$ during the measurement testing.
- e. The each temperature step shall be at least 0.5 hours, consider the EUT could be test under the stability condition.

NOTE: The frequency error was recorded frequency error from the GSM simulator.

4.3.4 TEST SETUP

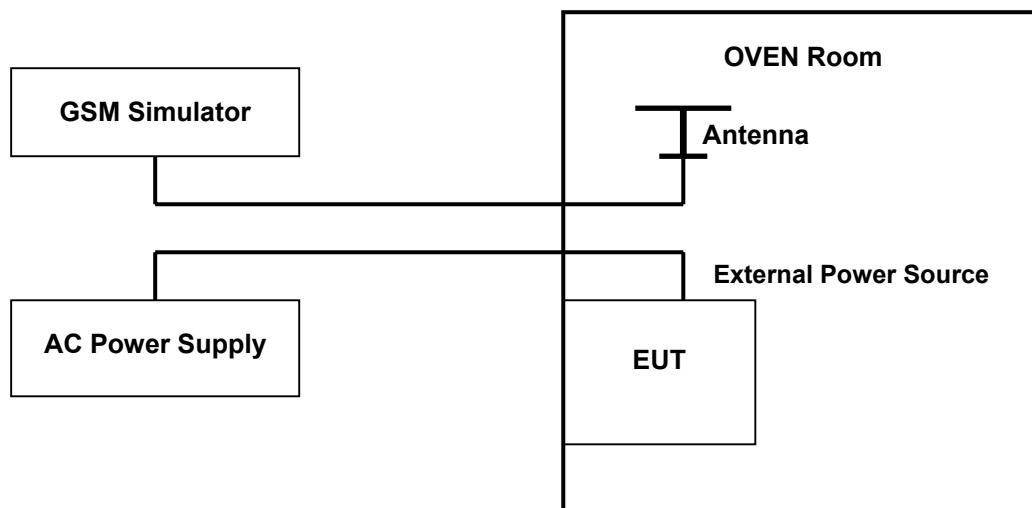



4.3.5 TEST RESULTS

EUT	Tri Band GSM mobile phone	MODEL	A320a
MODE	TX channel 251	POWER CONTROL LEVEL	5
INPUT POWER (SYSTEM)	120Vac, 60 Hz	ENVIRONMENTAL CONDITIONS	26deg. C, 65%RH, 991hPa
TESTED BY	Long Chen		

FOR GSM MODE (UP-LINK WITH 1 TIME SLOT)

AFC FREQUENCY ERROR vs. VOLTAGE			
VOLTAGE (Volts)	FREQUENCY ERROR (Hz)	FREQUENCY ERROR (ppm)	LIMIT (ppm)
3.3	33	0.039445374	2.5
3.4	36	0.043031317	2.5
3.5	35	0.041836003	2.5
3.6	39	0.046617260	2.5
3.7	40	0.047812575	2.5
3.8	37	0.044226632	2.5
3.9	38	0.045421946	2.5
4.0	41	0.049007889	2.5
4.1	36	0.043031317	2.5
4.2	40	0.047812575	2.5

NOTE: The applicant defined the normal working voltage of the battery is from 3.3Vdc to 4.2Vdc.



FOR GPRS MODE (UP-LINK WITH 2 TIME SLOTS)

AFC FREQUENCY ERROR vs. VOLTAGE			
VOLTAGE (Volts)	FREQUENCY ERROR (Hz)	FREQUENCY ERROR (ppm)	LIMIT (ppm)
3.3	38	0.045421946	2.5
3.4	39	0.046617260	2.5
3.5	42	0.050203203	2.5
3.6	43	0.051398518	2.5
3.7	41	0.049007889	2.5
3.8	45	0.053789147	2.5
3.9	39	0.046617260	2.5
4.0	44	0.052593832	2.5
4.1	42	0.050203203	2.5
4.2	47	0.056179775	2.5

NOTE: The applicant defined the normal working voltage of the battery is from 3.3Vdc to 4.2Vdc.



EUT	Tri Band GSM mobile phone	MODEL	A320a
MODE	TX channel 251	POWER CONTROL LEVEL	5
INPUT POWER (SYSTEM)	120Vac, 60 Hz	ENVIRONMENTAL CONDITIONS	26deg. C, 65%RH, 991hPa
TESTED BY	Long Chen		

FOR GSM MODE (UP-LINK WITH 1 TIME SLOT)

AFC FREQUENCY ERROR vs. VOLTAGE			
TEMP. (°C)	FREQUENCY ERROR (Hz)	FREQUENCY ERROR (ppm)	LIMIT (ppm)
50	39	0.046617260	2.5
40	36	0.043031317	2.5
30	35	0.041836003	2.5
20	32	0.038250060	2.5
10	40	0.047812575	2.5
0	42	0.050203203	2.5
-10	47	0.056179775	2.5
-20	49	0.058570404	2.5
-30	48	0.057375090	2.5

**FOR GPRS MODE (UP-LINK WITH 2 TIME SLOTS)**

AFC FREQUENCY ERROR vs. VOLTAGE			
TEMP. (°C)	FREQUENCY ERROR (Hz)	FREQUENCY ERROR (ppm)	LIMIT (ppm)
50	49	0.058570404	2.5
40	52	0.062156347	2.5
30	48	0.057375090	2.5
20	39	0.046617260	2.5
10	40	0.047812575	2.5
0	43	0.051398518	2.5
-10	45	0.053789147	2.5
-20	51	0.060961033	2.5
-30	56	0.066937605	2.5



4.4 OCCUPIED BANDWIDTH MEASUREMENT

4.4.1 LIMITS OF OCCUPIED BANDWIDTH MEASUREMENT

According to FCC 2.1049 (h) specified that emission bandwidth is defined as the width of the signal between two points, one below the carrier center frequency and one above the carrier center frequency, outside of which all emissions are attenuated at least 26 dB below the transmitter power.

4.4.2 TEST INSTRUMENTS

DESCRIPTION & MANUFACTURER	MODEL NO.	SERIAL NO.	CALIBRATED UNTIL
* ROHDE & SCHWARZ Spectrum Analyzer	FSP40	100035	Apr. 13, 2006
* Mini-Circuits Power Splitter	ZAPD-4	400005	NA
* Hewlett Packard RF cable	8120-6192	01428251	NA
* JFW 20dB attenuation	50HF-020-SMA	NA	NA
* Suhner RF cable	Sucoflex104	204850/4	NA

NOTE: 1. The calibration interval of the above test instruments is 12 months. And the calibrations are traceable to NML/ROC and NIST/USA.

2. "*" = These equipments are used for the final measurement.

4.4.3 TEST SETUP

Same as Item 4.2.4 (Conducted Power Setup)



4.4.4 TEST PROCEDURES

- a. The EUT was set up for the maximum peak power with GSM link data modulation. The power was measured with R&S Spectrum Analyzer. All measurements were done at 3 channels, 128, 190 and 251 (low, middle and high operational frequency range.)
- b. The conducted occupied bandwidth used the power splitter via EUT RF power connector between simulation base station and spectrum analyzer. This splitter loss and cable loss is the worst loss 4dB in the transmitted path track.
- c. FCC 2.1049 (h) required a measurement bandwidth is the fundamental emission below 26dB bandwidth.

4.4.5 EUT OPERATING CONDITION

- a. The EUT makes a phone call to the GSM simulator.
- b. The GSM simulator station system controlled a EUT to export maximum and minimum output power under transmission mode and specific channel frequency Same as Item 4.4.5



4.4.6 TEST RESULTS

FOR GSM MODE (UP-LINK WITH 1 TIME SLOT)

FREQUENCY (MHz)	OUTPUT POWER -26 dBc BANDWIDTH (kHz)
824.2	312
836.6	314
848.8	314

CH 128 POWER

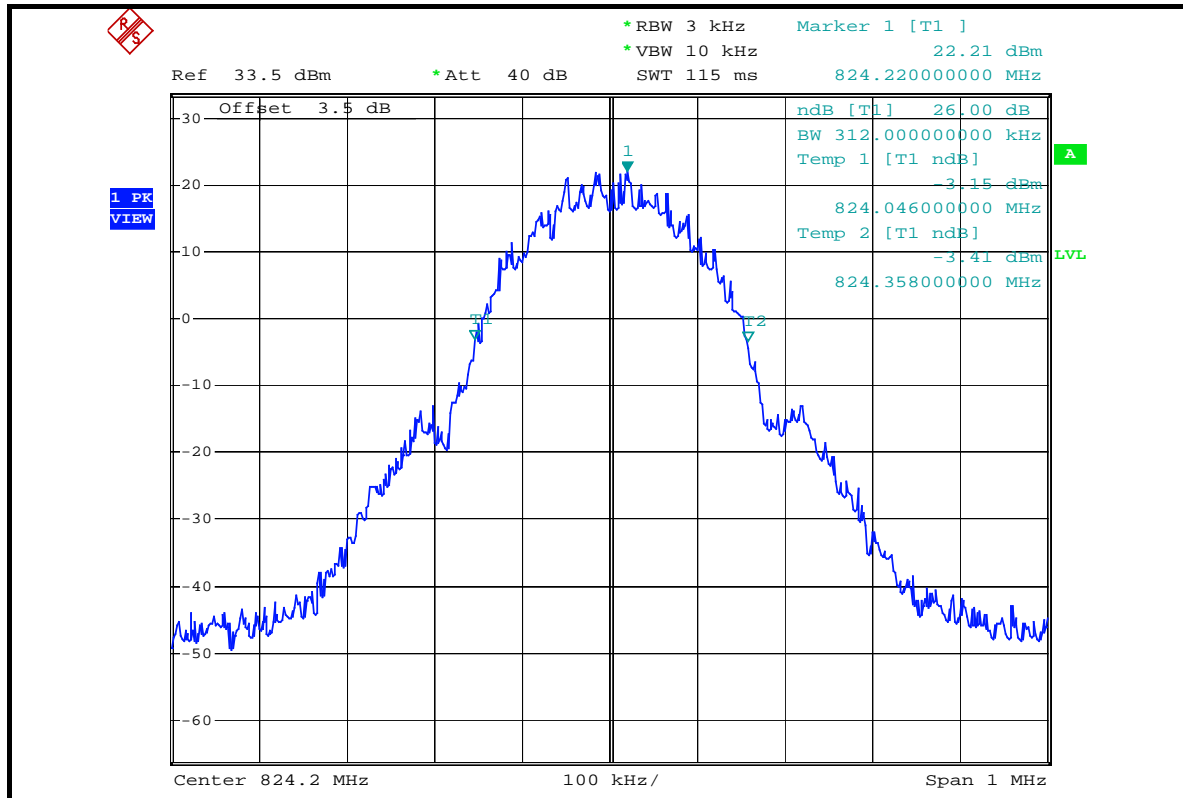



CH 190 POWER

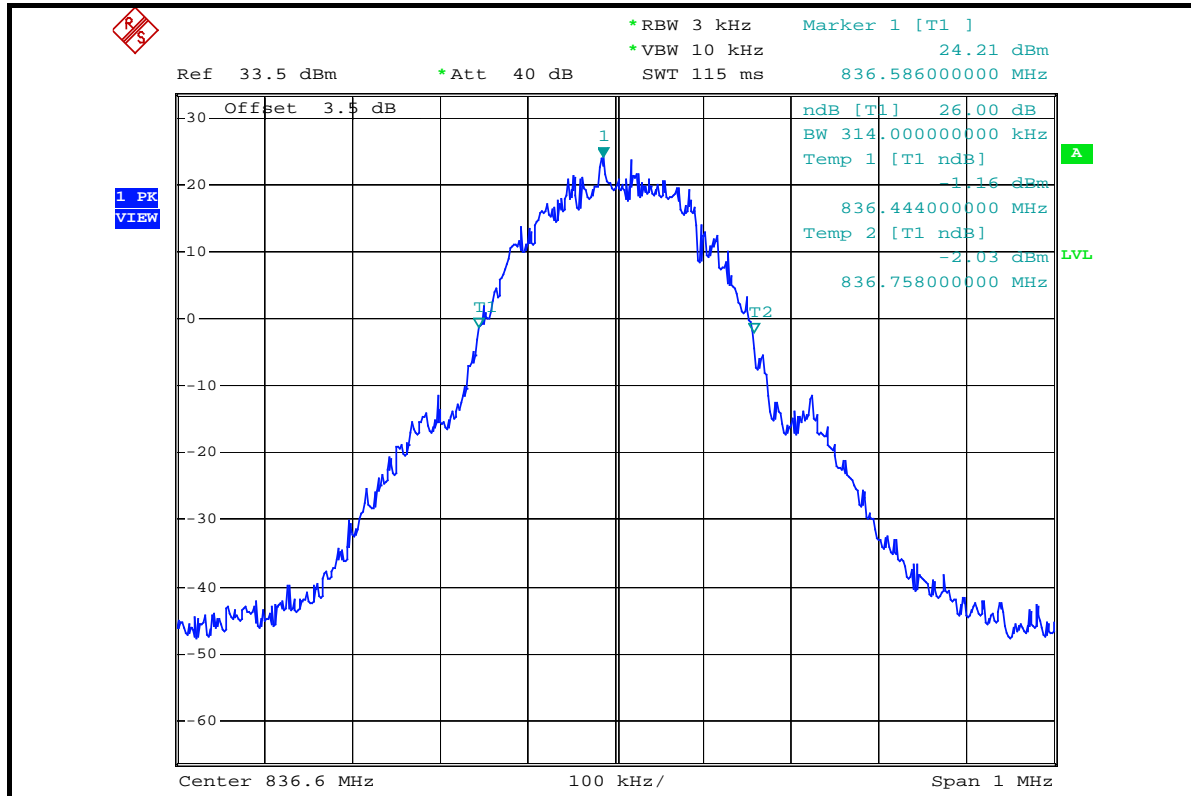

CH 251 POWER

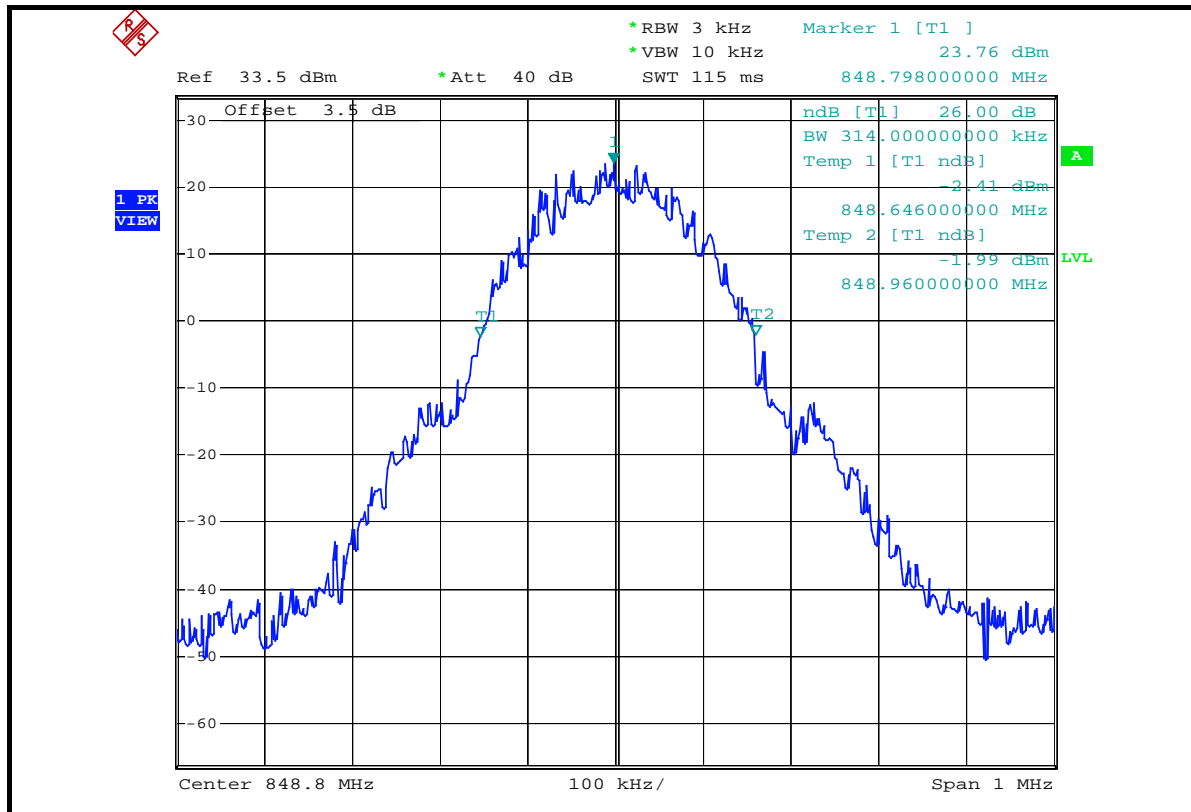



FOR GPRS MODE (UP-LINK WITH 2 TIME SLOTS)

FREQUENCY (MHz)	OUTPUT POWER -26 dBc BANDWIDTH (kHz)
824.2	318
836.6	316
848.8	316

CH 128 POWER

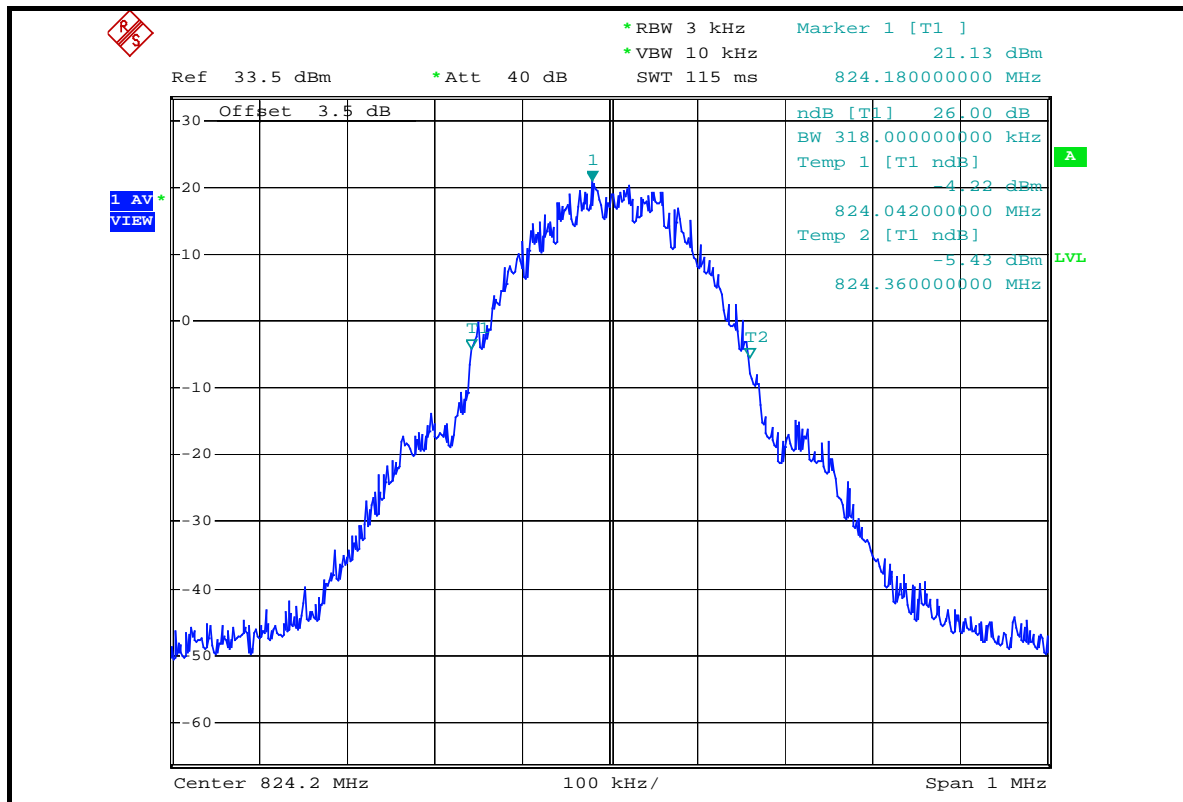



CH 190 POWER

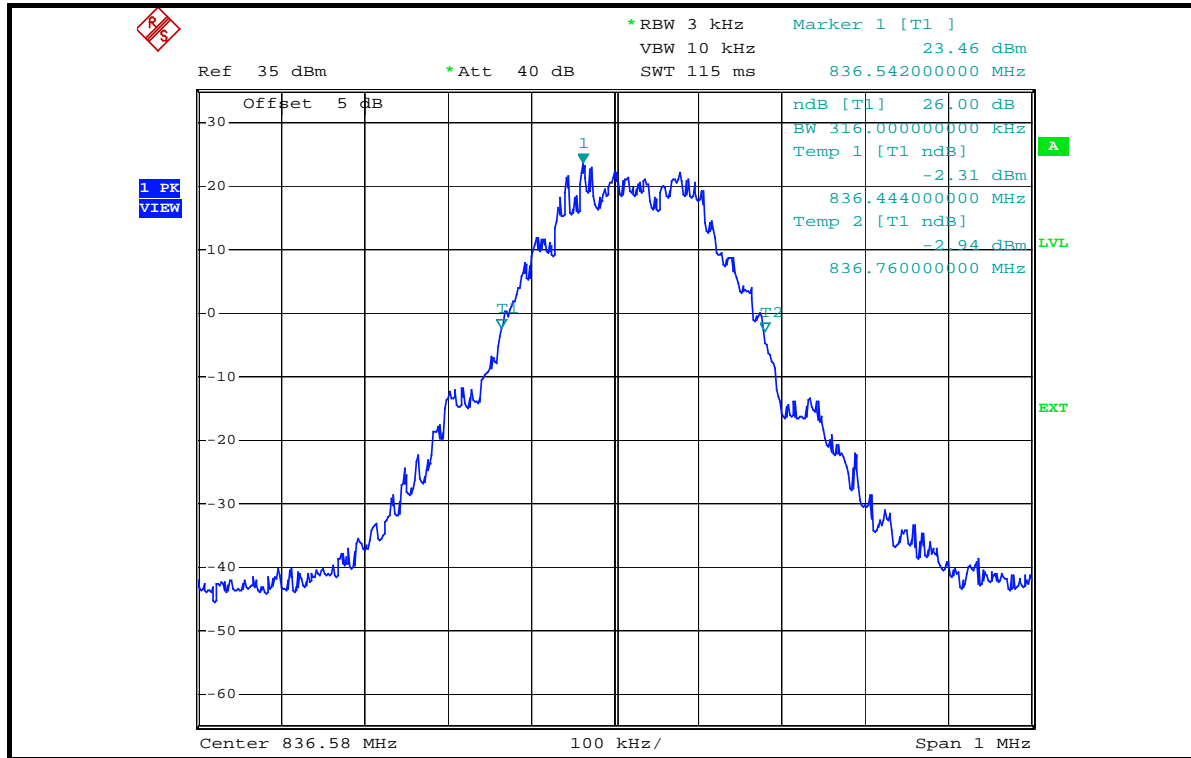

CH 251 POWER

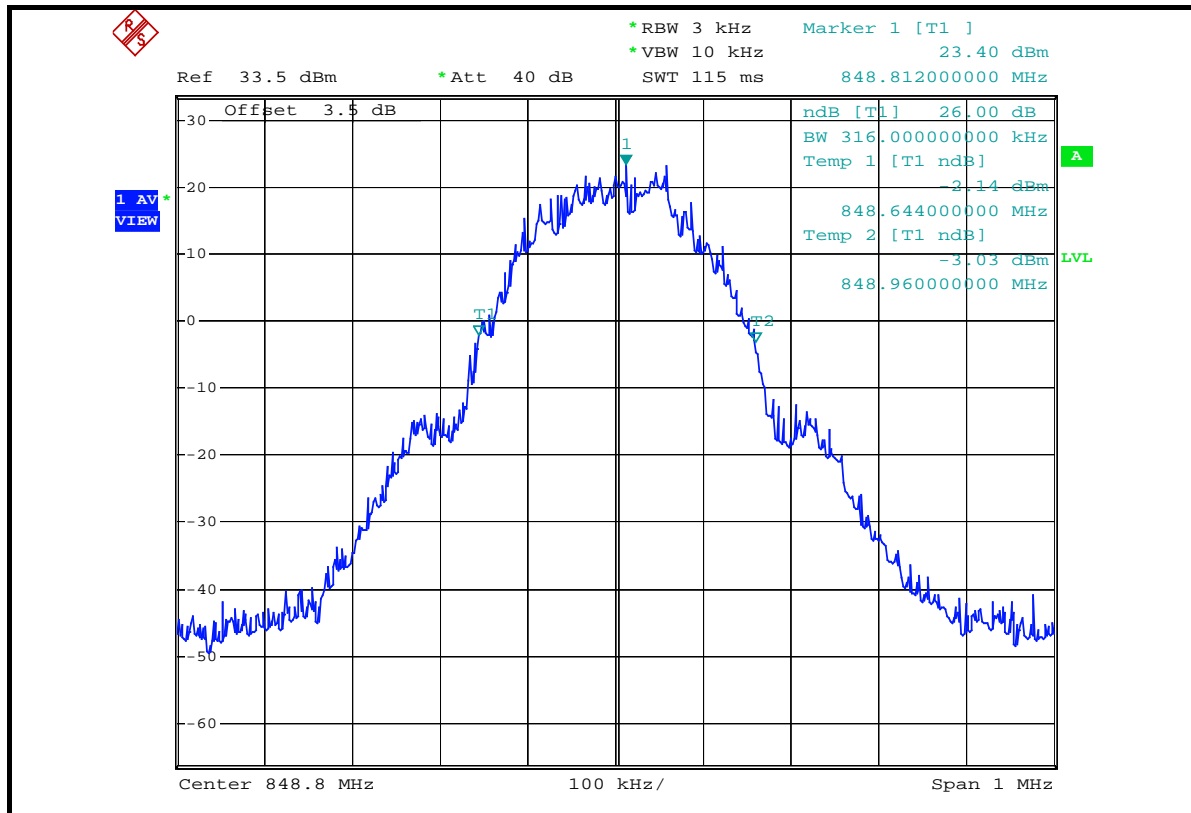



4.5 BAND EDGE MEASUREMENT

4.5.1 LIMITS OF BAND EDGE MEASUREMENT

According to FCC 22.917 specified that power of any emission outside of the authorized operating frequency ranges must be attenuated below the transmitting power (P) by a factor of at least $43 + 10 \log(P)$ dB. In the 1 MHz bands immediately outside and adjacent to the frequency block a resolution bandwidth of at least one percent of the emission bandwidth of the fundamental emission of the transmitter may be employed. Then we measure that the bandwidth is about 300kHz and the resolution bandwidth is 3kHz.

4.5.2 TEST INSTRUMENTS

DESCRIPTION & MANUFACTURER	MODEL NO.	SERIAL NO.	CALIBRATED UNTIL
* ROHDE & SCHWARZ Spectrum Analyzer	FSP40	100035	Apr. 13, 2006
* Mini-Circuits Power Splitter	ZAPD-4	400005	NA
* Hewlett Packard RF cable	8120-6192	01428251	NA
* JFW 20dB attenuation	50HF-020-SMA	NA	NA
* Suhner RF cable	Sucoflex104	204850/4	NA

- NOTE:** 1. The calibration interval of the above test instruments is 12 months. And the calibrations are traceable to NML/ROC and NIST/USA.
 2. "*" = These equipments are used for the final measurement.

4.5.3 TEST SETUP

Same as Item 4.2.4 (Conducted Power Setup)



4.5.4 TEST PROCEDURES

- a. The EUT was set up for the maximum peak power with GSM link data modulation. The power was measured with R&S Spectrum Analyzer. All measurements were done at 2 channels, 128 and 251 (low and high operational frequency range.)
- b. The band edge measurement used the power splitter via EUT RF power connector between simulation base station and spectrum analyzer. This splitter loss and cable loss is the worst loss 4dB in the transmitted path track.
- c. The center frequency of spectrum is the band edge frequency and span is 1.5 MHz. RB of the spectrum is 3kHz and VB of the spectrum is 10KHz.
- d. Record the max trace plot into the test report.

4.5.5 EUT OPERATING CONDITION

- a. The EUT makes a phone call to the GSM simulator.
- b. The GSM simulator station system controlled a EUT to export maximum output power under transmission mode and specific channel frequency Same as Item 4.4.5.



4.5.6 TEST RESULTS

FOR GSM MODE (UP-LINK WITH 1 TIME SLOT)

LOWER BAND EDGE

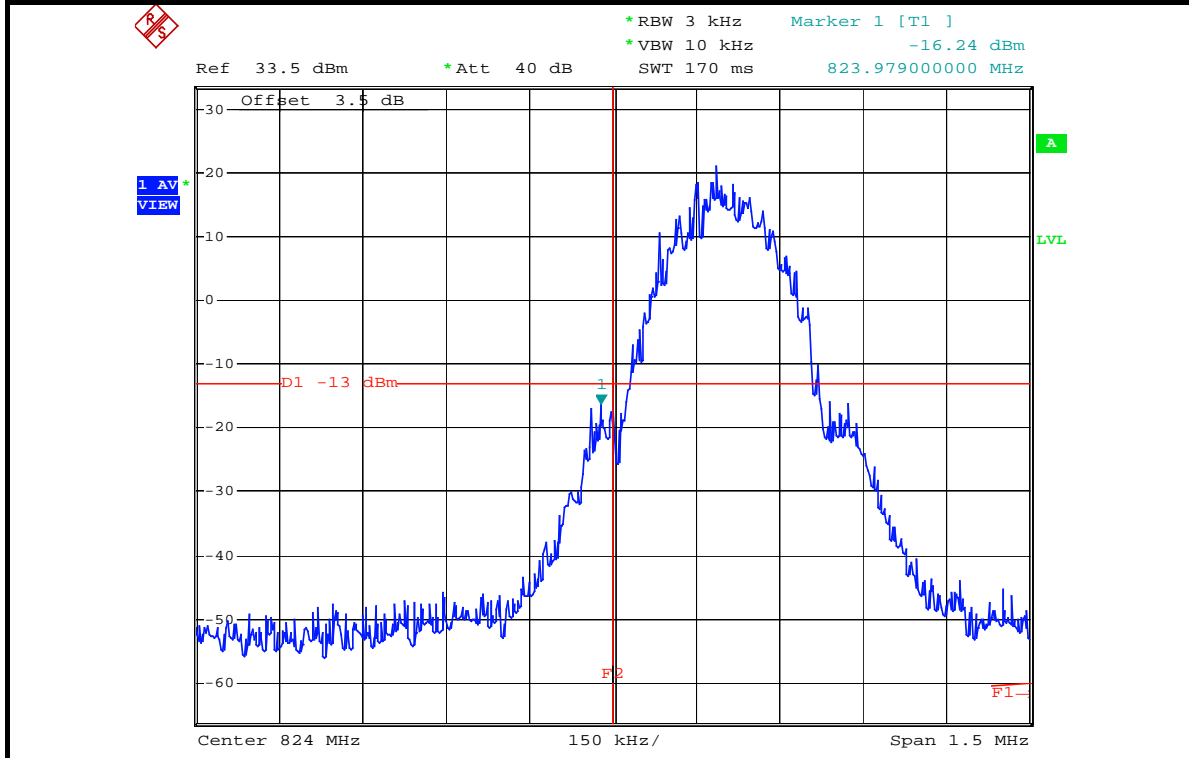

HIGHER BAND EDGE

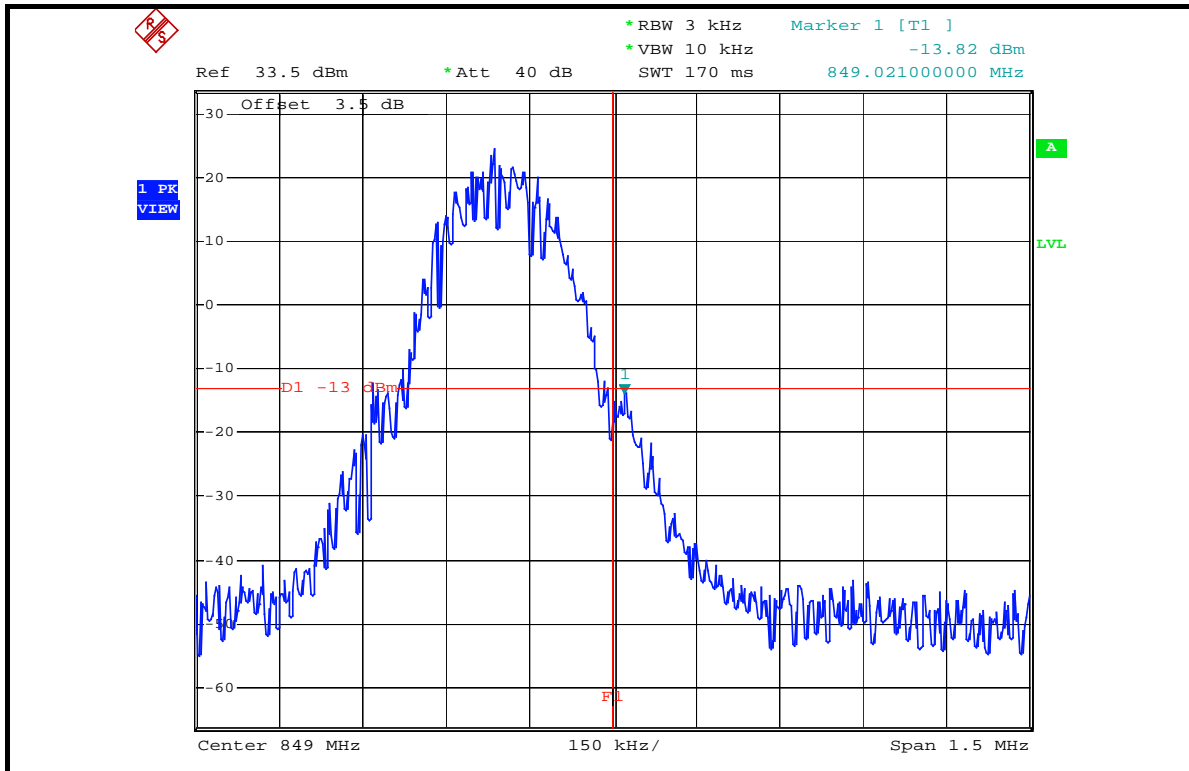



FOR GPRS MODE (UP-LINK WITH 2 TIME SLOTS)

LOWER BAND EDGE

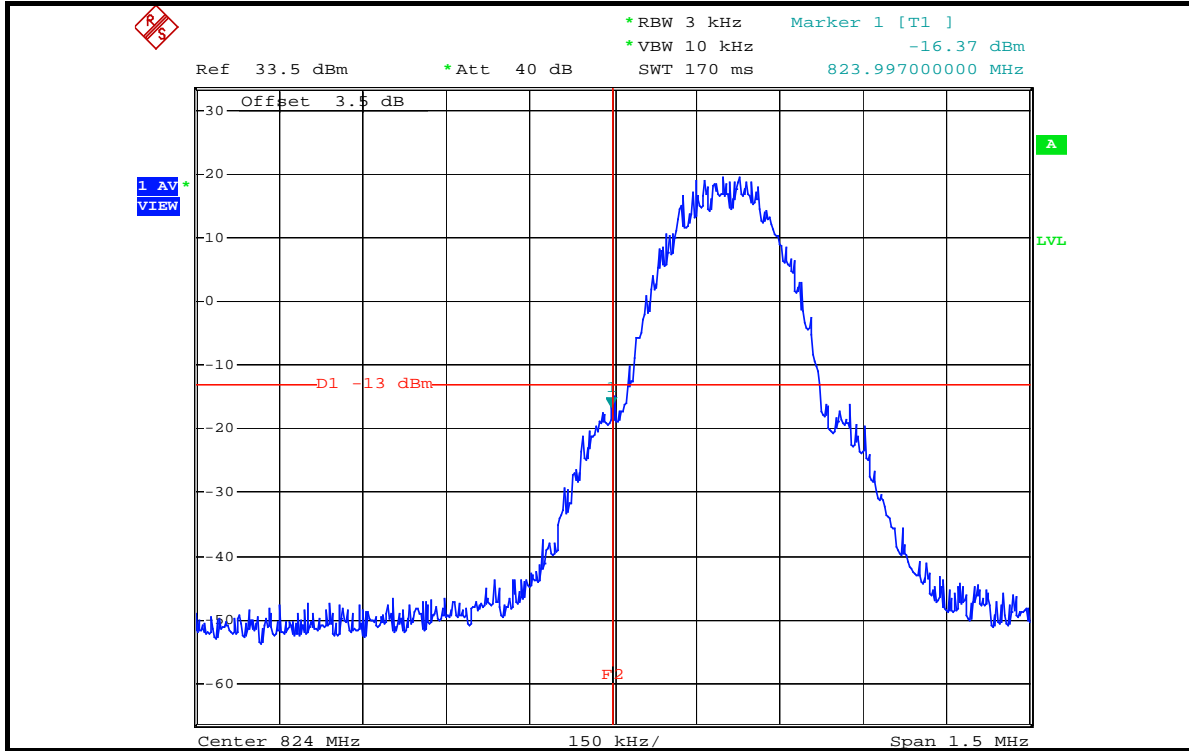

HIGHER BAND EDGE

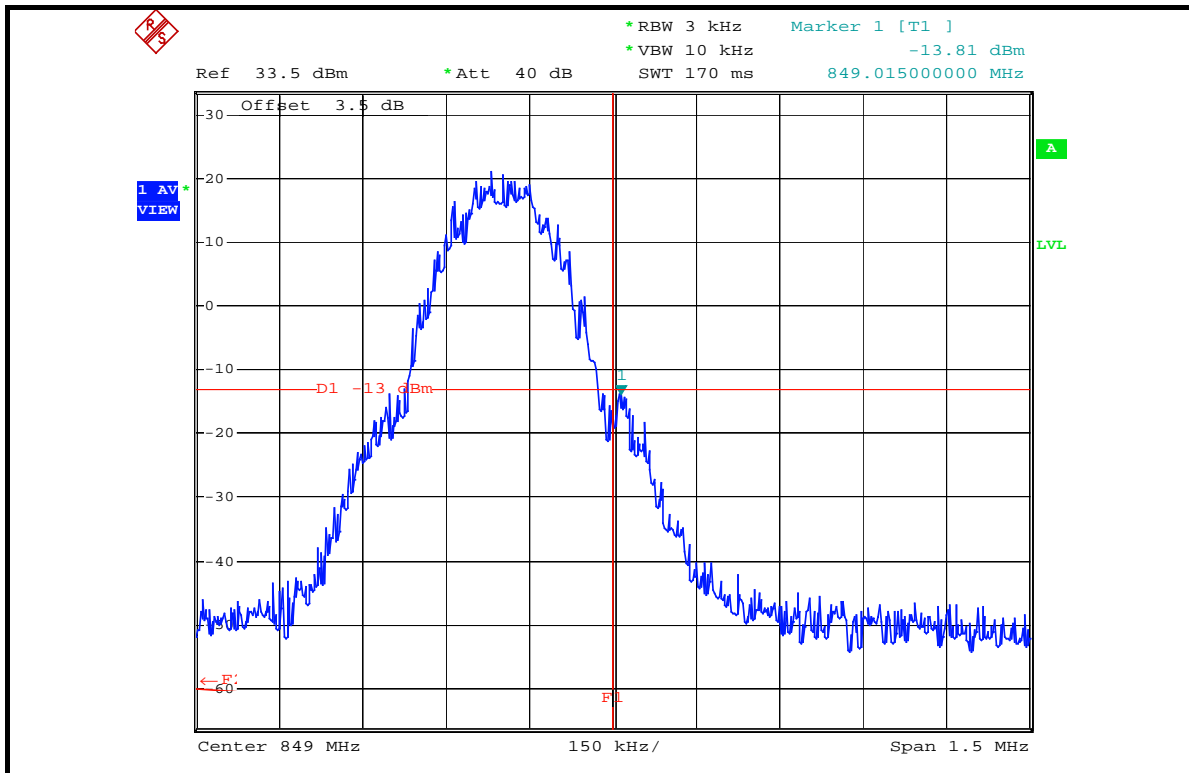



4.6 CONDUCTED SPURIOUS EMISSIONS

4.6.1 LIMITS OF CONDUCTED SPURIOUS EMISSIONS MEASUREMENT

In the FCC 22.917, On any frequency outside a licensee's frequency block within GSM spectrum, the power of any emission shall be attenuated below the transmitter power (P) by at least $43 + 10 \log (P)$ dB. The limit translates in the relevant power range (2 to 0.003W). At 2W (Power Control Level 5) the specified minimum attenuation becomes 43dB and the limit of emission equal to -13dBm .

4.6.2 TEST INSTRUMENTS

DESCRIPTION & MANUFACTURER	MODEL NO.	SERIAL NO.	CALIBRATED UNTIL
* ROHDE & SCHWARZ Spectrum Analyzer	FSP40	100035	Apr. 13, 2006
* Wainwright Instruments Band Reject Filter	WRCG1850/1910- 1830/1930- 60/10SS	SN1	NA
* Wainwright Instruments High Pass Filter	WHK3.1/18G-10SS	SN1	NA
* Mini-Circuits Power Splitter	ZAPD-4	400005	NA
* Hewlett Packard RF cable	8120-6192	01428251	NA
* JFW 20dB attenuation	50HF-020-SMA	NA	NA
* Suhner RF cable	Sucoflex104	204850/4	NA

- NOTE:**
1. The calibration interval of the above test instruments is 12 months. And the calibrations are traceable to NML/ROC and NIST/USA.
 2. "*" = These equipments are used for the final measurement.

4.6.3 TEST PROCEDURE

- a. The EUT was set up for the maximum peak power with GSM link data modulation. The power was measured with R&S Spectrum Analyzer. All measurements were done at 3 channels, 128, 190 and 251 (low, middle and high operational frequency range.)
- b. The conducted spurious emission used the power splitter via EUT RF power connector between simulation base station and spectrum analyzer. This splitter loss and cable loss are the worst loss 4dB in the transmitted path track.
- c. When the spectrum scanned from 9kHz to 3GHz, it shall be connected to the band reject filter attenuated the carried frequency. The spectrum set RB/VB 1MHz.
- d. When the spectrum scanned from 3kHz to 9GHz, it shall be connected to the high pass filter attenuated the carried frequency. The spectrum set RB/VB 1MHz.

4.6.4 TEST SETUP

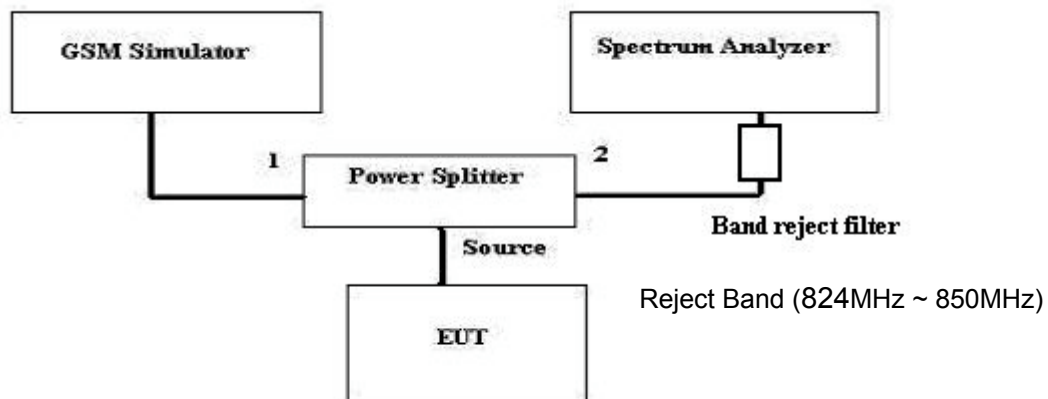

4.6.5 EUT OPERATING CONDITIONS

- a. The EUT makes a phone call to the GSM simulator.
- b. The GSM simulator station system controlled a EUT to export maximum output power under transmission mode and specific channel frequency.



4.6.6 TEST RESULTS

FOR GSM MODE (UP-LINK WITH 1 TIME SLOT)

CH 128: 9kHz ~ 1GHz

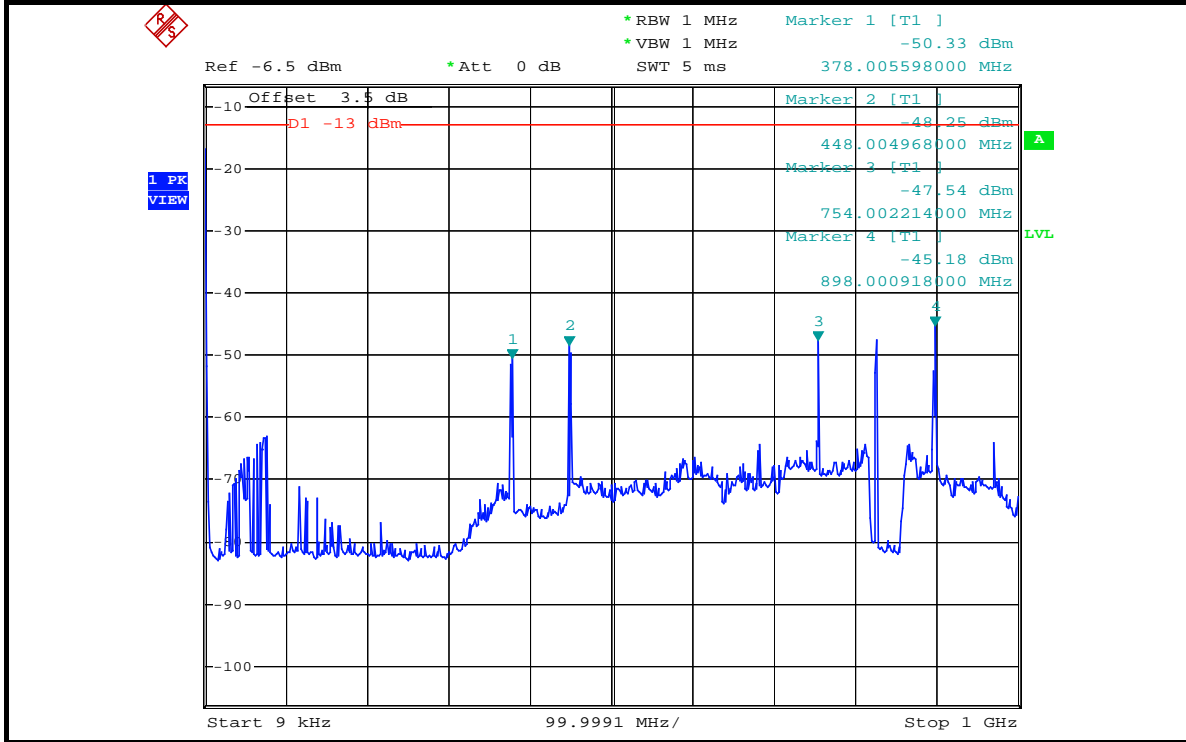

1GHz ~ 4GHz

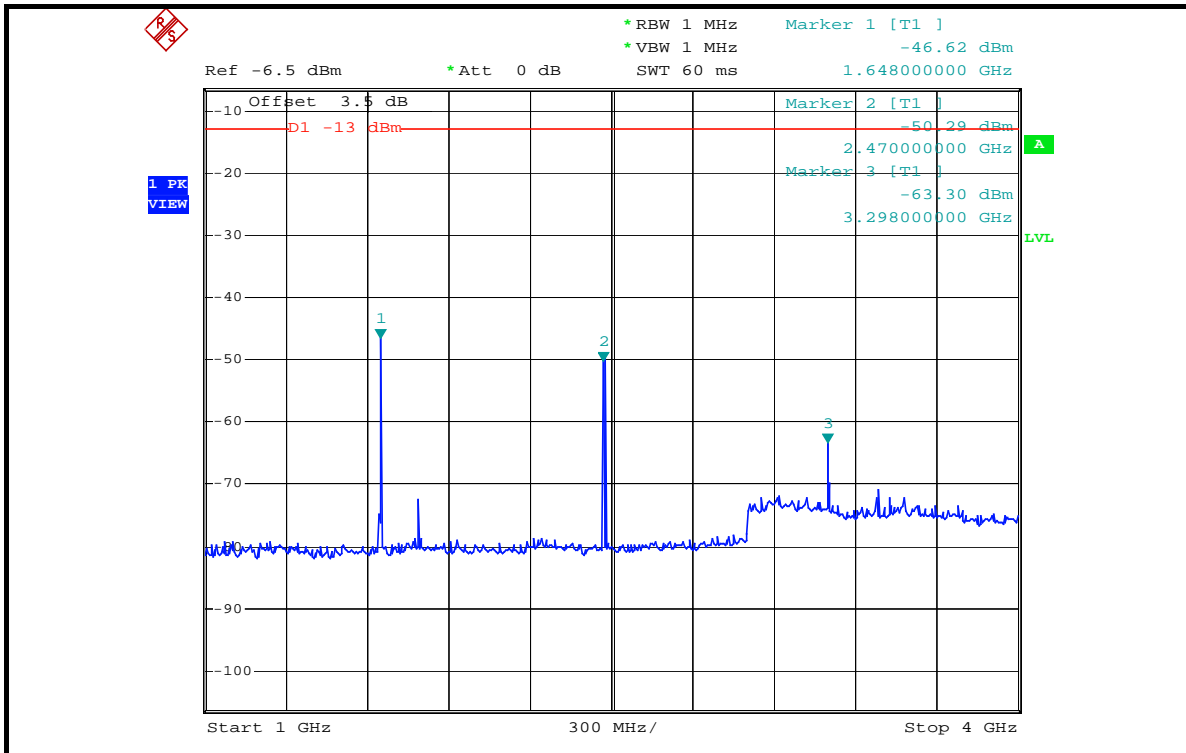



4GHz ~ 7GHz

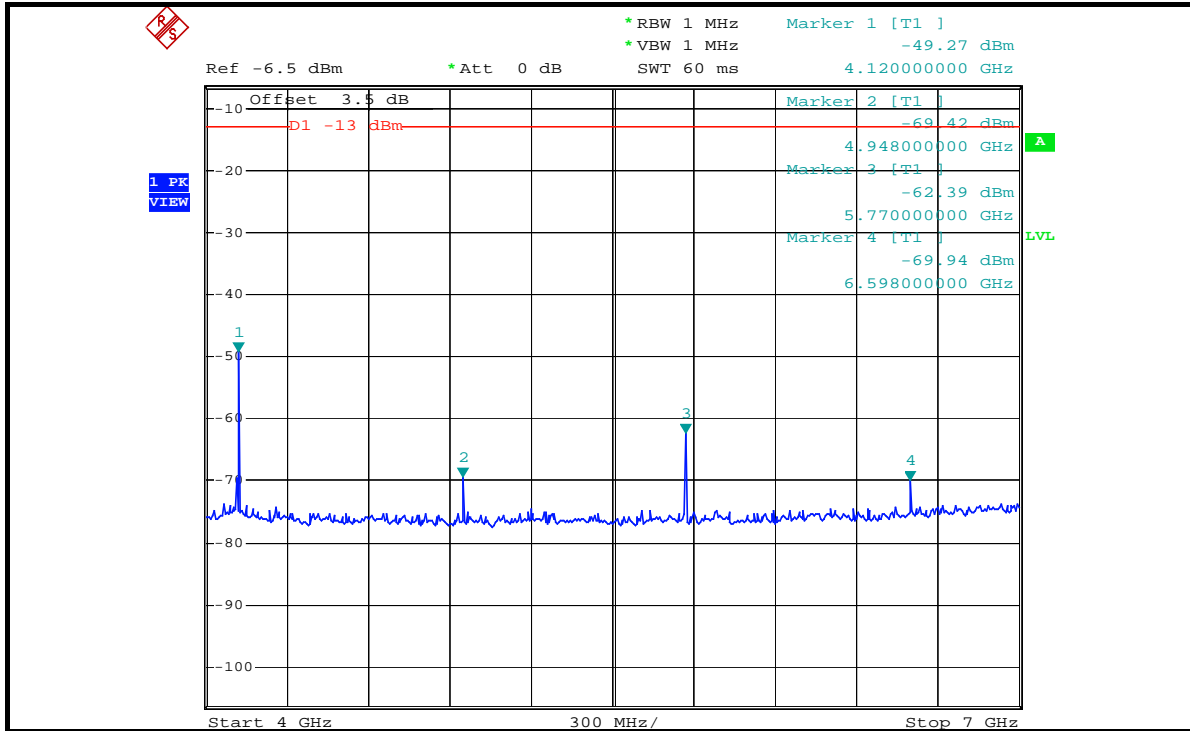

7GHz ~ 9GHz

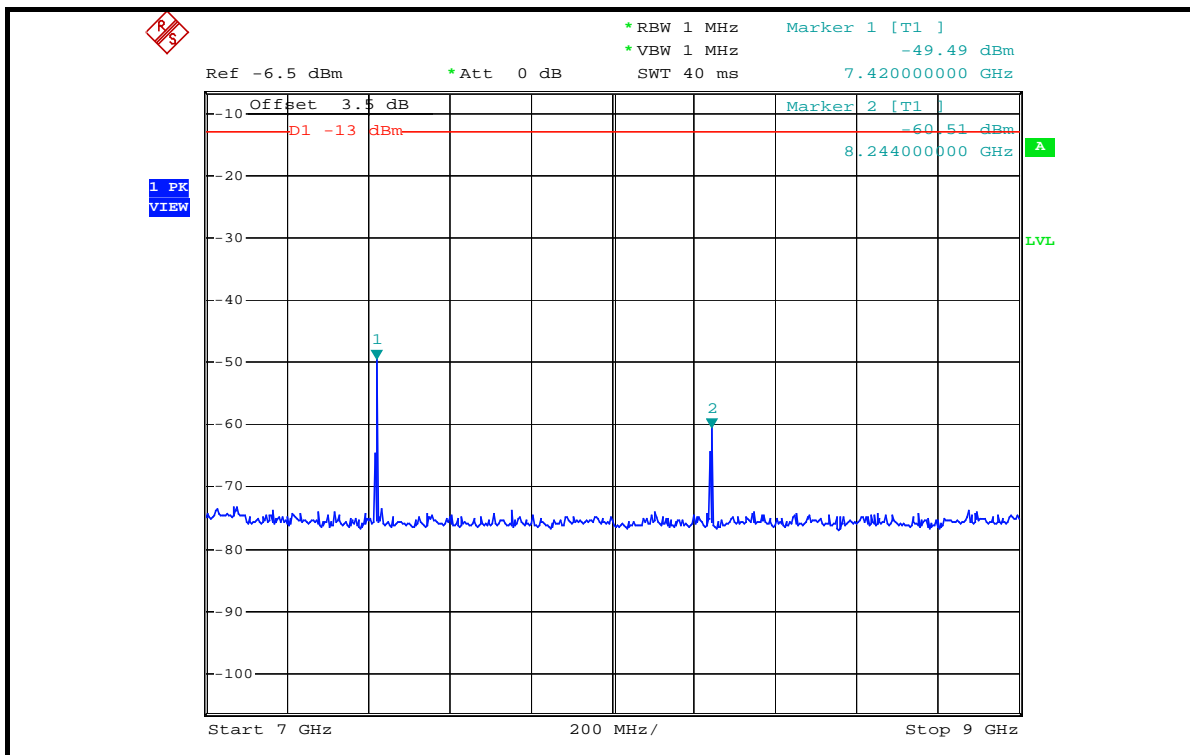



CH 190: 9kHz ~ 1GHz

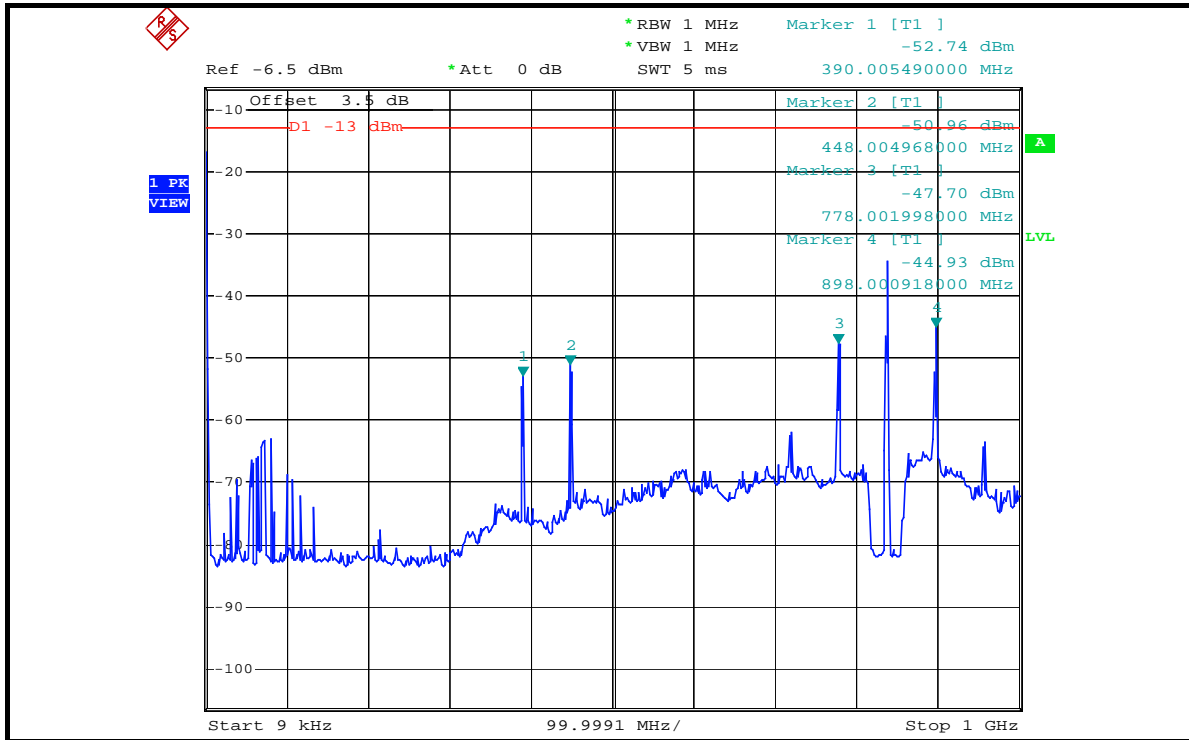

1GHz ~ 4GHz

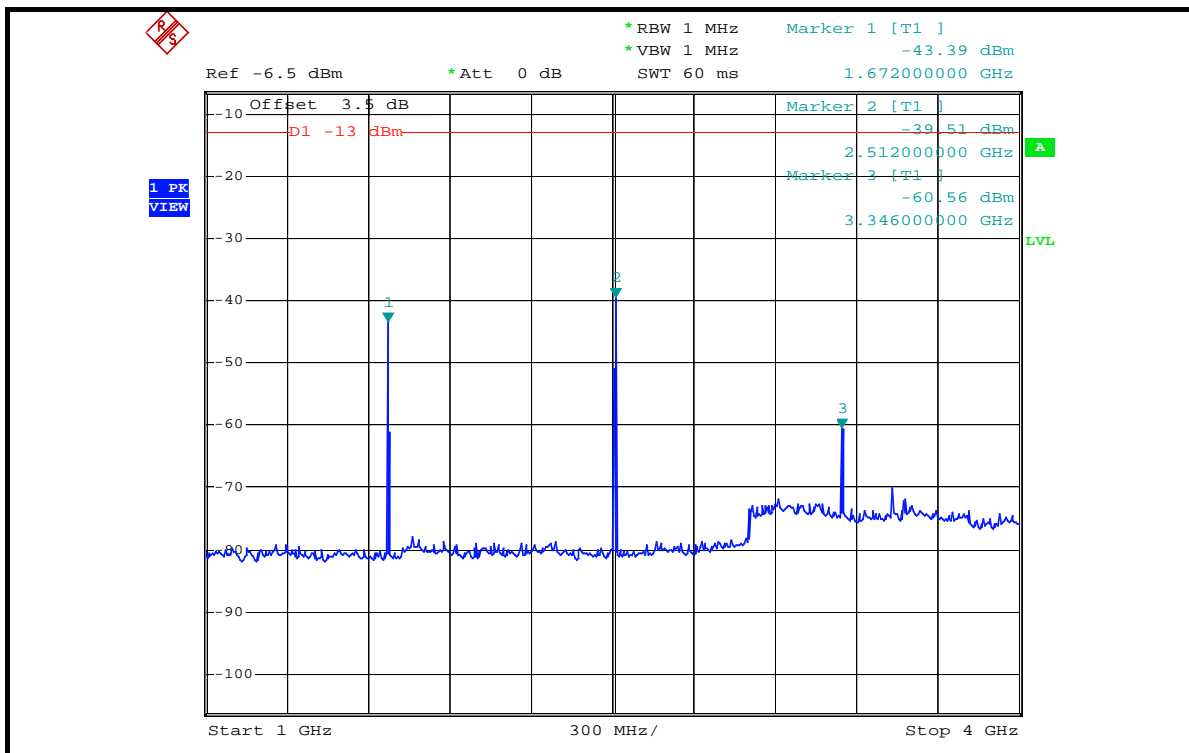



4GHz ~ 7GHz

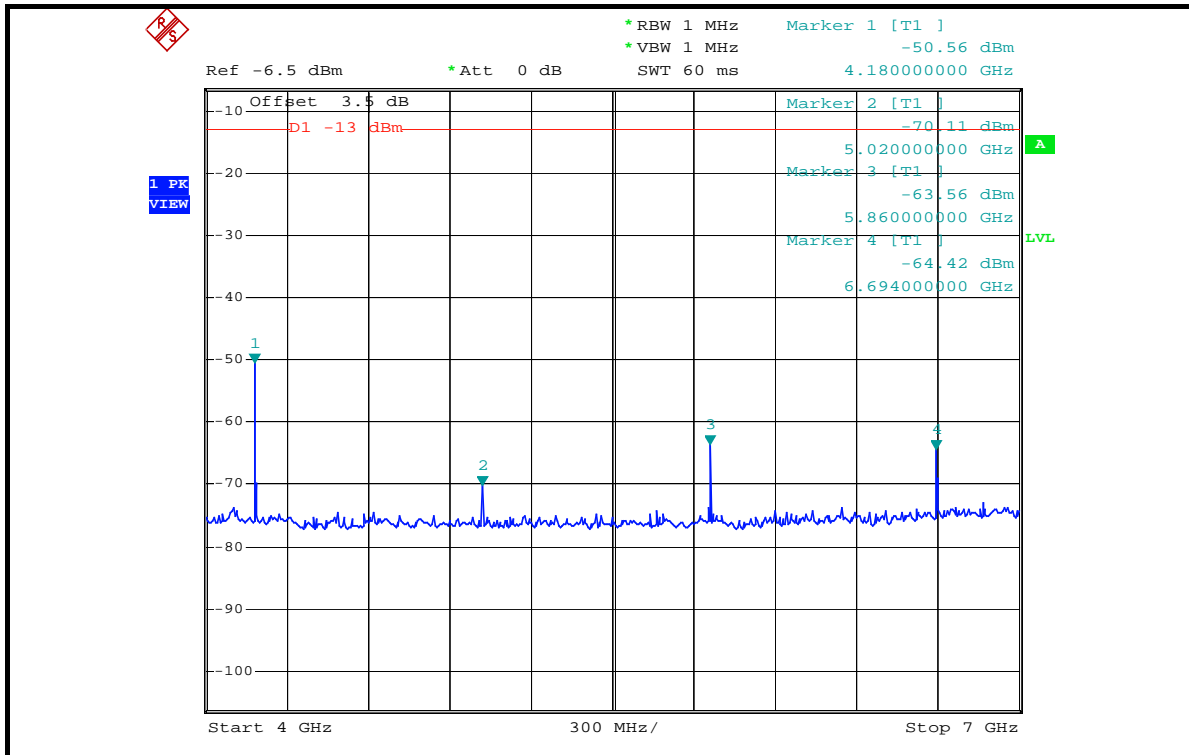

7GHz ~ 9GHz

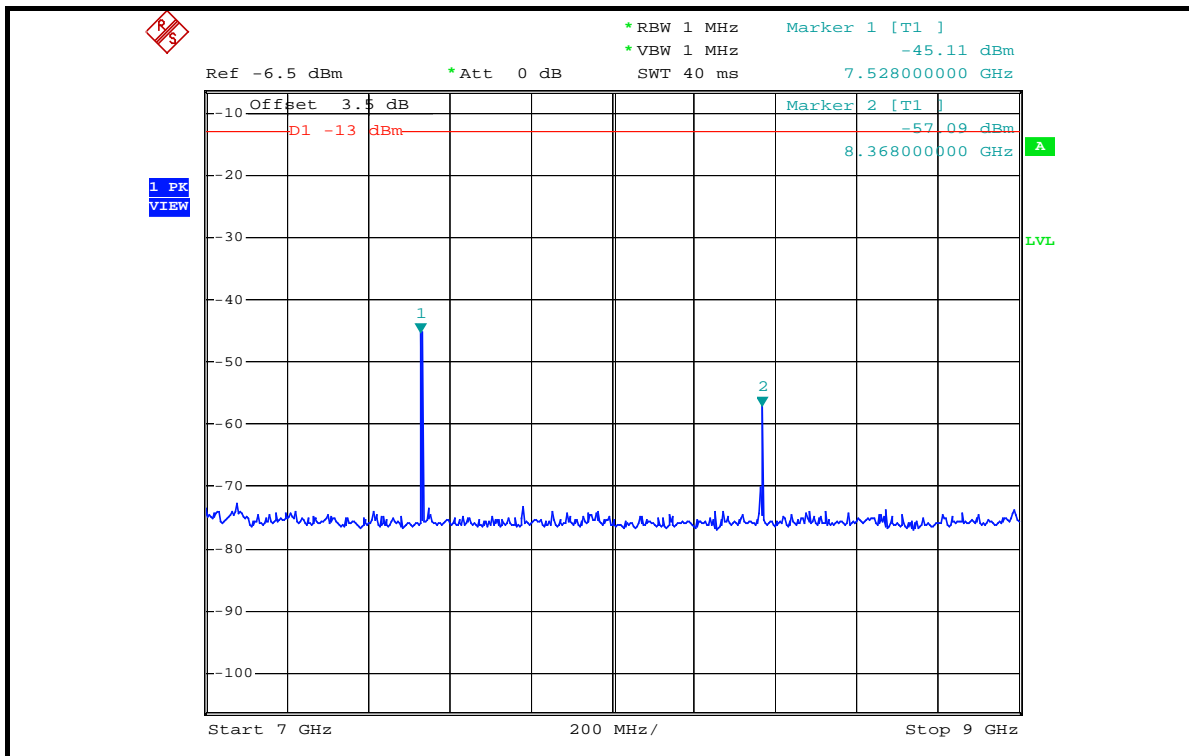



CH 251: 9kHz ~ 1GHz

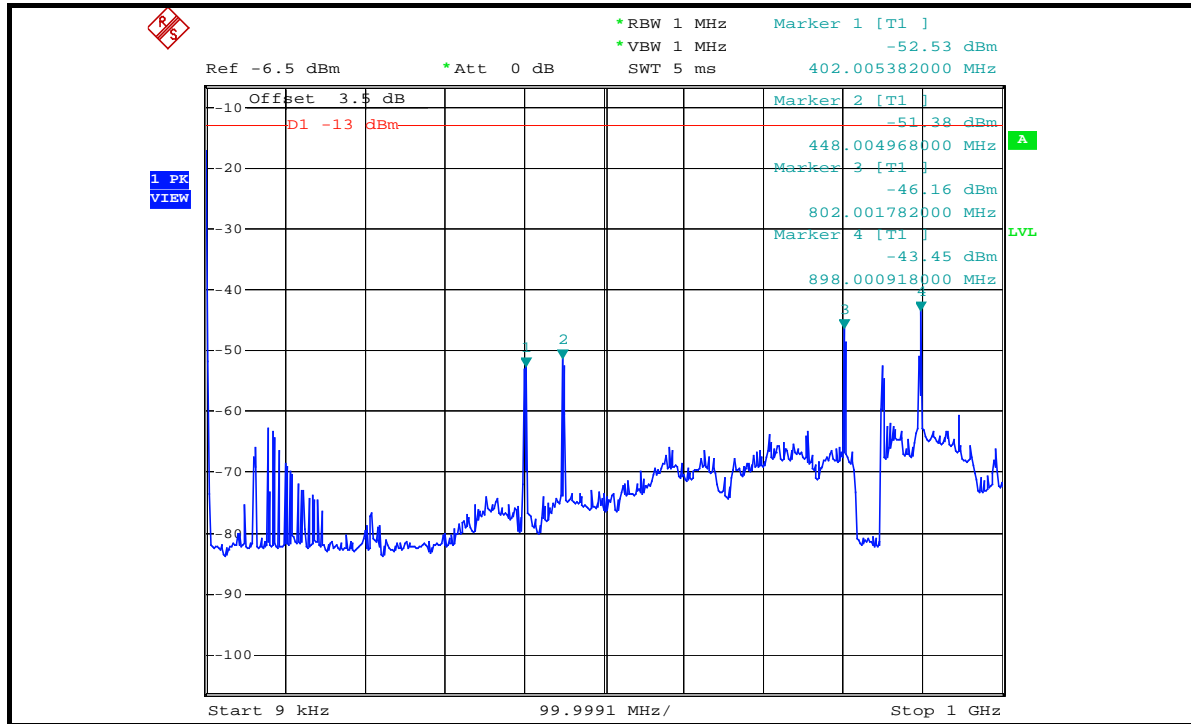

1GHz ~ 4GHz

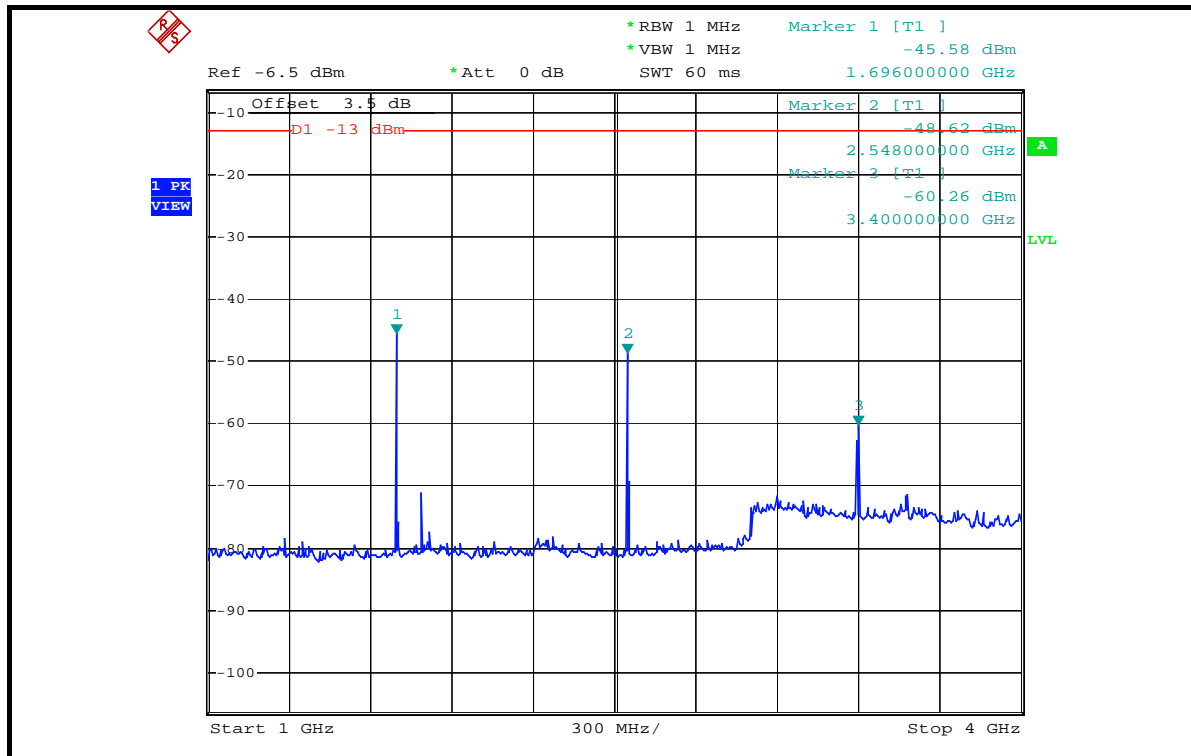



4GHz ~ 7GHz

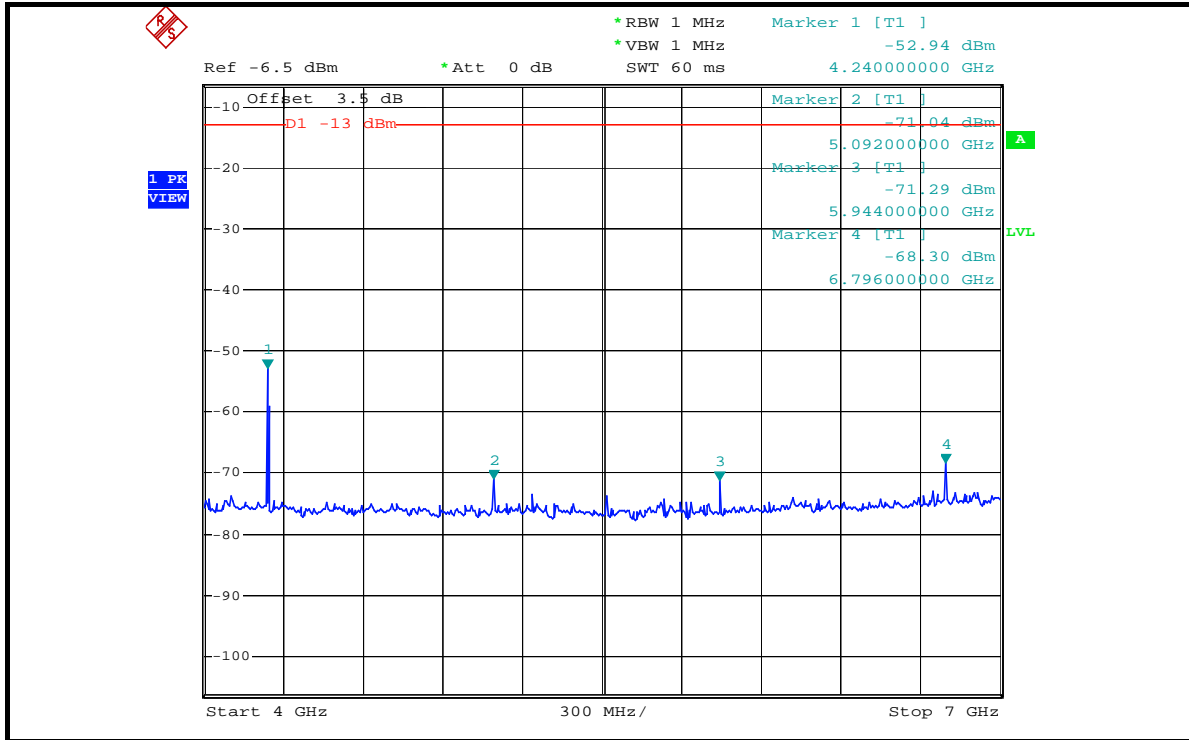

7GHz ~ 9GHz

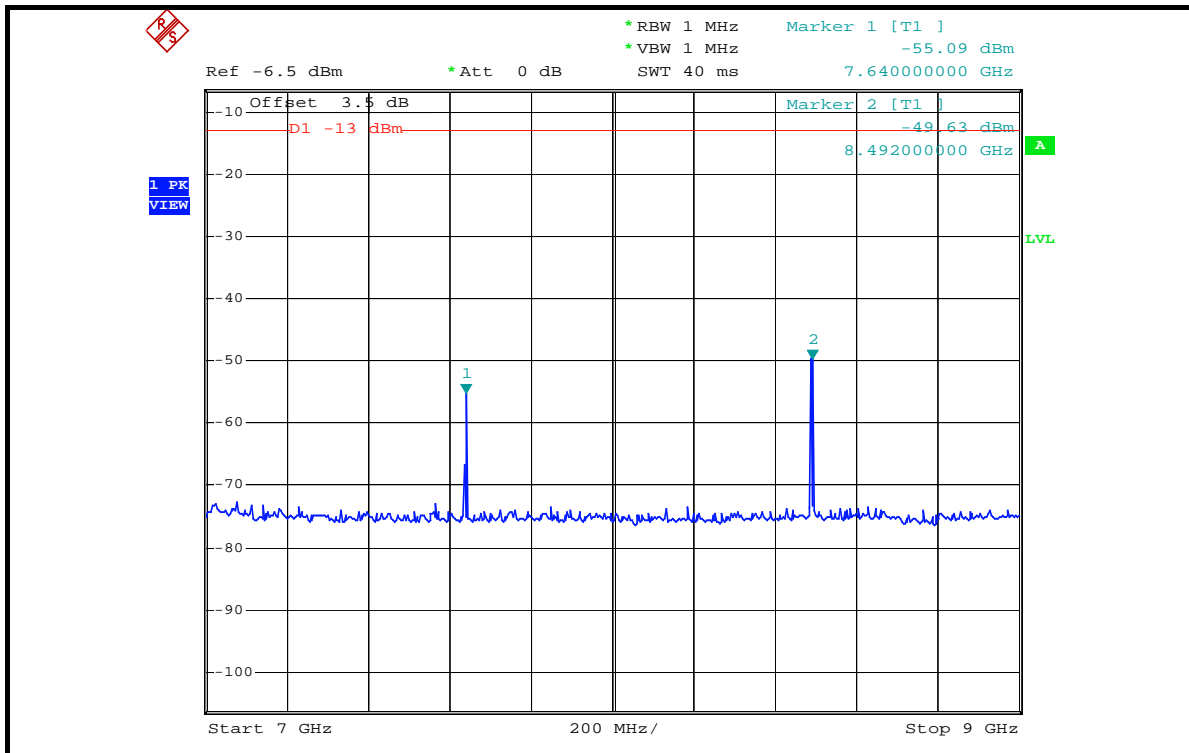



FOR GPRS MODE (UP-LINK WITH 2 TIME SLOTS)

CH 128: 9kHz ~ 1GHz

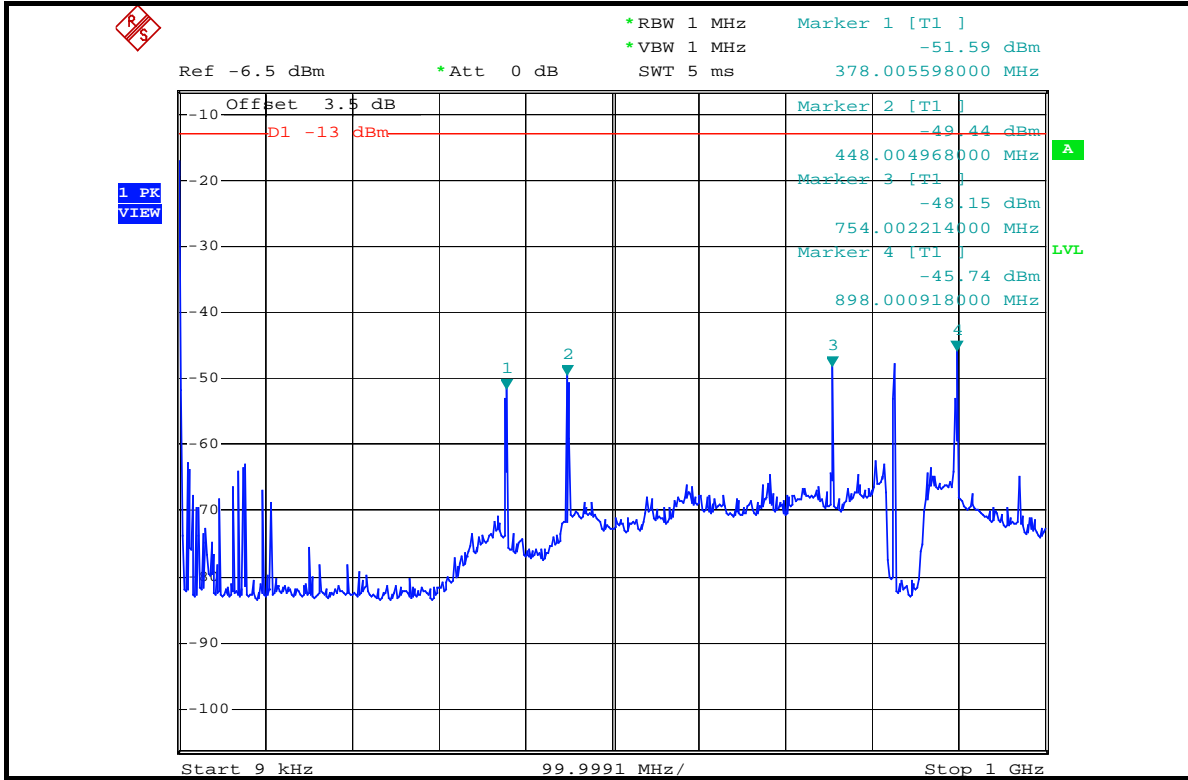

1GHz ~ 4GHz

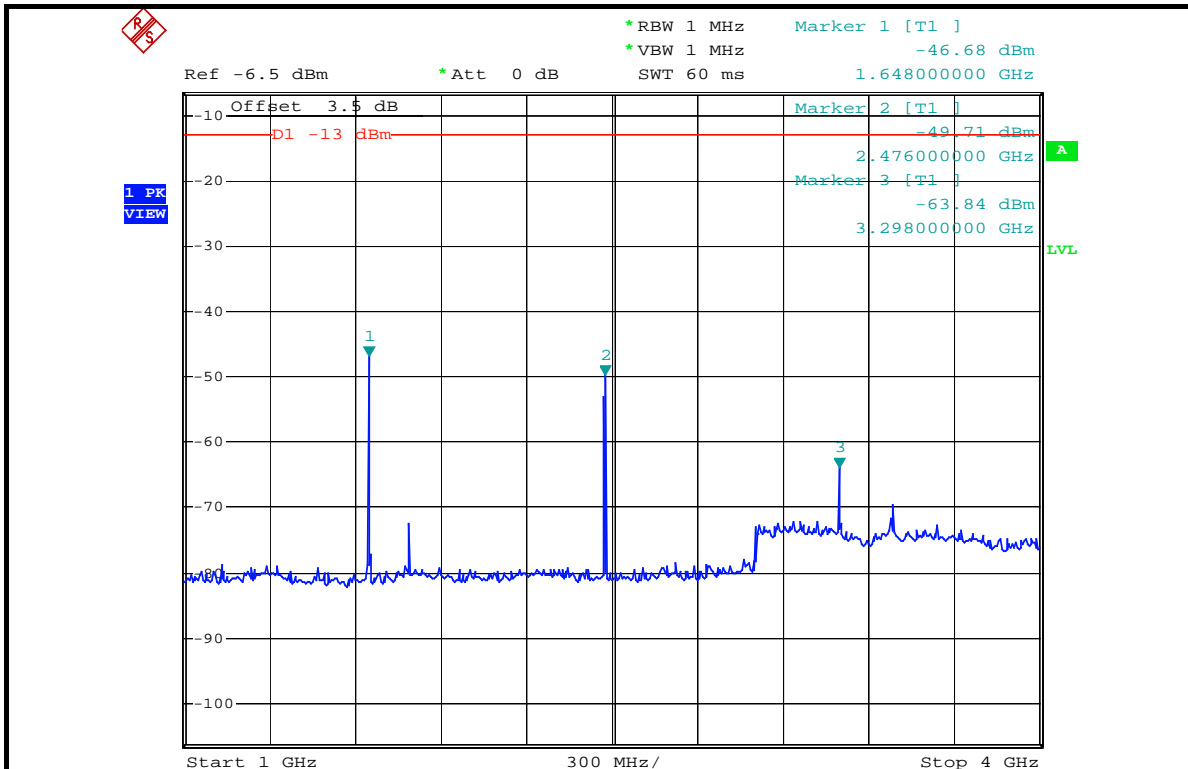



4GHz ~ 7GHz

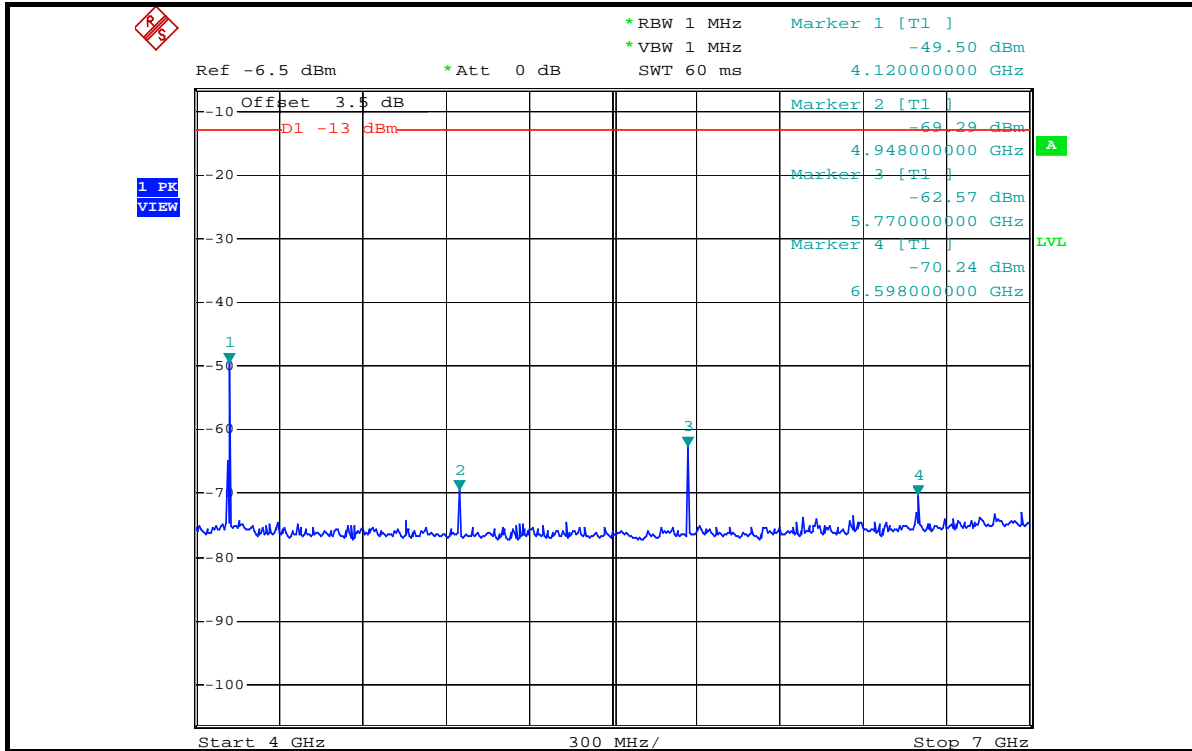

7GHz ~ 9GHz

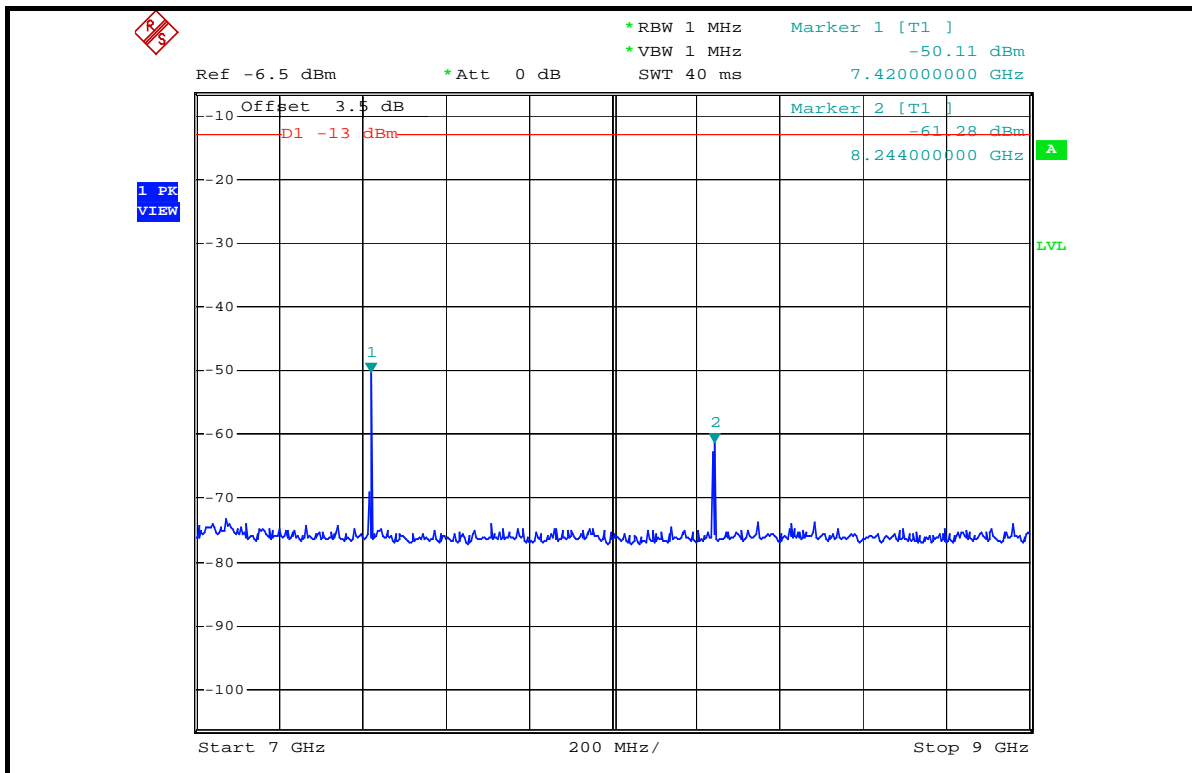



CH 190: 9kHz ~ 1GHz

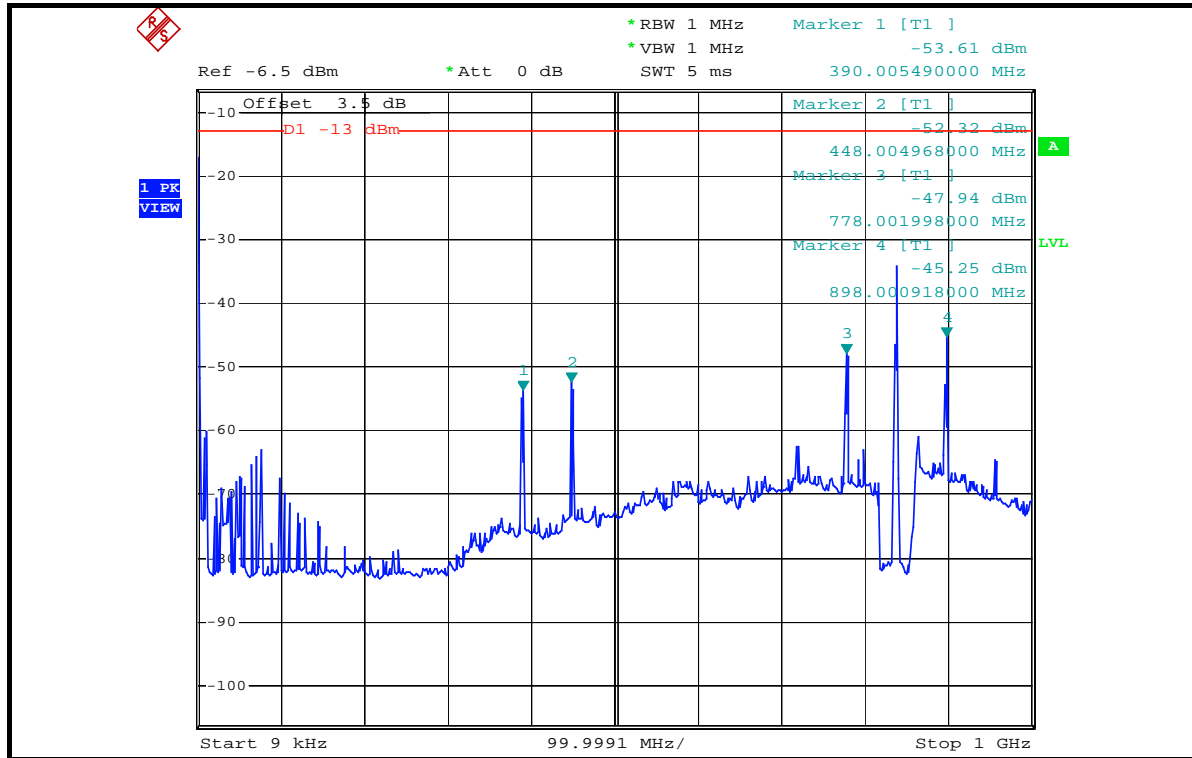

1GHz ~ 4GHz

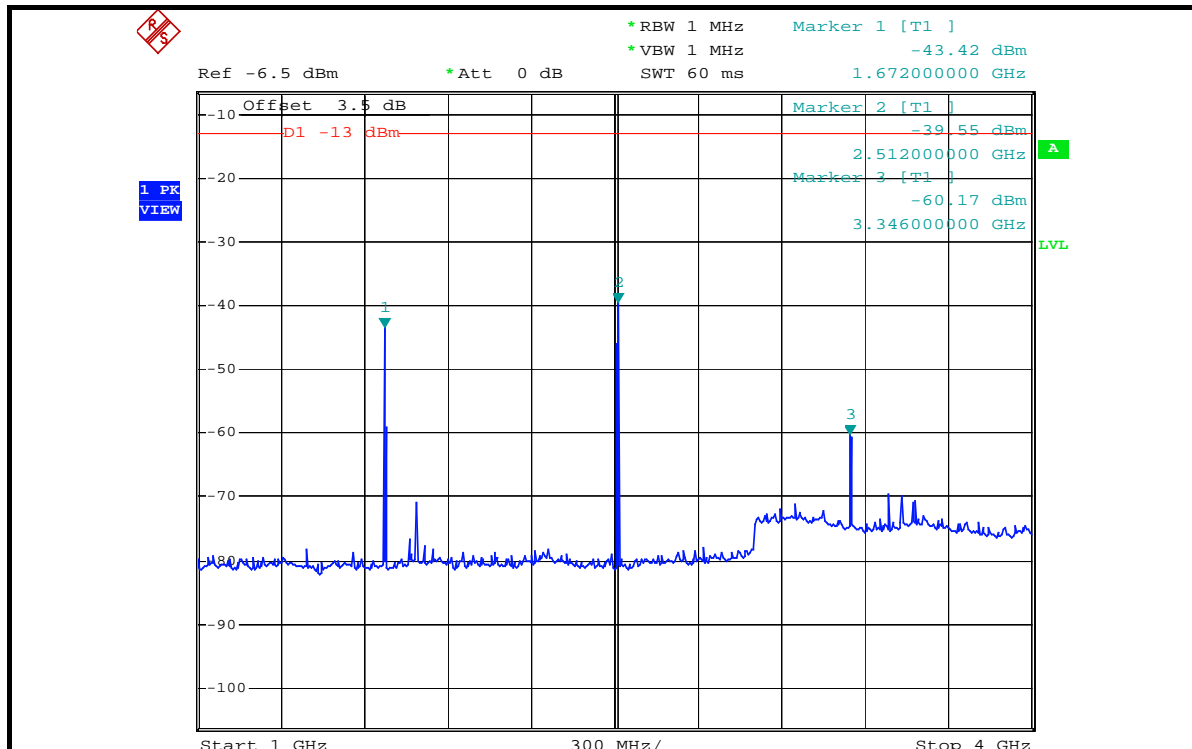



4GHz ~ 7GHz

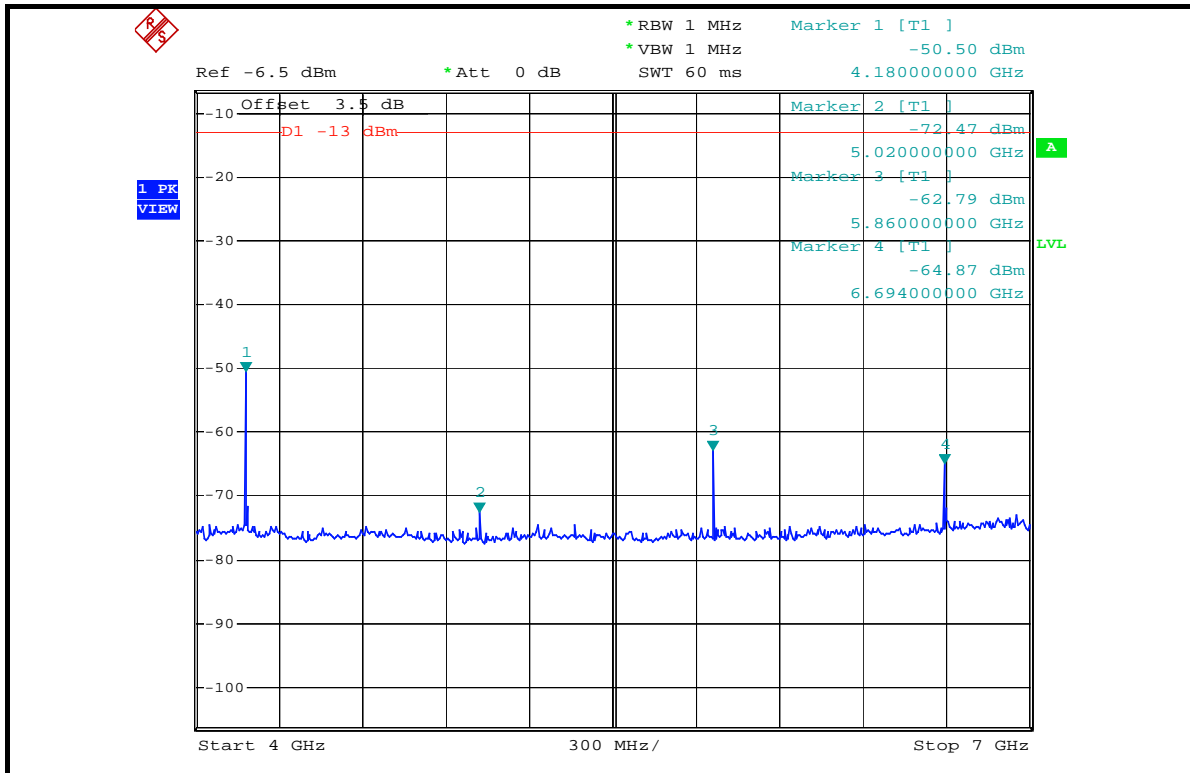

7GHz ~ 9GHz

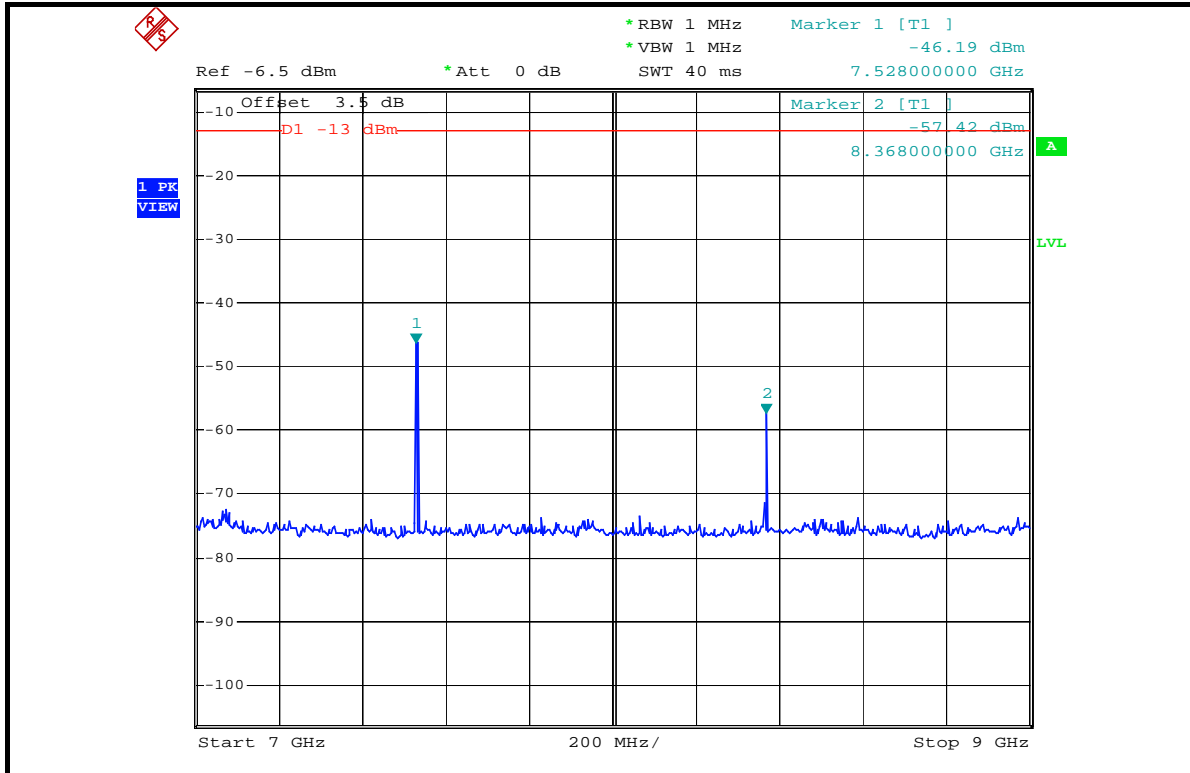



CH 251: 9kHz ~ 1GHz

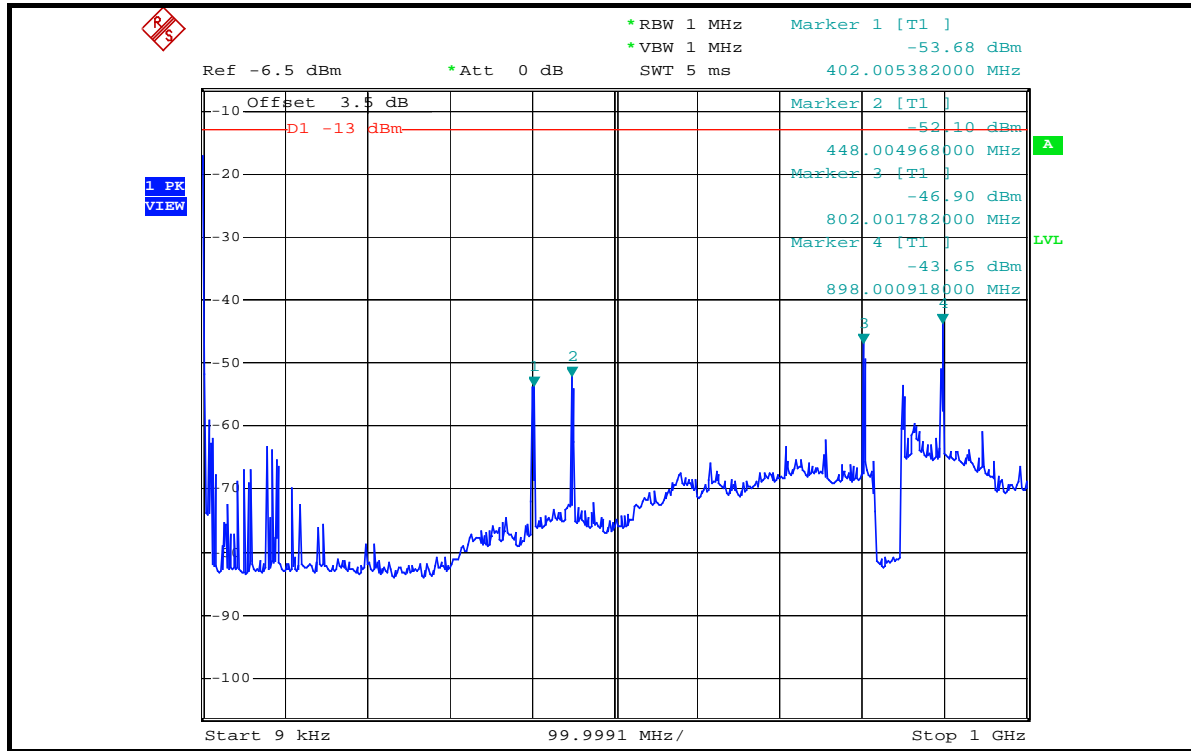

1GHz ~ 4GHz

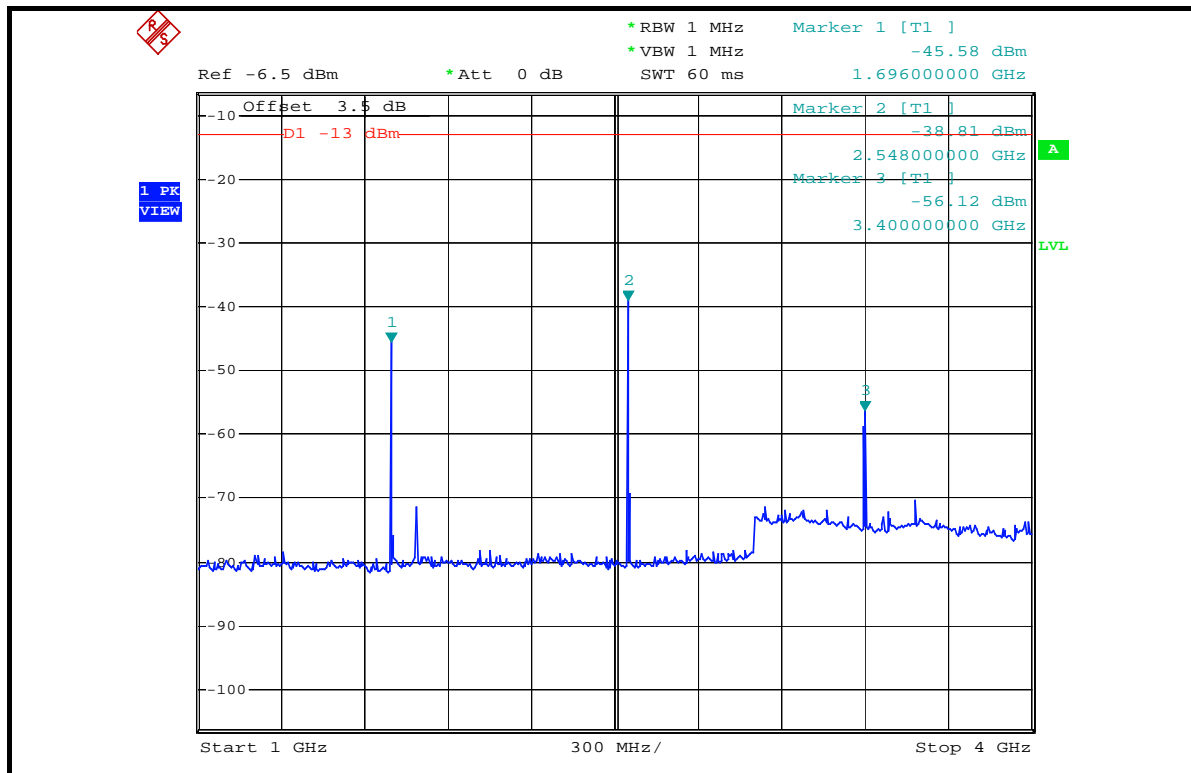



4GHz ~ 7GHz

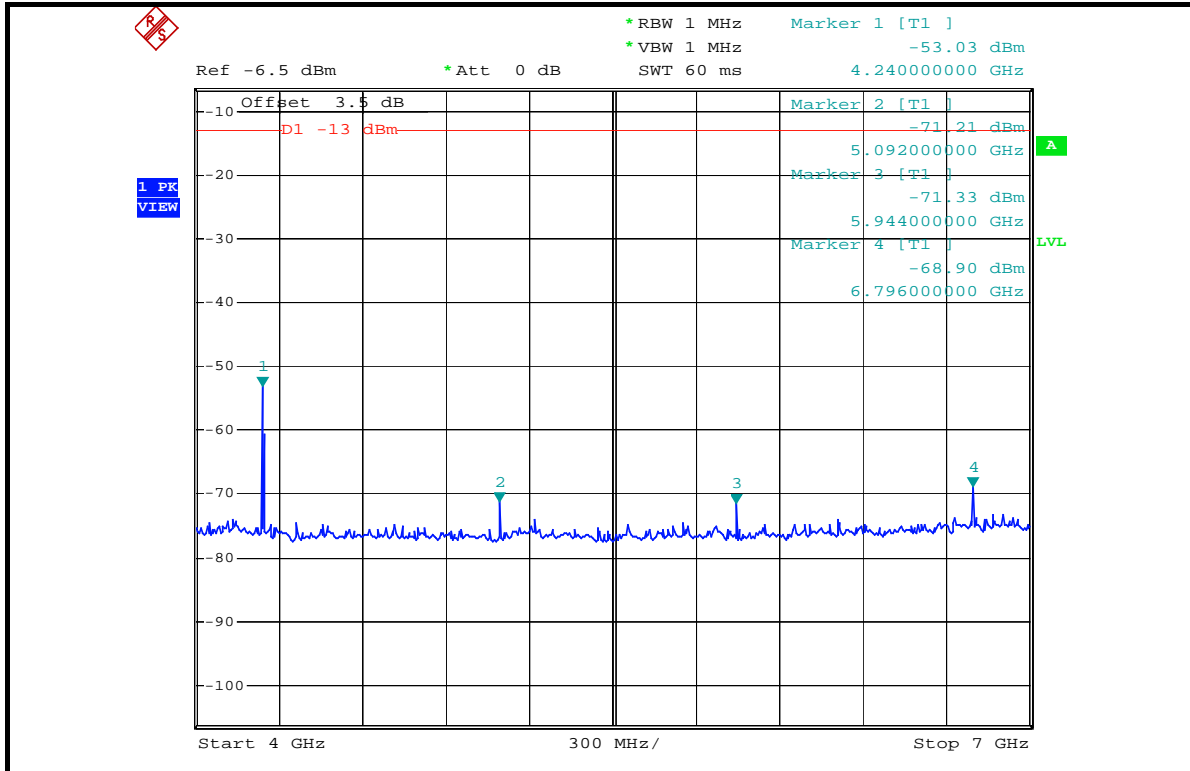

7GHz ~ 9GHz

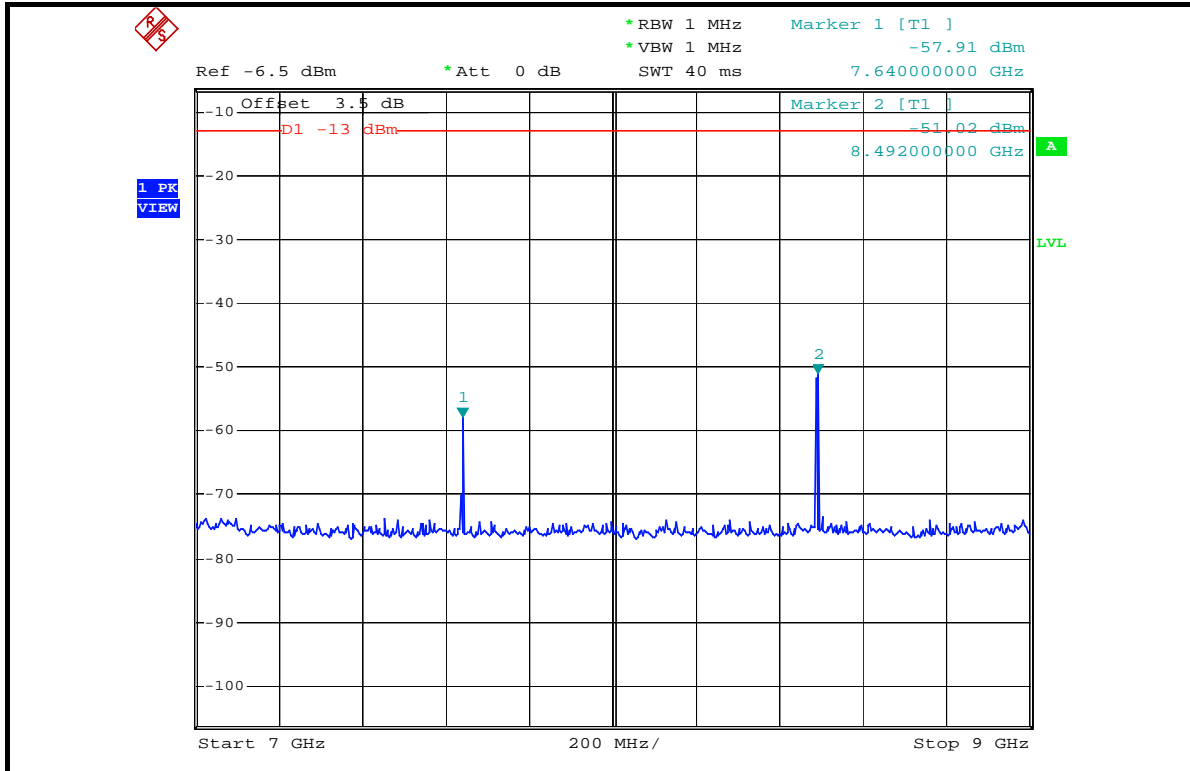



FOR GSM MODE (UP-LINK WITH 1 TIME SLOT)

EUT	Tri Band GSM mobile phone	MODEL	A320a
MODE	TX channel 128	POWER CONTROL LEVEL	5
INPUT POWER (SYSTEM)	120Vac, 60 Hz	DETECTOR FUNCTION	Peak
ENVIRONMENTAL CONDITIONS	26deg. C, 65%RH, 991hPa	TESTED BY	Long Chen

CONDUCTED SPURIOUS EMISSION					
FREQUENCY (MHz)	CORRECTION FACTOR (dB)	S.A READING (dBm)	CONDUCTED LEVEL (dBm)	LIMIT (dBm)	MARGIN (dB)
378.00	2.28	-50.33	-48.05	-13.00	-35.05
448.00	2.29	-48.25	-45.96	-13.00	-32.96
754.00	2.30	-47.54	-45.24	-13.00	-32.24
898.00	2.34	-45.18	-42.84	-13.00	-29.84
1648.00	3.81	-46.62	-42.81	-13.00	-29.81
2476.00	4.02	-50.29	-46.27	-13.00	-33.27
3298.00	4.18	-63.30	-59.12	-13.00	-46.12
4120.00	4.24	-49.27	-45.03	-13.00	-32.03
4948.00	4.29	-69.42	-65.13	-13.00	-52.13
5770.00	4.35	-62.39	-58.04	-13.00	-45.04
6598.00	4.40	-69.94	-65.54	-13.00	-52.54
7420.00	4.46	-49.49	-45.03	-13.00	-32.03
8244.00	4.49	-60.51	-56.02	-13.00	-43.02

REMARKS: 1. Peak Output Power (dBm) = Raw Value (dBm) + Correction Factor (dB).
 2. Correction Factor (dB) = Power Splitter Loss (dB) + Cable Loss (dB).



EUT	Tri Band GSM mobile phone	MODEL	A320a
MODE	TX channel 190	POWER CONTROL LEVEL	5
INPUT POWER (SYSTEM)	120Vac, 60 Hz	DETECTOR FUNCTION	Peak
ENVIRONMENTAL CONDITIONS	26deg. C, 65%RH, 991hPa	TESTED BY	Long Chen

CONDUCTED SPURIOUS EMISSION					
FREQUENCY (MHz)	CORRECTION FACTOR (dB)	S.A READING (dBm)	CONDUCTED LEVEL (dBm)	LIMIT (dBm)	MARGIN (dB)
390.00	2.28	-52.74	-50.46	-13.00	-37.46
448.00	2.29	-50.96	-48.67	-13.00	-35.67
778.00	2.31	-47.70	-45.39	-13.00	-32.39
898.00	2.34	-44.93	-42.59	-13.00	-29.59
1672.00	3.81	-42.39	-38.58	-13.00	-25.58
2512.00	4.02	-39.51	-35.49	-13.00	-22.49
3346.00	4.18	-60.56	-56.38	-13.00	-43.38
4180.00	4.24	-50.56	-46.32	-13.00	-33.32
5020.00	4.30	-70.11	-65.81	-13.00	-52.81
5860.00	4.35	-63.56	-59.21	-13.00	-46.21
6694.00	4.40	-64.42	-60.02	-13.00	-47.02
7528.00	4.46	-45.11	-40.65	-13.00	-27.65
8368.00	4.50	-57.09	-52.59	-13.00	-39.59

REMARKS: 1. Peak Output Power (dBm) = Raw Value (dBm) + Correction Factor (dB).
 2. Correction Factor (dB) = Power Splitter Loss (dB) + Cable Loss (dB).



EUT	Tri Band GSM mobile phone	MODEL	A320a
MODE	TX channel 251	POWER CONTROL LEVEL	5
INPUT POWER (SYSTEM)	120Vac, 60 Hz	DETECTOR FUNCTION	Peak
ENVIRONMENTAL CONDITIONS	26deg. C, 65%RH, 991hPa	TESTED BY	Long Chen

CONDUCTED SPURIOUS EMISSION					
FREQUENCY (MHz)	CORRECTION FACTOR (dB)	S.A READING (dBm)	CONDUCTED LEVEL (dBm)	LIMIT (dBm)	MARGIN (dB)
402.00	2.28	-52.53	-50.25	-13.00	-37.25
448.00	2.29	-51.38	-49.09	-13.00	-36.09
802.00	2.32	-46.16	-43.84	-13.00	-30.84
898.00	2.34	-43.45	-41.11	-13.00	-28.11
1696.00	3.81	-45.58	-41.77	-13.00	-28.77
2548.00	4.02	-48.62	-44.60	-13.00	-31.60
3400.00	4.19	-60.26	-56.07	-13.00	-43.07
4240.00	4.25	-52.94	-48.69	-13.00	-35.69
5092.00	4.30	-71.04	-66.74	-13.00	-53.74
5944.00	4.35	-71.29	-66.94	-13.00	-53.94
6796.00	4.40	-68.30	-63.90	-13.00	-50.90
7640.00	4.47	-55.09	-50.62	-13.00	-37.62
8492.00	4.50	-49.63	-45.13	-13.00	-32.13

REMARKS: 1. Peak Output Power (dBm) = Raw Value (dBm) + Correction Factor (dB).
 2. Correction Factor (dB) = Power Splitter Loss (dB) + Cable Loss (dB).



FOR GPRS MODE (UP-LINK WITH 2 TIME SLOTS)

EUT	Tri Band GSM mobile phone	MODEL	A320a
MODE	TX channel 128	POWER CONTROL LEVEL	5
INPUT POWER (SYSTEM)	120Vac, 60 Hz	DETECTOR FUNCTION	Peak
ENVIRONMENTAL CONDITIONS	26deg. C, 65%RH, 991hPa	TESTED BY	Long Chen

CONDUCTED SPURIOUS EMISSION					
FREQUENCY (MHz)	CORRECTION FACTOR (dB)	S.A READING (dBm)	CONDUCTED LEVEL (dBm)	LIMIT (dBm)	MARGIN (dB)
378.00	2.28	-51.59	-49.31	-13.00	-36.31
448.00	2.29	-49.44	-47.15	-13.00	-34.15
754.00	2.30	-48.15	-45.85	-13.00	-32.85
898.00	2.34	-45.74	-43.40	-13.00	-30.40
1648.00	3.81	-46.68	-42.87	-13.00	-29.87
2476.00	4.02	49.71	53.73	-13.00	66.73
3298.00	4.18	-63.84	-59.66	-13.00	-46.66
4120.00	4.24	-49.50	-45.26	-13.00	-32.26
4948.00	4.29	-69.29	-65.00	-13.00	-52.00
5770.00	4.35	-62.57	-58.22	-13.00	-45.22
6598.00	4.40	-70.24	-65.84	-13.00	-52.84
7420.00	4.46	-50.11	-45.65	-13.00	-32.65
8244.00	4.49	-61.28	-56.79	-13.00	-43.79

REMARKS: 1. Peak Output Power (dBm) = Raw Value (dBm) + Correction Factor (dB).
 2. Correction Factor (dB) = Power Splitter Loss (dB) + Cable Loss (dB).



EUT	Tri Band GSM mobile phone	MODEL	A320a
MODE	TX channel 190	POWER CONTROL LEVEL	5
INPUT POWER (SYSTEM)	120Vac, 60 Hz	DETECTOR FUNCTION	Peak
ENVIRONMENTAL CONDITIONS	26deg. C, 65%RH, 991hPa	TESTED BY	Long Chen

CONDUCTED SPURIOUS EMISSION					
FREQUENCY (MHz)	CORRECTION FACTOR (dB)	S.A READING (dBm)	CONDUCTED LEVEL (dBm)	LIMIT (dBm)	MARGIN (dB)
390.00	2.28	-53.61	-51.33	-13.00	-38.33
448.00	2.29	-52.32	-50.03	-13.00	-37.03
778.00	2.31	-47.94	-45.63	-13.00	-32.63
898.00	2.34	-45.25	-42.91	-13.00	-29.91
1672.00	3.81	-43.42	-39.61	-13.00	-26.61
2512.00	4.02	-39.55	-35.53	-13.00	-22.53
3346.00	4.18	-60.17	-55.99	-13.00	-42.99
4180.00	4.24	-50.50	-46.26	-13.00	-33.26
5020.00	4.30	-72.47	-68.17	-13.00	-55.17
5860.00	4.35	-62.79	-58.44	-13.00	-45.44
6694.00	4.40	-64.87	-60.47	-13.00	-47.47
7528.00	4.46	-46.19	-41.73	-13.00	-28.73
8368.00	4.50	-57.42	-52.92	-13.00	-39.92

REMARKS: 1. Peak Output Power (dBm) = Raw Value (dBm) + Correction Factor (dB).
 2. Correction Factor (dB) = Power Splitter Loss (dB) + Cable Loss (dB).



EUT	Tri Band GSM mobile phone	MODEL	A320a
MODE	TX channel 251	POWER CONTROL LEVEL	5
INPUT POWER (SYSTEM)	120Vac, 60 Hz	DETECTOR FUNCTION	Peak
ENVIRONMENTAL CONDITIONS	26deg. C, 65%RH, 991hPa	TESTED BY	Long Chen

CONDUCTED SPURIOUS EMISSION					
FREQUENCY (MHz)	CORRECTION FACTOR (dB)	S.A READING (dBm)	CONDUCTED LEVEL (dBm)	LIMIT (dBm)	MARGIN (dB)
402.00	2.28	-53.68	-51.40	-13.00	-38.40
448.00	2.29	-52.10	-49.81	-13.00	-36.81
802.00	2.32	-46.9	-44.58	-13.00	-31.58
898.00	2.34	-43.65	-41.31	-13.00	-28.31
1696.00	3.81	-45.58	-41.77	-13.00	-28.77
2548.00	4.02	-38.81	-34.79	-13.00	-21.79
3400.00	4.19	-56.12	-51.93	-13.00	-38.93
4240.00	4.25	-53.03	-48.78	-13.00	-35.78
5092.00	4.30	-71.21	-66.91	-13.00	-53.91
5944.00	4.35	-71.33	-66.98	-13.00	-53.98
6796.00	4.40	-68.9	-64.50	-13.00	-51.50
7640.00	4.47	-57.91	-53.44	-13.00	-40.44
8492.00	4.50	-51.02	-46.52	-13.00	-33.52

REMARKS: 1. Peak Output Power (dBm) = Raw Value (dBm) + Correction Factor (dB).
 2. Correction Factor (dB) = Power Splitter Loss (dB) + Cable Loss (dB).



4.7 RADIATED EMISSION MEASUREMENT (BELOW 1GHz)

4.7.1 LIMITS OF RADIATED EMISSION MEASUREMENT

In the FCC 22.917, On any frequency outside a licensee’s frequency block within USPCS spectrum, the power of any emission shall be attenuated below the transmitter power (P) by at least 43 +10 log (P) dB. The limit translates in the relevant power range (2 to 0.003W). At 2W(Power Control Level 5) the specified minimum attenuation becomes 43dB and the limit of emission equal to –13dBm.

LIMIT (dBm)	EQUIVALENT FIELD STRENGTH AT 3m (dBuV/m) (NOTE)
-13	82.22

NOTE: The following formula is used to convert the equipment radiated power to field strength.

$$E = [1000000\sqrt{(30P)}] / 3 \text{ uV/m, where P is the Watts.}$$



4.7.2 TEST INSTRUMENTS

DESCRIPTION & MANUFACTURER	MODEL NO.	SERIAL NO.	CALIBRATED UNTIL
Test Receiver ROHDE & SCHWARZ	ESI7	100033	May. 19, 2006
Spectrum Analyzer ROHDE & SCHWARZ	FSP40	100025	Dec. 05, 2006
BILOG Antenna SCHWARZBECK	VULB9168	9168-160	Jun. 01, 2006
HORN Antenna SCHWARZBECK	9120D	9120D-408	Jan. 17, 2006
HORN Antenna SCHWARZBECK	BBHA 9170	BBHA9170243	Jan. 23, 2006
Preamplifier Agilent	8447D	2944A10633	Nov. 04, 2006
Preamplifier Agilent	8449B	3008A01964	Oct. 30, 2006
RF signal cable HUBER+SUHNNER	SUCOFLEX 104	218183/4	Jan. 26, 2006
RF signal cable HUBER+SUHNNER	SUCOFLEX 104	218195/4	Jan. 26, 2006
Software ADT.	ADT_Radiated_V5.14	NA	NA
Antenna Tower inn-co GmbH	MA 4000	013303	NA
Antenna Tower Controller inn-co GmbH	CO2000	017303	NA
Turn Table ADT.	TT100.	TT93021703	NA
Turn Table Controller ADT.	SC100.	SC93021703	NA

- NOTE:** 1. The calibration interval of the above test instruments is 12 months and the calibrations are traceable to NML/ROC and NIST/USA.
2. The test was performed in HwaYa Chamber 2.
3. The horn antenna and HP preamplifier (model: 8449B) are used only for the measurement of emission frequency above 1GHz if tested.
4. The VCCI Site Registration No. is R-237.
5. The IC Site Registration No. is IC4924-3.



4.7.3 TEST PROCEDURES

- a. The EUT was placed on the top of a rotating table 0.8 meters above the ground. The table was rotated 360 degrees to determine the position of the highest radiation.
- b. The EUT was set 3 meters away from the receiving antenna, which was mounted on antenna tower and its position at 0.8 m above the ground.
- c. For each suspected emission, the EUT was arranged to its worst case and the rotatable table was turned from 0 degrees to 360 degrees to find the maximum reading and recorded the value.
- d. Repeat step a ~ c for horizontal polarization.

NOTE: The resolution bandwidth of spectrum analyzer is 1 MHz and the video bandwidth is 3 MHz for spurious emission test.

4.7.4 DEVIATION FROM TEST STANDARD

No deviation

4.7.5 TEST SETUP

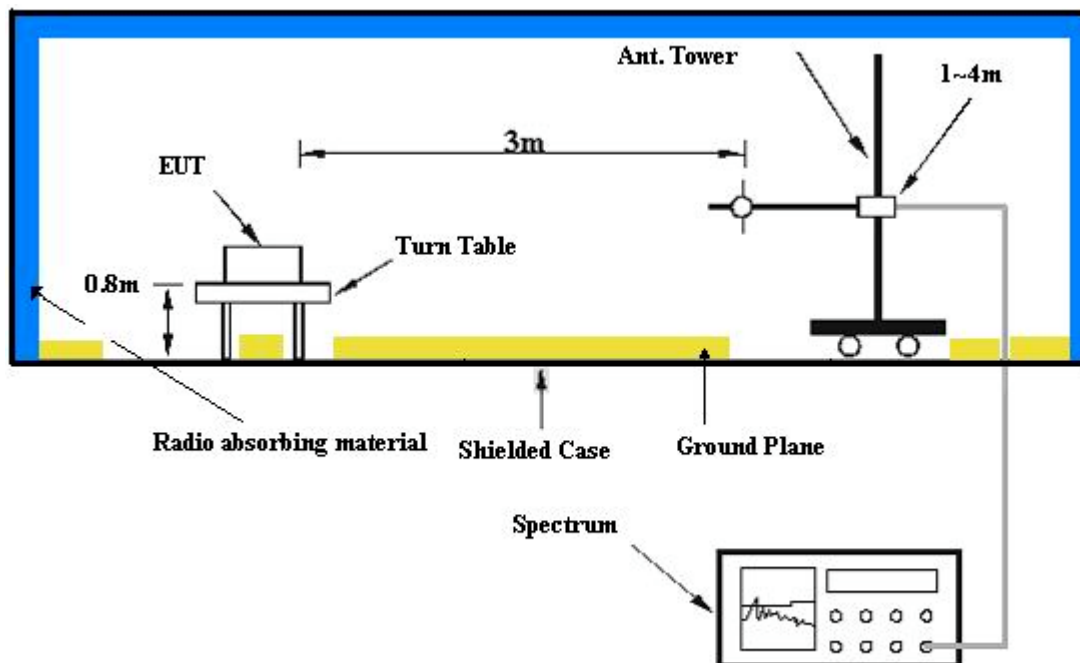

For the actual test configuration, please refer to the related item – Photographs of the Test Configuration.

4.7.6 EUT OPERATING CONDITIONS

- The EUT makes a phone call to the GSM simulator.
- The GSM simulator station system controlled an EUT to export maximum output power under transmission mode and specific channel frequency.



4.7.7 TEST RESULTS

EUT	Tri Band GSM mobile phone	MODEL	A320a
MODE	TX channel 128	DETECTOR FUNCTION	Quasi-Peak
FREQUENCY RANGE	Below 1000 MHz	INPUT POWER (SYSTEM)	120Vac, 60 Hz
ENVIRONMENTAL CONDITIONS	25deg. C, 65%RH, 991hPa	TESTED BY	Morgan Chen

ANTENNA POLARITY & TEST DISTANCE: HORIZONTAL AT 3 M								
No.	Freq. (MHz)	Emission Level (dBuV/m)	Limit (dBuV/m)	Margin (dB)	Antenna Height (m)	Table Angle (Degree)	Raw Value (dBuV)	Correction Factor (dB/m)
1	103.87	23.64 QP	82.22	-58.58	1.25 H	40	13.92	9.72
2	154.41	22.77 QP	82.22	-59.45	1.00 H	16	9.11	13.66
3	234.11	22.90 QP	82.22	-59.32	1.25 H	25	10.72	12.18
4	778.40	37.37 QP	82.22	-44.85	1.00 H	28	11.25	26.11
5	803.67	24.60 QP	82.22	-57.62	1.00 H	37	-1.71	26.31
6	836.71	51.86 QP	82.22	-30.36	1.00 H	345	25.24	26.62
7	883.37	64.86 QP	82.22	-17.36	1.00 H	34	37.85	27.01

ANTENNA POLARITY & TEST DISTANCE: VERTICAL AT 3 M								
No.	Freq. (MHz)	Emission Level (dBuV/m)	Limit (dBuV/m)	Margin (dB)	Antenna Height (m)	Table Angle (Degree)	Raw Value (dBuV)	Correction Factor (dB/m)
1	37.78	27.00 QP	82.22	-55.22	1.00 V	256	12.96	14.04
2	92.20	25.19 QP	82.22	-57.03	1.00 V	352	15.82	9.37
3	103.87	27.22 QP	82.22	-55.00	1.00 V	256	17.49	9.72
4	300.20	26.86 QP	82.22	-55.36	1.00 V	271	10.99	15.87
5	778.40	39.74 QP	82.22	-42.48	1.00 V	316	13.62	26.11
6	803.67	25.28 QP	82.22	-56.94	1.00 V	343	-1.03	26.31
7	836.71	59.41 QP	82.22	-22.81	1.00 V	28	32.79	26.62
8	881.42	61.41 QP	82.22	-20.81	1.00 V	181	34.41	26.99
9	896.97	42.54 QP	82.22	-39.68	1.00 V	142	15.42	27.12

NOTE:

1. Emission level (dBuV/m) = Raw Value (dBuV) + Correction Factor (dB).
2. Correction Factor (dB/m) = Antenna Factor (dB/m) + Cable Factor (dB).
3. The other emission levels were very low against the limit.
4. Margin value = Emission level – Limit value.
5. This is valid for all 3 channels.



4.8 EFFECTIVE RADIATED POWER MEASUREMENT (ABOVE 1GHz)

4.8.1 LIMITS OF RADIATED EMISSION MEASUREMENT

In the FCC 22.917 (a), On any frequency outside a licensee's frequency block within GSM spectrum, the power of any emission shall be attenuated below the transmitter power (P) by at least $43 + 10 \log (P)$ dB. The limit translates in the relevant power range (2 to 0.003W). At 2W (Power Control Level 5) the specified minimum attenuation becomes 43dB and the limit of emission equal to -13dBm .



4.8.2 TEST INSTRUMENTS

DESCRIPTION & MANUFACTURER	MODEL NO.	SERIAL NO.	CALIBRATED UNTIL
Test Receiver ROHDE & SCHWARZ	ESI7	100033	May. 19, 2006
Spectrum Analyzer ROHDE & SCHWARZ	FSP40	100025	Dec. 05, 2006
BILOG Antenna SCHWARZBECK	VULB9168	9168-160	Jun. 01, 2006
HORN Antenna SCHWARZBECK	9120D	9120D-408	Jan. 17, 2006
HORN Antenna SCHWARZBECK	BBHA 9170	BBHA9170243	Jan. 23, 2006
Preamplifier Agilent	8447D	2944A10633	Nov. 04, 2006
Preamplifier Agilent	8449B	3008A01964	Oct. 30, 2006
RF signal cable HUBER+SUHNNER	SUCOFLEX 104	218183/4	Jan. 26, 2006
RF signal cable HUBER+SUHNNER	SUCOFLEX 104	218195/4	Jan. 26, 2006
Software ADT.	ADT_Radiated_V5.14	NA	NA
Antenna Tower inn-co GmbH	MA 4000	013303	NA
Antenna Tower Controller inn-co GmbH	CO2000	017303	NA
Turn Table ADT.	TT100.	TT93021703	NA
Turn Table Controller ADT.	SC100.	SC93021703	NA
AGILENT SIGNAL GENERATOR	E8257C	MY43320668	Dec. 07, 2006

- NOTE:**
1. The calibration interval of the above test instruments is 12 months and the calibrations are traceable to NML/ROC and NIST/USA.
 2. The test was performed in HwaYa Chamber 2.
 3. The horn antenna and HP preamplifier (model: 8449B) are used only for the measurement of emission frequency above 1GHz if tested.
 4. The VCCI Site Registration No. is R-237.
 5. The IC Site Registration No. is IC4924-3.



4.8.3 TEST PROCEDURES

- a. The EUT was placed on the top of a rotating table 0.8 meters above the ground. The table was rotated 360 degrees to determine the position of the highest radiation.
- b. The EUT was set 3 meters away from the receiving antenna, which was mounted on antenna tower and its position at 0.8 m above the ground.
- c. For each suspected emission, the EUT was arranged to its worst case and the rotatable table was turned from 0 degrees to 360 degrees to find the maximum reading and recorded the value.
- d. The EUT is replaced by a horn antenna connected to a signal generator tuned to the frequency of emission.
- e. The signal generator level has to be adjusted to have the same emission nature.
- f. The radiated power can be calculated via the factor and antenna gain.
- g. Repeat step a ~ f for horizontal polarization.

NOTE: The resolution bandwidth of spectrum analyzer is 1 MHz and the video bandwidth is 3 MHz for spurious emission test.

4.8.4 DEVIATION FROM TEST STANDARD

No deviation

4.8.5 TEST SETUP

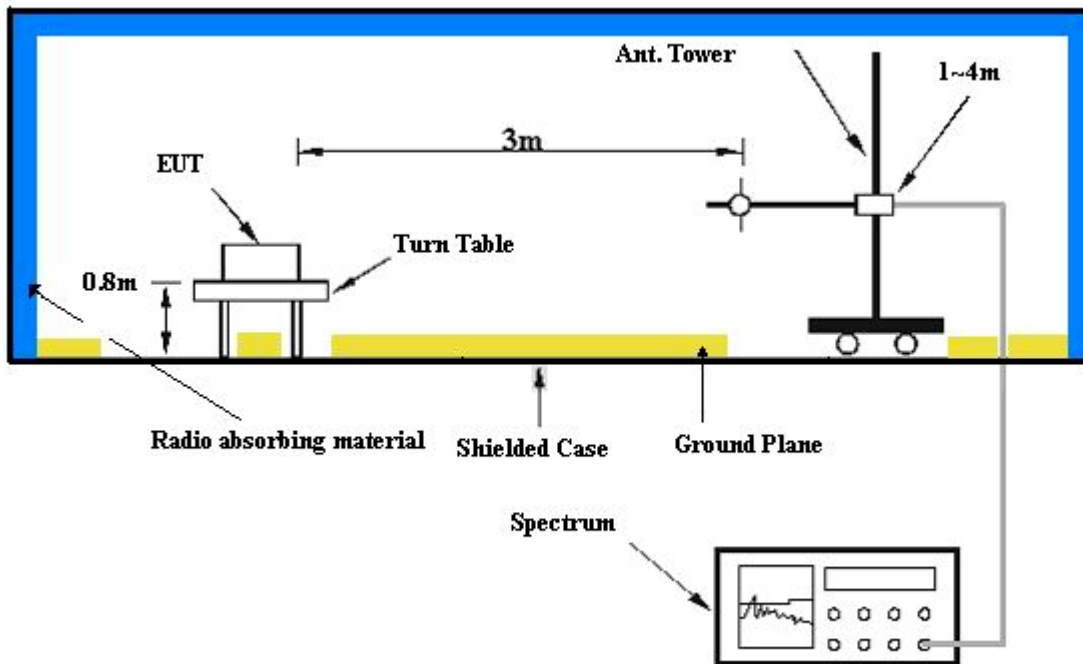

For the actual test configuration, please refer to the related item – Photographs of the Test Configuration.

4.8.6 EUT OPERATING CONDITIONS

- a. The EUT makes a phone call to the GSM simulator.
- b. The GSM simulator station system controlled an EUT to export maximum output power under transmission mode and specific channel frequency.



4.8.7 TEST RESULTS

EUT	Tri Band GSM mobile phone	MODEL	A320a
MODE	TX channel 128	FREQUENCY RANGE	Above 1000 MHz
INPUT POWER (SYSTEM)	120Vac, 60 Hz	ENVIRONMENTAL CONDITIONS	25deg. C, 65%RH, 991hPa
TESTED BY	Morgan Chen		

ANTENNA POLARITY & TEST DISTANCE: HORIZONTAL AT 3 M						
No.	Freq. (MHz)	Emission Level (dBUV)	Limit (dBm)	S.G Power Value (dBm)	Correction Factor (dB)	Power Value (dBm)
1	1648.00	61.25	-13.00	-44.10	10.12	-33.98
2	2472.00	48.35	-13.00	-58.37	11.49	-46.88
3	3296.00	56.88	-13.00	-50.85	12.50	-38.35
4	4121.00	57.33	-13.00	-51.65	13.75	-37.90
5	4945.00	50.15	-13.00	-58.99	13.91	-45.08
6	5769.00	51.35	-13.00	-58.27	14.39	-43.88

ANTENNA POLARITY & TEST DISTANCE: VERTICAL AT 3 M						
No.	Freq. (MHz)	Emission Level (dBUV)	Limit (dBm)	S.G Power Value (dBm)	Correction Factor (dB)	Power Value (dBm)
1	1648.00	65.16	-13.00	-40.19	10.12	-30.07
2	2472.00	52.62	-13.00	-54.10	11.49	-42.61
3	3296.00	60.22	-13.00	-47.51	12.50	-35.01
4	4121.00	61.13	-13.00	-47.85	13.75	-34.10
5	4945.00	53.85	-13.00	-55.29	13.91	-41.38
6	5769.00	55.43	-13.00	-54.19	14.39	-39.80

NOTE: Power Value (dBum) = S.G Power Value (dBm) + Correction Factor (dB).



EUT	Tri Band GSM mobile phone	MODEL	A320a
MODE	TX channel 190	FREQUENCY RANGE	Above 1000 MHz
INPUT POWER (SYSTEM)	120Vac, 60 Hz	ENVIRONMENTAL CONDITIONS	25deg. C, 65%RH, 991hPa
TESTED BY	Morgan Chen		

ANTENNA POLARITY & TEST DISTANCE: HORIZONTAL AT 3 M						
No.	Freq. (MHz)	Emission Level (dBuV)	Limit (dBm)	S.G Power Value (dBm)	Correction Factor (dB)	Power Value (dBm)
1	1673.00	65.35	-13.00	-40.00	10.12	-29.88
2	2510.00	54.35	-13.00	-52.37	11.49	-40.88
3	3346.00	64.08	-13.00	-43.65	12.50	-31.15
4	4183.00	63.55	-13.00	-45.38	13.70	-31.68
5	5019.00	55.08	-13.00	-54.04	13.89	-40.15
6	5856.00	56.32	-13.00	-53.30	14.39	-38.91

ANTENNA POLARITY & TEST DISTANCE: VERTICAL AT 3 M						
No.	Freq. (MHz)	Emission Level (dBuV)	Limit (dBm)	S.G Power Value (dBm)	Correction Factor (dB)	Power Value (dBm)
1	1673.00	68.78	-13.00	-36.57	10.12	-26.45
2	2510.00	67.31	-13.00	-39.41	11.49	-27.92
3	3346.00	65.31	-13.00	-42.42	12.50	-29.92
4	4183.00	66.12	-13.00	-42.81	13.70	-29.11
5	5019.00	58.33	-13.00	-50.79	13.89	-36.90
6	5856.00	60.15	-13.00	-49.47	14.39	-35.08

NOTE: Power Value (dBum) = S.G Power Value (dBm) + Correction Factor (dB).



EUT	Tri Band GSM mobile phone	MODEL	A320a
MODE	TX channel 251	FREQUENCY RANGE	Above 1000 MHz
INPUT POWER (SYSTEM)	120Vac, 60 Hz	ENVIRONMENTAL CONDITIONS	25deg. C, 65%RH, 991hPa
TESTED BY	Morgan Chen		

ANTENNA POLARITY & TEST DISTANCE: HORIZONTAL AT 3 M						
No.	Freq. (MHz)	Emission Level (dBuV)	Limit (dBm)	S.G Power Value (dBm)	Correction Factor (dB)	Power Value (dBm)
1	1698.00	64.22	-13.00	-41.18	10.17	-31.01
2	2546.00	53.35	-13.00	-53.37	11.49	-41.88
3	3395.00	61.21	-13.00	-46.58	12.56	-34.02
4	4244.00	61.35	-13.00	-47.58	13.70	-33.88
5	5093.00	54.12	-13.00	-55.02	13.91	-41.11
6	5941.00	54.35	-13.00	-55.27	14.39	-40.88

ANTENNA POLARITY & TEST DISTANCE: VERTICAL AT 3 M						
No.	Freq. (MHz)	Emission Level (dBuV)	Limit (dBm)	S.G Power Value (dBm)	Correction Factor (dB)	Power Value (dBm)
1	1698.00	66.95	-13.00	-38.45	10.17	-28.28
2	2546.00	55.88	-13.00	-50.84	11.49	-39.35
3	3395.00	64.10	-13.00	-43.69	12.56	-31.13
4	4244.00	64.82	-13.00	-44.11	13.70	-30.41
5	5093.00	56.29	-13.00	-52.85	13.91	-38.94
6	5941.00	59.15	-13.00	-50.47	14.39	-36.08

NOTE: Power Value (dBum) = S.G Power Value (dBm) + Correction Factor (dB).

5 PHOTOGRAPHS OF THE TEST CONFIGURATION

RADIATED EMISSION TEST

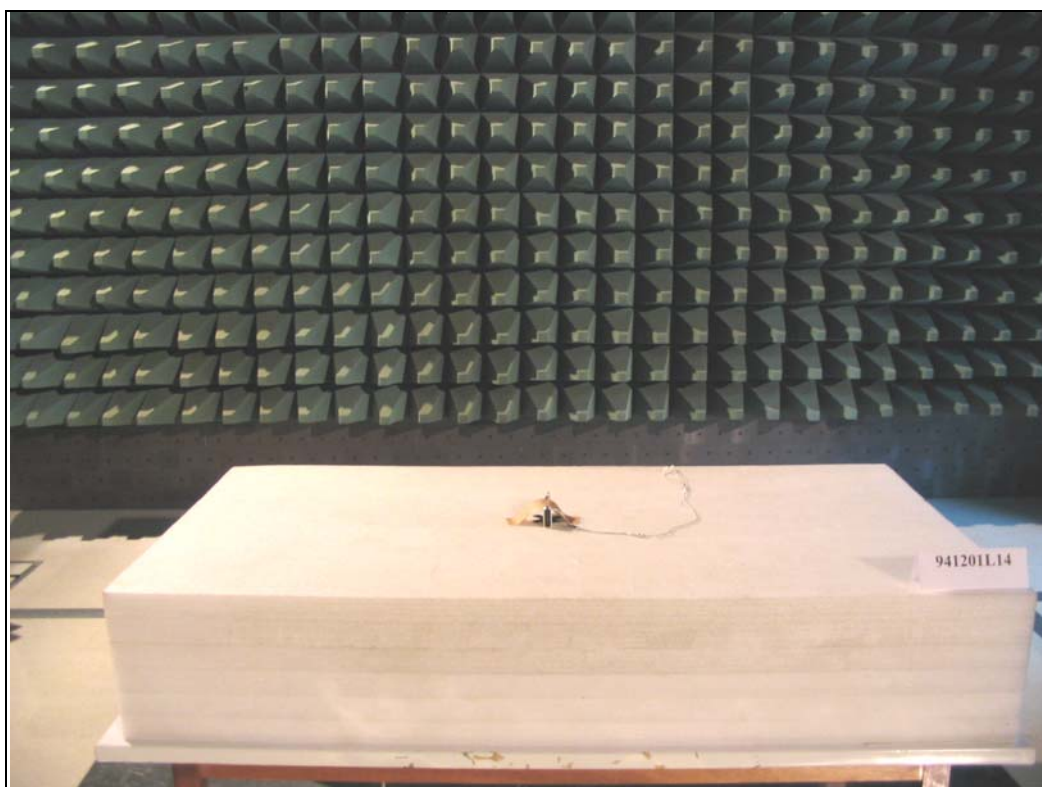
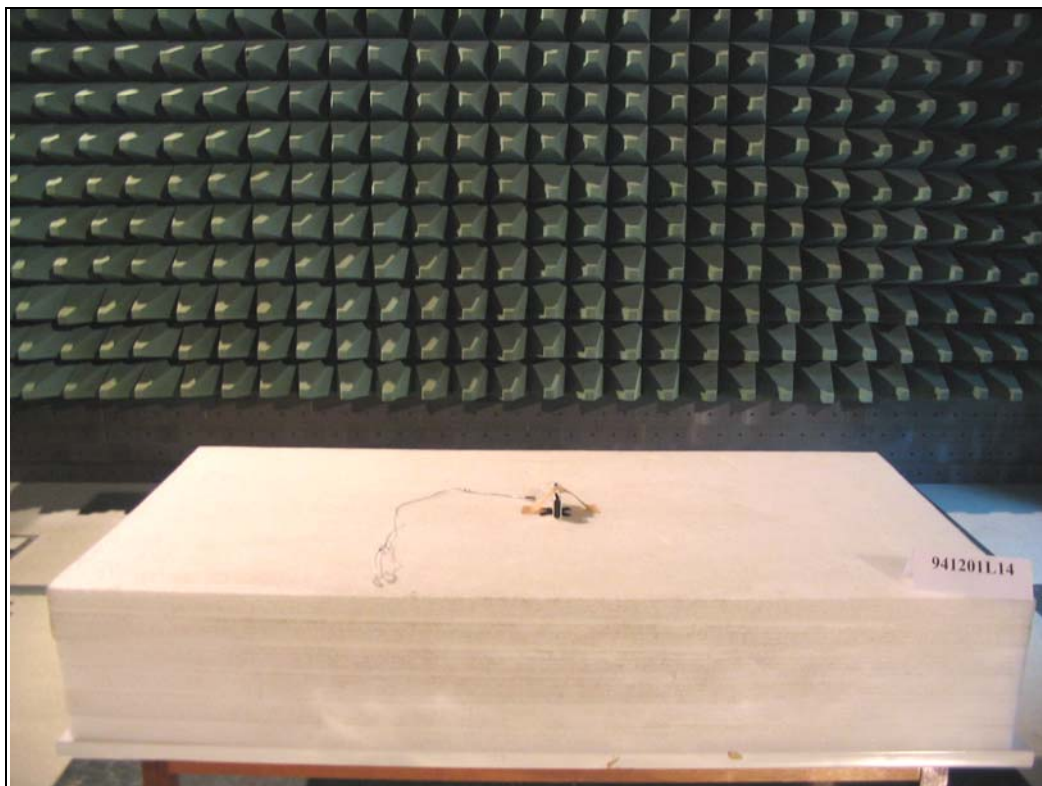



6 INFORMATION ON THE TESTING LABORATORIES

We, ADT Corp., were founded in 1988 to provide our best service in EMC, Radio, Telecom and Safety consultation. Our laboratories are accredited and approved by the following approval agencies according to ISO/IEC 17025.

USA	FCC, NVLAP, UL, A2LA
GERMANY	TUV Rheinland
JAPAN	VCCI
NORWAY	NEMKO
CANADA	INDUSTRY CANADA , CSA
R.O.C.	CNLA, BSMI, DGT
NETHERLANDS	Telefication
SINGAPORE	PSB , GOST-ASIA (MOU)
RUSSIA	CERTIS (MOU)

Copies of accreditation certificates of our laboratories obtained from approval agencies can be downloaded from our web site:

www.adt.com.tw/index.5/phtml. If you have any comments, please feel free to contact us at the following:

Linko EMC/RF Lab:

Tel: 886-2-26052180

Fax: 886-2-26052943

Hsin Chu EMC/RF Lab:

Tel: 886-3-5935343

Fax: 886-3-5935342

Hwa Ya EMC/RF/Safety/Telecom Lab:

Tel: 886-3-3183232

Fax: 886-3-3185050

Linko RF Lab:

Tel: 886-3-3270910

Fax: 886-3-3270892

Email: service@adt.com.tw

Web Site: www.adt.com.tw

The address and road map of all our labs can be found in our web site also.