

**AWS GSM DL Input**

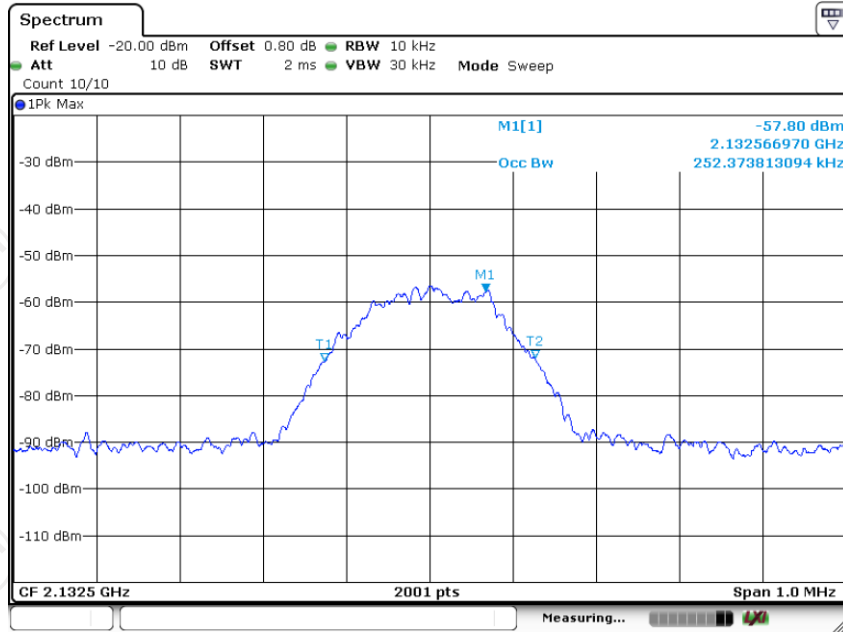

Date: 7.NOV.2024 16:06:55

**AWS GSM DL Output**

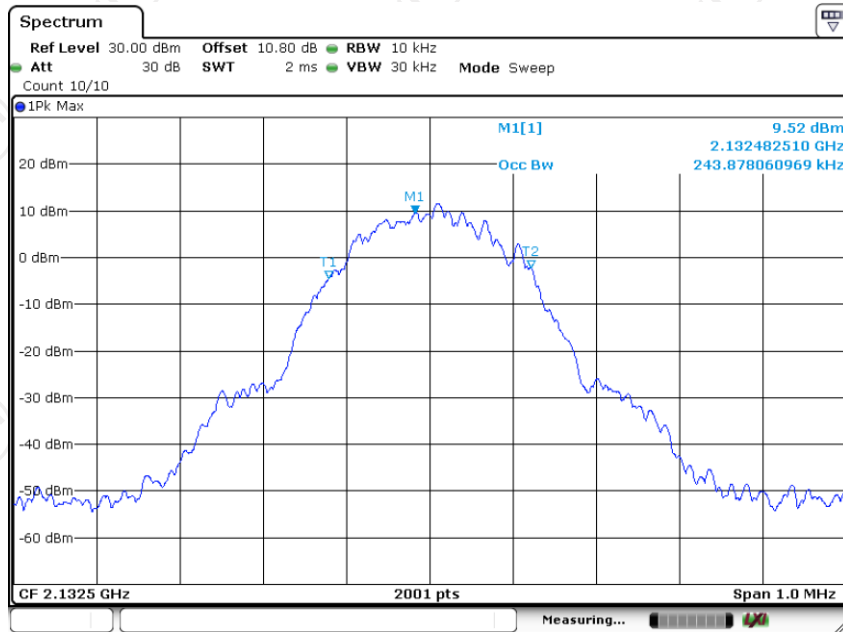

Date: 8.NOV.2024 10:33:55

**AWS CDMA UL Input**

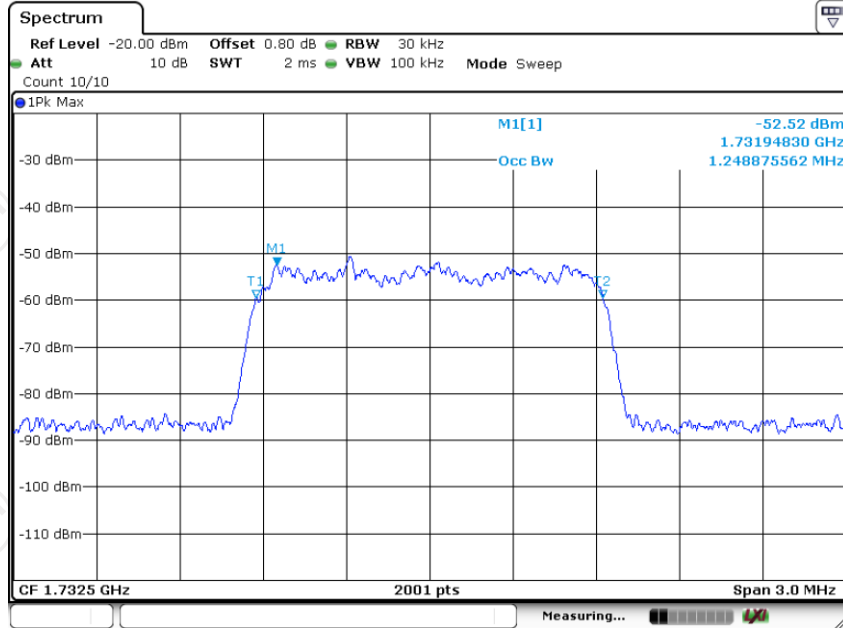

Date: 7.NOV.2024 16:21:16

**AWS CDMA UL output**

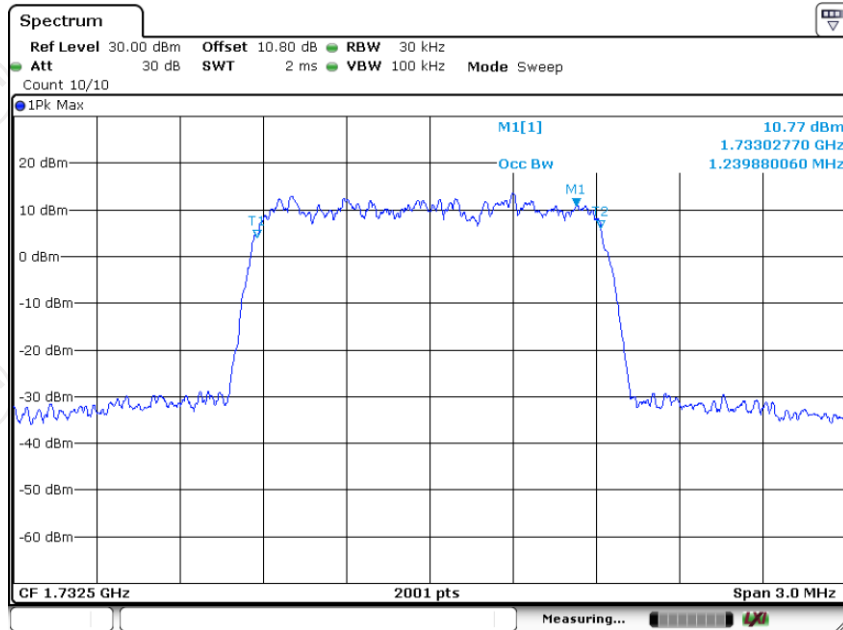

Date: 8.NOV.2024 09:28:56

**AWS CDMA DL Input**

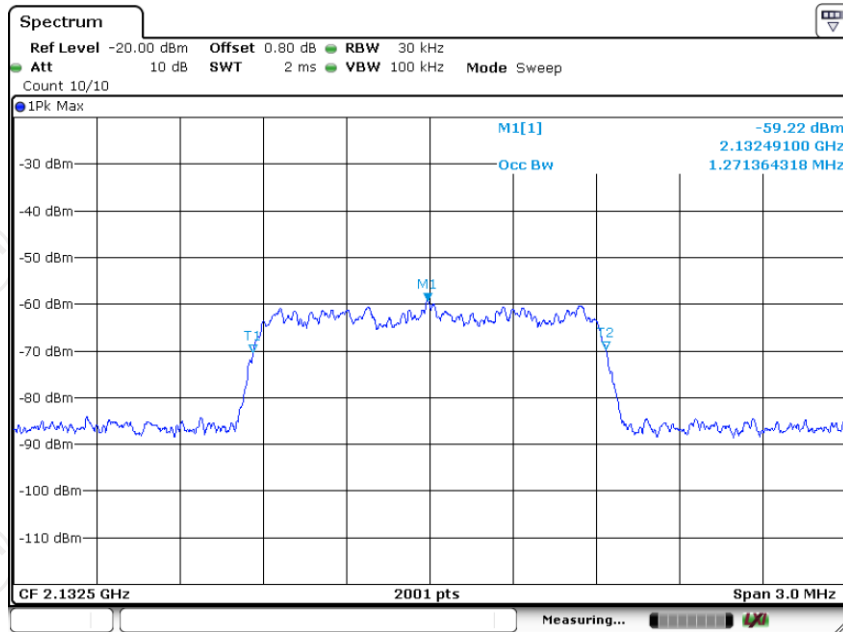

**AWS CDMA DL Output**

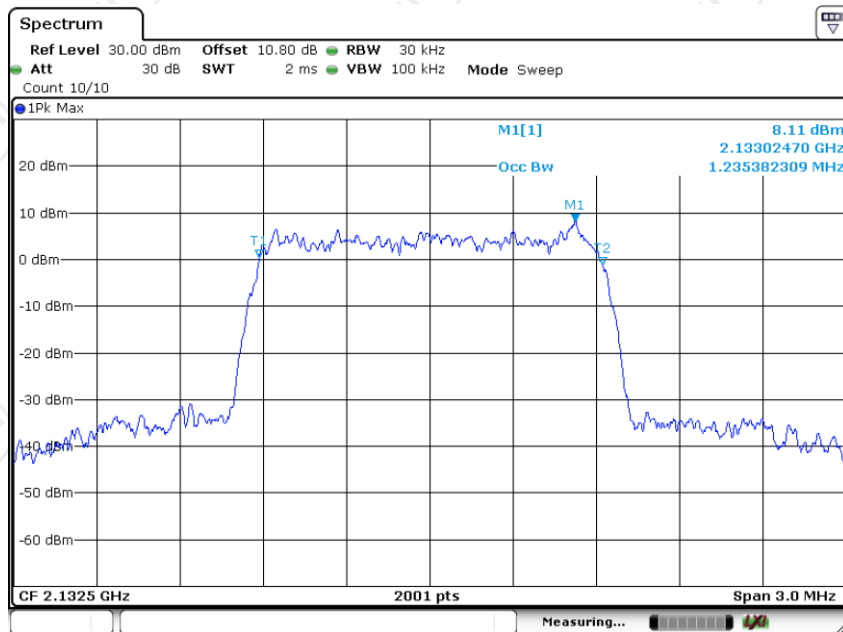

**AWS LTE UL Input**

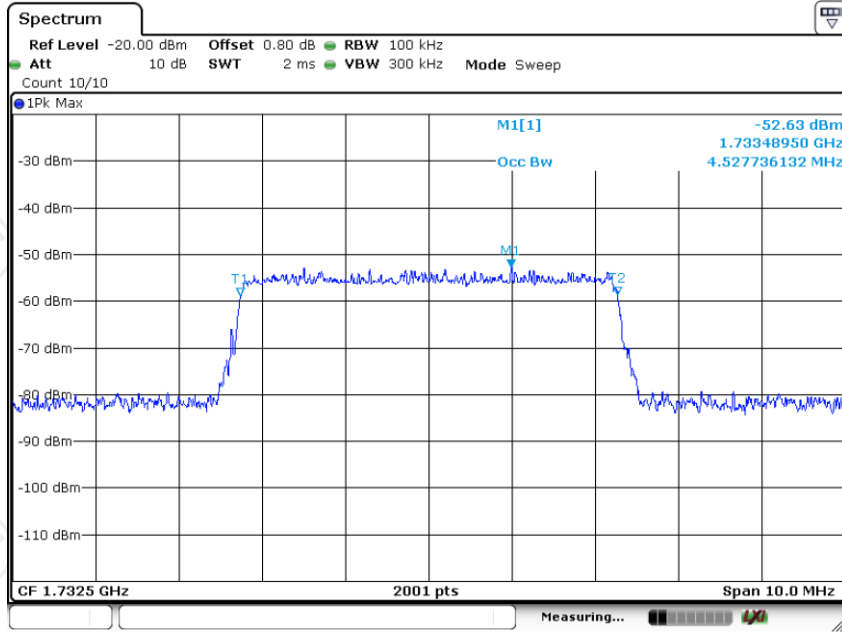

Date: 7.NOV.2024 16:26:31

**AWS LTE UL output**

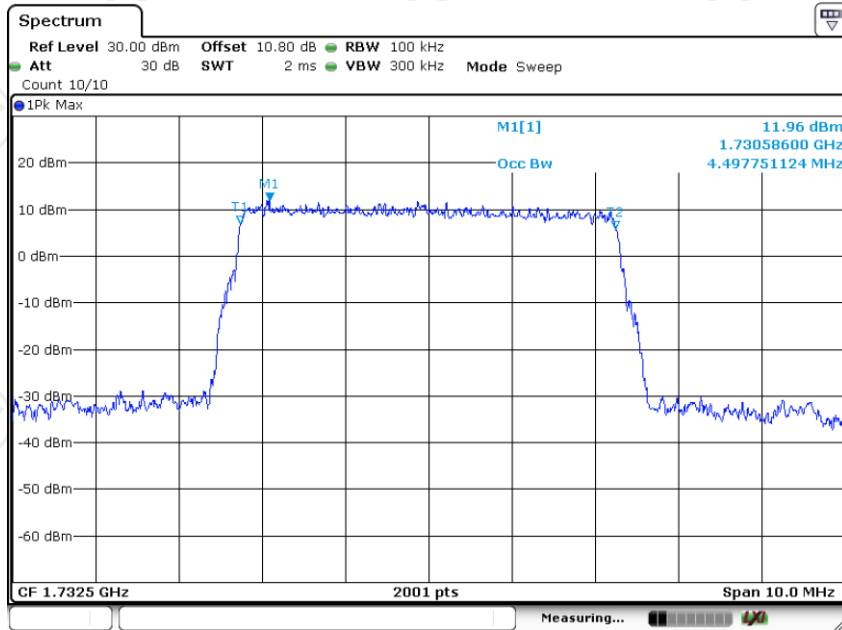

Date: 8.NOV.2024 09:44:18

## AWS LTE DL Input

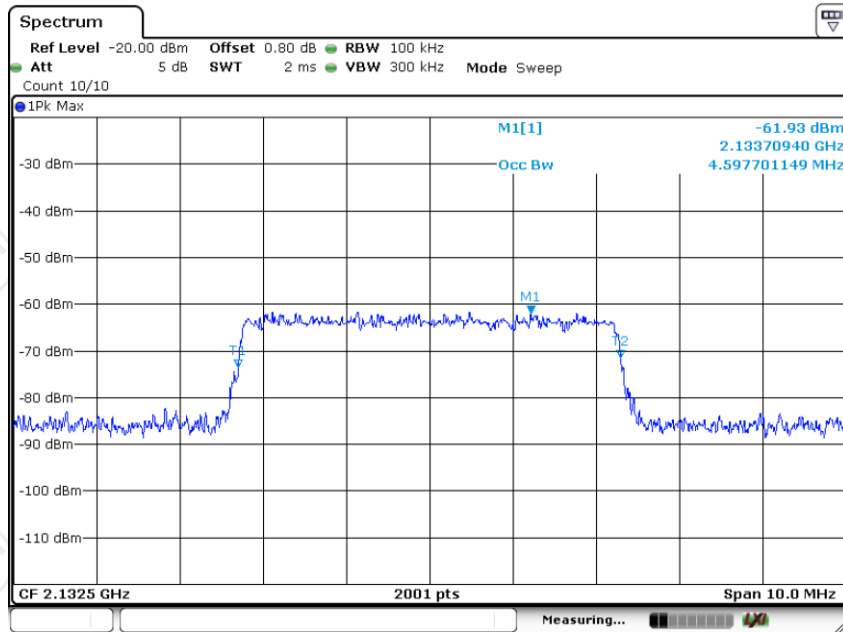

Date: 7.NOV.2024 16:30:58

## AWS LTE DL Output

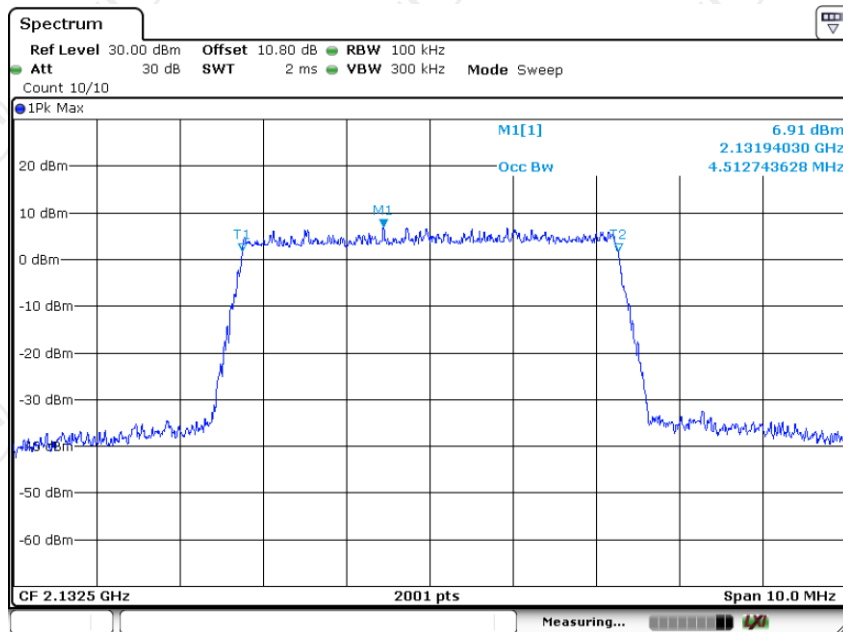

Date: 8.NOV.2024 10:13:27

Cellular GSM UL Input

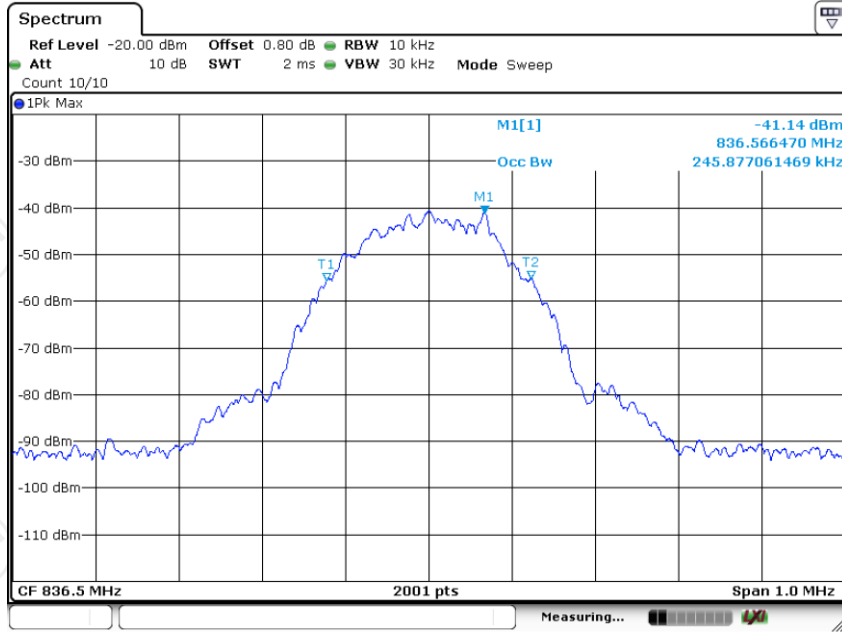

Date: 7.NOV.2024 16:04:00

Cellular GSM UL output

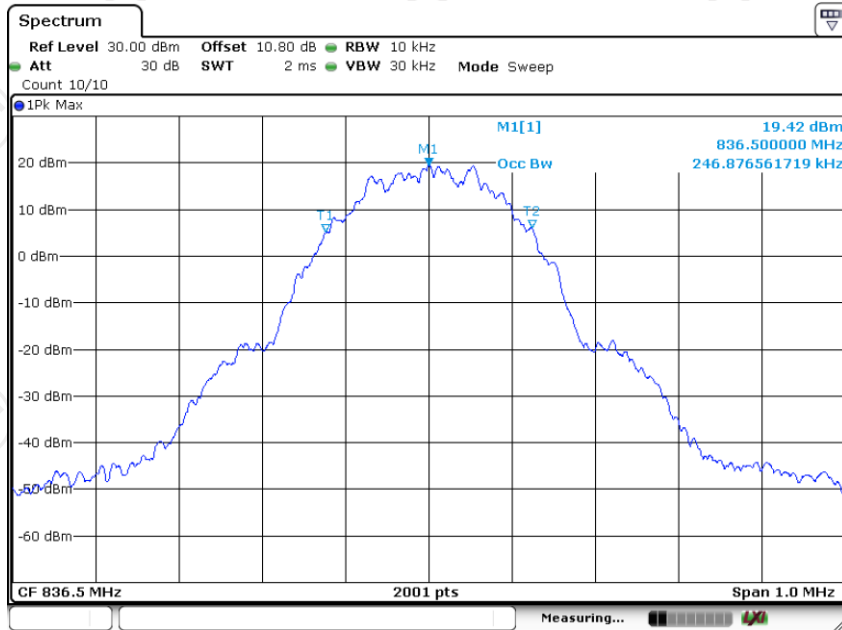

Date: 8.NOV.2024 09:16:23

## Cellular GSM DL Input

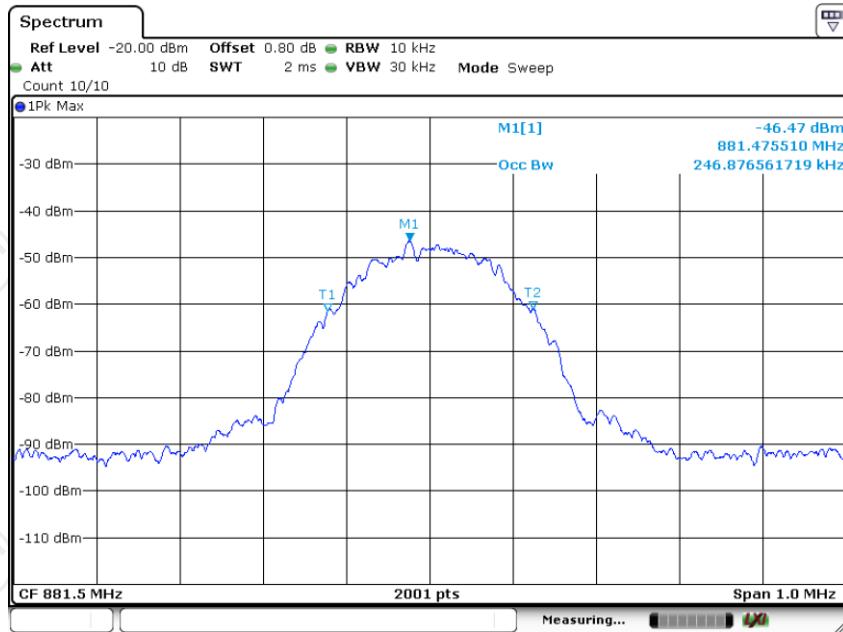

Date: 7.NOV.2024 16:09:33

## Cellular GSM DL Output

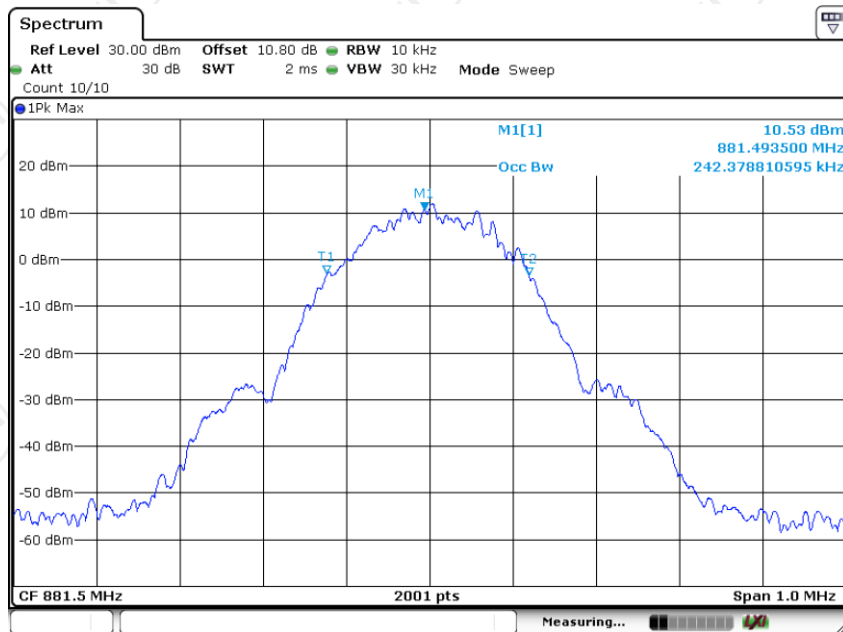

Date: 8.NOV.2024 10:36:22

Cellular CDMA UL Input

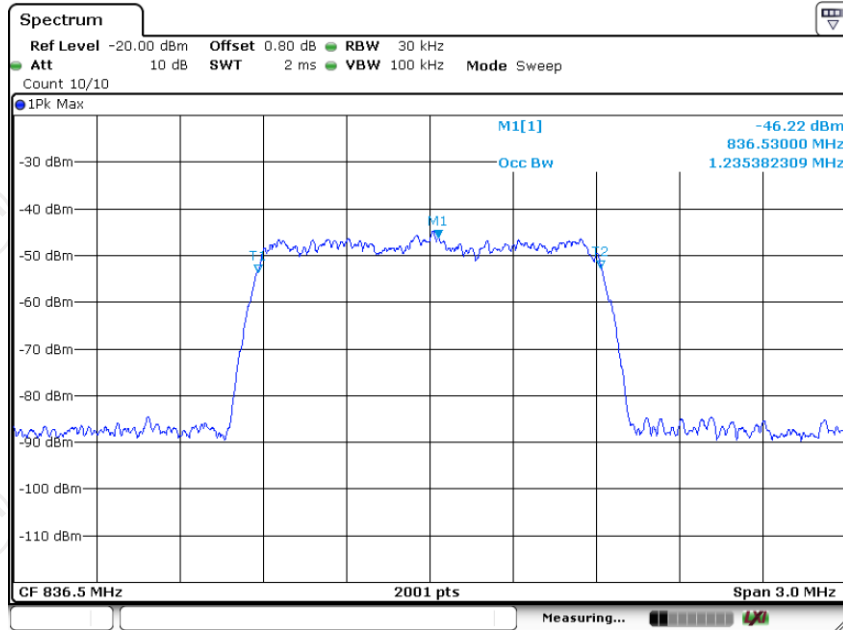

Date: 7.NOV.2024 16:23:10

Cellular CDMA UL output

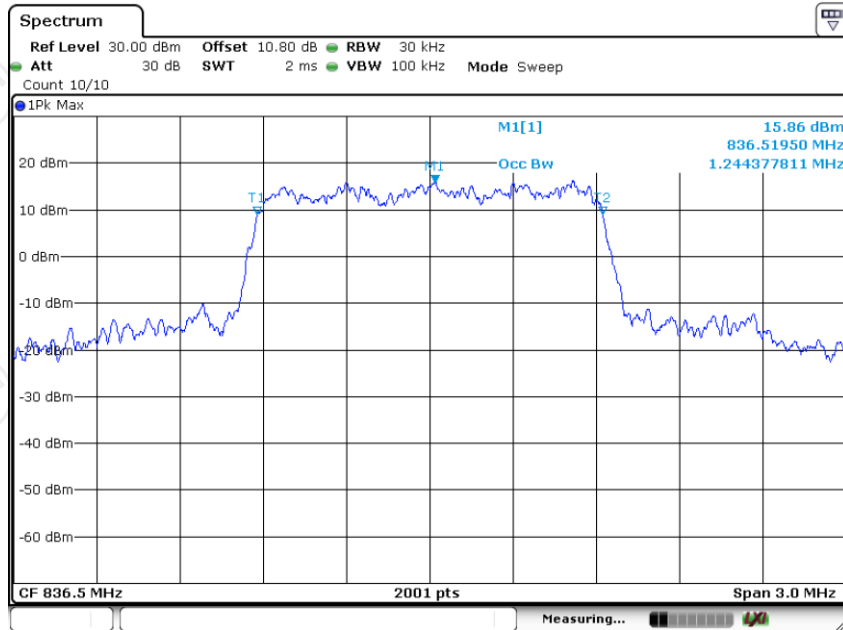

Date: 8.NOV.2024 09:34:45



Cellular CDMA DL Input

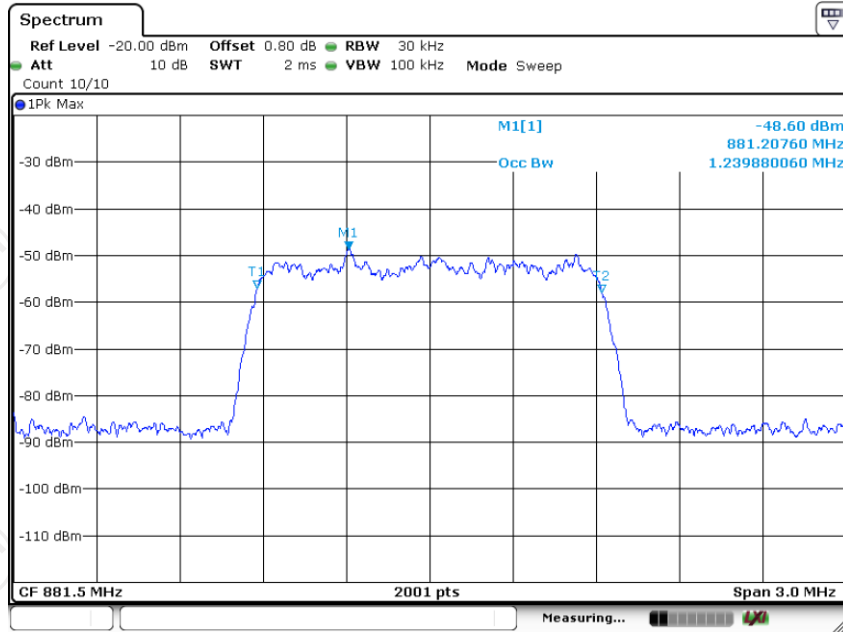

Date: 7.NOV.2024 16:10:06

Cellular CDMA DL Output

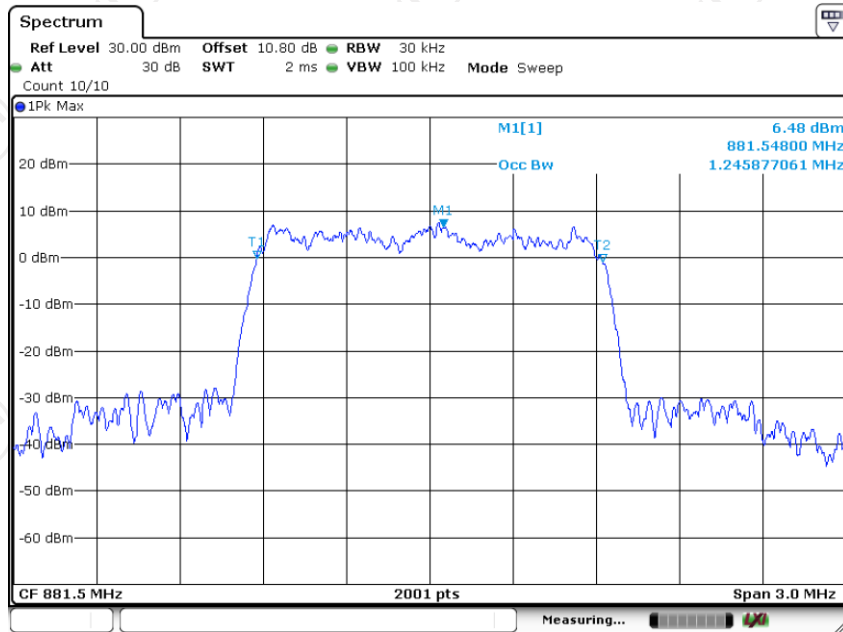

Date: 8.NOV.2024 10:24:49

**Cellular LTE UL Input**

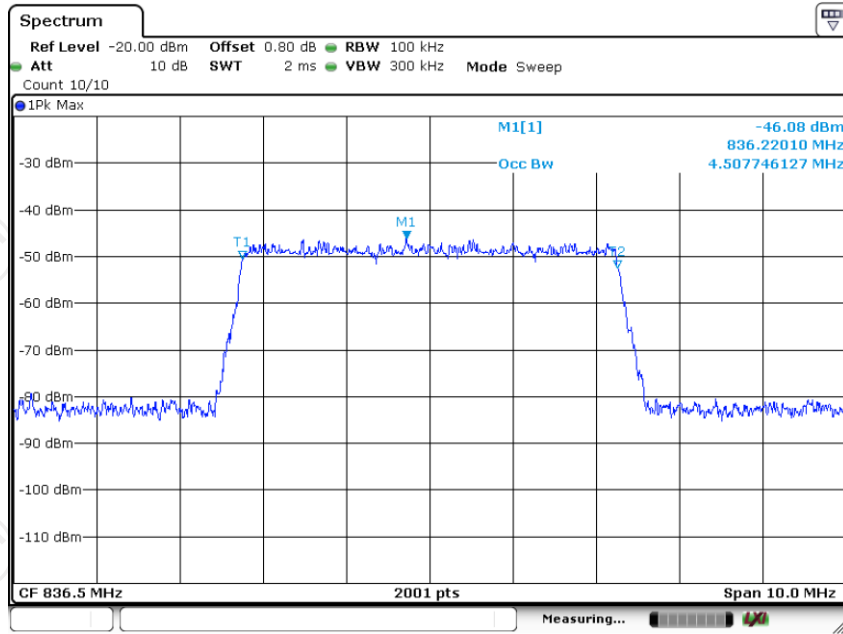

Date: 7.NOV.2024 16:23:58

**Cellular LTE UL output**

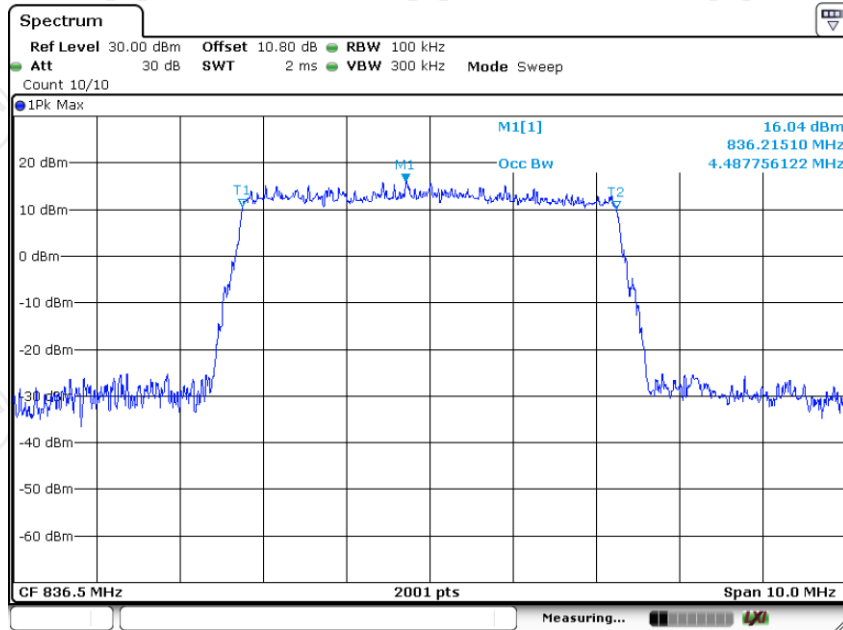

Date: 8.NOV.2024 09:37:52

Cellular LTE DL Input

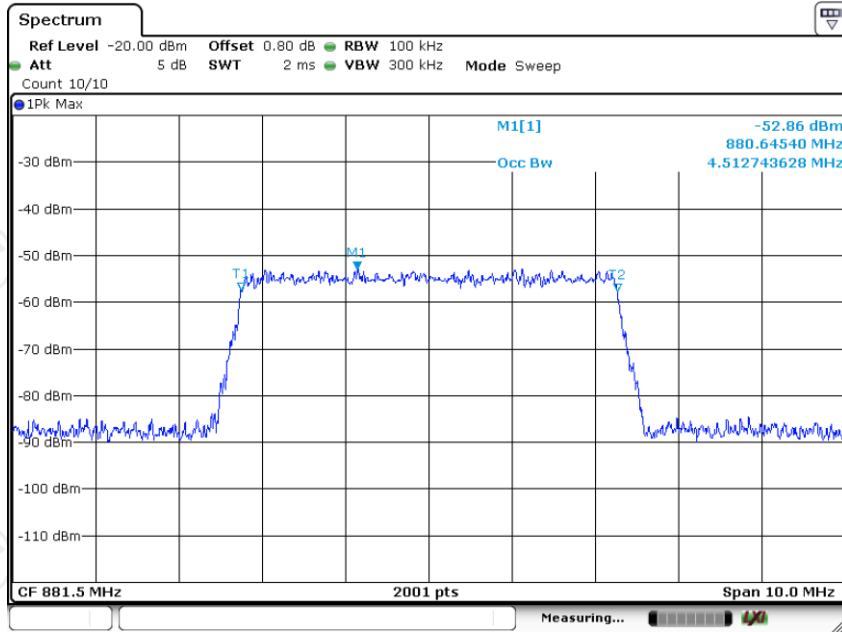

Date: 7.NOV.2024 16:31:54

Cellular LTE DL Output

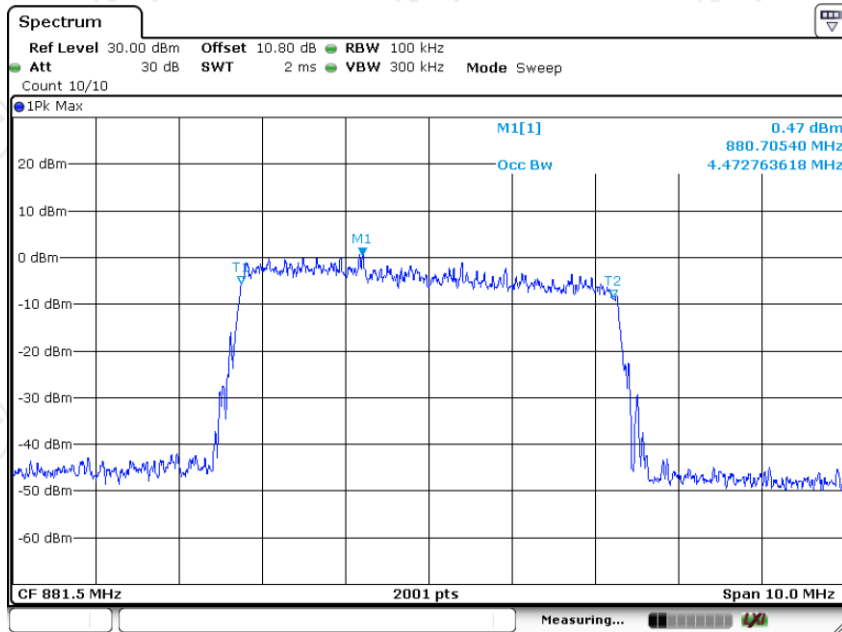

Date: 8.NOV.2024 10:21:35

Lower700MHz GSM UL Input

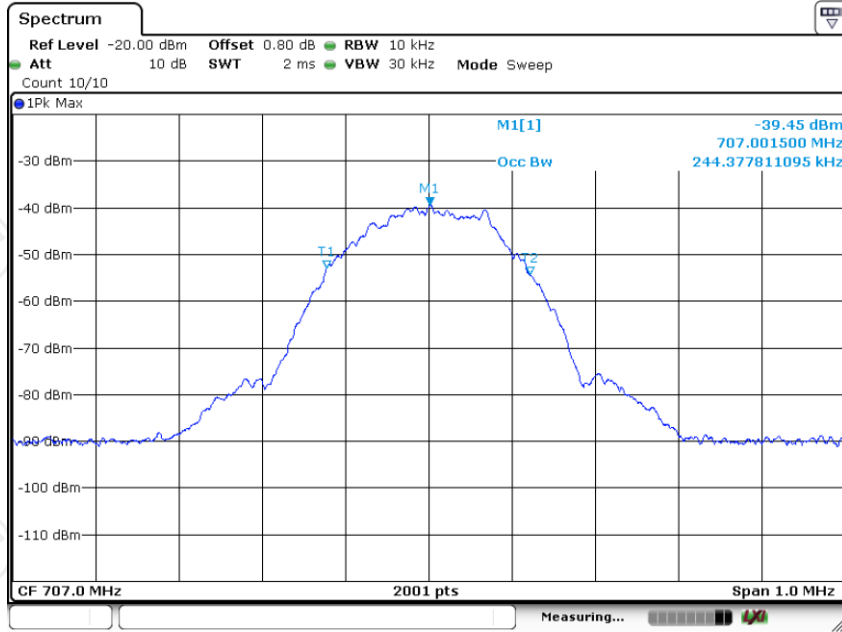

Date: 7.NOV.2024 16:02:05

Lower700MHz GSM UL output

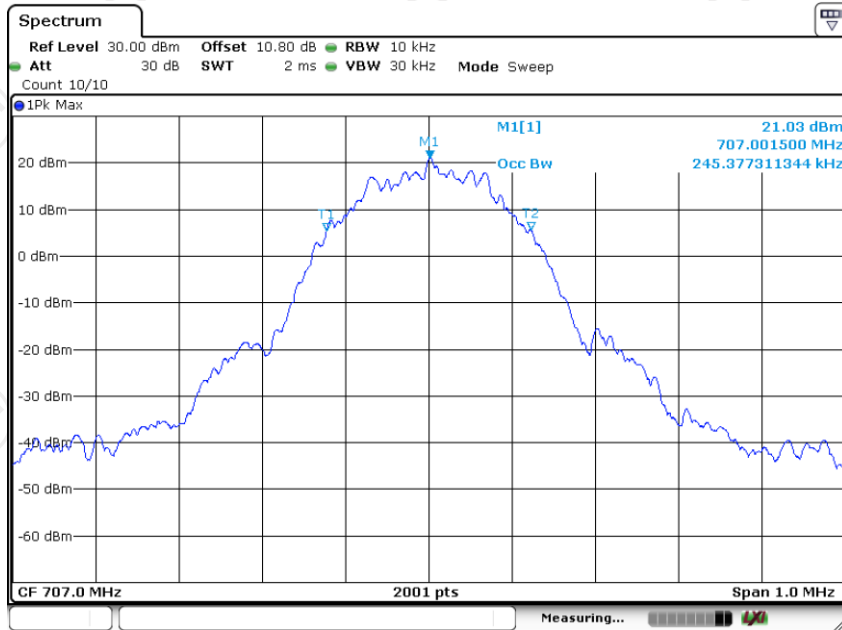

Date: 8.NOV.2024 09:13:47

Lower700MHz GSM DL Input

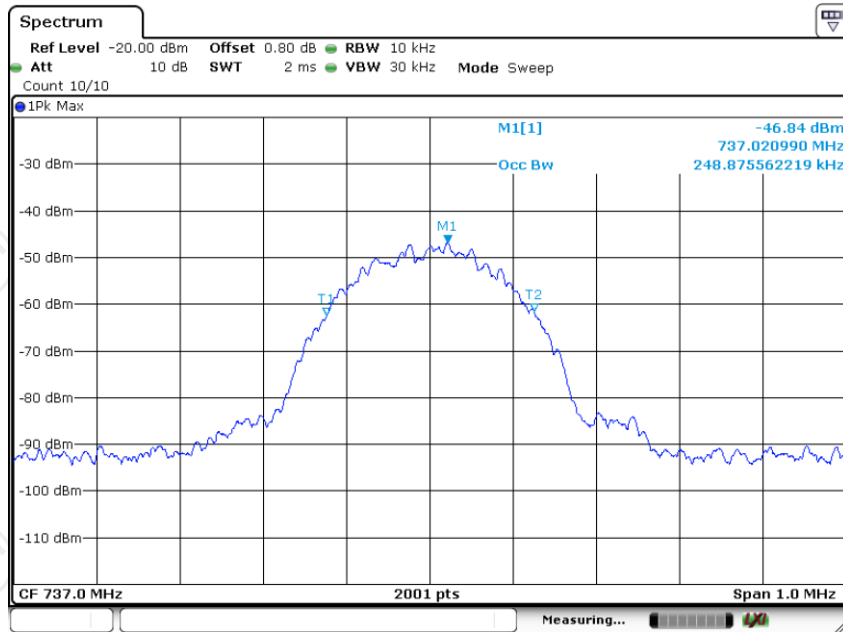

Date: 7.NOV.2024 16:07:48

Lower700MHz GSM DL Output

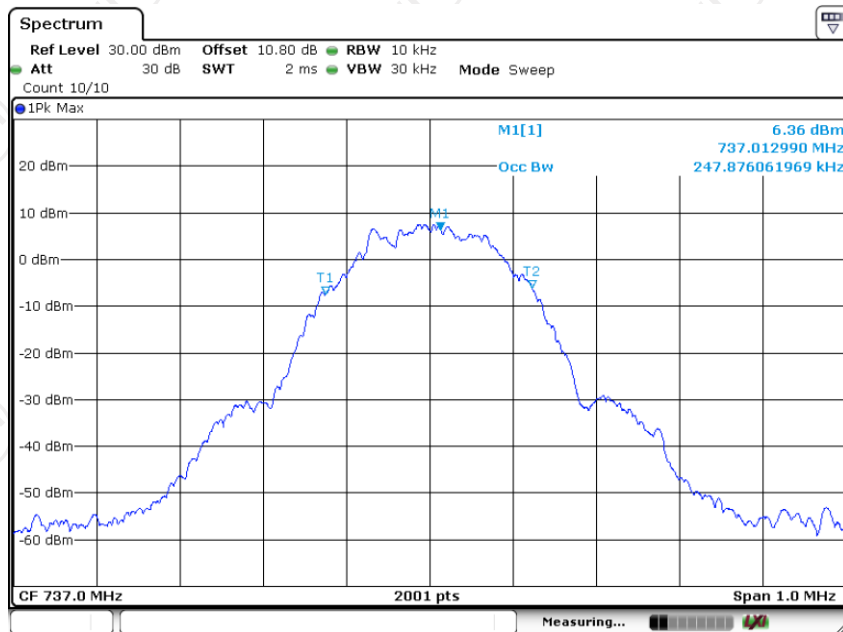

Date: 8.NOV.2024 10:34:56

Lower700MHz CDMA UL Input

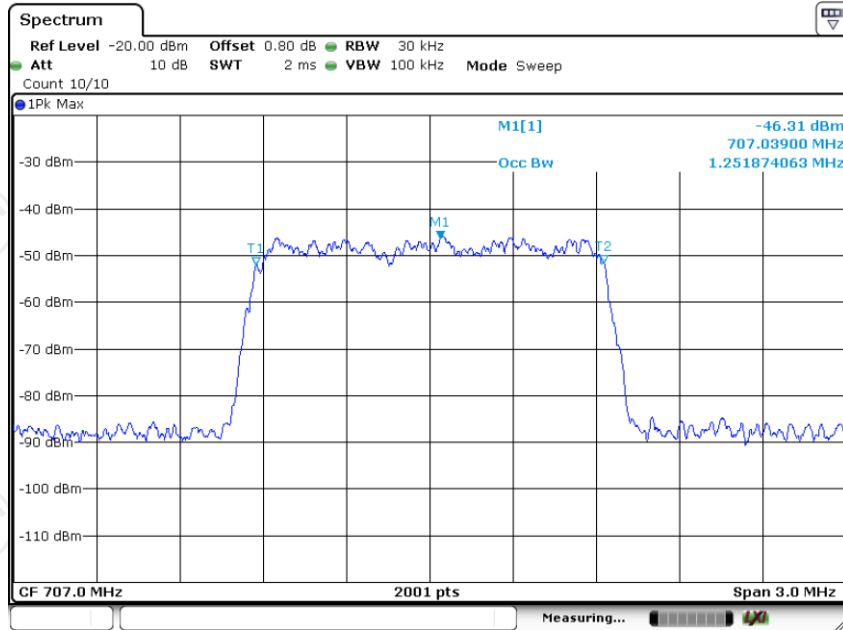

Date: 7.NOV.2024 16:22:02

Lower700MHz CDMA UL output

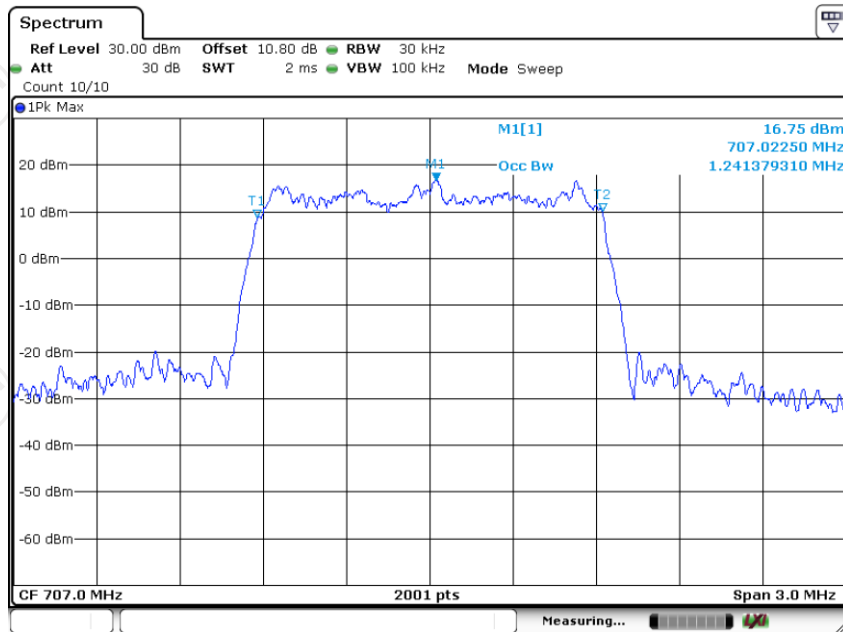

Date: 8.NOV.2024 09:32:03

## Lower700MHz CDMA DL Input

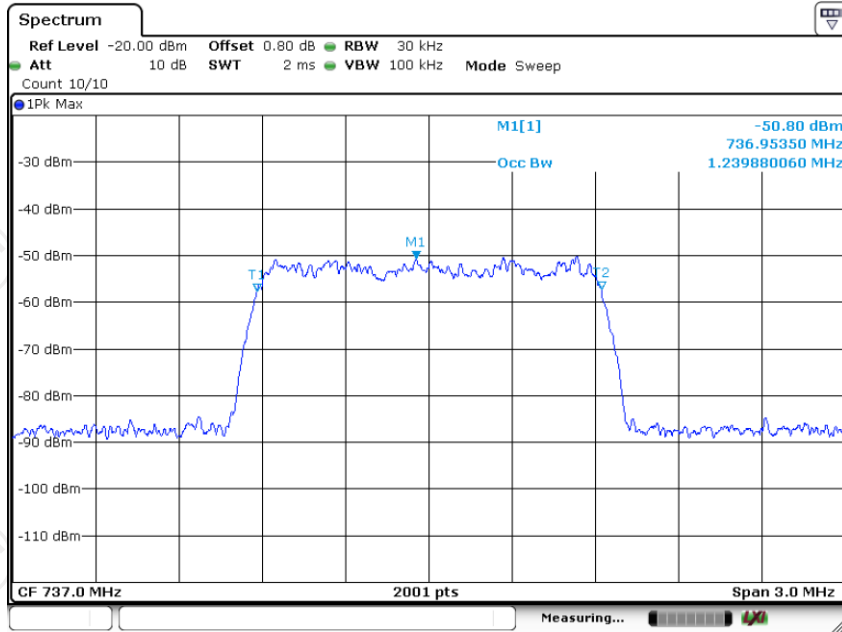

## Lower700MHz CDMA DL Output

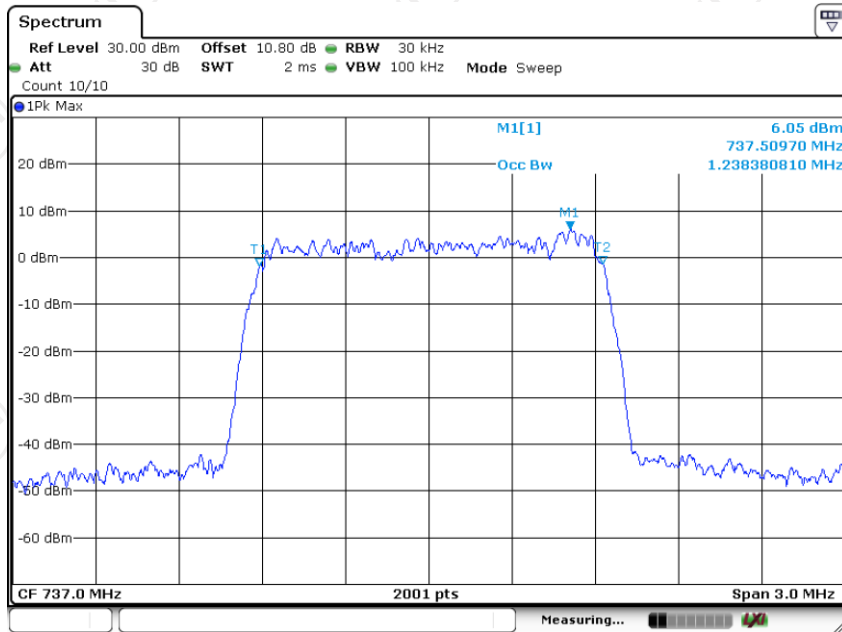

Lower700MHz LTE UL Input

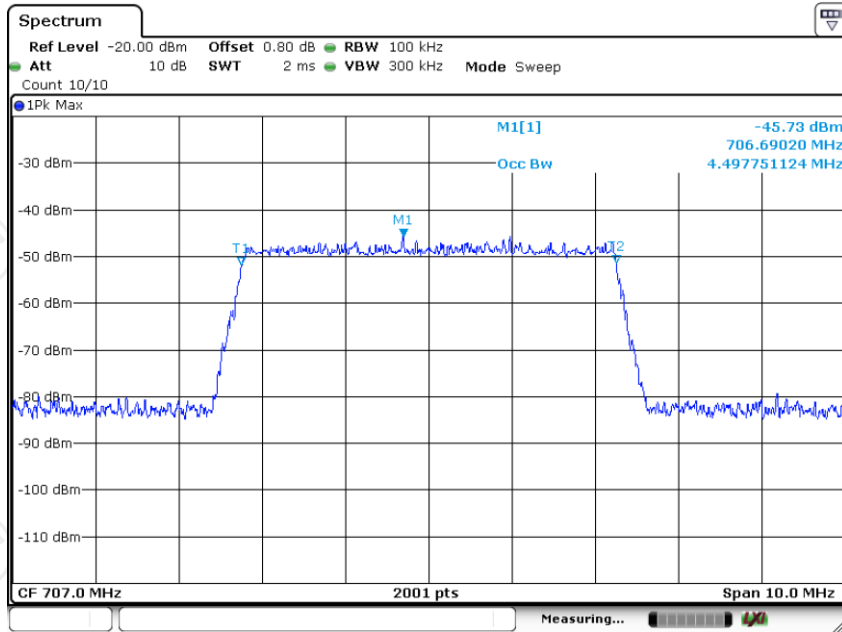

Date: 7.NOV.2024 16:24:19

Lower700MHz LTE UL output

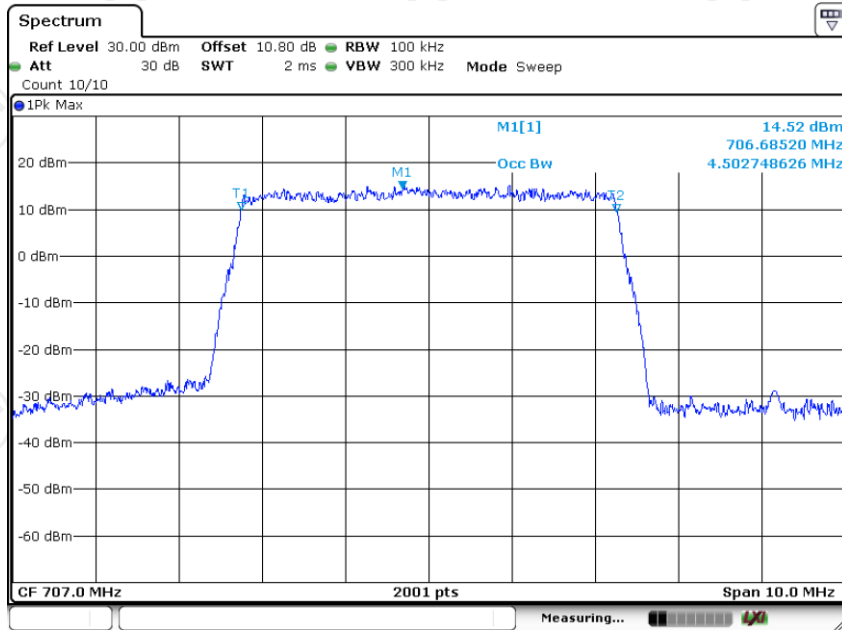

Date: 8.NOV.2024 09:38:28



Lower700MHz LTE DL Input

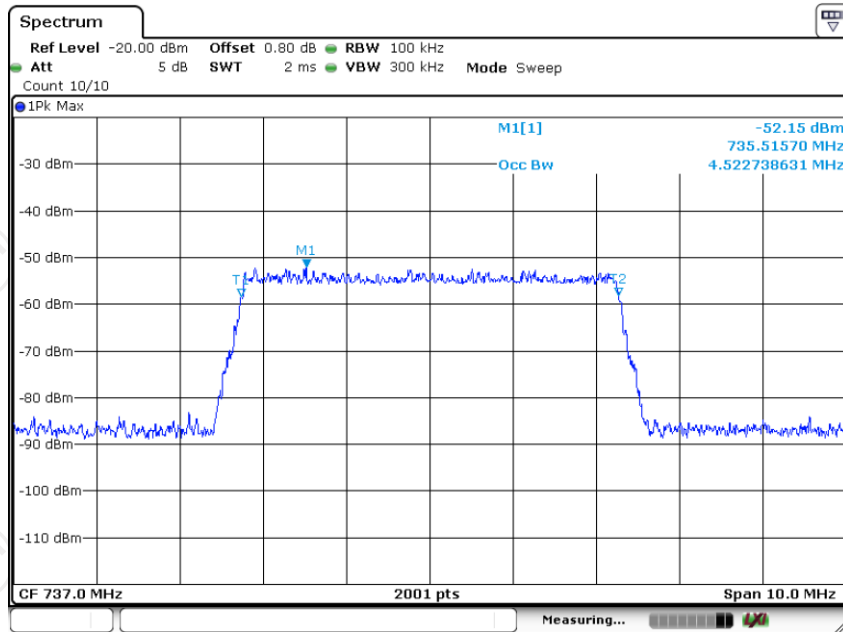

Date: 7.NOV.2024 16:32:18

Lower700MHz LTE DL Output

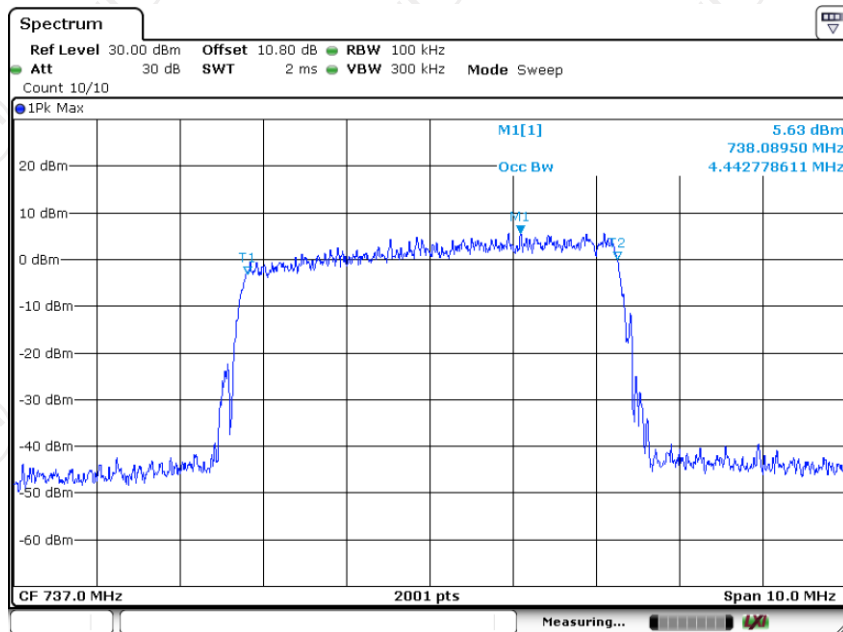

Date: 8.NOV.2024 10:19:15

Upper700MHz GSM UL Input

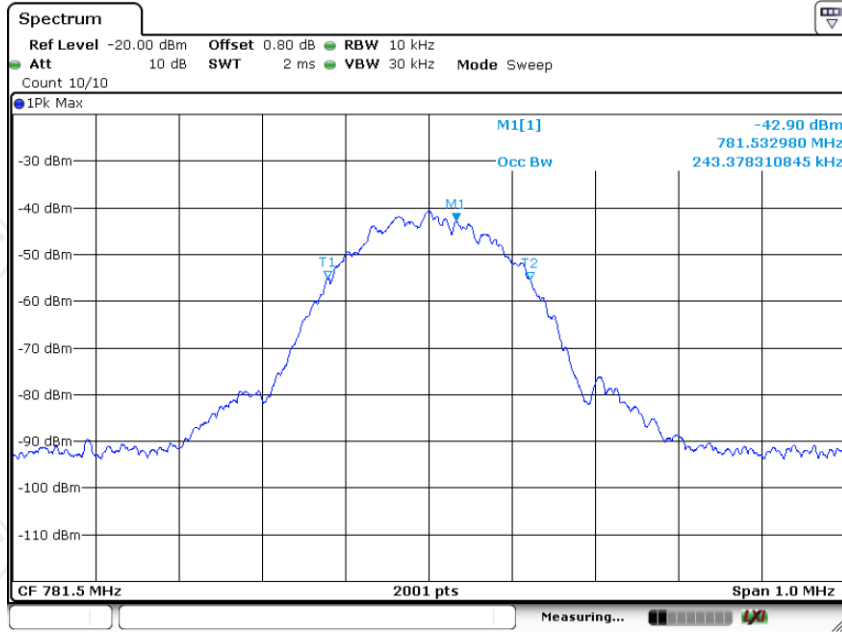

Date: 7.NOV.2024 16:03:09

Upper700MHz GSM UL output

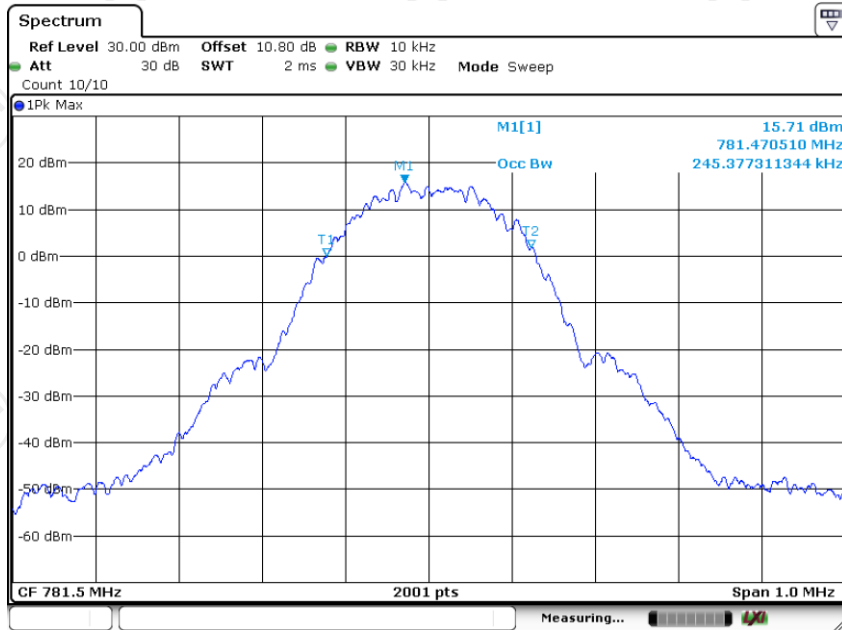

Date: 8.NOV.2024 09:15:18

Upper700MHz GSM DL Input

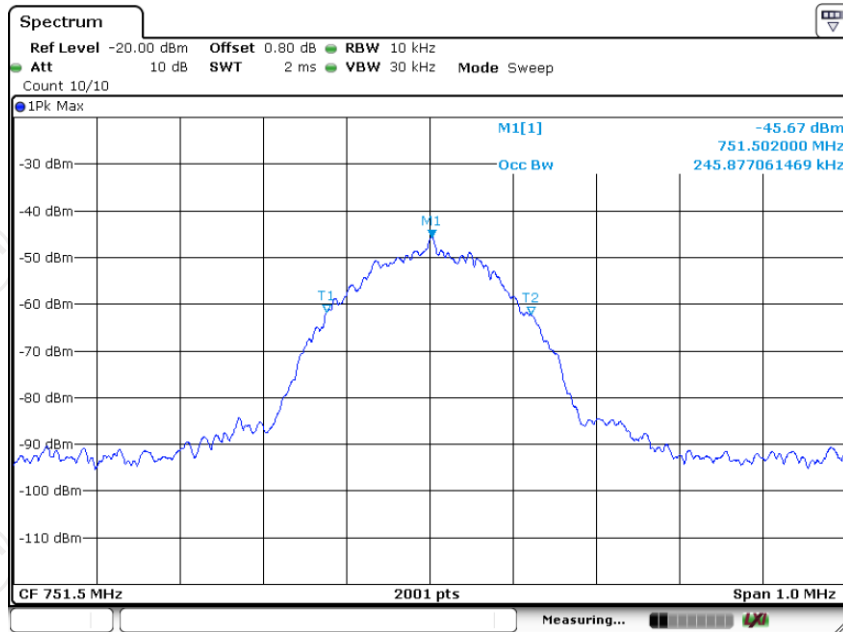

Date: 7.NOV.2024 16:08:25

Upper700MHz GSM DL Output

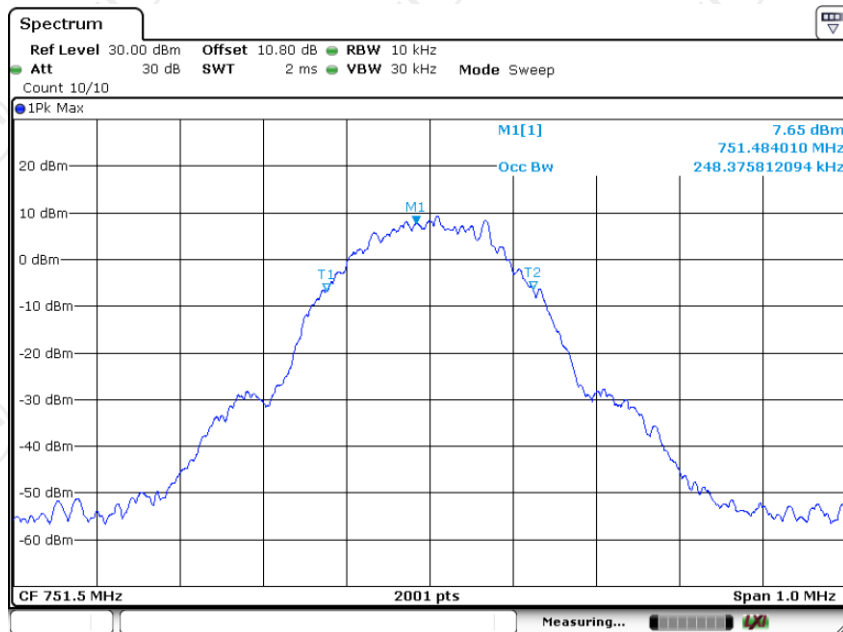

Date: 8.NOV.2024 10:35:20

Upper700MHz CDMA UL Input

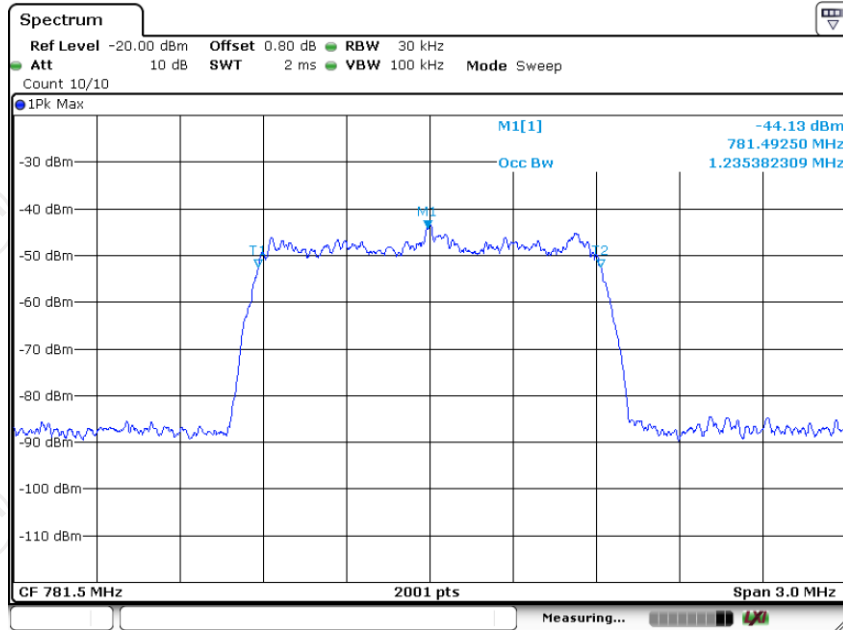

Date: 7.NOV.2024 16:22:29

Upper700MHz CDMA UL output

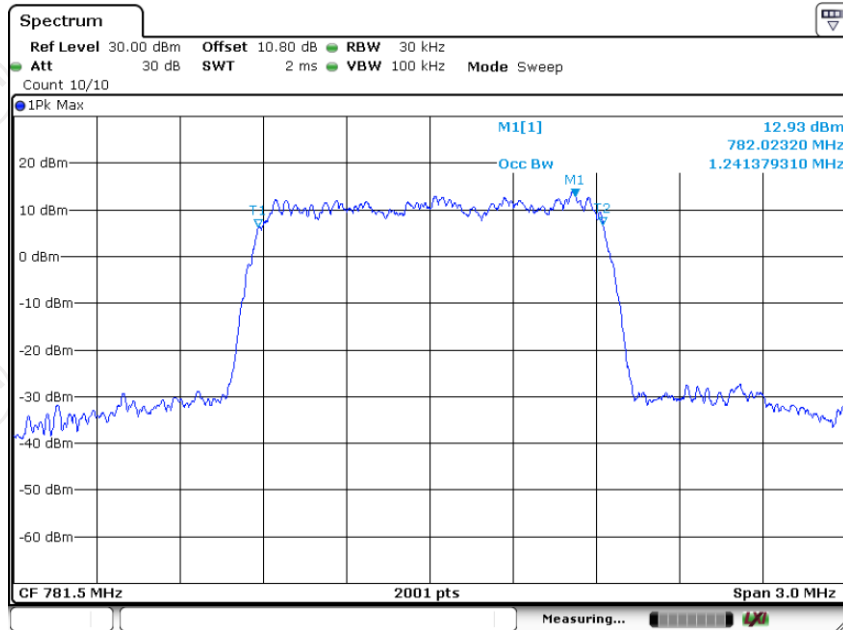

Date: 8.NOV.2024 09:32:55

## Upper700MHz CDMA DL Input

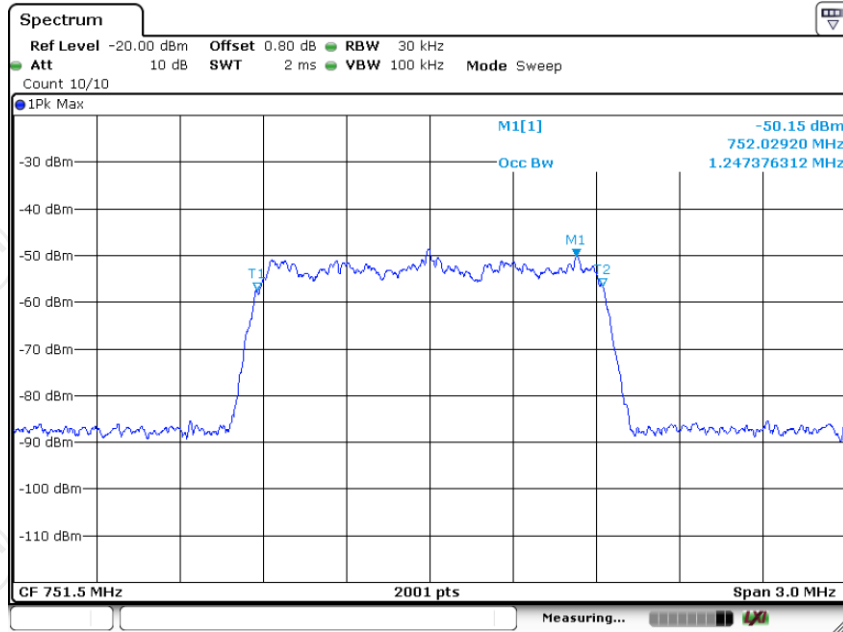

## Upper700MHz CDMA DL Output

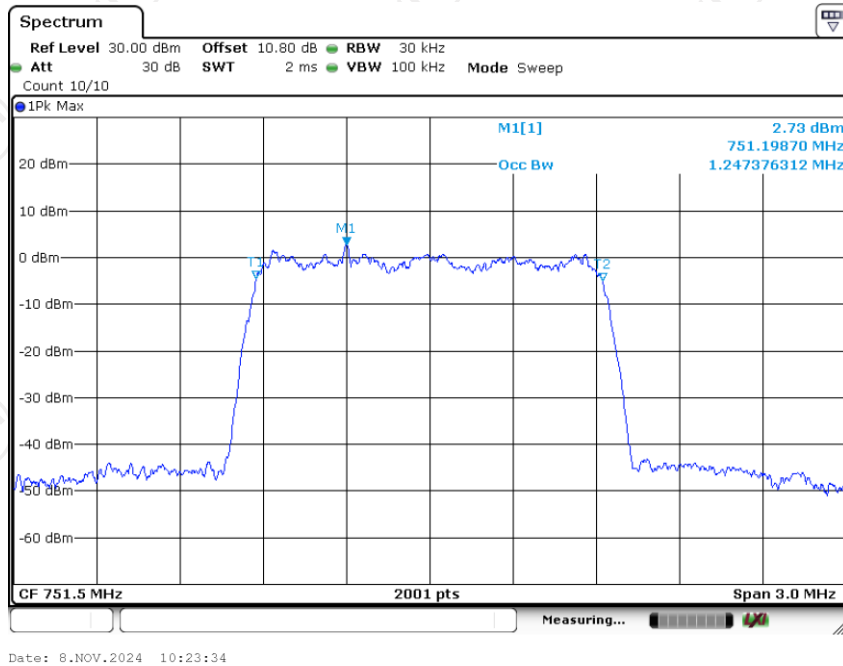

Upper700MHz LTE UL Input

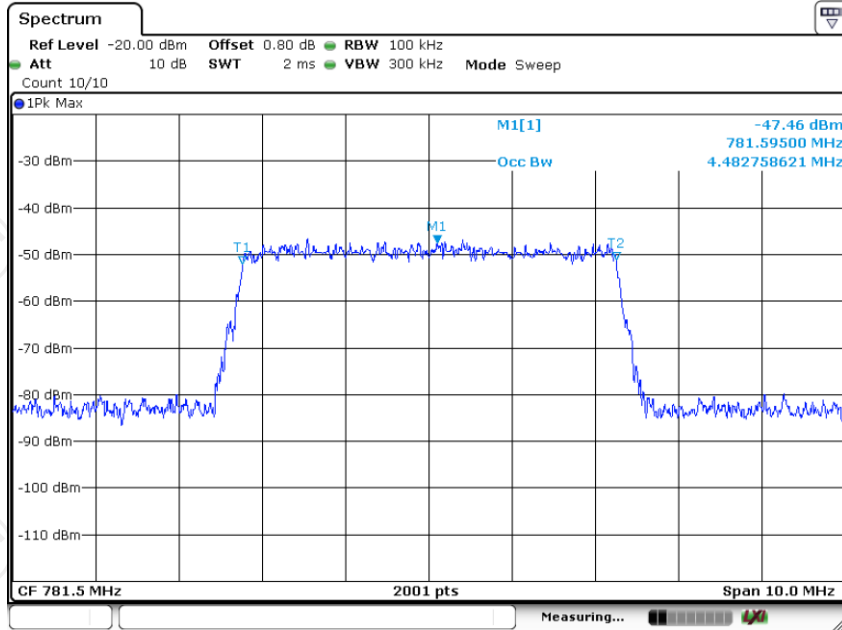

Date: 7.NOV.2024 16:24:43

Upper700MHz LTE UL output

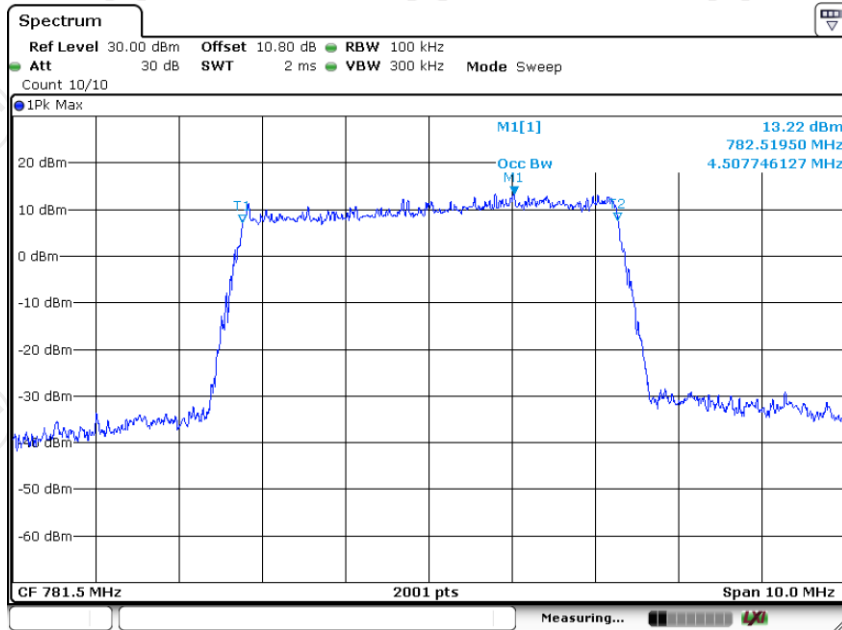

Date: 8.NOV.2024 09:38:53

Upper700MHz LTE DL Input

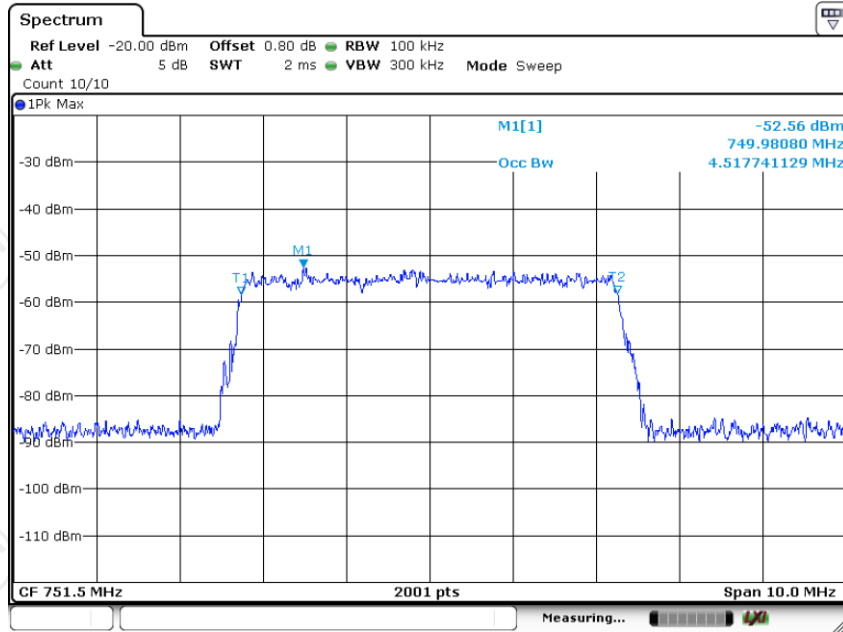

Date: 7.NOV.2024 16:32:42

Upper700MHz LTE DL Output

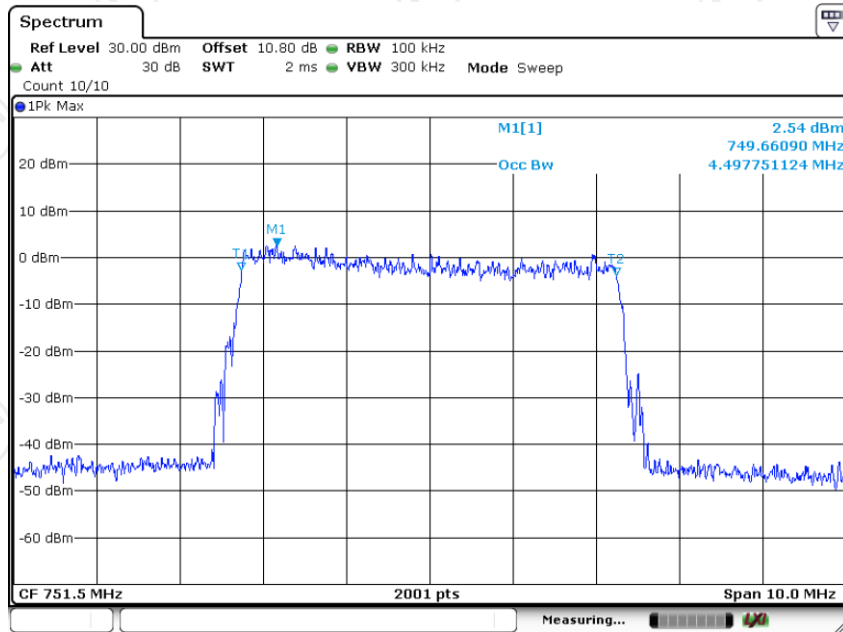

Date: 8.NOV.2024 10:20:37

## 5.10. Oscillation Detection and Mitigation

### 5.10.1. Test Specification

<b>Test Requirement:</b>	FCC Part20 Section 20.21(e)(8)(ii)(A)
<b>Test Method:</b>	KDB935210 D03 Signal booster Measurements v04r04
<b>Limit:</b>	Reference to test data bellow

**Test setup:**

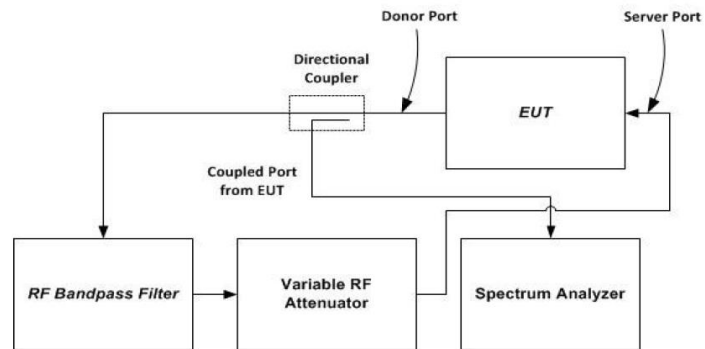

NOTE—This figure shows the test setup for uplink bands transmission path tests; i.e., signal flow is out from the donor port into the directional coupler. For downlink bands transmission path tests, the feedback signal flow path direction and equipment connections shall be reversed, i.e., signal flow is out from the server port into the directional coupler, and signal flow is into the donor port from the variable RF attenuator.

Figure 7 – Oscillation detection (7.11.2) test setup

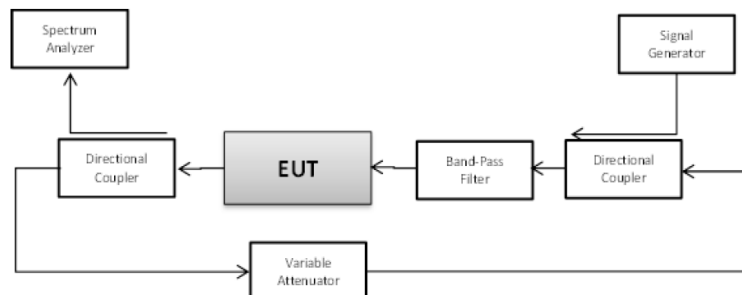

Figure 8 – Oscillation mitigation/shutdown test setup

**Test Procedure:**

**Oscillation restart tests**

- a) Connect the normal-operating mode EUT to the test equipment as shown in Figure 7 beginning with the spectrum analyzer on the uplink output (donor) port. Confirm that the RF coupled path is connected to the spectrum analyzer.  
NOTE—The band-pass filter shall provide sufficient out-of-band rejection to prevent oscillations from occurring in bands not under test.
- b) Spectrum analyzer settings:
  - 1) Center frequency at the center of the band under test
  - 2) Span equal or slightly exceeding the width of the band under test
  - 3) Continuous sweep, max-hold
  - 4) RBW $\geq$ 1 MHz, VBW > 3xRBW
- c) Decrease the variable attenuator until the spectrum analyzer displays a signal within the band under test. Using a marker, identify the approximate center frequency of this signal on the max-hold display, increase the attenuation by 10 dB, then reset the EUT (e.g., cycle ac/dc power).
- d) Repeat 7.11.2c) twice to ensure that the center of the signal



- created by the booster remains within 250 kHz of the spectrum analyzer display center frequency. If the frequency of the signal is unstable, confirm that the spectrum analyzer display is centered between the frequency extremes observed. If the signal is wider than 1 MHz, ensure that the spectrum analyzer display is centered on the signal by increasing the RBW. Reset the EUT (e.g., cycle ac/dc power) after each oscillation event, if necessary. Set the spectrum analyzer sweep trigger level to just below the peak amplitude of the displayed EUT oscillation signal.
- e) Set the spectrum analyzer to zero-span, with a sweep time of 5 seconds, and single-sweep with max-hold. The spectrum analyzer sweep trigger level in this and the subsequent steps shall be the level identified in 7.11.2d).
  - f) Decrease the variable attenuator until the spectrum analyzer sweep is triggered, increase the attenuation by 10 dB, then reset the EUT (e.g., cycle ac/dc power).
  - g) Reset the zero-span trigger of the spectrum analyzer, then repeat 7.11.2f) twice to ensure that the spectrum analyzer is reliably triggered, resetting the EUT (e.g., cycle ac/dc power) after each oscillation event if necessary.
  - h) Reset the zero-span sweep trigger of the spectrum analyzer, and reset the EUT (e.g., cycle ac/dc power).
  - i) Force the EUT into oscillation by reducing the attenuation.
  - j) Use the marker function of the spectrum analyzer to measure the time from the onset of oscillation until the EUT turns off, by setting Marker 1 on the leading edge of the oscillation signal and Marker 2 on the trailing edge. The spectrum analyzer sweep time may be adjusted to improve the time resolution of these cursors.
  - k) Capture the spectrum analyzer zero-span trace for inclusion in the test report. Report the power level associated with the oscillation separately if it can't be displayed on the trace.
  - l) Repeat 7.11.2b) to 7.11.2k) for all operational uplink and downlink bands.
  - m) Set the spectrum analyzer zero-span sweep time for longer than 60 seconds, then measure the restart time for each operational uplink and downlink band.
  - n) Replace the normal-operating mode EUT with the EUT that supports an anti-oscillation test mode.
  - o) Set the spectrum analyzer zero-span time for a minimum of 120 seconds, and a single sweep.
  - p) Manually trigger the spectrum analyzer zero-span sweep, and manually force the booster into oscillation as described in 7.11.2i).
  - q) When the sweep is complete, place cursors between the first two oscillation detections, and save the Test Plots for inclusion in the test report. The time between restarts must match the manufacturer's timing for the test mode, and there shall be no more than 5 restarts.
  - r) Repeat 7.11.2m) to 7.11.2q) for all operational uplink and downlink bands.

**Test procedure for measuring oscillation mitigation or shutdown**

- a) Connect the normal-operating mode EUT to the test equipment as shown in Figure 8.
- b) Set the spectrum analyzer center frequency to the center of band under test, and use the following settings:
  - 1) RBW=30 kHz, VBW  $\geq 3 \times$  RBW,
  - 2) power averaging (rms) detector,
  - 3) trace averages  $\geq 100$ ,
  - 4) span  $\geq 120\%$  of operational band under test

	<p>5) number of sweep points <math>\geq 2 \times \text{Span}/\text{RBW}</math>.</p> <p>c) Configure the signal generator for AWGN operation with a 99% OBW of 4.1 MHz, tuned to the frequency of 2.5 MHz above the lower edge or below the upper edge of the operating band under test. Adjust the RF output level of the signal generator such that the measured power level of the AWGN signal at the output port of the booster is 30 dB less than the maximum power of the booster for the band under test. Affirm that the input signal is not obstructing the measurement of the strongest oscillation peak in the band, and is not included within the span in the measurement.</p> <p>1) Boosters with operating spectrum passbands of 10 MHz or less may use a CW signal source at the band edge rather than AWGN.</p> <p>2) For device passbands greater than 10 MHz, standard CMRS signal sources (i.e., CDMA, W-CDMA, LTE) may be used instead of AWGN at the band edge.</p> <p>d) Set the variable attenuator to a high attenuation setting such that the booster will operate at maximum gain when powered on. Reset the the EUT (e.g., cycle ac/dc power). Allow the EUT to complete its boot-up process, to reach full operational gain, and to stabilize its operation.</p> <p>e) Set the variable attenuator such that the insertion loss for the center of the band under test (isolation) between the booster donor port and server port is 5 dB greater than the maximum gain, as recorded in the maximum gain test procedure (see 7.3), for the band under test.</p> <p>f) Verify the EUT shuts down, i.e., to mitigate the oscillations. If the booster does not shut down, measure and verify the peak oscillation level as follows.</p> <p>1) Allow the spectrum analyzer trace to stabilize.</p> <p>2) Place the marker at the highest oscillation level occurring within the span, and record its output level and frequency.</p> <p>3) Set the spectrum analyzer center frequency to the frequency with the highest oscillation signal level, and reduce the span such that the upper and lower adjacent oscillation peaks are within the span.</p> <p>4) Use the Minimum Search Marker function to find the lowest output level that is within the span, and within the operational band under test, and record its output level and frequency.</p> <p>5) Affirm that the peak oscillation level measured in 7.11.3f2), does not exceed by 12.0 dB the minimal output level measured in 7.11.3f4). Record the measurement results of 7.11.3f2) and 7.11.3f4) in tabular format for inclusion in the test report.</p> <p>6) The procedure of 7.11.3f1) to 7.11.3f5) allows the spectrum analyzer trace to stabilize, and verification of shutdown or oscillation level measurement must occur within 300 seconds.</p> <p>g) Decrease the variable attenuator in 1 dB steps, and repeat step 7.11.3f) for each 1 dB step. Continue testing to the level when the insertion loss for the center of band under test (isolation) between the booster donor port and server port is 5 dB lower than the maximum gain (see 7.3).</p> <p>h) Repeat 7.11.3a) to 7.11.3g) for all operational uplink and downlink bands.</p>
--	---

<b>Test results:</b>	<b>PASS</b>
----------------------	-------------

**5.10.2. Test Instruments**

Equipment	Manufacturer	Model	S/N	Calibration Date	Calibration Due
Spectrum Analyzer	R&S	FSV40-N	102188	Feb. 01, 2024	Jan. 31, 2025
Attenuation	AF115A-09-34	JFW	907763	/	/
RF Combiner	SUNVNDN	SUD-CS0800	162300 09	/	/
AN03468	Band Pass Filter	4CS10-781.5/E12.2-O/O	/	/	/
AN03469	Band Pass Filter	4CS10-751.5/E12-O/O	/	/	/
AN02475	1 dB step Attenuator	8494B	/	/	/
AN03429	10dB step Attenuator	8496B	/	/	/
ANC00082	RF Coupler	722-10-1.500V	/	/	/

**5.10.3. Test Data**

Test results of detection time				
Operation Bands		Detection Time (s)	Limit (s)	Result
Uplink	PCS	0.215	0.300	PASS
	AWS	0.215	0.300	PASS
	Cellular	0.215	0.300	PASS
	Lower700MHz	0.220	0.300	PASS
	Upper700MHz	0.213	0.300	PASS
Downlink	PCS	0.220	1.000	PASS
	AWS	0.223	1.000	PASS
	Cellular	0.220	1.000	PASS
	Lower700MHz	0.240	1.000	PASS
	Upper700MHz	0.220	1.000	PASS

Test results of restarting time						
Operation Bands		Restarting Time(s)	Limit (s)	Restarting Counts	Limit	Result
Uplink	PCS	69.47	60	2	5	PASS
	AWS	68.48	60	3	5	PASS
	Cellular	66.99	60	1	5	PASS
	Lower700 MHz	68.48	60	1	5	PASS
	Upper700 MHz	67.49	60	1	5	PASS
Downlink	PCS	70.13	60	1	5	PASS
	AWS	69.14	60	1	5	PASS
	Cellular	67.49	60	1	5	PASS
	Lower700 MHz	70.13	60	1	5	PASS
	Upper700 MHz	69.47	60	1	5	PASS

Note: All the RF path have been tested, only the worst-case DL path (The table below is listed) reported.

Band	Uplink	Downlink
PCS	Sever1-Donor	Donor- Sever4
AWS	Sever1-Donor	Donor- Sever4
Cellular	Sever2-Donor	Donor- Sever1
Lower700	Sever2-Donor	Donor- Sever2
Upper700	Sever4-Donor	Donor- Sever2

Test Plots of detection time

PCS UL

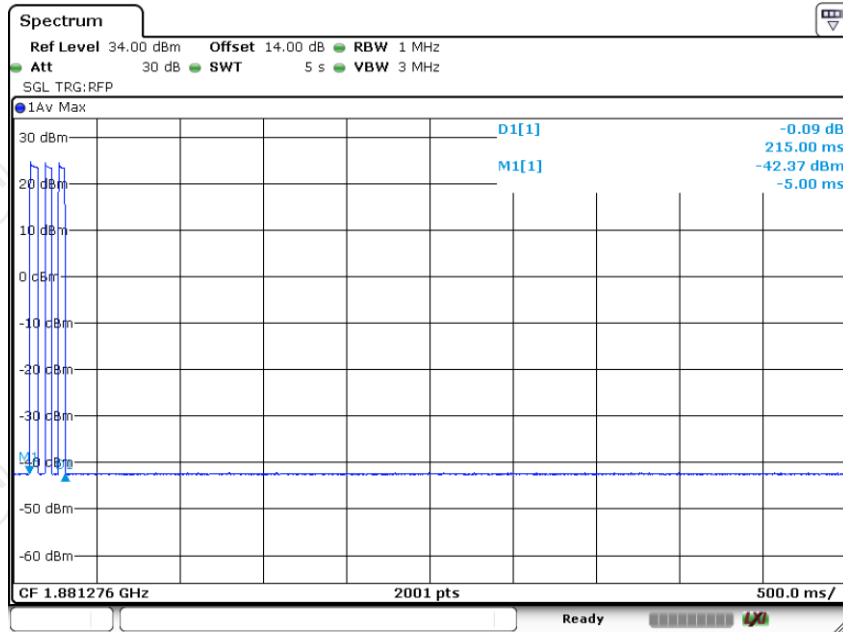

Date: 19.NOV.2024 09:17:03

PCS DL

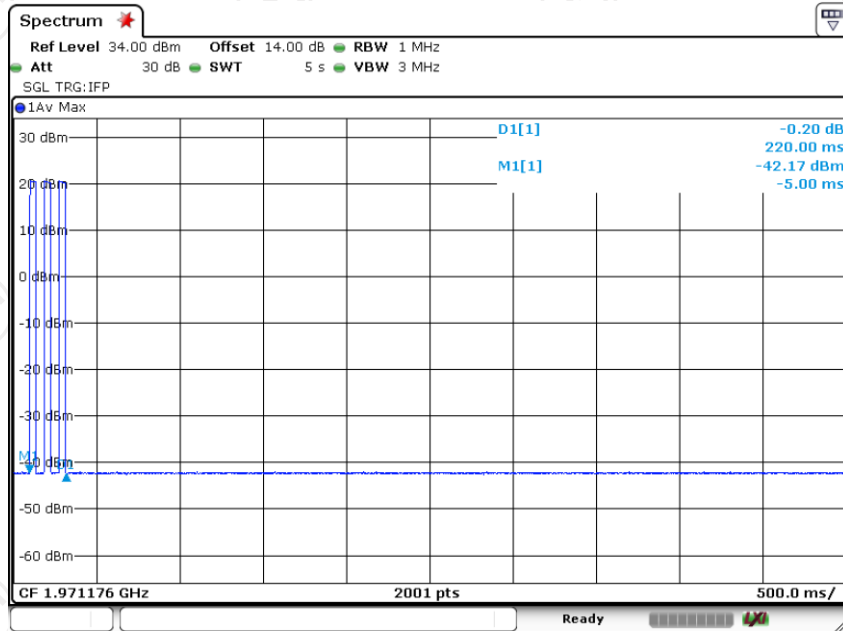

Date: 19.NOV.2024 09:32:18

**AWS UL**

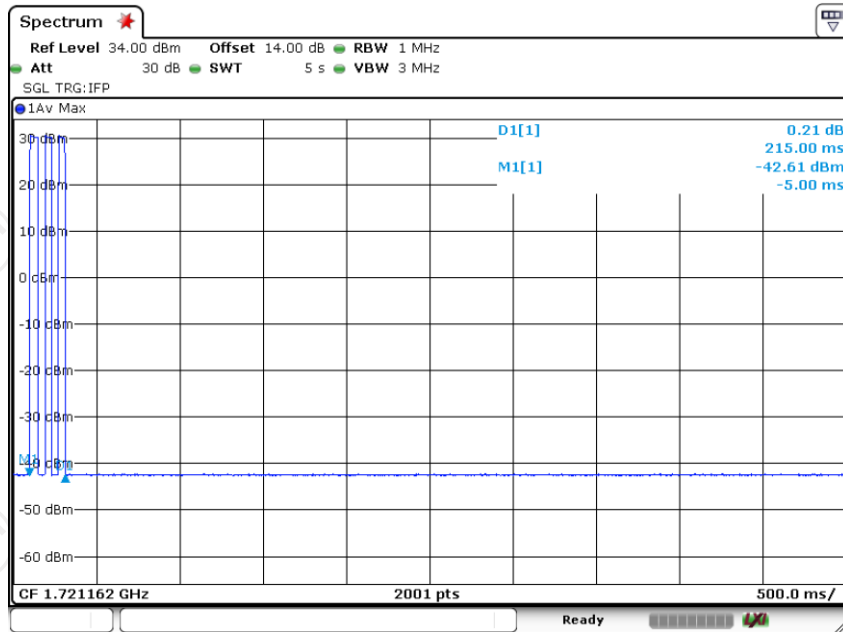

Date: 18.NOV.2024 16:37:33

**AWS DL**

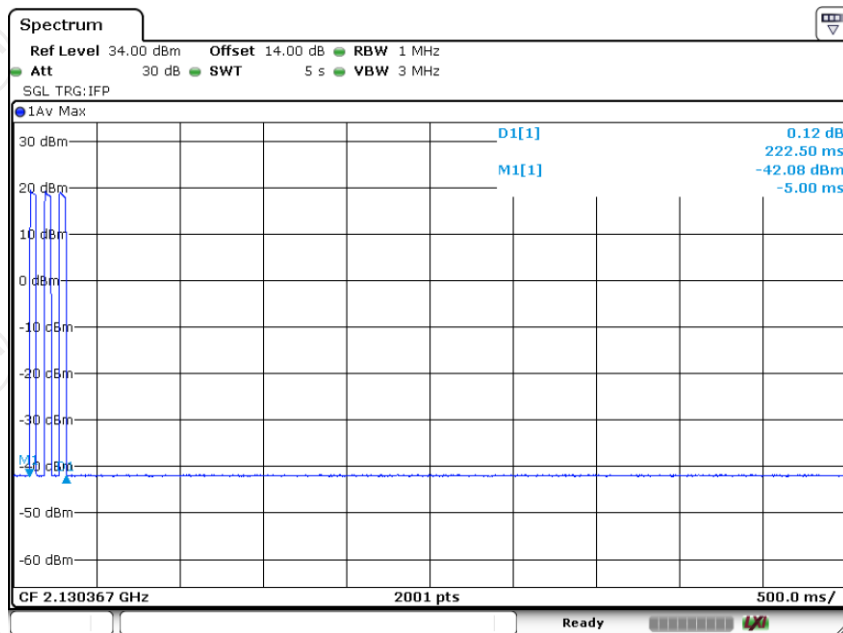

Date: 19.NOV.2024 09:56:24

Cellular UL

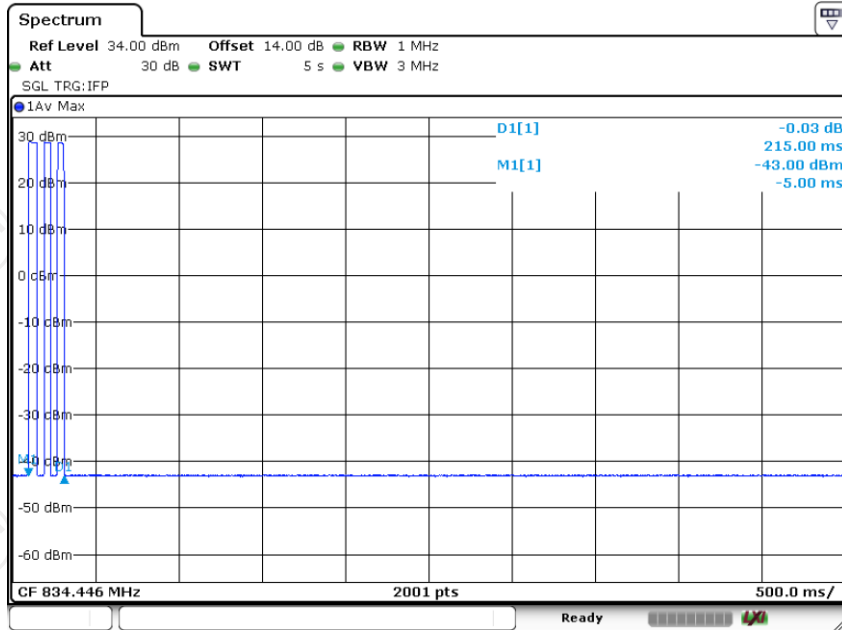

Date: 18.NOV.2024 16:17:51

Cellular DL

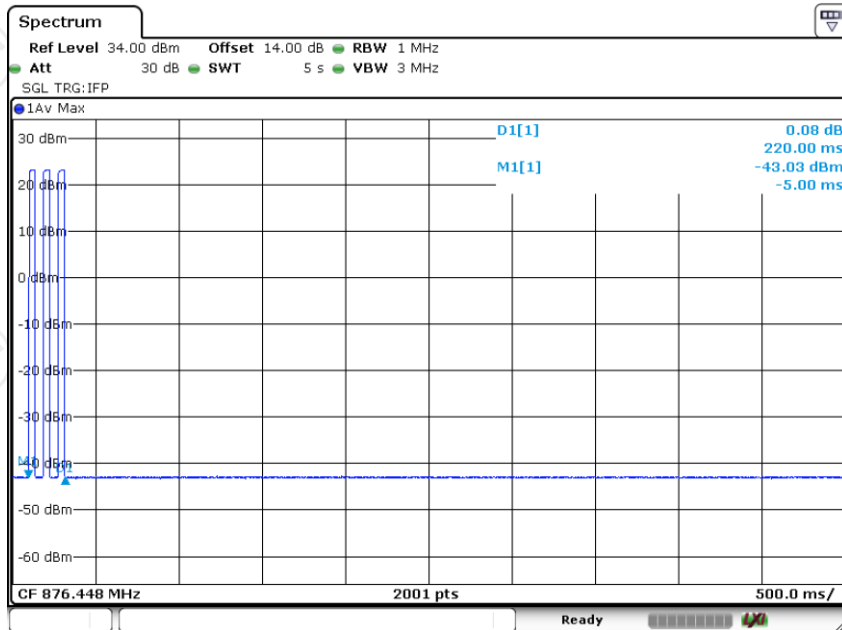

Date: 19.NOV.2024 10:28:27



## Lower700MHz UL

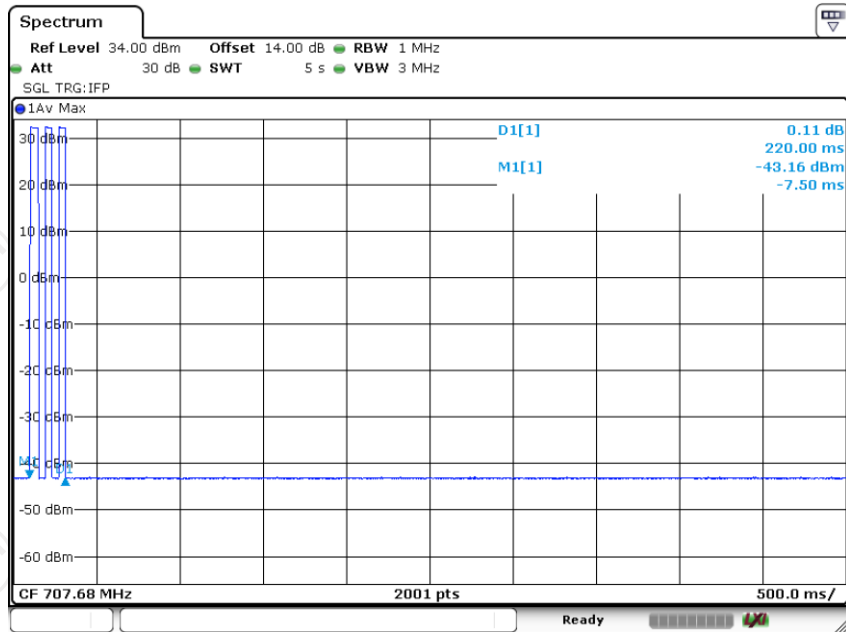

Date: 18.NOV.2024 15:20:42

## Lower700MHz DL

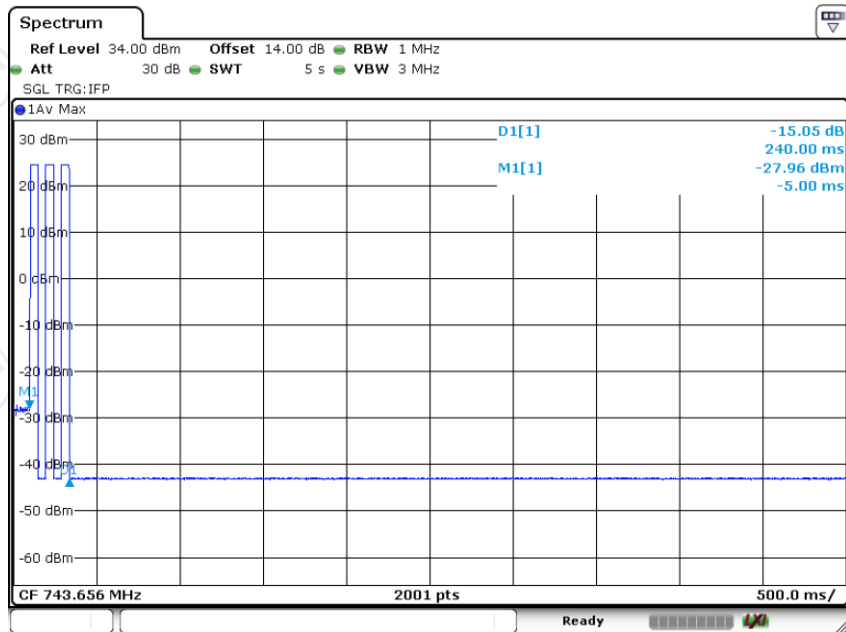

Date: 19.NOV.2024 10:42:34

Upper700MHz UL

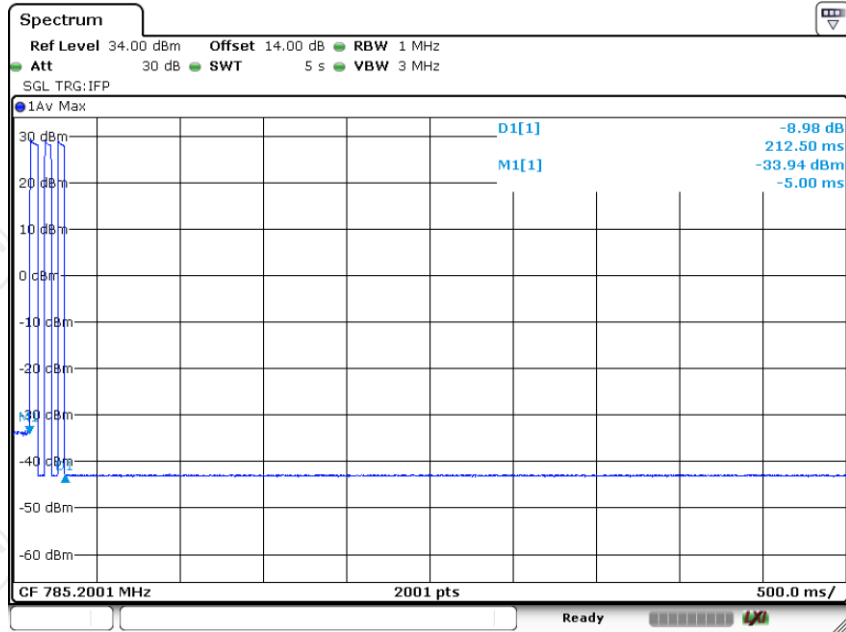

Date: 18.NOV.2024 16:01:50

Upper700MHz DL

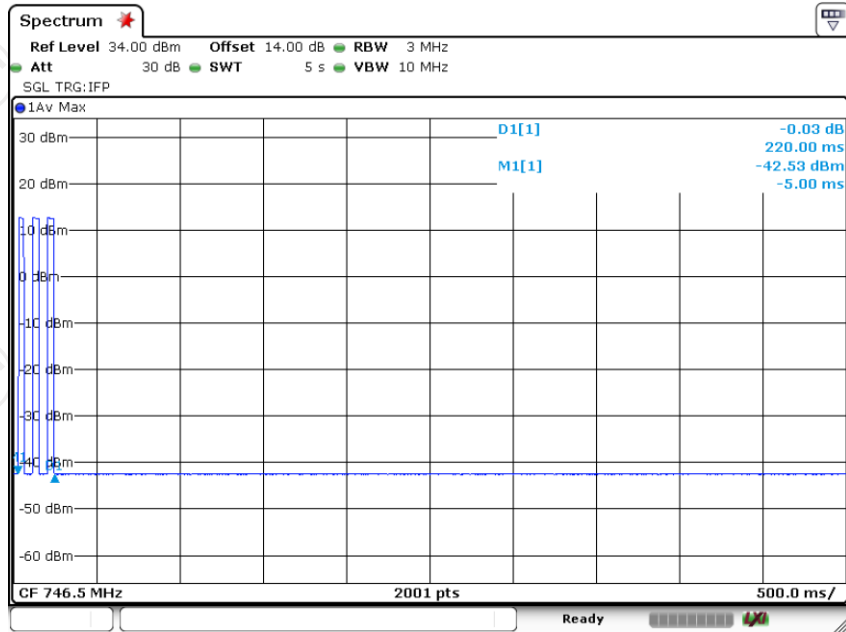

Date: 19.NOV.2024 10:54:57

Test Plots of restarting time

PCS UL

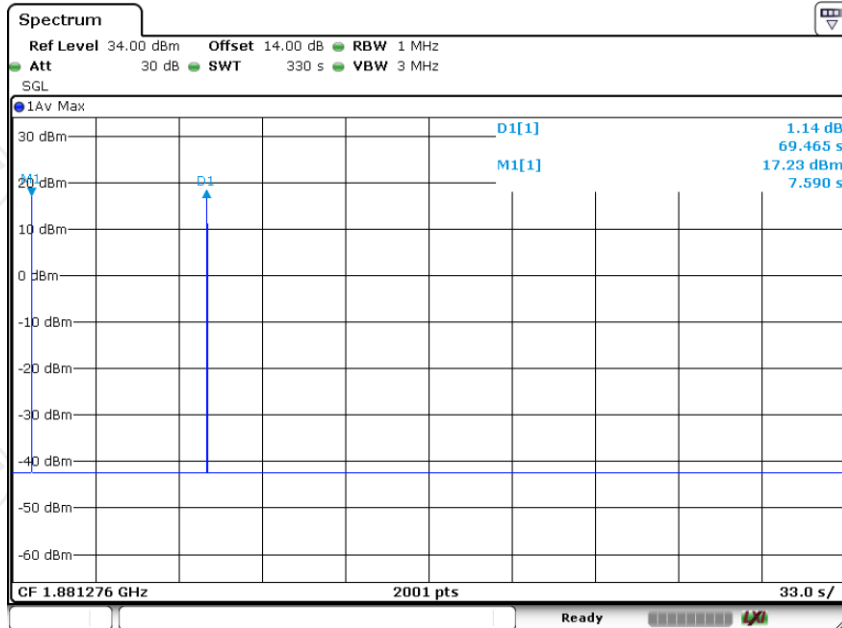

Date: 19.NOV.2024 09:24:13

PCS DL

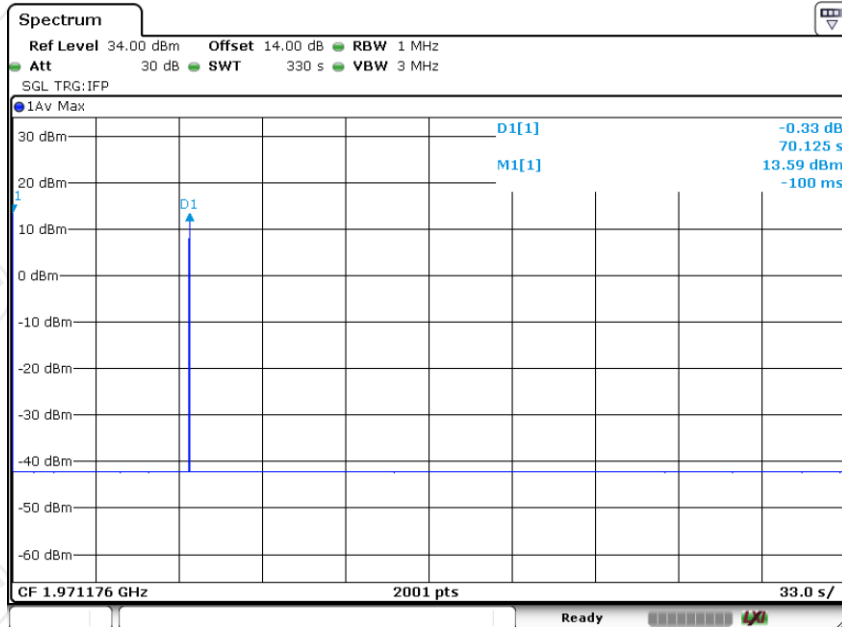

Date: 19.NOV.2024 09:52:34

**AWS UL**

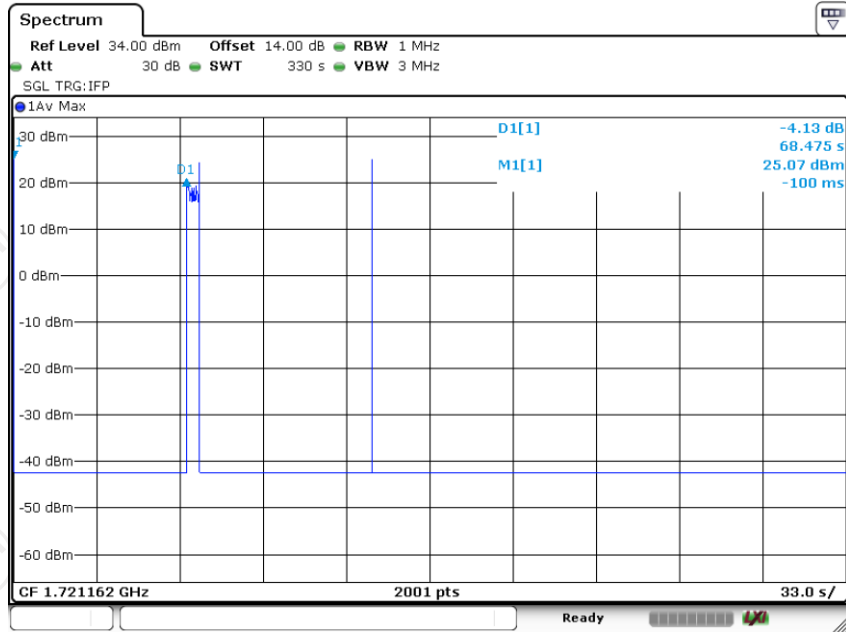

Date: 18.NOV.2024 16:44:22

**AWS DL**

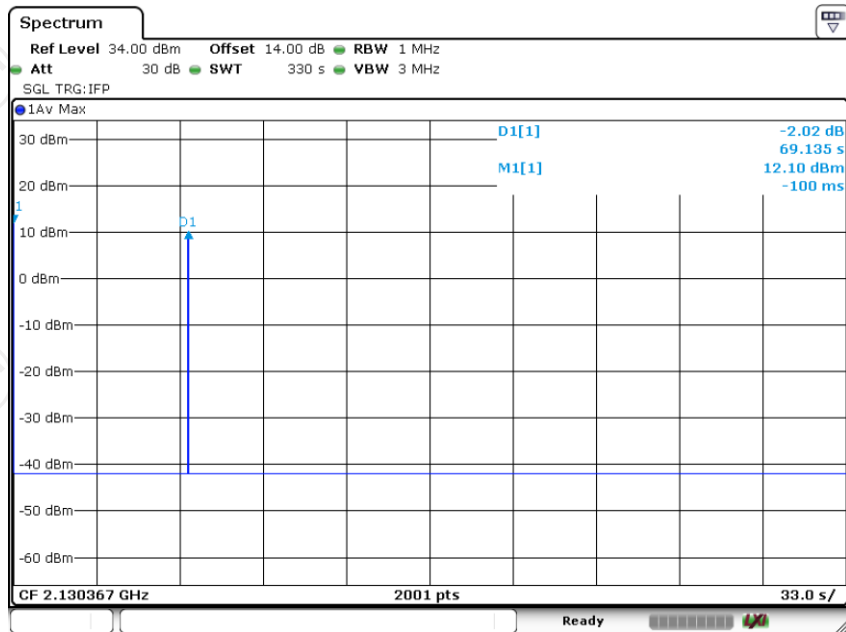

Date: 19.NOV.2024 10:19:00

## Cellular UL

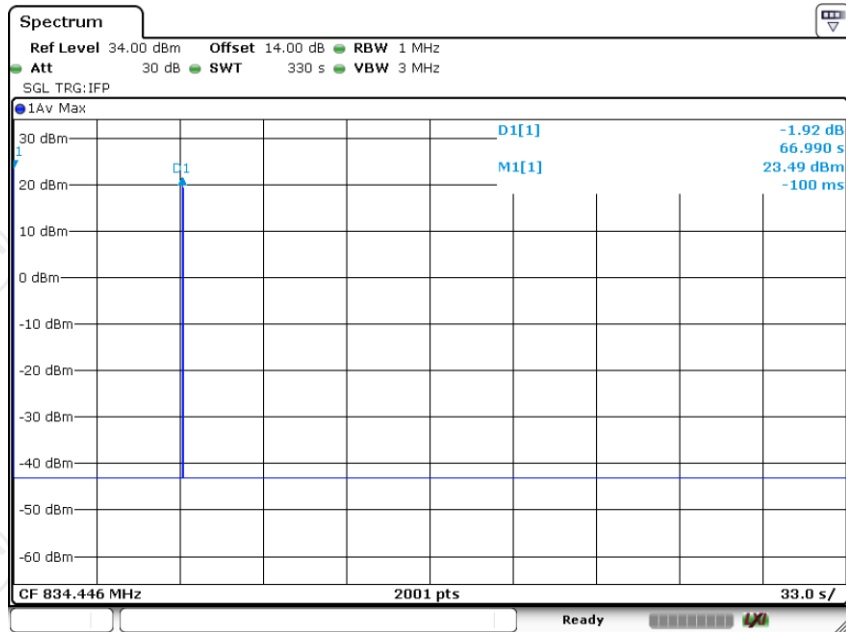

Date: 18.NOV.2024 16:26:36

## Cellular DL

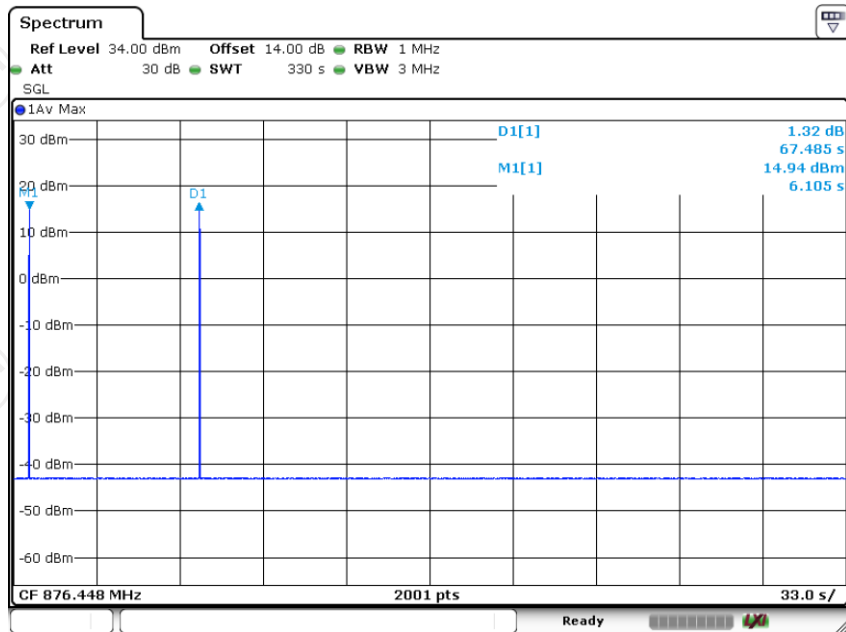

Date: 19.NOV.2024 10:35:11

## Lower700MHz UL

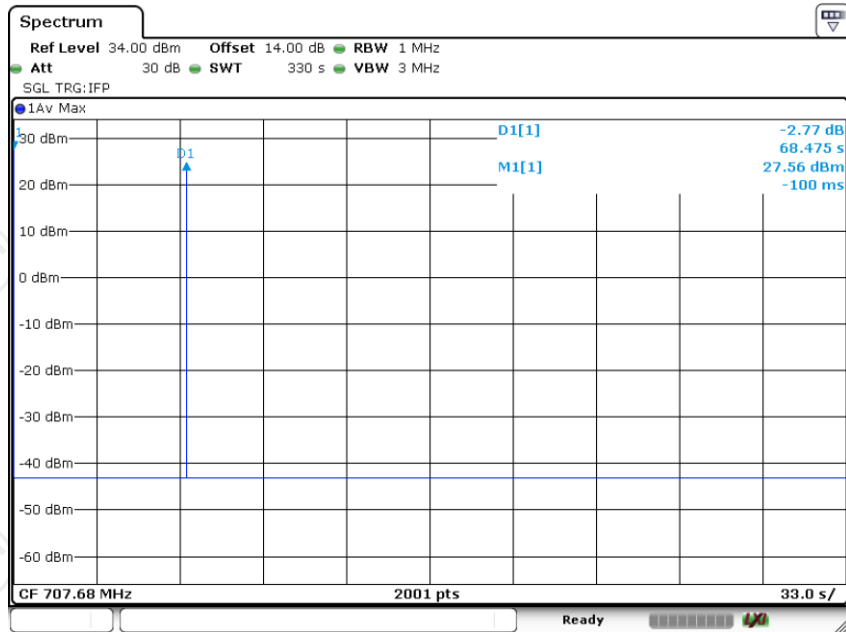

Date: 18.NOV.2024 15:30:56

## Lower700MHz DL

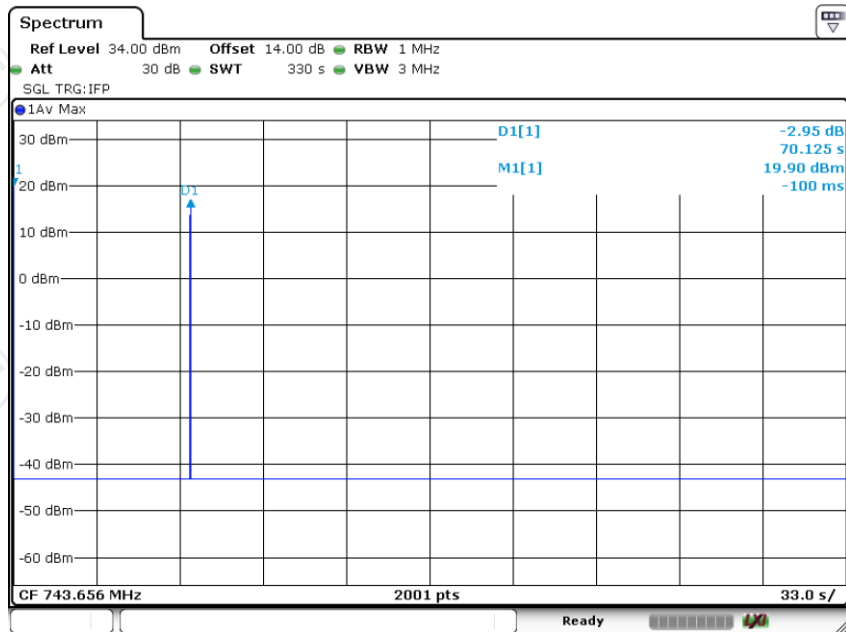

Date: 19.NOV.2024 10:49:25

Upper700MHz UL

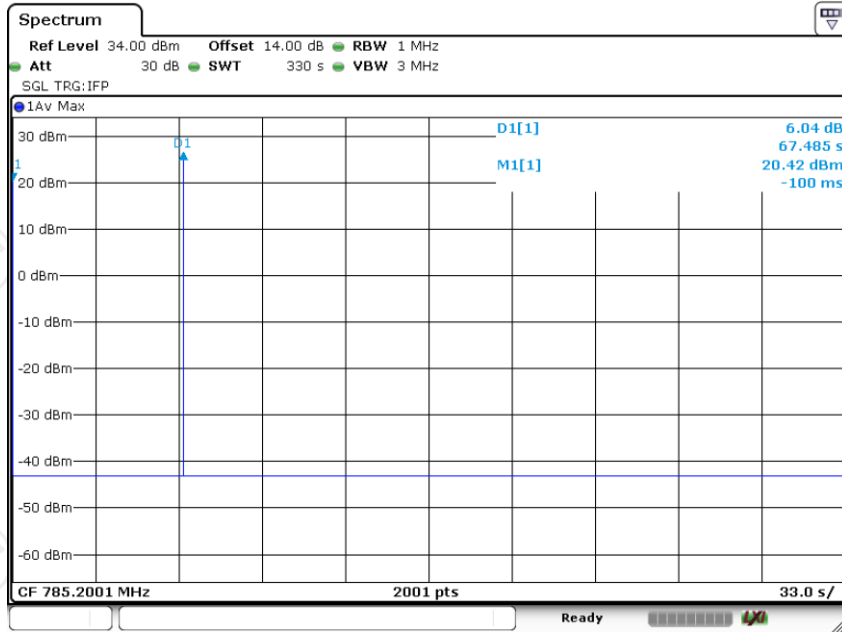

Date: 18.NOV.2024 16:09:40

Upper700MHz DL

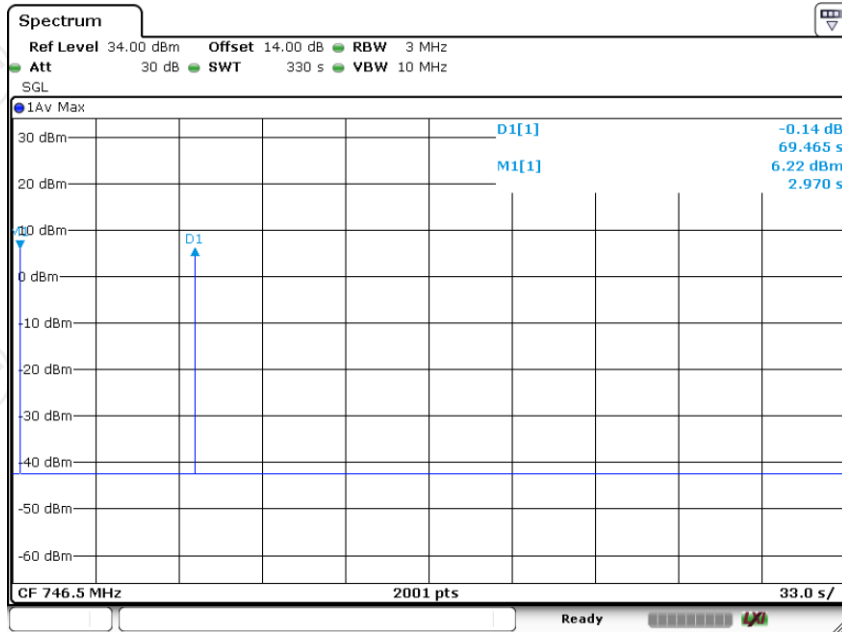

Date: 19.NOV.2024 11:01:42

Test results of Mitigation or Shutdown

PCS	Uplink(1850-1915MHz)								
Signal Type	AWGN								
Isolation	Peak Oscillations		Minimal Level		Delta Value	Limit	Time to Mitigate Oscillation	Mitigation Time Limit	Result
	Freq.	Level	Freq.	Level					
dB	MHz	dBm	MHz	dBm	dB	dB	sec	sec	
+5	1886.07	-49.26	1888.88	-55.31	6.05	<12	62	300	Pass
+4	1886.07	-48.21	1888.88	-55.25	7.04	<12	66	300	Pass
+3	1886.07	-47.71	1888.88	-55.83	8.12	<12	65	300	Pass
+2	1886.07	-47.11	1888.88	-56.02	8.91	<12	68	300	Pass
+1	1886.07	-44.25	1888.88	-57.29	13.04	<12	65	300	Pass
0	1886.07	-43.03	1888.88	-57.49	14.46	<12	68	300	Pass
-1	1886.07	-41.07	1888.88	-57.42	16.35	<12	65	300	Pass
-2	1886.07	-39.22	1888.88	-58.77	19.55	<12	66	300	Pass
-3	1886.07	-38.98	1888.88	-58.39	19.41	<12	67	300	Pass
-4	1886.07	-39.72	1888.88	-59.42	19.70	<12	67	300	Pass
-5	EUT Shutdown								

PCS	Downlink(1930-1995MHz)								
Signal Type	AWGN								
Isolation	Peak Oscillations		Minimal Level		Delta Value	Limit	Time to Mitigate Oscillation	Mitigation Time Limit	Result
	Freq.	Level	Freq.	Level					
dB	MHz	dBm	MHz	dBm	dB	dB	sec	sec	
+5	1949.28	-48.77	1951.13	-58.53	9.76	<12	67	300	Pass
+4	1949.28	-47.57	1951.13	-57.82	10.25	<12	68	300	Pass
+3	1949.28	-47.57	1951.13	-58.94	11.37	<12	65	300	Pass
+2	1949.28	-43.00	1951.13	-58.96	15.96	<12	66	300	Pass
+1	1949.28	-40.73	1951.13	-59.83	19.10	<12	68	300	Pass
0	1949.28	-34.14	1951.13	-59.42	25.28	<12	67	300	Pass
-1	1949.28	-33.56	1951.13	-60.33	26.77	<12	67	300	Pass
-2	EUT Shutdown								



AWS		Uplink(1710-1755MHz)							
Signal Type		AWGN							
Isolation	Peak Oscillations		Minimal Level		Delta Value	Limit	Time to Mitigate Oscillation	Mitigation Time Limit	Result
	Freq.	Level	Freq.	Level					
dB	MHz	dBm	MHz	dBm	dB	dB	sec	sec	
+5	1726.57	-49.50	1729.02	-58.14	8.64	<12	60	300	Pass
+4	1726.57	-48.12	1729.02	-57.18	9.06	<12	67	300	Pass
+3	1726.57	-46.50	1729.02	-58.11	11.61	<12	70	300	Pass
+2	1726.57	-46.87	1729.02	-58.86	11.99	<12	68	300	Pass
+1	1726.57	-43.30	1729.02	-58.51	15.21	<12	68	300	Pass
0	1726.57	-43.10	1729.02	-58.68	15.58	<12	70	300	Pass
-1	1726.57	-35.69	1729.02	-59.63	23.94	<12	68	300	Pass
-2	1726.57	8.53	1729.02	-58.83	67.36	<12	66	300	Pass
-3	EUT Shutdown								

AWS		Downlink(2110-2155MHz)							
Signal Type		AWGN							
Isolation	Peak Oscillations		Minimal Level		Delta Value	Limit	Time to Mitigate Oscillation	Mitigation Time Limit	Result
	Freq.	Level	Freq.	Level					
dB	MHz	dBm	MHz	dBm	dB	dB	sec	sec	
+5	2140.07	-50.70	2142.53	-59.31	8.61	<12	66	300	Pass
+4	2140.07	-49.99	2142.53	-59.30	9.31	<12	67	300	Pass
+3	2140.07	-49.30	2142.53	-58.41	9.11	<12	68	300	Pass
+2	2140.07	-46.80	2142.53	-59.87	13.07	<12	66	300	Pass
+1	2140.07	-45.29	2142.53	-60.21	14.92	<12	67	300	Pass
0	2140.07	-42.11	2142.53	-60.18	18.07	<12	68	300	Pass
-1	2140.07	-37.79	2142.53	-60.20	22.41	<12	67	300	Pass
-2	EUT Shutdown								

Cellular	Uplink(824-849MHz)								
Signal Type	AWGN								
Isolation	Peak Oscillations		Minimal Level		Delta Value	Limit	Time to Mitigate Oscillation	Mitigation Time Limit	Result
	Freq.	Level	Freq.	Level					
dB	MHz	dBm	MHz	dBm	dB	dB	sec	sec	
+5	834.88	-53.90	833.32	-61.80	7.90	<12	66	300	Pass
+4	834.88	-52.79	833.32	-61.98	9.19	<12	67	300	Pass
+3	834.88	-51.66	833.32	-62.48	10.82	<12	65	300	Pass
+2	834.88	-50.87	833.32	-62.60	11.73	<12	67	300	Pass
+1	834.88	-48.86	833.32	-62.86	14.00	<12	67	300	Pass
0	834.88	-47.67	833.32	-62.65	14.98	<12	67	300	Pass
-1	834.88	-44.67	833.32	-63.39	18.72	<12	68	300	Pass
-2	834.88	-37.56	833.32	-63.54	25.98	<12	60	300	Pass
-3	EUT Shutdown								

Cellular	Downlink(869-894MHz)								
Signal Type	AWGN								
Isolation	Peak Oscillations		Minimal Level		Delta Value	Limit	Time to Mitigate Oscillation	Mitigation Time Limit	Result
	Freq.	Level	Freq.	Level					
dB	MHz	dBm	MHz	dBm	dB	dB	sec	sec	
+5	879.28	-52.50	880.20	-59.59	7.09	<12	63	300	Pass
+4	879.28	-51.90	880.20	-59.60	7.70	<12	62	300	Pass
+3	879.28	-50.88	880.20	-59.77	8.89	<12	65	300	Pass
+2	879.28	-50.59	880.20	-60.18	9.59	<12	67	300	Pass
+1	879.28	-48.92	880.20	-60.80	11.88	<12	68	300	Pass
0	879.28	-47.15	880.20	-61.48	14.33	<12	68	300	Pass
-1	879.28	-44.67	880.20	-61.80	17.13	<12	67	300	Pass
-2	879.28	-40.94	880.20	-61.88	20.94	<12	67	300	Pass
-3	879.28	-27.06	880.20	-61.88	34.82	<12	63	300	Pass
-4	EUT Shutdown								

Lower700M Hz	Uplink(698-716MHz)								
Signal Type	AWGN								
Isolation	Peak Oscillations		Minimal Level		Delta Value	Limit	Time to Mitigate Oscillation	Mitigation Time Limit	Result
	Freq.	Level	Freq.	Level					
dB	MHz	dBm	MHz	dBm	dB	dB	sec	sec	
+5	706.82	-53.15	705.65	-62.12	8.97	<12	66	300	Pass
+4	706.82	-52.80	705.65	-62.65	9.85	<12	65	300	Pass
+3	706.82	-49.80	705.65	-63.10	13.30	<12	67	300	Pass
+2	706.82	-48.97	705.65	-62.77	13.80	<12	67	300	Pass
+1	706.82	-46.59	705.65	-63.85	17.26	<12	68	300	Pass
0	706.82	-44.07	705.65	-64.31	20.24	<12	66	300	Pass
-1	706.82	-31.04	705.65	-64.11	33.07	<12	65	300	Pass
-2	706.82	13.29	705.65	-64.07	77.36	<12	65	300	Pass
-3	EUT Shutdown								

Lower700M Hz	Downlink(728-746MHz)								
Signal Type	AWGN								
Isolation	Peak Oscillations		Minimal Level		Delta Value	Limit	Time to Mitigate Oscillation	Mitigation Time Limit	Result
	Freq.	Level	Freq.	Level					
dB	MHz	dBm	MHz	dBm	dB	dB	sec	sec	
+5	744.55	-56.75	742.82	-62.79	6.04	<12	63	300	Pass
+4	744.55	-55.24	742.82	-63.34	8.10	<12	65	300	Pass
+3	744.55	-54.17	742.82	-63.80	9.63	<12	64	300	Pass
+2	744.55	-53.70	742.82	-63.27	9.57	<12	62	300	Pass
+1	744.55	-52.15	742.82	-63.72	11.57	<12	63	300	Pass
0	744.55	-50.41	742.82	-64.30	13.89	<12	58	300	Pass
-1	744.55	-48.04	742.82	-63.98	15.94	<12	65	300	Pass
-2	744.55	-42.95	742.82	-64.59	21.64	<12	67	300	Pass
-3	744.55	-31.01	742.82	-64.57	33.56	<12	66	300	Pass
-4	EUT Shutdown								

Upper700M Hz	Uplink(776-787MHz)								
Signal Type	AWGN								
Isolation	Peak Oscillations		Minimal Level		Delta Value	Limit	Time to Mitigate Oscillation	Mitigation Time Limit	Result
	Freq.	Level	Freq.	Level					
dB	MHz	dBm	MHz	dBm	dB	dB	sec	sec	
+5	785.48	-54.64	786.62	-62.47	7.83	<12	63	300	Pass
+4	785.48	-52.74	786.62	-62.44	9.70	<12	65	300	Pass
+3	785.48	-51.99	786.62	-63.22	11.23	<12	66	300	Pass
+2	785.48	-51.67	786.62	-62.58	10.91	<12	67	300	Pass
+1	785.48	-50.05	786.62	-63.29	13.24	<12	70	300	Pass
0	785.48	-46.29	786.62	-63.50	17.21	<12	66	300	Pass
-1	785.48	-38.06	786.62	-62.89	24.83	<12	67	300	Pass
-2	EUT Shutdown								

Upper700M Hz	Downlink(746-757MHz)								
Signal Type	AWGN								
Isolation	Peak Oscillations		Minimal Level		Delta Value	Limit	Time to Mitigate Oscillation	Mitigation Time Limit	Result
	Freq.	Level	Freq.	Level					
dB	MHz	dBm	MHz	dBm	dB	dB	sec	sec	
+5	747.59	-58.36	749.09	-63.87	5.51	<12	66	300	Pass
+4	747.59	-57.93	749.09	-64.57	6.64	<12	63	300	Pass
+3	747.59	-57.20	749.09	-64.26	7.06	<12	64	300	Pass
+2	747.59	-56.17	749.09	-65.39	9.22	<12	67	300	Pass
+1	747.59	-55.86	749.09	-64.99	9.13	<12	65	300	Pass
0	747.59	-53.59	749.09	-65.73	12.14	<12	68	300	Pass
-1	747.59	-50.57	749.09	-65.60	15.03	<12	65	300	Pass
-2	747.59	-47.18	749.09	-65.13	17.95	<12	61	300	Pass
-3	EUT Shutdown								

## 6. Radiation Spurious Emission

### 6.1.1. Test Specification

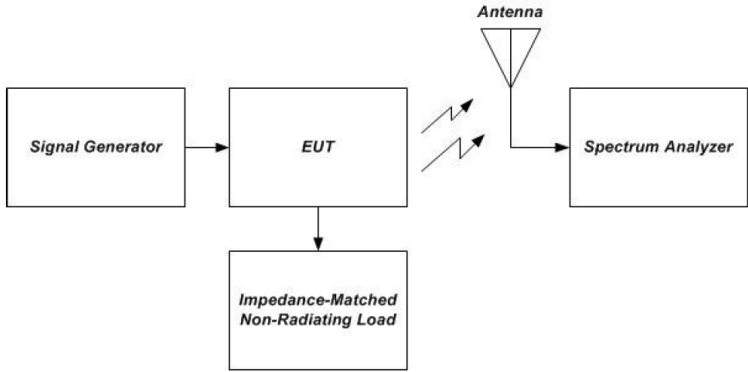
<b>Test Requirement:</b>	FCC Part2 Section 2.1053
<b>Test Method:</b>	KDB935210 D03 Signal booster Measurements v04r04
<b>Limit:</b>	-13dBm; For equipment operating in the frequency bands 746-757 MHz and 776-787 MHz, The e.i.r.p. in the band 1559-1610 MHz shall not exceed -70 dBW/MHz for wideband signal and -80 dBW for discrete emission with bandwidth less than 700 Hz.
<b>Test setup:</b>	 <p style="text-align: center;">Figure 10 – Radiated spurious emissions test and instrumentation setup</p>
<b>Test Procedure:</b>	<ol style="list-style-type: none"> <li>a) Place the EUT on an OATS or semi-anechoic chamber turntable 3 m from the receiving antenna.</li> <li>b) Connect the EUT to the test equipment as shown in Figure 10 beginning with the uplink output (donor) port.</li> <li>c) Set the signal generator to produce a CW signal with the frequency set to the center of the operational band under test, and the power level set at PIN as determined from measurement results per 7.2.</li> <li>d) Measure the radiated spurious emissions from the EUT from the lowest to the highest frequencies as specified in § 2.1057. Maximize the radiated emissions by using the procedures described in ANSI C63.4.</li> <li>e) Capture the peak emissions Test Plots using a peak detector with Max-Hold for inclusion in the test report. Tabular data is acceptable in lieu of spectrum analyzer Test Plots.</li> <li>f) Repeat 7.12c) through 7.12e) for all uplink and downlink operational bands.</li> </ol>

Test results:

PASS

**6.1.2. Test Instruments**

Radiated Emission				
Name	Model No.	Manufacturer	Date of Cal.	Due Date
EMI Test Receiver	ESCI7	R&S	Feb. 01, 2024	Jan. 31, 2025
Spectrum Analyzer	FSQ40	R&S	Jun. 27, 2024	Jun. 26, 2025
Pre-amplifier	8447D	HP	Jun. 27, 2024	Jun. 26, 2025
Pre-amplifier	LNPA_0118G-45	SKET	Feb. 01, 2024	Jan. 31, 2025
Pre-amplifier	LNPA_1840G-50	SKET	Feb. 01, 2024	Jan. 31, 2025
Broadband Antenna	VULB9163	Schwarzbeck	Jun. 29, 2024	Jun. 28, 2025
Horn Antenna	BBHA 9120D	Schwarzbeck	Jun. 29, 2024	Jun. 28, 2025
Horn Antenna	BBHA 9170	Schwarzbeck	Feb. 03, 2024	Feb. 02, 2025
Coaxial cable	RE-03-D	SKET	Jun. 27, 2024	Jun. 26, 2025
Coaxial cable	RE-03-M	SKET	Jun. 27, 2024	Jun. 26, 2025
Coaxial cable	RE-03-L	SKET	Jun. 27, 2024	Jun. 26, 2025
Coaxial cable	RE-04-D	SKET	Jun. 27, 2024	Jun. 26, 2025
Coaxial cable	RE-04-M	SKET	Jun. 27, 2024	Jun. 26, 2025
Coaxial cable	RE-04-L	SKET	Jun. 27, 2024	Jun. 26, 2025
Loop antenna	FMZB1519B	Schwarzbeck	Jun. 27, 2024	Jun. 26, 2025
Signal Generator	N5182A	Agilent	Feb. 01, 2024	Jan. 31, 2025

6.1.3. Test data

Frequency [MHz]	Antenna polarity [H/V]	Reading Level	Substitution factor	Measurement Level [dBm]	Limit [dBm]	Margin [dB]
<b>PCS Uplink</b>						
1152.15	H	-45.72	-7.85	-53.57	-13.00	-40.57
1882.30	V	-37.24	-6.20	-43.44		-30.44
11032.55	H	-61.56	15.54	-46.02		-33.02
11653.90	V	-63.51	13.28	-50.23		-37.23
<b>PCS Downlink</b>						
1152.15	H	-44.92	-8.32	-53.24	-13.00	-40.24
1151.30	V	-49.35	-7.57	-56.92		-43.92
14128.25	H	-61.39	16.62	-44.77		-31.77
13910.65	V	-61.71	17.66	-44.05		-31.05

Frequency [MHz]	Antenna polarity [H/V]	Reading Level	Substitution factor	Measurement Level [dBm]	Limit [dBm]	Margin [dB]
<b>AWS Uplink</b>						
1151.30	H	-45.83	-7.97	-53.80	-13.00	-40.80
1152.15	V	-46.88	-7.36	-54.24		-41.24
13990.550	H	-62.21	17.36	-44.85		-31.85
13950.600	V	-61.24	17.70	-43.54		-30.54
<b>AWS Downlink</b>						
1151.30	H	-44.83	-7.96	-52.79	-13.00	-39.79
1151.30	V	-50.08	-8.30	-58.38		-45.38
10488.55	H	-60.58	14.87	-45.71		-32.71
9275.60	V	-62.40	13.60	-48.80		-35.80

Frequency [MHz]	Antenna polarity [H/V]	Reading Level	Substitution factor	Measurement Level [dBm]	Limit [dBm]	Margin [dB]
<b>Cellular Uplink</b>						
1152.00	H	-44.89	-7.73	-52.62	-13.00	-39.62
1152.00	V	-46.76	-7.09	-53.85		-40.85
7927.60	H	-60.35	10.28	-50.07		-37.07
7098.40	V	-61.22	8.86	-52.36		-39.36
<b>Cellular Downlink</b>						
1152.00	H	-45.52	-7.68	-53.20	-13.00	-40.20
1152.00	V	-49.27	-7.61	-56.88		-43.88
7146.80	H	-60.68	9.14	-51.54		-38.54
6392.40	V	-60.39	7.56	-52.83		-39.83

Frequency [MHz]	Antenna polarity [H/V]	Reading Level	Substitution factor	Measurement Level [dBm]	Limit [dBm]	Margin [dB]
<b>Lower700MHz Uplink</b>						
1152.00	H	-52.94	-8.63	-61.57	-13.00	-48.57
1152.00	V	-47.30	-7.82	-55.12		-42.12
6805.20	H	-61.96	8.52	-53.44		-40.44
3532.40	V	-49.62	10.43	-39.19		-26.19
<b>Lower700MHz Downlink</b>						
1151.90	H	-43.84	-8.07	-51.91	-13.00	-38.91
1124.95	V	-53.93	-7.76	-61.69		-48.69
6443.90	H	-59.42	7.49	-51.93		-38.93
7146.35	V	-61.21	9.81	-51.40		-38.40



Frequency [MHz]	Antenna polarity [H/V]	Reading Level	Substitution factor	Measurement Level [dBm]	Limit [dBm]	Margin [dB]
<b>Upper700MHz Uplink</b>						
1152.00	H	-44.28	-7.79	-52.07	-13.00	-39.07
1152.00	V	-46.00	-6.63	-52.63		-39.63
7185.20	H	-60.97	9.23	-51.74		-38.74
6430.40	V	-59.42	7.55	-51.87		-38.87
1601.25	H	-62.01	-7.02	-69.03	-40.00	-29.03
1604.38	V	-64.99	-6.59	-71.58		-31.58
<b>Upper700MHz Downlink</b>						
1151.90	H	-51.46	-7.37	-58.83	-13.00	-45.83
1151.90	V	-52.15	-6.94	-59.09		-46.09
6413.10	H	-57.74	7.90	-49.84		-36.84
7113.10	V	-60.73	9.98	-50.75		-37.75
1606.61	H	-62.56	-7.67	-70.23	-40.00	-30.23
1602.54	V	-65.38	-6.50	-71.88		-31.88

## Appendix A: Photographs of Test Setup

Please refer to document Appendix No.: TCT241011E019-A

## Appendix B: Photographs of EUT

Please refer to document Appendix No.: TCT241011E019-B & TCT241011E019-C

**\*\*\*\*\*END OF REPORT\*\*\*\*\***