



FCC PART 15.407
DYNAMIC FREQUENCY SELECTION
TEST REPORT

For

Chuango Security Technology Corporation

6-17, Overseas Students Pioneer Park, No. 108, Jia, Economic & Technological Development Zone, Fuzhou, China

FCC ID: RJY-DBL

Report Type: Original Report	Product Type: Smart Video Doorbell
Report Number: <u>RSZ180302001-00</u>	
Report Date: <u>2018-03-19</u>	
Reviewed By: <u>Jerry Zhang EMC Manager</u>	<i>Jerry Zhang</i>
Test Laboratory: Bay Area Compliance Laboratories Corp. (Dongguan) No.69 Pulongcun, Puxinhu Industry Area, Tangxia, Dongguan, Guangdong, China Tel: +86-769-86858888 Fax: +86-769-86858891 www.baclcorp.com.cn	

Note: This test report is prepared for the customer shown above and for the device described herein. It may not be duplicated or used in part without prior written consent from Bay Area Compliance Laboratories Corp. (Dongguan). This report must not be used by the customer to claim product certification, approval, or endorsement by A2LA* or any agency of the Federal Government. * This report may contain data that are not covered by the A2LA accreditation and are marked with an asterisk “*”

TABLE OF CONTENTS

GENERAL INFORMATION.....	3
PRODUCT DESCRIPTION FOR EQUIPMENT UNDER TEST (EUT)	3
OBJECTIVE	3
TEST METHODOLOGY	3
TEST FACILITY	3
SYSTEM TEST CONFIGURATION.....	4
DESCRIPTION OF TEST CONFIGURATION	4
EUT EXERCISE SOFTWARE	4
EQUIPMENT MODIFICATIONS	4
SUPPORT EQUIPMENT LIST AND DETAILS	4
EXTERNAL CABLE.....	4
SUMMARY OF TEST RESULTS	5
APPLICABLE STANDARDS.....	6
DFS REQUIREMENT	6
DFS MEASUREMENT SYSTEM	10
SYSTEM BLOCK DIAGRAM	10
4.5 RADIATED METHOD	12
4.6 TEST PROCEDURE.....	12
TEST RESULTS.....	13
DESCRIPTION OF EUT	13
TEST EQUIPMENT LIST AND DETAILS.....	13
TEST ENVIRONMENTAL CONDITIONS	13
RADAR WAVEFORM CALIBRATION	14
CHANNEL MOVE TIME AND CHANNEL CLOSING TRANSMISSION TIME	17
TEST PROCEDURE	17
TEST RESULTS	17
NON-OCCUPANCY PERIOD.....	26
TEST PROCEDURE	26
TEST RESULT	26

GENERAL INFORMATION

Product Description for Equipment under Test (EUT)

EUT Name:	Smart Video Doorbell
EUT Model:	DB-20
Multiple Model:	WDB-70
FCC ID:	RJY-DBL
Rated Input Voltage:	DC 3.7V from battery
External Dimension:	131.7 mm (L) * 62.2 mm (W) * 36.2 mm (H)
Serial Number:	180302001
EUT Received Date:	2018.03.02

Note: The series product, models DB-20 and WDB-70 are electrically identical, we selected DB-20 for full test, and please refer to the declaration letter for details.

Objective

This report is prepared on behalf of *Chuango Security Technology Corporation* in accordance with Part 2-Subpart J, Part 15-Subparts E of the Federal Communications Commission's rules.

The objective is to determine compliance with FCC Part 15, Subpart E, section 15.407 Dynamic Frequency Selection (DFS) for devices operating in the bands 5250- 5350 MHz, 5470-5725 MHz.

Test Methodology

KDB 905462 D02 UNII DFS Compliance Procedures New Rules v02

Test Facility

The Test site used by Bay Area Compliance Laboratories Corp. (Dongguan) to collect test data is located on the No.69 Pulongcun, Puxinhu Industry Area, Tangxia, Dongguan, Guangdong, China.

The test site has been approved by the FCC under the KDB 974614 D01 and is listed in the FCC Public Access Link (PAL) database, FCC Registration No. : 897218, the FCC Designation No. : CN1220.

The test site has been registered with ISED Canada under ISED Canada Registration Number 3062D.

SYSTEM TEST CONFIGURATION

Description of Test Configuration

The EUT was configured for testing in an engineering mode which was provided by the manufacturer.

EUT Exercise Software

No exercise software was used.

Equipment Modifications

No modification was made to the EUT.

Support Equipment List and Details

Manufacturer	Description	Model	Serial Number
Lenovo	Notebook	E450	PF-0MRADG 16/08
HUAWEI	GPON Terminal	HG8245Q2	2102311RGB6RH1000087

Note: the master device HG8245Q2, FCC ID: QISHG8245Q2

External Cable

Cable Description	Shielding Type	Ferrite Core	Length (m)	From Port	To
RJ45 Cable	Yes	No	10	Note book	GPON Terminal

SUMMARY OF TEST RESULTS

The following result table represents the list of measurements required under the CFR47 §47 Part15.407 (h) and FCC KDB 905462 D02 UNII DFS Compliance Procedures New Rules v02

Items	Description of Test	Result
Detection Bandwidth	UNII Detection Bandwidth	Not applicable
Performance Requirements Check	Initial Channel Availability Check Time (CAC)	Not applicable
	Radar Burst at the Beginning of the CAC	Not applicable
	Radar Burst at the End of the CAC	Not applicable
In-Service Monitoring	Channel Move Time	Compliant
	Channel Closing Transmission Time	Compliant
	Non-Occupancy Period	Compliant
Radar Detection	Statistical Performance Check	Not applicable

Note:

- 1) Not applicable: the EUT is a client unit without radar detection.

APPLICABLE STANDARDS

DFS Requirement

FCC KDB 905462 D02 UNII DFS Compliance Procedures New Rules v02

Table 1: Applicability of DFS Requirements Prior to Use of a Channel

Requirement	Operational Mode		
	Master	Client Without Radar Detection	Client With Radar Detection
<i>Non-Occupancy Period</i>	Yes	Not required	Yes
<i>DFS Detection Threshold</i>	Yes	Not required	Yes
<i>Channel Availability Check Time</i>	Yes	Not required	Not required
<i>U-NII Detection Bandwidth</i>	Yes	Not required	Yes

Table 2: Applicability of DFS requirements during normal operation

Requirement	Operational Mode	
	Master Device or Client with Radar Detection	Client Without Radar Detection
<i>DFS Detection Threshold</i>	Yes	Not required
<i>Channel Closing Transmission Time</i>	Yes	Yes
<i>Channel Move Time</i>	Yes	Yes
<i>U-NII Detection Bandwidth</i>	Yes	Not required

Additional requirements for devices with multiple bandwidth modes	Master Device or Client with Radar Detection	Client Without Radar Detection
<i>U-NII Detection Bandwidth and Statistical Performance Check</i>	All BW modes must be tested	Not required
<i>Channel Move Time and Channel Closing Transmission Time</i>	Test using widest BW mode available	Test using the widest BW mode available for the link
<i>All other tests</i>	Any single BW mode	Not required
<p>Note: Frequencies selected for statistical performance check (Section 7.8.4) should include several frequencies within the radar detection bandwidth and frequencies near the edge of the radar detection bandwidth. For 802.11 devices it is suggested to select frequencies in each of the bonded 20 MHz channels and the channel center frequency.</p>		

Table 3: DFS Detection Thresholds for Master Devices and Client Devices With Radar Detection

Maximum Transmit Power	Value (See Notes 1, 2, and 3)
EIRP \geq 200 milliwatt	-64 dBm
EIRP < 200 milliwatt and power spectral density < 10 dBm/MHz	-62 dBm
EIRP < 200 milliwatt that do not meet the power spectral density requirement	-64 dBm
<p>Note 1: This is the level at the input of the receiver assuming a 0 dBi receive antenna.</p> <p>Note 2: Throughout these test procedures an additional 1 dB has been added to the amplitude of the test transmission waveforms to account for variations in measurement equipment. This will ensure that the test signal is at or above the detection threshold level to trigger a DFS response.</p> <p>Note 3: EIRP is based on the highest antenna gain. For MIMO devices refer to KDB Publication 662911 D01.</p>	

Table 4: DFS Response Requirement Values

Parameter	Value
<i>Non-occupancy period</i>	Minimum 30 minutes
<i>Channel Availability Check Time</i>	60 seconds
<i>Channel Move Time</i>	10 seconds See Note 1.
<i>Channel Closing Transmission Time</i>	200 milliseconds + an aggregate of 60 milliseconds over remaining 10 second period. See Notes 1 and 2.
<i>U-NII Detection Bandwidth</i>	Minimum 100% of the U-NII 99% transmission power bandwidth. See Note 3.
<p>Note 1: <i>Channel Move Time</i> and the <i>Channel Closing Transmission Time</i> should be performed with Radar Type 0. The measurement timing begins at the end of the Radar Type 0 burst.</p> <p>Note 2: The <i>Channel Closing Transmission Time</i> is comprised of 200 milliseconds starting at the beginning of the <i>Channel Move Time</i> plus any additional intermittent control signals required to facilitate a <i>Channel</i> move (an aggregate of 60 milliseconds) during the remainder of the 10 second period. The aggregate duration of control signals will not count quiet periods in between transmissions.</p> <p>Note 3: During the <i>U-NII Detection Bandwidth</i> detection test, radar type 0 should be used. For each frequency step the minimum percentage of detection is 90 percent. Measurements are performed with no data traffic.</p>	

Table 5 – Short Pulse Radar Test Waveforms

Radar Type	Pulse Width (μsec)	PRI (μsec)	Number of Pulses	Minimum Percentage of Successful Detection	Minimum Number of Trials
0	1	1428	18	See Note 1	See Note 1
1	1	Test A: 15 unique PRI values randomly selected from the list of 23 PRI values in Table 5a	Roundup $\left\{ \left(\frac{1}{360} \right) \cdot \left(\frac{19 \cdot 10^6}{PRI_{\mu sec}} \right) \right\}$	60%	30
		Test B: 15 unique PRI values randomly selected within the range of 518-3066 μsec, with a minimum increment of 1 μsec, excluding PRI values selected in Test A			
2	1-5	150-230	23-29	60%	30
3	6-10	200-500	16-18	60%	30
4	11-20	200-500	12-16	60%	30
Aggregate (Radar Types 1-4)				80%	120
Note 1: Short Pulse Radar Type 0 should be used for the detection bandwidth test, channel move time, and channel closing time tests.					

A minimum of 30 unique waveforms are required for each of the Short Pulse Radar Types 2 through 4. If more than 30 waveforms are used for Short Pulse Radar Types 2 through 4, then each additional waveform must also be unique and not repeated from the previous waveforms. If more than 30 waveforms are used for Short Pulse Radar Type 1, then each additional waveform is generated with Test B and must also be unique and not repeated from the previous waveforms in Tests A or B.

For example if in Short Pulse Radar Type 1 Test B a PRI of 3066 usec is selected, the number of pulses

would be $\text{Roundup} \left\{ \left(\frac{1}{360} \right) \cdot \left(\frac{19 \cdot 10^6}{3066} \right) \right\} = \text{Roundup} \{17.2\} = 18.$

Table 5a - Pulse Repetition Intervals Values for Test A

Pulse Repetition Frequency Number	Pulse Repetition Frequency (Pulses Per Second)	Pulse Repetition Interval (Microseconds)
1	1930.5	518
2	1858.7	538
3	1792.1	558
4	1730.1	578
5	1672.2	598
6	1618.1	618
7	1567.4	638
8	1519.8	658
9	1474.9	678
10	1432.7	698
11	1392.8	718
12	1355	738
13	1319.3	758
14	1285.3	778
15	1253.1	798
16	1222.5	818
17	1193.3	838
18	1165.6	858
19	1139	878
20	1113.6	898
21	1089.3	918
22	1066.1	938
23	326.2	3066

The aggregate is the average of the percentage of successful detections of Short Pulse Radar Types 1-4. For example, the following table indicates how to compute the aggregate of percentage of successful detections.

Radar Type	Number of Trials	Number of Successful Detections	Minimum Percentage of Successful Detection
1	35	29	82.9%
2	30	18	60%
3	30	27	90%
4	50	44	88%
Aggregate (82.9% + 60% + 90% + 88%)/4 = 80.2%			

Table 6 – Long Pulse Radar Test Waveform

Radar Type	Pulse Width (μsec)	Chirp Width (MHz)	PRI (μsec)	Number of Pulses per <i>Burst</i>	Number of <i>Bursts</i>	Minimum Percentage of Successful Detection	Minimum Number of Trials
5	50-100	5-20	1000-2000	1-3	8-20	80%	30

Table 7 – Frequency Hopping Radar Test Waveform

Radar Type	Pulse Width (μsec)	PRI (μsec)	Pulses per Hop	Hopping Rate (kHz)	Hopping Sequence Length (msec)	Minimum Percentage of Successful Detection	Minimum Number of Trials
6	1	333	9	0.333	300	70%	30

DFS Measurement System

BACL DFS measurement system consists of two subsystems: (1) The radar signal generating subsystem and (2) the traffic monitoring subsystem.

System Block Diagram

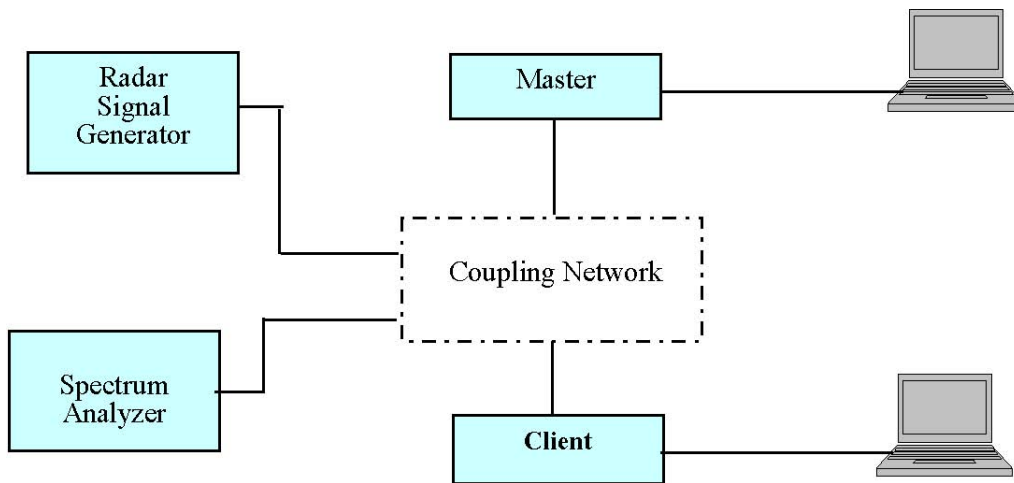

Conducted Method

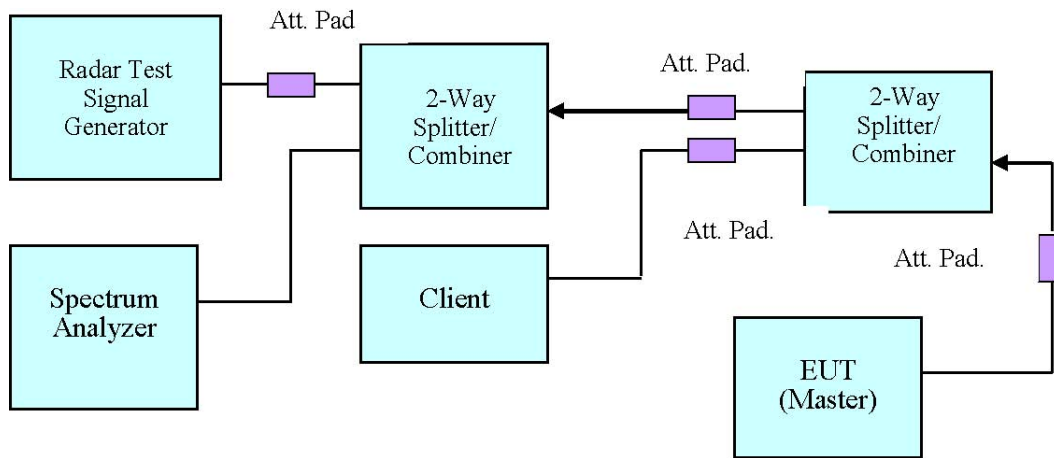

Setup for Master with injection at the Master

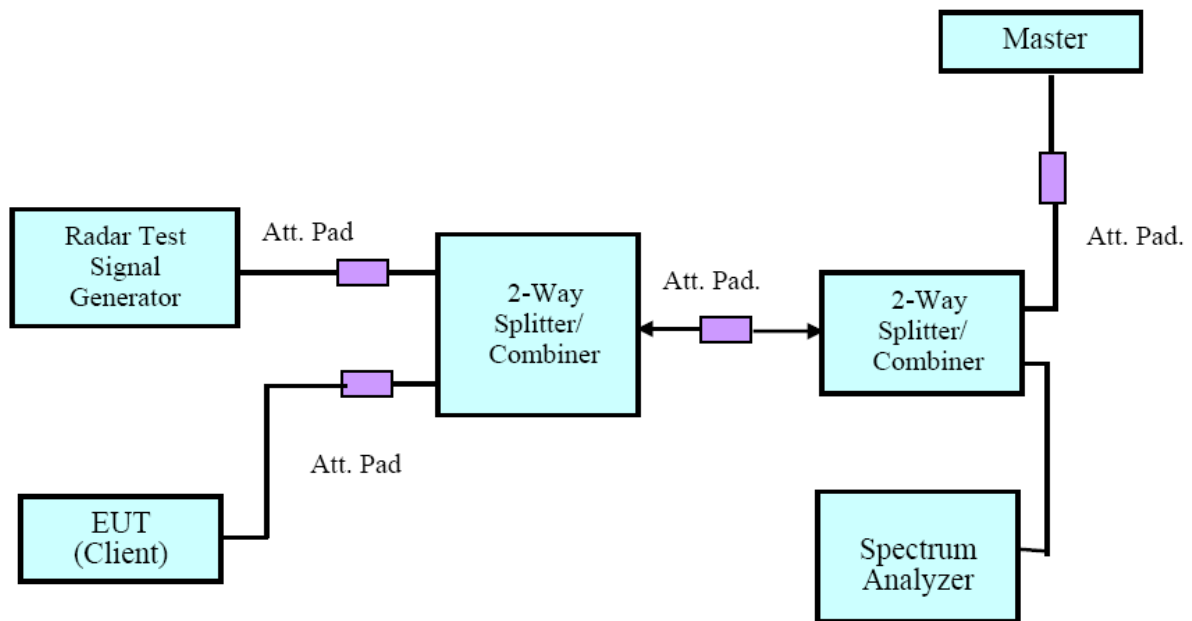

Setup for Client with injection at the Master

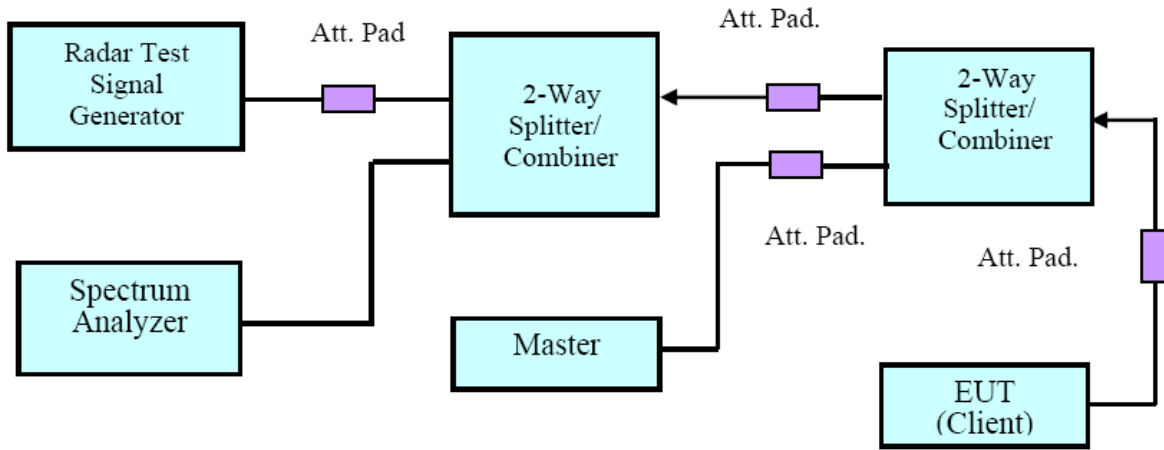

Setup for Client with injection at the Client

4.5 Radiated Method

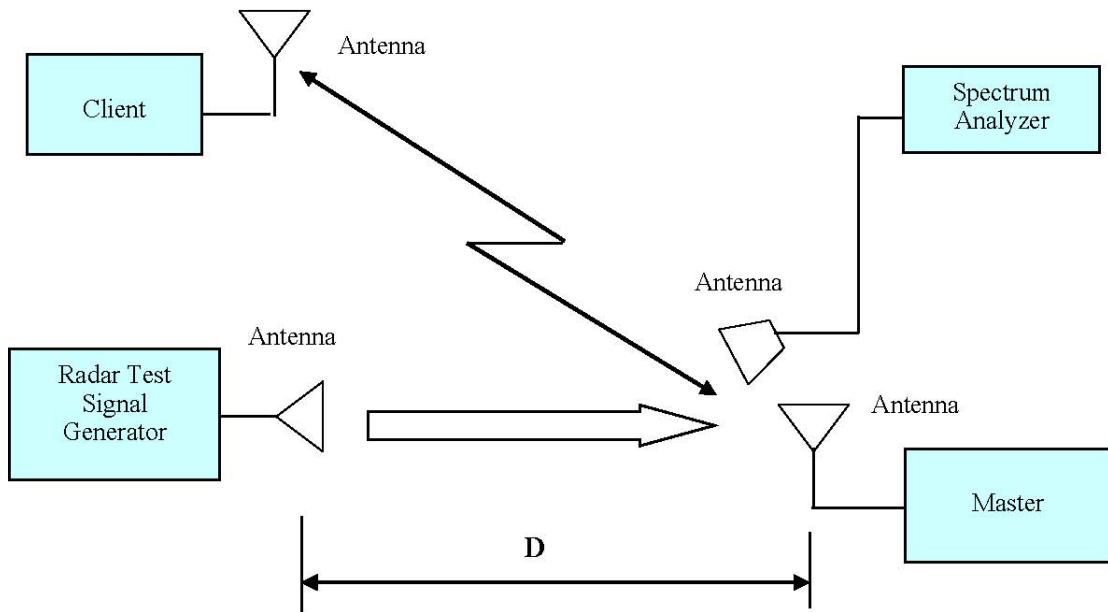

4.6 Test Procedure

A spectrum analyzer is used as a monitor verifies that the EUT status including Channel Closing Transmission Time and Channel Move Time, and does not transmit on a Channel during the Non-Occupancy Period after the diction and Channel move. It is also used to monitor EUT transmissions during the Channel Availability Check Time.

TEST RESULTS

Description of EUT

The EUT operates in 5250-5350 MHz and 5470-5725 MHz range.

The rated output power of master device is >23 dBm (EIRP), Therefore the required interference threshold level is -64 dBm, the required radiated threshold at antenna port is -64dBm.

The calibrated radiated DFS detection threshold level is set to -64 dBm.

WLAN traffic is generated by the EUT.

Test Equipment List and Details

Manufacturer	Description	Model	Serial Number	Calibration Date	Calibration Due Date
National Instruments	NI PXI-1042 8-Slot chassis	PXI-1042	VOBX40FBD	N/A	N/A
National Instruments	Arbitrary Waveform Generator	PXI-5421	N/A	N/A	N/A
National Instruments	RF Upconverter	PXI-5610	N/A	N/A	N/A
ASCOR	Upconverter	AS-7202	N/A	N/A	N/A
Agilent	Spectrum Analyzer	E4440A	SG43360054	2018-01-04	2019-01-04
Ditorn	Splitter/Combiner	D3C4080	SN2244	N/A	N/A
TDK RF	Horn Antenna	HRN-0118	130 084	2016-01-05	2019-01-04
ETS LINDGREN	Horn Antenna	3115	000 527 35	2016-01-05	2019-01-04

* **Statement of Traceability:** Bay Area Compliance Laboratories Corp. (Dongguan) attests that all calibrations have been performed, traceable to National Primary Standards and International System of Units (SI).

Test Environmental Conditions

Temperature:	22.7°C
Relative Humidity:	52 %
ATM Pressure:	100.7 kPa

The testing was performed by Swim Lv on 2018-03-15.

Radar Waveform Calibration

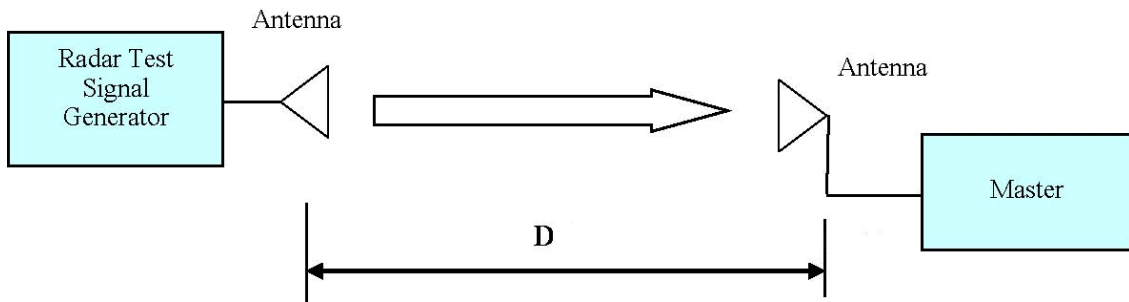

Note: the calibration distance(D) was 3meter.

Plots of Radar Waveforms

5290 MHz: Radar Type 0

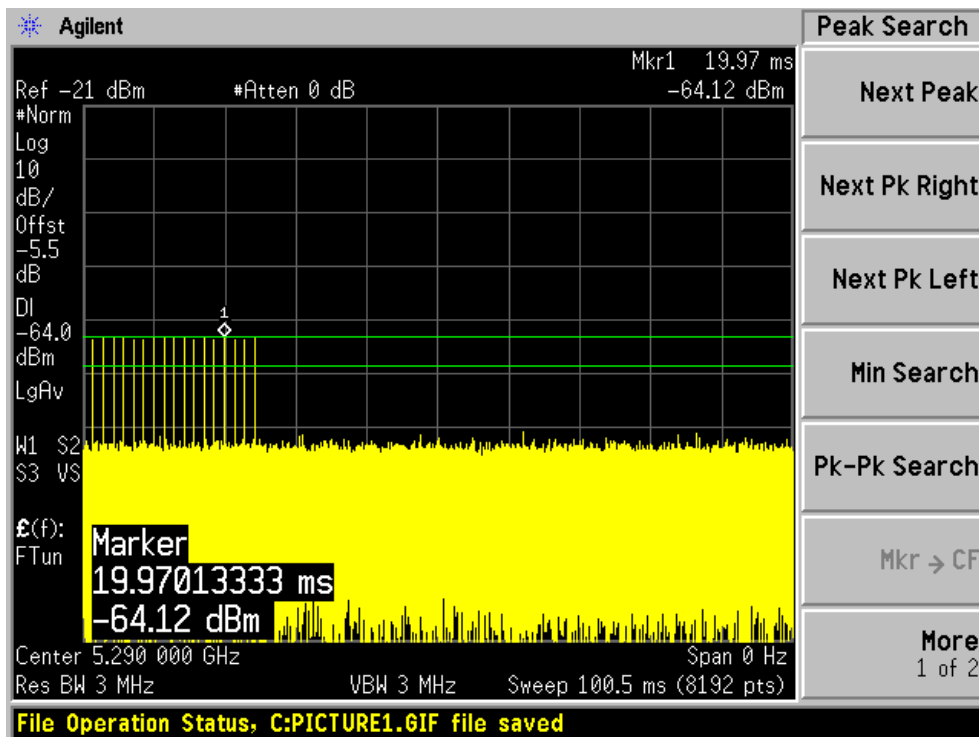

5530 MHz: Radar Type 0

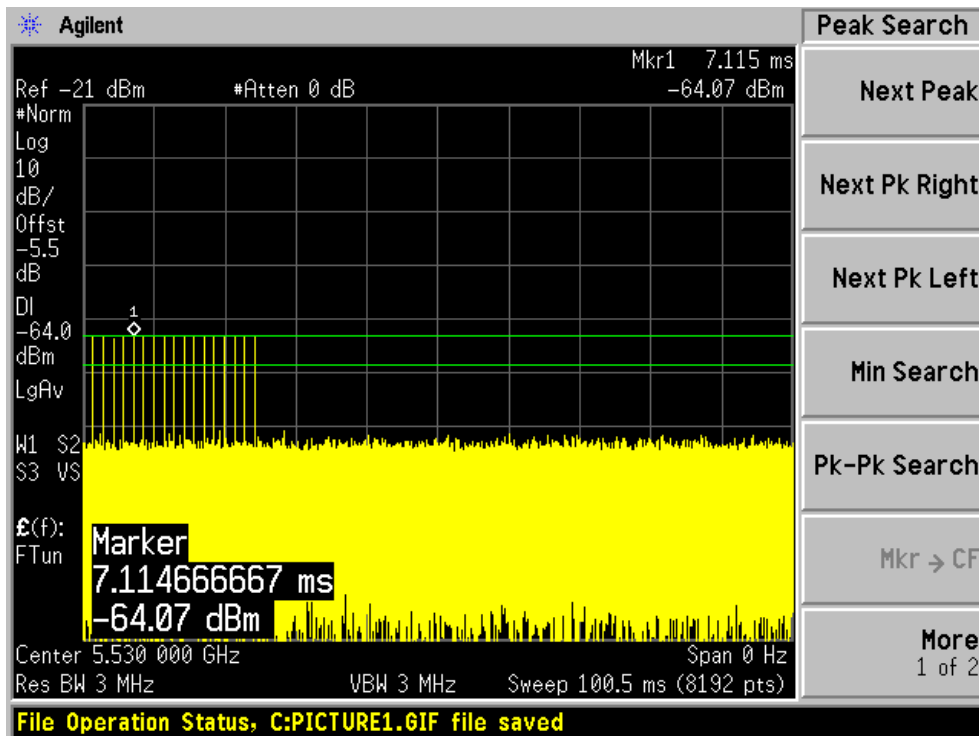

5280 MHz: Radar Type 0

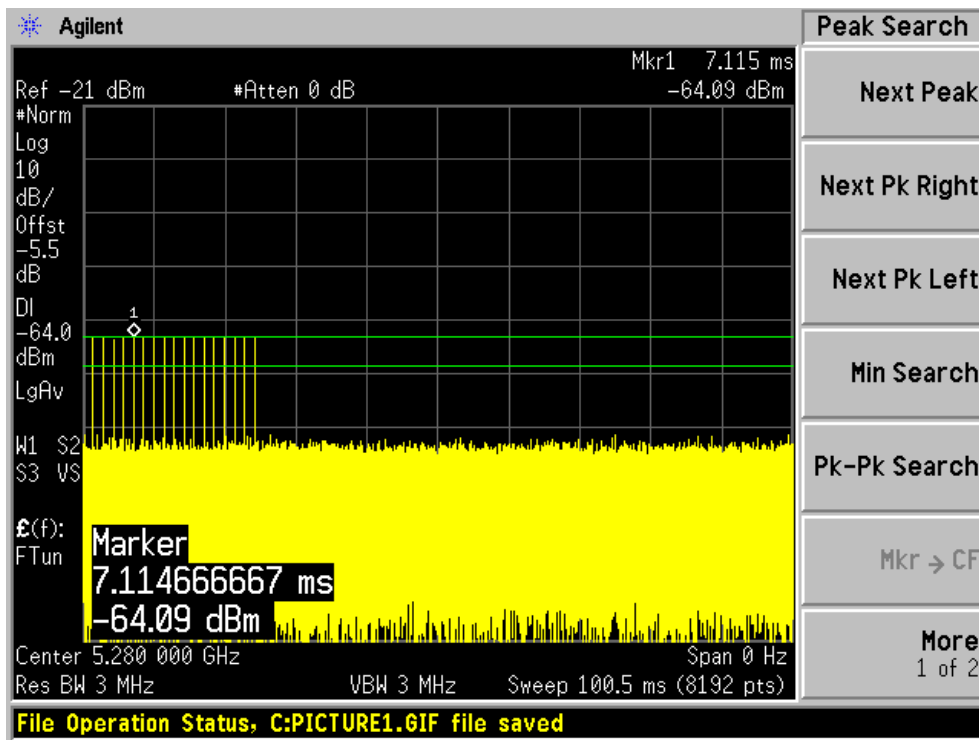

5580 MHz: Radar Type 0

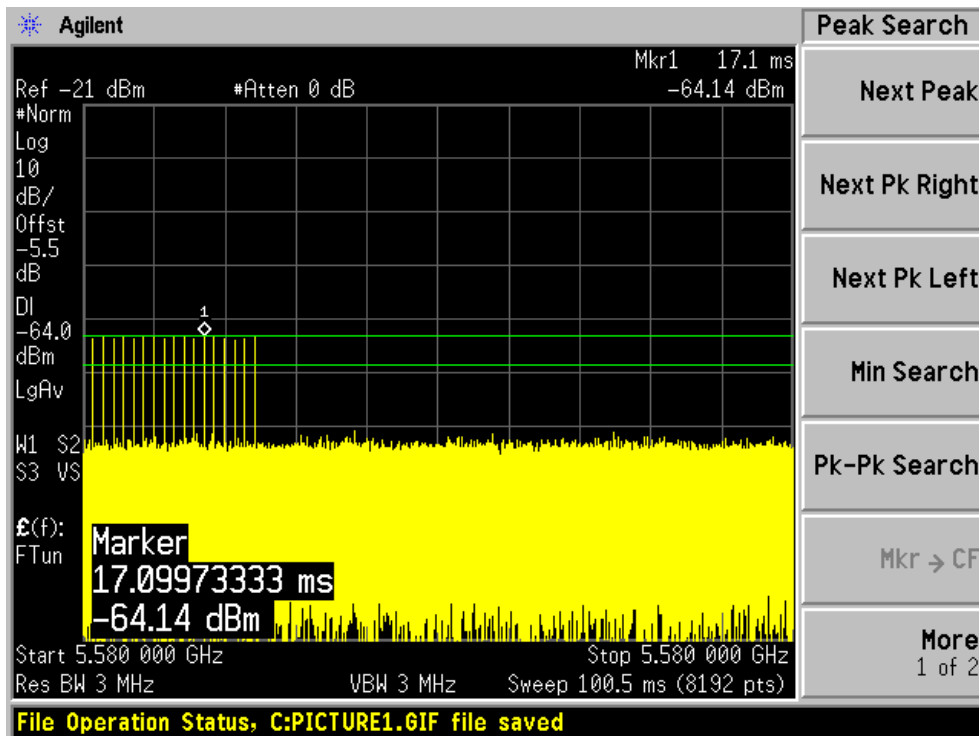

CHANNEL MOVE TIME AND CHANNEL CLOSING TRANSMISSION TIME

Test Procedure

Channel Move Time and the Channel Closing Transmission Time should be performed with Radar Type 0. The measurement timing begins at the end of the Radar Type 0 burst. repeat using a long pulse radar type5 waveform.

The Channel Closing Transmission Time is comprised of 200 milliseconds starting at the beginning of the Channel Move Time plus any additional intermittent control signals required to facilitate a Channel move (an aggregate of 60 milliseconds) during the remainder of the 10 second period. The aggregate duration of control signals will not count quiet periods in between transmissions.

The aggregate channel closing transmission time is calculated as follows:

Aggregate Transmission Time = N*Dwell Time

N is the number of spectrum analyzer bins showing a device transmission Dwell Time is the dwell time per bin (i.e. Dwell Time = S/B, S is the sweep time and B is the number of bin, i.e. 8192)

Test Results

Frequency (MHz)	Bandwidth (MHz)	Radar Type	Results
5290	80	Type 0	Compliant
5530	80	Type 0	Compliant
5280	20	Type 0	Compliant
5580	20	Type 0	Compliant

Please refer to the following tables and plots.

5290 MHz

Type 0 radar channel move time result:

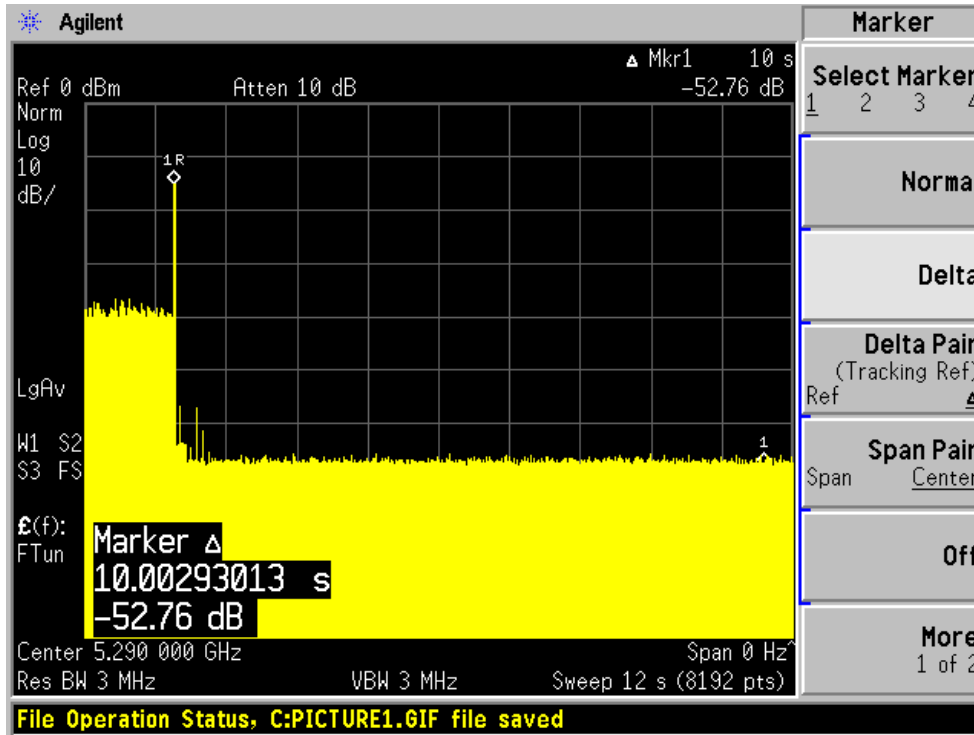

Type 0 radar channel closing transmission time result:

Aggregate Transmission Time after 200ms (ms)	Limit (ms)
1.465	60

5290 MHz channel closing transmission time

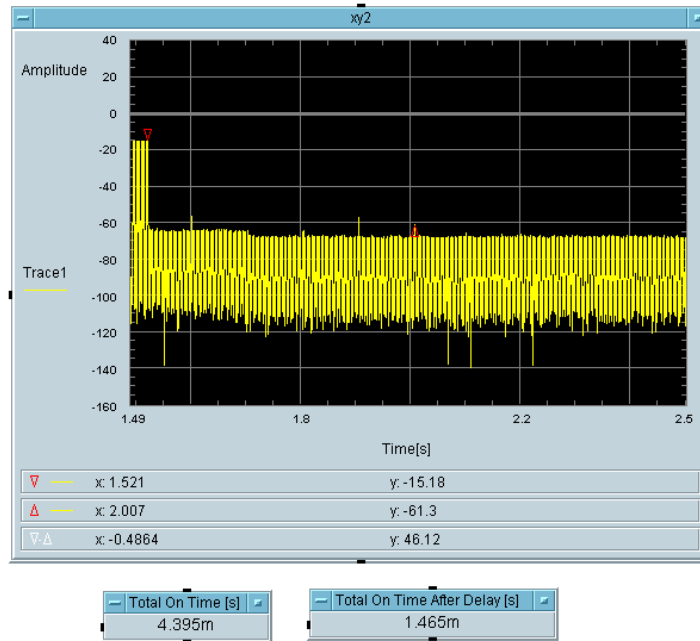

Note: If Aggregate Transmission Time after 200ms is 0ms, the total on time after delay(s) item will not display any data.

5530 MHz

Type 0 radar channel move time result:

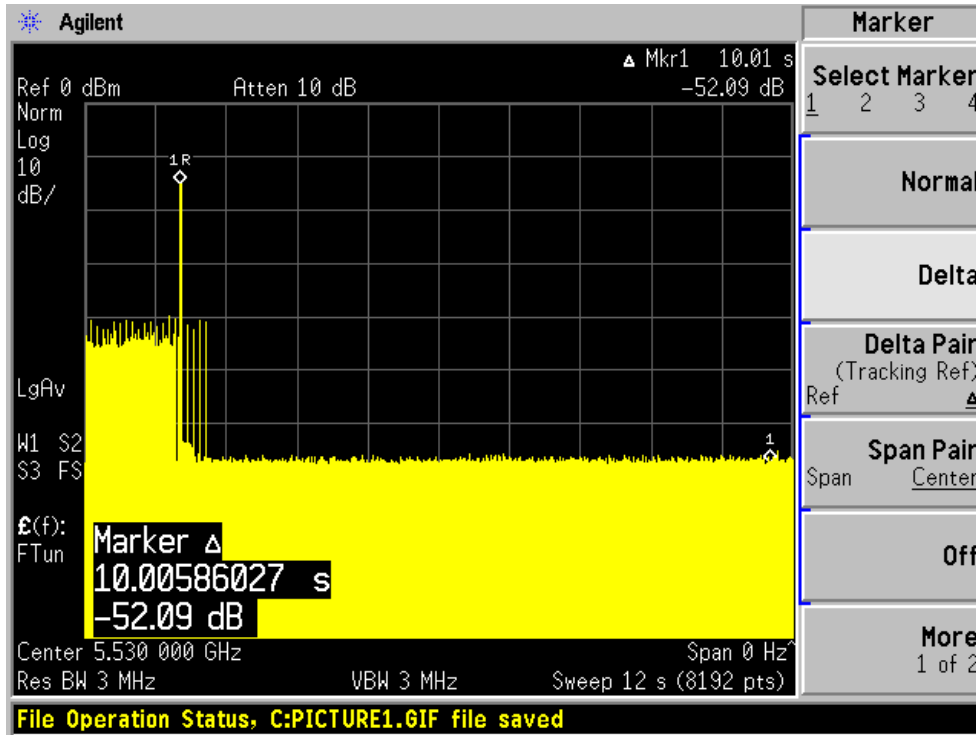

Type 0 radar channel closing transmission time result:

Aggregate Transmission Time after 200ms (ms)	Limit (ms)
2.93	60

5530 MHz channel closing transmission time

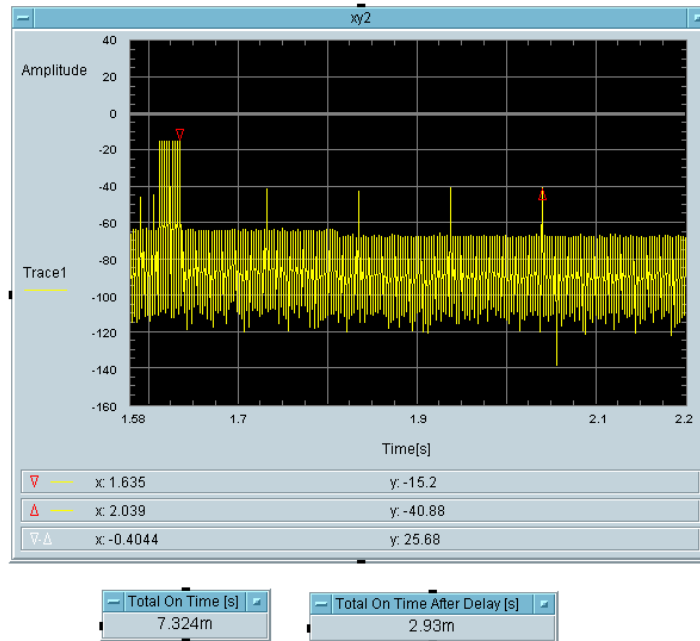

Note: If Aggregate Transmission Time after 200ms is 0ms, the total on time after delay(s) item will not display any data.

5280 MHz

Type 0 radar channel move time result:

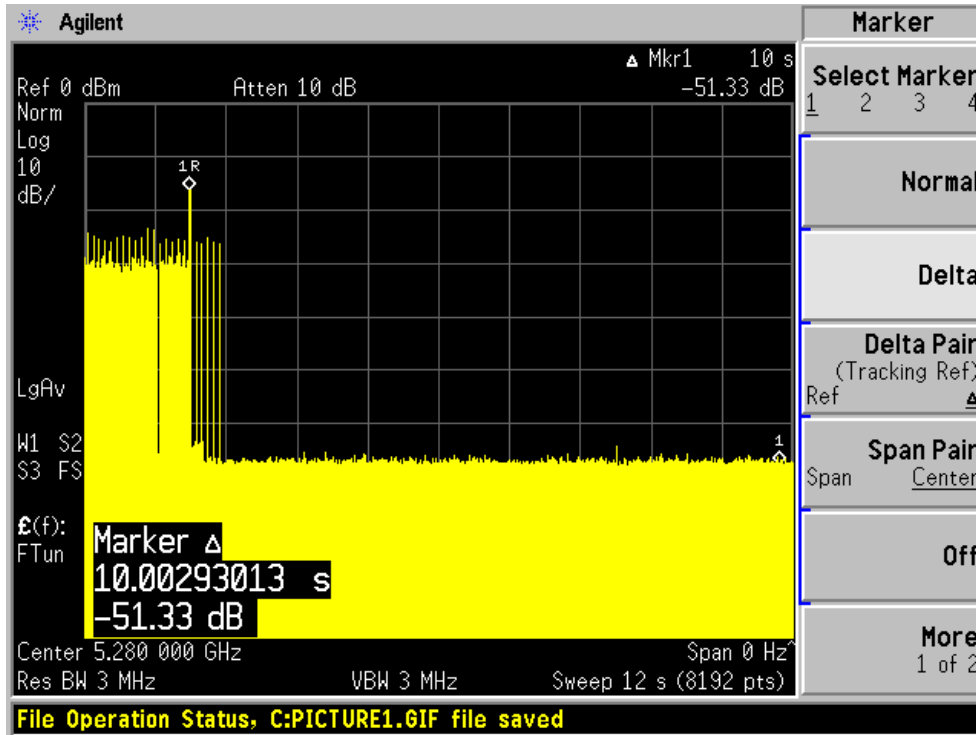

Type 0 radar channel closing transmission time result:

Aggregate Transmission Time after 200ms (ms)	Limit (ms)
4.789	60

5280 MHz channel closing transmission time

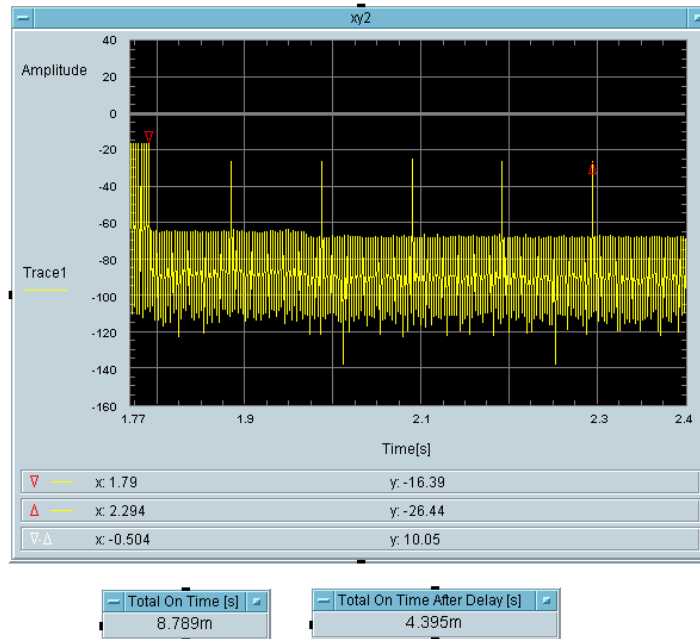

Note: If Aggregate Transmission Time after 200ms is 0ms, the total on time after delay(s) item will not display any data.

5580 MHz

Type 0 radar channel move time result:

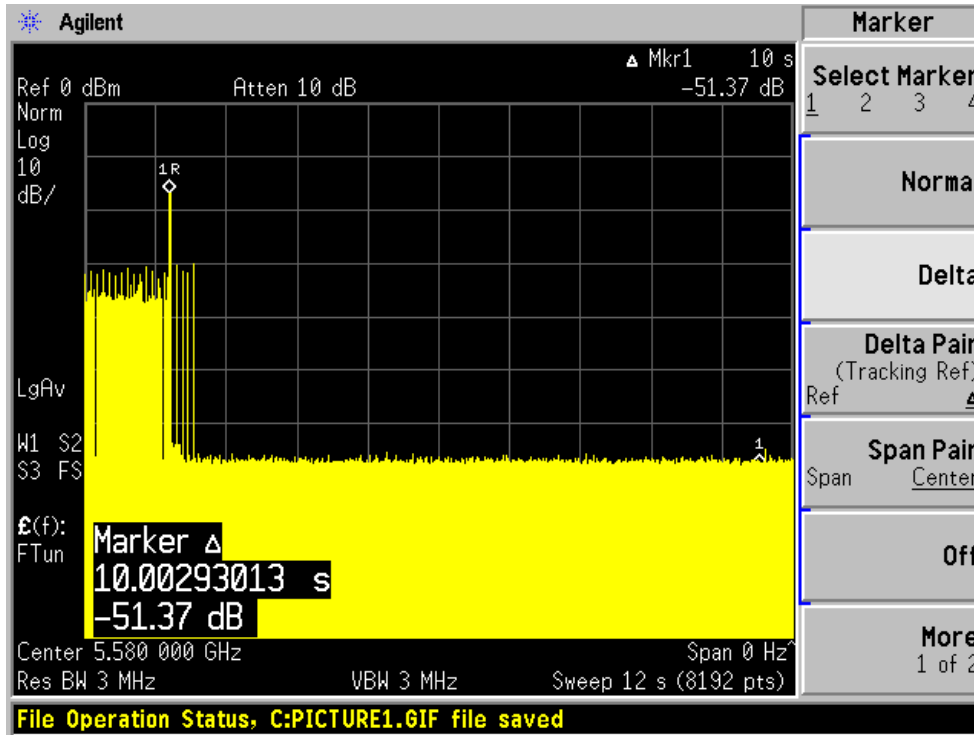

Type 0 radar channel closing transmission time result:

Aggregate Transmission Time after 200ms (ms)	Limit (ms)
4.395	60

5580 MHz channel closing transmission time

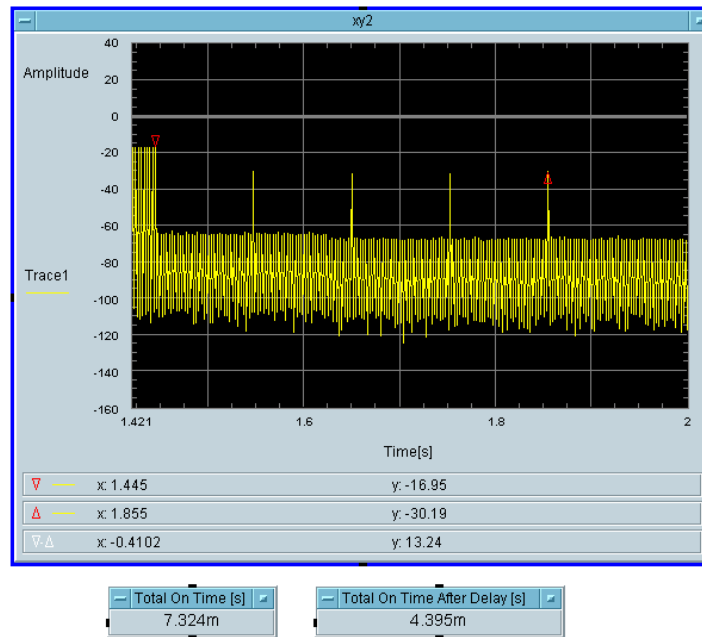

Note: If Aggregate Transmission Time after 200ms is 0ms, the total on time after delay(s) item will not display any data.

NON-OCCUPANCY PERIOD

Test Procedure

Measure the EUT for more than 30 minutes following the channel close/move time to verify that the EUT does not resume any transmissions on this channel. Provide one plot to demonstrate no transmission on the channel for the non-occupancy period (30 minutes observation time)

Test Result

Frequency (MHz)	Bandwidth (MHz)	Spectrum Analyzer Display
5290	80	No transmission within 30 minutes
5530	80	No transmission within 30 minutes
5280	20	No transmission within 30 minutes
5580	20	No transmission within 30 minutes

Please refer to the following plots.

5290 MHz

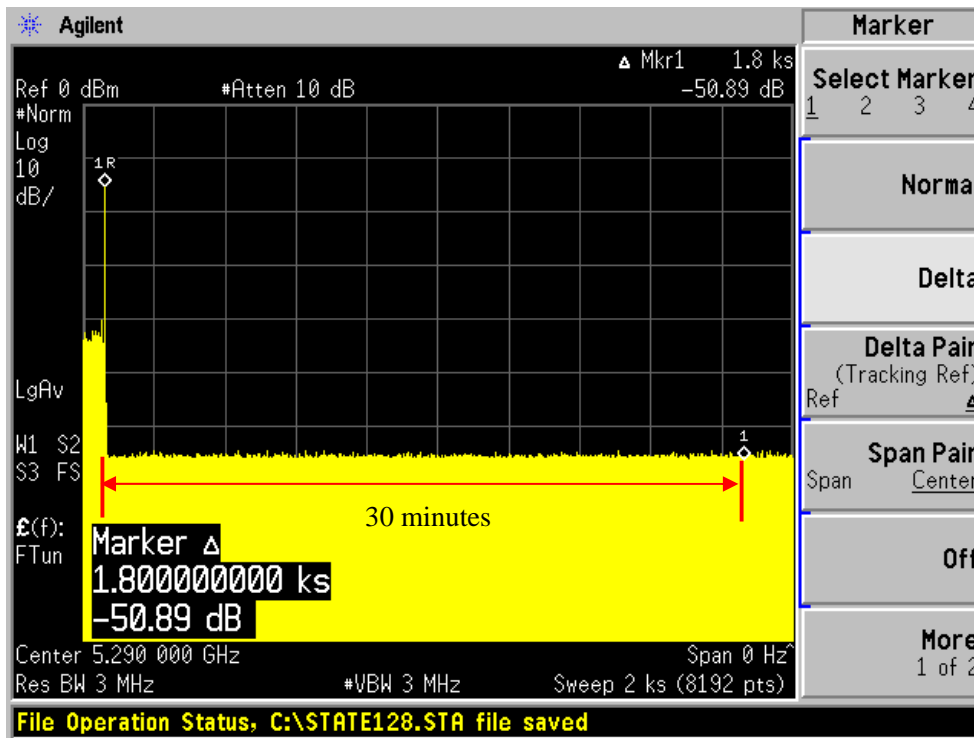

5530 MHz

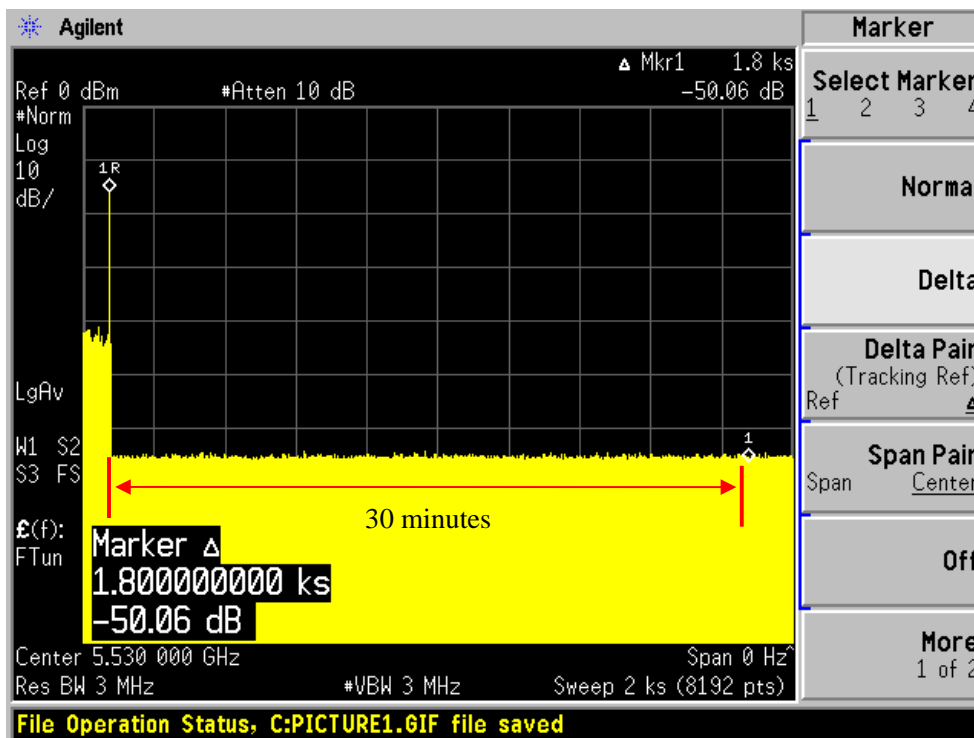

5280 MHz

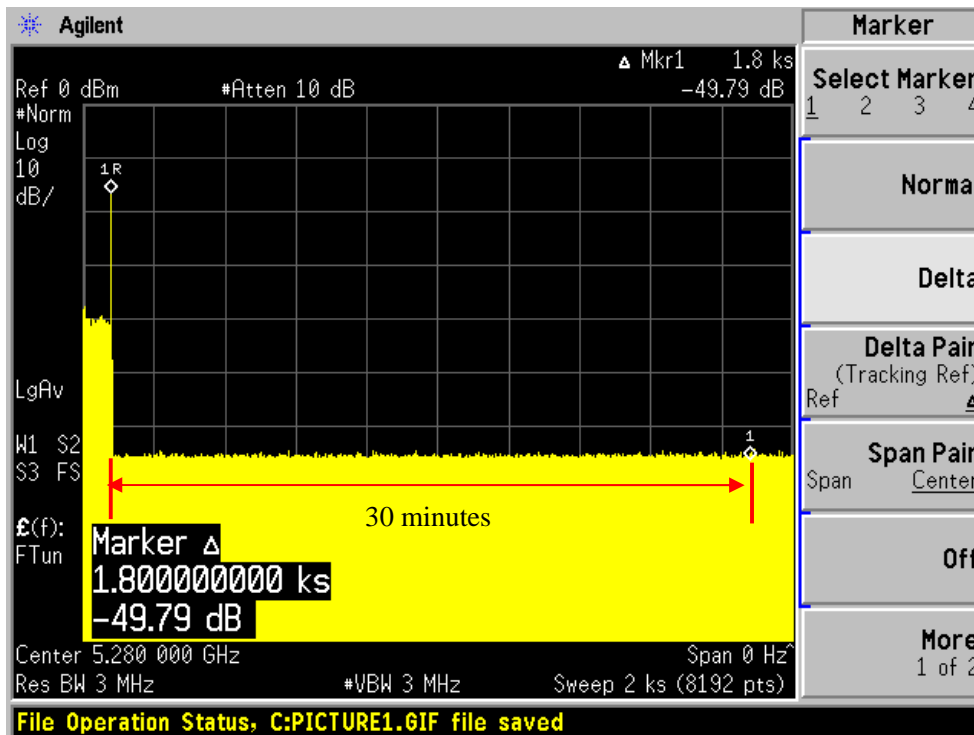

5580 MHz

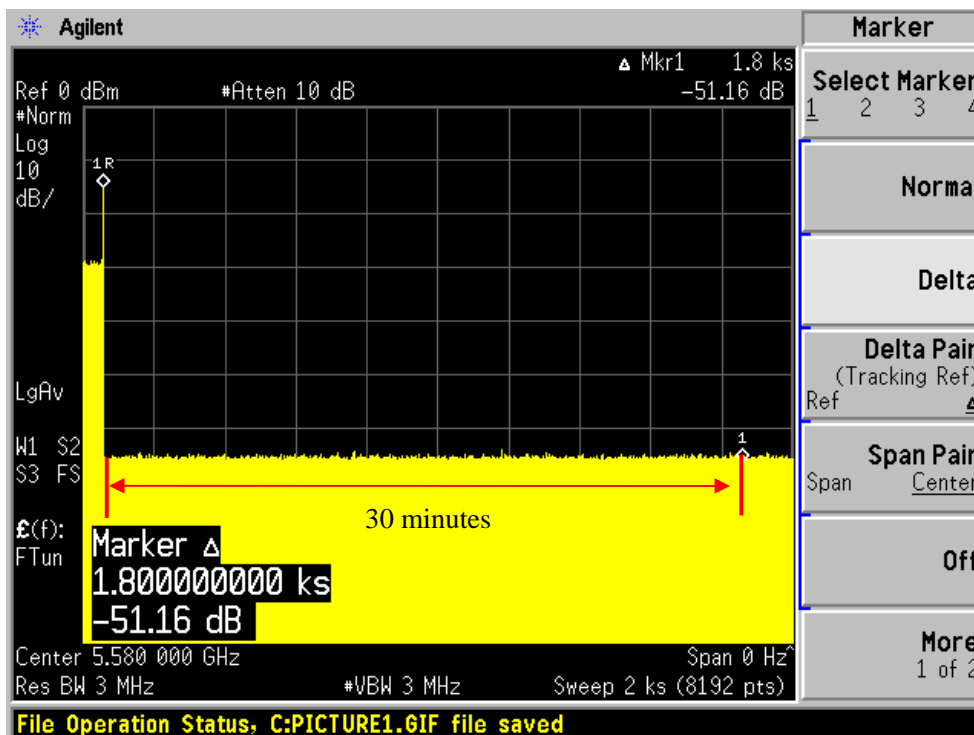

**** END OF REPORT ****