

Regulatory WLAN Antenna Information (Template)

English Language Required for Intel Regulatory Review / Approval

(OEM/ODM or antenna vendor is required to complete this document with platform antenna information.

Remove Intel references and make this your own document)

Platform information										
Brand	ODM	****End product model name	Intel platform <small>(ex: Yes, No or NA)</small>	Platform type <small>(ex: regular NB, convertible PC, AIO...etc)</small>	*SAR minimum separation (mm)					
LENOVO	HUAQIN	Lenovo 300e Yoga Chromebook Gen 4	No	Convertible PC	5.0					
****Please fill in exact product model name and make sure the model name is visible on product cover or any parts for end users recognize for authority inspection.										
Antenna information										
Vendor		Type	Antenna Part number (Main)	Antenna Part number (Aux)						
INPAQ Technology Co., Ltd.		PIFA	WA-P-LB-03-187	WA-P-LB-01-300						
Peak gain w/ cable loss (dBi)*										
	2.4GHz <small>2400-2483.5 MHz</small>	5.2GHz <small>5150-5250MHz</small>	5.3GHz <small>5250-5350MHz</small>	5.6GHz <small>5470-5725MHz</small>	5.8GHz <small>5725-5850MHz</small>	6.2GHz <small>5925-6425MHz</small>	6.5GHz <small>6425-6525MHz</small>	6.7GHz <small>6525-6875MHz</small>	7.0 GHz <small>6875-7125MHz</small>	
Main	2.62	2.93	3.18	3.05	2.79					
Aux	2.72	2.40	2.31	1.86	2.23					
Intel Reference Gain/Type/ Separation distance										
Antenna Type	Antenna Peak gain (In dBi)*									Distance to the end user (mm)
	2.4GHz <small>2400-2483.5 MHz</small>	5.2GHz <small>5150-5250MHz</small>	5.3GHz <small>5250-5350MHz</small>	5.6GHz <small>5470-5725MHz</small>	5.8GHz <small>5725-5850MHz</small>	6.2GHz <small>5925-6425MHz</small>	6.5GHz <small>6425-6525MHz</small>	6.7GHz <small>6525-6875MHz</small>	7.0GHz <small>6875-7125MHz</small>	
Design	3.00	5.00	5.00	5.00	5.00	5.00	5.00	5.00	5.00	Generic sku: refer to modular FCC SAR report Mid-power sku: ≥ 8 mm Low power sku: ≥ 5 mm
PIFA	3.23	3.64	3.73	4.77	4.97	4.83	4.30	5.37	5.59	
Dipole	2.89	2.92	3.19	4.41	4.22	4.83	4.30	4.49	5.34	
Notes (marked with *)										
* SAR minimum separation (mm)										
- Regular NB: Minimum antenna-to-body (from antenna bottom to the bottom of the device)										
- Tablet / Convertible PC: Minimum antenna-to-edge (5 sides of the device)										
- Mini-tablet: Minimum antenna-to-edge (6 sides of the device)										
* 3D Peak Antenna gain should be equal or greater than -2 dBi										
- If a host integrator plans to use a lower gain antenna of the same type, additional CBP(FCC)/EDT(EU) testing need to be performed while the module is installed in the host.										

Antenna Sample / Antenna Data

Requirements for worldwide regulatory approval

Section	Description of Required OEM / ODM Antenna Information	US / IC	EU	Japan	Taiwan	S. Korea
1A	Part Number for Antenna only	Required	Required	Required	Required	Required
1B	Antenna Manufacturer Name	Required	Required	Required	Required	Required
1C	Description of Antenna Type	Required	Required	N/A	N/A	N/A
1D	Part number of Antenna Assembly / cable impedance, length & diameter.	Required	Optional	Optional	Optional	Optional
1E	Main & Aux antenna (Peak Gain W/ cable loss) *	Required	Required	Required	Required	Required
1E OR 1F, 1G, 1H						
1F	Main & Aux antenna (Peak Gain only) *	Required	Required	Required	Required	Required
1G	VSWR of cable including connector	Required	Required	Required	Required	Required
1H	Main & Aux antenna (Cable loss W/ connector) *	Required	Required	Required	Required	Required
2	Dimensioned Photographs and Drawings of Main & Aux antennas	Required	Required	Required	Required	Required
3	Radiation patterns of antennas loaded in the host platform.	Required	Optional	Required	Required	Required
4	Platform model name / number - correlated to antenna manufacturer and antenna part number	Required	Required	Optional	Required	Optional
5	Photograph(s) or Drawings showing location of antennas in platform. <u>(S. Korea requires photographs of antennas for approval submission). Taiwan requires pictures of each antenna type shown in the system.</u>	Required	Required	Optional	<u>Required (Photos)</u>	<u>Required (Photos)</u>
6	Mech. drawings / photos with dimensions of antenna locations and distance from end-user (For evaluation of SAR testing requirement).	Required	N/A	N/A	N/A	N/A
7	Photograph(s) or Drawings showing the location of all antennas (WLAN, other) and distance between those transmitting antennas. Information will be used to evaluate whether co-location testing is required.	Required	N/A	N/A	N/A	N/A
8	Local representative contact information for LMA/ PARS process.	Required	N/A	N/A	N/A	N/A
9	Antenna gain range should be equal or greater than -2 dBi. (2.4/5/6GHz: EU, 6GHz: FCC)	Required	Required	N/A	N/A	N/A

Antenna Information

Section 1. Antenna Assembly Specifications

1A	1B	1C	1D	1E	1F	1G	1H	
Antenna Part Number	Manufacturer	Antenna Type	Cable Assembly Part Number and Information	Freq Range MHz	*Total Peak Gain W/ Cable loss (dBi)	Total Peak Gain w/o Cable Loss (dBi)	Max VSWR	Cable Loss (dB)
(P/N: WA-P-LB-03-187) Main Antenna	INPAQ Technology Co., Ltd.	PIFA	(P/N: WA-P-LB-03-187) 50 ohm Coaxial length: 430mm diameter: 1.13mm Connector: 宣德 4代, CON,ST C87P115-00002-H	2400-2483.5	2.62	3.72	2.5	1.10
				5150-5250	2.93	4.55	2.5	1.62
				5250-5350	3.18	4.87	2.5	1.69
				5470-5725	3.05	4.80	2.5	1.75
				5725-5850	2.79	4.59	2.5	1.80
				5925-6425				
				6425-6525				
				6525-6875				
(P/N: WA-P-LB-01-300) Aux Antenna	INPAQ Technology Co., Ltd.	PIFA	(P/N: WA-P-LB-01-300) 50 ohm Coaxial length: 593mm diameter: 1.13mm Connector: 宣德 4代, CON,ST C87P115-00002-H	2400-2483.5	2.72	4.30	2.5	1.58
				5150-5250	2.40	4.69	2.5	2.29
				5250-5350	2.31	4.64	2.5	2.33
				5470-5725	1.86	4.26	2.5	2.40
				5725-5850	2.23	4.66	2.5	2.43
				5925-6425				
				6425-6525				
				6525-6875				
6875-7125								

- 3D Antenna Peak Gain required being test in system basis.

Section 2. Dimensioned Photos or Drawings of Antennas

Include a dimensioned photo and dimensioned drawing of Main antenna here.

Main Antenna Dimensioned Drawing:

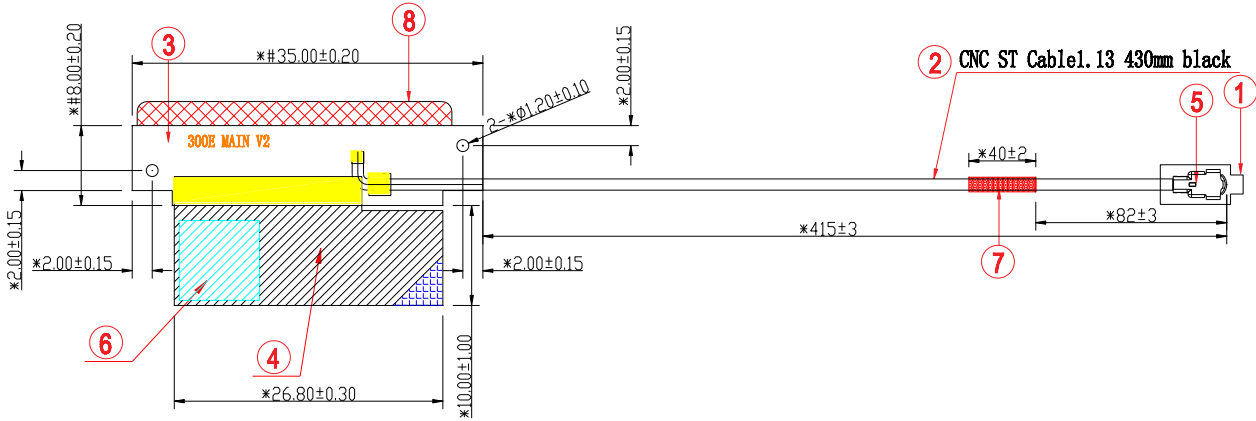

Main Antenna Photo (Front/Back):

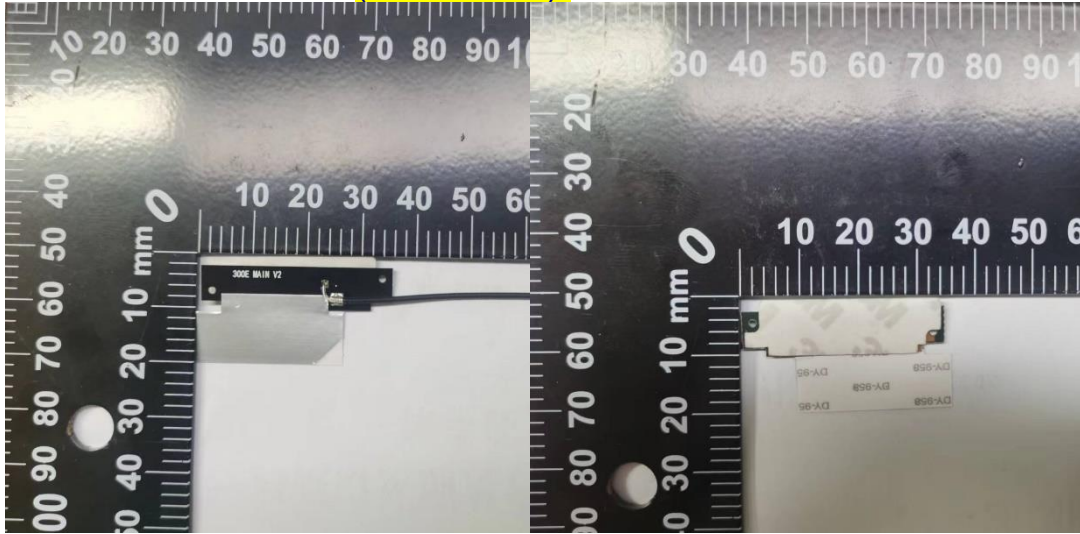

Antenna Manufacturer: INPAQ Technology Co., Ltd.

Antenna Part Number: WA-P-LB-03-187 (Main), WA-P-LB-01-300 (Aux)

Note: antenna photo should include L type ruler

Aux Antenna Dimensioned Drawing:

Include a dimensioned photo and dimensioned drawing of Aux antenna here.

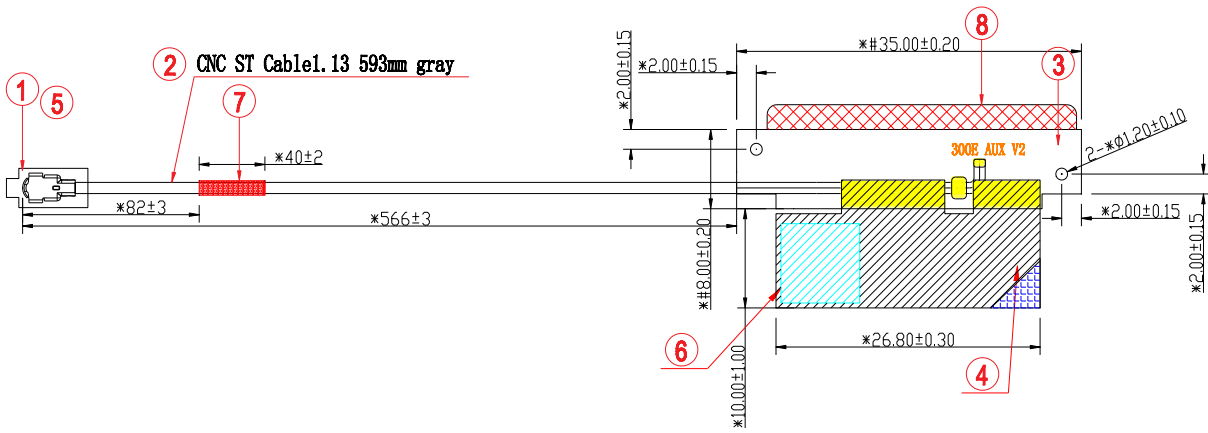

Aux Antenna Photo (Front/Back):

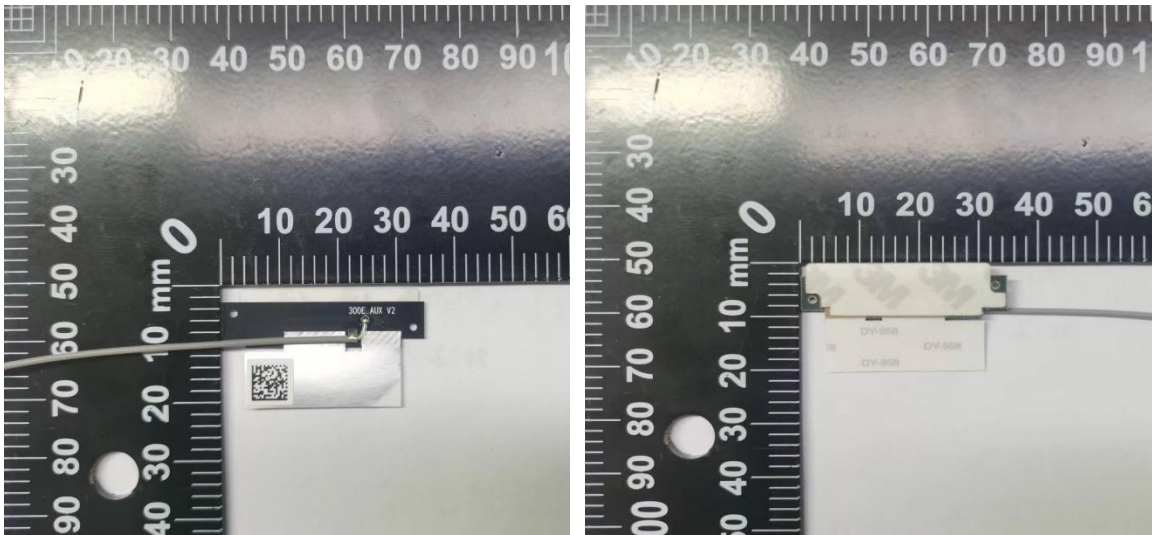

Antenna Manufacturer: INPAQ Technology Co., Ltd.

Antenna Part Number: WA-P-LB-03-187 (Main), WA-P-LB-01-300 (Aux)

Note: antenna photo should include L type ruler

Section 3. Radiation characteristics of antenna loaded in Host Platform

Main Antenna

Max Antenna 3D Radiation Pattern 2400 – 2483.5 MHz

Frequency (MHz)	Peak Gain w/ Cable Loss (dBi)
2400-2483.5	2.62

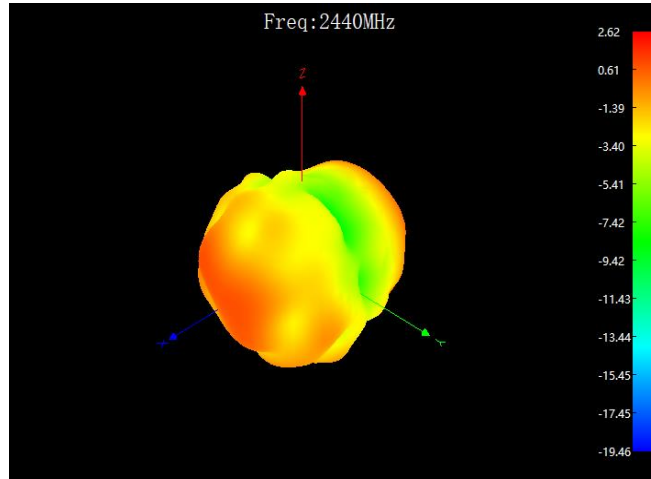

Max Antenna 3D Radiation Pattern 5150-5250 MHz

Frequency (MHz)	Peak Gain w/ Cable Loss (dBi)
5150-5250	2.93

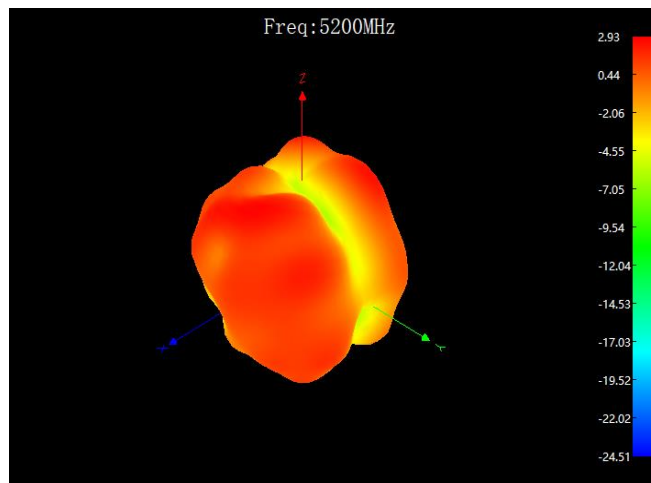

Max Antenna 3D Radiation Pattern 5250-5350 MHz

Frequency (MHz)	Peak Gain w/ Cable Loss (dBi)
5250-5350	3.18

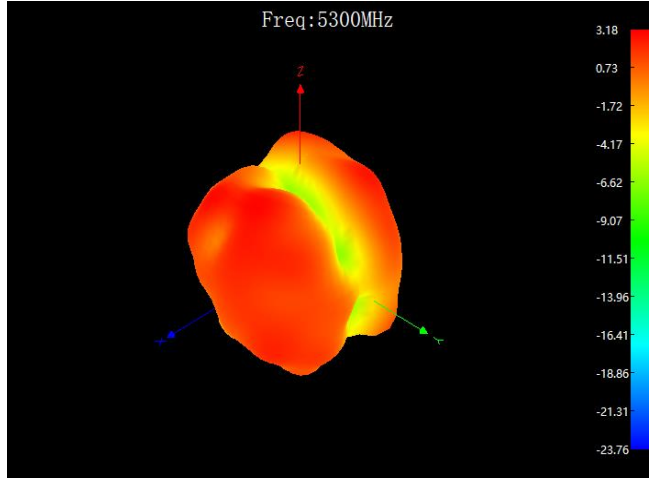

Max Antenna 3D Radiation Pattern 5470-5725 MHz

Frequency (MHz)	Peak Gain w/ Cable Loss (dBi)
5470-5725	3.05

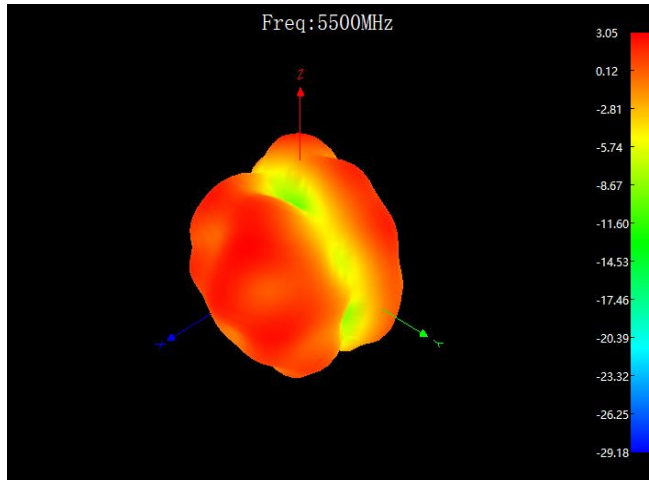

Max Antenna 3D Radiation Pattern 5725-5850 MHz

Frequency (MHz)	Peak Gain w/ Cable Loss (dBi)
5725-5850	2.79

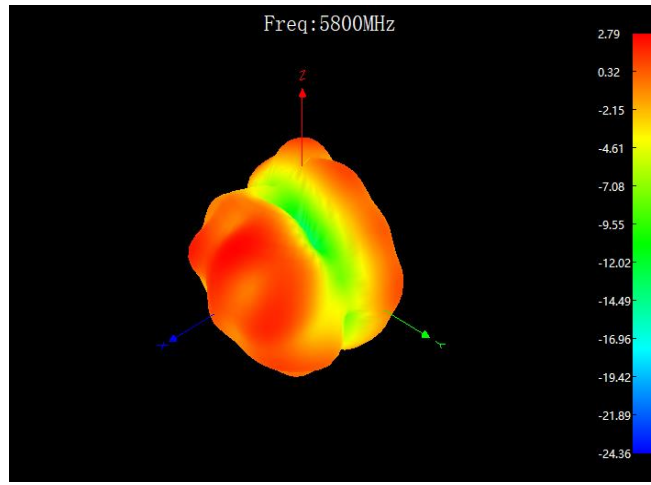

Auxiliary Antenna

Aux Antenna 3D Radiation Pattern 2400 – 2483.5 MHz

Frequency (MHz)	Peak Gain w/ Cable Loss (dBi)
2400-2483.5	2.72

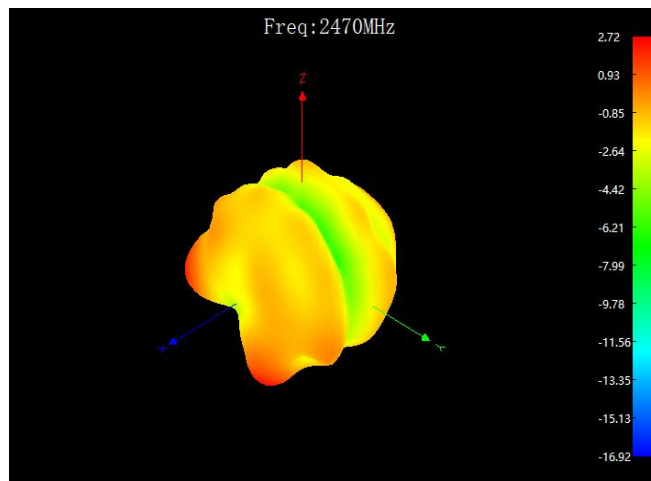

Aux Antenna 3D Radiation Pattern 5150-5250 MHz

Frequency (MHz)	Peak Gain w/ Cable Loss (dBi)
5150-5250	2.40

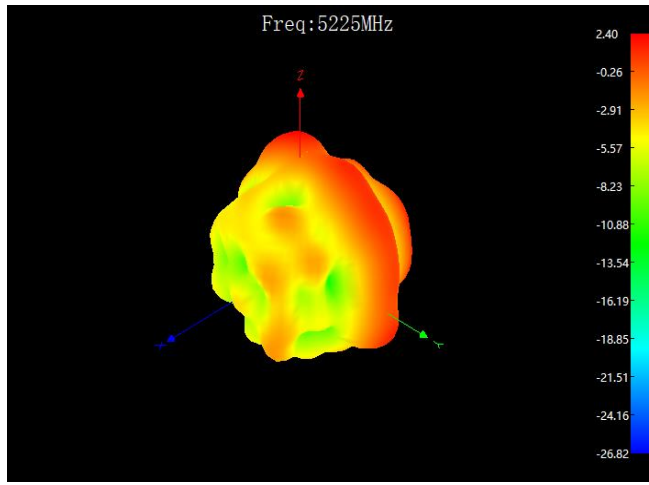

Aux Antenna 3D Radiation Pattern 5250-5350 MHz

Frequency (MHz)	Peak Gain w/ Cable Loss (dBi)
5250-5350	2.31

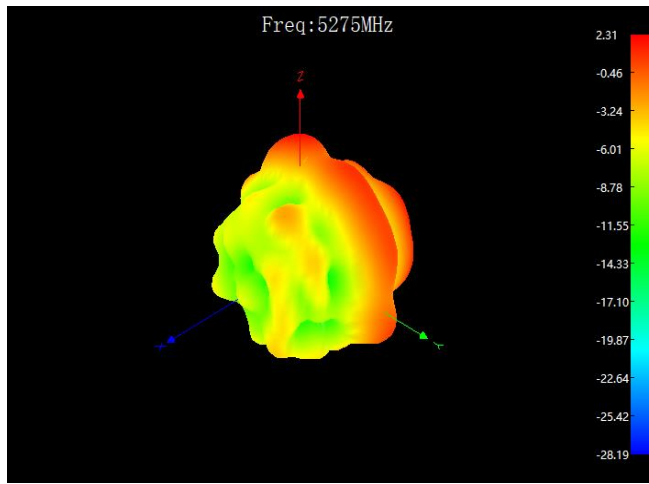

Aux Antenna 3D Radiation Pattern 5470-5725 MHz

Frequency (MHz)	Peak Gain w/ Cable Loss (dBi)
5470-5725	1.86

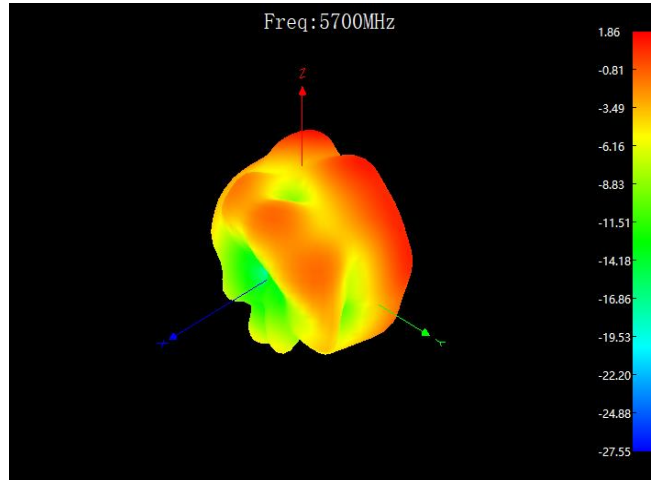

Aux Antenna 3D Radiation Pattern 5725-5850 MHz

Frequency (MHz)	Peak Gain w/ Cable Loss (dBi)
5725-5850	2.23

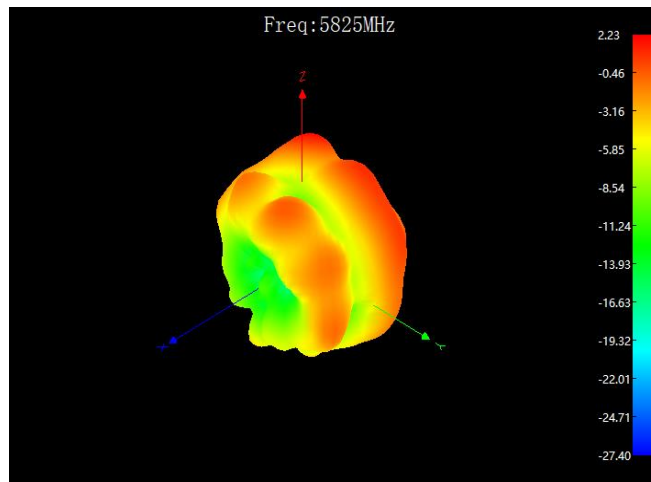

Section 4. Antenna Host Platform Location Information

Include a **dimensioned photo(s) or dimensioned drawing(s)** of Main and Aux antenna placements (measurements are not required for receive-only antenna).

Any antenna that transmits must show dimensions to bottom of laptop. Provide a description of the materials that are used for supporting or surrounding transmit antennas; for example, non-conductive plastics vs. conductive coated plastic or metallic materials.

NB Mode

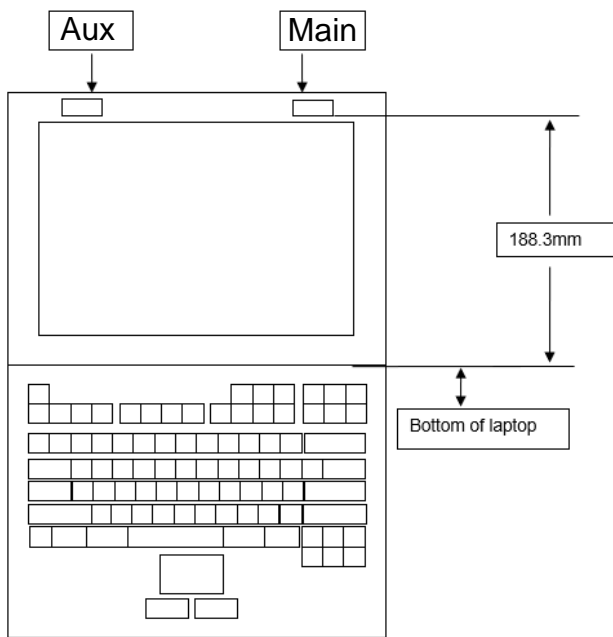

Pad Mode

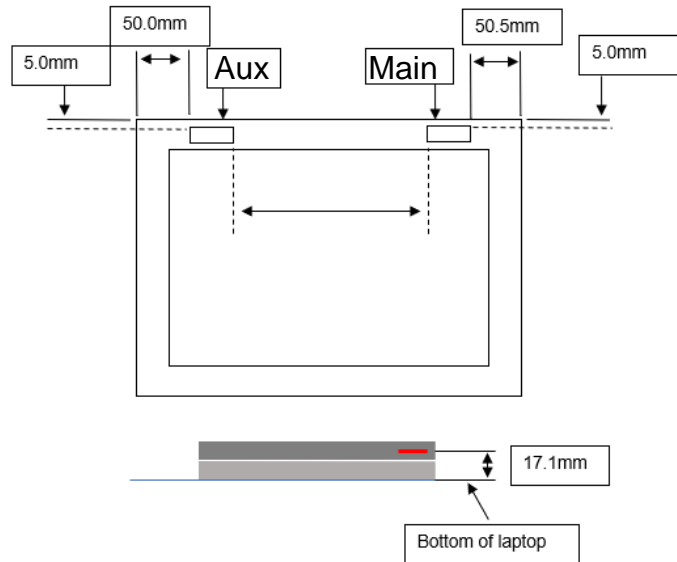

Section 5. Antenna dimensional information for SAR evaluation

Include a **dimensioned photo(s) or dimensioned drawing(s)** showing the distance (mm) between the transmit antennas and the user. For notebook/laptop hosts show lapheld position (example below). For tablet hosts show all orientations including lapheld, primary & secondary portrait, primary & secondary landscape positions. Include a description of any proximity sensors or power throttling implementations that limit or exclude use of any host orientation.

NB Mode

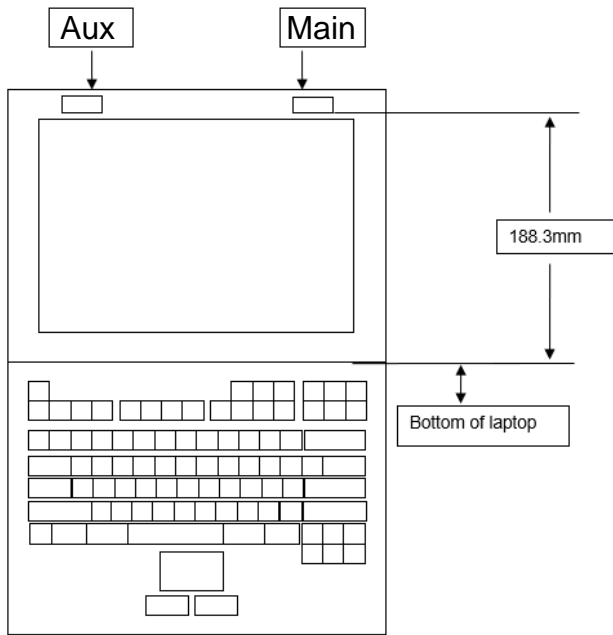

Pad Mode

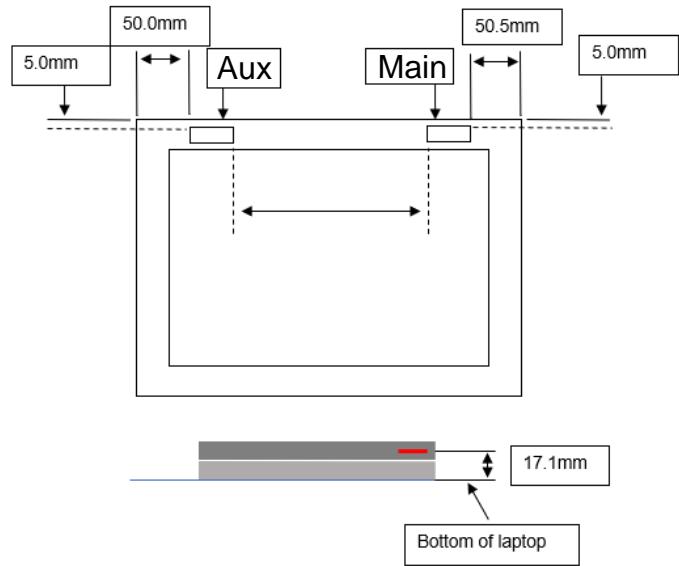

Section 6. Diagram Example of Co-Location Antenna Separation

Include a **dimensioned photo or dimensioned drawing** showing the distance (mm) between **all WLAN transmit antennas** and other co-located radiator transmit antenna such as Bluetooth, WWAN,..

(Note: Due to the evolving rules regarding co-location, each platform will need to be reviewed on a case by case basis)

