

FCC SAR Test Report

FCC ID: RAS-MT7921

Report No. : BTL-FCC SAR-1-1912H005B
Equipment : 2TX 11ax (WiFi6) + BLE Combo Card
Model Name : MT7921
Series Model : N/A
Brand Name : MediaTek
Applicant : MediaTek Inc.
Address : No. 1, Dusing 1st Rd., Hsinchu Science Park Hsinchu City 30078 Taiwan
Date of Receipt : May 12, 2021
Date of Test : May 29, 2021 ~ Jun. 04, 2021
Issued Date : Jun. 16, 2021

The above equipment has been tested and found in compliance with the requirement of the above standards by BTL Inc.

Prepared by : Justin Huang
Justin Huang, Engineer

Approved by : Herbert Liu
Herbert Liu, Manager



Certificate #5123.02

BTL Inc.

No.3, Jinshagang 1st Road, Shixia, Dalang Town, Dongguan, Guangdong, China.
Tel: +86-769-8318-3000 Web: www.newbtl.com

Declaration

BTL represents to the client that testing is done in accordance with standard procedures as applicable and that test instruments used has been calibrated with standards traceable to international standard(s) and/or national standard(s).

BTL's reports apply only to the specific samples tested under conditions. It is manufacture's responsibility to ensure that additional production units of this model are manufactured with the identical electrical and mechanical components. **BTL** shall have no liability for any declarations, inferences or generalizations drawn by the client or others from **BTL** issued reports.

The report must not be used by the client to claim product certification, approval, or endorsement by NIST, A2LA, or any agency of the U.S. Government.

This report is the confidential property of the client. As a mutual protection to the clients, the public and ourselves, the test report shall not be reproduced, except in full, without our written approval.

BTL's laboratory quality assurance procedures are in compliance with the **ISO/IEC 17025** requirements, and accredited by the conformity assessment authorities listed in this test report.

BTL is not responsible for the sampling stage, so the results only apply to the sample as received.

The information, data and test plan are provided by manufacturer which may affect the validity of results, so it is manufacturer's responsibility to ensure that the apparatus meets the essential requirements of applied standards and in all the possible configurations as representative of its intended use.

Limitation

For the use of the authority's logo is limited unless the Test Standard(s)/Scope(s)/Item(s) mentioned in this test report is (are) included in the conformity assessment authorities acceptance respective.

Please note that the measurement uncertainty is provided for informational purpose only and are not use in determining the Pass/Fail results.

Table of Contents	Page
REPORT ISSUED HISTORY	5
1 . GENERAL INFORMATION	6
1.1 GENERAL DESCRIPTION OF EUT	6
2 . RF EMISSIONS MEASUREMENT	7
2.1 TEST FACILITY	7
2.2 MEASUREMENT UNCERTAINTY	7
2.3 WLAN ANTENNA INFORMATION	7
2.4 STATEMENT OF COMPLIANCE	9
2.5 LABORATORY ENVIRONMENT	9
2.6 MAIN TEST INSTRUMENTS	10
3 . SAR MEASUREMENTS SYSTEM CONFIGURATION	11
3.1 SAR MEASUREMENT SET-UP	11
3.1.1 TEST SETUP LAYOUT	11
3.2 DASY5 E-FIELD PROBE SYSTEM	12
3.2.1 EX3DV4 PROBE SPECIFICATION	12
3.2.2 E-FIELD PROBE CALIBRATION	13
3.2.3 OTHER TEST EQUIPMENT	14
3.2.4 SCANNING PROCEDURE	15
3.2.5 SPATIAL PEAK SAR EVALUATION	16
3.2.6 DATA STORAGE AND EVALUATION	17
3.2.7 DATA EVALUATION BY SEMCAD	18
4 . SYSTEM VERIFICATION PROCEDURE	20
4.1 TISSUE VERIFICATION	20
4.2 SYSTEM CHECK	21
4.3 SYSTEM CHECK PROCEDURE	22
5 . SAR MEASUREMENT VARIABILITY AND UNCERTAINTY	23
5.1 SAR MEASUREMENT VARIABILITY	23
6 . OPERATIONAL CONDITIONS DURING TEST	24
6.1 SAR TEST CONFIGURATION	24
6.1.1 WIFI TEST CONFIGURATION	24
6.2 TEST POSITION	26
7 . TEST RESULT	27
7.1 CONDUCTED POWER RESULTS	27
7.1.1 CONDUCTED POWER MEASUREMENTS OF BT	27

Table of Contents	Page
7.1.2 CONDUCTED POWER MEASUREMENTS OF WIFI 2.4G	28
7.1.3 CONDUCTED POWER MEASUREMENTS OF WIFI 5G	31
7.2 SAR TEST RESULTS	41
7.2.1 SAR MEASUREMENT RESULT	42
7.3 MULTIPLE TRANSMITTER EVALUATION	47
7.3.1 STAND-ALONE SAR TEST EXCLUSION	47
7.3.2 SIMULTANEOUS TRANSMISSION CONDITIONS	48
APPENDIX	49
1. TEST LAYOUT	49
Appendix A. SAR Plots of System Verification	
Appendix B. SAR Plots of SAR Measurement	
Appendix C. Calibration Certificate	
Appendix D. Photographs of the Test Set-Up	

REPORT ISSUED HISTORY

Report Version	Description	Issued Date
R00	Original Issue.	Jun. 16, 2021

1. GENERAL INFORMATION

1.1 GENERAL DESCRIPTION OF EUT

Equipment	2TX 11ax (WiFi6) + BLE Combo Card	
Test Model	MT7921	
Series Model	N/A	
Model Difference(s)	N/A	
Test Sample	Engineering Sample No.: SH2021033051, SH2021033051-4, SH2021033051-14, SH2021033051-5, SH2021033051-2, SH2021033051-3, SH2021033051-6, SH2021033051-7, SH2021033051-1.	
Battery Information	Brand: Lenovo Model: L19L3PD5 Rating: 11.1V \equiv Typical Capacity 4050mAh/45Wh, Rated Capacity 3920mAh/43Wh	
Frequency Range	WLAN 2.4 GHz Band:	2400 MHz ~ 2483.5 MHz
	RLAN 5 GHz Band:	5150 MHz ~ 5250 MHz
		5250 MHz ~ 5350 MHz
		5470 MHz ~ 5725 MHz
5725 MHz ~ 5850 MHz		
Bluetooth:	2400 MHz ~ 2483.5 MHz	
Operation Frequency	WLAN 2.4 GHz Band:	2412 MHz ~ 2472 MHz
	RLAN 5 GHz Band:	5180 MHz ~ 5240 MHz
		5260 MHz ~ 5320 MHz
		5500 MHz ~ 5700 MHz
5745 MHz ~ 5825 MHz		
Bluetooth:	2402 MHz ~ 2480 MHz	
Standard(s)	<p>ANSI Std C95.1-1992 Safety Levels with Respect to Human Exposure to Radio Frequency Electromagnetic Fields, 3 kHz – 300 GHz. (IEEE Std C95.1-1991)</p> <p>IEEE Std 1528-2013 Recommended Practice for Determining the Peak Spatial-Average Specific Absorption Rate (SAR) in the Human Head from Wireless Communications Devices: Measurement Techniques</p> <p>KDB616217 D04 SAR for laptop and tablets v01r02</p> <p>KDB447498 D01 General RF Exposure Guidance v06</p> <p>KDB248227 D01 802.11 Wi-Fi SAR v02r02</p> <p>KDB865664 D01 SAR measurement 100 MHz to 6 GHz v01r04</p> <p>KDB865664 D02 SAR Reporting v01r02</p> <p>KDB690783 D01 SAR Listings on Grants v01r03</p>	

Note:

- 1) Implementation in the following platform
 Model name: TP00116C
 Product name: Notebook Computer
 Brand name: Lenovo

2. RF EMISSIONS MEASUREMENT

2.1 TEST FACILITY

The test facilities used to collect the test data in this report is SAR room at the location of No.3, Jinshagang 1st Road, ShiXia, Dalang Town, Dong Guan, China.523792

2.2 MEASUREMENT UNCERTAINTY

Note: Per KDB865664 D01 SAR Measurement 100 MHz to 6 GHz, when the highest measured 1-g SAR within a frequency band is < 1.5 W/kg, the extensive SAR measurement uncertainty analysis described in IEEE Std 1528-2013 is not required in SAR reports submitted for equipment approval. The equivalent ratio (1.5/1.6) is applied to extremity and occupational exposure conditions.

2.3 WLAN ANTENNA INFORMATION

Ant.	Brand	Model	Type	Frequency Range (MHz)	Gain (dBi)
Main	Speed	DC33001MY00	PIFA Antenna	2400-2500	2.62
				5150-5350	1.79
				5470-5725	1.01
				5725-5875	1.00
Aux	Speed	DC33001MY00	PIFA Antenna	2400-2500	1.09
				5150-5350	0.82
				5470-5725	0.21
				5725-5875	-1.33
Main	Speed	DC33001MZ00	PIFA Antenna	2400-2500	0.82
				5150-5350	2.88
				5470-5725	2.84
				5725-5875	2.84
Aux	Speed	DC33001MZ00	PIFA Antenna	2400-2500	1.57
				5150-5350	2.30
				5470-5725	2.88
				5725-5875	2.52

Ant.	Brand	Model	Type	Frequency Range (MHz)	Gain (dBi)
Main	AMP	DC33001N000	PIFA Antenna	2400-2500	-0.36
				5150-5350	-1.47
				5470-5725	-1.43
				5725-5875	-1.43
Aux	AMP	DC33001N000	PIFA Antenna	2400-2500	-1.88
				5150-5350	-2.56
				5470-5725	-2.50
				5725-5875	-1.65
Main	AMP	DC33001N100	PIFA Antenna	2400-2500	0.45
				5150-5350	-0.28
				5470-5725	0.13
				5725-5875	0.13
Aux	AMP	DC33001N100	PIFA Antenna	2400-2500	-3.32
				5150-5350	-1.51
				5470-5725	0.75
				5725-5875	-0.19

Ant.	Brand	Model	Type	Frequency Range (MHz)	Gain (dBi)
Main	ICT	DC33001MX00	PIFA Antenna	2400-2500	-2.00
				5150-5350	-2.92
				5470-5725	-0.96
				5725-5875	-3.97
Aux	ICT	DC33001MX00	PIFA Antenna	2400-2500	-0.54
				5150-5350	-1.17
				5470-5725	-2.13
				5725-5875	-2.13
Main	ICT	DC33001MW00	PIFA Antenna	2400-2500	0.47
				5150-5350	-2.18
				5470-5725	-3.58
				5725-5875	-3.33
Aux	ICT	DC33001MW00	PIFA Antenna	2400-2500	-0.89
				5150-5350	-2.74
				5470-5725	-2.42
				5725-5875	-2.72

2.4 STATEMENT OF COMPLIANCE

Mode	Highest Reported Body SAR-1g (W/kg)
2.4G WLAN	0.690
5.2G WLAN	/
5.3G WLAN	1.162
5.6G WLAN	1.176
5.8G WLAN	1.198
Bluetooth	0.095

Note:

The device is in compliance with Specific Absorption Rate (SAR) for general population uncontrolled exposure limits according to the FCC rule §2.1093, the ANSI C95.1:1992/IEEE C95.1:1991, the NCRP Report Number 86 for uncontrolled environment, and had been tested in accordance with the measurement methods and procedures specified in IEEE Std 1528-2013.

2.5 LABORATORY ENVIRONMENT

Temperature	Min. = 18°C, Max. = 25°C
Relative humidity	Min. = 30%, Max. = 70%
Ground system resistance	< 0.5Ω
Ambient noise is checked and found very low and in compliance with requirement of standards.	
Reflection of surrounding objects is minimized and in compliance with requirement of standards.	

2.6 MAIN TEST INSTRUMENTS

Item	Equipment	Manufacturer	Model	Serial No.	Cal. Date	Cal. Interval
1	Data Acquisition Electronics	Speag	DAE4	1390	Nov. 06, 2020	1 Year
2	E-field Probe	Speag	EX3DV4	7544	Oct. 29, 2020	1 Year
3	System Validation Dipole	Speag	D2450V2	919	Jun. 11, 2018	3 Years
4	System Validation Dipole	Speag	D5GHzV2	1160	Jun. 20, 2018	3 Years
5	ELI Phantom	Speag	ELI Phantom V5.0	1128	N/A	N/A
6	Power Amplifier	Mini-Circuits	ZHL-42W+	QA1333003	Dec. 29, 2020	1 Year
7	Power Amplifier	Mini-Circuits	ZVE-8G+	520701341	Mar. 02, 2021	1 Year
8	DC Source meter	Iteck	IT6154	0061041267682 01001	Jul. 25, 2020	1 Year
9	Signal Analyzer	R&S	FSV7	103120	Jul. 25, 2020	1 Year
10	Vector Network Analyzer	Anritsu	MS46522B	1538101	Jul. 25, 2020	1 Year
11	Signal Generator	R&S	SMF100A	101214	Feb. 27, 2021	1 Year
12	Smart Power Sensor	R&S	NRP-Z21	102209	Feb. 08, 2021	1 Year
13	Dielectric Assessment Kit	Speag	DAK-3.5	1226	N/A	N/A
14	Directional Coupler	Woken	TS-PCC0M-05	107090019	Feb. 27, 2021	1 Year
15	Coupler	Woken	0110A05601O-10	COM5BNW1A2	Feb. 27, 2021	1 Year
16	Digital Themometer	LKM	DTM3000	3519	Jul. 02, 2020	1 Year

Note:

1. "N/A" denotes no model name, serial No. or calibration specified.
2. * The test equipment recalibrated between different test periods were within the valid period when the tests were performed.
3.
 - 1) Per KDB865664 D01 requirements for dipole calibration, the test laboratory has adopted three-year extended calibration interval. Each measured dipole is expected to evaluate with the following criteria at least on annual interval in Appendix C.
 - a) There is no physical damage on the dipole;
 - b) System check with specific dipole is within 10% of calibrated value;
 - c) The most recent return-loss result, measured at least annually, deviates by no more than 20% from the previous measurement;
 - d) The most recent measurement of the real or imaginary parts of the impedance, measured at least annually is within 5Ω from the previous measurement.
 - 2) Network analyzer probe calibration against air, distilled water and a short block performed before measuring liquid parameters.

3. SAR MEASUREMENTS SYSTEM CONFIGURATION

3.1 SAR MEASUREMENT SET-UP

The DASY5 system for performing compliance tests consists of the following items:

1. A standard high precision 6-axis robot (Stäubli RX family) with controller and software. An arm extension for accommodating the data acquisition electronics (DAE).
2. A dosimetric probe, i.e. an isotropic E-field probe optimized and calibrated for usage in tissue simulating liquid. The probe is equipped with an optical surface detector system.
3. A data acquisition electronic (DAE) which performs the signal amplification, signal multiplexing, AD-conversion, offset measurements, mechanical surface detection, collision detection, etc. The unit is battery powered with standard or rechargeable batteries. The signal is optically transmitted to the EOC.
4. A unit to operate the optical surface detector which is connected to the EOC.
5. The Electro-Optical Coupler (EOC) performs the conversion from the optical into a digital electric signal of the DAE. The EOC is connected to the DASY5 measurement server.
6. The DASY5 measurement server, which performs all real-time data evaluation for field measurements and surface detection, controls robot movements and handles safety operation. A computer operating Windows.
7. DASY5 software and SEMCAD data evaluation software.
8. Remote control with teach panel and additional circuitry for robot safety such as warning lamps, etc.
9. The generic twin phantom enabling the testing of left-hand and right-hand usage.
10. The device holder for handheld mobile phones.
11. Tissue simulating liquid mixed according to the given recipes.
12. System validation dipoles allowing to validate the proper functioning of the system.

3.1.1 TEST SETUP LAYOUT

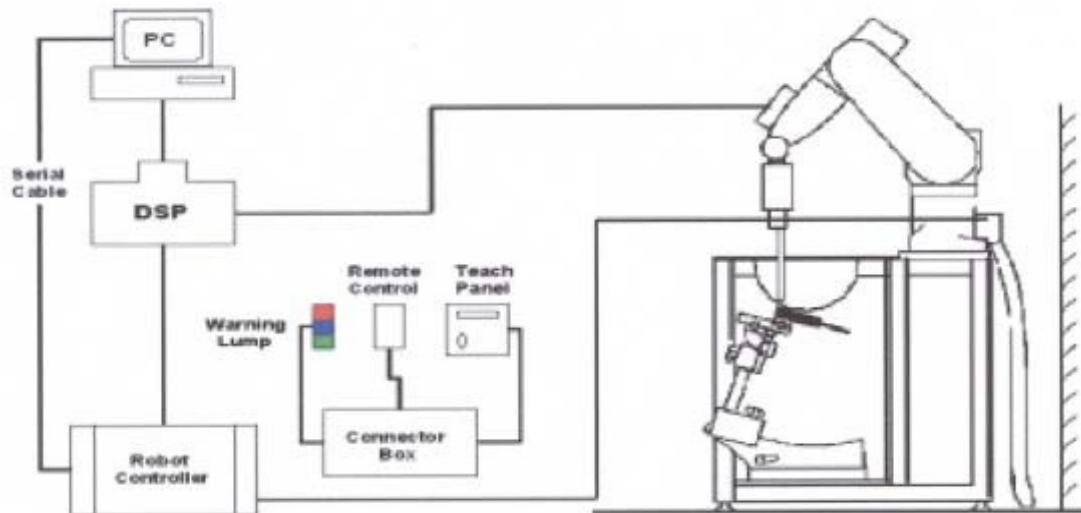

3.2 DASY5 E-FIELD PROBE SYSTEM

The SAR measurements were conducted with the dosimetric probe EX3DV4 (manufactured by SPEAG), designed in the classical triangular configuration and optimized for dosimetric evaluation.

3.2.1 EX3DV4 PROBE SPECIFICATION

Construction	Symmetrical design with triangular core Interleaved sensors Built-in shielding against static charges PEEK enclosure material (resistant to organic solvents, e.g., DGBE)
Calibration	ISO/IEC 17025 calibration service available
Frequency	10 MHz to 6 GHz Linearity: ± 0.2 dB (30 MHz to 6 GHz)
Directivity	± 0.3 dB in HSL (rotation around probe axis) ± 0.5 dB in tissue material (rotation normal to probe axis)
Dynamic Range	10 μ W/g to > 100 mW/g Linearity: ± 0.2 dB
Dimensions	Overall length: 330 mm (Tip: 20 mm) Tip diameter: 2.5 mm (Body: 12 mm) Distance from probe tip to dipole centers: 1.0 mm



EX3DV4 E-field Probe

3.2.2 E-FIELD PROBE CALIBRATION

Each probe is calibrated according to a dosimetric assessment procedure with accuracy better than $\pm 10\%$. The spherical isotropy was evaluated and found to be better than $\pm 0.25\text{dB}$. The sensitivity parameters (NormX, NormY, NormZ), the diode compression parameter (DCP) and the conversion factor (ConvF) of the probe are tested.

The free space E-field from amplified probe outputs is determined in a test chamber. This is performed in a TEM cell for frequencies below 1 GHz, and in a wave guide above 1 GHz for free space. For the free space calibration, the probe is placed in the volumetric center of the cavity and at the proper orientation with the field. The probe is then rotated 360 degrees.

E-field temperature correlation calibration is performed in a flat phantom filled with the appropriate simulated brain tissue. The measured free space E-field in the medium correlates to temperature rise in a dielectric medium. For temperature correlation calibration a RF transparent thermostat-based temperature probe is used in conjunction with the E-field probe.

$$\text{SAR} = C \frac{\Delta T}{\Delta t}$$

Where: Δt =Exposure time (30 seconds),

C =Heat capacity of tissue (brain or muscle),

ΔT =Temperature increase due to RF exposure.

Or
$$\text{SAR} = \frac{|E|^2 \sigma}{\rho}$$

Where: σ = Simulated Tissue Conductivity,
 ρ =Tissue density (kg/m³).

3.2.3 OTHER TEST EQUIPMENT

3.2.3.1 Device Holder for Transmitters

Construction: Simple but effective and easy-to-use extension for Mounting Device that facilitates the testing of larger devices (e.g., laptops, cameras, etc.) It is light weight and fits easily on the upper part of the Mounting Device in place of the phone positioner. The extension is fully compatible with the Twin SAM, ELI and SAM v6.0 Phantoms.

Material: POM, Acrylic glass, Foam

3.2.3.2 Phantom

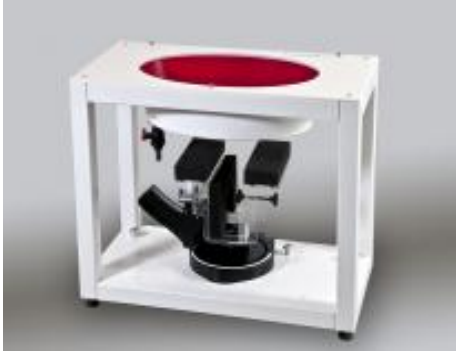
Model	ELI Phantom	
Construction	Phantom for compliance testing of handheld and body-mounted wireless devices in the frequency range of 30 MHz to 6 GHz. ELI is fully compatible with the IEC 62209-2 standard and all known tissue simulating liquids. ELI has been optimized regarding its performance and can be integrated into our standard phantom tables. A cover prevents evaporation of the liquid. Reference markings on the phantom allow installation of the complete setup, including all predefined phantom positions and measurement grids, by teaching three points. The phantom is compatible with all SPEAG dosimetric probes and dipoles.	
Shell Thickness	2±0.1 mm	
Filling Volume	Approx. 30 liters	
Dimensions	Length: 600 mm; Width: 190mm Height: adjustable feet	
Available	Special	

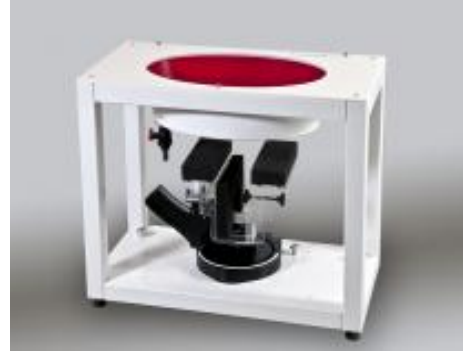

3.2.4 SCANNING PROCEDURE

The DASY5 installation includes predefined files with recommended procedures for measurements and validation. They are read-only document files and destined as fully defined but unmeasured masks. All test positions (head or body-worn) are tested with the same configuration of test steps differing only in the grid definition for the different test positions.

The “reference” and “drift” measurements are located at the beginning and end of the batch process. They measure the field drift at one single point in the liquid over the complete procedure. The indicated drift is mainly the variation of the DUT’s output power and should vary max. $\pm 5\%$.

The “surface check” measurement tests the optical surface detection system of the DASY5 system by repeatedly detecting the surface with the optical and mechanical surface detector and comparing the results. The output gives the detecting heights of both systems, the difference between the two systems and the standard deviation of the detection repeatability. Air bubbles or refraction in the liquid due to separation of the sugar-water mixture gives poor repeatability (above $\pm 0.1\text{mm}$). To prevent wrong results tests are only executed when the liquid is free of air bubbles. The difference between the optical surface detection and the actual surface depends on the probe and is specified with each probe. (It does not depend on the surface reflectivity or the probe angle to the surface within $\pm 30^\circ$.)

- Area Scan

The “area scan” measures the SAR above the DUT or verification dipole on a parallel plane to the surface. It is used to locate the approximate location of the peak SAR with 2D spline interpolation. The robot performs a stepped movement along one grid axis while the local electrical field strength is measured by the probe. The probe is touching the surface of the SAM during acquisition of measurement values. The standard scan uses large grid spacing for faster measurement. Standard grid spacing for head measurements is 15 mm in x- and y-dimension ($\leq 2\text{GHz}$), 12 mm in x- and y- dimension (2-4 GHz) and 10mm in x- and y- dimension (4-6GHz). If a finer resolution is needed, the grid spacing can be reduced. Grid spacing and orientation have no influence on the SAR result. For special applications where the standard scan method does not find the peak SAR within the grid, e.g. mobile phones with flip cover, the grid can be adapted in orientation.

- Zoom Scan

A “zoom scan” measures the field in a volume around the 2D peak SAR value acquired in the previous “coarse” scan. This is a fine grid with maximum scan spatial resolution: $\Delta x_{\text{zoom}}, \Delta y_{\text{zoom}} \leq 2\text{GHz} - \leq 8\text{mm}$, 2-4GHz $- \leq 5\text{ mm}$ and 4-6 GHz $- \leq 4\text{mm}$; $\Delta z_{\text{zoom}} \leq 3\text{GHz} - \leq 5\text{ mm}$, 3-4 GHz $- \leq 4\text{mm}$ and 4-6GHz $- \leq 2\text{mm}$ where the robot additionally moves the probe along the z-axis away from the bottom of the Phantom. DASY is also able to perform repeated zoom scans if more than 1 peak is found during area scan. In this document, the evaluated peak 1g and 10g averaged SAR values are shown in the 2D-graphics in Appendix B. Test results relevant for the specified standard (see chapter 1.4.) are shown in table form in chapter 7.2.

A Z-axis scan measures the total SAR value at the x-and y-position of the maximum SAR value found during the cube scan. The probe is moved away in z-direction from the bottom of the SAM phantom in 2 mm steps. This measurement shows the continuity of the liquid and can - depending in the field strength – also show the liquid depth.

The following table summarizes the area scan and zoom scan resolutions per FCC KDB 865664D01:

Frequency	Maximun Area Scan resolution ($\Delta x_{\text{area}}, \Delta y_{\text{area}}$)	Maximun Zoom Scan spatial resolution ($\Delta x_{\text{Zoom}}, \Delta y_{\text{Zoom}}$)	Maximun Zoom Scan spatial resolution			Minimum zoom scan volume (x,y,z)
			Uniform Grid	Graded Grad		
			$\Delta z_{\text{Zoom}}(n)$	$\Delta z_{\text{Zoom}}(1)^*$	$\Delta z_{\text{Zoom}}(n>1)^*$	
$\leq 2\text{GHz}$	$\leq 15\text{mm}$	$\leq 8\text{mm}$	$\leq 5\text{mm}$	$\leq 4\text{mm}$	$\leq 1.5 \cdot \Delta z_{\text{Zoom}}(n-1)$	$\geq 30\text{mm}$
2-3GHz	$\leq 12\text{mm}$	$\leq 5\text{mm}$	$\leq 5\text{mm}$	$\leq 4\text{mm}$	$\leq 1.5 \cdot \Delta z_{\text{Zoom}}(n-1)$	$\geq 30\text{mm}$
3-4GHz	$\leq 12\text{mm}$	$\leq 5\text{mm}$	$\leq 4\text{mm}$	$\leq 3\text{mm}$	$\leq 1.5 \cdot \Delta z_{\text{Zoom}}(n-1)$	$\geq 28\text{mm}$
4-5GHz	$\leq 10\text{mm}$	$\leq 4\text{mm}$	$\leq 3\text{mm}$	$\leq 2.5\text{mm}$	$\leq 1.5 \cdot \Delta z_{\text{Zoom}}(n-1)$	$\geq 25\text{mm}$
5-6GHz	$\leq 10\text{mm}$	$\leq 4\text{mm}$	$\leq 2\text{mm}$	$\leq 2\text{mm}$	$\leq 1.5 \cdot \Delta z_{\text{Zoom}}(n-1)$	$\geq 22\text{mm}$

3.2.5 SPATIAL PEAK SAR EVALUATION

The spatial peak SAR - value for 1 and 10 g is evaluated after the Cube measurements have been done. The basis of the evaluation are the SAR values measured at the points of the fine cube grid consisting of 5 x 5 x 7 points (with 8mm horizontal resolution) or 7 x 7 x 7 points (with 5mm horizontal resolution) or 8 x 8 x 7 points (with 4mm horizontal resolution). The algorithm that finds the maximal averaged volume is separated into three different stages.

- The data between the dipole center of the probe and the surface of the phantom are extrapolated. This data cannot be measured since the center of the dipole is 2.7 mm away from the tip of the probe and the distance between the surface and the lowest measuring point is about 1 mm (see probe calibration sheet). The extrapolated data from a cube measurement can be visualized by selecting "Graph Evaluated".
- The maximum interpolated value is searched with a straight-forward algorithm. Around this maximum the SAR - values averaged over the spatial volumes (1g or 10 g) are computed using the 3d-spline interpolation algorithm. If the volume cannot be evaluated (i.e., if a part of the grid was cut off by the boundary of the measurement area) the evaluation will be started on the corners of the bottom plane of the cube.
- All neighboring volumes are evaluated until no neighboring volume with a higher average value is found.

Extrapolation

The extrapolation is based on a least square algorithm [W. Gander, Computer mathematic, p.168-180]. Through the points in the first 3 cm along the z-axis, polynomials of order four are calculated. These polynomials are then used to evaluate the points between the surface and the probe tip. The points, calculated from the surface, have a distance of 1 mm from each other.

Interpolation

The interpolation of the points is done with a 3d-Spline. The 3d-Spline is composed of three one-dimensional splines with the "Not a knot"-condition [W. Gander, Computer mathematic, p.141-150] (x, y and z -direction) [Numerical Recipes in C, Second Edition, p.123ff].

Volume Averaging

At First the size of the cube is calculated. Then the volume is integrated with the trapezoidal algorithm. 8000 points (20x20x20) are interpolated to calculate the average.

Advanced Extrapolation

DASY5 uses the advanced extrapolation option which is able to compensate boundary effects on E-field probes.

3.2.6 DATA STORAGE AND EVALUATION

3.2.6.1 Data Storage

The DASY5 software stores the acquired data from the data acquisition electronics as raw data (in microvolt readings from the probe sensors), together with all necessary software parameters for the data evaluation (probe calibration data, liquid parameters and device frequency and modulation data) in measurement files with the extension "DAE". The software evaluates the desired unit and format for output each time the data is visualized or exported. This allows verification of the complete software setup even after the measurement and allows correction of incorrect parameter settings. For example, if a measurement has been performed with a wrong crest factor parameter in the device setup, the parameter can be corrected afterwards and the data can be re-evaluated.

The measured data can be visualized or exported in different units or formats, depending on the selected probe type ([V/m], [A/m], [°C], [mW/g], [mW/cm²], [dBrel], etc.). Some of these units are not available in certain situations or show meaningless results, e.g., a SAR output in a lossless media will always be zero. Raw data can also be exported to perform the evaluation with other software packages.

3.2.7 DATA EVALUATION BY SEMCAD

The SEMCAD software automatically executes the following procedures to calculate the field units from the microvolt readings at the probe connector. The parameters used in the evaluation are stored in the configuration modules of the software:

Probe parameters:	Sensitivity	Normi, ai0, ai1, ai2
	Conversion factor	ConvFj
	Diode compression point	Dcpj
Device parameters:	Frequency	f
	Crest factor	cf
Media parameters:	Conductivity	
	Density	

These parameters must be set correctly in the software. They can be found in the component documents or they can be imported into the software from the configuration files issued for the DASY5 components. In the direct measuring mode of the multi meter option, the parameters of the actual system setup are used. In the scan visualization and export modes, the parameters stored in the corresponding document files are used.

The first step of the evaluation is a linearization of the filtered input signal to account for the compression characteristics of the detector diode. The compensation depends on the input signal, the diode type and the DC-transmission factor from the diode to the evaluation electronics.

If the exciting field is pulsed, the crest factor of the signal must be known to correctly compensate for peak power. The formula for each channel can be given as:

$$V_i = U_i + U_i^2 \cdot cf / dcp_i$$

With	V_i = compensated signal of channel i	(i = x, y, z)
	U_i = input signal of channel i	(i = x, y, z)
	cf = crest factor of exciting field	(DASY parameter)
	dcp _i = diode compression point	(DASY parameter)

From the compensated input signals the primary field data for each channel can be evaluated:

$$\text{E-field probes: } E_i = (V_i / \text{Norm}_i \cdot \text{ConvF})^{1/2}$$

$$\text{H-field probes: } H_i = (V_i)^{1/2} \cdot (a_{i0} + a_{i1} f + a_{i2} f^2) / f$$

With V_i = compensated signal of channel i ($i = x, y, z$)

Norm_i = sensor sensitivity of channel i ($i = x, y, z$)

[mV/(V/m)²] for E-field Probes

ConvF = sensitivity enhancement in solution

a_{ij} = sensor sensitivity factors for H-field probes

f = carrier frequency [GHz]

E_i = electric field strength of channel i in V/m

H_i = magnetic field strength of channel i in A/m

The RSS value of the field components gives the total field strength (Hermitian magnitude):

$$E_{\text{tot}} = (E_x^2 + E_y^2 + E_z^2)^{1/2}$$

The primary field data are used to calculate the derived field units.

$$\text{SAR} = (E_{\text{tot}})^2 \cdot \sigma / (\rho \cdot 1000)$$

With SAR = local specific absorption rate in mW/g

E_{tot} = total field strength in V/m

= conductivity in [mho/m] or [Siemens/m]

= equivalent tissue density in g/cm³

Note that the density is normally set to 1 (or 1.06), to account for actual brain density rather than the density of the simulation liquid. The power flow density is calculated assuming the excitation field to be a free space field.

$$P_{\text{pwe}} = E_{\text{tot}}^2 / 3770 \text{ or } P_{\text{pwe}} = H_{\text{tot}}^2 \cdot 37.7$$

With P_{pwe} = equivalent power density of a plane wave in mW/cm²

E_{tot} = total field strength in V/m

H_{tot} = total magnetic field strength in A/m

4. SYSTEM VERIFICATION PROCEDURE

4.1 TISSUE VERIFICATION

The simulating liquids should be checked at the beginning of a series of SAR measurements to determine if the dielectric parameters are within the tolerances of the specified target values. The measured conductivity and relative permittivity should be within $\pm 5\%$ of the target values.

The following materials are used for producing the tissue-equivalent materials.

Tissue Type	Bactericide	DGBE	HEC	NaCl	Sucrose	Triton X-100	Water	Diethylene Glycol Mono-hexylether
Head 2450	-	45.0	-	0.1	-	-	54.9	-
Head 5G	-	-	-	-	-	17.2	65.5	17.3

Salt: 99+% Pure Sodium Chloride; Sugar: 98+% Pure Sucrose; Water: De-ionized, 16M + resistivity
 HEC: Hydroxyethyl Cellulose; DGBE: 99+% Di(ethylene glycol) butyl ether,[2-(2-butoxyethoxy)ethanol]
 Triton X-100(ultra pure): Polyethylene glycol mono [4-(1,1,3,3-tetramethylbutyl)phenyl]ether

Tissue Verification									
Tissue Type	Frequency (MHz)	Liquid Temp. (°C)	Conductivity (σ)	Permittivity (ϵ_r)	Targeted Conductivity (σ)	Targeted Permittivity (ϵ_r)	Deviation Conductivity (σ) (%)	Deviation Permittivity (ϵ_r) (%)	Date
Head	2450	22.3	1.795	39.754	1.80	39.2	-0.28	1.41	May 29, 2021
Head	2450	22.2	1.821	39.963	1.80	39.2	1.17	1.95	Jun. 04, 2021
Head	5200	22.4	4.788	36.071	4.66	36.0	2.75	0.20	May 30, 2021
Head	5200	22.3	4.714	35.707	4.66	36.0	1.16	-0.81	Jun. 02, 2021
Head	5300	22.4	4.913	35.827	4.76	35.9	3.21	-0.20	May 30, 2021
Head	5300	22.3	4.838	35.462	4.76	35.9	1.64	-1.22	Jun. 02, 2021
Head	5500	22.4	5.144	35.337	4.96	35.6	3.71	-0.74	May 30, 2021
Head	5500	22.3	5.065	34.972	4.96	35.6	2.12	-1.76	Jun. 02, 2021
Head	5600	22.4	5.267	35.085	5.07	35.5	3.89	-1.17	May 30, 2021
Head	5600	22.3	5.188	34.720	5.07	35.5	2.33	-2.20	Jun. 02, 2021
Head	5800	22.4	5.520	34.606	5.27	35.3	4.74	-1.97	May 30, 2021
Head	5800	22.3	5.438	34.241	5.27	35.3	3.19	-3.00	Jun. 02, 2021

Note:

- 1)The dielectric parameters of the tissue-equivalent liquid should be measured under similar ambient conditions and within 2 °C of the conditions expected during the SAR evaluation to satisfy protocol requirements.
- 2)KDB 865664 was ensured to be applied for probe calibration frequencies greater than or equal to 50MHz of the EUT frequencies.
- 3)The above measured tissue parameters were used in the DASY software to perform interpolation via the DASY software to determine actual dielectric parameters at the test frequencies. The SAR test plots may slightly differ from the table above since the DASY rounds to three significant digits.

4.2 SYSTEM CHECK

The system check is performed for verifying the accuracy of the complete measurement system and performance of the software. The system check is performed with tissue equivalent material according to IEEE P1528 (described above). The following table shows system check results for all frequency bands and tissue liquids used during the tests.

System Check	Date	Frequency (MHz)	Targeted SAR-1g (W/kg)	Measured SAR-1g (W/kg)	normalized SAR-1g (W/kg)	Deviation (%)	Dipole S/N
Head	May 29, 2021	2450	52.10	12.60	50.40	-3.26	919
Head	Jun. 04, 2021	2450	52.10	12.41	49.64	-4.72	919
Head	May 30, 2021	5200	75.30	7.58	75.80	0.66	1160
Head	Jun. 02, 2021	5200	75.30	7.56	75.60	0.40	1160
Head	May 30, 2021	5300	76.80	7.87	78.70	2.47	1160
Head	Jun. 02, 2021	5300	76.80	7.56	75.60	-1.56	1160
Head	May 30, 2021	5500	80.80	7.96	79.60	-1.49	1160
Head	Jun. 02, 2021	5500	80.80	7.92	79.20	-1.98	1160
Head	May 30, 2021	5600	78.60	8.11	81.10	3.18	1160
Head	Jun. 02, 2021	5600	78.60	7.76	77.60	-1.27	1160
Head	May 30, 2021	5800	77.90	7.99	79.90	2.57	1160
Head	Jun. 02, 2021	5800	77.90	7.79	77.90	0.00	1160

4.3 SYSTEM CHECK PROCEDURE

The system check is performed by using a system check dipole which is positioned parallel to the planar part of the SAM phantom at the reference point. The distance of the dipole to the SAM phantom is determined by a plexiglass spacer. The dipole is connected to the signal source consisting of signal generator and amplifier via a directional coupler, N-connector cable and adaption to SMA. It is fed with a power of 250 mW (below 3GHz) or 100mW (3-6GHz). To adjust this power a power meter is used.

The power sensor is connected to the cable before the system check to measure the power at this point and do adjustments at the signal generator. At the outputs of the directional coupler both return loss as well as forward power are controlled during the system check to make sure that emitted power at the dipole is kept constant. This can also be checked by the power drift measurement after the test.

System check results have to be equal or near the values determined during dipole calibration (target SAR in table above) with the relevant liquids and test system ($\pm 10\%$).

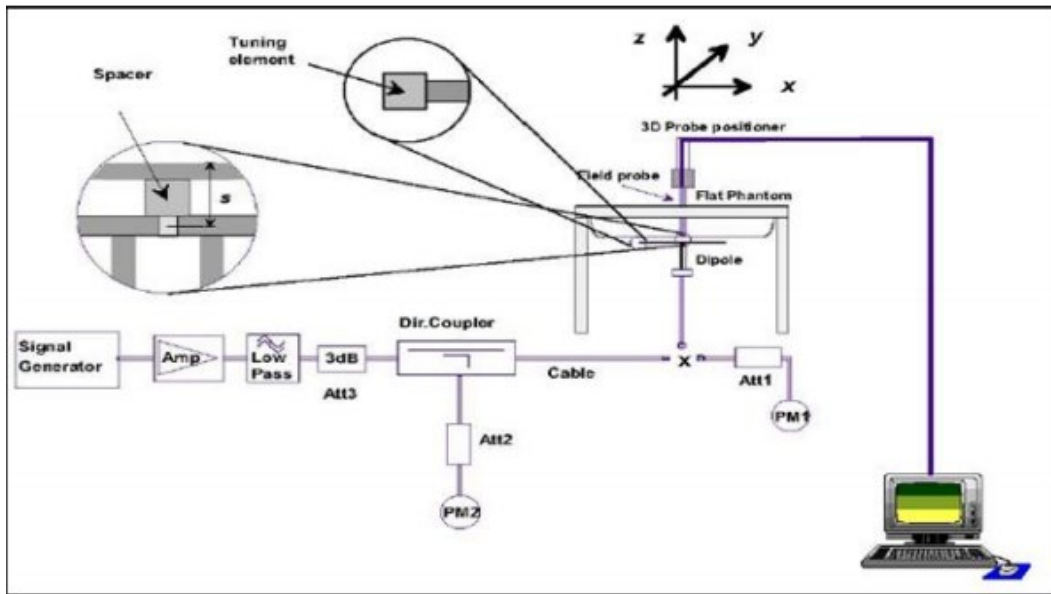

5. SAR MEASUREMENT VARIABILITY AND UNCERTAINTY

5.1 SAR MEASUREMENT VARIABILITY

Per KDB865664 D01 SAR measurement 100 MHz to 6 GHz, SAR measurement variability must be assessed for each frequency band, which is determined by the SAR probe calibration point and tissue-equivalent medium used for the device measurements. The additional measurements are repeated after the completion of all measurements requiring the same head or body tissue-equivalent medium in a frequency band. The test device should be returned to ambient conditions (normal room temperature) with the battery fully charged before it is re-mounted on the device holder for the repeated measurement(s) to minimize any unexpected variations in the repeated results.

- 1) Repeated measurement is not required when the original highest measured SAR is < 0.80 W/kg; steps 2) through 4) do not apply.
- 2) When the original highest measured SAR is ≥ 0.80 W/kg, repeat that measurement once.
- 3) Perform a second repeated measurement only if the ratio of largest to smallest SAR for the original and first repeated measurements is > 1.20 or when the original or repeated measurement is ≥ 1.45 W/kg ($\sim 10\%$ from the 1-g SAR limit).
- 4) Perform a third repeated measurement only if the original, first or second repeated measurement is ≥ 1.5 W/kg and the ratio of largest to smallest SAR for the original, first and second repeated measurements is > 1.20 .

The same procedures should be adapted for measurements according to extremity and occupational exposure limits by applying a factor of 2.5 for extremity exposure and a factor of 5 for occupational exposure to the corresponding SAR thresholds.

The detailed repeated measurement results are shown in section 7.2.

6. OPERATIONAL CONDITIONS DURING TEST

6.1 SAR TEST CONFIGURATION

6.1.1 WIFI TEST CONFIGURATION

For WLAN / BT SAR testing, WLAN / BT engineering testing software installed on the DUT can provide continuous transmitting RF signal.

2.4G

Mode	802.11b	802.11g	802.11ac (VHT20/40)	802.11ax (HE20/40)	BT / BLE
Duty cycle	100%				
Crest factor	1				

5G

Mode	802.11a	802.11ac (VHT20/40/80)	802.11ax (HE20/40/80)
Duty cycle	100%		
Crest factor	1		

For WiFi SAR testing, a communication link is set up with the test mode software for WiFi mode test. During the test, at the each test frequency channel, the EUT is operated at the RF continuous emission mode. The test procedures in KDB 248227 D01 are applied.

6.1.1.1 2.4G SAR Test Requirements

802.11b DSSS SAR Test Requirements

SAR is measured for 2.4 GHz 802.11b DSSS using either a fixed test position or, when applicable, the initial test position procedure. SAR test reduction is determined according to the following:

- 1) When the reported SAR of the highest measured maximum output power channel for the exposure configuration is ≤ 0.8 W/kg, no further SAR testing is required for 802.11b DSSS in that exposure configuration.
- 2) When the reported SAR is > 0.8 W/kg, SAR is required for that exposure configuration using the next highest measured output power channel. When any reported SAR is > 1.2 W/kg, SAR is required for the third channel; i.e., all channels require testing.

2.4 GHz 802.11g/n OFDM SAR Test Exclusion Requirements

When SAR measurement is required for 2.4 GHz 802.11g/n OFDM configurations, the measurement and test reduction procedures for OFDM are applied. SAR is not required for the following 2.4 GHz OFDM conditions.

- 1) When KDB Publication 447498 SAR test exclusion applies to the OFDM configuration.
- 2) When the highest reported SAR for DSSS is adjusted by the ratio of OFDM to DSSS specified maximum output power and the adjusted SAR is ≤ 1.2 W/kg.

SAR Test Requirements for OFDM configurations

When SAR measurement is required for 2.4 GHz 802.11g/n OFDM configurations, each stand alone. And frequency aggregated band is considered separately for SAR test reduction. In applying the initial test configuration and subsequent test configuration procedures, the 802.11 transmission configuration with the highest specified maximum output power and the channel within a test configuration with the highest measured maximum output power should be clearly distinguished to apply the procedures.

6.1.1.2 5G SAR Test Requirements

U-NII-1 and U-NII-2A Band

For devices that operate in both U-NII-1 and U-NII-2A bands, when the same maximum output power is specified for both bands, begin SAR measurement in U-NII-2A band by applying the OFDM SAR requirements. If the highest reported SAR for a test configuration is ≤ 1.2 W/kg, SAR is not required for U-NII-1 band for that configuration (802.11 mode and exposure condition); otherwise, both bands are tested independently for SAR. When different maximum output power is specified for the bands, begin SAR measurement in the band with higher specified maximum output power. The highest reported SAR for the tested configuration is adjusted by the ratio of lower to higher specified maximum output power for the two bands. When the adjusted SAR is ≤ 1.2 W/kg, SAR is not required for the band with lower maximum output power in that test configuration; otherwise, both bands are tested independently for SAR.

U-NII-2C, U-NII-3 Bands

The frequency range covered by these bands is 380 MHz (5.47 – 5.85 GHz), which requires a minimum of at least two SAR probe calibration frequency points to support SAR measurements. When Terminal Doppler Weather Radar (TDWR) restriction applies, the channels at 5.60 – 5.65 GHz in U-NII-2C band must be disabled with acceptable mechanisms and documented in the equipment certification.

Unless band gap channels are permanently disabled, they must be considered for SAR testing.

To maintain SAR measurement accuracy and to facilitate test reduction, the channels in U-NII-2C band above 5.65 GHz may be grouped with the 5.8 GHz channels in U-NII-3 or §15.247 band to enable two SAR probe calibration frequency points to cover the bands, including the band gap channels.¹¹ When band gap channels are supported and the bands are not aggregated for SAR testing, band gap channels must be considered independently in each band according to the normally required OFDM SAR measurement and probe calibration frequency points requirements.

6.1.1.3 OFDM transmission mode and SAR test channel selection

For the 2.4GHz and 5GHz bands, when the same maximum output power was specified for multiple OFDM transmission mode configurations in a frequency band or aggregated band, SAR is measured using the configuration with the largest channel bandwidth, lowest order modulation and lowest data rate. When the maximum output power of a channel is the same for equivalent OFDM configurations (for example 802.11a, 802.11n and 802.11ac, or 802.11g and 802.11n, with the same channel bandwidth, modulation, and data rate, etc.), the lower order 802.11 mode (i.e.802.11a then 802.11n and 802.11ac, or 802.11g then 802.11n) is used for SAR measurement. When the maximum output power are the same for multiple test channels, either according to the default or additional power measurement requirements, SAR is measured using the channel closest to the middle of the frequency band or aggregated band. When there are multiple channels with the same maximum output power, SAR is measured using the higher number channel.

6.1.1.4 Initial test configuration procedure

For OFDM, in both 2.4GHz and 5GHz bands, an initial test configuration is determined for each frequency band and aggregated band, according to the transmission mode with the highest maximum output power specified for SAR measurements. When the same maximum output power is specified for multiple OFDM transmission mode configurations in a frequency band or aggregated band, SAR is measured using the configuration(s) with the largest channel bandwidth, lowest order modulation, and lowest data rate. If the average RF output powers of the highest identical transmission modes are within 0.25 dB of each other, mid channel of the transmission mode with highest average RF output powers is the initial test channel. Otherwise, the channel of the transmission mode with the highest average RF output power will be the initial test configuration.

When the reported SAR is ≤ 0.8 W/kg, no additional measurements on other test channels are required. Otherwise, SAR is evaluated using the subsequent highest average RF output channel until the reported SAR result is ≤ 1.2 W/kg or all channels are measured. When there are multiple untested channels having the same subsequent highest average RF output power, the channel with higher frequency from the lowest 802.11 mode is considered for SAR measurement.

6.2 TEST POSITION

This DUT was tested in 2 different positions. They are back of keyboard and back of screen as illustrated below:

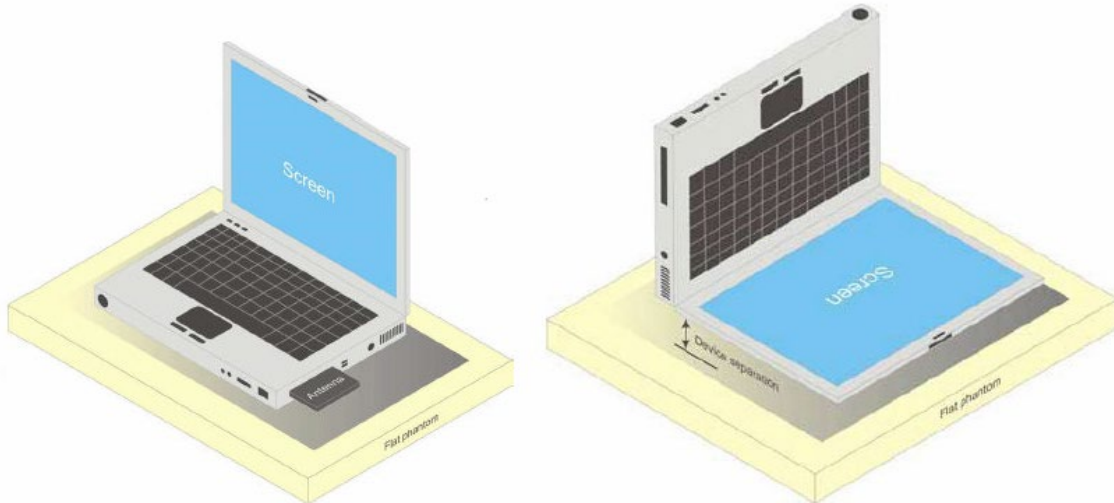

SAR testing to ensure safety of bystanders or people other than the user is not specifically covered in the harmonized standards but it is a consideration for declaration of compliance to the Directive.

Therefore, the manufacturer is encouraged to ensure that the RF exposure and SAR assessments do cover the safety of all persons, during the normal intended use of the device. For example, this may apply to a device where normal intended use could locate the transmitting antenna at a safe distance from the user but a closer distance to other persons located or standing nearby.

Therefore, we tested the position at the back of the screen, which is bystander SAR. Since the integrated antenna is located at the back of the display screen, the test distance we tested is 25mm.

7. TEST RESULT

7.1 CONDUCTED POWER RESULTS

7.1.1 CONDUCTED POWER MEASUREMENTS OF BT

BT	Average Conducted Power(dBm)			
	Max. Tune up	CH0	CH39	CH78
		2402MHz	2441MHz	2480MHz
DH5	11.50	11.32	11.15	10.78
2DH5	8.50	7.75	7.65	7.36
3DH5	8.50	7.73	7.60	7.59

BT	Average Conducted Power(dBm)			
	Max. Tune up	CH0	CH19	CH39
		2402MHz	2441MHz	2480MHz
BLE(1M)	11.50	11.29	11.22	10.72
BLE(2M)	11.50	10.11	10.38	10.14

Note:

- 1) The Average conducted power of BT is measured with RMS detector.
- 2) The tested channel results are marks in bold.

7.1.2 CONDUCTED POWER MEASUREMENTS OF WIFI 2.4G

Band	Mode	Channel	Frequency (MHz)	Data Rate (Mbps)	Max. Tune up	Average Power(dBm)
2.4G WIFI _1TX _MAIN ANT	802.11b	1	2412	1	19.50	19.11
		6	2437		19.50	19.25
		11	2462		19.50	19.08
		12	2467		16.00	15.45
		13	2472		9.50	9.33
	802.11g	1	2412	6	18.00	17.93
		6	2437		19.00	18.85
		11	2462		17.50	17.28
		12	2467		12.50	12.41
		13	2472		7.50	7.45
	802.11ac VHT20	1	2412	HT0	17.00	Not required
		6	2437		18.50	
		11	2462		17.00	
		12	2467		10.50	
		13	2472		6.00	
	802.11ac VHT40	3	2422	HT0	15.50	
		6	2437		16.50	
		9	2452		15.50	
		10	2457		9.00	
		11	2462		7.00	
	802.11ax HE20	1	2412	MCS0	17.50	
		6	2437		18.50	
		11	2462		17.00	
		12	2467		11.00	
		13	2472		6.50	
802.11ax HE40	3	2422	MCS0	16.00		
	6	2437		17.00		
	9	2452		15.50		
	10	2457		9.50		
	11	2462		7.00		

Band	Mode	Channel	Frequency (MHz)	Data Rate (Mbps)	Max. Tune up	Average Power(dBm)
2.4G WIFI _1TX _AUX ANT	802.11b	1	2412	1	20.00	19.69
		6	2437		20.00	19.71
		11	2462		20.00	19.96
		12	2467		16.00	15.68
		13	2472		9.50	9.28
	802.11g	1	2412	6	17.50	17.15
		6	2437		18.50	18.06
		11	2462		17.50	17.26
		12	2467		12.50	12.16
		13	2472		7.00	6.97
	802.11ac VHT20	1	2412	HT0	17.00	Not required
		6	2437		18.00	
		11	2462		16.50	
		12	2467		10.50	
		13	2472		6.00	
	802.11ac VHT40	3	2422	HT0	15.50	
		6	2437		16.50	
		9	2452		15.50	
		10	2457		8.50	
		11	2462		7.00	
	802.11ax HE20	1	2412	MCS0	17.00	
		6	2437		18.50	
		11	2462		17.00	
		12	2467		10.50	
		13	2472		6.00	
802.11ax HE40	3	2422	MCS0	15.50		
	6	2437		16.50		
	9	2452		15.50		
	10	2457		9.00		
	11	2462		7.00		

Band	Mode	Channel	Frequency (MHz)	Data Rate (Mbps)	MAIN Average Power(dBm)	AUX Average Power(dBm)	Max. Tune up	Total Average Power(dBm)
2.4G WIFI _2TX _MAIN ANT + AUX ANT	802.11b	1	2412	1	19.38	19.05	22.50	22.23
		6	2437		19.42	19.22	22.50	22.33
		11	2462		19.21	19.23	22.50	22.23
		12	2467		15.75	15.65	19.00	18.71
		13	2472		9.27	9.32	12.50	12.31
	802.11g	1	2412	6	17.34	17.38	20.50	20.37
		6	2437		18.23	18.06	21.50	21.16
		11	2462		17.22	17.29	20.50	20.27
		12	2467		12.47	12.05	15.50	15.28
		13	2472		7.44	7.07	10.50	10.27
	802.11ac VHT20	1	2412	HT8	16.75	16.98	20.00	19.88
		6	2437		18.26	18.13	21.50	21.21
		11	2462		16.23	16.24	19.50	19.25
		12	2467		10.28	10.28	13.50	13.29
		13	2472		5.78	5.77	9.00	8.79
	802.11ac VHT40	3	2422	HT8	15.36	15.12	18.50	18.25
		6	2437		16.37	16.19	19.50	19.29
		9	2452		15.13	15.17	18.50	18.16
		10	2457		8.78	8.56	12.00	11.68
		11	2462		6.72	6.79	10.00	9.77
	802.11ax HE20	1	2412	MCS8	16.48	16.72	20.00	19.61
		6	2437		18.11	18.25	21.50	21.19
		11	2462		16.64	16.88	20.00	19.77
		12	2467		10.85	10.93	14.00	13.90
		13	2472		5.53	5.61	9.00	8.58
802.11ax HE40	3	2422	MCS8	15.23	15.41	18.50	18.33	
	6	2437		16.49	16.57	20.00	19.54	
	9	2452		15.01	15.15	18.50	18.09	
	10	2457		8.58	8.82	12.00	11.71	
	11	2462		6.59	6.73	10.00	9.67	

Note:

- 1) The Average conducted power of WiFi 2.4G is measured with RMS detector.
- 2) Per KDB248227 D01, for WiFi 2.4G, the highest measured maximum output power Channel for DSSS modes (802.11b) was selected for SAR measurement. SAR for OFDM modes (2.4GHz 802.11g/n, VHT) was not required When the highest reported SAR for DSSS is adjusted by the ratio of OFDM modes (802.11g/n) to DSSS modes (802.11b) specified maximum output power and the adjusted SAR is ≤ 1.2 W/kg.
- 3) The tested channel results are marks in bold.

7.1.3 CONDUCTED POWER MEASUREMENTS OF WIFI 5G

1. Conducted power measurement results of 5.2G WiFi

Band	Mode	Channel	Frequency (MHz)	Data Rate (Mbps)	Max. Tune up	Average Power(dBm)
5.2G WIFI _1TX _MAIN _ANT	802.11a	36	5180	6	16.00	15.42
		40	5200		17.50	17.01
		48	5240		19.00	18.48
	802.11ac VHT20	36	5180	VHT0	16.00	15.80
		40	5200		17.50	16.92
		48	5240		18.50	18.30
	802.11ac VHT40	38	5190	VHT0	15.50	15.15
		46	5230		18.00	17.60
	802.11ac VHT80	42	5210	VHT0	14.00	13.84
	802.11ax HE20	36	5180	MCS0	16.50	16.01
		40	5200		17.50	17.01
		48	5240		18.50	18.13
	802.11ax HE40	38	5190	MCS0	15.50	15.02
		46	5230		18.00	17.20
	802.11ax HE80	42	5210	MCS0	14.50	14.02

Band	Mode	Channel	Frequency (MHz)	Data Rate (Mbps)	Max. Tune up	Average Power(dBm)
5.2G WIFI _1TX _AUX _ANT	802.11a	36	5180	6	15.50	15.32
		40	5200		17.50	17.11
		48	5240		17.50	16.92
	802.11ac VHT20	36	5180	VHT0	16.00	15.21
		40	5200		17.00	16.36
		48	5240		17.50	17.22
	802.11ac VHT40	38	5190	VHT0	15.00	14.68
		46	5230		17.50	17.11
	802.11ac VHT80	42	5210	VHT0	14.00	13.77
	802.11ax HE20	36	5180	MCS0	16.00	15.45
		40	5200		17.50	17.15
		48	5240		17.50	17.04
	802.11ax HE40	38	5190	MCS0	15.50	15.13
		46	5230		17.50	17.11
	802.11ax HE80	42	5210	MCS0	14.00	13.38

Band	Mode	Channel	Frequency (MHz)	Data Rate (Mbps)	MAIN Average Power(dBm)	AUX Average Power(dBm)	Max. Tune up	Total Average Power(dBm)
5.2G WIFI _2TX _MAIN ANT + AUX ANT	802.11a	36	5180	6	15.49	12.56	18.50	17.28
		40	5200		17.63	14.41	20.50	19.32
		48	5240		19.93	16.32	22.00	21.50
	802.11ac VHT20	36	5180	HT8	16.01	15.55	19.00	18.80
		40	5200		17.15	15.64	20.00	19.47
		48	5240		18.04	15.38	21.50	19.92
	802.11ac VHT40	38	5190	VHT8	14.93	14.66	18.50	17.81
		46	5230		16.82	16.22	20.50	19.54
	802.11ac VHT80	42	5210	VHT8	14.25	12.54	17.00	16.49
	802.11ax HE20	36	5180	MCS8	16.64	14.68	19.50	18.78
		40	5200		17.48	14.67	20.50	19.31
		48	5240		18.55	16.56	21.50	20.68
	802.11ax HE40	38	5190	MCS8	15.53	14.18	18.50	17.92
		46	5230		17.92	16.36	21.00	20.22
	802.11ax HE80	42	5210	MCS8	14.42	12.81	17.50	16.70

Note:

1) The Average conducted power of WiFi 5.2G is measured with RMS detector.

2. Conducted power measurement results of 5.3G WiFi

Band	Mode	Channel	Frequency (MHz)	Data Rate (Mbps)	Max. Tune up	Average Power(dBm)
5.3G WIFI _1TX _MAIN _ANT	802.11a	52	5260	6	19.00	18.82
		60	5300		19.00	18.93
		64	5320		16.00	15.62
	802.11ac VHT20	52	5260	VHT0	18.50	18.06
		60	5300		18.00	17.52
		64	5320		16.00	15.70
	802.11ac VHT40	54	5270	VHT0	18.00	17.76
		62	5310		15.50	15.36
	802.11ac VHT80	58	5290	VHT0	14.50	13.94
	802.11ax HE20	52	5260	MCS0	19.00	18.38
		60	5300		18.50	17.93
		64	5320		16.00	15.55
	802.11ax HE40	54	5270	MCS0	18.00	17.36
		62	5310		15.50	15.18
802.11ax HE80	58	5290	MCS0	14.50	14.12	

Band	Mode	Channel	Frequency (MHz)	Data Rate (Mbps)	Max. Tune up	Average Power(dBm)
5.3G WIFI _1TX _AUX _ANT	802.11a	52	5260	6	17.50	17.39
		60	5300		17.50	17.34
		64	5320		16.50	16.39
	802.11ac VHT20	52	5260	VHT0	17.50	17.05
		60	5300		17.50	17.03
		64	5320		15.50	14.81
	802.11ac VHT40	54	5270	VHT0	17.50	16.88
		62	5310		15.00	14.62
	802.11ac VHT80	58	5290	VHT0	14.00	13.50
	802.11ax HE20	52	5260	MCS0	17.50	17.32
		60	5300		17.50	17.31
		64	5320		16.00	15.20
	802.11ax HE40	54	5270	MCS0	17.50	17.13
		62	5310		15.50	15.09
802.11ax HE80	58	5290	MCS0	14.50	13.84	

Band	Mode	Channel	Frequency (MHz)	Data Rate (Mbps)	MAIN Average Power(dBm)	AUX Average Power(dBm)	Max. Tune up	Total Average Power(dBm)
5.3G WIFI _2TX _MAIN ANT + AUX ANT	802.11a	52	5260	6	19.07	17.57	22.00	21.39
		60	5300		19.34	17.76	22.00	21.63
		64	5320		15.77	14.16	19.00	18.05
	802.11ac VHT20	52	5260	VHT8	18.06	16.70	21.50	20.44
		60	5300		17.79	16.15	21.00	20.06
		64	5320		14.91	13.75	18.50	17.38
	802.11ac VHT40	54	5270	VHT8	17.95	16.33	21.00	20.23
		62	5310		14.77	14.19	18.50	17.50
	802.11ac VHT80	58	5290	VHT8	14.08	12.49	17.50	16.37
	802.11ax HE20	52	5260	MCS8	18.79	16.49	22.00	20.80
		60	5300		18.02	16.48	21.50	20.33
		64	5320		15.69	14.99	19.00	18.36
	802.11ax HE40	54	5270	MCS8	18.04	15.96	21.00	20.13
		62	5310		14.86	14.15	18.50	17.53
	802.11ax HE80	58	5290	MCS8	14.13	12.88	17.50	16.56

Note:

- 1) The Average conducted power of WiFi 5.3G is measured with RMS detector.
- 2) The tested channel results are marks in bold.

3. Conducted power measurement results of 5.6G WiFi

Band	Mode	Channel	Frequency (MHz)	Data Rate (Mbps)	Max. Tune up	Average Power(dBm)
5.6G WIFI _1TX _MAIN _ANT	802.11a	100	5500	6	17.50	17.08
		116	5580		19.00	18.63
		140	5700		18.00	17.92
	802.11ac VHT20	100	5500	VHT0	17.00	16.50
		116	5580		19.00	18.32
		140	5700		18.00	17.35
	802.11ac VHT40	102	5510	VHT0	17.00	16.18
		110	5550		17.50	17.05
		134	5670		17.50	17.13
	802.11ac VHT80	106	5530	VHT0	15.50	15.32
		122	5610		16.50	16.02
	802.11ax HE20	100	5500	MCS0	17.50	17.21
		116	5580		19.00	18.34
		140	5700		18.00	17.40
	802.11ax HE40	102	5510	MCS0	17.00	16.25
		110	5550		18.00	17.21
		134	5670		18.00	17.47
	802.11ax HE80	106	5530	MCS0	15.50	15.05
		122	5610		17.00	16.10

Band	Mode	Channel	Frequency (MHz)	Data Rate (Mbps)	Max. Tune up	Average Power(dBm)
5.6G WIFI _1TX _AUX ANT	802.11a	100	5500	6	17.00	16.65
		116	5580		19.00	18.62
		140	5700		18.00	17.51
	802.11ac VHT20	100	5500	VHT0	16.50	15.94
		116	5580		18.50	18.08
		140	5700		17.50	17.15
	802.11ac VHT40	102	5510	VHT0	16.50	16.30
		110	5550		17.00	16.65
		134	5670		17.50	17.19
	802.11ac VHT80	106	5530	VHT0	14.50	13.84
		122	5610		16.50	16.14
	802.11ax HE20	100	5500	MCS0	17.00	16.65
		116	5580		19.00	18.25
		140	5700		18.00	17.49
	802.11ax HE40	102	5510	MCS0	17.00	16.68
		110	5550		17.50	16.83
		134	5670		17.50	17.02
	802.11ax HE80	106	5530	MCS0	15.00	14.72
122		5610	16.50		15.94	

Band	Mode	Channel	Frequency (MHz)	Data Rate (Mbps)	MAIN Average Power(dBm)	AUX Average Power(dBm)	Max. Tune up	Total Average Power(dBm)
5.6G WIFI _2TX _MAIN ANT + AUX ANT	802.11a	100	5500	6	16.57	16.11	19.50	19.36
		116	5580		18.61	18.56	22.00	21.60
		140	5700		17.62	17.21	20.50	20.43
	802.11ac VHT20	100	5500	VHT8	16.18	16.99	20.00	19.61
		116	5580		19.15	18.51	22.00	21.85
		140	5700		17.15	16.52	20.50	19.86
	802.11ac VHT40	102	5510	VHT8	16.32	16.23	20.00	19.29
		110	5550		16.67	17.19	20.50	19.95
		134	5670		17.03	17.24	20.50	20.15
	802.11ac VHT80	106	5530	VHT8	15.05	14.28	18.00	17.69
		122	5610		15.96	15.78	19.50	18.88
	802.11ax HE20	100	5500	MCS8	16.67	16.87	20.00	19.78
		116	5580		18.25	18.34	22.00	21.31
		140	5700		17.39	17.04	21.00	20.23
	802.11ax HE40	102	5510	MCS8	16.61	16.34	20.00	19.49
		110	5550		16.85	16.22	20.50	19.56
		134	5670		17.37	17.53	21.00	20.46
	802.11ax HE80	106	5530	MCS8	15.58	14.78	18.50	18.21
122		5610	17.15		15.65	20.00	19.47	

Note:

- 1) The Average conducted power of WiFi 5.6G is measured with RMS detector.
- 2) The tested channel results are marks in bold.

4. Conducted power measurement results of 5.8G WiFi

Band	Mode	Channel	Frequency (MHz)	Data Rate (Mbps)	Max. Tune up	Average Power(dBm)
5.8G WIFI _1TX _MAIN _ANT	802.11a	149	5745	6	19.00	18.53
		157	5785		19.00	18.69
		165	5825		19.00	18.50
	802.11ac VHT20	149	5745	VHT0	19.00	18.13
		157	5785		19.00	18.39
		165	5825		19.00	18.41
	802.11ac VHT40	151	5755	VHT0	17.50	16.98
		159	5795		17.50	16.84
	802.11ac VHT80	155	5775	VHT0	16.50	16.09
	802.11ax HE20	149	5745	MCS0	19.00	18.34
		157	5785		19.00	18.66
		165	5825		19.00	18.59
	802.11ax HE40	151	5755	MCS0	18.00	17.59
		159	5795		18.00	17.35
802.11ax HE80	155	5775	MCS0	17.00	16.54	

Band	Mode	Channel	Frequency (MHz)	Data Rate (Mbps)	Max. Tune up	Average Power(dBm)
5.8G WIFI _1TX _AUX _ANT	802.11a	149	5745	6	19.00	18.41
		157	5785		19.00	18.05
		165	5825		19.00	18.28
	802.11ac VHT20	149	5745	VHT0	18.50	18.13
		157	5785		18.50	17.99
		165	5825		18.50	17.95
	802.11ac VHT40	151	5755	VHT0	17.50	17.02
		159	5795		17.50	17.35
	802.11ac VHT80	155	5775	VHT0	16.50	16.13
	802.11ax HE20	149	5745	MCS0	18.50	17.94
		157	5785		18.50	18.03
		165	5825		18.50	18.01
	802.11ax HE40	151	5755	MCS0	18.00	17.68
		159	5795		17.50	17.12
802.11ax HE80	155	5775	MCS0	16.50	16.22	

Band	Mode	Channel	Frequency (MHz)	Data Rate (Mbps)	MAIN Average Power(dBm)	AUX Average Power(dBm)	Max. Tune up	Total Average Power(dBm)
5.8G WIFI _2TX _MAIN ANT + AUX ANT	802.11a	149	5745	6	18.46	19.11	22.50	21.81
		157	5785		18.27	19.26	22.50	21.80
		165	5825		18.16	19.09	22.50	21.66
	802.11ac VHT20	149	5745	VHT8	17.94	16.99	21.50	20.50
		157	5785		17.75	16.84	21.50	20.33
		165	5825		17.83	17.60	21.50	20.73
	802.11ac VHT40	151	5755	VHT8	17.10	16.00	20.50	19.60
		159	5795		16.93	16.93	20.50	19.94
	802.11ac VHT80	155	5775	VHT8	16.03	16.09	19.50	19.07
	802.11ax HE20	149	5745	MCS8	18.11	18.31	22.00	21.22
		157	5785		18.04	18.64	22.00	21.36
		165	5825		18.78	18.66	22.50	21.73
	802.11ax HE40	151	5755	MCS8	18.13	17.47	21.00	20.82
		159	5795		18.36	16.88	21.00	20.69
	802.11ax HE80	155	5775	MCS8	17.66	15.24	20.00	19.63

Note:

- 1) The Average conducted power of WiFi 5.8G is measured with RMS detector.
- 2) The tested channel results are marks in bold.

5. Overlapped Channels Between UNII-2C and UNII-3

Band	Mode	Channel	Frequency (MHz)	Data Rate (Mbps)	Max. Tune up	Average Power(dBm)
5.6G-5.8G _1TX _MAIN ANT	802.11a	144	5720	6	17.50	17.23
	802.11ac VHT20	144	5720	HT0	13.50	13.04
	802.11ac VHT40	142	5710	HT0	10.50	10.48
	802.11ac VHT80	138	5690	VHT0	15.00	14.62
	802.11ax HE20	144	5720	MCS0	14.00	13.52
	802.11ax HE40	142	5710	MCS0	11.00	10.97
	802.11ax HE80	138	5690	MCS0	14.00	13.65

Band	Mode	Channel	Frequency (MHz)	Data Rate (Mbps)	Max. Tune up	Average Power(dBm)
5.6G-5.8G _1TX _AUX ANT	802.11a	144	5720	6	17.50	17.44
	802.11ac VHT20	144	5720	HT0	12.00	11.80
	802.11ac VHT40	142	5710	HT0	9.50	8.83
	802.11ac VHT80	138	5690	VHT0	8.00	7.41
	802.11ax HE20	144	5720	MCS0	12.50	12.17
	802.11ax HE40	142	5710	MCS0	10.00	9.82
	802.11ax HE80	138	5690	MCS0	8.00	7.44

Band	Mode	Channel	Frequency (MHz)	Data Rate (Mbps)	MAIN Average Power(dBm)	AUX Average Power(dBm)	Max. Tune up	Total Average Power(dBm)
5.6G -5.8G _2TX _MAIN ANT + AUX ANT	802.11a	144	5720	6	17.20	17.42	20.50	20.32
	802.11ac VHT20	144	5720	HT8	13.10	13.05	16.50	16.09
	802.11ac VHT40	142	5710	HT8	10.04	9.93	13.50	13.00
	802.11ac VHT80	138	5690	VHT8	13.53	13.31	17.00	16.43
	802.11ax HE20	144	5720	MCS8	12.62	13.08	16.50	15.87
	802.11ax HE40	142	5710	MCS8	10.30	11.07	14.00	13.71
	802.11ax HE80	138	5690	MCS8	11.95	12.22	16.00	15.10

7.2 SAR TEST RESULTS

General Notes:

- 1) Per KDB447498 D01, all measurement SAR results are scaled to the maximum tune-up tolerance limit to demonstrate compliant.
- 2) Per KDB447498 D01, testing of other required channels within the operating mode of a frequency band is not required when the reported 1-g or 10-g SAR for the mid-band or highest output power channel is: ≤ 0.8 W/kg or 2.0 W/kg, for 1-g or 10-g respectively, when the transmission band is ≤ 100 MHz. When the maximum output power variation across the required test channels is $> \frac{1}{2}$ dB, instead of the middle channel, the highest output power channel must be used.
- 3) Per KDB865664 D01, for each frequency band, repeated SAR measurement is required only when the measured SAR is ≥ 0.8 W/kg; if the deviation among the repeated measurement is $\leq 20\%$, and the measured SAR < 1.45 W/kg, only one repeated measurement is required.
- 4) Per KDB941225 D06, the DUT Dimension is bigger than 9 cm x 5 cm, so 10mm is chosen as the test separation distance for Hotspot mode. When the antenna-to-edge distance is greater than 2.5cm, such position does not need to be tested.
- 5) Per KDB648474 D04, SAR is evaluated without a headset connected to the device. When the standalone reported body-worn SAR is ≤ 1.2 W/kg, no additional SAR evaluations using a headset are required.
- 6) Per KDB865664 D02, SAR plot is only required for the highest measured SAR in each exposure configuration, wireless mode and frequency band combination; Plots are also required when the measured SAR is > 1.5 W/kg, or > 7.0 W/kg for occupational exposure. The published RF exposure KDB procedures may require additional plots; for example, to support SAR to peak location separation ratio test exclusion and/or volume scan post-processing.

WLAN Notes:

- 1) For exposure conditions with multiple test positions, such as handset operating next to the ear, devices with hotspot mode, procedures for initial test position can be applied. Using the transmission mode determined by the DSSS procedure or initial test configuration, area scans are measured for all positions in an exposure condition. The test position with the highest extrapolated (peak) SAR is used as the initial test position. When the reported SAR of the initial test position is ≤ 0.4 W/kg, further SAR measurement is not required for the other (remaining) test positions. Otherwise, SAR is evaluated at the subsequent highest peak SAR position until the reported SAR result is ≤ 0.8 W/kg or all test positions are measured.
- 2) Justification for test configurations for WLAN per KDB Publication 248227 for 2.4GHZ WIFI single transmission chain operations, the highest measured maximum output power Channel for DSSS was selected for SAR measurement. SAR for OFDM modes (2.4GHz 802.11g/n) was not required due to the maximum allowed powers and the highest reported DSSS SAR. See Section 7.1 for more information.
- 3) Justification for test configurations for WLAN per KDB Publication 248227 for 5GHZ WIFI single transmission chain operations, the initial test configuration was selected according to the transmission mode with the highest maximum allowed power. Other transmission modes were not investigated since the highest reported SAR for initial test configuration adjusted by the ratio of maximum output powers is less than 1.2W/kg. See Section 7.1 for more information.

7.2.1 SAR MEASUREMENT RESULT

1. SAR Measurement Result of 2.4G WiFi

Test No.	Band	Channel	Test Position	Separation Distance (cm)	Ant	Ant Vendor	Shell material	Data Rate	Maximum Tune-up (dBm)	Conducted Power (dBm)	Power Drift (dB)	SAR 1g (W/kg)	SAR 10g (W/kg)	Reported 1g SAR (W/kg)
W01	802.11b	6	Back of Screen	2.5	MAIN	Speed	plastic	1	19.50	19.25	0.03	0.060	0.036	0.064
W02	802.11b	6	Back of Keyboard	0	MAIN	Speed	plastic	1	19.50	19.25	-0.12	0.295	0.148	0.312
W03	802.11b	6	Back of Keyboard	0	MAIN	Speed	metal 2	1	19.50	19.25	0.09	0.514	0.253	0.544
W04	802.11b	6	Back of Keyboard	0	MAIN	Speed	metal 1	1	19.50	19.25	-0.17	0.641	0.318	0.679
W05	802.11b	6	Back of Keyboard	0	MAIN	AMP	plastic	1	19.50	19.25	0.01	0.284	0.151	0.301
W06	802.11b	6	Back of Keyboard	0	MAIN	AMP	metal 2	1	19.50	19.25	-0.17	0.651	0.324	0.690
W07	802.11b	6	Back of Keyboard	0	MAIN	AMP	metal 1	1	19.50	19.25	0.05	0.558	0.273	0.591
W08	802.11b	6	Back of Keyboard	0	MAIN	ICT	plastic	1	19.50	19.25	-0.02	0.244	0.125	0.258
W09	802.11b	6	Back of Keyboard	0	MAIN	ICT	metal 2	1	19.50	19.25	0.08	0.595	0.297	0.630
W10	802.11b	6	Back of Keyboard	0	MAIN	ICT	metal 1	1	19.50	19.25	0	0.556	0.276	0.589
W11	802.11b	1	Back of Keyboard	0	MAIN	AMP	metal 2	1	19.50	19.11	0.11	0.623	0.318	0.682
W12	802.11b	11	Back of Keyboard	0	MAIN	AMP	metal 2	1	19.50	19.08	0.13	0.611	0.303	0.673
W14	802.11b	11	Back of Screen	2.5	AUX	Speed	plastic	1	20.00	19.96	-0.02	0.033	0.020	0.034
W15	802.11b	11	Back of Keyboard	0	AUX	Speed	plastic	1	20.00	19.96	0	0.290	0.152	0.293
W16	802.11b	11	Back of Keyboard	0	AUX	Speed	metal 2	1	20.00	19.96	0.11	0.664	0.342	0.670
W17	802.11b	11	Back of Keyboard	0	AUX	Speed	metal 1	1	20.00	19.96	-0.17	0.636	0.341	0.642
W18	802.11b	11	Back of Keyboard	0	AUX	AMP	plastic	1	20.00	19.96	0.03	0.247	0.131	0.249
W19	802.11b	11	Back of Keyboard	0	AUX	AMP	metal 2	1	20.00	19.96	0	0.682	0.340	0.688
W20	802.11b	11	Back of Keyboard	0	AUX	AMP	metal 1	1	20.00	19.96	0.05	0.621	0.319	0.627
W21	802.11b	11	Back of Keyboard	0	AUX	ICT	plastic	1	20.00	19.96	-0.13	0.401	0.211	0.405
W22	802.11b	11	Back of Keyboard	0	AUX	ICT	metal 2	1	20.00	19.96	0	0.672	0.336	0.678
W23	802.11b	11	Back of Keyboard	0	AUX	ICT	metal 1	1	20.00	19.96	0.02	0.544	0.298	0.549
W24	802.11b	6	Back of Keyboard	0	AUX	AMP	metal 2	1	20.00	19.71	-0.19	0.641	0.324	0.685
W25	802.11b	1	Back of Keyboard	0	AUX	AMP	metal 2	1	20.00	19.69	0.07	0.635	0.319	0.682

Note:

1) The value with boldface is the maximum SAR Value of each test band.

2) About the shell material:

Plastic means A&B&C&D cover plastic; Metal 1 means A cover metal and B&C&D cover plastic; Metal 2 means A&D cover metal and B&C cover plastic.

2. SAR Measurement Result of BT

Test No.	Band	Channel	Test Position	Separation Distance (cm)	Ant	Ant Vendor	Shell material	Data Rate	Maximum Tune-up (dBm)	Conducted Power (dBm)	Power Drift (dB)	SAR 1g (W/kg)	SAR 10g (W/kg)	Reported 1g SAR (W/kg)
B01	BT DH5	0	Back of Screen	2.5	AUX	Speed	plastic	-	11.50	11.32	0.17	<0.001	<0.001	<0.001
B02	BT DH5	0	Back of Keyboard	0	AUX	Speed	plastic	-	11.50	11.32	-0.08	0.019	0.008	0.020
B03	BT DH5	0	Back of Keyboard	0	AUX	Speed	metal 2	-	11.50	11.32	0.02	0.021	0.011	0.022
B04	BT DH5	0	Back of Keyboard	0	AUX	Speed	metal 1	-	11.50	11.32	0	0.064	0.031	0.066
B05	BT DH5	0	Back of Keyboard	0	AUX	AMP	plastic	-	11.50	11.32	0	<0.001	<0.001	<0.001
B06	BT DH5	0	Back of Keyboard	0	AUX	AMP	metal 2	-	11.50	11.32	0.15	0.052	0.027	0.054
B07	BT DH5	0	Back of Keyboard	0	AUX	AMP	metal 1	-	11.50	11.32	0	0.031	0.019	0.032
B08	BT DH5	0	Back of Keyboard	0	AUX	ICT	plastic	-	11.50	11.32	0.09	0.041	0.022	0.043
B09	BT DH5	0	Back of Keyboard	0	AUX	ICT	metal 2	-	11.50	11.32	0.12	0.048	0.025	0.050
B10	BT DH5	0	Back of Keyboard	0	AUX	ICT	metal 1	-	11.50	11.32	0	0.038	0.020	0.039
B11	BT DH5	39	Back of Keyboard	0	AUX	Speed	metal 1	-	11.50	11.15	0.01	0.035	0.015	0.038
B12	BT DH5	78	Back of Keyboard	0	AUX	Speed	metal 1	-	11.50	10.78	0	0.067	0.034	0.079
B14	BT BLE	0	Back of Screen	2.5	AUX	Speed	plastic	-	11.50	11.29	0.12	<0.001	<0.001	<0.001
B15	BT BLE	0	Back of Keyboard	0	AUX	Speed	plastic	-	11.50	11.29	0	0.021	0.011	0.022
B16	BT BLE	0	Back of Keyboard	0	AUX	Speed	metal 2	-	11.50	11.29	0.08	0.028	0.018	0.029
B17	BT BLE	0	Back of Keyboard	0	AUX	Speed	metal 1	-	11.50	11.29	0	0.062	0.032	0.065
B18	BT BLE	0	Back of Keyboard	0	AUX	AMP	plastic	-	11.50	11.29	0.04	<0.001	<0.001	<0.001
B19	BT BLE	0	Back of Keyboard	0	AUX	AMP	metal 2	-	11.50	11.29	0.07	0.055	0.029	0.058
B20	BT BLE	0	Back of Keyboard	0	AUX	AMP	metal 1	-	11.50	11.29	0	0.022	0.015	0.023
B21	BT BLE	0	Back of Keyboard	0	AUX	ICT	plastic	-	11.50	11.29	-0.02	0.020	0.011	0.021
B22	BT BLE	0	Back of Keyboard	0	AUX	ICT	metal 2	-	11.50	11.29	0.09	0.050	0.027	0.052
B23	BT BLE	0	Back of Keyboard	0	AUX	ICT	metal 1	-	11.50	11.29	0	0.046	0.024	0.048
B24	BT BLE	19	Back of Keyboard	0	AUX	Speed	metal 1	-	11.50	11.22	0.05	0.049	0.026	0.052
B25	BT BLE	39	Back of Keyboard	0	AUX	Speed	metal 1	-	11.50	10.72	0	0.080	0.040	0.095

Note:

1) The value with boldface is the maximum SAR Value of each test band.

2) About the shell material:

Plastic means A&B&C&D cover plastic; Metal 1 means A cover metal and B&C&D cover plastic; Metal 2 means A&D cover metal and B&C cover plastic.

3. SAR Measurement Result of 5G WiFi

Test No.	Band	Channel	Test Position	Separation Distance (cm)	Ant	Ant Vendor	Shell material	Data Rate	Maximum Tune-up (dBm)	Conducted Power (dBm)	Power Drift (dB)	SAR 1g (W/kg)	SAR 10g (W/kg)	Reported 1g SAR (W/kg)
W27	802.11a	60	Back of Screen	2.5	MAIN	Speed	plastic	6	19.00	18.93	0.15	0.129	0.057	0.131
W28	802.11a	60	Back of Keyboard	0	MAIN	Speed	plastic	6	19.00	18.93	0	1.120	0.402	1.138
W29	802.11a	60	Back of Keyboard	0	MAIN	Speed	metal 2	6	19.00	18.93	0.12	0.473	0.198	0.481
W30	802.11a	60	Back of Keyboard	0	MAIN	Speed	metal 1	6	19.00	18.93	-0.07	0.742	0.262	0.754
W31	802.11a	60	Back of Keyboard	0	MAIN	AMP	plastic	6	19.00	18.93	-0.17	0.542	0.208	0.551
W32	802.11a	60	Back of Keyboard	0	MAIN	AMP	metal 2	6	19.00	18.93	0.03	0.534	0.207	0.543
W33	802.11a	60	Back of Keyboard	0	MAIN	AMP	metal 1	6	19.00	18.93	0.11	0.690	0.255	0.701
W34	802.11a	60	Back of Keyboard	0	MAIN	ICT	plastic	6	19.00	18.93	0	0.623	0.226	0.633
W35	802.11a	60	Back of Keyboard	0	MAIN	ICT	metal 2	6	19.00	18.93	-0.09	0.369	0.142	0.375
W36	802.11a	60	Back of Keyboard	0	MAIN	ICT	metal 1	6	19.00	18.93	0.1	0.760	0.280	0.772
W37	802.11a	52	Back of Keyboard	0	MAIN	Speed	plastic	6	19.00	18.82	-0.04	0.949	0.334	0.989
W38	802.11a	64	Back of Keyboard	0	MAIN	Speed	plastic	6	16.00	15.62	-0.16	0.445	0.158	0.486
W39	802.11a	60	Back of Keyboard (Repeated)	0	MAIN	Speed	plastic	6	19.00	18.93	0.11	1.090	0.389	1.108
W40	802.11a	52	Back of Screen	2.5	AUX	Speed	plastic	6	17.50	17.39	0.15	0.113	0.049	0.116
W41	802.11a	52	Back of Keyboard	0	AUX	Speed	plastic	6	17.50	17.39	-0.09	0.759	0.312	0.778
W42	802.11a	52	Back of Keyboard	0	AUX	Speed	metal 2	6	17.50	17.39	0.02	0.401	0.122	0.411
W43	802.11a	52	Back of Keyboard	0	AUX	Speed	metal 1	6	17.50	17.39	0	0.947	0.326	0.971
W44	802.11a	52	Back of Keyboard	0	AUX	AMP	plastic	6	17.50	17.39	0.11	0.747	0.312	0.766
W45	802.11a	52	Back of Keyboard	0	AUX	AMP	metal 2	6	17.50	17.39	-0.14	0.588	0.213	0.603
W46	802.11a	52	Back of Keyboard	0	AUX	AMP	metal 1	6	17.50	17.39	0.01	0.390	0.130	0.400
W47	802.11a	52	Back of Keyboard	0	AUX	ICT	plastic	6	17.50	17.39	0.09	0.894	0.364	0.917
W48	802.11a	52	Back of Keyboard	0	AUX	ICT	metal 2	6	17.50	17.39	0.08	0.308	0.106	0.316
W49	802.11a	52	Back of Keyboard	0	AUX	ICT	metal 1	6	17.50	17.39	0.06	0.912	0.318	0.935
W50	802.11a	60	Back of Keyboard	0	AUX	Speed	metal 1	6	17.50	17.34	-0.17	0.711	0.289	0.738
W51	802.11a	64	Back of Keyboard	0	AUX	Speed	metal 1	6	16.50	16.39	-0.02	0.411	0.139	0.422
W52	802.11a	52	Back of Keyboard (Repeated)	0	AUX	Speed	metal 1	6	17.50	17.39	0.07	0.936	0.318	0.960
W53	802.11a	116	Back of Screen	2.5	MAIN	Speed	plastic	6	19.00	18.63	0.01	0.156	0.065	0.170
W54	802.11a	116	Back of Keyboard	0	MAIN	Speed	plastic	6	19.00	18.63	0	1.080	0.393	1.176
W55	802.11a	116	Back of Keyboard	0	MAIN	Speed	metal 2	6	19.00	18.63	-0.08	0.442	0.187	0.481
W56	802.11a	116	Back of Keyboard	0	MAIN	Speed	metal 1	6	19.00	18.63	-0.19	0.637	0.236	0.694
W57	802.11a	116	Back of Keyboard	0	MAIN	AMP	plastic	6	19.00	18.63	0.05	0.468	0.179	0.510
W58	802.11a	116	Back of Keyboard	0	MAIN	AMP	metal 2	6	19.00	18.63	0.13	0.478	0.197	0.521
W59	802.11a	116	Back of Keyboard	0	MAIN	AMP	metal 1	6	19.00	18.63	-0.04	0.758	0.286	0.825
W60	802.11a	116	Back of Keyboard	0	MAIN	ICT	plastic	6	19.00	18.63	0	0.678	0.247	0.738
W61	802.11a	116	Back of Keyboard	0	MAIN	ICT	metal 2	6	19.00	18.63	-0.09	0.333	0.133	0.363
W62	802.11a	116	Back of Keyboard	0	MAIN	ICT	metal 1	6	19.00	18.63	0.1	0.874	0.329	0.952
W63	802.11a	140	Back of Keyboard	0	MAIN	Speed	plastic	6	18.00	17.92	0.02	0.827	0.292	0.842
W64	802.11a	100	Back of Keyboard	0	MAIN	Speed	plastic	6	17.50	17.08	-0.06	0.580	0.208	0.639
W65	802.11a	116	Back of Keyboard (Repeated)	0	MAIN	Speed	plastic	6	19.00	18.63	0.19	1.030	0.378	1.122

Test No.	Band	Channel	Test Position	Separation Distance (cm)	Ant	Ant Vendor	Shell material	Data Rate	Maximum Tune-up (dBm)	Conducted Power (dBm)	Power Drift (dB)	SAR 1g (W/kg)	SAR 10g (W/kg)	Reported 1g SAR (W/kg)
W66	802.11a	116	Back of Screen	2.5	AUX	Speed	plastic	6	19.00	18.62	0.12	0.130	0.059	0.142
W67	802.11a	116	Back of Keyboard	0	AUX	Speed	plastic	6	19.00	18.62	0	0.751	0.295	0.820
W68	802.11a	116	Back of Keyboard	0	AUX	Speed	metal 2	6	19.00	18.62	-0.05	0.162	0.055	0.177
W69	802.11a	116	Back of Keyboard	0	AUX	Speed	metal 1	6	19.00	18.62	-0.05	0.830	0.299	0.906
W70	802.11a	116	Back of Keyboard	0	AUX	AMP	plastic	6	19.00	18.62	0.1	0.732	0.291	0.799
W71	802.11a	116	Back of Keyboard	0	AUX	AMP	metal 2	6	19.00	18.62	0.03	0.690	0.254	0.753
W72	802.11a	116	Back of Keyboard	0	AUX	AMP	metal 1	6	19.00	18.62	0.19	0.204	0.074	0.223
W73	802.11a	116	Back of Keyboard	0	AUX	ICT	plastic	6	19.00	18.62	0	1.010	0.406	1.102
W74	802.11a	116	Back of Keyboard	0	AUX	ICT	metal 2	6	19.00	18.62	0.11	0.365	0.127	0.398
W75	802.11a	116	Back of Keyboard	0	AUX	ICT	metal 1	6	19.00	18.62	-0.06	0.978	0.376	1.067
W76	802.11a	140	Back of Keyboard	0	AUX	ICT	plastic	6	18.00	17.51	0.08	0.869	0.317	0.973
W77	802.11a	100	Back of Keyboard	0	AUX	ICT	plastic	6	17.00	16.65	-0.13	0.827	0.299	0.896
W78	802.11a	116	Back of Keyboard (Repeated)	0	AUX	ICT	plastic	6	19.00	18.62	0.02	0.995	0.394	1.086
W79	802.11a	157	Back of Screen	2.5	MAIN	Speed	plastic	6	19.00	18.69	0.1	0.183	0.074	0.197
W80	802.11a	157	Back of Keyboard	0	MAIN	Speed	plastic	6	19.00	18.69	0.09	1.040	0.377	1.117
W81	802.11a	157	Back of Keyboard	0	MAIN	Speed	metal 2	6	19.00	18.69	-0.05	0.309	0.109	0.332
W82	802.11a	157	Back of Keyboard	0	MAIN	Speed	metal 1	6	19.00	18.69	-0.03	0.426	0.167	0.458
W83	802.11a	157	Back of Keyboard	0	MAIN	AMP	plastic	6	19.00	18.69	0.18	0.674	0.251	0.724
W84	802.11a	157	Back of Keyboard	0	MAIN	AMP	metal 2	6	19.00	18.69	-0.01	0.239	0.087	0.257
W85	802.11a	157	Back of Keyboard	0	MAIN	AMP	metal 1	6	19.00	18.69	0.04	0.653	0.212	0.701
W86	802.11a	157	Back of Keyboard	0	MAIN	ICT	plastic	6	19.00	18.69	0	0.681	0.247	0.731
W87	802.11a	157	Back of Keyboard	0	MAIN	ICT	metal 2	6	19.00	18.69	0.12	0.254	0.081	0.273
W88	802.11a	157	Back of Keyboard	0	MAIN	ICT	metal 1	6	19.00	18.69	-0.19	0.547	0.209	0.587
W89	802.11a	165	Back of Keyboard	0	MAIN	Speed	plastic	6	19.00	18.50	0.16	0.871	0.324	0.977
W90	802.11a	149	Back of Keyboard	0	MAIN	Speed	plastic	6	19.00	18.53	0.02	0.990	0.351	1.103
W91	802.11a	157	Back of Keyboard (Repeated)	0	MAIN	Speed	plastic	6	19.00	18.69	0.14	1.020	0.371	1.095
W92	802.11a	149	Back of Screen	2.5	AUX	Speed	plastic	6	19.00	18.41	0.07	0.202	0.091	0.231
W93	802.11a	149	Back of Keyboard	0	AUX	Speed	plastic	6	19.00	18.41	0	0.936	0.322	1.072
W94	802.11a	149	Back of Keyboard	0	AUX	Speed	metal 2	6	19.00	18.41	-0.15	0.276	0.095	0.316
W95	802.11a	149	Back of Keyboard	0	AUX	Speed	metal 1	6	19.00	18.41	-0.03	0.777	0.274	0.890
W96	802.11a	149	Back of Keyboard	0	AUX	AMP	plastic	6	19.00	18.41		0.985	0.403	1.128
W97	802.11a	149	Back of Keyboard	0	AUX	AMP	metal 2	6	19.00	18.41	0.12	0.522	0.208	0.598
W98	802.11a	149	Back of Keyboard	0	AUX	AMP	metal 1	6	19.00	18.41	-0.06	0.642	0.224	0.735
W99	802.11a	149	Back of Keyboard	0	AUX	ICT	plastic	6	19.00	18.41	0.09	1.030	0.417	1.180
W100	802.11a	149	Back of Keyboard	0	AUX	ICT	metal 2	6	19.00	18.41	0.1	0.233	0.082	0.267
W101	802.11a	149	Back of Keyboard	0	AUX	ICT	metal 1	6	19.00	18.41	-0.03	0.646	0.240	0.740
W102	802.11a	157	Back of Keyboard	0	AUX	ICT	plastic	6	19.00	18.05	0.1	0.633	0.217	0.788
W103	802.11a	165	Back of Keyboard	0	AUX	ICT	plastic	6	19.00	18.28	-0.05	0.475	0.156	0.561
W104	802.11a	149	Back of Keyboard (Repeated)	0	AUX	ICT	plastic	6	19.00	18.41	0.07	0.989	0.375	1.133

Test No.	Band	Channel	Test Position	Separation Distance (cm)	Ant	Ant Vendor	Shell material	Data Rate	Maximum Tune-up (dBm)	Conducted Power (dBm)	Power Drift (dB)	SAR 1g (W/kg)	SAR 10g (W/kg)	Reported 1g SAR (W/kg)
W105	802.11a	52	Back of Screen	2.5	MAIN+AUX	Speed	plastic	6	22.00	21.39	0.1	0.090	0.031	0.104
W106	802.11a	52	Back of Keyboard	0	MAIN+AUX	Speed	plastic	6	22.00	21.39	0.01	1.010	0.365	1.162
W107	802.11a	52	Back of Keyboard	0	MAIN+AUX	Speed	metal 2	6	22.00	21.39	-0.13	0.391	0.151	0.450
W108	802.11a	52	Back of Keyboard	0	MAIN+AUX	Speed	metal 1	6	22.00	21.39	0.05	0.990	0.351	1.139
W109	802.11a	52	Back of Keyboard	0	MAIN+AUX	AMP	plastic	6	22.00	21.39	0.02	0.515	0.222	0.593
W110	802.11a	52	Back of Keyboard	0	MAIN+AUX	AMP	metal 2	6	22.00	21.39	0.08	0.668	0.267	0.769
W111	802.11a	52	Back of Keyboard	0	MAIN+AUX	AMP	metal 1	6	22.00	21.39	-0.11	0.711	0.253	0.818
W112	802.11a	52	Back of Keyboard	0	MAIN+AUX	ICT	plastic	6	22.00	21.39	0	0.590	0.243	0.679
W113	802.11a	52	Back of Keyboard	0	MAIN+AUX	ICT	metal 2	6	22.00	21.39	0.02	0.375	0.138	0.432
W114	802.11a	52	Back of Keyboard	0	MAIN+AUX	ICT	metal 1	6	22.00	21.39	0.08	0.708	0.250	0.815
W115	802.11a	60	Back of Keyboard	0	MAIN+AUX	Speed	plastic	6	22.00	21.63	-0.17	0.811	0.295	0.883
W116	802.11a	64	Back of Keyboard	0	MAIN+AUX	Speed	plastic	6	19.00	18.05	0.02	0.688	0.255	0.856
W117	802.11a	52	Back of Keyboard (Repeated)	0	MAIN+AUX	Speed	plastic	6	22.00	21.39	0.18	0.997	0.358	1.147
W118	802.11a	116	Back of Screen	2.5	MAIN+AUX	Speed	plastic	6	22.00	21.60	-0.11	0.100	0.038	0.110
W119	802.11a	116	Back of Keyboard	0	MAIN+AUX	Speed	plastic	6	22.00	21.60	0	0.974	0.353	1.068
W120	802.11a	116	Back of Keyboard	0	MAIN+AUX	Speed	metal 2	6	22.00	21.60	-0.02	0.412	0.196	0.452
W121	802.11a	116	Back of Keyboard	0	MAIN+AUX	Speed	metal 1	6	22.00	21.60	0.01	0.608	0.256	0.667
W122	802.11a	116	Back of Keyboard	0	MAIN+AUX	AMP	plastic	6	22.00	21.60	-0.03	0.556	0.253	0.610
W123	802.11a	116	Back of Keyboard	0	MAIN+AUX	AMP	metal 2	6	22.00	21.60	0.13	0.575	0.252	0.630
W124	802.11a	116	Back of Keyboard	0	MAIN+AUX	AMP	metal 1	6	22.00	21.60	0.05	0.576	0.248	0.632
W125	802.11a	116	Back of Keyboard	0	MAIN+AUX	ICT	plastic	6	22.00	21.60	0	0.576	0.240	0.632
W126	802.11a	116	Back of Keyboard	0	MAIN+AUX	ICT	metal 2	6	22.00	21.60	0.02	0.457	0.210	0.501
W127	802.11a	116	Back of Keyboard	0	MAIN+AUX	ICT	metal 1	6	22.00	21.60	0.01	0.669	0.296	0.734
W128	802.11a	140	Back of Keyboard	0	MAIN+AUX	Speed	plastic	6	20.50	20.43	0	0.597	0.222	0.607
W129	802.11a	100	Back of Keyboard	0	MAIN+AUX	Speed	plastic	6	19.50	19.36	0.08	0.626	0.273	0.647
W130	802.11a	116	Back of Keyboard (Repeated)	0	MAIN+AUX	Speed	plastic	6	22.00	21.60	0.04	0.956	0.323	1.048
W131	802.11a	149	Back of Screen	2.5	MAIN+AUX	Speed	plastic	6	22.50	21.81	-0.15	0.106	0.047	0.124
W132	802.11a	149	Back of Keyboard	0	MAIN+AUX	Speed	plastic	6	22.50	21.81	0	0.963	0.372	1.129
W133	802.11a	149	Back of Keyboard	0	MAIN+AUX	Speed	metal 2	6	22.50	21.81	-0.1	0.407	0.188	0.477
W134	802.11a	149	Back of Keyboard	0	MAIN+AUX	Speed	metal 1	6	22.50	21.81	0.11	0.779	0.313	0.913
W135	802.11a	149	Back of Keyboard	0	MAIN+AUX	AMP	plastic	6	22.50	21.81	0.05	0.846	0.366	0.992
W136	802.11a	149	Back of Keyboard	0	MAIN+AUX	AMP	metal 2	6	22.50	21.81	0.17	0.643	0.285	0.754
W137	802.11a	149	Back of Keyboard	0	MAIN+AUX	AMP	metal 1	6	22.50	21.81	0.07	0.774	0.323	0.907
W138	802.11a	149	Back of Keyboard	0	MAIN+AUX	ICT	plastic	6	22.50	21.81	0	1.010	0.420	1.184
W139	802.11a	149	Back of Keyboard	0	MAIN+AUX	ICT	metal 2	6	22.50	21.81	-0.05	0.444	0.196	0.520
W140	802.11a	149	Back of Keyboard	0	MAIN+AUX	ICT	metal 1	6	22.50	21.81	0.08	0.631	0.283	0.740
W141	802.11a	165	Back of Keyboard	0	MAIN+AUX	ICT	plastic	6	22.50	21.66	0	0.935	0.390	1.135
W142	802.11a	157	Back of Keyboard	0	MAIN+AUX	ICT	plastic	6	22.50	21.80	-0.01	1.020	0.423	1.198
W143	802.11a	157	Back of Keyboard (Repeated)	0	MAIN+AUX	ICT	plastic	6	22.50	21.80	0.15	0.981	0.403	1.153

Note:

1) The value with boldface is the maximum SAR Value of each test band.

2) About the shell material:

Plastic means A&B&C&D cover plastic; Metal 1 means A cover metal and B&C&D cover plastic; Metal 2 means A&D cover metal and B&C cover plastic.

7.3 MULTIPLE TRANSMITTER EVALUATION

The following tables list information which is relevant for the decision if a simultaneous transmit evaluation is necessary according to FCC KDB 447498D01 General RF Exposure Guidance v06.

The location of the antennas inside the EUT is shown as below picture:

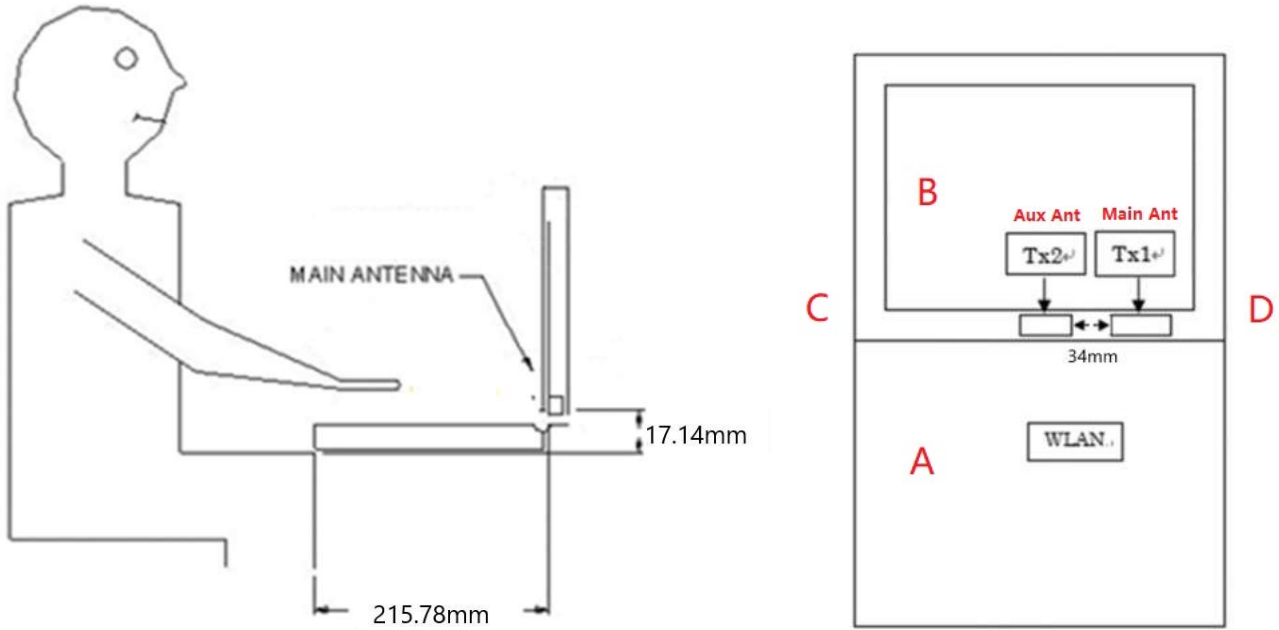

7.3.1 STAND-ALONE SAR TEST EXCLUSION

Per FCC KDB 447498D01, SAR compliance for simultaneous transmission must be considered when the maximum duration of overlapping transmissions, including network hand-offs, is greater than 30 seconds. This device contains multiple transmitters that may operate simultaneously, and therefore requires a simultaneous transmission analysis.

The Simultaneous Transmission Possibilities of this device are as below:

No.	Configuration	Body
1	WLAN 2.4GHz Main Ant + WLAN 2.4GHz Aux Ant	Yes
2	WLAN 5GHz Main Ant + WLAN 5GHz Aux Ant	Yes
3	BT Aux Ant + WLAN 2.4GHz Main Ant	Yes
4	BT Aux Ant + WLAN 5GHz Main Ant	Yes

Note: Only the Aux Ant supports BT function.

7.3.2 SIMULTANEOUS TRANSMISSION CONDITIONS

About WIFI and Bluetooth transmit simultaneously

Band	Position	Back of Screen	Back of Keyboard
	Main Ant	2.4G WLAN	0.064
5.2G WLAN		/	/
5.3G WLAN		0.131	1.138
5.6G WLAN		0.170	1.176
5.8G WLAN		0.197	1.117
Aux Ant	2.4G WLAN	0.034	0.688
	5.2G WLAN	/	/
	5.3G WLAN	0.116	0.971
	5.6G WLAN	0.142	1.102
	5.8G WLAN	0.231	1.180
	Bluetooth	<0.001	0.095
MAX \sum SAR _{1g}		0.428	1.378

Note:

- 1) MAX. \sum SAR_{1g}<1.6 W/Kg, the MIMO test data of WLAN 5.3G, WLAN 5.6G and WLAN 5.8G please refer to section 7.2.1.
- 2) The highest simultaneous SAR value=1.378W/Kg, per KDB690783 D01.

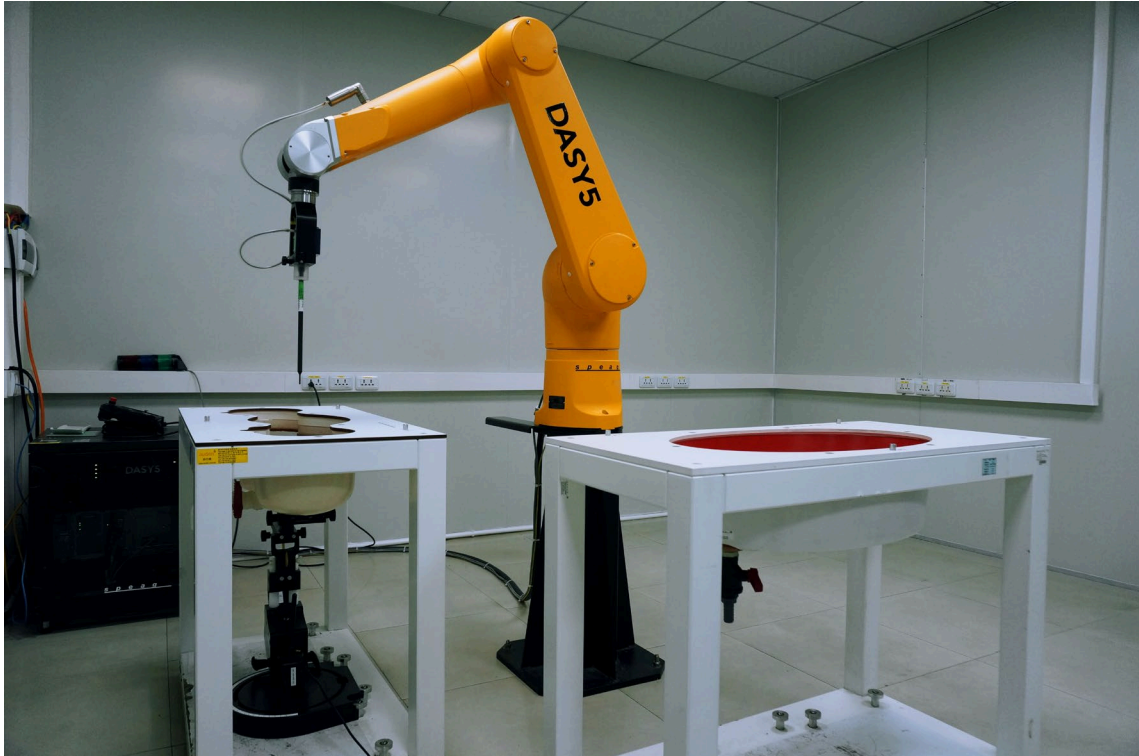
APPENDIX**1. TEST LAYOUT****Specific Absorption Rate Test Layout****Liquid depth in the flat Phantom ($\geq 15\text{cm}$ depth)**

HSL_2300MHz-2700MHz_15.3cm

HSL_5GHz_15.7cm

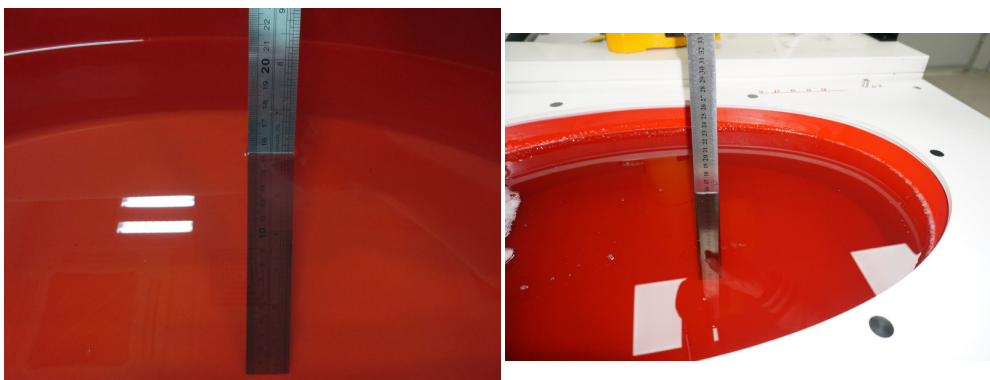

Appendix A. SAR Plots of System Verification

(Pls See BTL-FCC SAR-1-1912H005B_WLAN Module_abgn for MT7921_Appendix A.)

Appendix B. SAR Plots of SAR Measurement

(Pls See BTL-FCC SAR-1-1912H005B_WLAN Module_abgn for MT7921_Appendix B.)

Appendix C. Calibration Certificate

(Pls See BTL-FCC SAR-1-1912H005B_WLAN Module_abgn for MT7921_Appendix C.)

Appendix D. Photographs of the Test Set-Up

(Pls See BTL-FCC SAR-1-1912H005B_WLAN Module_abgn for MT7921_Appendix D.)

End of Test Report