

Measurement of Maximum Permissible Exposure

1. Foreword

In adopt with the Human Exposure IEEE C95.1, and according to the FCC 1.1310. The *Maximum Permissible Exposure (MPE)* is obligated to measure in order to prove the safety of radiation harmfulness to the human body.

The *Gain* of the antenna used is measured in an *Anechoic chamber*. The *maximum total power to the antenna* is to be recorded. By adopting the *Friis Transmission Formula* and the *power gain of the antenna*, we can find the distance right away from the product, where the limit of the MPE is.

2. Description of EUT

FCC ID	:	RAFXWL-11GCAR
Product name	:	X-Micro WLAN 11g PCI Card (108Mbps)
Model name	:	XWL-11GCAR
Classification	:	Mobile Device (i) Under normal use condition, the antenna is at least 20cm away from the user; (ii) Warning statement for keeping 20cm separation distance and the prohibition of operating next to the person has been printed in the user's manual
Frequency Range	:	2.412 GHz ~ 2.462GHz
Supported Channel	:	11 Channels
Modulation Skill	:	DBPSK, DQPSK, CCK, OFDM
Power Type	:	Powered by PCI of client's device

3. Limits for Maximum Permissible Exposure (MPE)

Frequency Range (MHz)	Electric Field Strength (V/m)	Magnetic Field Strength (H) (A/m)	Power Density (S) (mW/cm ²)	Averaging Time E ² , H ² or S (minutes)
(A) Limits for Occupational/Controlled Exposure				
0.3-3.0	614	1.63	100	6
3.0-30	1842/f	4.89/f	900/f ²	6
30-300	61.4	0.163	1.0	6
300-1500	--	--	f/300	6
1500-100,000	--	--	5	6
(B) Limits for General Population/Uncontrolled Exposure				
0.3-1.34	614	1.63	100	30
1.34-30	824/f	2.19/f	180/f ²	30
30-300	27.5	0.073	0.2	30
300-1500	--	--	f/1500	30
1500-100,000	--	--	1.0	30

[The EUT is tested in transmit and receive modes and in the first, middle and the last channel separately. The following shows only our observation have the greatest emissions.]

According to OET BULLETIN 56 Fourth Edition/August 1999, Equation for Predicting RF Fields:

$$\text{Friis Transmission Formula: } S = \frac{PG}{4\pi R^2} = \frac{220.29 \times 1.514}{4\pi(20)^2} = 0.066mW / cm^2$$

$$\text{Estimated safe separation: } R = \sqrt{\frac{PG}{4\pi}} = \sqrt{\frac{220.29 \times 1.514}{4\pi}} = 5.152cm$$

Remarks: "The safe estimated separation that the user must maintain from the antenna is at least 5.152 cm."

Where: S = power density (in appropriate units, e.g. mW/cm²)

P = power input to the antenna (in appropriate units, e.g., mW)

G = power gain of the antenna in the direction of interest relative to an isotropic radiator

R = distance to the center of radiation of the antenna (appropriate units, e.g., cm)

The Numeric gain G of antenna with a gain specified in dB is determined by:

$$G = \text{Log}^{-1} (dB \text{ antenna gain} / 10)$$

$$G = \text{Log}^{-1} (1.80 / 10) = 1.51356$$

Appendix

Antenna Specification

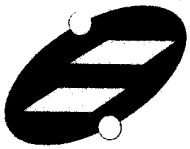

WHA YU INDUSTRIAL CO., LTD. (HEAD OFFICE)

TAI HWA ELECTRONIC CO., LTD.(CHINA)

SHANGHAI HUA YU ELECTRONIC CO., LTD.(CHINA)

SPECIFICATION FOR APPROVAL

CUSTOMER: 友勁科技股份有限公司

PART NAME: 2.4G RF Antenna Assembly

PART NO: 11723B02*317*00

W. Y. P/NO.: C056-510131-A

REV.: X1

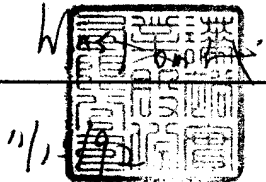
	MANUFACTURER SIGNATURE	CUSTOMER SIGNATURE
APPROVED BY :		
DATE :		

WHA YU GROUP

WHA YU INDUSTRIAL CO., LTD.(HEAD OFFICE)

譚裕實業股份有限公司

Tel:+886-3-5714225(REP.)

Fax:+ 886-3-5713853 · + 886-3-5723600

TAI HWA ELECTRONIC CO., LTD. (CHINA)

台樺電業製品廠

Address: Pak Ho District, Hiu Street Town,

Dong Guan City, Guangdong, China

Tel: + 86-769-5599375 · + 86-769-5912375

Fax: + 86-769-5599376

SHANGHAI HUA YU ELECTRONIC CO., LTD. (CHINA)

上海譚裕電子有限公司

Address: Lian Ho Village Bai Ho Town, Qing

Pu Country Shanghai, China

Tel: + 86-21-59741348 · + 86-21-59743624

Fax: + 86-21-59741347

INDEX

<i>Item</i>	<i>Content</i>	<i>Page</i>
1.	天線規格表 1
2.	成品圖 2
3.	測試報告 3~5
4.	Cable 規格 6~10
5.	天線桿套材質特性 11~17
6.	天線固定座材質特性 18
7.	膠水特性及黏著力 19~23

RF Antenna Cable Assembly

Specification

1. Electrical Properties :

- 1.1 Frequency Rang..... 2.4GHz ~ 2.5GHz
- 1.2 Impedance 50Ω Nominal
- 1.3 VSWR 1.92 Max.
- 1.4 Return Loss..... -10dB Maximum
- 1.5 Electrical Wave..... $1/2 \lambda$ Diople
- 1.6 Gain..... 1.8 dBi
- 1.7 Admitted Power..... 1W

2. Physical Properties :

- 2.1 Cable..... RG-178 Cable
- 2.2 Antenna Cover..... TPE
- 2.3 Antenna Base..... PC
- 2.4 Operating Temp. -20°C ~ +65°C
- 2.5 Storage Temp. -30°C ~ +75°C
- 2.6 Color Black
- 2.7 Connector..... SMA Plug Reverse

REV	DATE	DESCRIPTION
XI	11/17-2003	New Issue

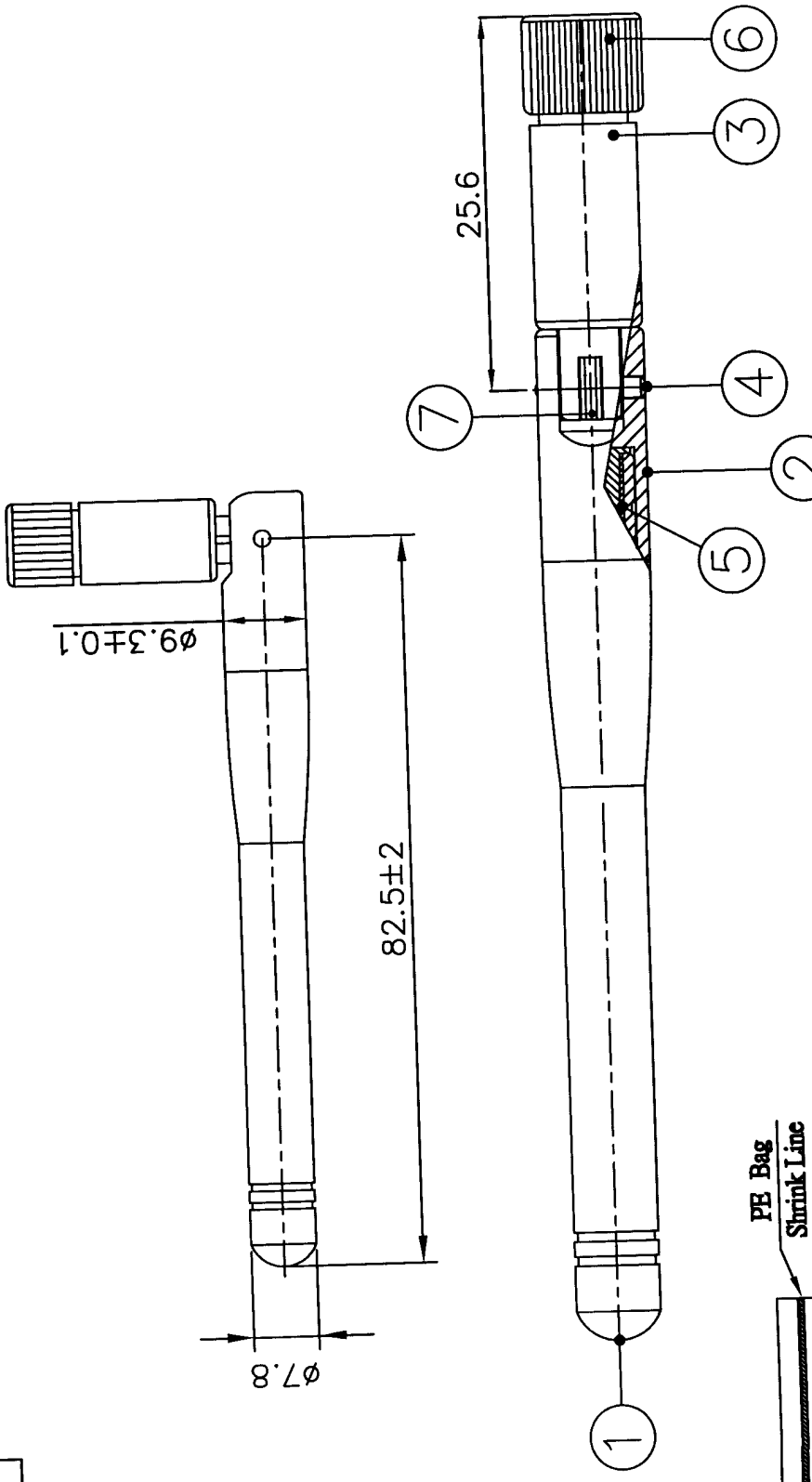

NO	DESCRIPTION	QTY	REMARK
7	Cable RG-178, Translucent Brown; 50 Ω	1	
6	Connector SMA Straight Plug/Reverse	1	
5	Ground Tube Brass, Ni plated	1	
4	Rivet Brass, Cr Plated (Black)	2	
3	Antenna Base PC; Color: Black	1	
2	Antenna Base PC; Color: Black	1	
1	Antenna Cover TPE; Color: Black	1	

Wha Yu INDUSTRIAL CO., LTD.
譚裕實業股份有限公司
THIS DRAWING, AND ITS INHERENT DESIGN CONCEPTS, ARE THE PROPERTY OF WHA YU AND AS SUCH MAY NOT BE COPIED, REPRODUCED, OR GIVEN TO THIRD PARTIES WITHOUT THE WRITTEN CONSENT OF WHA YU.

CUSTOMER:	友邦科技股份有限公司	
PART NO :	11723B02*317*00	
PARTNAME:	RF Antenna Assembly	
W.Y PNO :	C056-510131-A	
REV	UNIT	FILE :
XI	m/m	SHEET: 1/1

APPROVED	XX ±3.0	XX ±2.0	XX ±1.0	XX ±0.5	XXX ±0.1
<i>Win-Yon</i>					
CHECKED					
DRAWING					
<i>Saw</i>					

CUSTOMER'S SIGNATURE

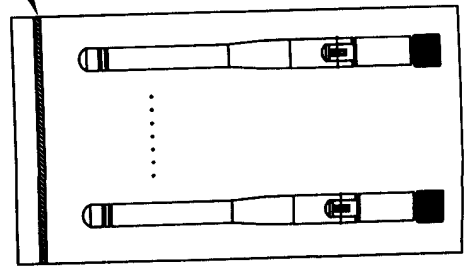

Packing : 25 pcs/bag

1 Active Ch/Trace 2 Response 3 Stimulus 4 Mkr/Analysis 5 Instr State

Tr1 S22 Log Mag 10.00dB/ Ref 0.000dB [F2]

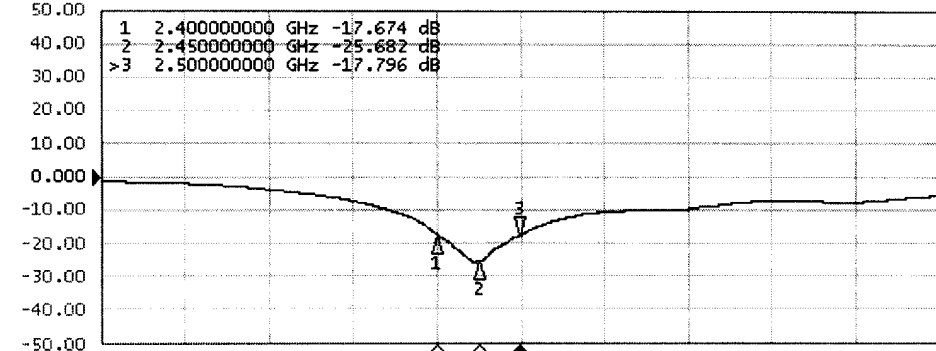

Tr2 S22 Smith (R+jX) Scale 1.000U [F2]

Point	Frequency (GHz)	Real (R)	Imaginary (jX)
1	2.400000000	38.966	3.7038
2	2.450000000	53.254	4.2754
3	2.500000000	62.599	7.2618

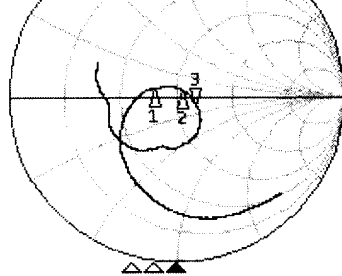

Tr3 S22 SWR 1.000/ Ref 1.000 [F2]

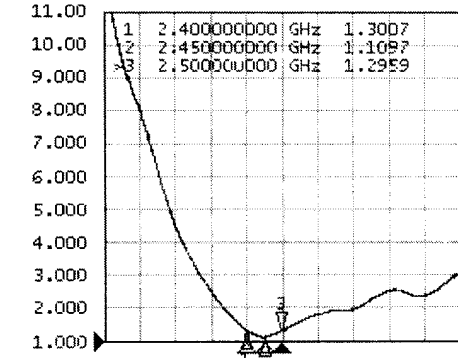

1 Start 2 GHz IFBW 70 kHz Stop 3 GHz

System

Abort Printing

Printer Setup

Invert Image ON

Dump Screen Image

E5091A Setup

Misc Setup

Backlight ON

Firmware Revision

20.03 17/10/57

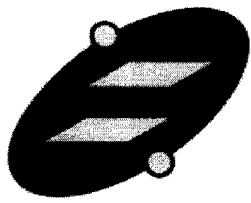

譚裕實業股份有限公司

WHA YU INDUSTRIAL CO., LTD

Far-field amplitude of 2.4GHz small dipole antenna-E-plane.nsi

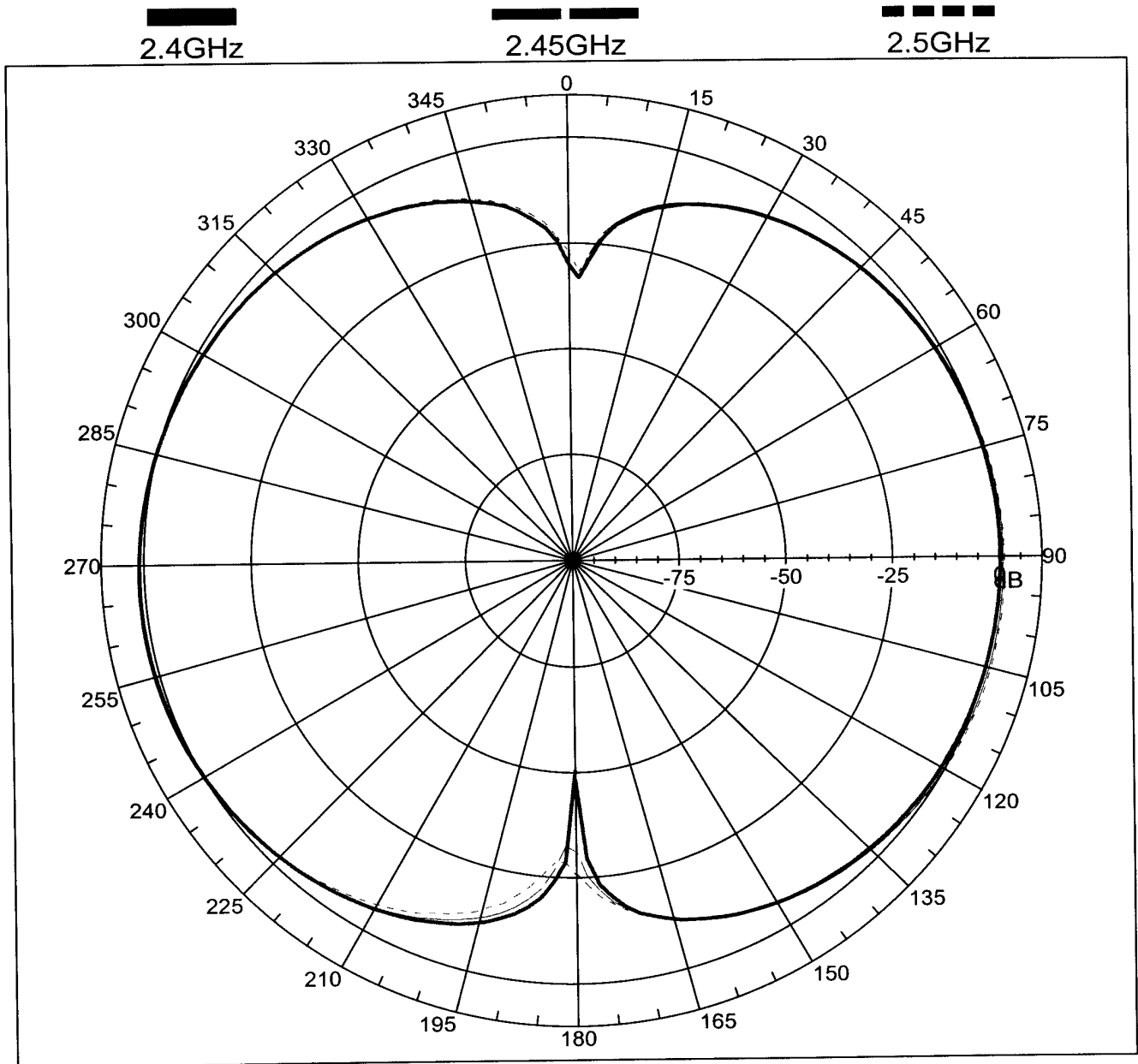

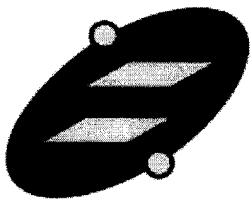

華裕實業股份有限公司

WHA YU INDUSTRIAL CO., LTD

Far-field amplitude of 2.4GHz small dipole antenna-H-plane.nsi

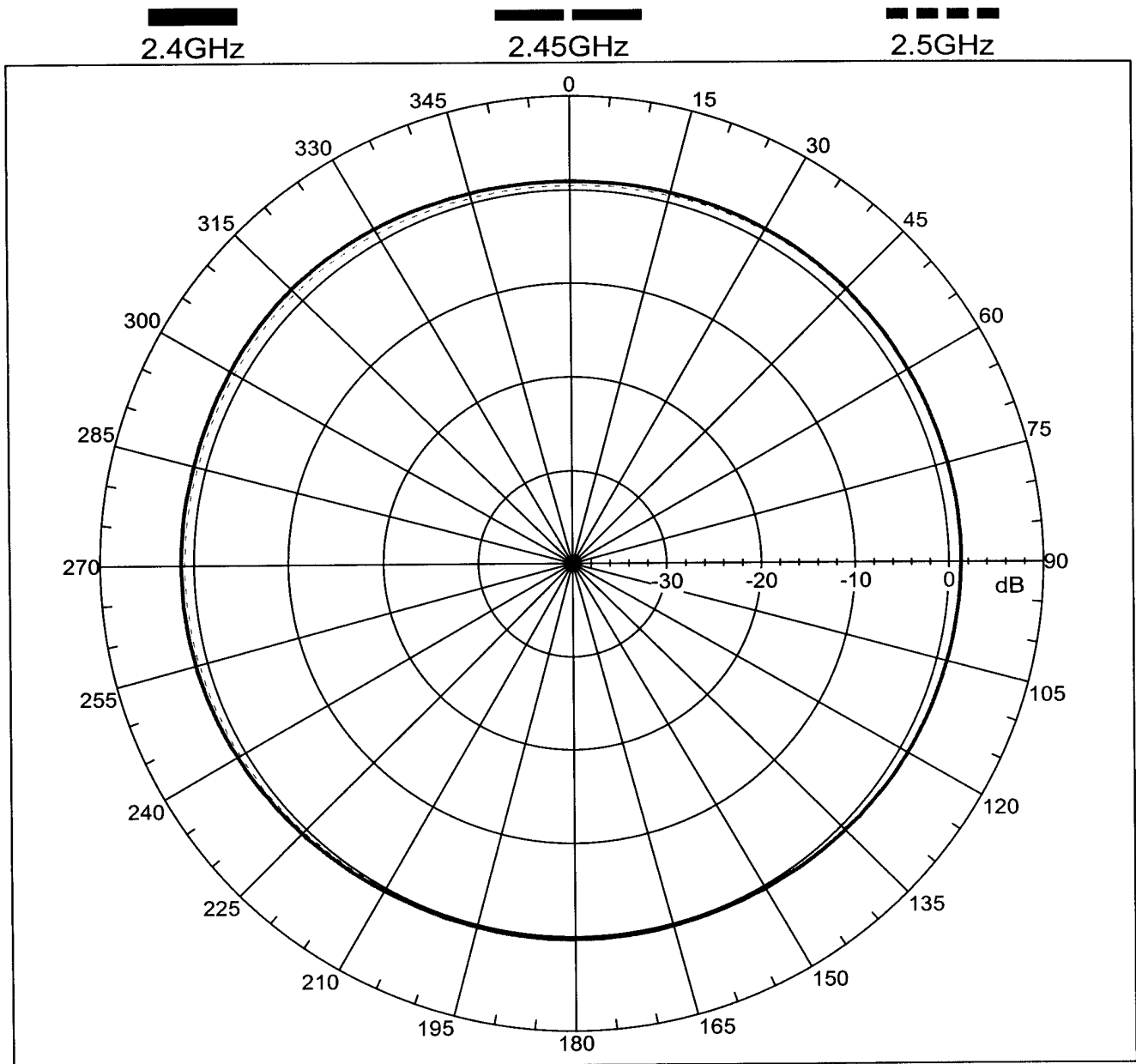

RG 178 B/U	FEP INSULATED HIGH-FREQUENCY COAXIAL CABLE	PAGE	1 / 2
PRODUCT STANDARD		ISSUED	16. Oct. 2003
		REVISED	

I - Scope

This specification presents a FEP insulated high-frequency coaxial cable AWG 30, 1.8 mm O.D. for internal wiring of electronic equipment, such as Computer / Notebook with wireless communication systems.

II - Construction

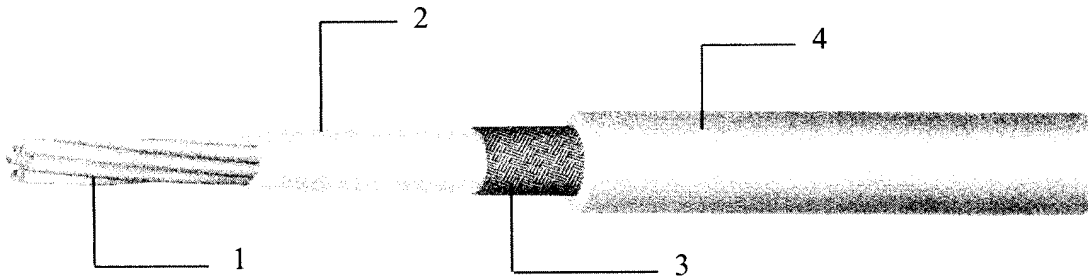

Item		Unit	Details
1. Inner Conductor	Material	—	CP-AG
	Composition	No./mm	AWG 30 or 7 ×0.1
	Dia. (approx.)	mm	0.305
2. Dielectric	Material	—	Extruded FEP
	Nom. O.D.	mm	0.84 ± 0.05
	Color	—	Natural
3. Outer Conductor	Material	—	Silver coated copper
	Composition	—	Braided (16 / 3 / 0.1)
	Dia. (approx)	mm	1.29 ±0.01
4. Jacket	Material	—	Extruded FEP
	Dia.	mm	1.80 ±0.1
	Color	—	Standard color is Light Orange

Note :	MADE BY	
	APPROVALS	



WHA YU INDUSTRIAL CO., LTD.
NO. 88-3, SHUI LI ROAD, HSIN CHU CITY, TAIWAN 300
TEL: 886-3-5714225 FAX: 886-3-5713853
<http://www.whayu.com.tw>

QUOTATION

TO: Archtech Electronics Corporation NO.: 20031105
ATTN.: Mr. Paul Foung DATE: 05 Nov.,03
TEL: 732-432-5188 FROM: Rebecca Wu
FAX: 732-432-5189 E-MAIL: rebecca@whayu.com.tw

ITEM / PART NO.	QTY (PCS)	DESCRIPTION	Unit Price (USD)	Amount (USD)
		SC/SC MM DUP 3.0*2 62.5/125PVC 1M	\$4.620	
		SC/SC MM DUP 3.0*2 62.5/125PVC 2M	\$5.080	
		SC/SC MM DUP 3.0*2 62.5/125PVC 3M	\$5.550	
		SC/SC MM DUP 3.0*2 62.5/125PVC 4M	\$6.020	
		SC/SC MM DUP 3.0*2 62.5/125PVC 5M	\$6.490	
		SC/SC MM DUP 3.0*2 62.5/125PVC 6M	\$6.950	
		SC/SC MM DUP 3.0*2 62.5/125PVC 7M	\$7.420	
		SC/SC MM DUP 3.0*2 62.5/125PVC 8M	\$7.890	
		SC/SC MM DUP 3.0*2 62.5/125PVC 9M	\$8.350	
		SC/SC MM DUP 3.0*2 62.5/125PVC 10M	\$8.880	

REMARK:

1. Price Term: FOB Shanghai
2. Lead time: 1-2 Weeks
3. Payment Term: T/T Net 30 days
4. Shipment: BY UPS Expedited ,Account No. 74W-6A3
5. The per shipment total weight is under 145KGS
6. Packing :

Sales Rep.: Rebecca Wu

Approval : Ken Chen

Cable Specification

Cable : Mil-C-17 Coaxial Cable RG-178

1. Construction :

- 1 Conductor..... 30AWG 7/38 SCCS
- 2 Dielectric..... PTFE OD : 0.033"±0.002"
- 3 Shielded.....38AWG SPC OD : 0.051" Nominal
- 4 Jacket.....FEP OD : 0.071"±0.004"

2. Physical Properties :

- 1 Weight per 1000ft..... 6.3 lbs Maximum
- 2 Bend Radius.....0.35" Minimum
- 3 Operating Temperature Range -55°C ~ 200°C

3. Electrical Properties:

- 1 Impedance..... 50±2 ohms
- 2 Capacitance..... 32 pF/ft Maximum
- 3 Cut off Frequency..... 116 GHz
- 4 Attenuation.....45.0 dB/100ft @ 1GHz
64.4 dB/100ft @ 2GHz
79.7 dB/100ft @ 3GHz
92.7 dB/100ft @ 4GHz
104.3 dB/100ft @ 5GHz
115.0 dB/100ft @ 6GHz

Mil-C-17 Coaxial Cable QPL Approved

Single braid



Double braid

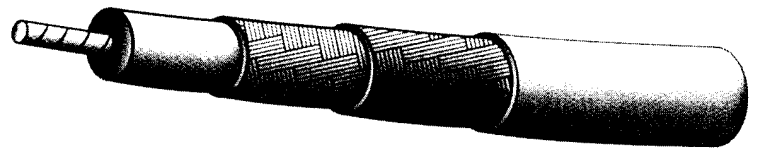

Triax

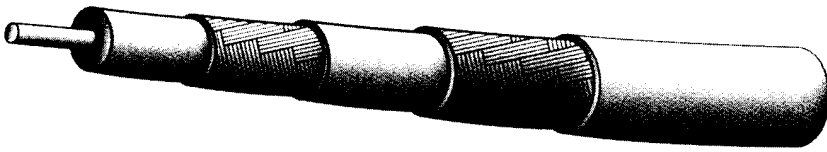

Twinax

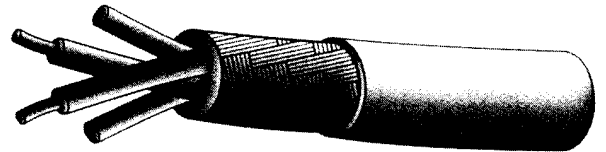

Harbour supplies a complete line of high temperature, high performance QPL approved MIL-C-17 coax cables for the military, commercial and industrial applications. The specific M17 constructions referenced are manufactured in accordance with the most recent revision of the MIL-C-17 specification. The MIL-C-17 specification defines complete physical and electrical characteristics for each M17 part number, including dimensional parameters, dielectric materials, shield construction, maximum attenuation, and VSWR levels.

VSWR Sweep Testing

When selecting a 50 ohm coaxial cable, constructions with VSWR requirements are recommended. Manufacturing and sweep testing cables with concern for VSWR ensures a quality cable free of spikes over the referenced frequency range. (Note the test frequencies specified in the electrical characteristics section.)

Precision PTFE Dielectrics

All of the high temperature, high performance coax cables listed have PTFE dielectrics with high dielectric strength and low capacitance in proportion to the dielectric constant. All PTFE dielectrics are manufactured with tolerances tighter than the MIL-C-17 specification to ensure uniformity of electrical characteristics, especially impedance, attenuation and VSWR.

Tape wrapped PTFE Constructions

Harbour also manufactures PTFE tape wrapped cables to a previous revision of the MIL-C-17 specification. These constructions can withstand operating temperatures up to 250° C. versus 200° C. for FEP jacketed cables. Also, PTFE tape wrapped cables are generally more flexible than their FEP jacketed counterparts.

UL Approvals

All of Harbour's M17 part numbers manufactured to the MIL-C-17 specification may be ordered with UL and FT4 approvals.

Mil-C-17 Coaxial Cables

Physical Characteristics:

M17 Number	Center Conductor	PTFE Dielectric Diameter	Shield	Jacket	Overall Diameter	Minimum Recommended Bend Radius	Operating Temp. (°C)	Weight (lbs./100ft)	
M17/60-RG142	.037" SCCS	.116"	SPC(2)	FEP	.195"	1.0"	-55 +200	43.0	
M17/93-RG178	.0120"(7/.004")SCCS	.033"	SPC	FEP	.071"	0.4"	-55 +200	6.3	
M17/93-00001	.0120"(7/.004")SCCS	.033"	SPC	PFA	.071"	0.4"	-55 +230	6.3	M17/93-RG178 w/ extended temp. ra
M17/94-RG179	.0120"(7/.004")SCCS	.063"	SPC	FEP	.100"	0.4"	-55 +200	10.8	
M17/95-RG180	.0120"(7/.004")SCCS	.102"	SPC	FEP	.141"	0.7"	-55 +200	19.8	
M17/110-RG302	.0253"SCCS	.146"	SPC	FEP	.202"	1.0"	-55 +200	40.0	
M17/111-RG303	.037"SCCS	.116"	SPC	FEP	.170"	0.9"	-55 +200	31.0	
M17/112-RG304	.059" SCCS	.185"	SPC(2)	FEP	.280"	1.4"	-55 +200	94.0	
M17/113-RG316	.0201"(7/.0067")SCCS	.060"	SPC	FEP	.098"	0.5"	-55 +200	12.2	
M17/127-RG393	.094"(7/.0312")SC	.285"	SPC(2)	FEP	.390"	2.0"	-55 +200	165.0	
M17/128-RG400	.0384"(19/.008")SC	.116"	SPC(2)	FEP	.195"	1.0"	-55 +200	50.0	
M17/131-RG403	.0120"(7/.004")SCCS	.033"	SPC(2)	FEP(2)	.116"	0.6"	-55 +200	15.0	Triaxial M17/93-RG
M17/152-00001	.0201"(7/.0067")SCCS	.060"	SPC(2)	FEP	.114"	0.6"	-55 +200	18.5	Double shielded M17/113-RG316
M17/158-00001	.037"SCCS	.116"	SPC(2)	FEP	.195"	1.0"	-55 +200	56.0	Unswept M17/60-RG
M17/169-00001	.0120"(7/.004")SCCS	.033"	SPC	FEP	.071"	0.4"	-55 +200	6.3	Unswept M17/93-RG
M17/170-00001	.037"(SCCS	.116"	SPC	FEP	.170"	0.9"	-55 +200	39.0	Unswept M17/111-RG
M17/172-00001	.0201"(7/.0067")SCCS	.060"	SPC	FEP	.098"	0.5"	-55 +200	11.5	Unswept M17/113-RG
M17/174-00001	.094"(7/.0312")SCCS	.285"	SPC(2)	FEP	.390"	2.0"	-55 +200	175.0	Unswept M17/127-RG
M17/175-00001	.0384"(19/.008")SC	.116"	SPC(2)	FEP	.390"	1.0"	-55 +200	50.0	Unswept M17/128-RG
M17/176-00002	.0235"(19/.005")SPA(2)	.042"	SPA	PFA	.129"	0.6"	-55 +230	18.0	Controlled impedar twinax
PTFE Tape Wrap Jacketed RG Cables									
RG 187 A/U	.0120"(7/.004)SCCS	.063	SPC	PTFE	.100"	0.5"	-55 +250	10.0	Flexible, 250° C. rat
RG 188 A/U	.0201"(7/.0067)SCCS	.060	SPC	PTFE	.100"	0.5"	-55 +250	11.0	Flexible, 250° C. rat
RG 195 A/U	.0120"(7/.004)SCCS	.102	SPC	PTFE	.141"	0.7"	-55 +250	18.0	Flexible, 250° C. rat
RG 196 A/U	.0120"(7/.004)SCCS	.034	SPC	PTFE	.067"	0.4"	-55 +250	6.0	Flexible, 250° C. rat

Electrical Characteristics:

M17 Number	Impedance (ohms)	Capacitance (pF/ft)	Max. Operating Voltage (RMS)	Maximum attenuation (dB/100ft) @						
				100 MHz	400 MHz	1 GHz	3 GHz	5 GHz	10 GHz	
M17/60-RG142	50 +/- 2	29.4	1900	5.5	11.7	19.0	35.0	48.0	-	17.4
M17/93-RG178	50 +/- 2	29.4	1000	16.0	33.0	52.0	94.0	-	-	3.0
M17/93-00001	50 +/- 2	29.4	1000	16.0	33.0	52.0	94.0	-	-	3.0
M17/94-RG179	75 +/- 3	19.4	1200	-	21.0	-	-	-	-	-
M17/95-RG180	95 +/- 5	16.4	1500	-	17.0	-	-	-	-	-
M17/110-RG302	75 +/- 3	19.4	2300	-	8.0	-	26.0	-	-	-
M17/111-RG303	50 +/- 2	29.4	1900	3.9	8.0	15.0	28.0	-	-	-
M17/112-RG304	50 +/- 3	29.4	3000	2.7	6.4	11.1	22.0	30.0	-	8.0
M17/113-RG316	50 +/- 2	29.4	1200	11.0	21.0	38.0	58.0	-	-	3.0
M17/127-RG393	50 +/- 2	29.4	2500	2.4	5.0	8.8	18.0	24.6	37.0	11.0
M17/128-RG400	50 +/- 2	29.4	1900	4.5	10.5	17.0	38.0	50.0	78.0	12.4
M17/131-RG403	50 +/- 2	29.4	1000	-	37.0	-	-	-	-	10.0
M17/152-00001	50 +/- 2	29.4	1200	11.5	24.0	40.0	75.0	110.0	170.0	12.4
M17/158-00001	50 +/- 2	29.4	1900	-	9.5	-	-	-	-	-
M17/169-00001	50 +/- 2	29.4	1000	-	29.0	-	-	-	-	-
M17/170-00001	50 +/- 2	29.4	1900	-	8.6	-	-	-	-	-
M17/172-00001	50 +/- 2	29.4	1200	-	21.0	-	-	-	-	-
M17/174-00001	50 +/- 2	29.4	2500	-	5.0	-	-	-	-	-
M17/175-00001	50 +/- 2	29.4	1900	-	10.5	-	-	-	-	-
M17/176-00001	77 +/- 7	19.0	1000	-	-	-	-	-	-	-
PTFE Tape Wrap Jacketed RG Cables										
RG 187 A/U	75 +/- 3	19.4	1200	-	21.0	-	-	-	-	3
RG 188 A/U	50 +/- 2	29.4	1200	11.0	21.0	38.0	58.0	-	-	3
RG 195 A/U	95 +/- 5	15.4	1500	-	17.0	-	-	-	-	3
RG 196 A/U	50 +/- 2	29.4	1000	-	29.0	-	-	-	-	-

"Maximum frequencies" are those as referenced on individual slant sheets of the MIL-C-17 specification. No values are given for unswept constructions as the specification recommends these cables should not be used above 400 MHz. (All figures referenced above are nominal unless otherwise specified.)

Arnitel

polyether esters
polyetherester
esters de polyether

天線桿套材質特性表



Units Einheiten Unites	EM400	EM460	EL550	EL630	EL740	PL380
	1.12	1.16	1.20	1.23	1.27	1.18
°C	195	185	202	212	221	197
μm/m.k	220	160	180	140	110	150
°C	\	\	110	115	120	\
°C	130	150	180	200	200	145
°C	\	50	85	115	150	\
%	0.30	0.30	0.20	0.20	0.15	0.40
%	0.75	0.70	0.55	0.60	0.90	7.0
*	HB	HB	HB	HB	HB	HB
Mpa	55	110	220	375	900	60
Mpa	4.0	7.1	13.2	20.2	26.9	3.5
Mpa	5.4	9.0	15.7	23	22.6	5.2
Mpa	8.4	11.4	16.6	22.0	26.3	8.5
Mpa	17	21	32	40	45	16
%	700	800	600	600	360	450
kJ/m ²	NB	NB	NB	NB	NB	NB
kJ/m ²	NB	NB	NB	NB	200	NB
kJ/m ²	NB	NB	NB	NB	9	NB
kJ/m ²	NB	NB	20	4	4	NB
	38	45	55	63	74	38
MV/m	\	\	\	\	\	\
Ω.cm	5*10 ¹⁴	10 ¹⁴	10 ¹⁴	10 ¹⁴	10 ¹²	10 ¹²
Ω	>10 ¹³	>10 ¹⁴	>10 ¹⁴	>10 ¹⁴	>10 ¹⁰	>10 ¹³
\	4.1	\	\	3.8	\	4.7
\	4.0	4.4	4.0	3.4	3.3	4.4
x10 ¹⁴	10	\	\	3.8	\	310
x10 ¹⁴	170	350	400	350	300	350
\	800	800	600	600	600	800
\	600	600	600	800	800	600

Arnitel

2.2 Product coding

The structure of the Arnitel productcodes is illustrated with the following example:

U M 55 1 - V

Thermoplastic elastomer type:

- E = polyether ester, polyether = PTHF
- P = polyether ester, polyether = PEO/PPO
- U = polyester ester; (with extra urethane linkages)

Indication of viscosity range or processing technique

- L, M = injection moulding and extrusion
- B = blow moulding grade

Indication of hardness (Shore D)

Serial number

Indication of additives, performance

- H = heat-stabilized
- L = light/UV stabilized
- V = flame-retardant (not V-0)
- S = flame-retardant (V-0)

Figure 2.2: Arnitel product coding

2.3 Product portfolio

The Arnitel productrange is available with a hardness from 38 to 74 Shore D. The general Arnitel grades are shown in table 2.2. In order to enhance the flexibility of the portfolio a set of masterbatches (a.o. for heat, UV, etc) are on offer (refer to § 2.4).

Because of the development of these masterbatches heat stabilised Arnitel P is suggested for application areas where thermo-oxidative stability is an issue. For applications where colour and UV stability is required, the Arnitel E range is advised.

	Shore D					
	38	40	46	55	63	74
Arnitel E		EM400	EM460	EL550 EM550	EL630 EM630	EL740 EM740
Arnitel P	PL380		PL460	PL580 PM581		
Arnitel U				UM551 UM551-V UM552 UM552-V	UM622	

Table 2.2: Arnitel productrange for general purpose

Besides these multi-purpose grades, specialty grades can be offered for specific purposes and/or application areas. These grades are not intended for regular sales and are therefore restricted. Permission from marketing is needed before sampling is initiated.

	Arnitel E	Arnitel P	Arnitel U
Automotive			
• CVJ boots	EB460 EB463 EB464		
• Boyplugs		PL380-M0	
Extrusion			
• Roofing foil	EM402-L		

Table 2.3: Examples of specialty grades

Arnitel® EL630/EM630

2.8.31 General:

Arnitel is the brand name of a series polyester based thermoplastic elastomers. These polymers combine excellent processability with good elastomeric properties between -40 and 200°C. Arnitel EL630 and EM630 are excellent materials for injection moulding and extrusion applications respectively. The chemical structure of Arnitel EL630/EM630 is shown below.

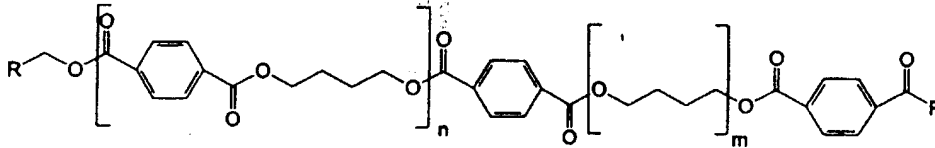

Figure 2.9: Chemical structure of Arnitel EL630/EM630.

Another way of writing the structure of Arnitels is shown below in Figure 2.



Figure 2.10: Simplified structure of Arnitel EL630/EM630 .

Arnitel EL630/EM630 is TOSCA registered (including DSL-Canada) under CAS 37282-12-5

2.8.32 Thermal properties:

• **Modulus-temperature behaviour:**

The materials have a glass transition at circa -40°C and a typical melting point at 213°C. The modulus-temperature behaviour is shown in graph 2.76, for comparison, accompanied by other Arnitel E types.

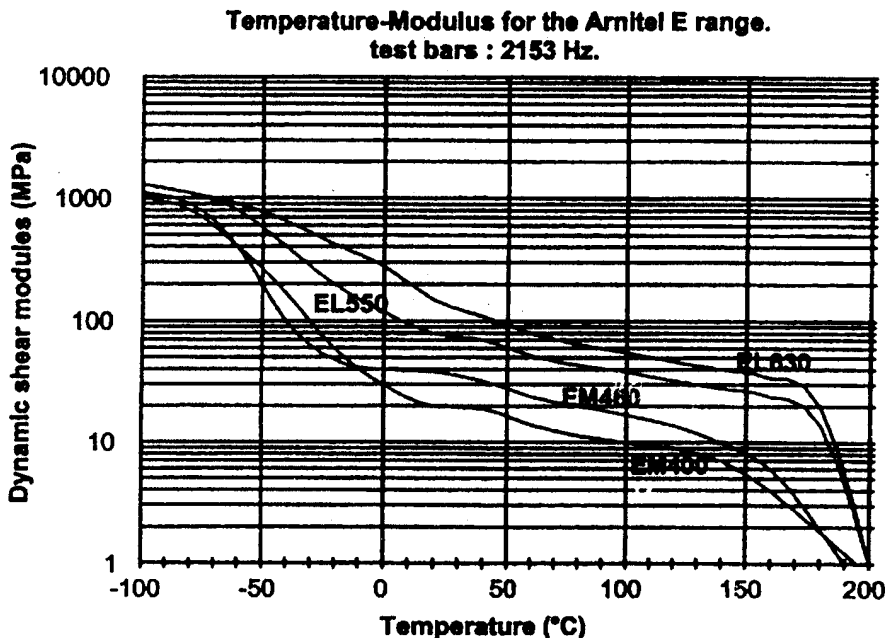

Graph 2.76: Modulus-temperature behaviour of Arnitel EL630/EM630.

Arnitel® EL630/EM630

Although information on performance at higher temperatures may be extracted from the above shown graph, a Vicat or HDT are shown in table 2.29.

analysis	SI unit	typical data	test method
Vicat A	(°C)	200	ISO 308/A
Vicat B	(°C)	125	ISO 308/B
HDT-B	(°C)	115	ISO 75-1

Table 2.29: Vicat and HDT data on Arnitel® EL630 and EM630

Arnitel EL630 and EM630 have a melting point of 213°C as found in the second heating curve of a DSC. The polymer will crystallize at 155°C using a 20°C/min cooling rate. The thermal expansion coefficient of Arnitel EL630/EM630 and is $140 \cdot 10^{-4} \mu\text{m/m.K}$.

• **Heat aging:**

Arnitel EL630/EM630 shows an optimum between heat resistance and colour stability. Heat aging for EL630/EM630 is under test at this moment, however the data will be between EL550 and EL740. Arrhenius curves of thermo-oxidative heat aging are shown in graph 2.77. Criterium chosen is retention of 50% original elongation at break.

Heat aging of Arnitel E40D, 46D, 55D and 74D.

Natural products, Arrhenius plot.

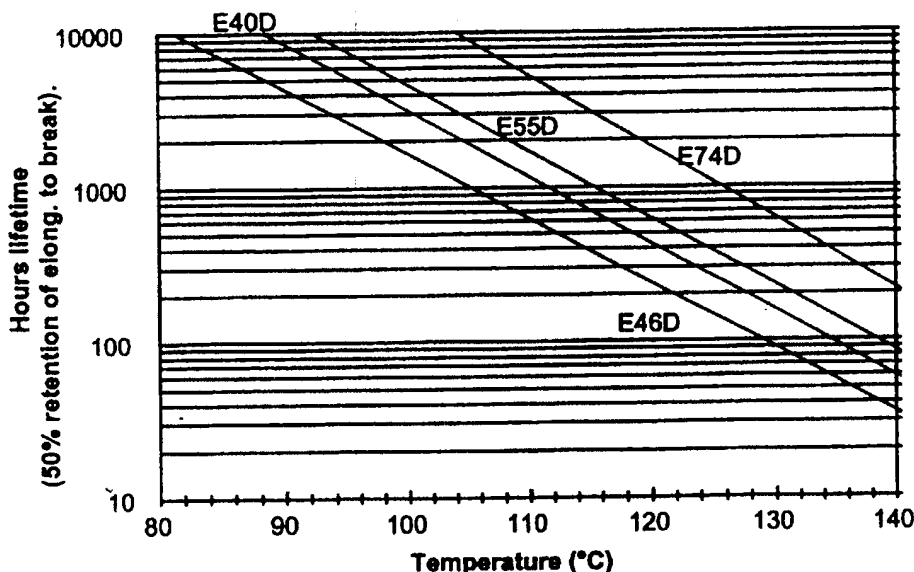

Graph 2.77: Heat stability for Arnitel E-range.

Heat ageing can be improve using a stabilisation masterbatch, however for heat stabilisation the P-range is preferred for it's excellence in performance. These data can be found in the Arnitel properties summary or an Arnitel P datasheet.

2.8.33 Processing and Handling:

Arnitel EL630/EM630 is a polyester with a density of 1.12 g/cm³ according ISO 1183. Due to the polyester nature of these materials it is of major importance to store the material dry prior to processing. Materials packaged in sealed packaging should have a moisture content lower then 500 ppm. The polymer will contain 0.12% moisture in 50% RH and 0.58% water after saturation in water. Both numbers are in equilibrium.

If samples have become wet during storage a drying step of 24 hours 120°C (or 6 hours 140°C) prior to use will prevent degradation of the material during processing combined with an eventual loss of properties. The air or nitrogen will have to have a dew point of at least -30°C.

Arnitel® EL630/EM630

• **Processing:**

Arnitel EL630/EM630 shows a single melting point at 195°C in DSC. Processing conditions are shown in the table below.

polymer	zone 1	zone 2	zone 3	additional	melt	mold
EL630	225	230	235	235	225-235	20-50
EM630	225	230	235	235	235	50

All temperatures are in °C.

Table 2.30: Processing conditions for Arnitel EL630 and Arnitel EM630.

• **Rheology:**

The temperature depending melt viscosity of Arnitel EL630/EM630 and are shown below in graph 2.80 and 2.81 respectively.

**Shear rate dependent of the melt viscosity of Arnitel EL630.
Effect of melt temperature.**

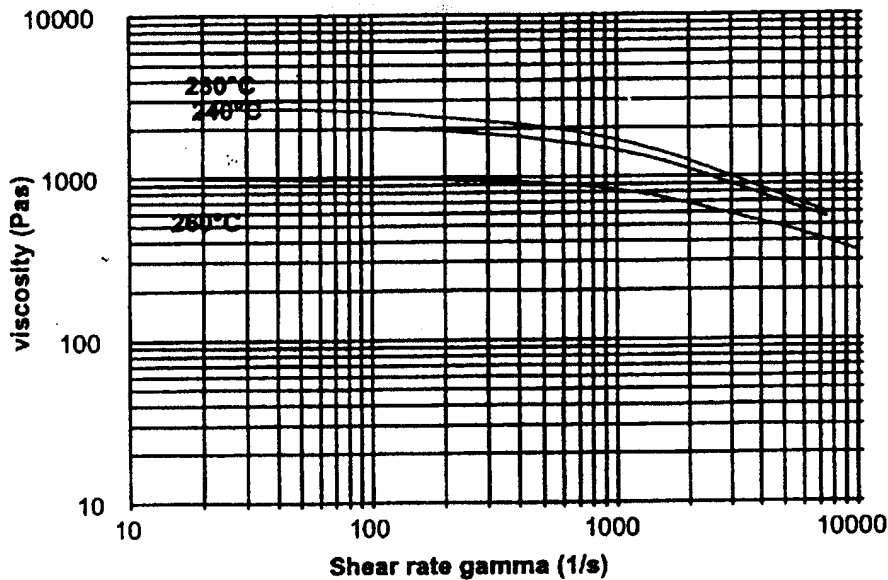

Arnitel® EL630/EM630

Capillar melt viscosity of Arnitel EM630.
240, 250 and 260°C.

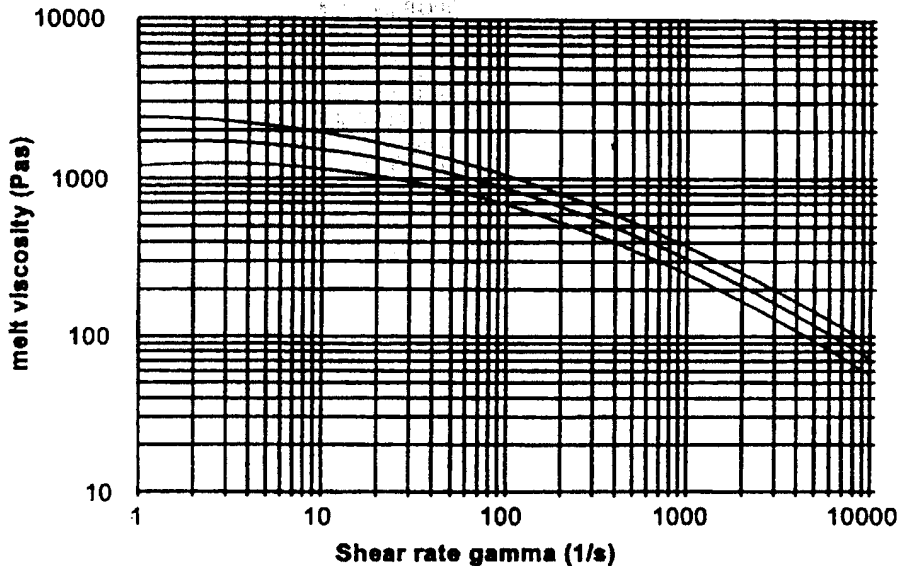

Graph 2.80 and 2.81: Temperature dependency of the melt viscosity for Arnitel EL630 and EM630 .

The MFI values are shown in table 2.31.

		EL630	EM630	
MFI 230°C	g/10 min		7	ISO 1133
MFI 240°C	g/10 min	30		ISO 1133

Table 2.31: MFI for Arnitel EL630/EM630.

• Use of regrind:

Arnitel can readily be recycled. If the MFI of the regrind is up or down to four points higher, 20% can be recycled. A difference of 2 MFI points allows up to 50% of regrind. Obviously the regrind should be dried properly before use.

2.8.34 Mechanical properties:

If Arnitel EL630 or Arnitel EM630 are processed properly the materials will have mechanical properties as shown in table 2.32.

Mechanical property	SI Unit	typical data*		test method
		EL630	EM630	
Hardness	Shore D	63	63	ISO 868
Tensile modulus (1 mm/min)	MPa	330	330	ISO 527
Tensile strength (50 mm/min)	MPa	30	30	ISO 527
Strain at break	%	350	350	ISO 527
Tensile stress at 5% strain	Mpa	11.5	11.5	
Tensile stress at 10% strain	Mpa	15.9	15.9	
Tensile stress at 50% strain	Mpa	17.3	17.3	
Tear strength Graves	KN/m	145	145	DIN53515
Izod notched 23°C (73°F)	KJ/m ²	NB	NB	ISO 180/1A
Izod notched -30°C (-22°F)	KJ/m ²	4	4	ISO 180/1A
Charpy notched 23°C (73°F)	KJ/m ²	NB	NB	ISO 179/1eA
Charpy notched -30°C (-22°F)	KJ/m ²	12	12	ISO 179/1eA

* Data for dry natural materials.

NB: No Break

Table 2.32: mechanical properties of Arnitel® EL630.

Arnitel® EL630/EM630

- **Abrasion:**

Arniteis show good abrasion resistance in both Taber and DIN 53516 abrasion tests. Data are shown in the Arnitel general property overview (also included in the EPIC)

2.8.35 Flame retardancy:

Arnitel EL630 and EM630 show in an ISO1210/A flammability test a burning rate leading to a classification FH-1. Flame retardancy can be improved using a halogenated or halogen free FR masterbatch.

2.8.36 Electrical properties:

Arnitel EL630/EM630 can be used for cable jacketing applications. If the material is in permanent contact with copper a copper stabilisation package should be added. If the copper wires are coated with a tin layer, no stabilisation is necessary. The electrical properties are shown in table 33.

Electrical property	SI Unit	typical data*		test method
		EL630	EM630	
Dielectric strength	KV/mm	22	22	IEC 243-1
Relative permittivity (ϵ_r) at 1 kHz	-	4.4	4.4	IEC 250
Dissipation factor ($\tan \delta$) at 1kHz	-	0.019	0.019	IEC 250
Comparative tracking index	-	600	600	IEC 112
Volume resistivity	$10^{14} \Omega \cdot \text{cm}$	1	1	IEC 93
Surface resistivity	$10^{14} \Omega$	1	1	IEC 93

Table 2.33: Typical electrical properties of Arnitel® EL630 and EM630.

2.8.37 Chemical resistance:

Arnitel EL630 and EM630 are sensitive to strong bases and strong acids, especially at elevated temperatures. In some halogenated hydrocarbons (like tetrachloroethane), the materials (partially) dissolve. For a full review on chemical resistance of Arnitel EL630 and EM630 request the chemical resistance brochure.

- **Hydrolysis**

Like all polyesters Arnitel are sensitive to moisture, however Arniteis are more stable to water than e.g. PET and PBT. graph 2.84 shows the hydrolytic stability of Arnitel EL630 at 100°C and in steam (120°C). For improved hydrolysis stability, using a polycarbodiimid containing masterbatch like Stabaxol® in an option. To maintain all other properties use a masterbatch based on polyester. Data on the Stabaxol stabilised grade are shown in graph 2.85.

■Panlite L-1250Z

Category	Unit	Test Method	Condition	L-1250Z 100
Melt volume flow rate	cm ³ /10min	ISO 1133	300°C load 1.2kg	8
Density	kg/m ³	ISO 1183	—	1200
Water absorption rate	%	ISO 62	in water 23°C24h	0.2
Light transmission	%	ASTM D 1003	thickness 3mm	88
Refractive index	—	ASTM D 542	—	1.585
Tensile modulus	MPa	ISO 527-1 and ISO 527-2	1mm/min	2400
Tensile stress at yield	MPa		50mm/min	61
Tensile strain at yield	%		50mm/min	6
Nominal tensile strain at break	%		50mm/min	>50
Flexural modulus	MPa	ISO 178	2mm/min	2350
Flexural strength	MPa		2mm/min	93
Charpy impact strength	KJ/m ²	ISO 179	unnotched	NB
			notched	76
Heat deflection temperature	°C	ISO 75-1 and ISO 75-2	1.80MPa	129
			0.45MPa	142
Vicat softening temperature	°C	ISO 306	50°C/h 50N	149
Mold shrinkage	%	In-house method	parallel	0.5~0.7
			vertical	0.5~0.7
Coefficient of linear expansion	× 10 ⁻⁴ /°C	ISO 11359-2	parallel	0.7
			vertical	0.7
Specific inductive capacity	—	IEC 60250	100Hz	3.1
	—		1MHz	3
Dielectric loss tangent	× 10 ⁻⁴	IEC 60250	100Hz	10
	× 10 ⁻⁴		1MHz	90
Volume resistivity	Ω·m	IEC 60093	—	>1 × 10 ¹³
Surface resistivity	Ω	IEC 60093	—	>1 × 10 ¹⁵
Withstand voltage	MV/m	IEC 60243-1	short time test	30
Tracking resistance	—	IEC 60112	—	250
Flammability	—	UL 94	—	V-2(0.40mm) HB(1.5mm)
Temperature index	°C	UL 746B	electric 1.47mmt	125
			impact 1.47mmt	115
			non-impact 1.47mmt	125

※The values listed are specification values, not certified values.

Two-part adhesive		1590	High Super 5	EP-330 (HighSuper30)	EP-331	1500	Super
Feature		curing for 5 min type		curing for 30 min type	curing for 30min type Low-viscosity	Standard type	
Appearance	Base	Clear, blue	Translucent, blue	Translucent, pink	Clear, light yellow	Clear, light yellow	Translucent
	Hardener	Clear light yellow	Translucent, light yellow	Translucent, milk white	Clear, light yellow	Clear, light brown	Light yellow
Viscosity (Pa · S/20°C)	Base	8	120	80	7	25	100
	Hardener	12	70	170	7	60	50
Specific gravity (g/cm ³)	Base	1.17	1.17	1.17	1.16	1.16	1.14
	Hardener	1.11	1.15	1.14	1.16	0.97	0.99
Mixing ratio(Base : Hardener)		1 : 1	1 : 1	1 : 1	1 : 1	1 : 1	1 : 1
Pot life		Within 5 min	Within 5 min	Within 30 min	Within 30 min	Within 1 hr	Within 1 hr
Tensile shear strength(N/mm ²)		19.0	18.0	17.5	17.6	15.7	15.1
T-Formed peeling adhesion (N/mm)		2.71	0.31	0.47		0.40	
Hardness(shore D)		77	77	82	71	82	
Coefficient of linear expansion (× 10 ⁻⁵)		8.6	10.7	6.7	4.1	7.1	
Tg(°C)			47	43		53.7	
Volume resistivity(Ω · cm)			4.9 × 10 ¹⁵	3.8 × 10 ¹¹	3.6 × 10 ¹¹	1.1 × 10 ¹⁶	
Coefficient of water absorption(%)			2.5	2.3		0.8	
Capacity standards		Base 1 kg Hardener 1 kg	6 g set 15 g set 25 g set 80 g set	320 ml set Base 3 kg Hardener 3 kg 6 g set, 15 g set, 80 g set	Base 1 kg Hardener 1 kg	Base 500 g, 1 kg, 3 kg, 15 kg Hardener 500 g, 1 kg, 3 kg, 15 kg	15 g set 40 g set 110 g set



施敏打硬 CEMEDINE 1500

〔一般性質〕

	主 劑	硬 化 劑
主要成分	環氧 (Epoxy) 樹脂	聚醯胺 (Poly-Amido) 樹脂
顏色常態	中間帶淺黃色透明液體	透明液體
不揮發率 (%)	99.6	99.4
黏度 (9/20°C)	350	600
比重 (20/20°C)	1.16	0.97
溶 劑	無	
硬化劑混合比例 phr	60~110	
保持粘度時間	參照混合硬化劑後的粘度變化表	
膠 化 時 間	3 小時	
硬化所需時間	6 小時 10 分鐘	
可保存時間 (20°C)	2 年	

〔特性〕

由兩種液體混合而成的環氧 (Epoxy) 樹脂系黏着劑，能在常溫下硬化，應用範圍至為廣泛，可穩定粘着金屬、塑膠以及其他各種物質，而由於此黏着劑，通常以聚醯胺 (Poly-Amido) 樹脂為其硬化劑，具有下列各優點：

1. 能在常溫下硬化。
2. 縱使所使用的硬化劑份量不同，也不影響其特性。
3. 由於能產生比一般黏着劑富有彈曲性的黏着層，縱使粘着不同材質的物品，也能以粘着層緩和熱膨脹的差別所引起的兩物品彎曲，對機械學的衝擊也能顯現較為良好的性能。
4. 由於能形成透明的黏着層，可以粘着透明的物質，如玻璃等等。

〔用 途〕

由於能強力粘着各種物質，諸如金屬，熱硬化塑膠，玻璃，飛機裝配以及一般家庭器具等等，應用範圍至為廣泛。

縱然是複聚乙稀 (Polythylene)，聚酯 (Polyester)，天然以及人造橡膠等，以一般的粘着根本無法粘着的物質，如果加以適當的表面處理，即可強力粘着。

〔實 例〕

汽車、火車、船隻、飛機……。(將金屬把手粘着於玻璃窗) 可以粘着銅製品，三聚氰胺 (Melamine) 裝飾板等，於內部以增加強度。(不同金屬間為防止電偶且加熱之) 當作防腐塗料亦可。

電器製品……。(由於是一種優秀的黏着劑，使用於高級擴音器、音響設備的粘着/電磁器或外殼的粘着/線圈框的粘着/鐵粉筒的粘着/馬達線圈的粘着等等)。

建築……(玻璃、壓克力門或將文字或信屏風黏住把手) 印刷設備以及其他塑膠裝飾品的加粘以及獨立/不銹鋼製品、船隻建材、陶器或大理石等需要強力粘劑物品之加粘。

高級裝飾品，玻璃以及塑膠製工藝品，精密機械……(照像機，調整距離儀/分光儀等等的底座)。
其他諸如鐘頭，遊動器材，公路標誌等等的加粘。
除上述各種加粘外，也可以使用作填充劑，鑄模用以及膜裏用。



圖 II 2.1
硬化劑混合量と粘着力強度
(在20°C七天の硬化)
試験片: 軟銅板 (25×100×1.6mm)
(Over-lap)12.5mm



圖 II 2.2
硬化劑混合量と粘着力強度
(在80°C一小時の硬化)
試験片: 同其他圖 II 2.1

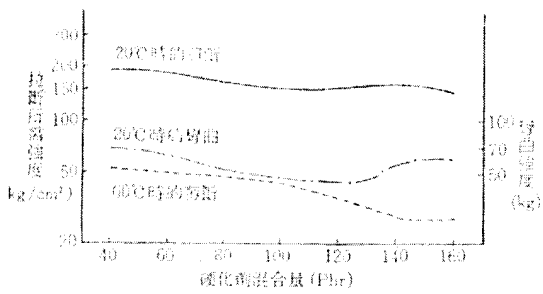

圖 II 2.3
常溫時の硬化特性 硬化劑混合率 100phr

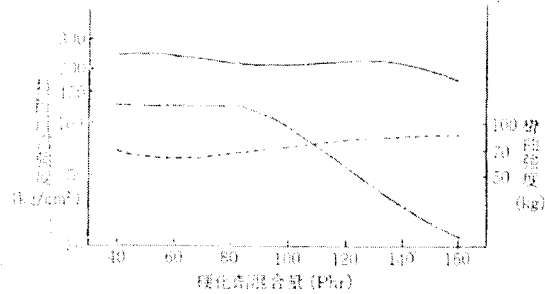

圖 II 2.5
耐熱特性 硬化劑混合率為 100phr

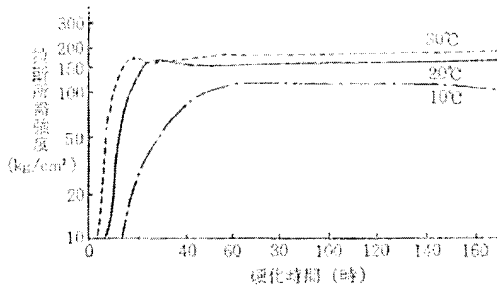

圖 II 2.4
加熱硬化特性 硬化劑混合率為 100phr

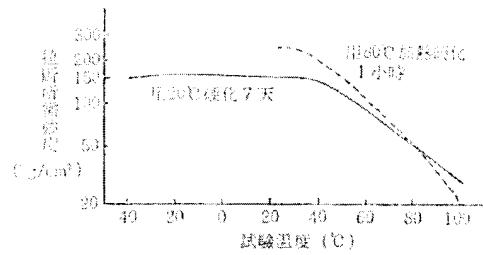

圖 II 2.6
老化特性

表 II 2.1 物理特性

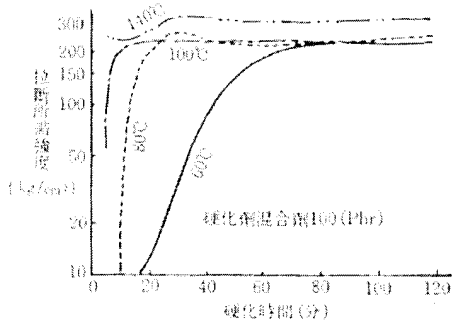
抗張力 (kg/mm ²)	5.04	硬塊 { ロックスワートM バーコル シロアード	63
抗折力 (kg/mm ²)	7.49		67
線膨張率 (kg/mm ²)	214		82
曲げ強度 (kg/mm ²)	11.6	表面固定電阻 (Ω)	5.6×10 ¹¹
厚さ強度 (kg/mm ²)	15.10(6.41) (D)	體積固有電阻 (Ω-Cm)	10.5×10 ¹³
玻璃轉溫度 (°C)	47	誘電率 (10 ⁶ cycle)	2.94
		電壓破塊 (kv/mm)	19

表II 2.2 拉斷所需強度

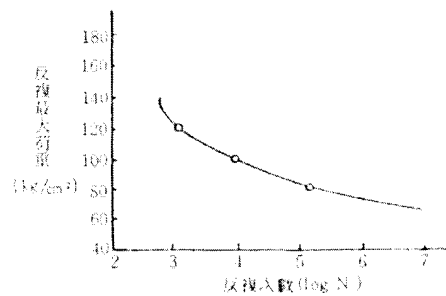
玻 璃 質	拉 斷 所 需 強 度	玻 璃 質	拉 斷 所 需 強 度 (20°C)
樟 樹 材	83	多 元 共 成	22
馬 菜 西 亞 杉 材	106 ※	萊 乙 錫 耐 質	19
針 葉 樹 材	99 < ※	瑪 克 力 耐 質	30
杉 材	66	德 質 錫 耐 質	36
玻 璃	153	三 聚 氫 酸 聚 酯 板 (表 面)	55
硝 酸	61	三 聚 氫 酸 聚 酯 板 (背 面)	45
黃 硝 酸	69		
混 合	80		
路 電 線	71	F R P	125
非 電 線	50		

[註] 1. 粘着條件：20°C，硬化7天，硬化劑混合比 100phr(接合部over-lap)12.5mm。
2. ※記號者表示材料拉斷。

表II 2.3 促進劣化特性

試 驗	未試驗前的粘力強度 (kg/cm ²)	比較調整試驗片的粘力強度(1) (1個月) (kg/cm ²)	經過各試驗1個月後的粘力強度 (kg/cm ²)	經過各試驗1,000小時後的粘力強度 (kg/cm ²)
利用測候儀所做的耐候試驗	143	150	—	166
利用噴射鹽水的促進試驗	143	150	100	—
利用高濕高濕的促進試驗(2)	143	150	143	—
利用反復冷知的促進試驗(3)	143	150	183	—

[註] (1) 20±1°C, 65±5%RH 各保持1個月的試驗片；(2) 50°C100%RH；(3) -5°C8小時~50°C16小時。

表II 2.4 耐 候 性

暴 露 前 的 粘 力 強 度		拉 斷 所 需 強 度 (kg/cm ²)	
比較調整試驗片的粘力強度 (6個月) ※	156	在戶外暴露6個月的粘力強度	147
" (1年) ※	138	" 1年 "	152
" (2年) ※	130	" 2年 "	138
" (3年) ※	123	" 3年 "	137
" (10年) ※	111	" 10年 "	130

[註] ※20±1°C, 65±5%RH 保持各期間的試驗片。

表II 2.5 耐水性 (20°C, 7天硬化)

試驗	拉 斷 所 需 強 度 (kg/cm ²)				
	時間	0	3個月	6個月	1年
常態試驗		120	106	123	120
耐水試驗			109	117	169

[註] 硬化劑混合比為 100phr
試驗片：不銹鋼 (100×25×1.5mm)
(接合部Over-lap)12.5mm。

表II 2.6 耐水性 (60°C, 2小時硬化)

試驗	拉 斷 所 需 強 度 (kg/cm ²)				
	時間	0	3個月	6個月	1年
常態試驗		157	150	169	163
耐水試驗			133	108	116

[註] 同表II 2.5

◎ GEMEDINE

表II 2.7 耐油性

拉斷時高強度 (kg/cm²)

放置日數	1天	3天	5天	10天	20天	1個月
放置於20°C室溫	---	---	---	90.0	---	79.0
0°C油中	---	---	77.5	87.5	---	80.0
20°C油中	---	---	82.5	77.6	---	89.5
70°C油中	77.6	78.3	80.0	74.3	---	71.0
循環油中 cycle	---	---	79.0	78.0	89.0	76.0

放置日數	40天	2個月	3個月	6個月	1年	10年
放置於 20°C室溫	---	---	73.0	65.9	76.3	75.4
0°C油中	---	86.5	71.5	80.5	89.2	---
20°C油中	---	70.5	79.5	78.7	79.7	---
70°C油中	---	75.5	---	75.4	68.3	---
循環油中 (cycle)	71.5	---	---	---	---	---

【註】 1. 硬化劑混合比為80phr，試驗片用木片(100×25×3mm)接合部(Over-lap)12.5mm 2. 油為硬質器油。
3. 試驗片全部破裂。

表II 2.8 耐溶劑、耐藥品性

種 類	浸漬7天後的黏力保持率(%)		浸漬1個月後的黏力保持率(%)		
	以20°C硬化7天 的試驗片	以80°C硬化1小 時的試驗片	以20°C硬化7天 的試驗片	以80°C硬化1小 時的試驗片	
溶 劑	已 烷	107.0	80.6	94.1	78.8
	乙 醇	85.5	63.8	51.7	66.8
	丙 酮	88.8	69.5	93.4	70.8
	四 氫 呋 喃	89.5	71.3	97.4	68.7
	三 氯 化 乙 烯	90.2	64.7	101.3	69.1
油	三 氯 化 乙 烯	91.5	72.7	65.0	69.5
	植 物 油	102.7	90.8	107.3	90.3
藥 品	植 物 油	96.2	87.8	98.1	84.2
	蒸 餾 水	102.7	90.8	107.3	90.3
	10% 硼 酸 溶 液	93.4	72.3	96.3	69.3
	10% 硼 酸 溶 液	93.4	72.8	79.8	69.8
	10% 硫 酸 溶 液	71.7	67.8	70.3	57.2
	10% 苛 性 鹼 溶 液	97.2	74.3	83.8	74.3
洗 滌 劑	10% 食 鹽 水 溶 液	89.5	71.8	91.0	69.8
	10% 醋 酸 溶 液	94.2	77.8	78.4	64.2

【註】黏劑混合率=1:1，試驗片：軟質片(25×100×1.6mm)但是實際試驗時使用了SUS-37，接合部(Over-lap)為12.5mm。

容量規格 = (主) 110g、1kg、15kg (組)



台灣 施敏打硬 股份有限公司

總公司：台北縣林口鎮中興路253號
電話：(02) 2629-1129 • 2629-1113
FAX：(02) 8631-6806
高雄分公司：高雄南區民生路通二街14號
電話：(07) 3118198 • 3215086