



HAC RF TEST REPORT

No. I14Z45205-SEM01

For

TCT Mobile Limited

GSM/GPRS/EDGE/UMTS Digital Mobile Phone with Bluetooth and WiFi

Mode Name: Yaris 5.5 US 1SIM

Marketing Name: 7047A

With

Hardware Version: Proto

Software Version: CGK+GDK0

FCC ID: RAD465

Results Summary: M Category = M3

Issued Date: 2014-02-24



Note:

The test results in this test report relate only to the devices specified in this report. This report shall not be reproduced except in full without the written approval of TMC Beijing.

Test Laboratory:

TMC Beijing, Telecommunication Metrology Center of MIIT

No. 52, Huayuan Bei Road, Haidian District, Beijing, P. R. China 100191.

Tel:+86(0)10-62304633-2079, Fax:+86(0)10-62304793 Email:welcome@emcite.com. www.emcite.com

Revision Version

Report Number	Revision	Date	Memo
I14Z45205-SEM01	00	2014-02-21	Initial creation of test report
I14Z45205-SEM01	01	2014-02-24	Update the marketing name

TABLE OF CONTENT

1 TEST LABORATORY	4
1.1 TESTING LOCATION	4
1.2 TESTING ENVIRONMENT.....	4
1.3 PROJECT DATA	4
1.4 SIGNATURE.....	4
2 CLIENT INFORMATION	5
2.1 APPLICANT INFORMATION	5
2.2 MANUFACTURER INFORMATION	5
3 EQUIPMENT UNDER TEST (EUT) AND ANCILLARY EQUIPMENT (AE)	6
3.1 ABOUT EUT	6
3.2 INTERNAL IDENTIFICATION OF EUT USED DURING THE TEST	6
3.3 INTERNAL IDENTIFICATION OF AE USED DURING THE TEST.....	6
3.4 AIR INTERFACES / BANDS INDICATING OPERATING MODES	6
4 CONDUCTED OUTPUT POWER MEASUREMENT	7
4.1 SUMMARY	7
4.2 CONDUCTED POWER	7
5. REFERENCE DOCUMENTS	7
5.1 REFERENCE DOCUMENTS FOR TESTING	7
6 OPERATIONAL CONDITIONS DURING TEST	8
6.1 HAC MEASUREMENT SET-UP.....	8
6.2 PROBE SPECIFICATION	9
6.3 TEST ARCH PHANTOM & PHONE POSITIONER.....	10
6.4 ROBOTIC SYSTEM SPECIFICATIONS.....	10
7 EUT ARRANGEMENT	11
7.1 WD RF EMISSION MEASUREMENTS REFERENCE AND PLANE	11
8 SYSTEM VALIDATION	12
8.1 VALIDATION PROCEDURE	12
8.2 VALIDATION RESULT	12
9 PROBE MODULATION FACTOR	13
9.1 MODULATION FACTOR TEST PROCEDURE.....	13
9.2 MODULATION FACTOR.....	14
10 RF TEST PROCEDURES	15
11 HAC RF TEST DATA SUMMARY	16
11.1 MEASUREMENT RESULTS (E-FIELD).....	16
11.2 MEASUREMENT RESULTS (H-FIELD)	16
11.3 TOTAL M-RATING	17
12 ANSI C 63.19-2007 LIMITS	16
13 MEASUREMENT UNCERTAINTY	18
14 MAIN TEST INSTRUMENTS	19
15 CONCLUSION	19
ANNEX A TEST LAYOUT	20
ANNEX B TEST PLOTS	21
ANNEX C SYSTEM VALIDATION RESULT	53
ANNEX D PROBE CALIBRATION CERTIFICATE	53
ANNEX E DIPOLE CALIBRATION CERTIFICATE	77

1 Test Laboratory

1.1 Testing Location

Company Name: TMC Beijing, Telecommunication Metrology Center of MIIT
Address: No 52, Huayuan beilu, Haidian District, Beijing, P.R.China
Postal Code: 100191
Telephone: +86-10-62304633
Fax: +86-10-62304793

1.2 Testing Environment

Temperature: 18°C~25 °C,
Relative humidity: 30%~ 70%
Ground system resistance: < 0.5 Ω

Ambient noise is checked and found very low and in compliance with requirement of standards.
Reflection of surrounding objects is minimized and in compliance with requirement of standards.

1.3 Project Data

Project Leader: Qi Dianyuan
Test Engineer: Lin Hao
Testing Start Date: February 12, 2014
Testing End Date: February 12, 2014

1.4 Signature



Lin Hao

(Prepared this test report)

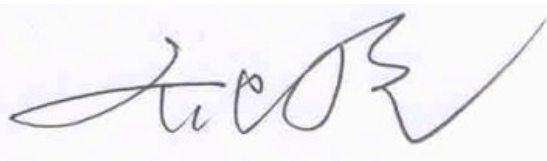

Qi Dianyuan

(Reviewed this test report)



Xiao Li

Deputy Director of the laboratory
(Approved this test report)

2 Client Information

2.1 Applicant Information

Company Name:	TCT Mobile Limited
Address /Post:	TCT Mobile Limited/5F, C building, No. 232, Liang Jing Road ZhangJiang High-Tech Park, Pudong Area Shanghai, P.R. China. 201203
City:	ShangHai
Postal Code:	201203
Country:	P.R.China
Contact:	Gong Zhizhou
Email:	zhizhou.gong@tcl.com
Telephone:	0086-21-61460890
Fax:	0086-21-61460602

2.2 Manufacturer Information

Company Name:	TCT Mobile Limited
Address /Post:	TCT Mobile Limited/5F, C building, No. 232, Liang Jing Road ZhangJiang High-Tech Park, Pudong Area Shanghai, P.R. China. 201203
City:	ShangHai
Postal Code:	201203
Country:	P.R.China
Contact:	Gong Zhizhou
Email:	zhizhou.gong@tcl.com
Telephone:	0086-21-61460890
Fax:	0086-21-61460602

3 Equipment Under Test (EUT) and Ancillary Equipment (AE)

3.1 About EUT

Description:	GSM/GPRS/EDGE/UMTS Digital Mobile Phone with Bluetooth and WiFi
Mode Name:	Yaris 5.5 US 1SIM
Marketing Name:	7047A
Operating mode(s):	GSM 850/1900, WCDMA 850/1900

3.2 Internal Identification of EUT used during the test

EUT ID*	IMEI	HW Version	SW Version
EUT1	014029000000276	Proto	CGK+GDK0

*EUT ID: is used to identify the test sample in the lab internally.

3.3 Internal Identification of AE used during the test

AE ID*	Description	Model	SN	Manufacturer
AE1	Battery	TLp025A1	/	BYD
AE2	Battery	TLp025A2	/	SCUD
AE3	Battery	TLp025A4	/	Lishen

*AE ID: is used to identify the test sample in the lab internally.

Note: It is performed to test with battery TLp025A2.

3.4 Air Interfaces / Bands Indicating Operating Modes

Air-interface	Band(MHz)	Type	C63.19/ tested	Simultaneous Transmissions Note: Not to be tested	Concurrent single transmission	Reduced power	Voice Over Digital Transport (Data)
GSM	850	VO	Yes	NA	Yes	No	NA
	1900				GPRS/EDGE Not rated		
	GPRS/EDGE	DT	NA	NA	Yes* see note	NA	NA
WCDMA	850	V/D	Yes	NA	NA	No	NA
	1900						

VO: Voice CMRS/PSTN Service Only

V/D: Voice CMRS/PSTN and Data Service

DT: Digital Transport

* HAC Rating was not based on concurrent voice and data modes, Non current mode was found to represent worst case rating for both M and T rating

4 CONDUCTED OUTPUT POWER MEASUREMENT

4.1 Summary

During the process of testing, the EUT was controlled via Agilent Digital Radio Communication tester (E5515C) to ensure the maximum power transmission and proper modulation. This result contains conducted output power for the EUT. In all cases, the measured output power should be greater and within 5% than EMI measurement.

4.2 Conducted Power

GSM 850MHz	Conducted Power (dBm)		
	Channel 251(848.8MHz)	Channel 190(836.6MHz)	Channel 128(824.2MHz)
	33.02	33.05	33.10
GSM 1900MHz	Conducted Power (dBm)		
	Channel 810(1909.8MHz)	Channel 661(1880MHz)	Channel 512(1850.2MHz)
	29.73	29.84	30.31
WCDMA 850MHz	Conducted Power (dBm)		
	Channel 4233(846.6MHz)	Channel 4182(836.4MHz)	Channel 4132(826.4MHz)
	22.52	22.51	22.53
WCDMA 1900MHz	Conducted Power (dBm)		
	Channel 9538(1907.6MHz)	Channel 9400(1880MHz)	Channel 9262(1852.4MHz)
	22.54	22.73	22.57

5. Reference Documents

5.1 Reference Documents for testing

The following document listed in this section is referred for testing.

Reference	Title	Version
ANSI C63.19-2007	American National Standard for Methods of Measurement of Compatibility between Wireless Communication Devices and Hearing Aids	2007 Edition
FCC 47 CFR §20.19	Hearing Aid Compatible Mobile Headsets	/
KDB 285076 D01	Equipment Authorization Guidance for Hearing Aid Compatibility	v03

6 OPERATIONAL CONDITIONS DURING TEST

6.1 HAC MEASUREMENT SET-UP

These measurements are performed using the DASY5 NEO automated dosimetric assessment system. It is made by Schmid & Partner Engineering AG (SPEAG) in Zurich, Switzerland. It consists of high precision robotics system (Stäubli), robot controller, Intel Core2 computer, near-field probe, probe alignment sensor. The robot is a six-axis industrial robot performing precise movements. A cell controller system contains the power supply, robot controller, teach pendant (Joystick), and remote control, is used to drive the robot motors. The PC consists of the HP Intel Core2 1.86 GHz computer with Windows XP system and HAC Measurement Software DASY5 NEO, A/D interface card, monitor, mouse, and keyboard. The Stäubli Robot is connected to the cell controller to allow software manipulation of the robot. A data acquisition electronic (DAE) circuit performs the signal amplification, signal multiplexing, AD-conversion, offset measurements, mechanical surface detection, collision detection, etc. is connected to the Electro-optical coupler (EOC). The EOC performs the conversion from the optical into digital electric signal of the DAE and transfers data to the PC plug-in card.

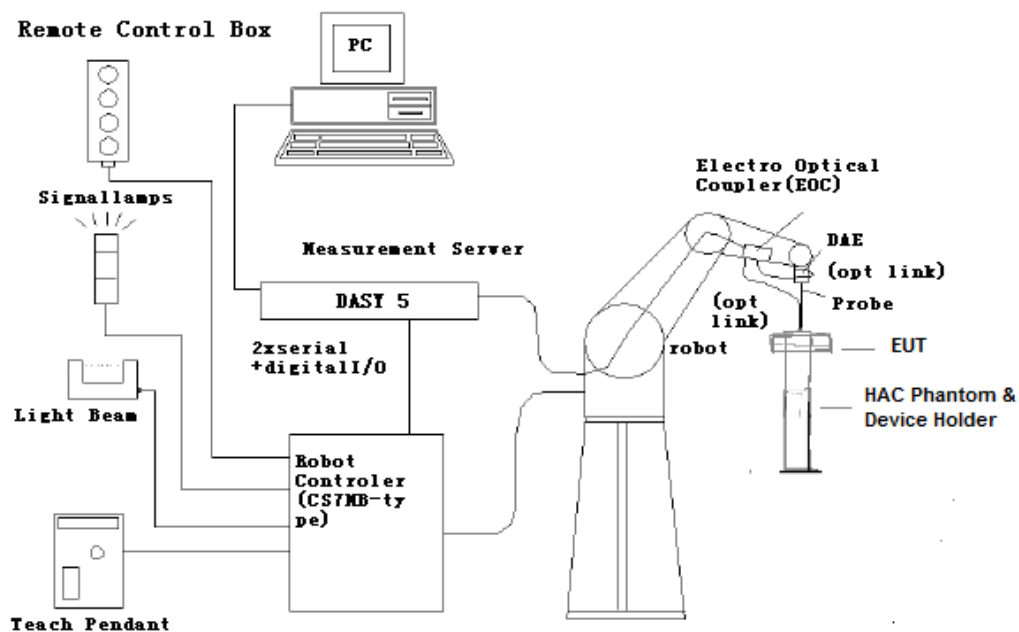

Fig. 1 HAC Test Measurement Set-up

The DAE4 consists of a highly sensitive electrometer-grade preamplifier with auto-zeroing, a channel and gain-switching multiplexer, a fast 16 bit AD-converter and a command decoder and control logic unit. Transmission to the PC-card is accomplished through an optical downlink for data and status information and an optical uplink for commands and clock lines. The mechanical probe mounting device includes two different sensor systems for frontal and sidewise probe contacts. They are also used for mechanical surface detection and probe collision detection. The robot uses its own controller with a built in VME-bus computer.

6.2 Probe Specification

6.2.1 E-Field Probe Description

Construction	One dipole parallel, two dipoles normal to probe axis Built-in shielding against static charges PEEK enclosure material
Calibration	In air from 100 MHz to 3.0 GHz (absolute accuracy $\pm 6.0\%$, $k=2$)
Frequency	40 MHz to > 6 GHz (can be extended to < 20 MHz) Linearity: ± 0.2 dB (100 MHz to 3 GHz)
Directivity	± 0.2 dB in air (rotation around probe axis) ± 0.4 dB in air (rotation normal to probe axis)
Dynamic Range	2 V/m to > 1000 V/m; Linearity: ± 0.2 dB
Dimensions	Overall length: 330 mm (Tip: 16 mm) Tip diameter: 8 mm (Body: 12 mm) Distance from probe tip to dipole centers: 2.5 mm
Application	General near-field measurements up to 6 GHz Field component measurements Fast automatic scanning in phantoms



[ER3DV6]

6.2.2 H-Field Probe Description

Construction	Three concentric loop sensors with 3.8 mm loop diameters Resistively loaded detector diodes for linear response Built-in shielding against static charges PEEK enclosure material (resistant to organic solvents, e.g., glycoether)
Frequency	200 MHz to 3 GHz (absolute accuracy $\pm 6.0\%$, $k=2$); Output linearized
Directivity	± 0.2 dB (spherical isotropy error)
Dynamic Range	10 mA/m to 2 A/m at 1 GHz
E-Field Interference	< 10% at 3 GHz (for plane wave)
Dimensions	Overall length: 330 mm (Tip: 40 mm) Tip diameter: 6 mm (Body: 12 mm) Distance from probe tip to dipole centers: 3 mm
Application	General magnetic near-field measurements up to 3 GHz (in air or liquids) Field component measurements Surface current measurements Low interaction with the measured field

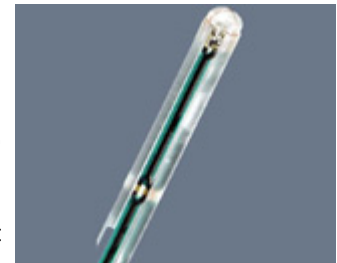

[H3DV6]

6.3 Test Arch Phantom & Phone Positioner

The Test Arch phantom should be positioned horizontally on a stable surface. Reference markings on the Phantom allow the complete setup of all predefined phantom positions and measurement grids by manually teaching three points in the robot. It enables easy and well defined positioning of the phone and validation dipoles as well as simple teaching of the robot (Dimensions: 370 x 370 x 370 mm).

The Phone Positioner supports accurate and reliable positioning of any phone with effect on near field $< \pm 0.5$ dB.

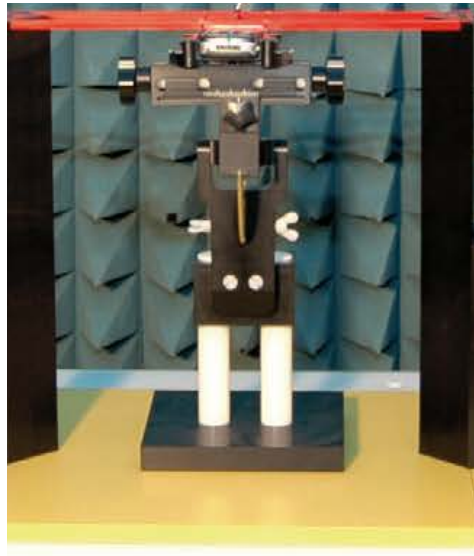

Fig. 2 HAC Phantom & Device Holder

6.4 Robotic System Specifications

Specifications

Positioner: Stäubli Unimation Corp. Robot Model: RX160L

Repeatability: ± 0.02 mm

No. of Axis: 6

Data Acquisition Electronic (DAE) System

Cell Controller

Processor: Intel Core2

Clock Speed: 1.86 GHz

Operating System: Windows XP

Data Converter

Features: Signal Amplifier, multiplexer, A/D converter, and control logic

Software: DASY5 software

Connecting Lines: Optical downlink for data and status info.

Optical uplink for commands and clock

7 EUT ARRANGEMENT

7.1 WD RF Emission Measurements Reference and Plane

Figure 4 illustrates the references and reference plane that shall be used in the WD emissions measurement.

- The grid is 5 cm by 5 cm area that is divided into 9 evenly sized blocks or sub-grids.
- The grid is centered on the audio frequency output transducer of the WD (speaker or T-coil).
- The grid is located by reference to a reference plane. This reference plane is the planar area that contains the highest point in the area of the WD that normally rests against the user's ear
- The measurement plane is located parallel to the reference plane and 15 mm from it, out from the phone. The grid is located in the measurement plane.

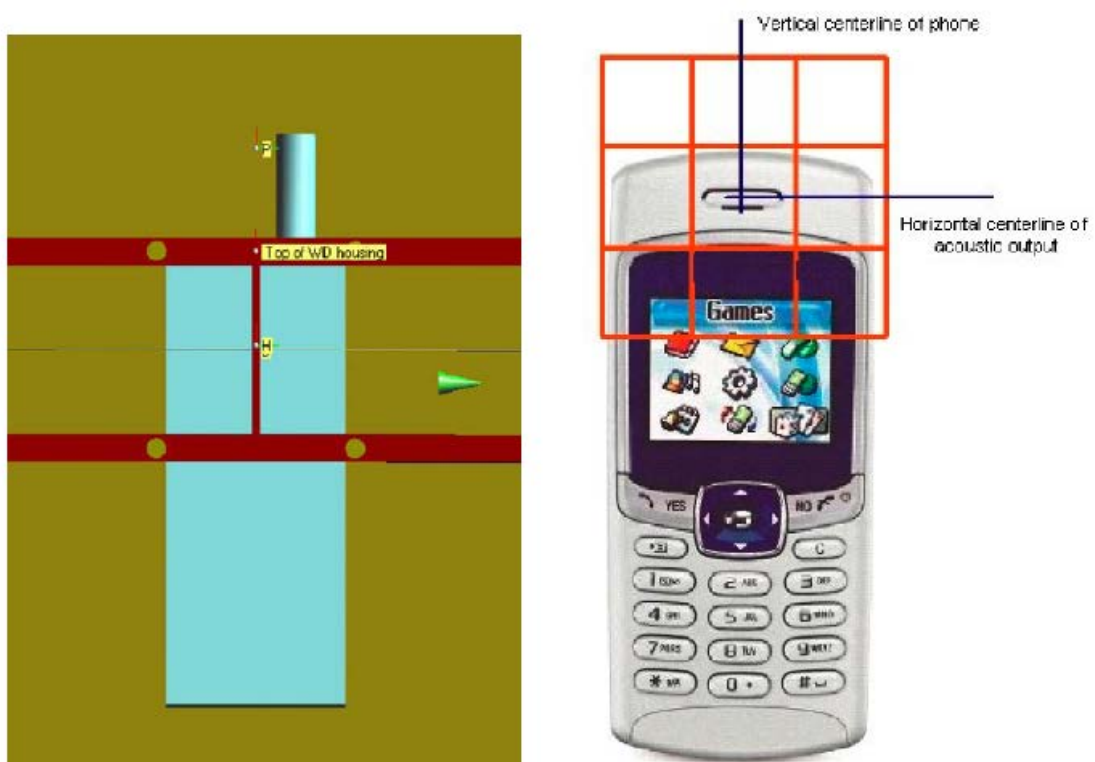

Fig. 3 WD reference and plane for RF emission measurements

8 SYSTEM VALIDATION

8.1 Validation Procedure

Place a dipole antenna meeting the requirements given in ANSI C63.19 D.5 in the position normally occupied by the WD. The dipole antenna serves as a known source for an electrical and magnetic output. Position the E-field and H-field probes so that:

- The probes and their cables are parallel to the coaxial feed of the dipole antenna
- The probe cables and the coaxial feed of the dipole antenna approach the measurement area from opposite directions
- The center point of the probe element(s) are 10 mm from the closest surface of the dipole elements.

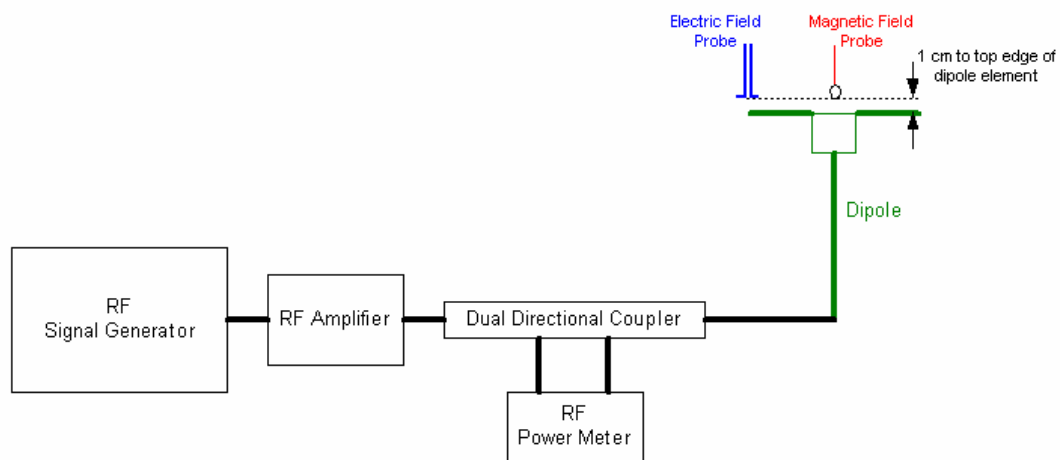

Fig. 4 Dipole Validation Setup

8.2 Validation Result

E-Field Scan							
Mode	Frequency (MHz)	Input Power (mW)	Power	Measured ¹ Value(V/m)	Target ² Value(V/m)	Deviation ³ (%)	Limit ⁴ (%)
CW	835	100		169.4	169.8	-0.24	±25
CW	1880	100		141.2	142.9	-1.19	±25
H-Field Scan							
Mode	Frequency (MHz)	Input Power (mW)	Power	Measured Value(A/m)	Target Value(A/m)	Deviation (%)	Limit (%)
CW	835	100		0.468	0.461	1.51	±25
CW	1880	100		0.454	0.470	-3.40	±25

Notes:

1. Please refer to the attachment for detailed measurement data and plot.
2. Target value is provided by SPEAD in the calibration certificate of specific dipoles.
3. Deviation (%) = 100 * (Measured value minus Target value) divided by Target value.
4. ANSI C63.19 requires values within ± 25% are acceptable, of which 12% is deviation and 13% is measurement uncertainty. Values independently validated for the dipole actually used in the measurements should be used, when available.

9 Probe Modulation Factor

The Probe Modulation Factor (PMF) is defined as the ratio of the field readings for a CW and a modulated signal with the equivalent Field Envelope Peak as defined in ANSI C63.19 (Chapter C.3.1). Calibration shall be made of the modulation response of the probe and its instrumentation chain. This Calibration shall be performed with the field probe, attached to the instrumentation that is to be used with it during the measurement. The response of the probe system to a CW field at the frequency(s) of interest is compared to its response to a modulated signal with equal peak amplitude. The field level of the test signals shall be more than 10dB above the ambient level and the noise floor of the instrumentation being used. The ratio of the CW reading to that taken with a modulated field shall be applied to the readings taken of modulated fields of the specified type.

9.1 Modulation Factor Test Procedure

This may be done using the following procedure:

1. Fix the field probe in a set location relative to a field generating device, such as the reference dipole antenna, as illustrated in Figure 6.
2. Illuminate the probe using the wireless device connected to the reference dipole with a test signal at the intended measurement frequency, Ensure there is sufficient field coupling between the probe and the antenna so the resulting reading is greater than 10 dB above the probe system noise floor but within the systems operating range.
3. Record the amplitude applied to the antenna during transmission and the field strength measured by the E-field probe located near the tip of the dipole antenna
4. Replace the wireless device with an RF signal generator producing an unmodulated CW signal and set to the wireless device operating frequency.
5. Set the amplitude of the unmodulated signal to equal that recorded from the wireless device.
6. Record the reading of the probe measurement system of the unmodulated signal.
7. The ratio, in linear units, of the probe reading in Step 6) to the reading in Step 3) is the E-field modulation factor. $PMF_E = E_{CW} / E_{mod}$ ($PMF_H = H_{CW} / H_{mod}$)
8. Repeat the previous steps using the H-field probe, except locate the probe at the center of the dipole.

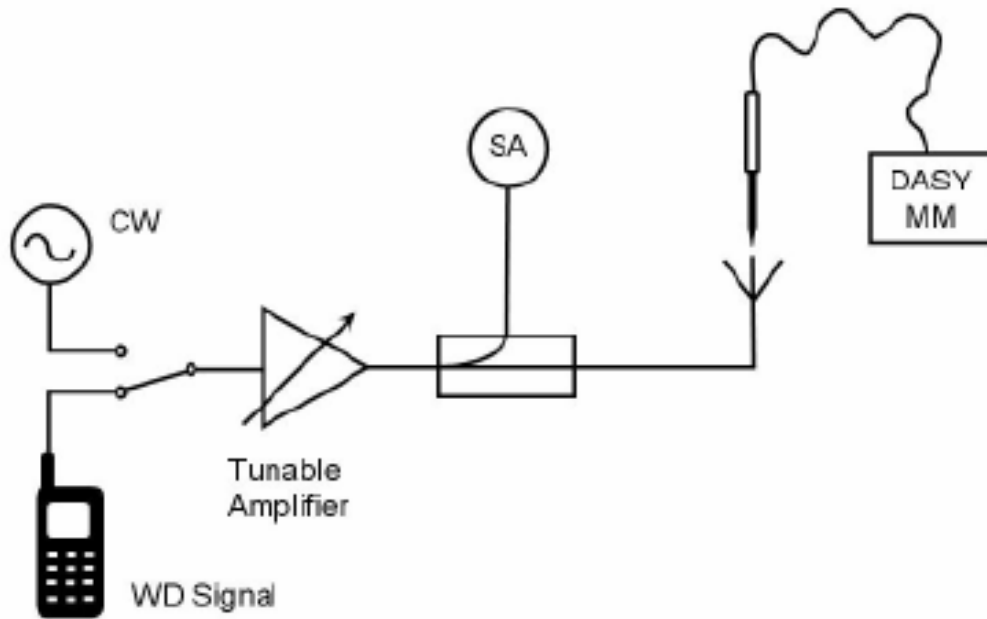

Fig. 5 Probe Modulation Factor Test Setup

9.2 Modulation Factor

9.2.1 E-Field

Frequency (MHz)	Mode	Input Power (mW)	E-Field Measured Value (V/m)	Probe Modulation Factor
835	CW	100	169.4	\
	WCDMA	100	168.6	1.005
	GSM	100	58.9	2.874
1880	CW	100	141.2	\
	WCDMA	100	140.4	1.006
	GSM	100	49.0	2.882

9.2.2 H-Field

Frequency (MHz)	Mode	Input Power (mW)	H-Field Measured Value (A/m)	Probe Modulation Factor
835	CW	100	0.468	\
	WCDMA	100	0.456	1.005
	GSM	100	0.163	2.874
1880	CW	100	0.454	\
	WCDMA	100	0.453	1.003
	GSM	100	0.158	2.865

10 RF TEST PROCEDURES

The evaluation was performed with the following procedure:

- 1) Confirm proper operation of the field probe, probe measurement system and other instrumentation and the positioning system.
- 2) Position the WD in its intended test position. The gauge block can simplify this positioning. Note that a separate E-field and H-field gauge block will be needed if the center of the probe sensor elements are at different distances from the tip of the probe.
- 3) Configure the WD normal operation for maximum rated RF output power, at the desired channel and other operating parameters (e.g., test mode), as intended for the test.
- 4) The center sub-grid shall be centered on the center of the T-Coil mode axial measurement point or the acoustic output, as appropriate. Locate the field probe at the initial test position in the 50 mm by 50 mm grid, which is contained in the measurement plane. If the field alignment method is used, align the probe for maximum field reception.
- 5) Record the reading.
- 6) Scan the entire 50 mm by 50 mm region in equally spaced increments and record the reading at each measurement point. The distance between measurement points shall be sufficient to assure the identification of the maximum reading.
- 7) Identify the five contiguous sub-grids around the center sub-grid with the lowest maximum field strength readings. Thus the six areas to be used to determine the WD's highest emissions are identified and outlined for the final manual scan. Please note that a maximum of five blocks can be excluded for both E-field and H-field measurements for the WD output being measured. Stated another way, the center sub-grid and three others must be common to both the E-field and H-field measurements.
- 8) Identify the maximum field reading within the non-excluded sub-grids identified in Step 7)
- 9) Convert the maximum field strength reading identified in Step 8) to V/m or A/m, as appropriate. For probes which require a probe modulation factor, this conversion shall be done using the appropriate probe modulation factor and the calibration.
- 10) Repeat Step 1) through Step 10) for both the E-field and H-field measurements.
- 11) Compare this reading to the categories in ANSI C63.19 Clause 7 and record the resulting category. The lowest category number listed in 7.2, Table 7.4, or Table 7.5 obtained in Step 10) for either E- or H-field determines the M category for the audio coupling mode assessment. Record the WD category rating.

11 HAC RF TEST DATA SUMMARY

11.1 Measurement Results (E-Field)

Frequency		AWF	Measured Value (V/m)	Power Drift (dB)	Category
MHz	Channel				
GSM 850					
848.8	251	-5	146.4	0.05	M4 (see Fig B.1)
836.6	190	-5	129.9	0.01	M4 (see Fig B.2)
824.2	128	-5	104.8	-0.02	M4 (see Fig B.3)
GSM 1900					
1909.8	810	-5	54.75	-0.15	M3 (see Fig B.4)
1880	661	-5	61.64	0.13	M3 (see Fig B.5)
1850.2	512	-5	64.58	-0.01	M3 (see Fig B.6)
WCDMA 850					
846.6	4458	0	39.49	0.01	M4 (see Fig B.7)
836.4	4407	0	39.40	0.01	M4 (see Fig B.8)
826.4	4357	0	33.56	-0.00	M4 (see Fig B.9)
WCDMA 1900					
1907.6	9538	0	27.16	0.11	M4 (see Fig B.10)
1880	9400	0	29.02	0.07	M4 (see Fig B.11)
1852.4	9262	0	30.15	-0.12	M4 (see Fig B.12)

11.2 Measurement Results (H-Field)

Frequency		AWF	Measured Value (A/m)	Power Drift (dB)	Category
MHz	Channel				
GSM 850					
848.8	251	-5	0.1997	0.04	M4 (see Fig B.13)
836.6	190	-5	0.1619	0.13	M4 (see Fig B.14)
824.2	128	-5	0.1324	-0.00	M4 (see Fig B.15)
GSM 1900					
1909.8	810	-5	0.1884	0.04	M3 (see Fig B.16)
1880	661	-5	0.1965	0.01	M3 (see Fig B.17)
1850.2	512	-5	0.1961	-0.06	M4 (see Fig B.18)
WCDMA 850					
846.6	4458	0	0.05549	0.05	M4 (see Fig B.19)
836.4	4407	0	0.05393	-0.14	M4 (see Fig B.20)
826.4	4357	0	0.04518	-0.11	M4 (see Fig B.21)
WCDMA 1900					
1907.6	9538	0	0.08113	0.07	M4 (see Fig B.22)
1880	9400	0	0.08418	0.03	M4 (see Fig B.23)
1852.4	9262	0	0.08230	-0.05	M4 (see Fig B.24)

11.3 Total M-rating

Mode	Maximum value of peak Total E-Field (V/m)	Maximum value of peak Total H-Field (A/m)	E-Field M Rating	H-Field M Rating	Total M Rating
GSM 850	146.4	0.1997	M4 (AWF -5 dB)	M4 (AWF -5 dB)	M4 (see Fig B.25)
GSM 1900	64.58	0.1965	M4 (AWF -5 dB)	M3 (AWF -5 dB)	M3 (see Fig B.26)
WCDMA 850	39.49	0.05549	M4 (AWF -5 dB)	M4 (AWF -5 dB)	M4 (see Fig B.27)
WCDMA 1900	30.15	0.08418	M4 (AWF -5 dB)	M4 (AWF -5 dB)	M4 (see Fig B.28)

12 ANSI C 63.19-2007 LIMITS

AWF: Articulation Weighting Factor

Standard	Technology	AWF
TIA/EIA/IS-2000	CDMA	0
TIA/EIA-136	TDMA (50 Hz)	0
J-STD-007	GSM (217 Hz)	-5
T1/T1P1/3GPP	UMTS (WCDMA)	0
iDEN	TDMA (22 Hz and 11 Hz)	0

Table 1: Telephone near-field categories in linear units

Category		Telephone RF parameters < 960 MHz			
Near field	AWF	E-field emissions		H-field emissions	
Category M1	0	631.0 to 1122.0	V/m	1.91 to 3.39	A/m
	-5	473.2 to 841.4	V/m	1.43 to 2.54	A/m
Category M2	0	354.8 to 631.0	V/m	1.07 to 1.91	A/m
	-5	266.1 to 473.2	V/m	0.80 to 1.43	A/m
Category M3	0	199.5 to 354.8	V/m	0.60 to 1.07	A/m
	-5	149.6 to 266.1	V/m	0.45 to 0.80	A/m
Category M4	0	< 199.5	V/m	< 0.60	A/m
	-5	< 149.6	V/m	< 0.45	A/m
Category		Telephone RF parameters > 960 MHz			
Near field	AWF	E-field emissions		H-field emissions	
Category M1	0	199.5 to 354.8	V/m	0.60 to 1.07	A/m
	-5	149.6 to 266.1	V/m	0.45 to 0.80	A/m
Category M2	0	112.2 to 199.5	V/m	0.34 to 0.60	A/m
	-5	84.1 to 149.6	V/m	0.25 to 0.45	A/m

Category M3	0	63.1 to 112.2	V/m	0.19 to 0.34	A/m
	-5	47.3 to 84.1	V/m	0.14 to 0.25	A/m
Category M4	0	< 63.1	V/m	< 0.19	A/m
	-5	< 47.3	V/m	< 0.14	A/m

13 MEASUREMENT UNCERTAINTY

No.	Error source	Type	Uncertainty Value (%)	Prob. Dist.	k	c_i E	c_i H	Standard Uncertainty (%) u_i (%) E	Standard Uncertainty (%) u_i (%) H	Degree of freedom V_{eff} or ν_i
Measurement System										
1	Probe Calibration	B	5.	N	1	1	1	5.1	5.1	∞
2	Axial Isotropy	B	4.7	R	$\sqrt{3}$	1	1	2.7	2.7	∞
3	Sensor Displacement	B	16.5	R	$\sqrt{3}$	1	0.145	9.5	1.4	∞
4	Boundary Effects	B	2.4	R	$\sqrt{3}$	1	1	1.4	1.4	∞
5	Linearity	B	4.7	R	$\sqrt{3}$	1	1	2.7	2.7	∞
6	Scaling to Peak Envelope Power	B	2.0	R	$\sqrt{3}$	1	1	1.2	1.2	∞
7	System Detection Limit	B	1.0	R	$\sqrt{3}$	1	1	0.6	0.6	∞
8	Readout Electronics	B	0.3	N	1	1	1	0.3	0.3	∞
9	Response Time	B	0.8	R	$\sqrt{3}$	1	1	0.5	0.5	∞
10	Integration Time	B	2.6	R	$\sqrt{3}$	1	1	1.5	1.5	∞
11	RF Ambient Conditions	B	3.0	R	$\sqrt{3}$	1	1	1.7	1.7	∞
12	RF Reflections	B	12.0	R	$\sqrt{3}$	1	1	6.9	6.9	∞
13	Probe Positioner	B	1.2	R	$\sqrt{3}$	1	0.67	0.7	0.5	∞
14	Probe Positioning	A	4.7	R	$\sqrt{3}$	1	0.67	2.7	1.8	∞
15	Extra. And Interpolation	B	1.0	R	$\sqrt{3}$	1	1	0.6	0.6	∞
Test Sample Related										
16	Device Positioning Vertical	B	4.7	R	$\sqrt{3}$	1	0.67	2.7	1.8	∞

17	Device Positioning Lateral	B	1.0	R	$\sqrt{3}$	1	1	0.6	0.6	∞
18	Device Holder and Phantom	B	2.4	R	$\sqrt{3}$	1	1	1.4	1.4	∞
19	Power Drift	B	5.0	R	$\sqrt{3}$	1	1	2.9	2.9	∞
Phantom and Setup related										
20s	Phantom Thickness	B	2.4	R	$\sqrt{3}$	1	0.67	1.4	0.9	∞
Combined standard uncertainty(%)								14.7	10.9	
Expanded uncertainty (confidence interval of 95 %)		$u_e = 2u_c$		N	k=2			29.4	21.8	

14 MAIN TEST INSTRUMENTS

Table 2: List of Main Instruments

No.	Name	Type	Serial Number	Calibration Date	Valid Period
01	Signal Generator	E4438C	MY49071430	February 10, 2014	One Year
02	Power meter	NRVD	102196	March 15, 2013	One year
03	Power sensor	NRV-Z5	100596		
04	Amplifier	60S1G4	0331848	No Calibration Requested	
05	E-Field Probe	ER3DV6	2428	January 27, 2014	One year
06	H-Field Probe	H3DV6	6260	January 27, 2014	One year
07	HAC Dipole	CD835V3	1156	September 02, 2013	One year
08	HAC Dipole	CD1880V3	1140	September 02, 2013	One year
09	BTS	E5515C	MY50263375	January 30, 2014	One year
10	DAE	SPEAG DAE4	777	February 22, 2013	One year

15 CONCLUSION

The HAC measurement indicates that the EUT complies with the HAC limits of the ANSI C63.19-2007. The total M-ratings are **M3**.

END OF REPORT BODY

ANNEX A TEST LAYOUT



Picture A1: HAC RF System Layout

ANNEX B TEST PLOTS

HAC RF E-Field GSM 850 High

Date: 2014-2-12

Electronics: DAE4 Sn777

Medium: Air

Medium parameters used: $\sigma = 0$ mho/m, $\epsilon_r = 1$; $\rho = 1000$ kg/m³

Ambient Temperature: 22.6°C

Communication System: GSM 850; Frequency: 848.8 MHz; Duty Cycle: 1:8.3

Probe: ER3DV6 - SN2428; ConvF(1, 1, 1)

E Scan - ER3DV6 - 2007: 15 mm from Probe Center to the Device/Hearing Aid Compatibility Test (101x101x1): Interpolated grid: dx=0.5000 mm, dy=0.5000 mm

Device Reference Point: 0, 0, -6.3 mm

Reference Value = 60.25 V/m; Power Drift = 0.05 dB

PMR not calibrated. PMF = 2.874 is applied.

E-field emissions = 146.4 V/m

Near-field category: M4 (AWF -5 dB)

PMF scaled E-field

Grid 1 M4 116.6 V/m	Grid 2 M4 138.3 V/m	Grid 3 M4 138.2 V/m
Grid 4 M4 124.2 V/m	Grid 5 M4 146.4 V/m	Grid 6 M4 146.1 V/m
Grid 7 M4 134.7 V/m	Grid 8 M4 149.4 V/m	Grid 9 M4 147.2 V/m

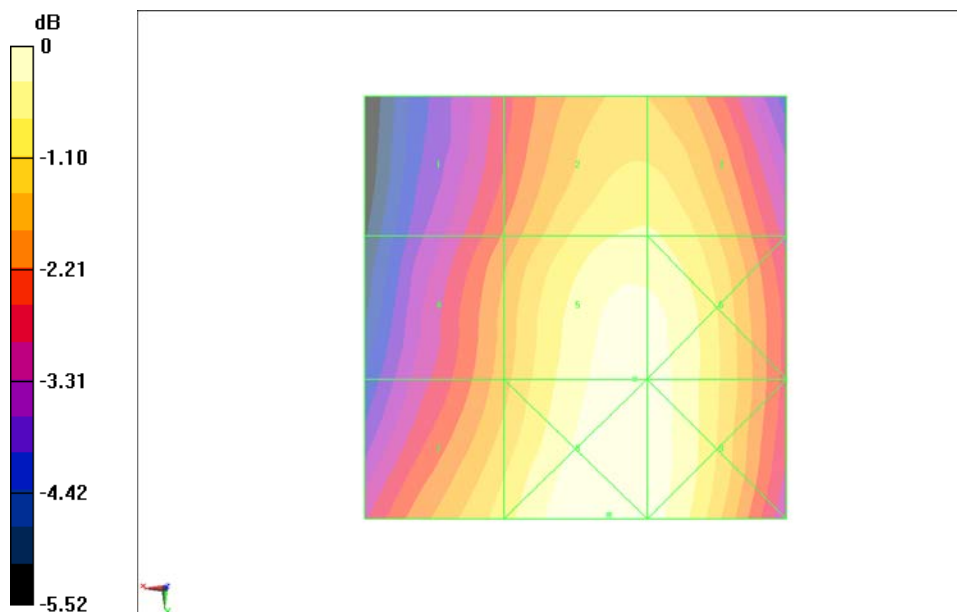

0 dB = 149.4 V/m = 43.49 dBV/m

Fig B.1 HAC RF E-Field GSM 850 High

HAC RF E-Field GSM 850 Middle

Date: 2014-2-12

Electronics: DAE4 Sn777

Medium: Air

Medium parameters used: $\sigma = 0$ mho/m, $\epsilon_r = 1$; $\rho = 1000$ kg/m³

Ambient Temperature: 22.6°C

Communication System: GSM 850; Frequency: 836.6 MHz; Duty Cycle: 1:8.3

Probe: ER3DV6 - SN2428; ConvF(1, 1, 1)

E Scan - ER3DV6 - 2007: 15 mm from Probe Center to the Device 2/Hearing Aid

Compatibility Test (101x101x1): Interpolated grid: dx=0.5000 mm, dy=0.5000 mm

Device Reference Point: 0, 0, -6.3 mm

Reference Value = 53.74 V/m; Power Drift = 0.01 dB

PMR not calibrated. PMF = 2.874 is applied.

E-field emissions = 129.9 V/m

Near-field category: M4 (AWF -5 dB)

PMF scaled E-field

Grid 1 M4 104.4 V/m	Grid 2 M4 122.9 V/m	Grid 3 M4 122.8 V/m
Grid 4 M4 111.3 V/m	Grid 5 M4 129.9 V/m	Grid 6 M4 129.5 V/m
Grid 7 M4 120.7 V/m	Grid 8 M4 132.4 V/m	Grid 9 M4 130.8 V/m

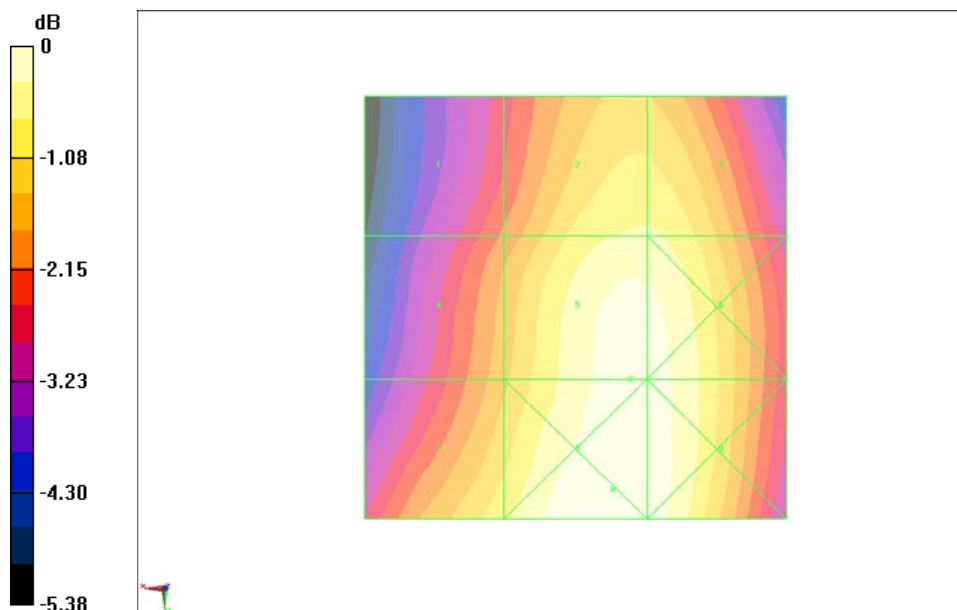

0 dB = 132.4 V/m = 42.44 dBV/m

Fig B.2 HAC RF E-Field GSM 850 Middle

HAC RF E-Field GSM 850 Low

Date: 2014-2-12

Electronics: DAE4 Sn777

Medium: Air

Medium parameters used: $\sigma = 0$ mho/m, $\epsilon_r = 1$; $\rho = 1000$ kg/m³

Ambient Temperature: 22.6°C

Communication System: GSM 850; Frequency: 824.2 MHz; Duty Cycle: 1:8.3

Probe: ER3DV6 - SN2428; ConvF(1, 1, 1)

E Scan - ER3DV6 - 2007: 15 mm from Probe Center to the Device 3/Hearing Aid Compatibility Test (101x101x1): Interpolated grid: dx=0.5000 mm, dy=0.5000 mm

Device Reference Point: 0, 0, -6.3 mm

Reference Value = 43.60 V/m; Power Drift = -0.02 dB

PMR not calibrated. PMF = 2.874 is applied.

E-field emissions = 104.8 V/m

Near-field category: M4 (AWF -5 dB)

PMF scaled E-field

Grid 1 M4 85.18 V/m	Grid 2 M4 99.83 V/m	Grid 3 M4 99.55 V/m
Grid 4 M4 90.06 V/m	Grid 5 M4 104.8 V/m	Grid 6 M4 104.6 V/m
Grid 7 M4 97.85 V/m	Grid 8 M4 107.5 V/m	Grid 9 M4 105.3 V/m

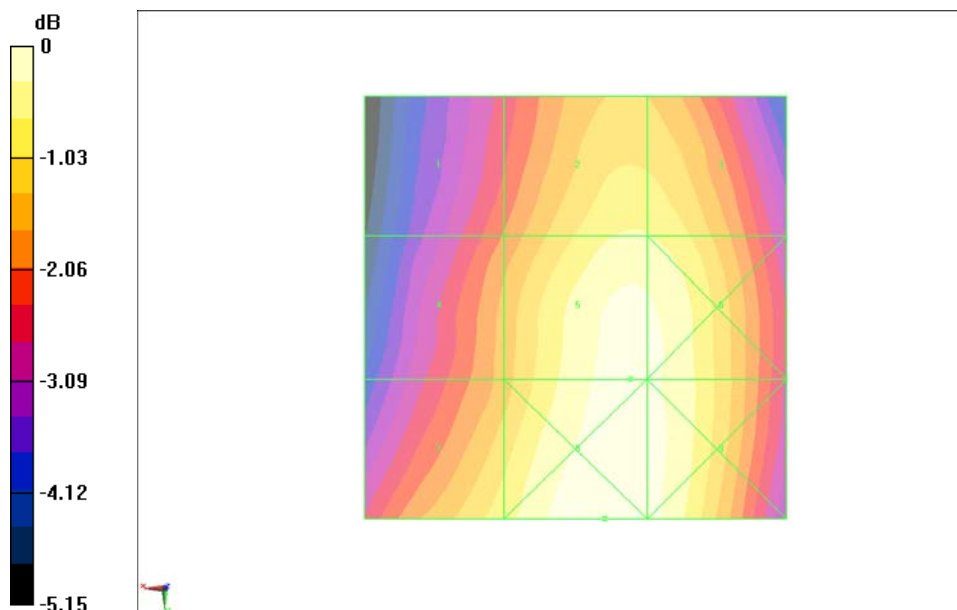

0 dB = 107.5 V/m = 40.63 dBV/m

Fig B.3 HAC RF E-Field GSM 850 Low

HAC RF E-Field GSM 1900 High

Date: 2014-2-12

Electronics: DAE4 Sn777

Medium: Air

Medium parameters used: $\sigma = 0$ mho/m, $\epsilon_r = 1$; $\rho = 1000$ kg/m³

Ambient Temperature: 22.6°C

Communication System: DCS 1900; Frequency: 1909.8 MHz; Duty Cycle: 1:8.3

Probe: ER3DV6 - SN2428; ConvF(1, 1, 1)

E Scan - ER3DV6 - 2007: 15 mm from Probe Center to the Device/Hearing Aid Compatibility Test (101x101x1): Interpolated grid: dx=0.5000 mm, dy=0.5000 mm

Device Reference Point: 0, 0, -6.3 mm

Reference Value = 5.161 V/m; Power Drift = -0.15 dB

PMR not calibrated. PMF = 2.882 is applied.

E-field emissions = 54.75 V/m

Near-field category: M3 (AWF -5 dB)

PMF scaled E-field

Grid 1 M4 44.65 V/m	Grid 2 M3 62.79 V/m	Grid 3 M3 62.79 V/m
Grid 4 M4 20.14 V/m	Grid 5 M4 32.68 V/m	Grid 6 M4 34.92 V/m
Grid 7 M3 47.57 V/m	Grid 8 M3 54.75 V/m	Grid 9 M3 53.76 V/m

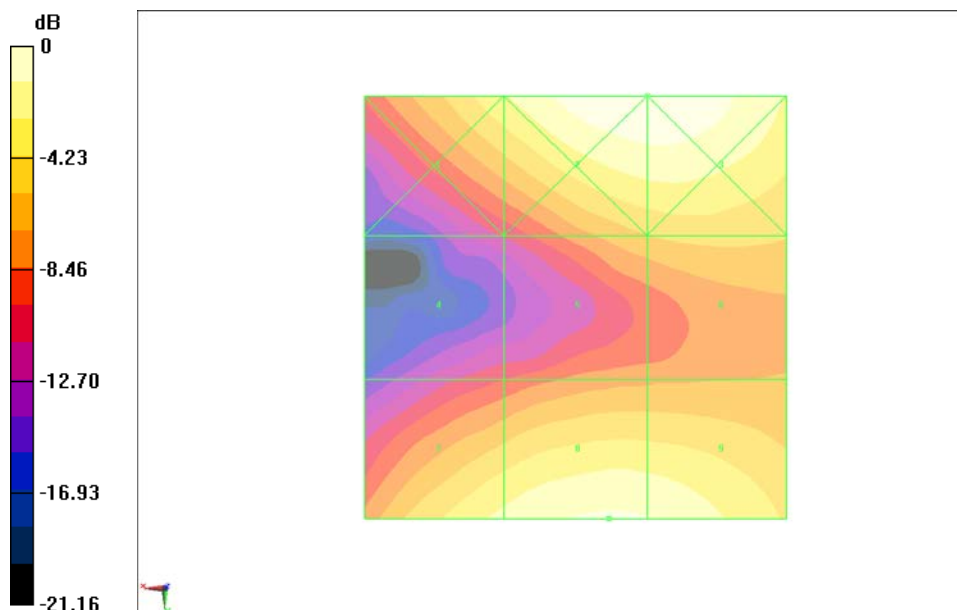

0 dB = 62.79 V/m = 35.96 dBV/m

Fig B.4 HAC RF E-Field GSM 1900 High

HAC RF E-Field GSM 1900 Middle

Date: 2014-2-12

Electronics: DAE4 Sn777

Medium: Air

Medium parameters used: $\sigma = 0$ mho/m, $\epsilon_r = 1$; $\rho = 1000$ kg/m³

Ambient Temperature: 22.6°C

Communication System: DCS 1900; Frequency: 1880 MHz; Duty Cycle: 1:8.3

Probe: ER3DV6 - SN2428; ConvF(1, 1, 1)

E Scan - ER3DV6 - 2007: 15 mm from Probe Center to the Device 2/Hearing Aid Compatibility Test (101x101x1): Interpolated grid: dx=0.5000 mm, dy=0.5000 mm

Device Reference Point: 0, 0, -6.3 mm

Reference Value = 6.357 V/m; Power Drift = 0.13 dB

PMR not calibrated. PMF = 2.882 is applied.

E-field emissions = 61.64 V/m

Near-field category: M3 (AWF -5 dB)

PMF scaled E-field

Grid 1 M3 47.87 V/m	Grid 2 M3 65.94 V/m	Grid 3 M3 65.92 V/m
Grid 4 M4 25.11 V/m	Grid 5 M4 33.22 V/m	Grid 6 M4 37.04 V/m
Grid 7 M3 53.88 V/m	Grid 8 M3 61.64 V/m	Grid 9 M3 60.23 V/m

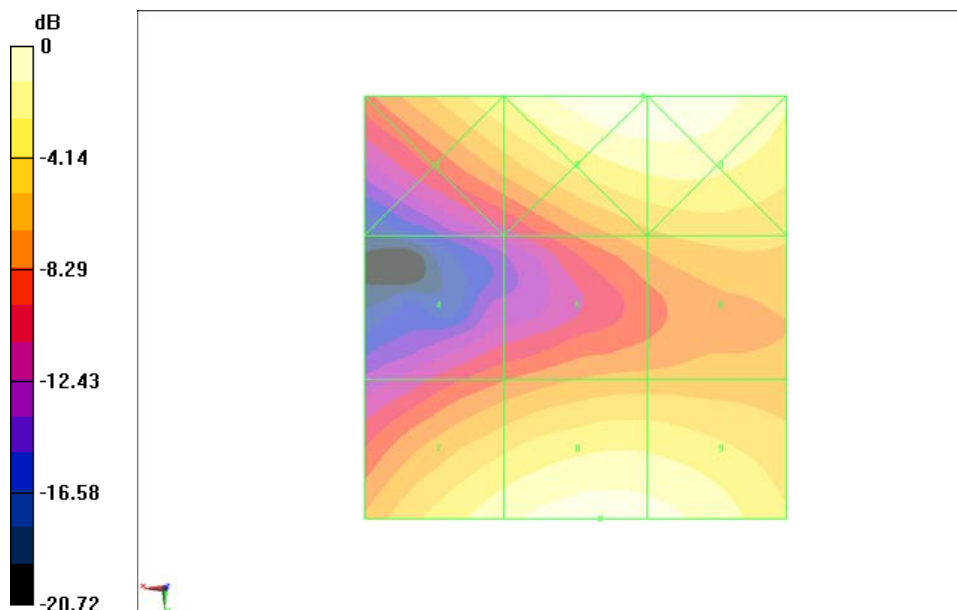

0 dB = 65.94 V/m = 36.38 dBV/m

Fig B.5 HAC RF E-Field GSM 1900 Middle

HAC RF E-Field GSM 1900 Low

Date: 2014-2-12

Electronics: DAE4 Sn777

Medium: Air

Medium parameters used: $\sigma = 0$ mho/m, $\epsilon_r = 1$; $\rho = 1000$ kg/m³

Ambient Temperature: 22.6°C

Communication System: DCS 1900; Frequency: 1850.2 MHz; Duty Cycle: 1:8.3

Probe: ER3DV6 - SN2428; ConvF(1, 1, 1)

E Scan - ER3DV6 - 2007: 15 mm from Probe Center to the Device 3/Hearing Aid Compatibility Test (101x101x1): Interpolated grid: dx=0.5000 mm, dy=0.5000 mm

Device Reference Point: 0, 0, -6.3 mm

Reference Value = 6.735 V/m; Power Drift = -0.01 dB

PMR not calibrated. PMF = 2.882 is applied.

E-field emissions = 64.58 V/m

Near-field category: M3 (AWF -5 dB)

PMF scaled E-field

Grid 1 M3 49.33 V/m	Grid 2 M3 65.48 V/m	Grid 3 M3 65.37 V/m
Grid 4 M4 26.81 V/m	Grid 5 M4 32.54 V/m	Grid 6 M4 34.38 V/m
Grid 7 M3 57.00 V/m	Grid 8 M3 64.58 V/m	Grid 9 M3 62.53 V/m

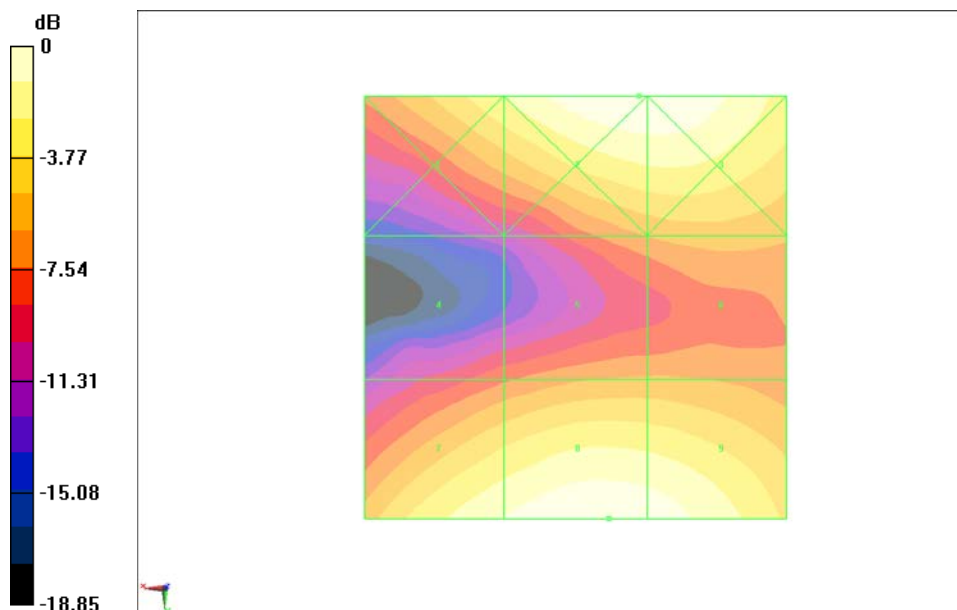

0 dB = 65.48 V/m = 36.32 dBV/m

Fig B.6 HAC RF E-Field GSM 1900 Low

HAC RF E-Field WCDMA 850 High

Date: 2014-2-12

Electronics: DAE4 Sn777

Medium: Air

Medium parameters used: $\sigma = 0$ mho/m, $\epsilon_r = 1$; $\rho = 1000$ kg/m³

Ambient Temperature: 22.6°C

Communication System: WCDMA 850; Frequency: 846.6 MHz; Duty Cycle: 1:1

Probe: ER3DV6 - SN2428; ConvF(1, 1, 1)

E Scan - ER3DV6 - 2007: 15 mm from Probe Center to the Device/Hearing Aid

Compatibility Test (101x101x1): Interpolated grid: dx=0.5000 mm, dy=0.5000 mm

Device Reference Point: 0, 0, -6.3 mm

Reference Value = 46.35 V/m; Power Drift = 0.01 dB

PMR not calibrated. PMF = 1.005 is applied.

E-field emissions = 39.49 V/m

Near-field category: M4 (AWF 0 dB)

PMF scaled E-field

Grid 1 M4 31.10 V/m	Grid 2 M4 37.41 V/m	Grid 3 M4 37.38 V/m
Grid 4 M4 33.04 V/m	Grid 5 M4 39.48 V/m	Grid 6 M4 39.45 V/m
Grid 7 M4 35.63 V/m	Grid 8 M4 40.13 V/m	Grid 9 M4 39.87 V/m

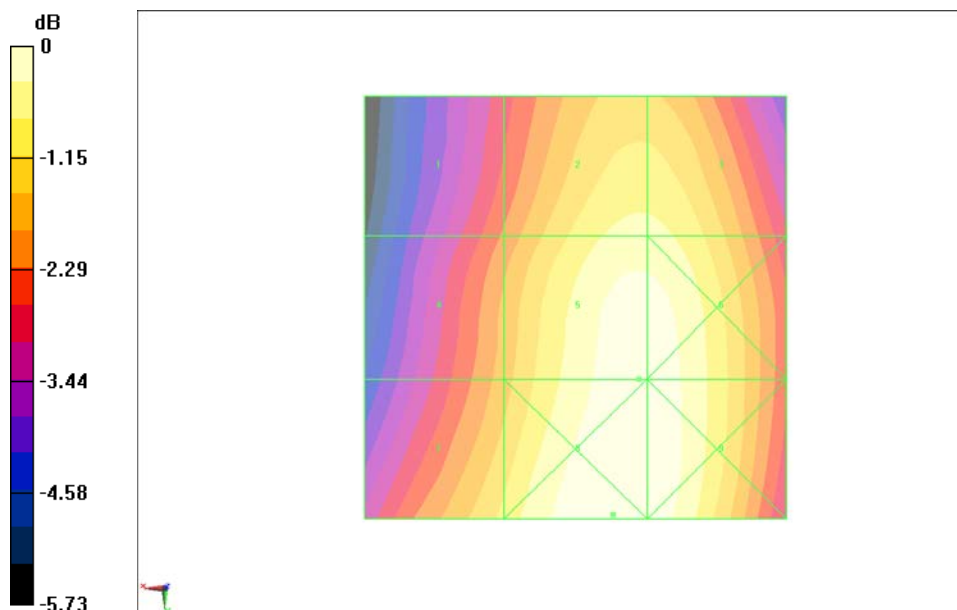

0 dB = 40.13 V/m = 32.07 dBV/m

Fig B.7 HAC RF E-Field WCDMA 850 High

HAC RF E-Field WCDMA 850 Middle

Date: 2014-2-12

Electronics: DAE4 Sn777

Medium: Air

Medium parameters used: $\sigma = 0$ mho/m, $\epsilon_r = 1$; $\rho = 1000$ kg/m³

Ambient Temperature: 22.6°C

Communication System: WCDMA 850; Frequency: 836.4 MHz; Duty Cycle: 1:1

Probe: ER3DV6 - SN2428; ConvF(1, 1, 1)

E Scan - ER3DV6 - 2007: 15 mm from Probe Center to the Device 2/Hearing Aid Compatibility Test (101x101x1): Interpolated grid: dx=0.5000 mm, dy=0.5000 mm

Device Reference Point: 0, 0, -6.3 mm

Reference Value = 46.22 V/m; Power Drift = 0.01 dB

PMR not calibrated. PMF = 1.005 is applied.

E-field emissions = 39.40 V/m

Near-field category: M4 (AWF 0 dB)

PMF scaled E-field

Grid 1 M4 31.00 V/m	Grid 2 M4 37.29 V/m	Grid 3 M4 37.26 V/m
Grid 4 M4 32.98 V/m	Grid 5 M4 39.40 V/m	Grid 6 M4 39.36 V/m
Grid 7 M4 35.65 V/m	Grid 8 M4 40.06 V/m	Grid 9 M4 39.76 V/m

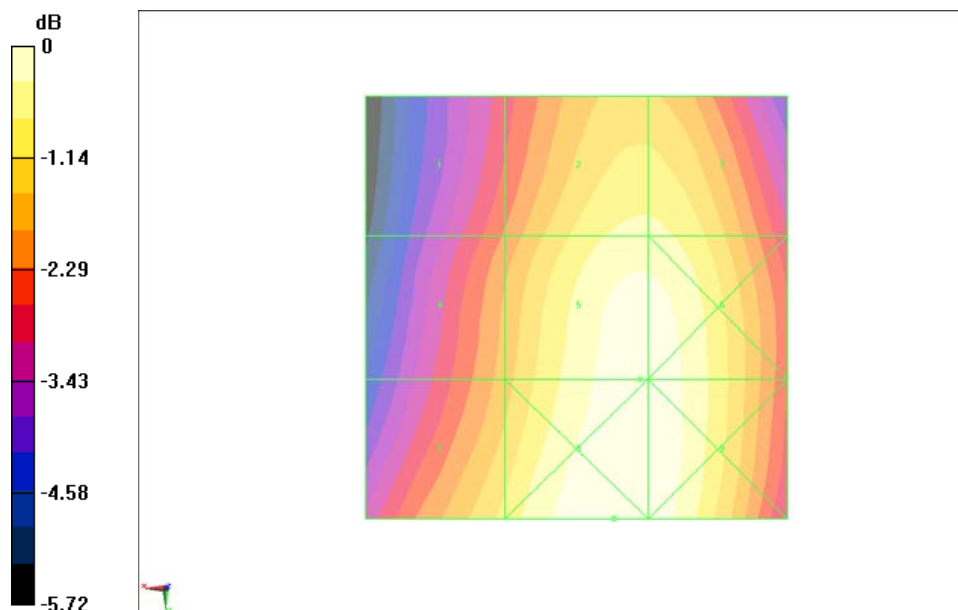

0 dB = 40.06 V/m = 32.05 dBV/m

Fig B.8 HAC RF E-Field WCDMA 850 Middle

HAC RF E-Field WCDMA 850 Low

Date: 2014-2-12

Electronics: DAE4 Sn777

Medium: Air

Medium parameters used: $\sigma = 0$ mho/m, $\epsilon_r = 1$; $\rho = 1000$ kg/m³

Ambient Temperature: 22.6°C

Communication System: WCDMA 850; Frequency: 826.4 MHz; Duty Cycle: 1:1

Probe: ER3DV6 - SN2428; ConvF(1, 1, 1)

E Scan - ER3DV6 - 2007: 15 mm from Probe Center to the Device 3/Hearing Aid Compatibility Test (101x101x1): Interpolated grid: dx=0.5000 mm, dy=0.5000 mm

Device Reference Point: 0, 0, -6.3 mm

Reference Value = 39.53 V/m; Power Drift = -0.00 dB

PMR not calibrated. PMF = 1.005 is applied.

E-field emissions = 33.56 V/m

Near-field category: M4 (AWF 0 dB)

PMF scaled E-field

Grid 1 M4 26.94 V/m	Grid 2 M4 31.96 V/m	Grid 3 M4 31.94 V/m
Grid 4 M4 28.53 V/m	Grid 5 M4 33.56 V/m	Grid 6 M4 33.50 V/m
Grid 7 M4 30.68 V/m	Grid 8 M4 34.10 V/m	Grid 9 M4 33.75 V/m

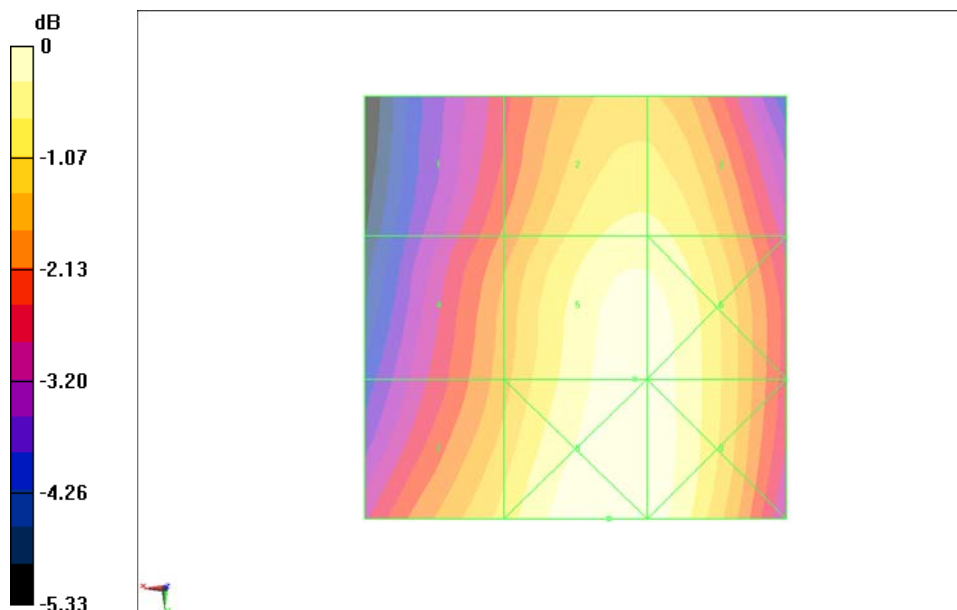

0 dB = 34.10 V/m = 30.66 dBV/m

Fig B.9 HAC RF E-Field WCDMA 850 Low

HAC RF E-Field WCDMA 1900 High

Date: 2014-2-12

Electronics: DAE4 Sn777

Medium: Air

Medium parameters used: $\sigma = 0$ mho/m, $\epsilon_r = 1$; $\rho = 1000$ kg/m³

Ambient Temperature: 22.5°C

Communication System: WCDMA 1900; Frequency: 1907.6 MHz; Duty Cycle: 1:1

Probe: ER3DV6 - SN2428; ConvF(1, 1, 1)

E Scan - ER3DV6 - 2007: 15 mm from Probe Center to the Device/Hearing Aid

Compatibility Test (101x101x1): Interpolated grid: dx=0.5000 mm, dy=0.5000 mm

Device Reference Point: 0, 0, -6.3 mm

Reference Value = 7.268 V/m; Power Drift = 0.11 dB

PMR not calibrated. PMF = 1.006 is applied.

E-field emissions = 27.16 V/m

Near-field category: M4 (AWF 0 dB)

PMF scaled E-field

Grid 1 M4 22.18 V/m	Grid 2 M4 30.31 V/m	Grid 3 M4 30.28 V/m
Grid 4 M4 10.20 V/m	Grid 5 M4 15.73 V/m	Grid 6 M4 17.01 V/m
Grid 7 M4 23.30 V/m	Grid 8 M4 27.16 V/m	Grid 9 M4 26.55 V/m

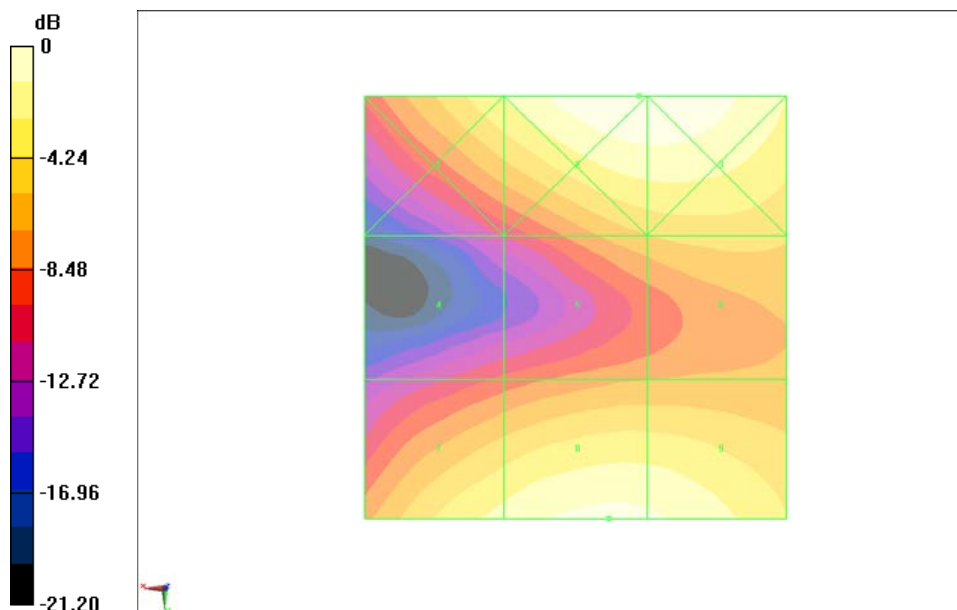

0 dB = 30.31 V/m = 29.63 dBV/m

Fig B.10 HAC RF E-Field WCDMA 1900 High

HAC RF E-Field WCDMA 1900 Middle

Date: 2014-2-12

Electronics: DAE4 Sn777

Medium: Air

Medium parameters used: $\sigma = 0$ mho/m, $\epsilon_r = 1$; $\rho = 1000$ kg/m³

Ambient Temperature: 22.5°C

Communication System: WCDMA 1900; Frequency: 1880 MHz; Duty Cycle: 1:1

Probe: ER3DV6 - SN2428; ConvF(1, 1, 1)

E Scan - ER3DV6 - 2007: 15 mm from Probe Center to the Device 2/Hearing Aid Compatibility Test (101x101x1): Interpolated grid: dx=0.5000 mm, dy=0.5000 mm

Device Reference Point: 0, 0, -6.3 mm

Reference Value = 8.368 V/m; Power Drift = 0.07 dB

PMR not calibrated. PMF = 1.006 is applied.

E-field emissions = 29.02 V/m

Near-field category: M4 (AWF 0 dB)

PMF scaled E-field

Grid 1 M4 23.14 V/m	Grid 2 M4 31.72 V/m	Grid 3 M4 31.71 V/m
Grid 4 M4 11.62 V/m	Grid 5 M4 16.38 V/m	Grid 6 M4 17.71 V/m
Grid 7 M4 24.87 V/m	Grid 8 M4 29.02 V/m	Grid 9 M4 28.48 V/m

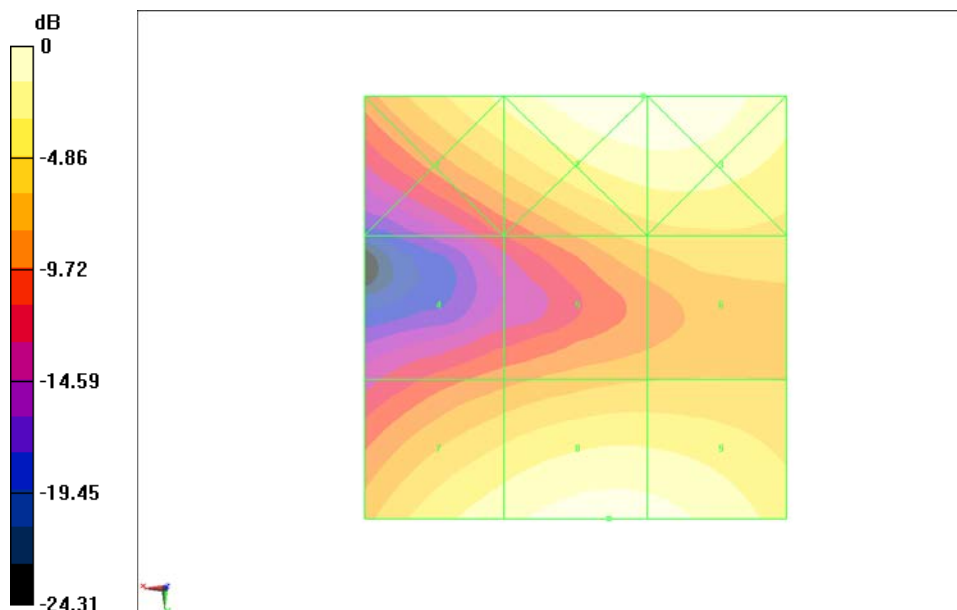

0 dB = 31.72 V/m = 30.03 dBV/m

Fig B.11 HAC RF E-Field WCDMA 1900 Middle

HAC RF E-Field WCDMA 1900 Low

Date: 2014-2-12

Electronics: DAE4 Sn777

Medium: Air

Medium parameters used: $\sigma = 0$ mho/m, $\epsilon_r = 1$; $\rho = 1000$ kg/m³

Ambient Temperature: 22.5°C

Communication System: WCDMA 1900; Frequency: 1852.4 MHz; Duty Cycle: 1:1

Probe: ER3DV6 - SN2428; ConvF(1, 1, 1)

E Scan - ER3DV6 - 2007: 15 mm from Probe Center to the Device 3/Hearing Aid Compatibility Test (101x101x1): Interpolated grid: dx=0.5000 mm, dy=0.5000 mm

Device Reference Point: 0, 0, -6.3 mm

Reference Value = 9.215 V/m; Power Drift = -0.12 dB

PMR not calibrated. PMF = 1.006 is applied.

E-field emissions = 30.15 V/m

Near-field category: M4 (AWF 0 dB)

PMF scaled E-field

Grid 1 M4 24.26 V/m	Grid 2 M4 31.77 V/m	Grid 3 M4 31.67 V/m
Grid 4 M4 11.94 V/m	Grid 5 M4 15.82 V/m	Grid 6 M4 16.83 V/m
Grid 7 M4 26.10 V/m	Grid 8 M4 30.15 V/m	Grid 9 M4 29.43 V/m

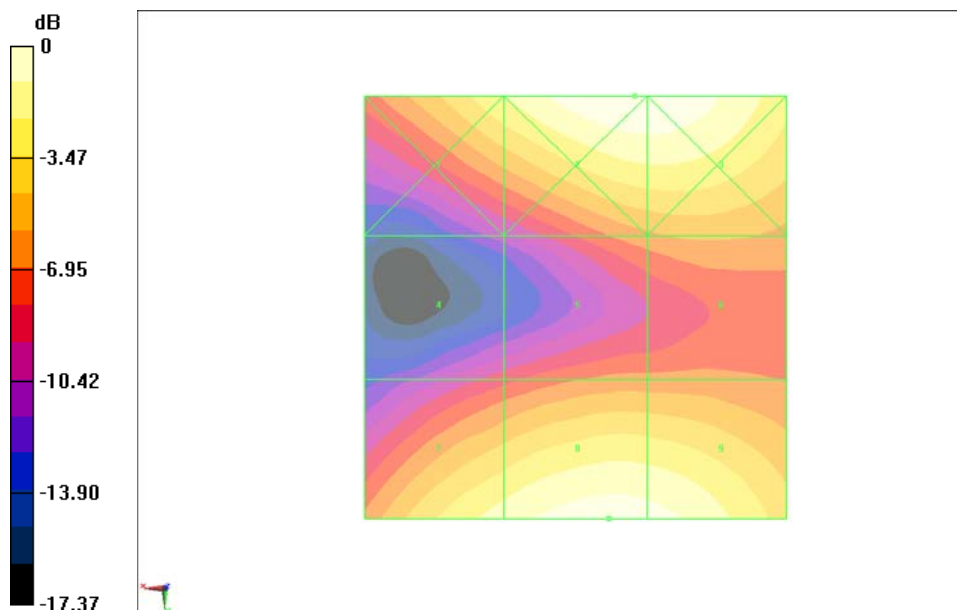

0 dB = 31.77 V/m = 30.04 dBV/m

Fig B.12 HAC RF E-Field WCDMA 1900 Low

HAC RF H-Field GSM 850 High

Date: 2014-2-12

Electronics: DAE4 Sn777

Medium: Air

Medium parameters used: $\sigma = 0$ mho/m, $\epsilon_r = 1$; $\rho = 1$ kg/m³

Ambient Temperature: 22.6°C

Communication System: GSM 850; Frequency: 848.8 MHz; Duty Cycle: 1:8.3

Probe: H3DV6 - SN6260;

H Scan - H3DV6 - 2007: 15 mm from Probe Center to the Device/Hearing Aid

Compatibility Test (101x101x1): Interpolated grid: dx=0.5000 mm, dy=0.5000 mm

Device Reference Point: 0, 0, -6.3 mm

Reference Value = 0.05400 A/m; Power Drift = 0.04 dB

PMR not calibrated. PMF = 2.874 is applied.

H-field emissions = 0.1997 A/m

Near-field category: M4 (AWF -5 dB)

PMF scaled H-field

Grid 1 M4 0.258 A/m	Grid 2 M4 0.200 A/m	Grid 3 M4 0.150 A/m
Grid 4 M4 0.234 A/m	Grid 5 M4 0.179 A/m	Grid 6 M4 0.132 A/m
Grid 7 M4 0.246 A/m	Grid 8 M4 0.178 A/m	Grid 9 M4 0.116 A/m

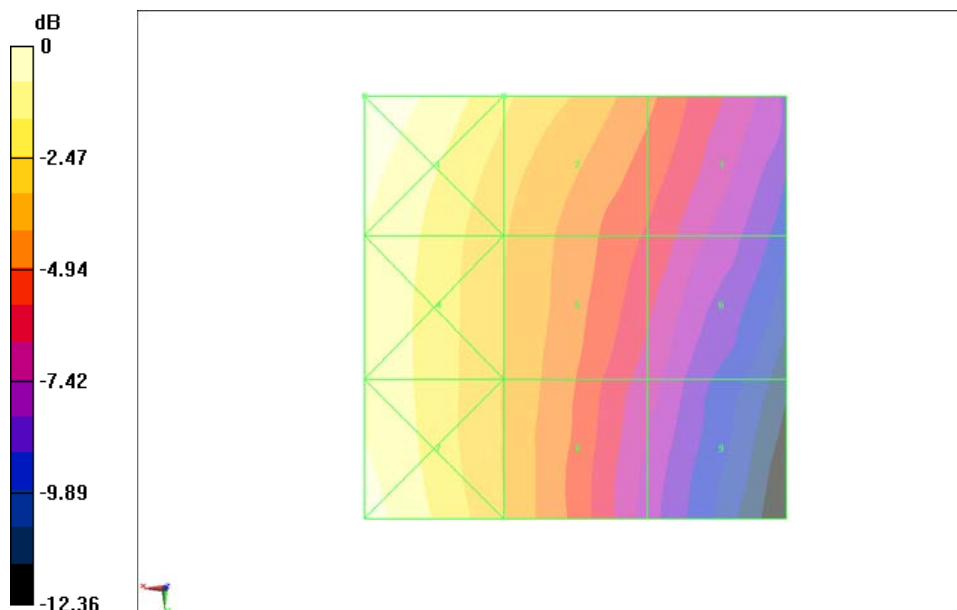

0 dB = 0.2584 A/m = -11.75 dBA/m

Fig B.13 HAC RF H-Field GSM 850 High

HAC RF H-Field GSM 850 Middle

Date: 2014-2-12

Electronics: DAE4 Sn777

Medium: Air

Medium parameters used: $\sigma = 0$ mho/m, $\epsilon_r = 1$; $\rho = 1$ kg/m³

Ambient Temperature: 22.6°C

Communication System: GSM 850; Frequency: 836.6 MHz; Duty Cycle: 1:8.3

Probe: H3DV6 - SN6260;

H Scan - H3DV6 - 2007: 15 mm from Probe Center to the Device 2/Hearing Aid Compatibility Test (101x101x1): Interpolated grid: dx=0.5000 mm, dy=0.5000 mm

Device Reference Point: 0, 0, -6.3 mm

Reference Value = 0.04300 A/m; Power Drift = 0.13 dB

PMR not calibrated. PMF = 2.874 is applied.

H-field emissions = 0.1619 A/m

Near-field category: M4 (AWF -5 dB)

PMF scaled H-field

Grid 1 M4 0.211 A/m	Grid 2 M4 0.162 A/m	Grid 3 M4 0.120 A/m
Grid 4 M4 0.191 A/m	Grid 5 M4 0.146 A/m	Grid 6 M4 0.103 A/m
Grid 7 M4 0.198 A/m	Grid 8 M4 0.143 A/m	Grid 9 M4 0.093 A/m

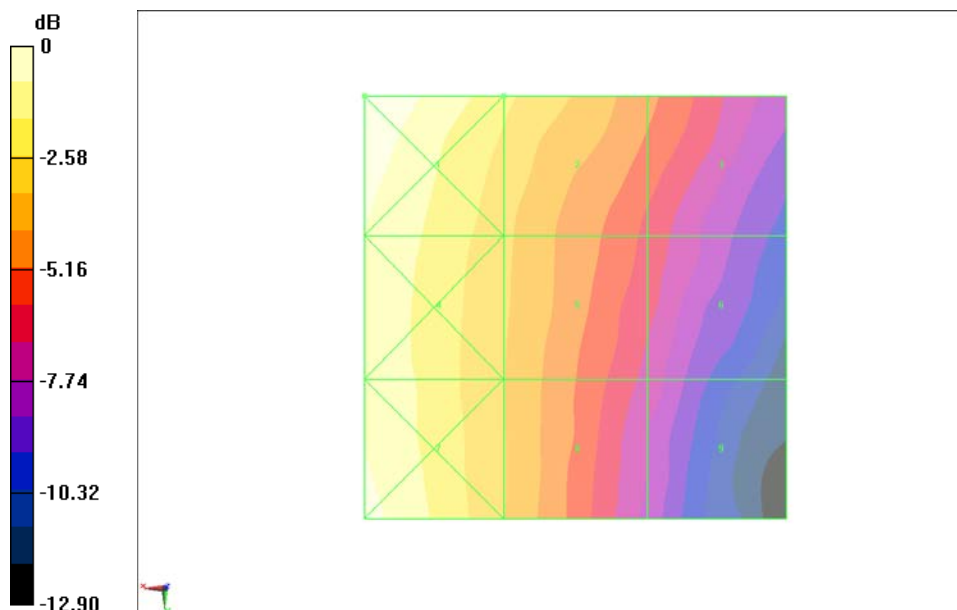

0 dB = 0.2110 A/m = -13.51 dBA/m

Fig B.14 HAC RF H-Field GSM 850 Middle

HAC RF H-Field GSM 850 Low

Date: 2014-2-12

Electronics: DAE4 Sn777

Medium: Air

Medium parameters used: $\sigma = 0$ mho/m, $\epsilon_r = 1$; $\rho = 1$ kg/m³

Ambient Temperature: 22.6°C

Communication System: GSM 850; Frequency: 824.2 MHz; Duty Cycle: 1:8.3

Probe: H3DV6 - SN6260;

H Scan - H3DV6 - 2007: 15 mm from Probe Center to the Device 3/Hearing Aid Compatibility Test (101x101x1): Interpolated grid: dx=0.5000 mm, dy=0.5000 mm

Device Reference Point: 0, 0, -6.3 mm

Reference Value = 0.03500 A/m; Power Drift = -0.00 dB

PMR not calibrated. PMF = 2.874 is applied.

H-field emissions = 0.1324 A/m

Near-field category: M4 (AWF -5 dB)

PMF scaled H-field

Grid 1 M4 0.172 A/m	Grid 2 M4 0.132 A/m	Grid 3 M4 0.098 A/m
Grid 4 M4 0.155 A/m	Grid 5 M4 0.117 A/m	Grid 6 M4 0.084 A/m
Grid 7 M4 0.159 A/m	Grid 8 M4 0.114 A/m	Grid 9 M4 0.073 A/m

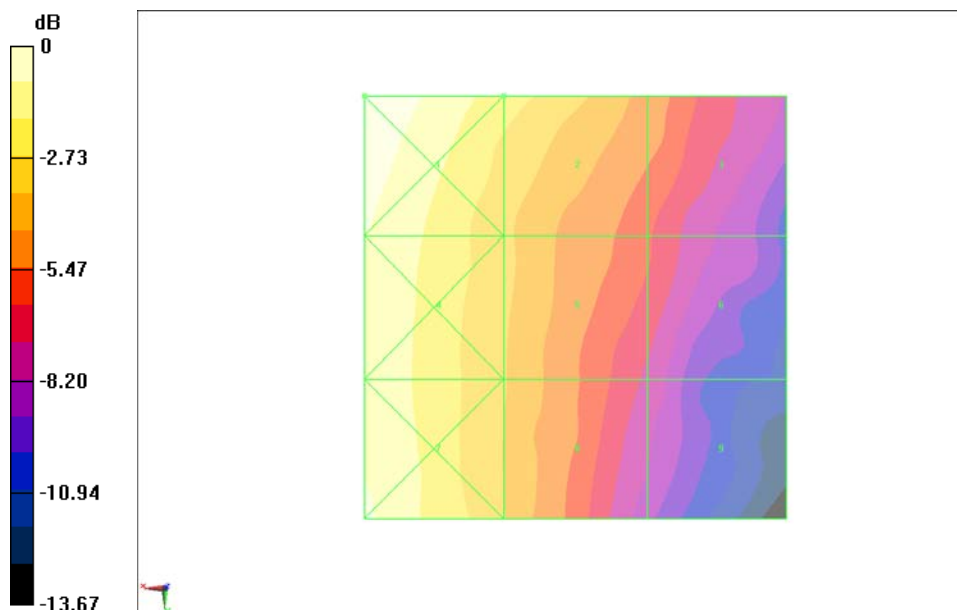

0 dB = 0.1720 A/m = -15.29 dBA/m

Fig B.15 HAC RF H-Field GSM 850 Low

HAC RF H-Field GSM 1900 High

Date: 2014-2-12

Electronics: DAE4 Sn777

Medium: Air

Medium parameters used: $\sigma = 0$ mho/m, $\epsilon_r = 1$; $\rho = 1$ kg/m³

Ambient Temperature: 22.6°C

Communication System: DCS 1900; Frequency: 1909.8 MHz; Duty Cycle: 1:8.3

Probe: H3DV6 - SN6260;

H Scan - H3DV6 - 2007: 15 mm from Probe Center to the Device/Hearing Aid Compatibility Test (101x101x1): Interpolated grid: dx=0.5000 mm, dy=0.5000 mm

Device Reference Point: 0, 0, -6.3 mm

Reference Value = 0.07600 A/m; Power Drift = 0.04 dB

PMR not calibrated. PMF = 2.865 is applied.

H-field emissions = 0.1884 A/m

Near-field category: M3 (AWF -5 dB)

PMF scaled H-field

Grid 1 M3 0.152 A/m	Grid 2 M3 0.182 A/m	Grid 3 M3 0.181 A/m
Grid 4 M4 0.136 A/m	Grid 5 M3 0.188 A/m	Grid 6 M3 0.188 A/m
Grid 7 M4 0.131 A/m	Grid 8 M3 0.182 A/m	Grid 9 M3 0.182 A/m

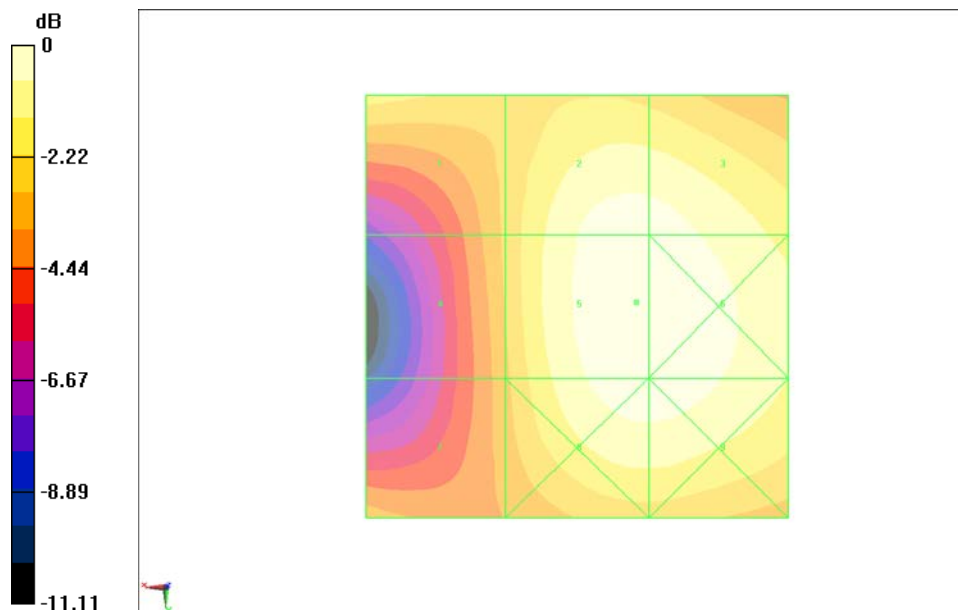

0 dB = 0.1884 A/m = -14.50 dBA/m

Fig B.16 HAC RF H-Field GSM 1900 High

HAC RF H-Field GSM 1900 Middle

Date: 2014-2-12

Electronics: DAE4 Sn777

Medium: Air

Medium parameters used: $\sigma = 0$ mho/m, $\epsilon_r = 1$; $\rho = 1$ kg/m³

Ambient Temperature: 22.6°C

Communication System: DCS 1900; Frequency: 1880 MHz; Duty Cycle: 1:8.3

Probe: H3DV6 - SN6260;

H Scan - H3DV6 - 2007: 15 mm from Probe Center to the Device 2/Hearing Aid Compatibility Test (101x101x1): Interpolated grid: dx=0.5000 mm, dy=0.5000 mm

Device Reference Point: 0, 0, -6.3 mm

Reference Value = 0.08000 A/m; Power Drift = 0.01 dB

PMR not calibrated. PMF = 2.865 is applied.

H-field emissions = 0.1965 A/m

Near-field category: M3 (AWF -5 dB)

PMF scaled H-field

Grid 1 M3 0.152 A/m	Grid 2 M3 0.192 A/m	Grid 3 M3 0.191 A/m
Grid 4 M3 0.148 A/m	Grid 5 M3 0.196 A/m	Grid 6 M3 0.196 A/m
Grid 7 M3 0.140 A/m	Grid 8 M3 0.188 A/m	Grid 9 M3 0.188 A/m

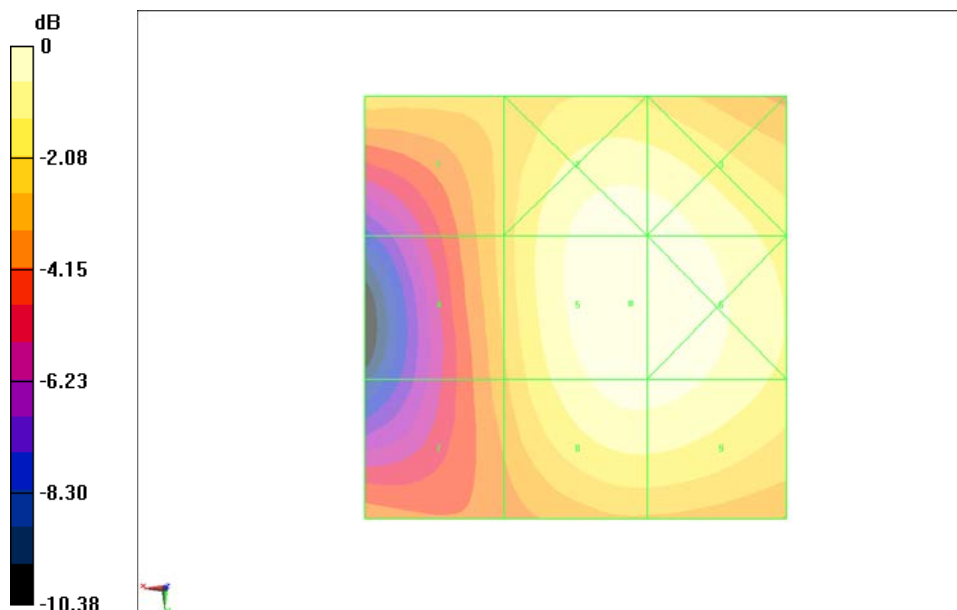

0 dB = 0.1965 A/m = -14.13 dBA/m

Fig B.17 HAC RF H-Field GSM 1900 Middle

HAC RF H-Field GSM 1900 Low

Date: 2014-2-12

Electronics: DAE4 Sn777

Medium: Air

Medium parameters used: $\sigma = 0$ mho/m, $\epsilon_r = 1$; $\rho = 1$ kg/m³

Ambient Temperature: 22.6°C

Communication System: DCS 1900; Frequency: 1850.2 MHz; Duty Cycle: 1:8.3

Probe: H3DV6 - SN6260;

H Scan - H3DV6 - 2007: 15 mm from Probe Center to the Device 3/Hearing Aid Compatibility Test (101x101x1): Interpolated grid: dx=0.5000 mm, dy=0.5000 mm

Device Reference Point: 0, 0, -6.3 mm

Reference Value = 0.07800 A/m; Power Drift = -0.06 dB

PMR not calibrated. PMF = 2.865 is applied.

H-field emissions = 0.1961 A/m

Near-field category: M3 (AWF -5 dB)

PMF scaled H-field

Grid 1 M3 0.153 A/m	Grid 2 M3 0.190 A/m	Grid 3 M3 0.190 A/m
Grid 4 M3 0.141 A/m	Grid 5 M3 0.196 A/m	Grid 6 M3 0.196 A/m
Grid 7 M4 0.138 A/m	Grid 8 M3 0.190 A/m	Grid 9 M3 0.190 A/m

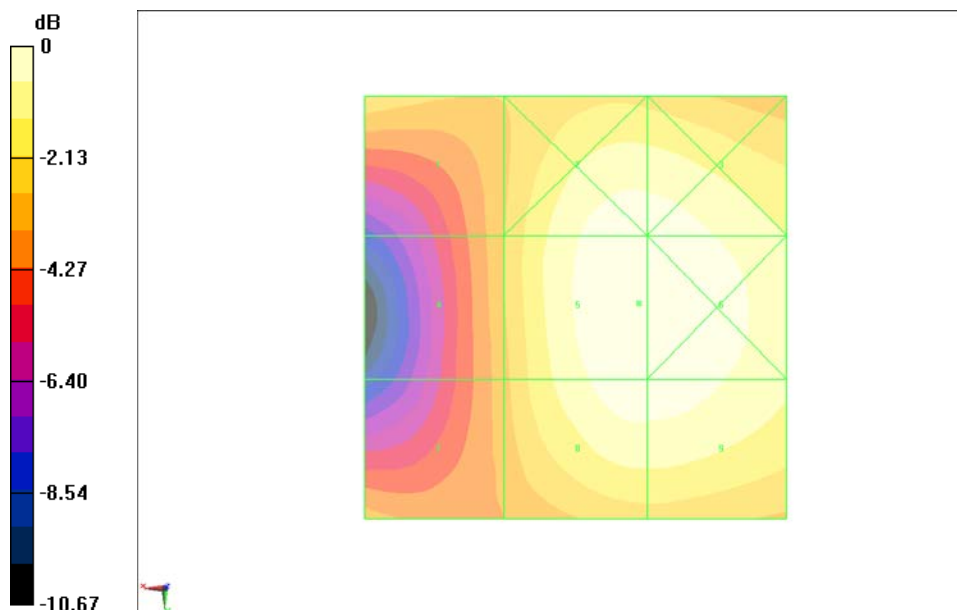

0 dB = 0.1961 A/m = -14.15 dBA/m

Fig B.18 HAC RF H-Field GSM 1900 Low

HAC RF H-Field WCDMA 850 High

Date: 2014-2-12

Electronics: DAE4 Sn777

Medium: Air

Medium parameters used: $\sigma = 0$ mho/m, $\epsilon_r = 1$; $\rho = 1$ kg/m³

Ambient Temperature: 22.6°C

Communication System: WCDMA 850; Frequency: 846.6 MHz; Duty Cycle: 1:1

Probe: H3DV6 - SN6260;

H Scan - H3DV6 - 2007: 15 mm from Probe Center to the Device/Hearing Aid

Compatibility Test (101x101x1): Interpolated grid: dx=0.5000 mm, dy=0.5000 mm

Device Reference Point: 0, 0, -6.3 mm

Reference Value = 0.04300 A/m; Power Drift = 0.05 dB

PMR not calibrated. PMF = 1.005 is applied.

H-field emissions = 0.05549 A/m

Near-field category: M4 (AWF 0 dB)

PMF scaled H-field

Grid 1 M4 0.072 A/m	Grid 2 M4 0.055 A/m	Grid 3 M4 0.042 A/m
Grid 4 M4 0.065 A/m	Grid 5 M4 0.050 A/m	Grid 6 M4 0.036 A/m
Grid 7 M4 0.068 A/m	Grid 8 M4 0.049 A/m	Grid 9 M4 0.032 A/m

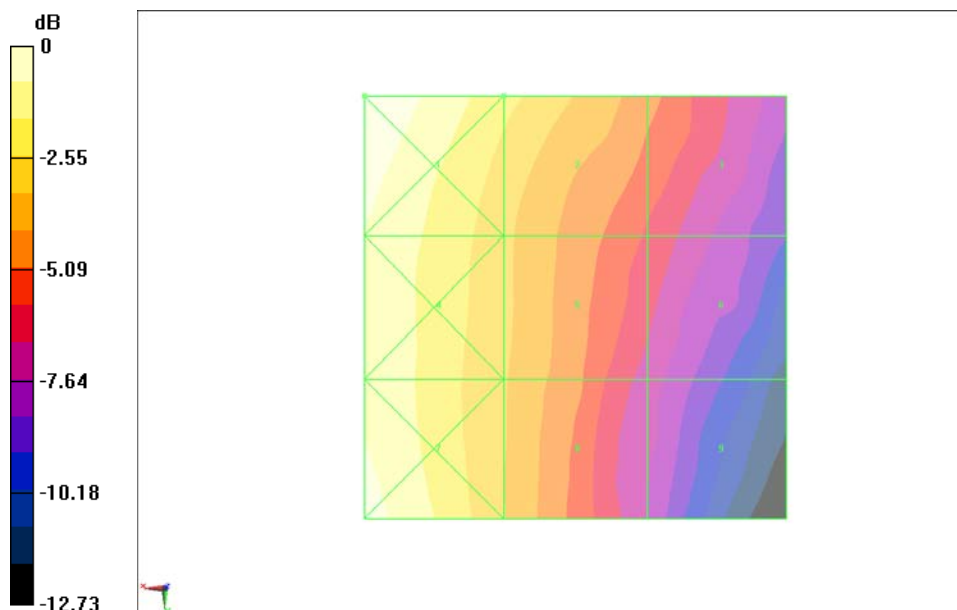

0 dB = 0.07179 A/m = -22.88 dBA/m

Fig B.19 HAC RF H-Field WCDMA 850 High

HAC RF H-Field WCDMA 850 Middle

Date: 2014-2-12

Electronics: DAE4 Sn777

Medium: Air

Medium parameters used: $\sigma = 0$ mho/m, $\epsilon_r = 1$; $\rho = 1$ kg/m³

Ambient Temperature: 22.6°C

Communication System: WCDMA 850; Frequency: 836.4 MHz; Duty Cycle: 1:1

Probe: H3DV6 - SN6260;

H Scan - H3DV6 - 2007: 15 mm from Probe Center to the Device 2/Hearing Aid Compatibility Test (101x101x1): Interpolated grid: dx=0.5000 mm, dy=0.5000 mm

Device Reference Point: 0, 0, -6.3 mm

Reference Value = 0.04100 A/m; Power Drift = -0.14 dB

PMR not calibrated. PMF = 1.005 is applied.

H-field emissions = 0.05393 A/m

Near-field category: M4 (AWF 0 dB)

PMF scaled H-field

Grid 1 M4 0.069 A/m	Grid 2 M4 0.054 A/m	Grid 3 M4 0.039 A/m
Grid 4 M4 0.062 A/m	Grid 5 M4 0.048 A/m	Grid 6 M4 0.034 A/m
Grid 7 M4 0.065 A/m	Grid 8 M4 0.047 A/m	Grid 9 M4 0.030 A/m

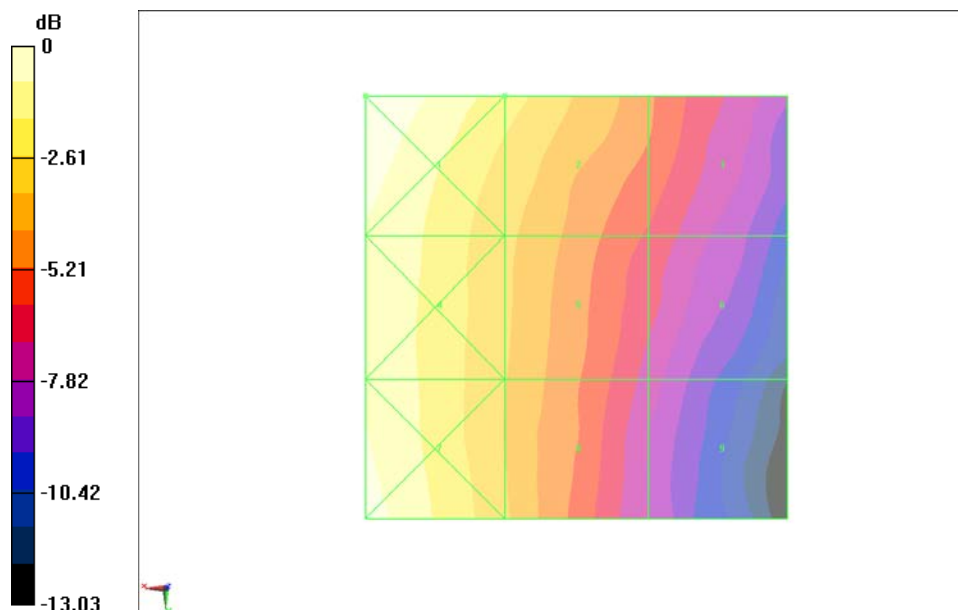

0 dB = 0.06918 A/m = -23.20 dBA/m

Fig B.20 HAC RF H-Field WCDMA 850 Middle

HAC RF H-Field WCDMA 850 Low

Date: 2014-2-12

Electronics: DAE4 Sn777

Medium: Air

Medium parameters used: $\sigma = 0$ mho/m, $\epsilon_r = 1$; $\rho = 1$ kg/m³

Ambient Temperature: 22.6°C

Communication System: WCDMA 850; Frequency: 826.4 MHz; Duty Cycle: 1:1

Probe: H3DV6 - SN6260;

H Scan - H3DV6 - 2007: 15 mm from Probe Center to the Device 3/Hearing Aid Compatibility Test (101x101x1): Interpolated grid: dx=0.5000 mm, dy=0.5000 mm

Device Reference Point: 0, 0, -6.3 mm

Reference Value = 0.03500 A/m; Power Drift = -0.11 dB

PMR not calibrated. PMF = 1.005 is applied.

H-field emissions = 0.04518 A/m

Near-field category: M4 (AWF 0 dB)

PMF scaled H-field

Grid 1 M4 0.059 A/m	Grid 2 M4 0.045 A/m	Grid 3 M4 0.034 A/m
Grid 4 M4 0.052 A/m	Grid 5 M4 0.040 A/m	Grid 6 M4 0.029 A/m
Grid 7 M4 0.054 A/m	Grid 8 M4 0.039 A/m	Grid 9 M4 0.024 A/m

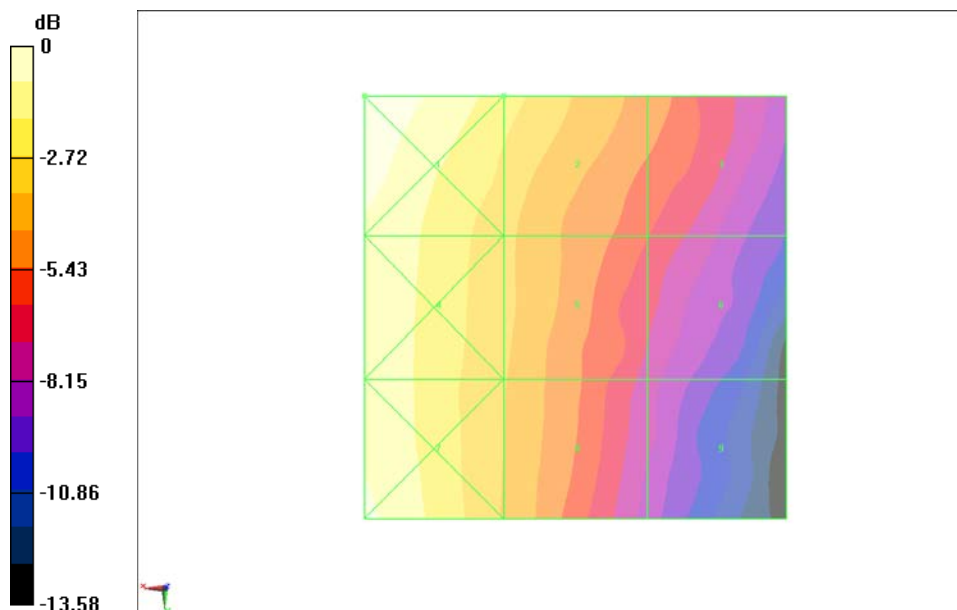

0 dB = 0.05865 A/m = -24.63 dBA/m

Fig B.21 HAC RF H-Field WCDMA 850 Low

HAC RF H-Field WCDMA 1900 High

Date: 2014-2-12

Electronics: DAE4 Sn777

Medium: Air

Medium parameters used: $\sigma = 0$ mho/m, $\epsilon_r = 1$; $\rho = 1$ kg/m³

Ambient Temperature: 22.5°C

Communication System: WCDMA 1900; Frequency: 1907.6 MHz; Duty Cycle: 1:1

Probe: H3DV6 - SN6260;

H Scan - H3DV6 - 2007: 15 mm from Probe Center to the Device/Hearing Aid

Compatibility Test (101x101x1): Interpolated grid: dx=0.5000 mm, dy=0.5000 mm

Device Reference Point: 0, 0, -6.3 mm

Reference Value = 0.09300 A/m; Power Drift = 0.07 dB

PMR not calibrated. PMF = 1.003 is applied.

H-field emissions = 0.08113 A/m

Near-field category: M4 (AWF 0 dB)

PMF scaled H-field

Grid 1 M4 0.067 A/m	Grid 2 M4 0.079 A/m	Grid 3 M4 0.079 A/m
Grid 4 M4 0.059 A/m	Grid 5 M4 0.081 A/m	Grid 6 M4 0.081 A/m
Grid 7 M4 0.057 A/m	Grid 8 M4 0.078 A/m	Grid 9 M4 0.078 A/m

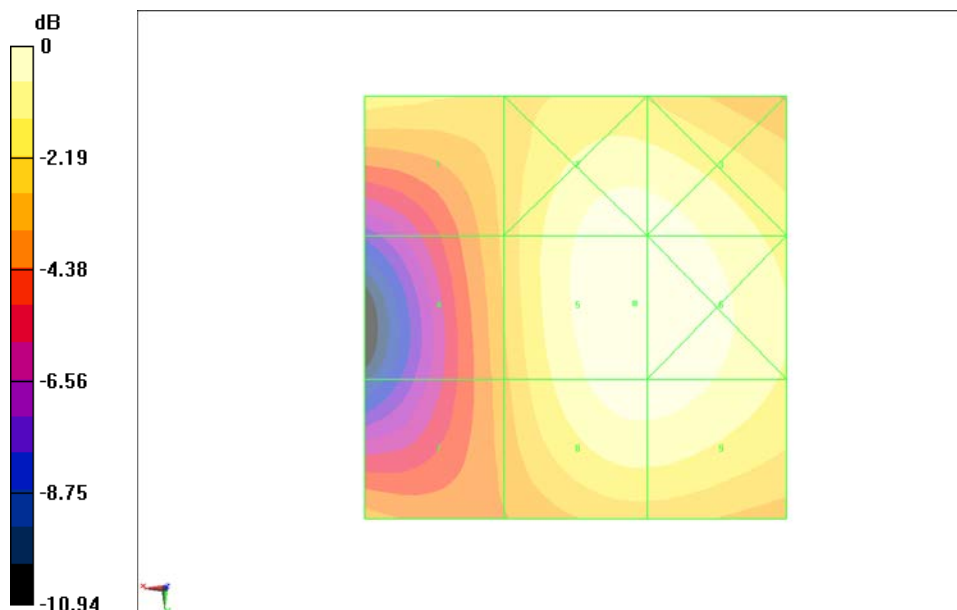

0 dB = 0.08113 A/m = -21.82 dBA/m

Fig B.22 HAC RF H-Field WCDMA 1900 High

HAC RF H-Field WCDMA 1900 Middle

Date: 2014-2-12

Electronics: DAE4 Sn777

Medium: Air

Medium parameters used: $\sigma = 0$ mho/m, $\epsilon_r = 1$; $\rho = 1$ kg/m³

Ambient Temperature: 22.5°C

Communication System: WCDMA 1900; Frequency: 1880 MHz; Duty Cycle: 1:1

Probe: H3DV6 - SN6260;

H Scan - H3DV6 - 2007: 15 mm from Probe Center to the Device 2/Hearing Aid Compatibility Test (101x101x1): Interpolated grid: dx=0.5000 mm, dy=0.5000 mm

Device Reference Point: 0, 0, -6.3 mm

Reference Value = 0.09700 A/m; Power Drift = 0.03 dB

PMR not calibrated. PMF = 1.003 is applied.

H-field emissions = 0.08418 A/m

Near-field category: M4 (AWF 0 dB)

PMF scaled H-field

Grid 1 M4 0.066 A/m	Grid 2 M4 0.082 A/m	Grid 3 M4 0.082 A/m
Grid 4 M4 0.063 A/m	Grid 5 M4 0.084 A/m	Grid 6 M4 0.084 A/m
Grid 7 M4 0.060 A/m	Grid 8 M4 0.081 A/m	Grid 9 M4 0.081 A/m

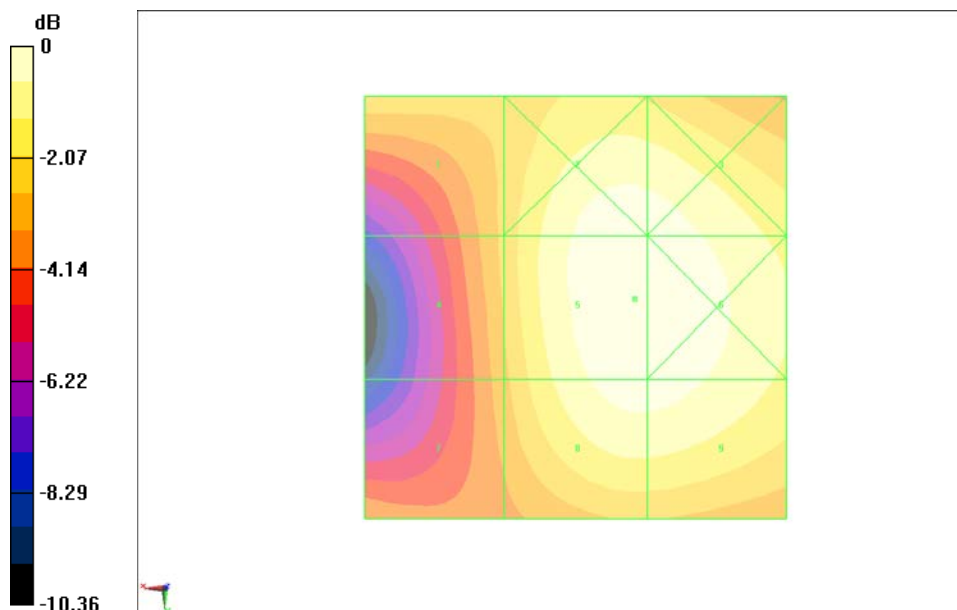

0 dB = 0.08418 A/m = -21.50 dBA/m

Fig B.23 HAC RF H-Field WCDMA 1900 Middle

HAC RF H-Field WCDMA 1900 Low

Date: 2014-2-12

Electronics: DAE4 Sn777

Medium: Air

Medium parameters used: $\sigma = 0$ mho/m, $\epsilon_r = 1$; $\rho = 1$ kg/m³

Ambient Temperature: 22.5°C

Communication System: WCDMA 1900; Frequency: 1852.4 MHz; Duty Cycle: 1:1

Probe: H3DV6 - SN6260;

H Scan - H3DV6 - 2007: 15 mm from Probe Center to the Device 3/Hearing Aid Compatibility Test (101x101x1): Interpolated grid: dx=0.5000 mm, dy=0.5000 mm

Device Reference Point: 0, 0, -6.3 mm

Reference Value = 0.09400 A/m; Power Drift = -0.05 dB

PMR not calibrated. PMF = 1.003 is applied.

H-field emissions = 0.08230 A/m

Near-field category: M4 (AWF 0 dB)

PMF scaled H-field

Grid 1 M4 0.066 A/m	Grid 2 M4 0.080 A/m	Grid 3 M4 0.080 A/m
Grid 4 M4 0.059 A/m	Grid 5 M4 0.082 A/m	Grid 6 M4 0.082 A/m
Grid 7 M4 0.059 A/m	Grid 8 M4 0.080 A/m	Grid 9 M4 0.080 A/m

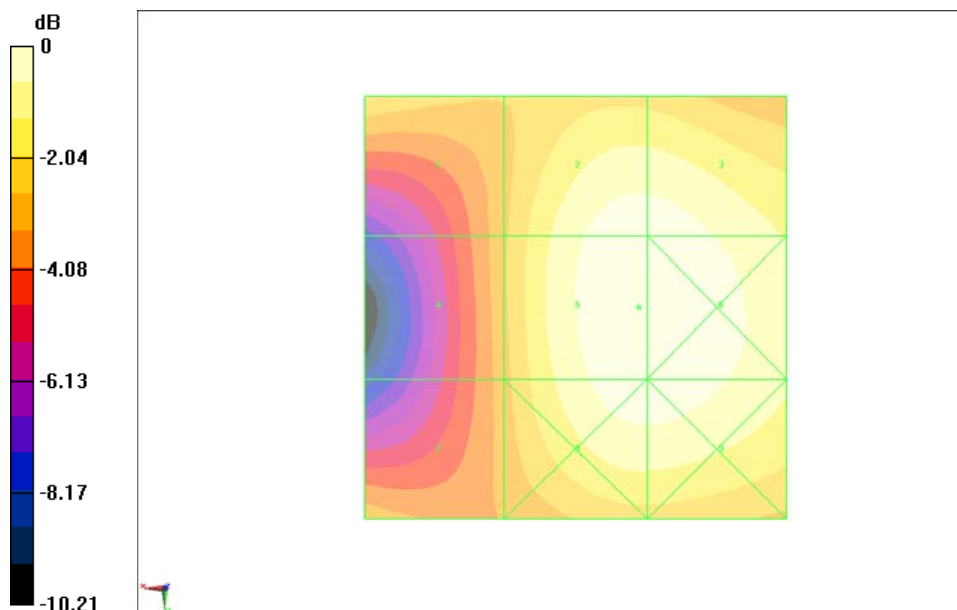

0 dB = 0.08230 A/m = -21.69 dBA/m

Fig B.24 HAC RF H-Field WCDMA 1900 Low

Total M-rating of GSM 850 MHz Band

Date: 2014-2-12

Electronics: DAE4 Sn777

Medium: Air

Medium parameters used: $\sigma = 0$ mho/m, $\epsilon_r = 1$; $\rho = 1000$ kg/m³ Medium parameters used: $\sigma = 0$ mho/m, $\epsilon_r = 1$; $\rho = 1$ kg/m³

Ambient Temperature: 22.6°C

Communication System: GSM 850; Frequency: 848.8 MHz; Duty Cycle: 1:8.3

Probe: ER3DV6 - SN2428 Probe: H3DV6 - SN6260; ConvF(1, 1, 1)

E Scan - ER3DV6 - 2007: 15 mm from Probe Center to the Device/Hearing Aid Compatibility Test (101x101x1): Interpolated grid: dx=0.5000 mm, dy=0.5000 mm

Device Reference Point: 0, 0, -6.3 mm

Reference Value = 60.25 V/m; Power Drift = 0.05 dB

PMR not calibrated. PMF = 2.874 is applied.

E-field emissions = 146.4 V/m

Near-field category: M4 (AWF -5 dB)

PMF scaled E-field

Grid 1 M4 116.6 V/m	Grid 2 M4 138.3 V/m	Grid 3 M4 138.2 V/m
Grid 4 M4 124.2 V/m	Grid 5 M4 146.4 V/m	Grid 6 M4 146.1 V/m
Grid 7 M4 134.7 V/m	Grid 8 M4 149.4 V/m	Grid 9 M4 147.2 V/m

H Scan - H3DV6 - 2007: 15 mm from Probe Center to the Device/Hearing Aid

Compatibility Test (101x101x1): Interpolated grid: dx=0.5000 mm, dy=0.5000 mm

Device Reference Point: 0, 0, -6.3 mm

Reference Value = 0.05400 A/m; Power Drift = 0.04 dB

PMR not calibrated. PMF = 2.874 is applied.

H-field emissions = 0.1997 A/m

Near-field category: M4 (AWF -5 dB)

PMF scaled H-field

Grid 1 M4 0.258 A/m	Grid 2 M4 0.200 A/m	Grid 3 M4 0.150 A/m
Grid 4 M4 0.234 A/m	Grid 5 M4 0.179 A/m	Grid 6 M4 0.132 A/m
Grid 7 M4 0.246 A/m	Grid 8 M4 0.178 A/m	Grid 9 M4 0.116 A/m

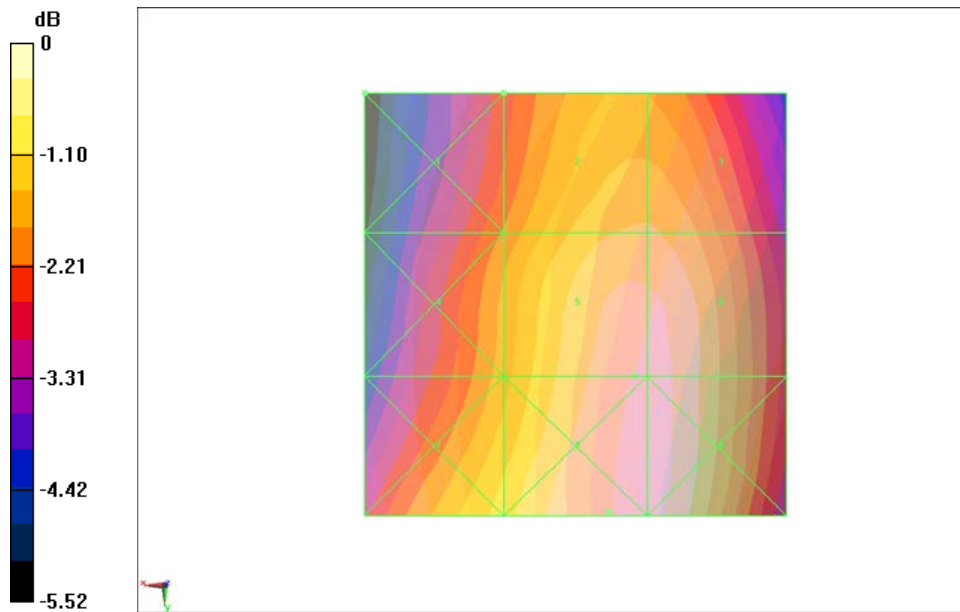

0 dB = 149.4 V/m = 43.49 dBV/m

RF RESULTS AND M-RATING	E-Field M Rating	M4 (AWF -5 dB)
	H-Field M Rating	M4 (AWF -5 dB)
	Total M Rating	M4

Fig B.25 Total M-rating of GSM 850

Total M-rating of GSM 1900 MHz Band

Date: 2014-2-12

Electronics: DAE4 Sn777

Medium: Air

Medium parameters used: $\sigma = 0$ mho/m, $\epsilon_r = 1$; $\rho = 1000$ kg/m³ Medium parameters used: $\sigma = 0$ mho/m, $\epsilon_r = 1$; $\rho = 1$ kg/m³

Ambient Temperature: 22.6°C

Communication System: PCS 1900; Frequency: 1850.2 MHz; Frequency: 1880 MHz; Duty Cycle: 1:8.3

Probe: ER3DV6 - SN2428 Probe: H3DV6 - SN6260; ConvF(1, 1, 1)

E Scan - ER3DV6 - 2007: 15 mm from Probe Center to the Device 3/Hearing Aid Compatibility Test (101x101x1): Interpolated grid: dx=0.5000 mm, dy=0.5000 mm

Device Reference Point: 0, 0, -6.3 mm

Reference Value = 6.735 V/m; Power Drift = -0.01 dB

PMR not calibrated. PMF = 2.882 is applied.

E-field emissions = 64.58 V/m

Near-field category: M3 (AWF -5 dB)

PMF scaled E-field

Grid 1 M3 49.33 V/m	Grid 2 M3 65.48 V/m	Grid 3 M3 65.37 V/m
Grid 4 M4 26.81 V/m	Grid 5 M4 32.54 V/m	Grid 6 M4 34.38 V/m
Grid 7 M3 57.00 V/m	Grid 8 M3 64.58 V/m	Grid 9 M3 62.53 V/m

H Scan - H3DV6 - 2007: 15 mm from Probe Center to the Device 2/Hearing Aid Compatibility Test (101x101x1): Interpolated grid: dx=0.5000 mm, dy=0.5000 mm

Device Reference Point: 0, 0, -6.3 mm

Reference Value = 0.08000 A/m; Power Drift = 0.01 dB

PMR not calibrated. PMF = 2.865 is applied.

H-field emissions = 0.1965 A/m

Near-field category: M3 (AWF -5 dB)

PMF scaled H-field

Grid 1 M3 0.152 A/m	Grid 2 M3 0.192 A/m	Grid 3 M3 0.191 A/m
Grid 4 M3 0.148 A/m	Grid 5 M3 0.196 A/m	Grid 6 M3 0.196 A/m
Grid 7 M3 0.140 A/m	Grid 8 M3 0.188 A/m	Grid 9 M3 0.188 A/m

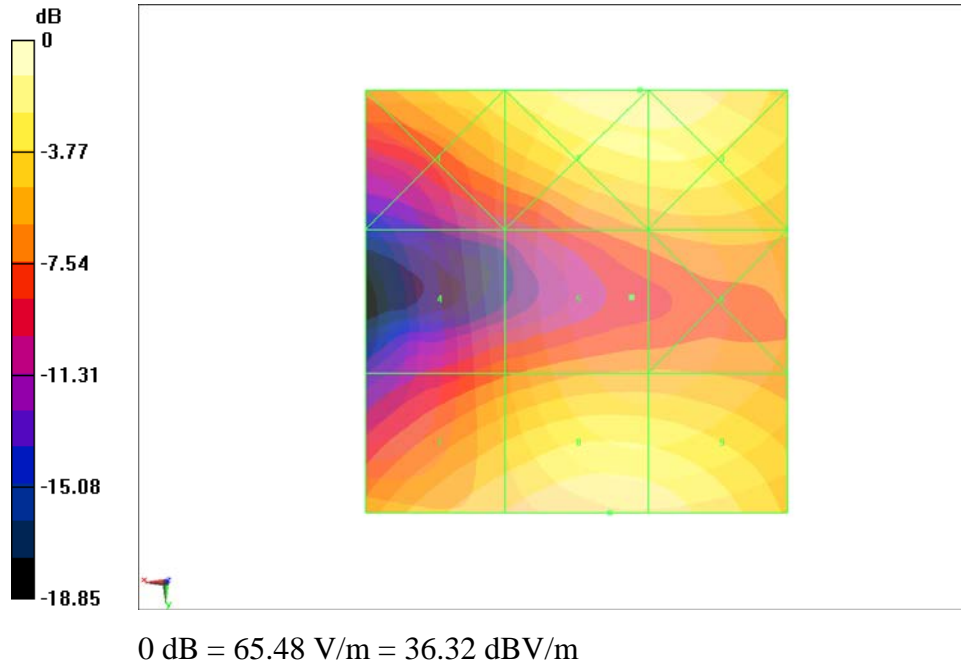

RF RESULTS AND M-RATING	E-Field M Rating	M3 (AWF -5 dB)
	H-Field M Rating	M3 (AWF -5 dB)
	Total M Rating	M3

Fig B.26 Total M-rating of GSM 1900

Total M-rating of WCDMA 850 MHz Band

Date: 2014-2-12

Electronics: DAE4 Sn777

Medium: Air

Medium parameters used: $\sigma = 0$ mho/m, $\epsilon_r = 1$; $\rho = 1000$ kg/m³ Medium parameters used: $\sigma = 0$ mho/m, $\epsilon_r = 1$; $\rho = 1$ kg/m³

Ambient Temperature: 22.6°C

Communication System: WCDMA 850; Frequency: 846.6 MHz; Duty Cycle: 1:1

Probe: ER3DV6 - SN2428 Probe: H3DV6 - SN6260; ConvF(1, 1, 1)

E Scan - ER3DV6 - 2007: 15 mm from Probe Center to the Device/Hearing Aid Compatibility Test (101x101x1): Interpolated grid: dx=0.5000 mm, dy=0.5000 mm

Device Reference Point: 0, 0, -6.3 mm

Reference Value = 46.35 V/m; Power Drift = 0.01 dB

PMR not calibrated. PMF = 1.005 is applied.

E-field emissions = 39.49 V/m

Near-field category: M4 (AWF 0 dB)

PMF scaled E-field

Grid 1 M4 31.10 V/m	Grid 2 M4 37.41 V/m	Grid 3 M4 37.38 V/m
Grid 4 M4 33.04 V/m	Grid 5 M4 39.48 V/m	Grid 6 M4 39.45 V/m
Grid 7 M4 35.63 V/m	Grid 8 M4 40.13 V/m	Grid 9 M4 39.87 V/m

H Scan - H3DV6 - 2007: 15 mm from Probe Center to the Device/Hearing Aid

Compatibility Test (101x101x1): Interpolated grid: dx=0.5000 mm, dy=0.5000 mm

Device Reference Point: 0, 0, -6.3 mm

Reference Value = 0.04300 A/m; Power Drift = 0.05 dB

PMR not calibrated. PMF = 1.005 is applied.

H-field emissions = 0.05549 A/m

Near-field category: M4 (AWF 0 dB)

PMF scaled H-field

Grid 1 M4 0.072 A/m	Grid 2 M4 0.055 A/m	Grid 3 M4 0.042 A/m
Grid 4 M4 0.065 A/m	Grid 5 M4 0.050 A/m	Grid 6 M4 0.036 A/m
Grid 7 M4 0.068 A/m	Grid 8 M4 0.049 A/m	Grid 9 M4 0.032 A/m

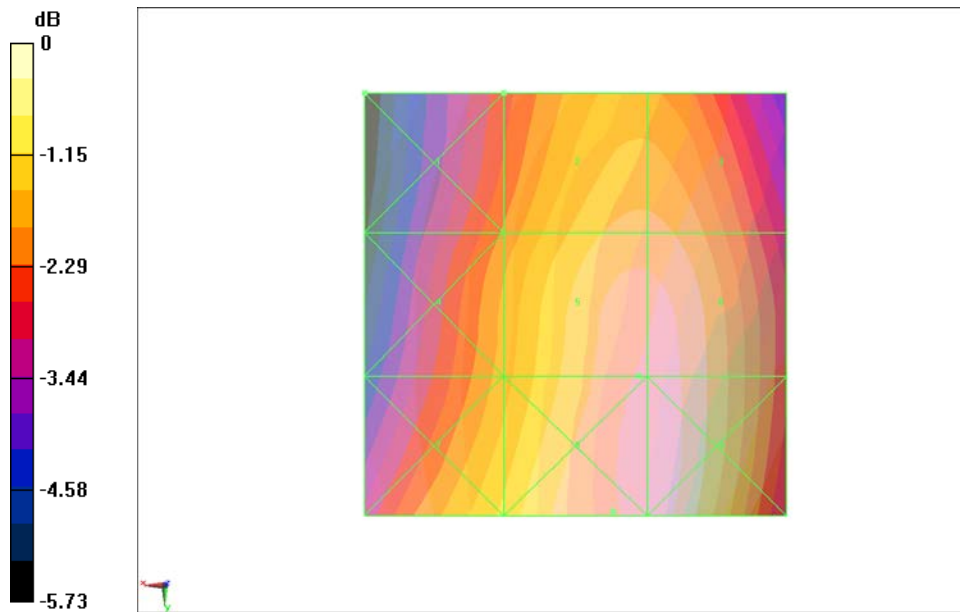

0 dB = 40.13 V/m = 32.07 dBV/m

RF RESULTS AND M-RATING	E-Field M Rating	M4 (AWF 0 dB)
	H-Field M Rating	M4 (AWF 0 dB)
	Total M Rating	M4

Fig B.27 Total M-rating of WCDMA 850

Total M-rating of WCDMA 1900 MHz Band

Date: 2014-2-12

Electronics: DAE4 Sn777

Medium: Air

Medium parameters used: $\sigma = 0$ mho/m, $\epsilon_r = 1$; $\rho = 1000$ kg/m³ Medium parameters used: $\sigma = 0$ mho/m, $\epsilon_r = 1$; $\rho = 1$ kg/m³

Ambient Temperature: 22.5°C

Communication System: WCDMA 1900; Frequency: 1852.4 MHz; Frequency: 1880 MHz; Duty Cycle: 1:1

Probe: ER3DV6 - SN2428Probe: H3DV6 - SN6260;ConvF(1, 1, 1)

E Scan - ER3DV6 - 2007: 15 mm from Probe Center to the Device 3/Hearing Aid Compatibility Test (101x101x1): Interpolated grid: dx=0.5000 mm, dy=0.5000 mm

Device Reference Point: 0, 0, -6.3 mm

Reference Value = 9.215 V/m; Power Drift = -0.42 dB

PMR not calibrated. PMF = 1.006 is applied.

E-field emissions = 30.15 V/m

Near-field category: M4 (AWF 0 dB)

PMF scaled E-field

Grid 1 M4 24.26 V/m	Grid 2 M4 31.77 V/m	Grid 3 M4 31.67 V/m
Grid 4 M4 11.94 V/m	Grid 5 M4 15.82 V/m	Grid 6 M4 16.83 V/m
Grid 7 M4 26.10 V/m	Grid 8 M4 30.15 V/m	Grid 9 M4 29.43 V/m

H Scan - H3DV6 - 2007: 15 mm from Probe Center to the Device 2/Hearing

Aid Compatibility Test (101x101x1): Interpolated grid: dx=0.5000 mm, dy=0.5000 mm

Device Reference Point: 0, 0, -6.3 mm

Reference Value = 0.09700 A/m; Power Drift = 0.03 dB

PMR not calibrated. PMF = 1.003 is applied.

H-field emissions = 0.08418 A/m

Near-field category: M4 (AWF 0 dB)

PMF scaled H-field

Grid 1 M4 0.066 A/m	Grid 2 M4 0.082 A/m	Grid 3 M4 0.082 A/m
Grid 4 M4 0.063 A/m	Grid 5 M4 0.084 A/m	Grid 6 M4 0.084 A/m
Grid 7 M4 0.060 A/m	Grid 8 M4 0.081 A/m	Grid 9 M4 0.081 A/m

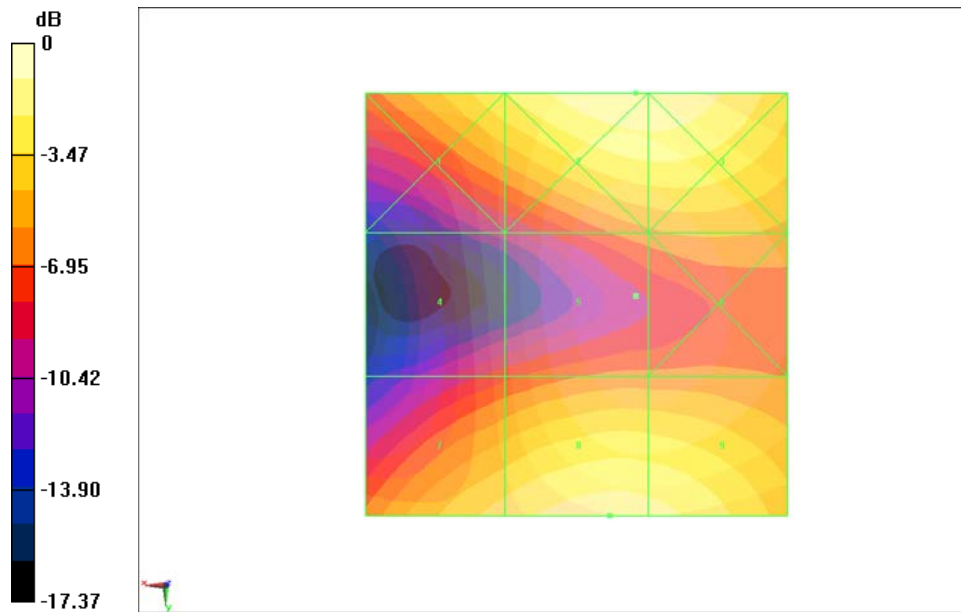

0 dB = 31.77 V/m = 30.04 dBV/m

RF RESULTS AND M-RATING	E-Field M Rating	M4 (AWF 0 dB)
	H-Field M Rating	M4 (AWF 0 dB)
	Total M Rating	M4

Fig B.28 Total M-rating of WCDMA 1900

ANNEX C SYSTEM VALIDATION RESULT

E SCAN of Dipole 835 MHz

Date: 2014-2-12

Electronics: DAE4 Sn777

Medium: Air

Medium parameters used: $\sigma = 0$ mho/m, $\epsilon_r = 1$; $\rho = 1000$ kg/m³

Communication System: CW; Frequency: 835 MHz; Duty Cycle: 1:1

Probe: ER3DV6 - SN2428;ConvF(1, 1, 1)

E Scan - measurement distance from the probe sensor center to CD835 Dipole = 10mm/Hearing Aid Compatibility Test (41x361x1): Measurement grid: dx=0.5000mm, dy=0.5000mm

Maximum value of peak Total field = 169.4 V/m

Probe Modulation Factor = 1.000

Device Reference Point: 0, 0, -6.3 mm

Reference Value = 108.2 V/m; Power Drift = 0.15 dB

Hearing Aid Near-Field Category: M4 (AWF 0 dB)

Peak E-field in V/m

Grid 1	Grid 2	Grid 3
162.1 M4	169.4 M4	165.7 M4
Grid 4	Grid 5	Grid 6
85.64 M4	88.67M4	87.09 M4
Grid 7	Grid 8	Grid 9
157.0 M4	167.3 M4	165.9 M4

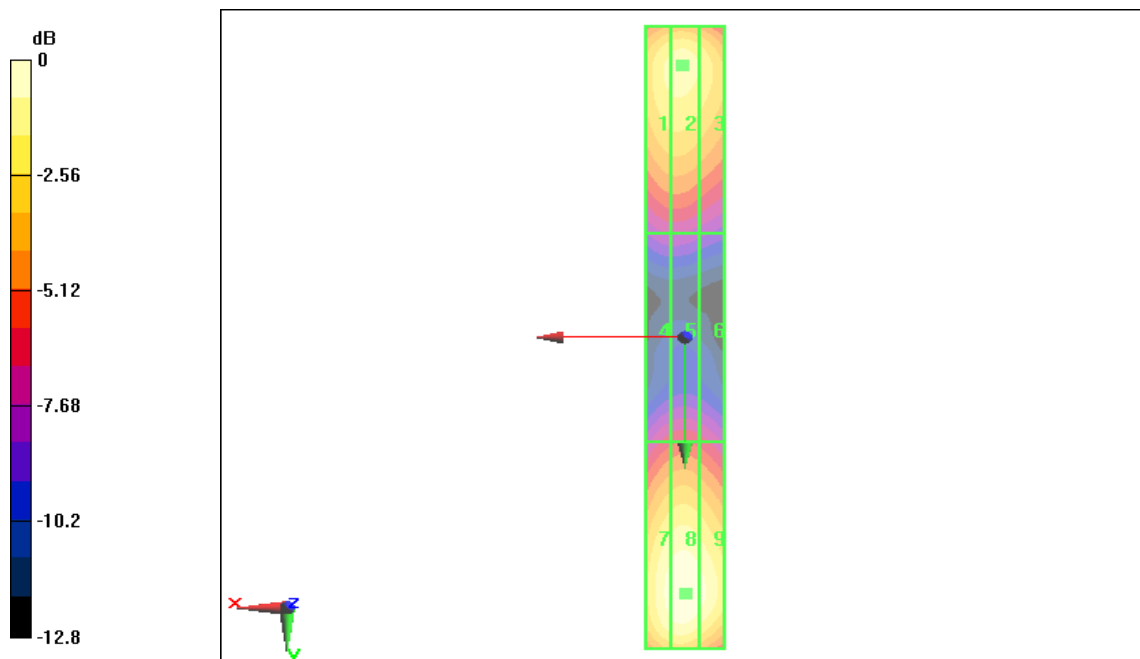

0 dB = 169.4V/m

H SCAN of Dipole 835 MHz

Date: 2014-2-12

Electronics: DAE4 Sn777

Medium: Air

Medium parameters used: $\sigma = 0$ mho/m, $\epsilon_r = 1$; $\rho = 1$ kg/m³

Communication System: CW; Frequency: 835 MHz; Duty Cycle: 1:1

Probe: H3DV6 - SN6260;

H Scan - measurement distance from the probe sensor center to CD835 Dipole = 10mm/Hearing Aid Compatibility Test (41x361x1): Measurement grid: dx=0.5000mm, dy=0.5000mm

Maximum value of peak Total field = 0.468 A/m

Probe Modulation Factor = 1.000

Device Reference Point: 0, 0, -6.3 mm

Reference Value = 0.497 A/m; Power Drift = 0.11 dB

Hearing Aid Near-Field Category: M4 (AWF 0 dB)

Peak H-field in A/m

Grid 1 0.387 M4	Grid 2 0.416 M4	Grid 3 0.401 M4
Grid 4 0.434 M4	Grid 5 0.468 M4	Grid 6 0.453 M4
Grid 7 0.384 M4	Grid 8 0.420 M4	Grid 9 0.407M4

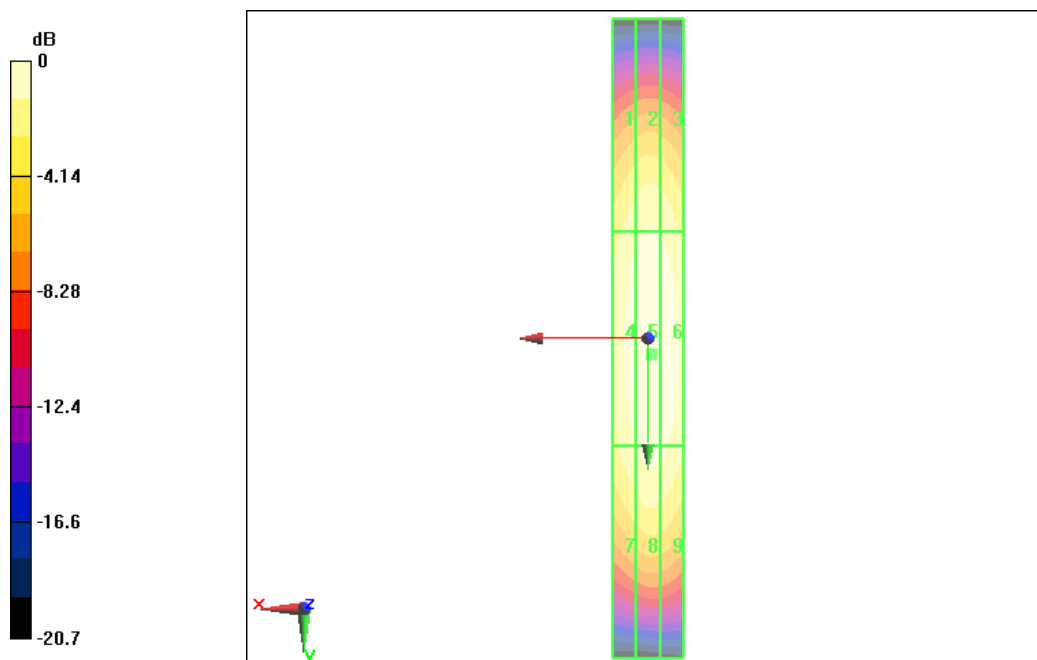

0 dB = 0.468A/m

E SCAN of Dipole 1880 MHz

Date: 2014-2-12

Electronics: DAE4 Sn777

Medium: Air

Medium parameters used: $\sigma = 0$ mho/m, $\epsilon_r = 1$; $\rho = 1000$ kg/m³

Communication System: CW; Frequency: 1880 MHz; Duty Cycle: 1:1

Probe: ER3DV6 - SN2428;ConvF(1, 1, 1)

E Scan - measurement distance from the probe sensor center to CD1880 Dipole = 10mm/Hearing Aid Compatibility Test (41x181x1): Measurement grid: dx=0.5000mm, dy=0.5000mm

Maximum value of peak Total field = 141.2 V/m

Probe Modulation Factor = 1.000

Device Reference Point: 0, 0, -6.3 mm

Reference Value = 158.2 V/m; Power Drift = 0.09 dB

Hearing Aid Near-Field Category: M2 (AWF 0 dB)

Peak E-field in V/m

Grid 1 129.5 M2	Grid 2 136.4 M2	Grid 3 135.0 M2
Grid 4 86.69 M3	Grid 5 90.12 M3	Grid 6 87.62 M3
Grid 7 131.8 M2	Grid 8 141.2 M2	Grid 9 139.5 M2

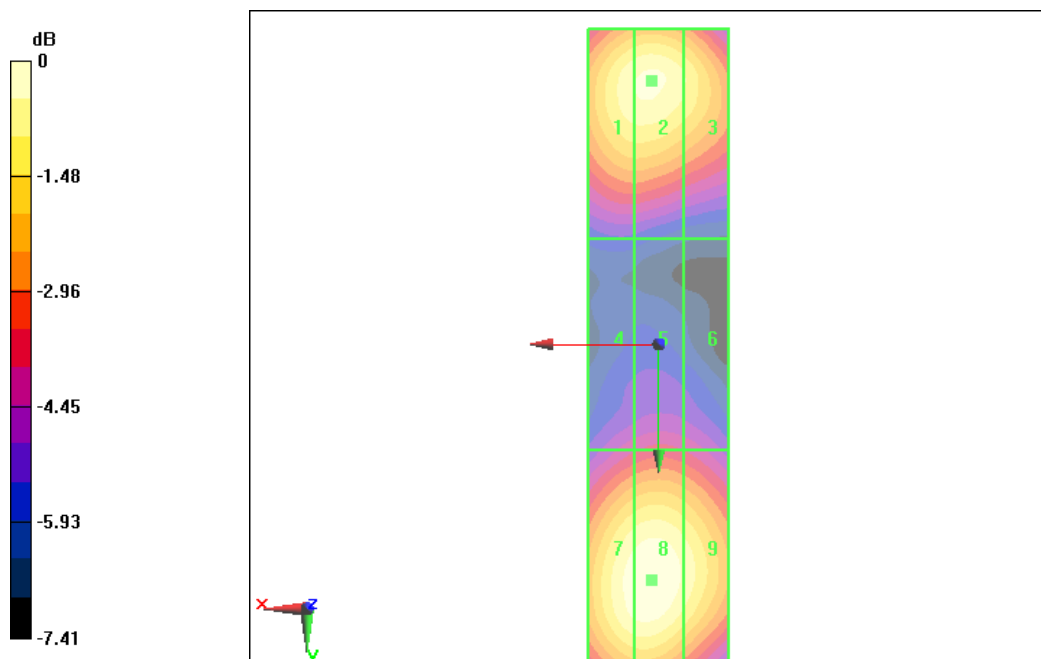

0 dB = 141.2V/m

H SCAN of Dipole 1880 MHz

Date: 2014-2-12

Electronics: DAE4 Sn777

Medium: Air

Medium parameters used: $\sigma = 0$ mho/m, $\epsilon_r = 1$; $\rho = 1$ kg/m³

Communication System: CW; Frequency: 1880 MHz; Duty Cycle: 1:1

Probe: H3DV6 - SN6260;

H Scan - measurement distance from the probe sensor center to CD1880 Dipole = 10mm/Hearing Aid Compatibility Test (41x181x1): Measurement grid: dx=0.5000mm, dy=0.5000mm

Maximum value of peak Total field = 0.454 A/m

Probe Modulation Factor = 1.000

Device Reference Point: 0, 0, -6.3 mm

Reference Value = 0.480 A/m; Power Drift = -0.01 dB

Hearing Aid Near-Field Category: M2 (AWF 0 dB)

Peak H-field in A/m

Grid 1	Grid 2	Grid 3
0.381 M2	0.411 M2	0.402 M2
Grid 4	Grid 5	Grid 6
0.420 M2	0.454 M2	0.442 M2
Grid 7	Grid 8	Grid 9
0.381 M2	0.418 M2	0.405 M2

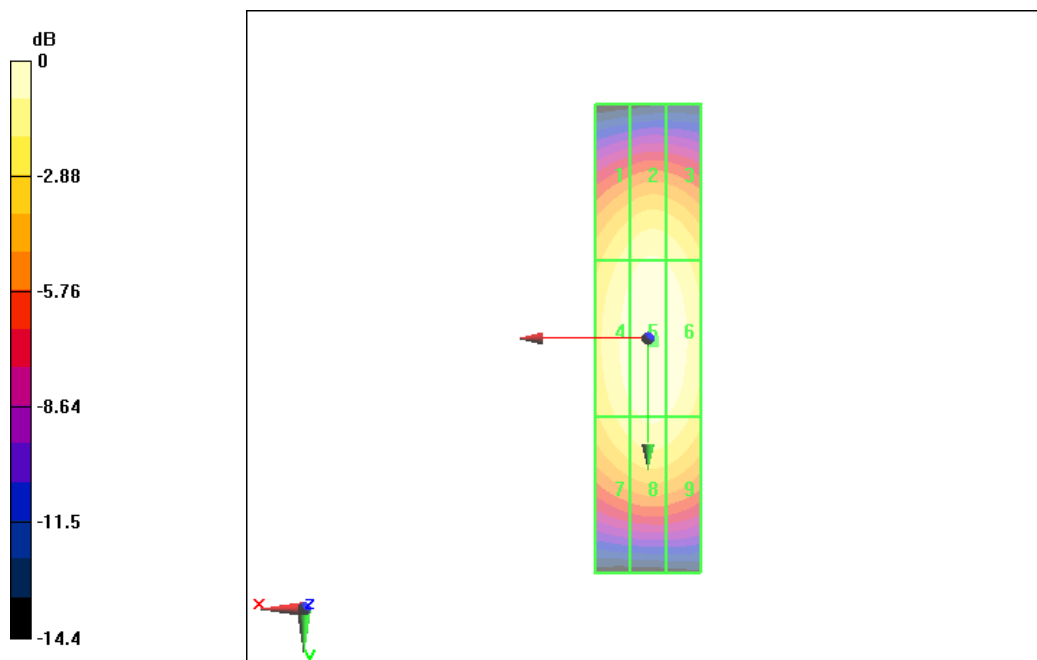

0 dB = 0.454A/m

ANNEX D PROBE CALIBRATION CERTIFICATE

E_Probe ER3DV6

Calibration Laboratory of
Schmid & Partner
Engineering AG
Zeughausstrasse 43, 8004 Zurich, Switzerland



S Schweizerischer Kalibrierdienst
C Service suisse d'étalonnage
S Servizio svizzero di taratura
S Swiss Calibration Service

Accredited by the Swiss Accreditation Service (SAS)
The Swiss Accreditation Service is one of the signatories to the EA
Multilateral Agreement for the recognition of calibration certificates

Accreditation No.: **SCS 108**

Client **TMC Beijing (Auden)**

Certificate No: **ER3-2428_Jan14**

CALIBRATION CERTIFICATE

Object **ER3DV6 - SN:2428**

Calibration procedure(s) **QA CAL-02.v8, QA CAL-25.v6
Calibration procedure for E-field probes optimized for close near field
evaluations in air**

Calibration date: **January 27, 2014**

This calibration certificate documents the traceability to national standards, which realize the physical units of measurements (SI).
The measurements and the uncertainties with confidence probability are given on the following pages and are part of the certificate.

All calibrations have been conducted in the closed laboratory facility: environment temperature (22 ± 3)°C and humidity < 70%.

Calibration Equipment used (M&TE critical for calibration)

Primary Standards	ID	Cal Date (Certificate No.)	Scheduled Calibration
Power meter E4419B	GB41293874	04-Apr-13 (No. 217-01733)	Apr-14
Power sensor E4412A	MY41498087	04-Apr-13 (No. 217-01733)	Apr-14
Reference 3 dB Attenuator	SN: S5054 (3c)	04-Apr-13 (No. 217-01737)	Apr-14
Reference 20 dB Attenuator	SN: S5277 (20x)	04-Apr-13 (No. 217-01735)	Apr-14
Reference 30 dB Attenuator	SN: S5129 (30b)	04-Apr-13 (No. 217-01738)	Apr-14
Reference Probe ER3DV6	SN: 2328	10-Oct-13 (No. ER3-2328_Oct13)	Oct-14
DAE4	SN: 789	15-May-13 (No. DAE4-789_May13)	May-14
Secondary Standards	ID	Check Date (in house)	Scheduled Check
RF generator HP 8648C	US3642U01700	4-Aug-99 (in house check Apr-13)	In house check: Apr-16
Network Analyzer HP 8753E	US37390585	18-Oct-01 (in house check Oct-13)	In house check: Oct-14

	Name	Function	Signature
Calibrated by:	Leif Klysner	Laboratory Technician	
Approved by:	Katja Pokovic	Technical Manager	

Issued: January 28, 2014

This calibration certificate shall not be reproduced except in full without written approval of the laboratory.

Calibration Laboratory of
Schmid & Partner
Engineering AG
Zeughausstrasse 43, 8004 Zurich, Switzerland



S Schweizerischer Kalibrierdienst
S Service suisse d'étalonnage
C Servizio svizzero di taratura
S Swiss Calibration Service

Accredited by the Swiss Accreditation Service (SAS)

Accreditation No.: **SCS 108**

The Swiss Accreditation Service is one of the signatories to the EA
Multilateral Agreement for the recognition of calibration certificates

Glossary:

NORM _{x,y,z}	sensitivity in free space
DCP	diode compression point
CF	crest factor (1/duty_cycle) of the RF signal
A, B, C, D	modulation dependent linearization parameters
Polarization φ	φ rotation around probe axis
Polarization ϑ	ϑ rotation around an axis that is in the plane normal to probe axis (at measurement center), i.e., $\vartheta = 0$ is normal to probe axis
Connector Angle	information used in DASY system to align probe sensor X to the robot coordinate system

Calibration is Performed According to the Following Standards:

- a) IEEE Std 1309-2005, " IEEE Standard for calibration of electromagnetic field sensors and probes, excluding antennas, from 9 kHz to 40 GHz", December 2005
- b) CTIA Test Plan for Hearing Aid Compatibility, April 2010.

Methods Applied and Interpretation of Parameters:

- *NORM_{x,y,z}*: Assessed for E-field polarization $\vartheta = 0$ for XY sensors and $\vartheta = 90$ for Z sensor ($f \leq 900$ MHz in TEM-cell; $f > 1800$ MHz: R22 waveguide).
- *NORM(f)_{x,y,z}* = *NORM_{x,y,z}* * *frequency_response* (see Frequency Response Chart).
- *DCP_{x,y,z}*: DCP are numerical linearization parameters assessed based on the data of power sweep with CW signal (no uncertainty required). DCP does not depend on frequency nor media.
- *PAR*: PAR is the Peak to Average Ratio that is not calibrated but determined based on the signal characteristics
- *A_{x,y,z}; B_{x,y,z}; C_{x,y,z}; D_{x,y,z}; VR_{x,y,z}*: A, B, C, D are numerical linearization parameters assessed based on the data of power sweep for specific modulation signal. The parameters do not depend on frequency nor media. VR is the maximum calibration range expressed in RMS voltage across the diode.
- *Spherical isotropy (3D deviation from isotropy)*: in a locally homogeneous field realized using an open waveguide setup.
- *Sensor Offset*: The sensor offset corresponds to the offset of virtual measurement center from the probe tip (on probe axis). No tolerance required.
- *Connector Angle*: The angle is assessed using the information gained by determining the *NORM_x* (no uncertainty required).

ER3DV6 – SN:2428

January 27, 2014

Probe ER3DV6

SN:2428

Manufactured: September 11, 2007
Calibrated: January 27, 2014

Calibrated for DASY/EASY Systems
(Note: non-compatible with DASY2 system!)

ER3DV6- SN:2428

January 27, 2014

DASY/EASY - Parameters of Probe: ER3DV6 - SN:2428

Basic Calibration Parameters

	Sensor X	Sensor Y	Sensor Z	Unc (k=2)
Norm ($\mu\text{V}/(\text{V}/\text{m})^2$)	1.51	1.59	1.83	$\pm 10.1 \%$
DCP (mV) ^B	98.9	97.0	101.1	

Modulation Calibration Parameters

UID	Communication System Name		A dB	B dB $\sqrt{\mu\text{V}}$	C	D dB	VR mV	Unc ^E (k=2)
0	CW	X	0.0	0.0	1.0	0.00	190.5	$\pm 3.3 \%$
		Y	0.0	0.0	1.0		152.5	
		Z	0.0	0.0	1.0		198.6	
10021-DAA	GSM-FDD (TDMA, GMSK)	X	20.75	99.9	29.1	9.39	119.1	$\pm 1.2 \%$
		Y	19.27	99.6	28.9		125.1	
		Z	24.43	99.4	28.5		139.5	
10039-CAA	CDMA2000 (1xRTT, RC1)	X	4.62	65.6	18.5	4.57	109.6	$\pm 0.9 \%$
		Y	4.78	66.3	18.9		121.2	
		Z	4.58	66.0	18.7		114.4	

The reported uncertainty of measurement is stated as the standard uncertainty of measurement multiplied by the coverage factor $k=2$, which for a normal distribution corresponds to a coverage probability of approximately 95%.

^B Numerical linearization parameter: uncertainty not required.

^E Uncertainty is determined using the max. deviation from linear response applying rectangular distribution and is expressed for the square of the field value.

ER3DV6- SN:2428

January 27, 2014

Frequency Response of E-Field (TEM-Cell:ifi110 EXX, Waveguide: R22)

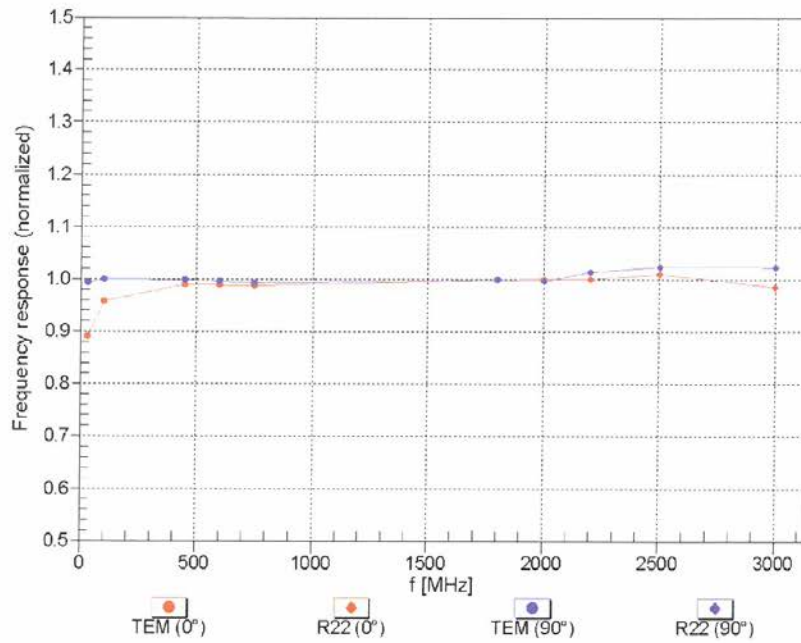

Uncertainty of Frequency Response of E-field: $\pm 6.3\%$ (k=2)

ER3DV6- SN:2428

January 27, 2014

Receiving Pattern (ϕ), $\vartheta = 0^\circ$

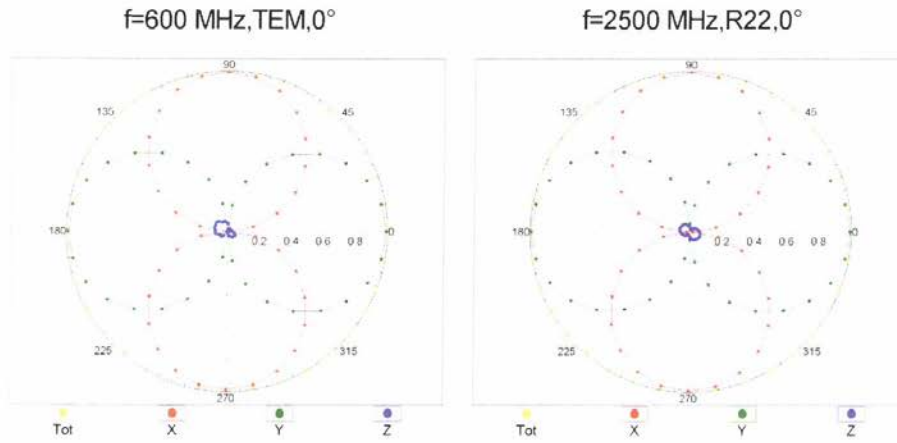

Receiving Pattern (ϕ), $\vartheta = 90^\circ$

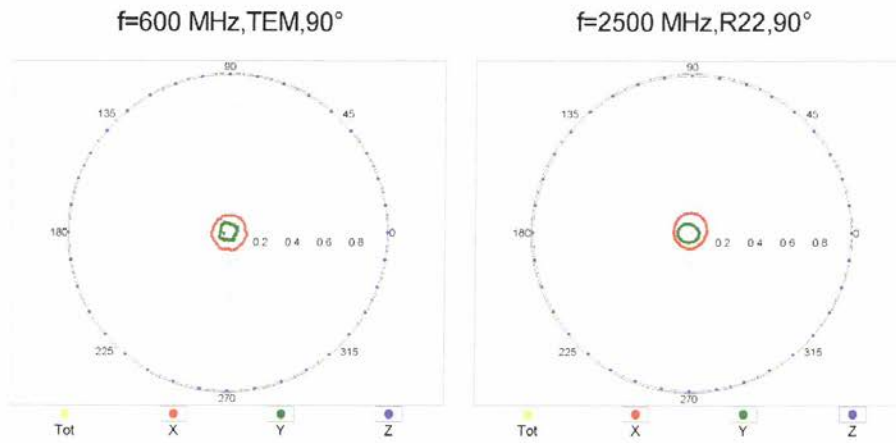

ER3DV6-SN:2428

January 27, 2014

Receiving Pattern (ϕ), $\vartheta = 0^\circ$

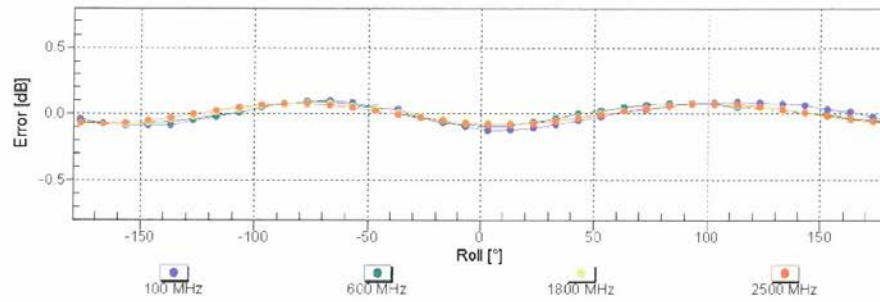

Uncertainty of Axial Isotropy Assessment: $\pm 0.5\%$ ($k=2$)

Receiving Pattern (ϕ), $\vartheta = 90^\circ$

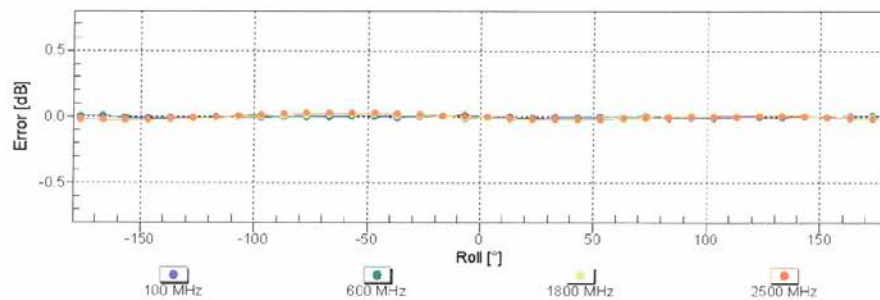

Uncertainty of Axial Isotropy Assessment: $\pm 0.5\%$ ($k=2$)

ER3DV6- SN:2428

January 27, 2014

Dynamic Range f(E-field) (TEM cell , f = 900 MHz)

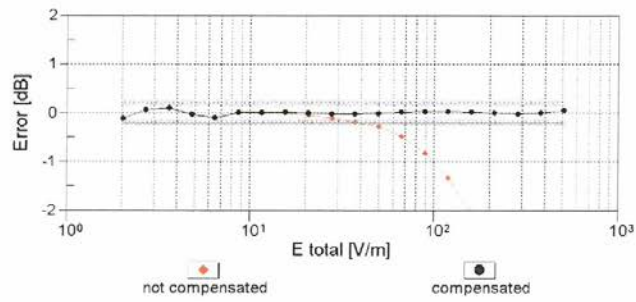
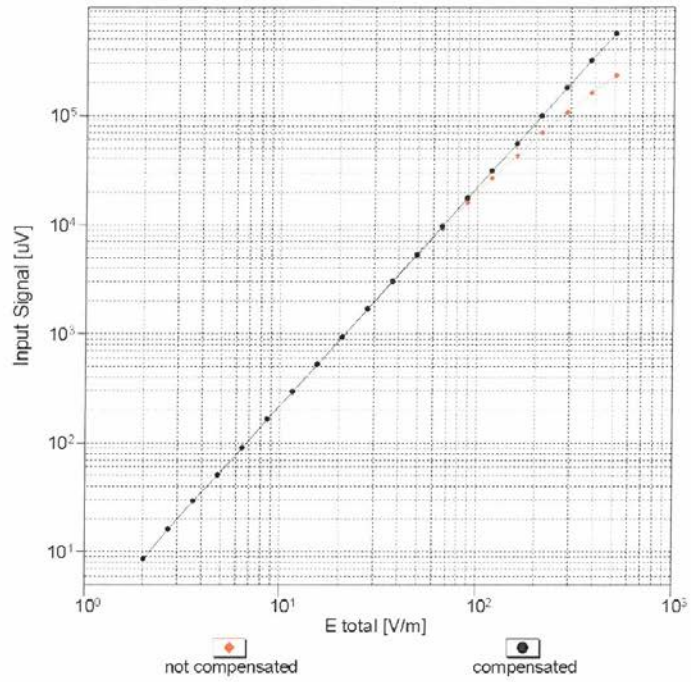

Uncertainty of Linearity Assessment: $\pm 0.6\%$ (k=2)

ER3DV6- SN:2428

January 27, 2014

Deviation from Isotropy in Air Error (ϕ , θ), $f = 900$ MHz

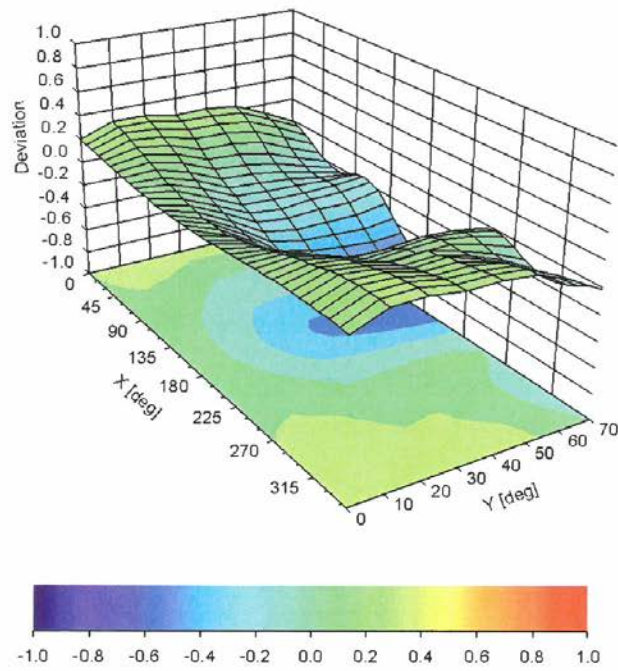

Uncertainty of Spherical Isotropy Assessment: $\pm 2.6\%$ ($k=2$)

ER3DV6- SN:2428

January 27, 2014

DASY/EASY - Parameters of Probe: ER3DV6 - SN:2428

Other Probe Parameters

Sensor Arrangement	Rectangular
Connector Angle (°)	-36.9
Mechanical Surface Detection Mode	enabled
Optical Surface Detection Mode	disabled
Probe Overall Length	337 mm
Probe Body Diameter	10 mm
Tip Length	10 mm
Tip Diameter	8 mm
Probe Tip to Sensor X Calibration Point	2.5 mm
Probe Tip to Sensor Y Calibration Point	2.5 mm
Probe Tip to Sensor Z Calibration Point	2.5 mm

H_Probe H3DV6

**Calibration Laboratory of
Schmid & Partner
Engineering AG**
Zeughausstrasse 43, 8004 Zurich, Switzerland



S Schweizerischer Kalibrierdienst
S Service suisse d'étalonnage
S Servizio svizzero di taratura
S Swiss Calibration Service

Accredited by the Swiss Accreditation Service (SAS)
The Swiss Accreditation Service is one of the signatories to the EA
Multilateral Agreement for the recognition of calibration certificates

Accreditation No.: **SCS 108**

Client **TMC Beijing (Auden)**

Certificate No: **H3-6260_Jan14**

CALIBRATION CERTIFICATE

Object **H3DV6 - SN:6260**

Calibration procedure(s) **QA CAL-03.v8, QA CAL-25.v6
Calibration procedure for H-field probes optimized for close near field
evaluations in air**

Calibration date: **January 27, 2014**

This calibration certificate documents the traceability to national standards, which realize the physical units of measurements (SI).
The measurements and the uncertainties with confidence probability are given on the following pages and are part of the certificate.

All calibrations have been conducted in the closed laboratory facility: environment temperature (22 ± 3)°C and humidity < 70%.

Calibration Equipment used (M&TE critical for calibration)

Primary Standards	ID	Cal Date (Certificate No.)	Scheduled Calibration
Power meter E4419B	GB41293874	04-Apr-13 (No. 217-01733)	Apr-14
Power sensor E4412A	MY41498087	04-Apr-13 (No. 217-01733)	Apr-14
Reference 3 dB Attenuator	SN: S5054 (3c)	04-Apr-13 (No. 217-01737)	Apr-14
Reference 20 dB Attenuator	SN: S5277 (20x)	04-Apr-13 (No. 217-01735)	Apr-14
Reference 30 dB Attenuator	SN: S5129 (30b)	04-Apr-13 (No. 217-01738)	Apr-14
Reference Probe H3DV6	SN: 6182	10-Oct-13 (No. H3-6182_Oct13)	Oct-14
DAE4	SN: 789	15-May-13 (No. DAE4-789_May13)	May-14
Secondary Standards	ID	Check Date (in house)	Scheduled Check
RF generator HP 8648C	US3642U01700	4-Aug-99 (in house check Apr-13)	In house check: Apr-16
Network Analyzer HP 8753E	US37390585	18-Oct-01 (in house check Oct-13)	In house check: Oct-14

Calibrated by:	Name Leif Klysner	Function Laboratory Technician	Signature
Approved by:	Name Katja Pokovic	Function Technical Manager	Signature

Issued: January 28, 2014

This calibration certificate shall not be reproduced except in full without written approval of the laboratory.

Calibration Laboratory of
Schmid & Partner
Engineering AG
Zeughausstrasse 43, 8004 Zurich, Switzerland



S Schweizerischer Kalibrierdienst
S Service suisse d'étalonnage
C Servizio svizzero di taratura
S Swiss Calibration Service

Accredited by the Swiss Accreditation Service (SAS)

Accreditation No.: **SCS 108**

The Swiss Accreditation Service is one of the signatories to the EA Multilateral Agreement for the recognition of calibration certificates

Glossary:

NORM _{x,y,z}	sensitivity in free space
DCP	diode compression point
CF	crest factor (1/duty_cycle) of the RF signal
A, B, C, D	modulation dependent linearization parameters
Polarization φ	φ rotation around probe axis
Polarization ϑ	ϑ rotation around an axis that is in the plane normal to probe axis (at measurement center), i.e., $\vartheta = 0$ is normal to probe axis
Connector Angle	information used in DASY system to align probe sensor X to the robot coordinate system

Calibration is Performed According to the Following Standards:

- a) IEEE Std 1309-2005, " IEEE Standard for calibration of electromagnetic field sensors and probes, excluding antennas, from 9 kHz to 40 GHz", December 2005.
- b) CTIA Test Plan for Hearing Aid Compatibility, April 2010.

Methods Applied and Interpretation of Parameters:

- *NORM_{x,y,z}*: Assessed for E-field polarization $\vartheta = 0$ for XY sensors and $\vartheta = 90$ for Z sensor ($f \leq 900$ MHz in TEM-cell; $f > 1800$ MHz: R22 waveguide).
- *X,Y,Z(f)_a0a1a2* = *X,Y,Z_a0a1a2* * *frequency_response* (see Frequency Response Chart).
- *DCP_{x,y,z}*: DCP are numerical linearization parameters assessed based on the data of power sweep with CW signal (no uncertainty required). DCP does not depend on frequency nor media.
- *PAR*: PAR is the Peak to Average Ratio that is not calibrated but determined based on the signal characteristics
- *A_{x,y,z}; B_{x,y,z}; C_{x,y,z}; D_{x,y,z}; VR_{x,y,z}*: A, B, C, D are numerical linearization parameters assessed based on the data of power sweep for specific modulation signal. The parameters do not depend on frequency nor media. VR is the maximum calibration range expressed in RMS voltage across the diode.
- *Spherical isotropy (3D deviation from isotropy)*: in a locally homogeneous field realized using an open waveguide setup.
- *Sensor Offset*: The sensor offset corresponds to the offset of virtual measurement center from the probe tip (on probe axis). No tolerance required.
- *Connector Angle*: The angle is assessed using the information gained by determining the *X_a0a1a2* (no uncertainty required).

H3DV6 – SN:6260

January 27, 2014

Probe H3DV6

SN:6260

Manufactured: September 7, 2007
Calibrated: January 27, 2014

Calibrated for DASY/EASY Systems
(Note: non-compatible with DASY2 system!)

H3DV6- SN:6260

January 27, 2014

DASY/EASY - Parameters of Probe: H3DV6 - SN:6260

Basic Calibration Parameters

		Sensor X	Sensor Y	Sensor Z	Unc (k=2)
Norm (A/m / $\sqrt{\text{mV}}$)	a0	2.48E-003	2.49E-003	2.92E-003	$\pm 5.1 \%$
Norm (A/m / $\sqrt{\text{mV}}$)	a1	-2.51E-005	1.35E-006	2.69E-006	$\pm 5.1 \%$
Norm (A/m / $\sqrt{\text{mV}}$)	a2	5.03E-005	4.10E-005	5.26E-005	$\pm 5.1 \%$
DCP (mV) ^B		90.9	91.8	92.6	

Modulation Calibration Parameters

UID	Communication System Name		A dB	B dB/ $\sqrt{\mu\text{V}}$	C	D dB	VR mV	Unc ^E (k=2)
0	CW	X	0.0	0.0	1.0	0.00	138.5	$\pm 1.4 \%$
		Y	0.0	0.0	1.0		136.9	
		Z	0.0	0.0	1.0		134.3	

The reported uncertainty of measurement is stated as the standard uncertainty of measurement multiplied by the coverage factor $k=2$, which for a normal distribution corresponds to a coverage probability of approximately 95%.

^B Numerical linearization parameter: uncertainty not required.

^E Uncertainty is determined using the max. deviation from linear response applying rectangular distribution and is expressed for the square of the field value.

H3DV6- SN:6260

January 27, 2014

Frequency Response of H-Field (TEM-Cell:ifi110 EXX, Waveguide: R22)

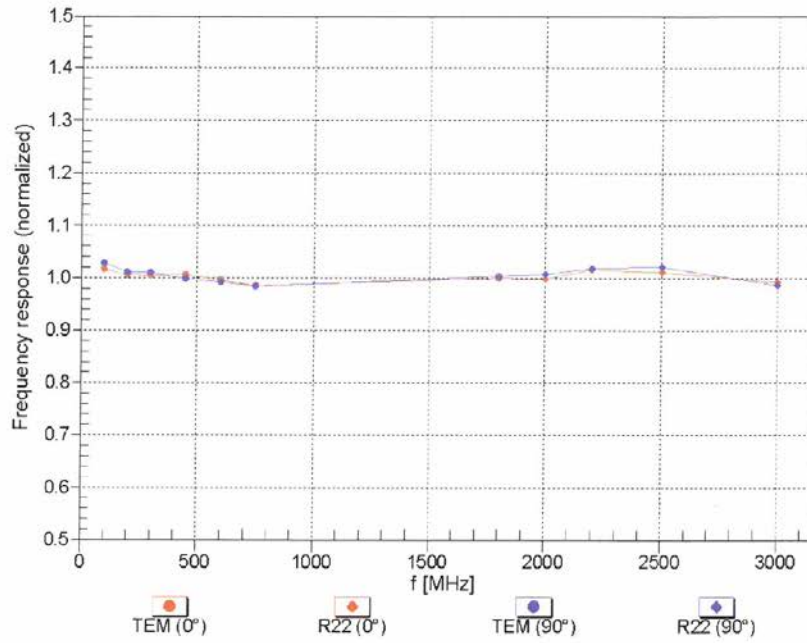

Uncertainty of Frequency Response of H-field: $\pm 6.3\%$ (k=2)

H3DV6- SN:6260

January 27, 2014

Receiving Pattern (ϕ), $\vartheta = 0^\circ$

f=600 MHz,TEM,0°

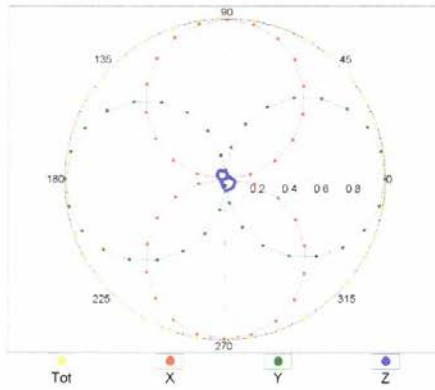

f=2500 MHz,R22,0°

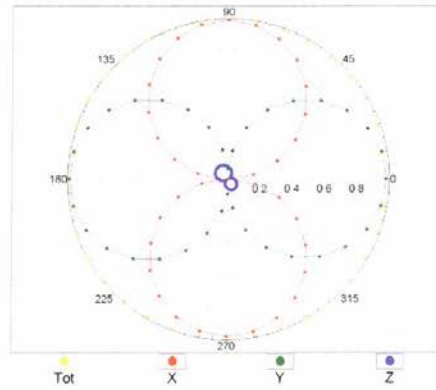

Receiving Pattern (ϕ), $\vartheta = 90^\circ$

f=600 MHz,TEM,90°

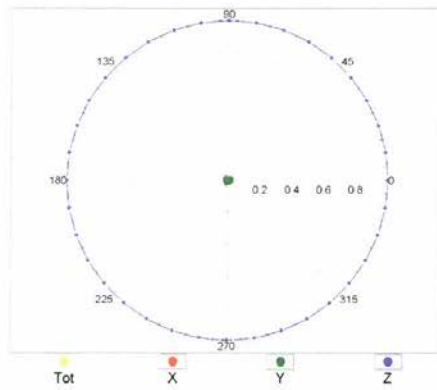

f=2500 MHz,R22,90°

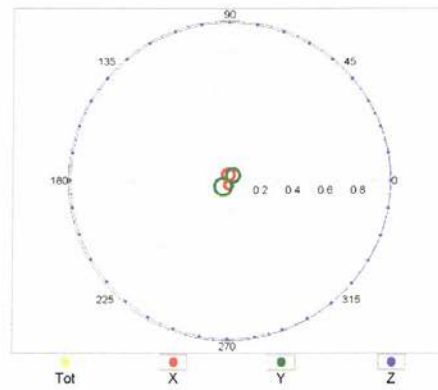

H3DV6- SN:6260

January 27, 2014

Receiving Pattern (ϕ), $\vartheta = 0^\circ$

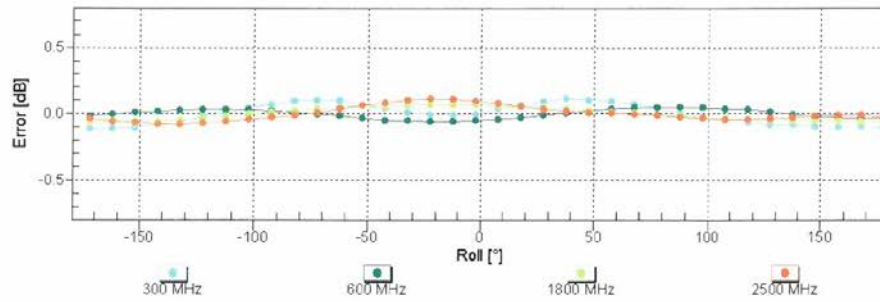

Uncertainty of Axial Isotropy Assessment: $\pm 0.5\%$ (k=2)

Receiving Pattern (ϕ), $\vartheta = 90^\circ$

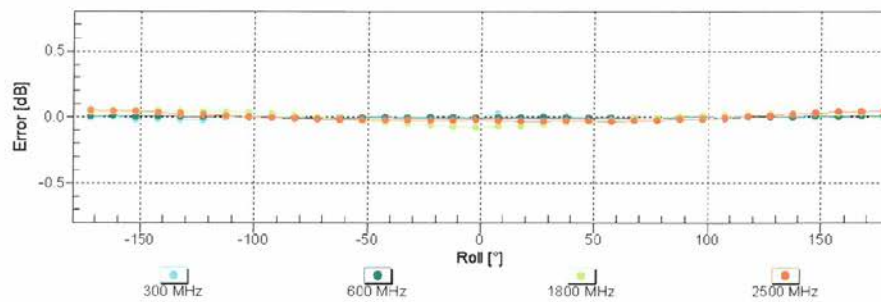

Uncertainty of Axial Isotropy Assessment: $\pm 0.5\%$ (k=2)

H3DV6- SN:6260

January 27, 2014

Dynamic Range f(H-field) (TEM cell, f = 900 MHz)

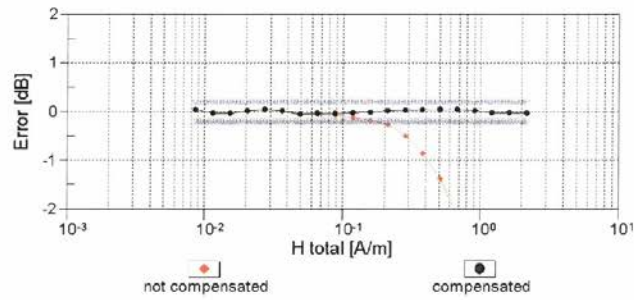
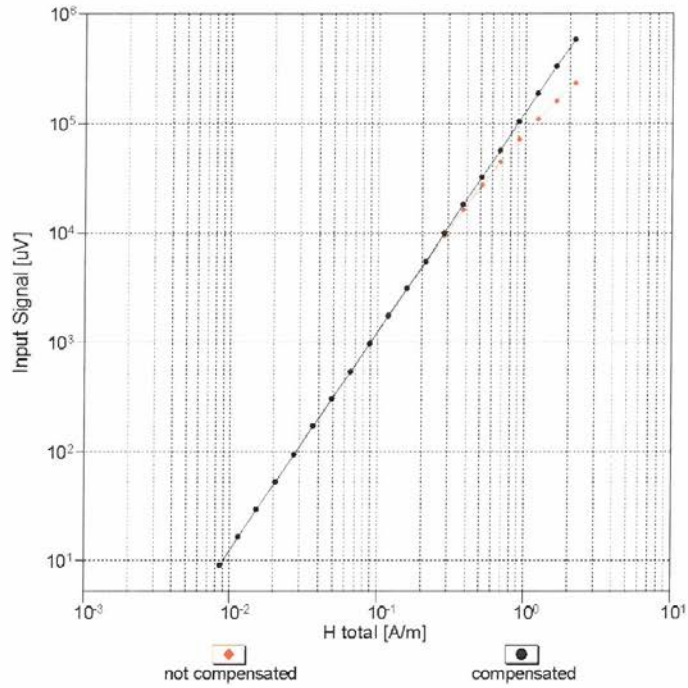

Uncertainty of Linearity Assessment: $\pm 0.6\%$ (k=2)

H3DV6-SN:6260

January 27, 2014

Deviation from Isotropy in Air Error (ϕ , θ), $f = 900$ MHz

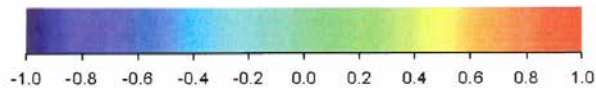
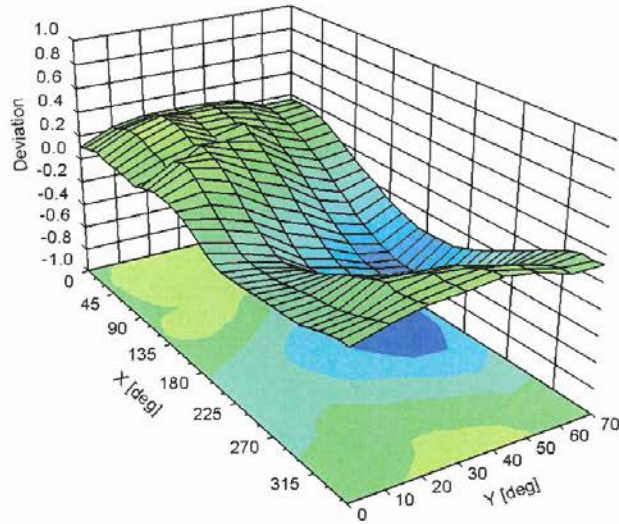

Uncertainty of Spherical Isotropy Assessment: $\pm 2.6\%$ ($k=2$)

H3DV6-- SN:6260

January 27, 2014

DASY/EASY - Parameters of Probe: H3DV6 - SN:6260

Other Probe Parameters

Sensor Arrangement	Rectangular
Connector Angle (°)	-152.4
Mechanical Surface Detection Mode	enabled
Optical Surface Detection Mode	disabled
Probe Overall Length	337 mm
Probe Body Diameter	10 mm
Tip Length	20 mm
Tip Diameter	6 mm
Probe Tip to Sensor X Calibration Point	3 mm
Probe Tip to Sensor Y Calibration Point	3 mm
Probe Tip to Sensor Z Calibration Point	3 mm