

PART2 TEST REPORT

Applicant: Guangdong OPPO Mobile Telecommunications Corp., Ltd.
Address: NO.18 HaiBin Road, Wusha Village, Chang'an Town, DongGuan City, Guangdong Province, P.R. China
Equipment Type: Mobile Phone
Model Name: CPH2743
Brand Name: OPPO
FCC ID: R9C-OP24335
Test Standard: FCC 47 CFR Part 2.1093
Test Date: Apr. 03, 2025
Test Date: May 16, 2025 - May 18, 2025
Date of Issue: May 22, 2025

ISSUED BY:

Shenzhen BALUN Technology Co., Ltd.

Tested by: Zhang Jiwei

Checked by: Xu Rui

Approved by: Tolan Tu

(Testing Director)

Zhang Jiwei

Xu Rui

Tolan Tu

Revision History		
Version	Issue Date	Revisions Content
<u>Rev. 01</u>	<u>May 22, 2025</u>	<u>Initial Issue</u>

TABLE OF CONTENTS

1	GENERAL INFORMATION.....	4
1.1	Test Laboratory	4
1.2	Test Location	4
1.3	Test Environment Condition.....	4
2	PRODUCT INFORMATION	5
2.1	Applicant Information	5
2.2	Manufacturer Information.....	5
2.3	General Description for Equipment under Test (EUT).....	5
2.4	Ancillary Equipment.....	5
2.5	Technical Information	6
3	INTRODUCTION	8
3.1	Time-Averaging Algorithm for RF Exposure Compliance	8
3.2	Bibliography.....	8
4	RF EXPOSURE LIMITS.....	9
4.1	Device Category and SAR Limit	9
5	TIME VARYING TRANSMISSION TEST CASES	10
6	FCC MEASUREMENT PROCEDURES.....	12
6.1	Test Sequence Determination for Validation.....	12
6.2	Test Configuration Selection Criteria for Validating Smart Transmit Feature.....	12
6.3	Test Procedures for Conducted Power Measurements.....	17
6.4	Test Procedures for Time-varying SAR Measurements	26
7	MEASUREMENT TEST SETSUP	28
7.1	Conducted Measurement Test Setup	28
7.2	SAR Measurement Setup	30

8	TEST CONFIGURATIONS	31
8.1	WWAN (sun-6) transmission.....	31
8.2	<i>P_{max}</i> and <i>P_{limit}</i> Measurement Results	46
8.3	Time-varying TX Power Measurement Results.....	50
8.4	Call Drop Test Results.....	67
8.5	Change in Technology/Band, Antenna and DSI switch Test Case	68
8.6	Change in Time Windows Switch Test Results	69
8.7	Switch in SAR Exposure Test Results(EN-DC Combination).....	72
8.8	Exposure Category Switch.....	74
9	SAR TEST RESULT for Sub-6 SMART TRANSMIT FEATURE VALIDATION	76
9.6	SAR Measurement for Time-varying Tx Power Scenario	76
10	TEST EQUIPMENTS LIST	93
11	CONCLUSIONS	94
ANNEX A	TEST SQUENCES	95
ANNEX B	TEST PROCEDURES for SUB-6 GHz NR + LTE RADIO	97
ANNEX C	DASY 8 SYSTEM VERIFIVATION.....	99
ANNEX D	Calibration Report.....	112
ANNEX E	TEST SETUP PHOTOS	112

1 GENERAL INFORMATION

1.1 Test Laboratory

Name	Shenzhen BALUN Technology Co., Ltd.
Address	Block B, 1/F, Baisha Science and Technology Park, Shahe Xi Road, Nanshan District, Shenzhen, Guangdong Province, P. R. China
Phone Number	+86 755 6685 0100

1.2 Test Location

Name	Shenzhen BALUN Technology Co., Ltd.
Location	<input type="checkbox"/> Block B, 1/F, Baisha Science and Technology Park, Shahe Xi Road, Nanshan District, Shenzhen, Guangdong Province, P. R. China
	<input checked="" type="checkbox"/> 1/F, Building B, Ganghongji High-tech Intelligent Industrial Park, No. 1008, Songbai Road, Yangguang Community, Xili Sub-district, Nanshan District, Shenzhen, Guangdong Province, P. R. China
Accreditation Certificate	The laboratory is a testing organization accredited by FCC as a accredited testing laboratory. The designation number is CN1196.

1.3 Test Environment Condition

Ambient Temperature	18°C to 25°C
Ambient Relative Humidity	30% to 70%

2 PRODUCT INFORMATION

2.1 Applicant Information

Applicant	Guangdong OPPO Mobile Telecommunications Corp., Ltd.
Address	NO.18 HaiBin Road, Wusha Village, Chang'an Town, DongGuan City, Guangdong Province, P.R. China

2.2 Manufacturer Information

Applicant	Guangdong OPPO Mobile Telecommunications Corp., Ltd.
Address	NO.18 HaiBin Road, Wusha Village, Chang'an Town, DongGuan City, Guangdong Province, P.R. China

2.3 General Description for Equipment under Test (EUT)

EUT Name	Mobile Phone
Model Name Under Test	CPH2743
Series Model Name	N/A
Description of Model name differentiation	N/A
Hardware Version	11
Software Version	ColorOS 15.0
Dimensions (Approx.)	N/A
Weight (Approx.)	N/A
EUT ID	S07, S09
IMEI Number	S07: IMEI1: 860247070022690; IMEI2: 860247070022682
	S09: IMEI1: 860247070037177; IMEI2: 860247070037169
Note1: EUT ID is used to identify the test sample in the lab internally.	
Note2: It is performed to test SAR with the EUT S07 and conducted power with the EUT S09.	

2.4 Ancillary Equipment

Please refer the document "BL-SZ2530966-AW EUT external photo.pdf".

2.5 Technical Information

Network and Wireless connectivity	<p>2G Network GSM/GPRS/EDGE 850/900/1900</p> <p>3G Network WCDMA/HSDPA/HSUPA Band 2/4/5/8</p> <p>4G Network FDD LTE Band 2/4/5/7/8/12/13/17/18/19/26/28/66 TDD LTE Band 38/41/48</p> <p>LTE CA Uplink (UL): CA_2C, CA_7C, CA_38C, CA_41C, CA_4A-5A, CA_5A-7A, CA_5A-66A</p> <p>5G Network SA: NR n2/n5/n7/n12/n26/n38/n41/n66 NSA(EN-DC): DC_7A_n5A, DC_66A_n5A, DC_2A_n7A, DC_4A_n7A, DC_5A_n7A, DC_66A_n7A, DC_7A_n26A, DC_2A_n38A, DC_4A_n38A, DC_5A_n38A, DC_66A_n38A, DC_2A_n41A, DC_4A_n41A, DC_26A_n41A, DC_66A_n41A, DC_2A_n66A, DC_5A_n66A, DC_7A_n66A, DC_12A_n66A</p> <p>Bluetooth (BR+EDR+BLE)</p> <p>2.4G WIFI 802.11b, 802.11g, 802.11n(HT20/40), VHT20/40</p> <p>5G WIFI 802.11a, 802.11n(HT20/40), 802.11ac(VHT20/40/80)</p> <p>GNSS, NFC</p>
<p>Note:</p> <p>The EUT is a mobile phone, which supports dual SIM card under the same transceiver. Each SIM supports GSM, WCDMA LTE and NR, and both SIM share the same transmitting electro circuit, NV parameters, so only SIM1 was tested in this report.</p>	

The requirement for the following technical information of the EUT was tested in this report:

Operating Mode	GSM, WCDMA, LTE, 2.4G WIFI, 5G WIFI, Bluetooth		
Frequency Range	GSM 850	TX: 824 ~ 849 MHz	RX: 869 ~ 894 MHz
	GSM 900	TX: 880 ~ 915 MHz	RX: 925 ~ 960 MHz
	GSM 1900	TX: 1850 ~ 1910 MHz	RX: 1930 ~ 1990 MHz
	WCDMA Band 2	TX: 1850 ~ 1910 MHz	RX: 1930 ~ 1990 MHz
	WCDMA Band 4	TX: 1710 ~ 1755 MHz	RX: 2110 ~ 2155 MHz
	WCDMA Band 5	TX: 824 ~ 849 MHz	RX: 869 ~ 894 MHz
	WCDMA Band 8	TX: 880 ~ 915 MHz	RX: 925 ~ 960 MHz
	LTE Band 2	TX: 1850 ~ 1910 MHz	RX: 1930 ~ 1990 MHz
	LTE Band 4	TX: 1710 ~ 1755 MHz	RX: 2110 ~ 2155 MHz
	LTE Band 5	TX: 824 ~ 849 MHz	RX: 869 ~ 894 MHz
	LTE Band 7	TX: 2500 ~ 2570 MHz	RX: 2620 ~ 2690 MHz
	LTE Band 8	TX: 880 ~ 915 MHz	RX: 925 ~ 960 MHz
	LTE Band 12	TX: 699 ~ 716 MHz	RX: 729 ~ 746 MHz
	LTE Band 13	TX: 777 ~ 787 MHz	RX: 746 ~ 756 MHz
	LTE Band 17	TX: 704 ~ 716 MHz	RX: 734 ~ 746 MHz
	LTE Band 18	TX: 815 ~ 824 MHz	RX: 860 ~ 869 MHz
		TX: 824 ~ 830 MHz	RX: 869 ~ 875 MHz
LTE Band 19	TX: 830 ~ 845 MHz	RX: 875 ~ 890 MHz	

	LTE Band 26	TX: 814 ~ 824 MHz	RX: 859 ~ 869 MHz
		TX: 824 ~ 849 MHz	RX: 869 ~ 894 MHz
	LTE Band 66	TX: 1710 ~ 1780 MHz	RX: 2110 ~ 2180 MHz
	LTE Band 38	TX: 2570 ~ 2620 MHz	RX: 2570 ~ 2620 MHz
	LTE Band 41	TX: 2496 ~ 2690 MHz	RX: 2496 ~ 2690 MHz
	LTE Band 48	TX: 3550 ~ 3700 MHz	RX: 3550 ~ 3700 MHz
	NR n2	TX: 1850 ~ 1910 MHz	RX: 1930 ~ 1990 MHz
	NR n5	TX: 824 ~ 849 MHz	RX: 869 ~ 894 MHz
	NR n7	TX: 2500 ~ 2570 MHz	RX: 2620 ~ 2690 MHz
	NR n12	TX: 699 ~ 716 MHz	RX: 729 ~ 746 MHz
	NR n26	TX: 814 ~ 824 MHz	RX: 859 ~ 869 MHz
		TX: 824 ~ 849 MHz	RX: 869 ~ 894 MHz
	NR n38	TX: 2570 ~ 2620 MHz	RX: 2570 ~ 2620 MHz
	NR n41	TX: 2496 ~ 2690 MHz	RX: 2496 ~ 2690 MHz
	NR n66	TX: 1710 ~ 1780 MHz	RX: 2110 ~ 2180 MHz
	802.11b/g /n(HT20/HT40)	2412 ~ 2462 MHz	
	VHT20/40	2412 ~ 2462 MHz	
	802.11a/ /n(HT20/HT40) /ac(VHT20/VHT40/ VHT80)	5150 ~ 5250 MHz	
		5250 ~ 5350 MHz	
		5470 ~ 5725 MHz	
5725 ~ 5850 MHz			
Bluetooth	2402 ~ 2480 MHz		
NFC	13.56 MHz		
Antenna Type	WWAN: IFA Antenna WIFI: IFA Antenna Bluetooth: IFA Antenna NFC: Coil Antenna		
DTM	N/A		
Hotspot Function	Support		
Power Reduction	Support		
Exposure Category	General Population/Uncontrolled exposure		
Product Type	Portable Device		
EUT Type	<input checked="" type="checkbox"/> Production unit	<input type="checkbox"/> Identical prototype	

3 INTRODUCTION

3.1 Time-Averaging Algorithm for RF Exposure Compliance

This equipment is enabled with Qualcomm modem supporting 2G/3G/4G technologies and 5G NR bands. All bands are enabled with Qualcomm Smart Transmit feature to control and manage transmitting power in real time and to ensure at all times the time-averaged RF exposure is in compliance with the FCC requirement.

This purpose of the Part 2 report is to demonstrate the EUT complies with FCC RF exposure requirement under Tx varying transmission scenarios, thereby validity of Qualcomm Smart Transmit feature for FCC equipment authorization.

3.2 Bibliography

Report Description	Report Serial Number
FCC Part0 SAR Characterization Report	BL-SZ2530966-703
FCC Part1 SAR Test Report	BL-SZ2530966-701
FCC Part 2 RF Exposure Test Report	BL-SZ2530966-702

4 RF EXPOSURE LIMITS

4.1 Device Category and SAR Limit

This device belongs to portable device category because its radiating structure is allowed to be used within 20 centimeters of the body of the user.

Limit for General Population/Uncontrolled exposure should be applied for this device, it is 1.6 W/kg as averaged over any 1 gram of tissue.

Table of Exposure Limits:

Body Position	SAR Value (W/Kg)	
	General Population/ Uncontrolled Exposure	Occupational/ Controlled Exposure
Whole-Body SAR (averaged over the entire body)	0.08	0.4
Partial-Body SAR (averaged over any 1 gram of tissue)	1.60	8.0
SAR for hands, wrists, feet and ankles (averaged over any 10 grams of tissue)	4.0	20.0

NOTE:

General Population/Uncontrolled Exposure: Locations where there is the exposure of individuals who have no knowledge or control of their exposure. General population/uncontrolled exposure limits are applicable to situations in which the general public may be exposed or in which persons who are exposed as a consequence of their employment may not be made fully aware of the potential for exposure or cannot exercise control over their exposure. Members of the general public would come under this category when exposure is not employment-related; for example, in the case of a wireless transmitter that exposes persons in its vicinity.

Occupational/Controlled Exposure: Locations where there is exposure that may be incurred by persons who are aware of the potential for exposure, In general, occupational/controlled exposure limits are applicable to situations in which persons are exposed as a consequence of their employment, who have been made fully aware of the potential for exposure and can exercise control over their exposure. This exposure category is also applicable when the exposure is of a transient nature due to incidental passage through a location where the exposure levels may be higher than the general population/uncontrolled limits, but the exposed person is fully aware of the potential for exposure and can exercise control over his or her exposure by leaving the area or by some other appropriate means.

5 TIME VARYING TRANSMISSION TEST CASES

To validate time averaging feature and demonstrate the compliance in Tx varying transmission conditions, the following transmission scenarios are covered in Part 2

1. During a time-varying Tx power transmission: To prove that the Smart Transmit feature accounts for Tx power variations in time accurately.
2. During a call disconnect and re-establish scenario: To prove that the Smart Transmit feature accounts for history of past Tx power transmissions accurately.
3. During technology/band handover: To prove that the Smart Transmit feature functions correctly during transitions in technology/band.
4. During DSI (Device State Index) change: To prove that the Smart Transmit feature functions correctly during transition from one device state (DSI) to another.
5. During antenna (or beam) switch: To prove that the Smart Transmit feature functions correctly during transitions in antenna (such as AsDiv scenario) or beams (different antenna array configurations).
6. During time window switch: To prove that the Smart Transmit feature correctly handles the transition from one time window to another specified by FCC, and maintains the normalized time-averaged RF exposure to be less than FCC limit of 1.0 at all times.
7. SAR exposure switching between two active radios (radio1 and radio2): To prove that the Smart Transmit feature functions correctly and ensures total RF exposure compliance when exposure varies among SAR_radio1 only, SAR_radio1 + SAR_radio2, and SAR_radio2 only scenarios.

As described in Part 0 report, the RF exposure is proportional to the Tx power for a SAR -characterized wireless device. Thus, feature validation in Part 2 can be effectively performed through conducted and radiated power measurement. Therefore, the compliance demonstration under dynamic transmission conditions and feature validation are done in conducted/radiated power measurement setup for transmission scenario 1 through 8.

To add confidence in the feature validation, the time-averaged SAR measurements are also performed but only performed for transmission scenario 1 to avoid the complexity in SAR measurement (such as, for scenario 3 requiring change in SAR probe calibration file to accommodate different bands and/or tissue simulating liquid).

The strategy for testing in Tx varying transmission condition is outlined as follows:

- Demonstrate the total RF exposure averaged over FCC defined time windows does not exceed FCC's SAR limits, through time-averaged power measurements
 - Measure conducted Tx power (for $f < 6\text{GHz}$) versus time, and radiated Tx power (EIRP for $f > 10\text{GHz}$) versus time.
 - Convert it into RF exposure and divide by respective FCC limits to get normalized exposure versus time.
 - Perform running time-averaging over FCC defined time windows.
 - Demonstrate that the total normalized time-averaged RF exposure is less than 1 for all transmission scenarios at all times.

Mathematical expression:

--For sub-6 transmission only:

$$1g_or_10gSAR(t) = \frac{\text{conducted_Tx_power}(t)}{\text{conducted_Tx_power_P_limit}} * 1g_or_10gSAR_P_limit \quad (1a)$$

$$\frac{\frac{1}{T_{SAR}} \int_{t-T_{SAR}}^t 1g_or_10gSAR(t) dt}{FCC\ SAR\ limit} \leq 1 \quad (1b)$$

where, $conducted_Tx_power(t)$, $conducted_Tx_power_P_{limit}$, and $1g_or_10gSAR_P_{limit}$ correspond to the measured instantaneous conducted Tx power, measured conducted Tx power at P_{limit} and measured $1gSAR$ or $10gSAR$ values at P_{limit} corresponding to sub-6 transmission.

- Demonstrate the total RF exposure averaged over FCC defined time windows does not exceed FCC's SAR limits, through time-averaged SAR measurements. Note as mentioned earlier, this measurement is performed for transmission scenario 1 only.
 - For sub-6 transmission only, measure instantaneous SAR versus time; for LTE+ sub6 NR transmission, request low power (or all-down bits) on LTE so that measured SAR predominantly corresponds to sub6 NR.
 - Convert it into RF exposure and divide by respective FCC limits to obtain normalized exposure versus time.
 - Perform time averaging over FCC defined time window.
 - Demonstrate that the total normalized time-averaged RF exposure is less than 1 for transmission scenario 1 at all times.

Mathematical expression:

--For sub-6 transmission only:

$$1g_or_10gSAR(t) = \frac{pointSAR(t)}{pointSAR_P_{limit}} * 1g_or_10gSAR_P_{limit} \quad (3a)$$

$$\frac{\frac{1}{T_{SAR}} \int_{t-T_{SAR}}^t 1g_or_10gSAR(t) dt}{FCC\ SAR\ limit} \leq 1 \quad (3b)$$

where, $pointSAR(t)$, $pointSAR_P_{limit}$, and $1g_or_10gSAR_P_{limit}$ correspond to the measured instantaneous point SAR, measured point SAR at P_{limit} , and measured $1gSAR$ or $10gSAR$ values at P_{limit} corresponding to sub-6 transmission.

Note: cDASY6 measurement system by Schmid & Partner Engineering AG (SPEAG) of Zurich,

Switzerland measures relative E-field, and provides ratio of $\frac{[pointE(t)]^2}{[pointE_{input.power.limit}]^2}$ versus time.

6 FCC MEASUREMENT PROCEDURES

This chapter provides the test plan and test procedure for validating Qualcomm Smart Transmit feature for sub-6 transmission. The 100 seconds time window for operating $f < 3\text{GHz}$ is used as an example to detail the test procedures in this chapter

6.1 Test Sequence Determination for Validation

Following the FCC recommendation, two test sequences having time-variation in Tx power are predefined for sub-6 ($f < 6\text{GHz}$) validation:

- Test sequence 1: request EUT's Tx power to be at maximum power, measured P_{max} for 80s, then requesting for half of the maximum power, i.e., measured $P_{max}/2$, for the rest of the time.
- Test sequence 2: request EUT's Tx power to vary with time. This sequence is generated relative to measured P_{max} , measured P_{limit} and calculated $P_{reserve}$ (= measured P_{limit} in dBm - Reserve_power_margin in dB) of EUT based on measured P_{limit} .

The details for generating these two test sequences is described and listed in Annex A.

Note: For test sequence generation, “measured P_{limit} ” and “measured P_{max} ” are used instead of the “ P_{limit} ” specified in EFS entry and “Pmax” specified for the device, because Smart Transmit feature operates against the actual power level of the “ P_{limit} ” that was calibrated for the EUT. The “measured P_{limit} ” accurately reflects what the feature is referencing to, therefore, it should be used during feature validation testing. The RF tune up and device-to-device variation are already considered in Part 0 report prior to determining P_{limit} .

6.2 Test Configuration Selection Criteria for Validating Smart Transmit Feature

For validating Smart Transmit feature, this section provides a general guidance to select test cases. In practice, an adjustment can be made in test case selection. The justification/clarification may be provided.

6.2.1 Test Configuration Selection for Time-varying Tx power Transmission

The Smart Transmit time averaging feature operation is independent of bands, modes, and channels for a given technology. Hence, validation of Smart Transmit in one band/mode/channel per technology is sufficient.

The criteria for the selection are based on the P_{limit} values determined in Part 1 report. Select the band in each supported technology that corresponds to the P_{limit} value that is less than P_{max} for validating Smart Transmit.

Note: this test is designed for single radio transmission scenario. If UE supports sub6 NR in both non-standalone (NSA) and standalone (SA) modes, then validation in time-varying Tx power transmission scenario described in this section needs to be performed in SA mode. Otherwise, it needs to be performed in NSA mode with LTE anchor set to low power. The choice between SA and NSA mode needs to also take into account the selection criteria described below. In general, one mode out of the two modes (NSA or SA) is sufficient for this test.

6.2.2 Test Configuration Selection for Change in call

The criteria to select a test configuration for call-drop measurement is:

- Select technology/band with least P_{limit} among all supported technologies/bands, and select the radio configuration (e.g., # of RBs, channel#) in this technology/band that corresponds to the highest *measured* 1gSAR at P_{limit} listed in Part 1 report.
- In case of multiple bands having same least P_{limit} , then select the band having the highest *measured* 1gSAR at P_{limit} in Part 1 report.

This test is performed with the EUT's Tx power requested to be at maximum power, the above band selection will result in Tx power enforcement (i.e., EUT forced to have Tx power at $P_{reserve}$) for longest duration in one FCC defined time window. The call change (call drop/reestablish) is performed during the Tx power enforcement duration (i.e., during the time when EUT is forced to have Tx power at $P_{reserve}$). One test is sufficient as the feature operation is independent of technology and band

6.2.3 Test Configuration Selection for Change in Technology/band

The selection criteria for this measurement is, for a given antenna, to have EUT switch from a technology/band with lowest P_{limit} within the technology group (in case of multiple bands having the same P_{limit} , then select the band with highest *measured* 1gSAR at P_{limit}) to a technology/band with highest P_{limit} within the technology group, in case of multiple bands having the same P_{limit} , then select the band with lowest *measured* 1gSAR at P_{limit} in Part 1 report, or vice versa.

This test is performed with the EUT's Tx power requested to be at maximum power, the technology/band switch is performed during Tx power enforcement duration (i.e., during the time when EUT is forced to have Tx power at $P_{reserve}$).

6.2.4 Test Configuration Selection for Change in Time Windows

FCC specifies different time window for time averaging based on operation frequency.

The criteria to select a test configuration for validating Smart Transmit feature and demonstrating the compliance during the change in time window is

- Select any technology/band that has operation frequency classified in one time window defined by FCC (such as 100-seconds time window), and its corresponding P_{limit} is less than P_{max} if possible.
- Select the 2nd technology/band that has operation frequency classified in a different time window defined by FCC (such as 60-seconds time window), and its corresponding P_{limit} is less than P_{max} if possible.
- It is preferred both P_{limit} values of two selected technology/band less than corresponding P_{max} if, but if not possible, at least one of technologies/bands has its P_{limit} less than P_{max} .

This test is performed with the EUT's Tx power requested to be at maximum power in selected technology/band. Test for one pair of time windows selected is sufficient as the feature operation is the same.

6.2.5 Test Configuration Selection for Change in DSI

The criteria to select a test configuration for DSI change test is

Select a technology/band having the $P_{limit} < P_{max}$ within any technology and DSI group, and for the same technology/band having a different P_{limit} in any other DSI group. Note that the selected DSI transition need to be supported by the device.

This test is performed with the EUT's Tx power requested to be at maximum power in selected technology/band, and DSI change is conducted during Tx power enforcement duration (i.e., during the time when EUT is forced to have Tx power at $P_{reserve}$).

6.2.6 Test Configuration Selection for SAR Exposure Switching

If supported, the test configuration for SAR exposure switching should cover

1. SAR exposure switch when two active radios are in the same time window
2. SAR exposure switch when two active radios are in different time windows. One test with two active radios in any two different time windows is sufficient as Smart Transmit operation is the same for RF exposure switch in any combination of two different time windows.

The Smart Transmit time averaging operation is independent of the source of SAR exposure (for example, LTE vs. Sub6 NR) and ensures total time-averaged RF exposure compliance. Hence, validation of Smart Transmit in any one simultaneous SAR transmission scenario (i.e., one combination for LTE + Sub6 NR transmission) is sufficient, where the SAR exposure varies among SARradio1 only, SARradio1 + SARradio2, and SARradio2 only scenarios.

The criteria to select a test configuration for validating Smart Transmit feature during SAR exposure switching scenarios is

- Select any two < 6GHz technologies/bands that the EUT supports simultaneous transmission (for example, LTE+ Sub6 NR).
- Among all supported simultaneous transmission configurations, the selection order is
 1. select one configuration where both P_{limit} of radio1 and radio2 is less than their corresponding P_{max} , preferably, with different P_{limits} . If this configuration is not available, then,
 2. select one configuration that has P_{limit} less than its P_{max} for at least one radio. If this can not be found, then,
 3. select one configuration that has P_{limit} of radio1 and radio2 greater than P_{max} but with least $(P_{limit} - P_{max})$ delta.

Test for one simultaneous transmission scenario is sufficient as the feature operation is the same

6.2.7 Test Configuration Selection for exposure category switch

The criteria to select a test configuration for exposure category switch measurement is:

If the device's intended exposure mode is configured for time averaged exposure mode operation, then:

If $P_{limit} < P_{max}$ for at least one radio out of all supported technology/band/antenna/DSI, then:

1) Out of all head exposure DSIs, select a technology/band/antenna/DSI having the least P_{limit} ($< P_{max}$), furthermore, having the largest difference between P_{max} and P_{limit} ($P_{limit} < P_{max}$) should be considered in the selection. Then, select a second DSI in the non-head exposure category DSI that has the least P_{limit} among all the non-head DSIs for the same technology/band/antenna. This technology/band/antenna and selected DSIs are used for head to non-head to head exposure switch test. If the $P_{limit} > P_{max}$ for all supported technology/band/antenna/DSI in head exposure category, then this test is not required.

2) Similarly, out of all non-head exposure DSIs, select a technology/band/antenna/DSI having the least P_{limit} ($< P_{max}$), furthermore, having the largest difference between P_{max} and P_{limit} ($P_{limit} < P_{max}$) should be considered in the selection. Then, select a second DSI in the head exposure category DSI that has the least P_{limit} among all the head DSIs for the same technology/band/antenna. This technology/band/antenna and selected DSIs are used for non-head to head to non-head exposure switch test. If the $P_{limit} > P_{max}$ for all supported technology/band/antenna/DSI in non-head exposure category, then this test is not required.

If $P_{limit} > P_{max}$ for all supported technology/band/antenna/DSIs for both head and non-head DSI categories, then:

3) select a supported sub6 simultaneous transmission scenario (like LTE + FR1 NSA or FR1 interband NR-DC, etc.) in head DSI that has $P_{limit} < P_{max} + 10 \cdot \log(N)$ for all radios of selected technology(s)/band(s)/antenna(s), where N is the number of active radios in selected sub6 simultaneous transmission scenario. Note that the antennas determined for the selected radios of simultaneous transmission scenario should be in the same antenna group if EUT is configured with GEN2_SUB6 or GEN2_SUB6_MMW. Then, select a second DSI in the non-head exposure category that has the lowest P_{limit} among all the non-head DSIs for all the radios of the selected technology(s)/band(s)/antenna(s) simultaneous transmission scenario. This selected technology(s)/band(s)/antenna(s) and selected DSIs are used for head to non-head to head exposure switch test. If the head DSI has $P_{limit} > P_{max} + 10 \cdot \log(N)$ for all radios supported in sub6 simultaneous transmission scenarios, then this test is not required.

4) select a supported sub6 simultaneous transmission scenario (like LTE + FR1 NSA, or FR1 interband NR-DC, etc.) in non-head DSI that has $P_{limit} < P_{max} + 10 \cdot \log(N)$ for all radios of the selected technology(s)/band(s)/antenna(s), where N is the number of active radios in selected sub6 simultaneous transmission scenario.

Note that the antennas determined for the selected radios of simultaneous transmission scenario should be in the same antenna group if EUT is configured with GEN2_SUB6 or GEN2_SUB6_MMW. Then, select a second DSI in the head exposure category that has the lowest P_{limit} among all the head DSIs for all the radios of the selected technology(s)/band(s)/antenna(s) simultaneous transmission scenario. This selected technology(s)/band(s)/antenna(s) and selected DSIs are used for non-head to head to non-head exposure

switch test. If the non-head DSI has $P_{limit} > P_{max} + 10 \cdot \log(N)$ for all radios supported in sub6 simultaneous transmission scenarios, then this test is not required.

Use the highest measured 1g_or_10g SAR at P_{limit} ($P_{limit} < P_{max}$) shown in Part 1 report for the selected tech/band/antenna/DSI out of all radio configurations and device positions to calculate time-varying SAR. However, in the case of $P_{limit} > P_{max}$, the SAR measured in Part 1 report for the corresponding radio configuration selected and tested in Part 2 should be applied.

If the device's intended exposure mode is configured for peak exposure mode operation, then:

1) Select a supported sub6 simultaneous transmission scenario (like LTE + FR1 NSA, or FR1 interband NR-DC, etc.) in head DSI that has $P_{limit} < P_{max} + 10 \cdot \log(N)$ for all radios of selected technology(s)/band(s)/antenna(s), where N is the number of active radios in selected sub6 simultaneous transmission scenario. Note that the antennas determined for the selected radios of simultaneous transmission scenario should be in the same antenna group if EUT is configured with GEN2_SUB6 or GEN2_SUB6_MMW. Then, select a second DSI in the non-head exposure category that has the lowest P_{limit} among all the non-head DSIs for all the radios of the selected technology(s)/band(s)/antenna(s) simultaneous transmission scenario. This selected technology(s)/band(s)/antenna(s) and selected DSIs are used for head to non-head to head exposure switch test. If the head DSI has $P_{limit} > P_{max} + 10 \cdot \log(N)$ for all radios supported in sub6 simultaneous transmission scenarios, then this test is not required.

2) Select a supported sub6 simultaneous transmission scenario (like LTE + FR1 NSA, or FR1 interband NR-DC, etc.) in non-head DSI that has $P_{limit} < P_{max} + 10 \cdot \log(N)$ for all radios of the selected technology(s)/band(s)/antenna(s), where N is the number of active radios in selected sub6 simultaneous transmission scenario. Note that the antennas determined for the selected radios of simultaneous transmission scenario should be in the same antenna group if EUT is configured with GEN2_SUB6 or GEN2_SUB6_MMW. Then,

select a second DSI in the head exposure category that has the lowest P_{limit} among all the head DSIs for all the radios of the selected technology(s)/band(s)/antenna(s) simultaneous transmission scenario. This selected technology(s)/band(s)/antenna(s) and selected DSIs are used for non-head to head to non-head exposure switch test. If the non-head DSI has $P_{limit} > P_{max} + 10 \cdot \log(N)$ for all radios supported in sub6 simultaneous transmission scenarios, then this test is not required.

Use the highest measured 1g_or_10g SAR at P_{limit} ($P_{limit} < P_{max}$) shown in Part 1 report for the selected tech/band/antenna/DSI out of all radio configurations and device positions to calculate time-varying SAR. However, in the case of $P_{limit} > P_{max}$, the SAR measured in Part 1 report for the corresponding radio configuration selected and tested in Part 2 should be applied.

6.3 Test Procedures for Conducted Power Measurements

This section provides general conducted power measurement procedures to perform compliance test under dynamic transmission scenarios described in Section 5. In practice, an adjustment can be made in these procedures. The justification/clarification may be provided.

6.3.1 Time-varying Tx power Transmission Scenario

This test is performed with the two pre-defined test sequences described in Section 6.1 for all the technologies and bands selected in Section 6.2.1. The purpose of the test is to demonstrate the effectiveness of power limiting enforcement and that the time-averaged SAR (corresponding time-averaged Tx power) does not exceed the FCC limit at all times (see Eq. (1a) and (1b)).

Test procedure

1. Measure P_{max} , measure P_{limit} and calculate $P_{reserve}$ (= measured P_{limit} in dBm – Reserve_power_margin in dB) and follow Section 6.1 to generate the test sequences for all the technologies and bands selected in Section 6.2.1. Both test sequence 1 and test sequence 2 are created based on measured P_{max} and measured P_{limit} of the EUT. Test condition to measure P_{max} and P_{limit} is:
 - Measure P_{max} with Smart Transmit disabled and callbox set to request maximum power.
 - Measure P_{limit} with Smart Transmit enabled and Reserve_power_margin set to 0 dB, callbox set to request maximum power.
2. Set Reserve_power_margin to actual (intended) value (3dB for this EUT based on Part 1 report) and reset power on EUT to enable Smart Transmit, establish radio link in desired radio configuration, with callbox requesting the EUT’s Tx power to be at pre-defined test sequence 1, measure and record Tx power versus time, and then convert the conducted Tx power into 1gSAR or 10gSAR value (see Eq. (1a)) using measured P_{limit} from above Step 1. Perform running time average to determine timeaveraged power and 1gSAR or 10gSAR versus time as illustrated in Figure 6-1 where using 100-seconds time window as an example.

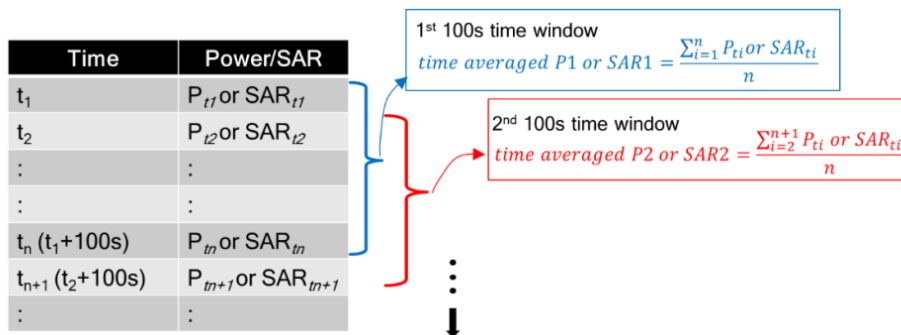

Figure 6-1 100s running average illustration

Note1: In Eq.(1a), instantaneous Tx power is converted into instantaneous 1gSAR or 10gSAR value by applying the measured worst-case 1gSAR or 10gSAR value at P_{limit} for the corresponding technology/band/antenna/DSI reported in Part 1 report.

Note2: For an easier computation of the running time average, 0 dBm can be added at the beginning of the test sequences the length of the responding time window, for example, add 0dBm for 100-seconds so the running time average can be directly performed starting with the first 100-seconds data using excel spreadsheet. This technique applies to all tests performed in this Part 2 report for easier time-averaged computation using excel spreadsheet.

3. Make one plot containing:
 - a) Instantaneous Tx power versus time measured in Step 2,
 - b) Requested Tx power used in Step 2 (test sequence 1),
 - c) Computed time-averaged power versus time determined in Step 2,
 - d) Time-averaged power limit (corresponding to FCC SAR limit of 1.6 W/kg for 1gSAR or 4.0W/kg for 10gSAR) given by

$$\text{Time average power limit} = \text{meas. } P_{\text{limit}} + 10 \log \left(\frac{\text{FCC SAR limit}}{\text{meas.SAR_Plimit}} \right) \quad (5a)$$

where $\text{meas. } P_{\text{limit}}$ and meas.SAR_Plimit correspond to measured power at P_{limit} and measured SAR at P_{limit} .

4. Make another plot containing:
 - a) Computed time-averaged 1gSAR or 10gSAR versus time determined in Step 2
 - b) FCC 1gSARlimit of 1.6W/kg or FCC 10gSARlimit of 4.0W/kg
5. Repeat Steps 2 ~ 4 for pre-defined test sequence 2 and replace the requested Tx power (test sequence 1) in Step 2 with test sequence 2.
6. Repeat Steps 2 ~ 5 for all the selected technologies and bands.

The validation criteria are, at all times, the time-averaged power versus time shown in Step 3 plot shall not exceed the time-averaged power limit (defined in Eq. (5a)), in turn, the time-averaged 1gSAR or 10gSAR versus time shown in Step 4 plot shall not exceed the FCC limit of 1.6 W/kg for 1gSAR or 4.0 W/kg for 10gSAR (i.e., Eq. (1b)).

6.3.2 Change in call Scenario

This test is to demonstrate that Smart Transmit feature accurately accounts for the past Tx powers during time-averaging when a new call is established.

The call disconnect and re-establishment needs to be performed during power limit enforcement, i.e., when the EUT's Tx power is at P_{reserve} level, to demonstrate the continuity of RF exposure management and limiting in call change scenario. In other words, the RF exposure averaged over any FCC defined time window (including the time windows containing the call change) doesn't exceed FCC limit of 1.6 W/kg for 1gSAR or 4.0 W/kg for 10gSAR.

Test procedure

1. Measure P_{limit} for the technology/band selected in Section 6.2.2. Measure P_{limit} with Smart Transmit enabled and *Reserve_power_margin* set to 0 dB, callbox set to request maximum power.
2. Set *Reserve_power_margin* to actual (intended) value and reset power on EUT to enable Smart Transmit.
3. Establish radio link with callbox in the selected technology/band.

4. Request EUT's Tx power at 0 dBm for at least one time window specified for the selected technology/band, followed by requesting EUT's Tx power to be at maximum power for about ~60 seconds, and then drop the call for ~10 seconds. Afterwards, re-establish another call in the same radio configuration (i.e., same technology/band/channel) and continue callbox requesting EUT's Tx power to be at maximum power for the remaining time of at least another full duration of the specified time window. Measure and record Tx power versus time. Once the measurement is done, extract instantaneous Tx power versus time, convert the measured conducted Tx power into 1gSAR or 10gSAR value using Eq. (1a), and then perform the running time average to determine time-averaged power and 1gSAR or 10gSAR versus time.

Note: In Eq.(1a), instantaneous Tx power is converted into instantaneous 1gSAR or 10gSAR value by applying the measured worst-case 1gSAR or 10gSAR value at P_{limit} for the corresponding technology/band/antenna/DSI reported in Part 1 report.

5. Make one plot containing: (a) instantaneous Tx power versus time, (b) requested power, (c) computed time-averaged power, (d) time-averaged power limit calculated using Eq.(5a).
6. Make another plot containing: (a) computed time-averaged 1gSAR or 10gSAR versus time, and (b) FCC limit of 1.6 W/kg for 1gSAR or 4.0 W/kg for 10gSAR.

The validation criteria are, at all times, the time-averaged power versus time shall not exceed the time-averaged power limit (defined in Eq.(5a)), in turn, the time-averaged 1gSAR or 10gSAR versus time shall not exceed the FCC limit of 1.6 W/kg for 1gSAR or 4.0 W/kg for 10gSAR (i.e., Eq. (1b)).

6.3.3 Change in Technology/band

This test is to demonstrate the correct power control by Smart Transmit during technology switches and/or band handovers.

Similar to the change in call test in Section 6.3.2, to validate the continuity of RF exposure limiting during the transition, the technology and band handover needs to be performed when EUT's Tx power is at *Preserve* level (i.e., during Tx power enforcement) to make sure that the EUT's Tx power from previous *Preserve* level to the new *Preserve* level (corresponding to new technology/band). Since the P_{limit} could vary with technology and band, Eq. (1a) can be written as follows to convert the instantaneous Tx power in 1gSAR or 10gSAR exposure for the two given radios, respectively:

$$1g_or_10gSAR_1(t) = \frac{conducted_Tx_power_1(t)}{conducted_Tx_power_P_{limit_1}} * 1g_or_10gSAR_P_{limit_1} \quad (6a)$$

$$1g_or_10gSAR_2(t) = \frac{conducted_Tx_power_2(t)}{conducted_Tx_power_P_{limit_2}} * 1g_or_10gSAR_P_{limit_2} \quad (6b)$$

$$\frac{1}{T_{SAR}} \left[\int_{t-T_{SAR}}^{t_1} \frac{1g_or_10gSAR_1(t)}{FCC\ SAR\ limit} dt + \int_{t-T_{SAR}}^{t_1} \frac{1g_or_10gSAR_2(t)}{FCC\ SAR\ limit} dt \right] \leq 1 \quad (6c)$$

where, $conducted_Tx_power_1(t)$, $conducted_Tx_power_P_{limit_1}$, and $1g_or_10gSAR_P_{limit_1}$ correspond to the measured instantaneous conducted Tx power, measured conducted Tx power at P_{limit} , and measured 1gSAR or 10gSAR value at P_{limit} of technology1/band1; $conducted_Tx_power_2(t)$, $conducted_Tx_power_P_{limit_2}(t)$, and $1g_or_10gSAR_P_{limit_2}$ correspond to the measured instantaneous conducted Tx power, measured conducted Tx power at P_{limit} , and measured 1gSAR or 10gSAR value

at P_{limit} of technology2/band2. Transition from technology1/band1 to the technology2/band2 happens at time-instant ' t_1 '.

Test procedure

1. Measure P_{limit} for both the technologies and bands selected in Section 6.2.3. Measure P_{limit} with Smart Transmit enabled and *Reserve_power_margin* set to 0 dB, callbox set to request maximum power.
2. Set *Reserve_power_margin* to actual (intended) value and reset power on EUT to enable Smart Transmit
3. Establish radio link with callbox in first technology/band selected.
4. Request EUT's Tx power at 0 dBm for at least one time window specified for the selected technology/band, followed by requesting EUT's Tx power to be at maximum power for about ~60 seconds, and then switch to second technology/band selected. Continue with callbox requesting EUT's Tx power to be at maximum power for the remaining time of at least another full duration of the specified time window. Measure and record Tx power versus time for the full duration of the test.
5. Once the measurement is done, extract instantaneous Tx power versus time, and convert the conducted Tx power into 1gSAR or 10gSAR value using Eq. (6a) and (6b) and corresponding measured P_{limit} values from Step 1 of this section. Perform the running time average to determine time-averaged power and 1gSAR or 10gSAR versus time.

Note: In Eq.(6a) & (6b), instantaneous Tx power is converted into instantaneous 1gSAR or 10gSAR value by applying the measured worst-case 1gSAR or 10gSAR value at P_{limit} for the corresponding technology/band/antenna/DSI reported in Part 1 report.

6. Make one plot containing: (a) instantaneous Tx power versus time, (b) requested power, (c) computed time-averaged power, (d) time-averaged power limit calculated using Eq.(5a).
7. Make another plot containing: (a) computed time-averaged 1gSAR or 10gSAR versus time, and(b) FCC limit of 1.6 W/kg for 1gSAR or 4.0 W/kg for 10gSAR.

The validation criteria are, at all times, the time-averaged 1gSAR or 10gSAR versus time shall not exceed the FCC limit of 1.6 W/kg for 1gSAR or 4.0 W/kg for 10gSAR (i.e., Eq. (6c))

6.3.4 Change in Antenna

This test is to demonstrate the correct power control by Smart Transmit during antenna switches from one antenna to another. The test procedure is identical to Section 6.3.3, by replacing technology/band switch operation with antenna switch. The validation criteria are, at all times, the time-averaged 1gSAR or 10gSAR versus time shall not exceed FCC limit of 1.6 W/kg for 1gSAR or 4.0 W/kg for 10gSAR.

Note: If the EUT does not support antenna switch within the same technology/band, but has multiple antennas to support different frequency bands, then the antenna switch test is included as part of change in technology and band (Section 6.3.3) test.

6.3.5 Change in Time Window

This test is to demonstrate the correct power control by Smart Transmit during the change in averaging time window when a specific band handover occurs. FCC specifies time-averaging windows of 100s for Tx frequency < 3GHz, and 60s for Tx frequency between 3GHz and 6GHz.

To validate the continuity of RF exposure limiting during the transition, the band handover test needs to be performed when EUT handovers from operation band less than 3GHz to greater than 3GHz and vice versa. The equations (3a) and (3b) in Section 2 can be written as follows for transmission scenario having change in time window

$$1gSAR_1(t) = \frac{\text{conducted_Tx_power_1}(t)}{\text{conducted_Tx_power_P}_{limit_1}} * 1g_or_10gSAR_P_{limit_1} \quad (7a)$$

$$1gSAR_2(t) = \frac{\text{conducted_Tx_power_2}(t)}{\text{conducted_Tx_power_P}_{limit_2}} * 1g_or_10gSAR_P_{limit_2} \quad (7b)$$

$$\frac{1}{T_{1SAR}} \left[\int_{t-T_{1SAR}}^{t_1} \frac{1g_or_10gSAR_1(t)}{FCC\ SAR\ limit} dt \right] + \frac{1}{T_{2SAR}} \left[\int_{t-T_{2SAR}}^{t_1} \frac{1g_or_10gSAR_2(t)}{FCC\ SAR\ limit} dt \right] \leq 1 \quad (7c)$$

where, $\text{conducted_Tx_power_1}(t)$, $\text{conducted_Tx_power_P}_{limit_1}(t)$, and $1g_or_10g_SAR_P_{limit_1}$ correspond to the instantaneous Tx power, conducted Tx power at P_{limit} , and compliance $1g_or_10g_SAR$ values at P_{limit_1} of band1 with time-averaging window ' T_{1SAR} '; $\text{conducted_Tx_power_2}(t)$, $\text{conducted_Tx_power_P}_{limit_2}(t)$, and $1g_or_10g_SAR_P_{limit_2}$ correspond to the instantaneous Tx power, conducted Tx power at P_{limit} , and compliance $1g_or_10g_SAR$ values at P_{limit_2} of band2 with time-averaging window ' T_{2SAR} '. One of the two bands is less than 3GHz, another is greater than 3GHz. Transition from first band with time-averaging window ' T_{1SAR} ' to the second band with time-averaging window ' T_{2SAR} ' happens at time-instant ' t_1 '.

Test procedure

1. Measure P_{limit} for both the technologies and bands selected in Section 6.2.4
Measure P_{limit} with Smart Transmit enabled and *Reserve_power_margin* set to 0 dB, callbox set to request maximum power.
2. Set *Reserve_power_margin* to actual (intended) value and enable Smart Transmit.

Transition from 100s time window to 60s time window, and vice versa

1. Establish radio link with callbox in the technology/band having 100s time window selected in Section 6.2.4.
2. Request EUT's Tx power to be at 0 dBm for at least 100 seconds, followed by requesting EUT's Tx power to be at maximum power for about ~140 seconds, and then switch to second technology/band (having 60s time window) selected in Section 6.2.4. Continue with callbox requesting EUT's Tx power to be at maximum power for about ~60s in this second technology/band, and then switch back to the first technology/band. Continue with callbox requesting EUT's Tx power to be at maximum power for at least another 100s. Measure and record Tx power versus time for the entire duration of the test.
3. Once the measurement is done, extract instantaneous Tx power versus time, and convert the conducted Tx power into 1gSAR or 10gSAR value (see Eq. (7a) and (7b)) using corresponding technology/band Step 1 result, and then perform 100s running average to determine time-averaged 1gSAR or 10gSAR versus time. Note that in Eq.(7a) & (7b), instantaneous Tx power is converted

into instantaneous 1gSAR or 10gSAR value by applying the worst-case 1gSAR or 10gSAR value tested in Part 1 for the selected technologies/bands at P_{limit}

4. Make one plot containing: (a) instantaneous Tx power versus time measured in Step
5. Make another plot containing: (a) instantaneous 1gSAR versus time determined in Step 5, (b) computed time-averaged 1gSAR versus time determined in Step 5, and (c) corresponding regulatory $1gSAR_{limit}$ of 1.6W/kg or $10gSAR_{limit}$ of 4.0W/kg.

Transition from 60s time window to 100s time window, and vice versa

1. Establish radio link with callbox in the technology/band having 60s time window selected in Section 6.2.4.
2. Request EUT's Tx power to be at 0 dBm for at least 60 seconds, followed by requesting EUT's Tx power to be at maximum power for about ~80 seconds, and then switch to second technology/band (having 100s time window) selected in Section 6.2.4. Continue with callbox requesting EUT's Tx power to be at maximum power for about ~100s in this second technology/band, and then switch back to the first technology/band. Continue with callbox requesting EUT's Tx power to be at maximum power for the remaining time for a total test time of 500 seconds. Measure and record Tx power versus time for the entire duration of the test.
3. Repeat above Step 5~7 to generate the plots The validation criteria is, at all times, the time-averaged 1gSAR or 10gSAR versus time shall not exceed the regulatory $1gSAR_{limit}$ of 1.6W/kg or $10gSAR_{limit}$ of 4.0W/kg

6.3.6 Change in DSI

This test is to demonstrate the correct power control by Smart Transmit during DSI switches from one DSI to another. The test procedure is identical to Section 6.3.3, by replacing technology/band switch operation with DSI switch. The validation criteria are, at all times, the time-averaged 1gSAR or 10gSAR versus time shall not exceed FCC limit of 1.6 W/kg for 1gSAR or 4.0 W/kg for 10gSAR.

6.3.7 SAR Exposure Switching

This test is to demonstrate that Smart Transmit feature is accurately accounts for switching in exposures among SAR from radio1 only, SAR from both radio1 and radio2, and SAR from radio2 only scenarios, and ensures total time-averaged RF exposure complies with the FCC limit. Here, radio1 represents primary radio (for example, LTE anchor in a NR non-standalone mode call) and radio2 represents secondary radio (for example, sub6 NR). The detailed test procedure for SAR exposure switching in the case of LTE+ sub6 NR non-standalone mode transmission scenario is provided in Annex B.2.

Test procedure

1. Measure conducted Tx power corresponding to P_{limit} for radio1 and radio2 in selected band. Test condition to measure conducted P_{limit} is:
 - Establish device in call with the callbox for radio1 technology/band. Measure conducted Tx power corresponding to radio1 P_{limit} with Smart Transmit enabled and *Reserve_power_margin* set to 0 dB, callbox set to request maximum power.
 - Repeat above step to measure conducted Tx power corresponding to radio2 P_{limit} . If radio2 is dependent on radio1 (for example, non-standalone mode of sub6 NR requiring radio1 LTE as anchor), then establish radio1 + radio2 call with callbox, and request all down bits for radio1 LTE. In this scenario, with callbox requesting maximum power from radio2 sub6 NR, measured conducted Tx power corresponds to radio2 P_{limit} (as radio1 LTE is at all-down bits)
2. Set *Reserve_power_margin* to actual (intended) value, with EUT setup for radio1 + radio2 call. In this description, it is assumed that radio2 has lower priority than radio1. Establish device in radio1+radio2 call, and request all-down bits or low power on radio1, with callbox requesting EUT's Tx power to be at maximum power in radio2 for at least one time window. After one time window, set callbox to request EUT's Tx power to be at maximum power on radio1, i.e., all-up bits. Continue radio1+radio2 call with both radios at maximum power for at least one time window, and drop (or request all-down bits on) radio2. Continue radio1 at maximum power for at least one time window. Record the conducted Tx power for both radio1 and radio2 for the entire duration of this test.
3. Once the measurement is done, extract instantaneous Tx power versus time for both radio1 and radio2 links. Convert the conducted Tx power for both these radios into 1gSAR or 10gSAR value (see Eq. (6a) and (6b)) using corresponding technology/band P_{limit} measured in Step 1, and then perform the running time average to determine time-averaged 1gSAR or 10gSAR versus time.
4. Make one plot containing: (a) instantaneous Tx power versus time measured in Step 2.
5. Make another plot containing: (a) instantaneous 1gSAR versus time determined in Step 3, (b) computed time-averaged 1gSAR versus time determined in Step 3, and (c) corresponding regulatory *1gSARlimit* of 1.6W/kg or *10gSARlimit* of 4.0W/kg.

The validation criteria is, at all times, the time-averaged 1gSAR or 10gSAR versus time shall not exceed the regulatory *1gSARlimit* of 1.6W/kg or *10gSARlimit* of 4.0W/kg.

6.3.8 Exposure category switch

This test is performed with the EUT being requested to transmit at maximum power in selected technology/band/antenna/DSI. The change in exposure category is preferably performed during Tx power enforcement (i.e., EUT forced to transmit at a sustainable level). One test is sufficient as this feature operation is independent of technology, band and antenna. Test procedure are:

In case of head to non-head to head exposure switch test, 'first DSI' in below test procedure refers to head DSI and 'second DSI' refers to non-head DSI. Similarly, in case of non-head to head to non-head exposure switch test, 'first DSI' in below test procedure refers to non-head DSI and 'second DSI' refers to head DSI.

1. Measure P_{limit} for all the technology(s)/band(s)/antenna(s)/DSI(s) selected following the above selection criteria. Measure P_{limit} with Smart Transmit Peak exposure mode enabled and callbox set to request maximum power.
2. Set EUT to intended Smart Transmit exposure mode.
3. Establish radio link with first DSI and with callbox in the selected technology(s)/band(s)/antenna(s).
4. Request EUT to transmit at 0 dBm for at least 100 seconds, followed by requesting EUT to transmit at maximum Tx power for the active radio(s) for half of the regulatory time window, and then switch to the second DSI for ~10s, and switch back to the first DSI for at least one time window. Throughout this test, when switching between DSIs (i.e., switching between exposure categories), continue with callbox requesting EUT to transmit at maximum Tx power for the active radio(s). Measure and record Tx power versus time for the entire duration of the test.
5. Once the measurement is done, extract instantaneous Tx power versus time, and convert the conducted Tx power into 1g_or_10gSAR value (see Eq. (7a) and (7b)) using the corresponding P_{limit} measured in Step 1 and 1g_or_10gSAR value measured in 80-W2112-4 Part 1 report, and then perform 100s running average to determine time-averaged 1g_or_10gSAR versus time as illustrated in Figure 5-1. Note that in Eq.(7a) & (7b), instantaneous Tx power is converted into instantaneous 1g_or_10gSAR value by applying the worstcase 1gSAR value for the selected technologies/bands at P_{limit} as reported in 80- W2112-4 Part 1 report.
6. Make one plot containing: (a) computed time-averaged normalized 1g_or_10gSAR of the selected technology(s)/band(s)/antenna(s) versus time determined in Step 5 for exposure under first DSI, (b) total time-averaged normalized exposure for exposure under first DSI if simultaneous transmission scenario was tested, and (c) normalized regulatory limit of 1.0.
7. Make another plot containing: (a) computed time-averaged 1g_or_10gSAR of the selected technology(s)/band(s)/antenna(s) versus time determined in Step 5 for exposure under second DSI, (b) total time-averaged normalized exposure for exposure under second DSI if simultaneous transmission scenario was tested, and (c) normalized regulatory limit of 1.0. The validation criteria is, at all times, the time-averaged normalized exposure versus time shall not exceed the normalized limit of 1.0 for both first & second DSIs (i.e., both head exposure category and non-head exposure category)

6.4 Test Procedures for Time-varying SAR Measurements

This section provides general time-varying SAR measurement procedures to perform compliance test under dynamic transmission scenarios described in Section 5. In practice, an adjustment can be made in these procedures. The justification/clarification may be provided.

To perform the validation through SAR measurement for transmission scenario 1 described in Section 5, the “path loss” between callbox antenna and EUT needs to be calibrated to ensure that the EUT Tx power reacts to the requested power from callbox in a radiated call. It should be noted that when signaling in closed loop mode, protocol level power control is in play, resulting in EUT not solely following callbox TPC (Tx power control) commands. In other words, EUT response has many dependencies (RSSI, quality of signal, path loss variation, fading, etc.) other than just TPC commands. These dependencies have less impact in conducted setup (as it is a controlled environment and the path loss can be very well calibrated) but have significant impact on radiated testing in an uncontrolled environment, such as SAR test setup. Therefore, the deviation in EUT Tx power from callbox requested power is expected, however the time-averaged SAR should not exceed FCC SAR requirement at all times as Smart Transmit controls Tx power at EUT.

The following steps are for time averaging feature validation through SAR measurement:

1. “Path Loss” calibration: Place the EUT against the phantom in the worst-case position determined based on Section 6.2.1. For each band selected, prior to SAR measurement, perform “path loss” calibration between callbox antenna and EUT. Since the SAR test environment is not controlled and well calibrated for OTA (Over the Air) test, extreme care needs to be taken to avoid the influence from reflections. The test setup is described in Section 6.1.
2. Time averaging feature validation:
 - i. For a given radio configuration (technology/band) selected in Section 6.2.1, enable Smart Transmit and set *Reserve_power_margin* to 0 dB, with callbox to request maximum power, perform area scan, conduct pointSAR measurement at peak location of the area scan. This point SAR value, *pointSAR_Plimit*, corresponds to point SAR at the measured *Plimit* (i.e., measured *Plimit* from the EUT in Step 1 of Section 6.3.1).
 - ii. Set *Reserve_power_margin* to actual (intended) value and reset power on EUT to enable Smart Transmit. Note, if *Reserve_power_margin* cannot be set wirelessly, care must be taken to re-position the EUT in the exact same position relative to the SAM phantom as in above Step 2.i. Establish radio link in desired radio configuration, with callbox requesting the EUT’s Tx power at power levels described by test sequence 1 generated in Step 1 of Section 6.3.1, conduct point SAR measurement versus time at peak location of the area scan determined in Step 2.i of this section. Once the measurement is done, extract instantaneous point SAR vs time data, *pointSAR(t)*, and convert it into instantaneous 1gSAR or 10gSAR vs. time using Eq. (3a), re-written below:

$$1g_or_10gSAR(t) = \frac{pointSAR(t)}{pointSAR_Plimit} * 1g_or_10gSAR_Plimit$$

where, *pointSAR_Plimit* is the value determined in Step 2.i, and *pointSAR(t)* is the instantaneous point SAR measured in Step 2.ii, is the measured 1gSAR or 10gSAR value listed in Part 1 report.

- iii. Perform 100s running average to determine time-averaged 1gSAR or 10gSAR versus time.

- iv. Make one plot containing: (a) time-averaged 1gSAR or 10gSAR versus time determined in Step 2.iii of this section, (b) FCC limit of 1.6 W/kg for 1gSAR or 4.0 W/kg for 10gSAR.
- v. Repeat 2.ii ~ 2.iv for test sequence 2 generated in Step 1 of Section 6.3.1.
- vi. Repeat 2.i ~ 2.v for all the technologies and bands selected in Section 6.2.1.

The time-averaging validation criteria for SAR measurement is that, at all times, the time-averaged 1gSAR or 10gSAR versus time shall not exceed FCC limit of 1.6 W/kg for 1gSAR or 4.0 W/kg for 10gSAR (i.e., Eq. (3b)).

7 MEASUREMENT TEST SETSUP

7.1 Conducted Measurement Test Setup

The Rohde & Schwarz CMW500 callbox is used in this test. The test setup schematic are shown in Figures 7-1a for single antenna of EUT, and in Figures 7-1b for measurements involving switching between different antennas/technologies/time-windows. For single antenna measurement, one port (RF1 COM) of the callbox is connected to the RF port of the EUT using a directional coupler. For technology or band switch measurement, one port (RF1 COM) of the callbox used for signaling two different technologies is connected to a combiner, which is in turn connected to a directional coupler. The other end of the directional coupler is connected to a splitter to connect to two RF ports of the EUT corresponding to the two antennas of interest. For inter-band ULCA measurements, two ports, (RF1 COM and RF3 COM) of callbox used for signaling the PCC band and SCC band respectively are each connected to the PCC and SCC RF ports of the DUT using two directional coupler, shown in figure 7.1c. In the setups, power meters are used to tap the directional coupler for measuring the conducted output power of the EUT. All the path losses from RF port of EUT to the callbox RF COM port and to the power meter are calibrated and automatically entered as offsets in the callbox and the power meter via test scripts on the PC used to control callbox and power meter.

Sub6 NR test setup:

The Keysight UXM E7515B and Anritsu MT8000A callboxes were used in these tests. The test setup schematic is shown in Figures 7-1a. For single antenna measurement, one port (RF1 COM) of the callbox is connected to the RF port of the EUT using a directional coupler.

All the path losses from RF port of EUT to the callbox RF COM port and to the power meter are calibrated and automatically entered as offsets in the callbox and the power meter via test scripts on the PC used to control callbox and power meter.

LTE+5G NR test setup:

The Keysight UXM E7515B and Anritsu MT8000A callbox is used in this test. LTE conducted port and 5G NR conducted port are different on this EUT, therefore the LTE and 5G NR signals for power meter measurement are performed on separate paths as shown in below Figure 7-1 c (Annex D – Test Setup Photo). If LTE conducted port and 5G NR conducted port are same on this EUT (i.e., they share the same antenna), therefore, low-/high-pass filter are used to separate LTE and 5G NR signals for power meter measurement via directional couplers.

All the path losses from RF port of DUT to the callbox RF COM port and to the power meter are calibrated and automatically entered as offsets in the callbox and the power meter via test scripts on the PC used to control callbox and power meter.

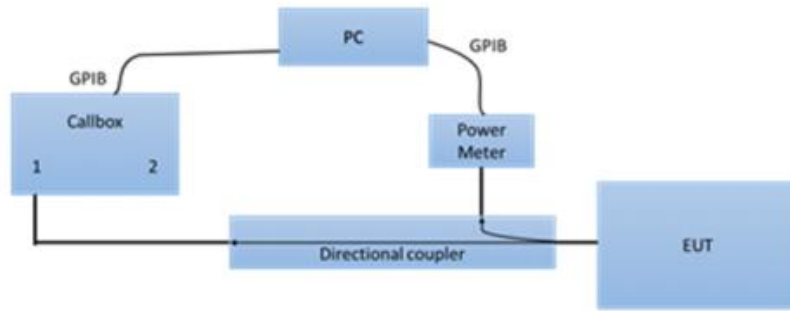

(a) Annex D – Test Setup Photo 1, 2, 3

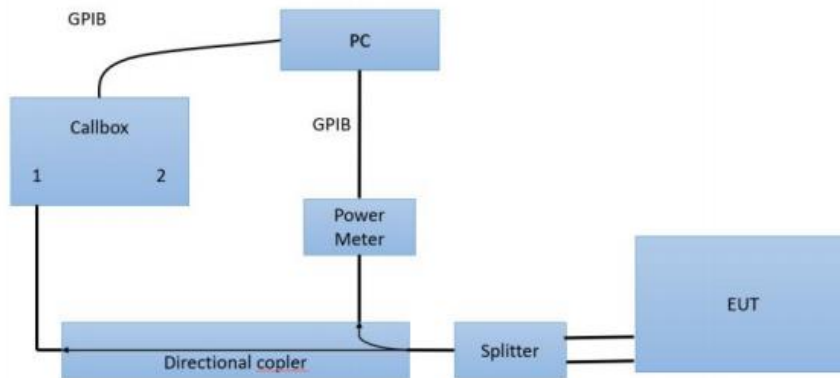

(b) Annex D – Test Setup Photo 4

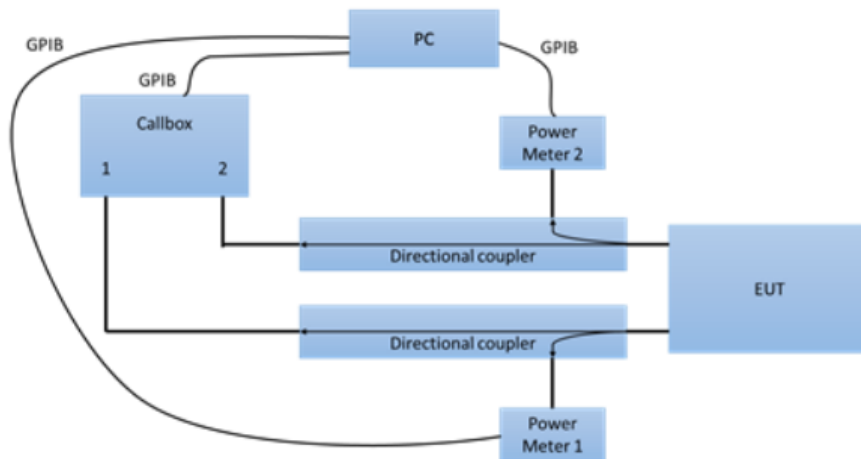

(c) Annex D – Test Setup Photo 5 and 6

Figure 7-1 Conducted power measurement setup

Both the callbox and power meter are connected to the PC using GPIB or Ethernet cables. Two test scripts are custom made for automation, and the test duration set in the test scripts is 500 seconds. Ethernet

For time-varying Tx power measurement, the PC runs the 1st test script to send GPIB commands to control the callbox's requested power versus time, while at the same time to record the conducted power measured at EUT RF port using the power meter. The commands sent to the callbox to request power are:

- 0dBm for 100 seconds
- test sequence 1 or test sequence 2 (defined in Section 6.1 and generated in Section 6.2.1), for 360 seconds
- stay at the last power level of test sequence 1 or test sequence 2 for the remaining time.

Power meter readings are periodically recorded every 100ms. A running average of this measured Tx power over 100 seconds is performed in the post-data processing to determine the 100s-time averaged power.

For call drop, technology/band/antenna switch, and DSI switch tests, after the call is established, the callbox is set to request the EUT's Tx power at 0dBm for 100 seconds while simultaneously starting the 2nd test script runs at the same time to start recording the Tx power measured at EUT RF port using the power meter. After the initial 100 seconds since starting the Tx power recording, the callbox is set to request maximum power from the EUT for the rest of the test. Note that the call drop/re-establish, or technology/band/antenna switch or DSI switch is manually performed when the Tx power of EUT is at $P_{reserve}$ level. See Section 6.3 for detailed test procedure of call drop test, technology/band/antenna switch test and DSI switch test.

7.2 SAR Measurement Setup

The measurement setup is similar to normal SAR measurements as described in the Part1 Test Report. The difference in SAR measurement setup for time averaging feature validation is that the callbox is signaling in close loop power control mode (instead of requesting maximum power in open loop control mode) and callbox is connected to the PC using GPIB so that the test script executed on PC can send GPIB commands to control the callbox's requested power over time (test sequence). The same test script used in conducted setup for time-varying Tx power measurements is also used in this section for running the test sequences during SAR measurements, and the recorded values from the disconnected power meter by the test script were discarded.

As mentioned in Section 6.4, for EUT to follow TPC command sent from the callbox wirelessly, the "path loss" between callbox antenna and the EUT needs to be very well calibrated. Since the SAR chamber is in uncontrolled environment, precautions must be taken to minimize the environmental influences on "path loss". Similarly, in the case of time-varying SAR measurements in 5G NR (with LTE as anchor), "path loss" between callbox antenna and the EUT needs to be carefully calibrated for both LTE link as well as for 5G NR link.

The EUT is placed in worst-case position according to Table 8-2.

8 TEST CONFIGURATIONS

8.1 WWAN (sun-6) transmission

The P_{limit} values, corresponding to 1.0W/kg(1g SAR) and 2.5W/kg(10g SAR) of SAR_{design_target} , for technologies and bands supported by EUT are derived in Part 0 report and summarized in Table 8-1.

Note all P_{limit} power levels entered in Table 8-1 correspond to average power levels after accounting for duty cycle in the case of TDD modulation schemes (for e.g., GSM, LTE TDD & 5G NR TDD).

Per Qualcomm's document, embedded file system (EFS) version 20 products are required to be verified for Smart Tx generation for relevant MCC settings. It was confirmed that this DUT contains embedded file system (EFS) version 20 configured for Smart Tx first generation (GEN1) for Sub6 with MCC settings for the US market.

Table 8-1 P_{limit} for supported technologies and bands(P_{limit} in EFS file)

Reduced level	Receiver state	Transmitting	Antenna	Position
		conditions		
State5	On (head scenario)	WWAN Use Only	Ant.0	Head
			Ant.1	
			Ant.3	
			Ant.4	
			Ant.5	
			Ant.6	
			Ant.7	
State10	On (head scenario)	WWAN + WLAN	Ant.0	Head
			Ant.1	
			Ant.3	
			Ant.4	
			Ant.5	
			Ant.6	
			Ant.7	
State3	Off (Body-Worn/Extremity scenario)	WWAN Use Only	Ant.0	Front Side;Back Side;Left Edge;Right Edge;Top Edge;Bottom Edge
			Ant.1	
			Ant.3	
			Ant.4	
			Ant.5	
			Ant.6	
			Ant.7	
State8	Off (Body-Worn/Hotspot/Extremity scenario)	WWAN + WLAN	Ant.0	Front Side;Back Side;Left Edge;Right Edge;Top Edge;Bottom Edge
			Ant.1	
			Ant.3	

			Ant.4	
			Ant.5	
			Ant.6	
			Ant.7	
			Ant.10	

WWAN Antenna Power table

Mode	Antenna	WWAN Antenna								
		Full Power	Receiver on		Receiver off					
			Head		Body-Worn		Hotspot	Specific		
			Standalone	Simultaneous transmission	Standalone	Simultaneous transmission	Simultaneous transmission	Standalone	Simultaneous transmission	
			WWAN	WWAN + WLAN	WWAN	WWAN + WLAN	WWAN + WLAN	WWAN	WWAN + WLAN	
Off	State5	State10	State3	State8	State8	State3	State8			
GSM 850	Ant.0	32.50	29.50	29.50	31.50	30.50	30.50	31.50	30.50	
GPRS850 1 Tx Slot	Ant.0	32.50	29.50	29.50	31.50	30.50	30.50	31.50	30.50	
GPRS850 2 Tx Slot	Ant.0	30.00	27.00	27.00	29.00	28.00	28.00	29.00	28.00	
GPRS850 3 Tx Slot	Ant.0	28.50	25.50	25.50	27.50	26.50	26.50	27.50	26.50	
GPRS850 4 Tx Slot	Ant.0	27.50	24.50	24.50	26.50	25.50	25.50	26.50	25.50	
EGPRS850 1 Tx Slot	Ant.0	27.00	27.00	27.00	27.00	27.00	27.00	27.00	27.00	
EGPRS850 2 Tx Slot	Ant.0	25.00	25.00	25.00	25.00	25.00	25.00	25.00	25.00	
EGPRS850 3 Tx Slot	Ant.0	23.50	23.50	23.50	23.50	23.50	23.50	23.50	23.50	
EGPRS850 4 Tx Slot	Ant.0	22.50	22.50	22.50	22.50	22.50	22.50	22.50	22.50	
GSM 850	Ant.1	33.50	30.50	29.50	31.00	30.00	30.00	31.00	30.00	
GPRS850 1 Tx Slot	Ant.1	33.50	30.50	29.50	31.00	30.00	30.00	31.00	30.00	
GPRS850 2 Tx Slot	Ant.1	31.00	28.00	27.00	28.50	27.50	27.50	28.50	27.50	
GPRS850 3 Tx Slot	Ant.1	29.50	26.50	25.50	27.00	26.00	26.00	27.00	26.00	
GPRS850 4 Tx Slot	Ant.1	28.50	25.50	24.50	26.00	25.00	25.00	26.00	25.00	
EGPRS850 1 Tx Slot	Ant.1	28.00	28.00	28.00	28.00	28.00	28.00	28.00	28.00	
EGPRS850 2 Tx Slot	Ant.1	26.00	26.00	26.00	26.00	26.00	26.00	26.00	26.00	
EGPRS850 3 Tx Slot	Ant.1	24.50	24.50	24.50	24.50	24.50	24.50	24.50	24.50	
EGPRS850 4 Tx Slot	Ant.1	23.50	23.50	23.50	23.50	23.50	23.50	23.50	23.50	
GSM 900	Ant.0	32.50	29.50	29.50	32.00	31.00	31.00	32.00	31.00	
GPRS900 1 Tx Slot	Ant.0	32.50	29.50	29.50	32.00	31.00	31.00	32.00	31.00	
GPRS900 2 Tx Slot	Ant.0	30.00	27.00	27.00	29.50	28.50	28.50	29.50	28.50	
GPRS900 3 Tx Slot	Ant.0	28.50	25.50	25.50	28.00	27.00	27.00	28.00	27.00	
GPRS900 4 Tx Slot	Ant.0	27.50	24.50	24.50	27.00	26.00	26.00	27.00	26.00	
EGPRS900 1 Tx Slot	Ant.0	27.00	27.00	27.00	27.00	27.00	27.00	27.00	27.00	
EGPRS900 2 Tx Slot	Ant.0	25.00	25.00	25.00	25.00	25.00	25.00	25.00	25.00	
EGPRS900 3 Tx Slot	Ant.0	23.50	23.50	23.50	23.50	23.50	23.50	23.50	23.50	
EGPRS900 4 Tx Slot	Ant.0	22.50	22.50	22.50	22.50	22.50	22.50	22.50	22.50	
GSM 900	Ant.1	33.50	29.00	28.00	31.00	30.50	30.50	31.00	30.50	

GPRS900 1 Tx Slot	Ant.1	33.50	29.00	28.00	31.00	30.50	30.50	31.00	30.50
GPRS900 2 Tx Slot	Ant.1	31.00	26.50	25.50	28.50	28.00	28.00	28.50	28.00
GPRS900 3 Tx Slot	Ant.1	29.50	25.00	24.00	27.00	26.50	26.50	27.00	26.50
GPRS900 4 Tx Slot	Ant.1	28.50	24.00	23.00	26.00	25.50	25.50	26.00	25.50
EGPRS900 1 Tx Slot	Ant.1	28.00	28.00	28.00	28.00	28.00	28.00	28.00	28.00
EGPRS900 2 Tx Slot	Ant.1	26.00	26.00	25.50	26.00	26.00	26.00	26.00	26.00
EGPRS900 3 Tx Slot	Ant.1	24.50	24.50	23.50	24.50	24.50	24.50	24.50	24.50
EGPRS900 4 Tx Slot	Ant.1	23.50	22.50	22.00	23.50	23.50	23.50	23.50	23.50
GSM1900	Ant.3	30.30	28.80	27.80	30.30	29.80	29.80	30.30	29.80
GPRS1900 1 Tx Slot	Ant.3	30.30	28.80	27.80	30.30	29.80	29.80	30.30	29.80
GPRS1900 2 Tx Slot	Ant.3	27.80	26.30	25.30	27.80	27.30	27.30	27.80	27.30
GPRS1900 3 Tx Slot	Ant.3	26.30	24.80	23.80	26.30	25.80	25.80	26.30	25.80
GPRS1900 4 Tx Slot	Ant.3	25.30	23.80	22.80	25.30	24.80	24.80	25.30	24.80
EGPRS1900 1 Tx Slot	Ant.3	26.80	26.80	26.80	26.80	26.80	26.80	26.80	26.80
EGPRS1900 2 Tx Slot	Ant.3	24.30	24.30	24.30	24.30	24.30	24.30	24.30	24.30
EGPRS1900 3 Tx Slot	Ant.3	22.80	22.80	22.80	22.80	22.80	22.80	22.80	22.80
EGPRS1900 4 Tx Slot	Ant.3	22.30	22.30	22.30	22.30	22.30	22.30	22.30	22.30
GSM1900	Ant.4	30.50	30.50	30.50	30.50	30.50	30.50	30.50	30.50
GPRS1900 1 Tx Slot	Ant.4	30.50	30.50	30.50	30.50	30.50	30.50	30.50	30.50
GPRS1900 2 Tx Slot	Ant.4	28.00	28.00	28.00	28.00	28.00	28.00	28.00	28.00
GPRS1900 3 Tx Slot	Ant.4	26.50	26.50	26.50	26.50	26.50	26.50	26.50	26.50
GPRS1900 4 Tx Slot	Ant.4	25.50	25.50	25.50	25.50	25.50	25.50	25.50	25.50
EGPRS1900 1 Tx Slot	Ant.4	27.00	27.00	27.00	27.00	27.00	27.00	27.00	27.00
EGPRS1900 2 Tx Slot	Ant.4	24.50	24.50	24.50	24.50	24.50	24.50	24.50	24.50
EGPRS1900 3 Tx Slot	Ant.4	23.00	23.00	23.00	23.00	23.00	23.00	23.00	23.00
EGPRS1900 4 Tx Slot	Ant.4	22.50	22.50	22.50	22.50	22.50	22.50	22.50	22.50
WCDMA Band2 RMC	Ant.3	24.60	18.60	18.10	22.10	20.60	20.60	22.10	20.60
WCDMA Band2 AMR	Ant.3	24.60	18.60	18.10	22.10	20.60	20.60	22.10	20.60
HSDPA Subtest-1	Ant.3	24.10	18.10	17.60	21.60	20.10	20.10	21.60	20.10
HSDPA Subtest-2	Ant.3	24.10	18.10	17.60	21.60	20.10	20.10	21.60	20.10
HSDPA Subtest-3	Ant.3	23.10	17.10	16.60	20.60	19.10	19.10	20.60	19.10
HSDPA Subtest-4	Ant.3	23.10	17.10	16.60	20.60	19.10	19.10	20.60	19.10
DC-HSDPA Subtest-1	Ant.3	24.10	18.10	17.60	21.60	20.10	20.10	21.60	20.10
DC-HSDPA Subtest-2	Ant.3	24.10	18.10	17.60	21.60	20.10	20.10	21.60	20.10
DC-HSDPA Subtest-3	Ant.3	23.10	17.10	16.60	20.60	19.10	19.10	20.60	19.10
DC-HSDPA Subtest-4	Ant.3	23.10	17.10	16.60	20.60	19.10	19.10	20.60	19.10
HSUPA Subtest-1	Ant.3	24.10	18.10	17.60	21.60	20.10	20.10	21.60	20.10
HSUPA Subtest-2	Ant.3	21.80	15.80	15.30	19.30	17.80	17.80	19.30	17.80
HSUPA Subtest-3	Ant.3	22.80	16.80	16.30	20.30	18.80	18.80	20.30	18.80
HSUPA Subtest-4	Ant.3	21.80	15.80	15.30	19.30	17.80	17.80	19.30	17.80
HSUPA Subtest-5	Ant.3	24.10	18.10	17.60	21.60	20.10	20.10	21.60	20.10
HSPA+(16QAM)	Ant.3	21.80	15.80	15.30	19.30	17.80	17.80	19.30	17.80
WCDMA Band2 RMC	Ant.4	24.80	24.80	24.80	21.80	21.30	21.30	21.80	21.30

WCDMA Band2 AMR	Ant.4	24.80	24.80	24.80	21.80	21.30	21.30	21.80	21.30
HSDPA Subtest-1	Ant.4	24.30	24.30	24.30	21.30	20.80	20.80	21.30	20.80
HSDPA Subtest-2	Ant.4	24.30	24.30	24.30	21.30	20.80	20.80	21.30	20.80
HSDPA Subtest-3	Ant.4	23.30	23.30	23.30	20.30	19.80	19.80	20.30	19.80
HSDPA Subtest-4	Ant.4	23.30	23.30	23.30	20.30	19.80	19.80	20.30	19.80
DC-HSDPA Subtest-1	Ant.4	24.30	24.30	24.30	21.30	20.80	20.80	21.30	20.80
DC-HSDPA Subtest-2	Ant.4	24.30	24.30	24.30	21.30	20.80	20.80	21.30	20.80
DC-HSDPA Subtest-3	Ant.4	23.30	23.30	23.30	20.30	19.80	19.80	20.30	19.80
DC-HSDPA Subtest-4	Ant.4	23.30	23.30	23.30	20.30	19.80	19.80	20.30	19.80
HSUPA Subtest-1	Ant.4	24.30	24.30	24.30	21.30	20.80	20.80	21.30	20.80
HSUPA Subtest-2	Ant.4	22.00	22.00	22.00	19.00	18.50	18.50	19.00	18.50
HSUPA Subtest-3	Ant.4	23.00	23.00	23.00	20.00	19.50	19.50	20.00	19.50
HSUPA Subtest-4	Ant.4	22.00	22.00	22.00	19.00	18.50	18.50	19.00	18.50
HSUPA Subtest-5	Ant.4	24.30	24.30	24.30	21.30	20.80	20.80	21.30	20.80
HSPA+(16QAM)	Ant.4	22.00	22.00	22.00	19.00	18.50	18.50	19.00	18.50
WCDMA Band4 RMC	Ant.3	24.60	17.10	16.60	22.60	20.60	20.60	22.60	20.60
WCDMA Band4 AMR	Ant.3	24.60	17.10	16.60	22.60	20.60	20.60	22.60	20.60
HSDPA Subtest-1	Ant.3	24.10	16.60	16.10	22.10	20.10	20.10	22.10	20.10
HSDPA Subtest-2	Ant.3	24.10	16.60	16.10	22.10	20.10	20.10	22.10	20.10
HSDPA Subtest-3	Ant.3	23.30	15.80	15.30	21.30	19.30	19.30	21.30	19.30
HSDPA Subtest-4	Ant.3	23.30	15.80	15.30	21.30	19.30	19.30	21.30	19.30
DC-HSDPA Subtest-1	Ant.3	24.10	16.60	16.10	22.10	20.10	20.10	22.10	20.10
DC-HSDPA Subtest-2	Ant.3	24.10	16.60	16.10	22.10	20.10	20.10	22.10	20.10
DC-HSDPA Subtest-3	Ant.3	23.30	15.80	15.30	21.30	19.30	19.30	21.30	19.30
DC-HSDPA Subtest-4	Ant.3	23.30	15.80	15.30	21.30	19.30	19.30	21.30	19.30
HSUPA Subtest-1	Ant.3	23.80	16.30	15.80	21.80	19.80	19.80	21.80	19.80
HSUPA Subtest-2	Ant.3	21.80	14.30	13.80	19.80	17.80	17.80	19.80	17.80
HSUPA Subtest-3	Ant.3	22.80	15.30	14.80	20.80	18.80	18.80	20.80	18.80
HSUPA Subtest-4	Ant.3	21.80	14.30	13.80	19.80	17.80	17.80	19.80	17.80
HSUPA Subtest-5	Ant.3	24.10	16.60	16.10	22.10	20.10	20.10	22.10	20.10
HSPA+(16QAM)	Ant.3	21.80	14.30	13.80	19.80	17.80	17.80	19.80	17.80
WCDMA Band4 RMC	Ant.4	24.80	24.80	24.80	22.30	21.30	21.30	22.30	21.30
WCDMA Band4 AMR	Ant.4	24.80	24.80	24.80	22.30	21.30	21.30	22.30	21.30
HSDPA Subtest-1	Ant.4	24.30	24.30	24.30	21.80	20.80	20.80	21.80	20.80
HSDPA Subtest-2	Ant.4	24.30	24.30	24.30	21.80	20.80	20.80	21.80	20.80
HSDPA Subtest-3	Ant.4	23.50	23.50	23.50	21.00	20.00	20.00	21.00	20.00
HSDPA Subtest-4	Ant.4	23.50	23.50	23.50	21.00	20.00	20.00	21.00	20.00
DC-HSDPA Subtest-1	Ant.4	24.30	24.30	24.30	21.80	20.80	20.80	21.80	20.80
DC-HSDPA Subtest-2	Ant.4	24.30	24.30	24.30	21.80	20.80	20.80	21.80	20.80
DC-HSDPA Subtest-3	Ant.4	23.50	23.50	23.50	21.00	20.00	20.00	21.00	20.00
DC-HSDPA Subtest-4	Ant.4	23.50	23.50	23.50	21.00	20.00	20.00	21.00	20.00
HSUPA Subtest-1	Ant.4	24.00	24.00	24.00	21.50	20.50	20.50	21.50	20.50
HSUPA Subtest-2	Ant.4	22.00	22.00	22.00	19.50	18.50	18.50	19.50	18.50

HSUPA Subtest-3	Ant.4	23.00	23.00	23.00	20.50	19.50	19.50	20.50	19.50
HSUPA Subtest-4	Ant.4	22.00	22.00	22.00	19.50	18.50	18.50	19.50	18.50
HSUPA Subtest-5	Ant.4	24.30	24.30	24.30	21.80	20.80	20.80	21.80	20.80
HSPA+(16QAM)	Ant.4	22.00	22.00	22.00	19.50	18.50	18.50	19.50	18.50
WCDMA Band5 RMC	Ant.0	24.60	20.60	20.60	22.10	21.10	21.10	22.10	21.10
WCDMA Band5 AMR	Ant.0	24.60	20.60	20.60	22.10	21.10	21.10	22.10	21.10
HSDPA Subtest-1	Ant.0	23.60	19.60	19.60	21.10	20.10	20.10	21.10	20.10
HSDPA Subtest-2	Ant.0	23.60	19.60	19.60	21.10	20.10	20.10	21.10	20.10
HSDPA Subtest-3	Ant.0	23.10	19.10	19.10	20.60	19.60	19.60	20.60	19.60
HSDPA Subtest-4	Ant.0	23.10	19.10	19.10	20.60	19.60	19.60	20.60	19.60
DC-HSDPA Subtest-1	Ant.0	23.60	19.60	19.60	21.10	20.10	20.10	21.10	20.10
DC-HSDPA Subtest-2	Ant.0	23.60	19.60	19.60	21.10	20.10	20.10	21.10	20.10
DC-HSDPA Subtest-3	Ant.0	23.10	19.10	19.10	20.60	19.60	19.60	20.60	19.60
DC-HSDPA Subtest-4	Ant.0	23.10	19.10	19.10	20.60	19.60	19.60	20.60	19.60
HSUPA Subtest-1	Ant.0	23.80	19.80	19.80	21.30	20.30	20.30	21.30	20.30
HSUPA Subtest-2	Ant.0	21.80	17.80	17.80	19.30	18.30	18.30	19.30	18.30
HSUPA Subtest-3	Ant.0	22.80	18.80	18.80	20.30	19.30	19.30	20.30	19.30
HSUPA Subtest-4	Ant.0	21.80	17.80	17.80	19.30	18.30	18.30	19.30	18.30
HSUPA Subtest-5	Ant.0	23.80	19.80	19.80	21.30	20.30	20.30	21.30	20.30
HSPA+(16QAM)	Ant.0	21.80	17.80	17.80	19.30	18.30	18.30	19.30	18.30
WCDMA Band5 RMC	Ant.1	24.80	20.30	19.30	22.30	21.30	21.30	22.30	21.30
WCDMA Band5 AMR	Ant.1	24.80	20.30	19.30	22.30	21.30	21.30	22.30	21.30
HSDPA Subtest-1	Ant.1	23.80	19.30	18.30	21.30	20.30	20.30	21.30	20.30
HSDPA Subtest-2	Ant.1	23.80	19.30	18.30	21.30	20.30	20.30	21.30	20.30
HSDPA Subtest-3	Ant.1	23.30	18.80	17.80	20.80	19.80	19.80	20.80	19.80
HSDPA Subtest-4	Ant.1	23.30	18.80	17.80	20.80	19.80	19.80	20.80	19.80
DC-HSDPA Subtest-1	Ant.1	23.80	19.30	18.30	21.30	20.30	20.30	21.30	20.30
DC-HSDPA Subtest-2	Ant.1	23.80	19.30	18.30	21.30	20.30	20.30	21.30	20.30
DC-HSDPA Subtest-3	Ant.1	23.30	18.80	17.80	20.80	19.80	19.80	20.80	19.80
DC-HSDPA Subtest-4	Ant.1	23.30	18.80	17.80	20.80	19.80	19.80	20.80	19.80
HSUPA Subtest-1	Ant.1	24.00	19.50	18.50	21.50	20.50	20.50	21.50	20.50
HSUPA Subtest-2	Ant.1	22.00	17.50	16.50	19.50	18.50	18.50	19.50	18.50
HSUPA Subtest-3	Ant.1	23.00	18.50	17.50	20.50	19.50	19.50	20.50	19.50
HSUPA Subtest-4	Ant.1	22.00	17.50	16.50	19.50	18.50	18.50	19.50	18.50
HSUPA Subtest-5	Ant.1	24.00	19.50	18.50	21.50	20.50	20.50	21.50	20.50
HSPA+(16QAM)	Ant.1	22.00	17.50	16.50	19.50	18.50	18.50	19.50	18.50
WCDMA Band8 RMC	Ant.0	24.60	20.60	20.60	23.10	22.10	22.10	23.10	22.10
WCDMA Band8 AMR	Ant.0	24.60	20.60	20.60	23.10	22.10	22.10	23.10	22.10
HSDPA Subtest-1	Ant.0	23.60	19.60	19.60	22.10	21.10	21.10	22.10	21.10
HSDPA Subtest-2	Ant.0	23.60	19.60	19.60	22.10	21.10	21.10	22.10	21.10
HSDPA Subtest-3	Ant.0	23.10	19.10	19.10	21.60	20.60	20.60	21.60	20.60
HSDPA Subtest-4	Ant.0	23.10	19.10	19.10	21.60	20.60	20.60	21.60	20.60
DC-HSDPA Subtest-1	Ant.0	23.60	19.60	19.60	22.10	21.10	21.10	22.10	21.10

DC-HSDPA Subtest-2	Ant.0	23.60	19.60	19.60	22.10	21.10	21.10	22.10	21.10
DC-HSDPA Subtest-3	Ant.0	23.10	19.10	19.10	21.60	20.60	20.60	21.60	20.60
DC-HSDPA Subtest-4	Ant.0	23.10	19.10	19.10	21.60	20.60	20.60	21.60	20.60
HSUPA Subtest-1	Ant.0	23.80	19.80	19.80	22.30	21.30	21.30	22.30	21.30
HSUPA Subtest-2	Ant.0	21.80	17.80	17.80	20.30	19.30	19.30	20.30	19.30
HSUPA Subtest-3	Ant.0	22.80	18.80	18.80	21.30	20.30	20.30	21.30	20.30
HSUPA Subtest-4	Ant.0	21.80	17.80	17.80	20.30	19.30	19.30	20.30	19.30
HSUPA Subtest-5	Ant.0	23.80	19.80	19.80	22.30	21.30	21.30	22.30	21.30
HSPA+(16QAM)	Ant.0	21.80	17.80	17.80	20.30	19.30	19.30	20.30	19.30
WCDMA Band8 RMC	Ant.1	24.80	20.80	19.80	21.30	20.30	20.30	21.30	20.30
WCDMA Band8 AMR	Ant.1	24.80	20.80	19.80	21.30	20.30	20.30	21.30	20.30
HSDPA Subtest-1	Ant.1	23.80	19.80	18.80	20.30	19.30	19.30	20.30	19.30
HSDPA Subtest-2	Ant.1	23.80	19.80	18.80	20.30	19.30	19.30	20.30	19.30
HSDPA Subtest-3	Ant.1	23.30	19.30	18.30	19.80	18.80	18.80	19.80	18.80
HSDPA Subtest-4	Ant.1	23.30	19.30	18.30	19.80	18.80	18.80	19.80	18.80
DC-HSDPA Subtest-1	Ant.1	23.80	19.80	18.80	20.30	19.30	19.30	20.30	19.30
DC-HSDPA Subtest-2	Ant.1	23.80	19.80	18.80	20.30	19.30	19.30	20.30	19.30
DC-HSDPA Subtest-3	Ant.1	23.30	19.30	18.30	19.80	18.80	18.80	19.80	18.80
DC-HSDPA Subtest-4	Ant.1	23.30	19.30	18.30	19.80	18.80	18.80	19.80	18.80
HSUPA Subtest-1	Ant.1	24.00	20.00	19.00	20.50	19.50	19.50	20.50	19.50
HSUPA Subtest-2	Ant.1	22.00	18.00	17.00	18.50	17.50	17.50	18.50	17.50
HSUPA Subtest-3	Ant.1	23.00	19.00	18.00	19.50	18.50	18.50	19.50	18.50
HSUPA Subtest-4	Ant.1	22.00	18.00	17.00	18.50	17.50	17.50	18.50	17.50
HSUPA Subtest-5	Ant.1	24.00	20.00	19.00	20.50	19.50	19.50	20.50	19.50
HSPA+(16QAM)	Ant.1	22.00	18.00	17.00	18.50	17.50	17.50	18.50	17.50
LTE Band2	Ant.3	23.80	18.80	18.30	22.30	20.80	20.80	22.30	20.80
LTE Band2	Ant.4	24.00	24.00	24.00	22.00	21.00	21.00	22.00	21.00
LTE Band4	Ant.3	24.80	17.80	16.80	22.30	21.30	21.30	22.30	21.30
LTE Band4	Ant.4	25.00	25.00	25.00	22.50	21.50	21.50	22.50	21.50
LTE Band4	Ant.5	23.20	21.20	20.20	21.20	19.70	19.70	21.20	19.70
LTE Band5	Ant.0	23.80	21.80	20.80	21.30	20.80	20.80	21.30	20.80
LTE Band5	Ant.1	25.00	21.50	20.50	21.50	21.00	21.00	21.50	21.00
LTE Band7	Ant.3	24.80	18.30	17.30	21.30	19.80	19.80	21.30	19.80
LTE Band7	Ant.4	25.00	25.00	25.00	23.50	21.50	21.50	23.50	21.50
LTE Band7	Ant.5	22.50	19.00	18.00	22.50	21.00	21.00	22.50	21.00
LTE Band8	Ant.0	23.80	21.80	20.80	21.80	20.80	20.80	21.80	20.80
LTE Band8	Ant.1	25.00	20.50	19.50	21.00	20.00	20.00	21.00	20.00
LTE Band12	Ant.0	23.80	23.80	22.80	22.80	21.80	21.80	22.80	21.80
LTE Band12	Ant.1	25.00	25.00	24.00	23.50	22.50	22.50	23.50	22.50
LTE Band13	Ant.0	23.80	23.80	23.80	22.80	21.80	21.80	22.80	21.80
LTE Band13	Ant.1	25.00	23.00	23.00	23.00	22.00	22.00	23.00	22.00
LTE Band17	Ant.0	23.80	23.80	22.80	22.80	21.80	21.80	22.80	21.80
LTE Band17	Ant.1	25.00	25.00	24.00	24.00	23.00	23.00	24.00	23.00

LTE Band18	Ant.0	23.80	22.80	22.30	22.80	21.80	21.80	22.80	21.80
LTE Band18	Ant.1	25.00	22.00	21.00	22.50	21.50	21.50	22.50	21.50
LTE Band19	Ant.0	23.80	22.30	21.30	21.80	20.80	20.80	21.80	20.80
LTE Band19	Ant.1	25.00	22.00	21.00	22.00	21.00	21.00	22.00	21.00
LTE Band26	Ant.0	23.80	21.80	20.80	21.80	20.80	20.80	21.80	20.80
LTE Band26	Ant.1	25.00	21.50	20.50	22.00	21.00	21.00	22.00	21.00
LTE Band28	Ant.0	23.80	22.30	21.30	22.30	21.30	21.30	22.30	21.30
LTE Band28	Ant.1	25.00	23.00	22.50	23.50	22.50	22.50	23.50	22.50
LTE Band66	Ant.3	24.80	17.30	16.30	22.80	21.30	21.30	22.80	21.30
LTE Band66	Ant.4	25.00	25.00	25.00	22.50	21.50	21.50	22.50	21.50
LTE Band66	Ant.5	23.20	21.70	20.70	21.20	19.70	19.70	21.20	19.70
LTE Band38	Ant.3	24.80	20.80	19.30	22.80	21.30	21.30	22.80	21.30
LTE Band38	Ant.4	25.00	25.00	25.00	25.00	24.00	24.00	25.00	24.00
LTE Band38	Ant.5	22.50	22.50	21.50	22.50	22.00	22.00	22.50	22.00
LTE Band41(PC3)	Ant.3	24.80	21.30	20.30	23.80	22.30	22.30	23.80	22.30
LTE Band41(PC3)	Ant.4	25.00	25.00	25.00	25.00	24.50	24.50	25.00	24.50
LTE Band41(PC3)	Ant.5	22.50	22.00	20.50	22.50	22.50	22.50	22.50	22.50
LTE Band41(PC2)	Ant.3	26.10	23.10	22.10	25.60	24.10	24.10	25.60	24.10
LTE Band41(PC2)	Ant.4	26.30	26.30	26.30	26.30	25.80	25.80	26.30	25.80
LTE Band41(PC2)	Ant.5	23.80	23.80	22.80	23.80	23.80	23.80	23.80	23.80
LTE Band48	Ant.5	24.30	19.30	18.30	20.80	18.80	18.80	20.80	18.80
LTE Band48	Ant.6	20.40	20.40	19.90	20.40	20.40	20.40	20.40	20.40
LTE Band48	Ant.7	25.00	18.00	17.00	20.50	19.00	19.00	20.50	19.00
LTE Band48	Ant.10	21.80	17.80	16.80	20.30	18.30	18.30	20.30	18.30
n2	Ant.3	24.10	19.10	18.10	22.10	19.60	19.60	22.10	19.60
n2	Ant.4	24.30	24.30	24.30	22.30	21.30	21.30	22.30	21.30
n5	Ant.0	23.80	21.80	20.80	21.30	20.80	20.80	21.30	20.80
n5	Ant.1	25.00	21.50	20.50	21.50	20.00	20.00	21.50	20.00
n7	Ant.3	25.20	18.20	17.20	20.70	19.20	19.20	20.70	19.20
n7	Ant.4	25.40	25.40	25.40	22.90	20.90	20.90	22.90	20.90
n7	Ant.5	22.90	19.90	18.90	22.90	21.40	21.40	22.90	21.40
n12	Ant.0	23.80	23.80	23.80	22.80	21.30	21.30	22.80	21.30
n12	Ant.1	25.00	25.00	25.00	24.00	23.00	23.00	24.00	23.00
n26	Ant.0	23.80	21.30	20.30	21.80	20.80	20.80	21.80	20.80
n26	Ant.1	25.00	21.00	20.00	22.00	21.00	21.00	22.00	21.00
n66	Ant.3	24.80	16.80	17.30	22.30	20.80	20.80	22.30	20.80
n66	Ant.4	25.00	25.00	25.00	22.00	21.00	21.00	22.00	21.00
n66	Ant.5	23.20	21.20	20.70	20.70	19.20	19.20	20.70	19.20
n38	Ant.3	25.20	18.70	17.20	20.70	19.20	19.20	20.70	19.20
n38	Ant.4	25.40	25.40	25.40	23.40	21.90	21.90	23.40	21.90
n38	Ant.5	22.90	20.90	19.40	22.90	22.90	22.90	22.90	22.90
n41(PC3)	Ant.3	25.20	18.20	16.20	19.20	17.70	17.70	19.20	17.70
n41(PC3)	Ant.4	25.40	25.40	25.40	22.40	19.90	19.90	22.40	19.90

n41(PC3)	Ant.5	22.90	19.40	17.40	22.90	21.40	21.40	22.90	21.40
n41(PC2)	Ant.3	26.50	18.50	17.50	20.50	19.00	19.00	20.50	19.00
n41(PC2)	Ant.4	26.70	26.70	26.70	23.70	21.20	21.20	23.70	21.20
n41(PC2)	Ant.5	24.20	20.70	18.70	24.20	22.70	22.70	24.20	22.70

LTE-UL CA Configurations	UL CA		Antenna Configurations		
	Band1	Band2	1	2	3
CA_2C	LTE Band2	LTE Band2	LTE Ant.3	LTE Ant.4	/
CA_7C	LTE Band7	LTE Band7	LTE Ant.3	LTE Ant.4	LTE Ant.5
CA_38C	LTE Band38	LTE Band38	LTE Ant.3	LTE Ant.4	LTE Ant.5
CA_41C	LTE Band41	LTE Band41	LTE Ant.3	LTE Ant.4	LTE Ant.5
CA_4A_5A	LTE Band4	LTE Band5	LTE Ant.3	LTE Ant.4	LTE Ant.5
			LTE Ant.0	LTE Ant.1	/
CA_5A_7A	LTE Band5	LTE Band7	LTE Ant.0	LTE Ant.1	/
			LTE Ant.3	LTE Ant.4	LTE Ant.5
CA_5A_66A	LTE Band5	LTE Band66	LTE Ant.0	LTE Ant.1	/
			LTE Ant.3	LTE Ant.4	LTE Ant.5

Mode	Band	Antenna	LTE-Inter CA Antenna								
			Full Power	Receiver on				Receiver off			
				Head		Body-worn		Hotspot		Specific	
				Standalone	Simultaneous transmission	Standalone	Simultaneous transmission	Simultaneous transmission	Standalone	Simultaneous transmission	
				WWAN	WWAN + WLAN	WWAN	WWAN + WLAN	WWAN + WLAN	WWAN	WWAN + WLAN	
Off	State5	State10	State3	State8	State8	State3	State8				
CA_4A+5A	LTE Band4	Ant.3	24.80	17.80	16.80	22.30	21.30	21.30	22.30	21.30	
	LTE Band4	Ant.4	25.00	25.00	25.00	22.50	21.50	21.50	22.50	21.50	
	LTE Band4	Ant.5	23.20	21.20	20.20	21.20	19.70	19.70	21.20	19.70	
	LTE Band5	Ant.0	23.80	21.80	20.80	21.30	20.80	20.80	21.30	20.80	
	LTE Band5	Ant.1	25.00	21.50	20.50	21.50	21.00	21.00	21.50	21.00	
CA_5A+7A	LTE Band5	Ant.0	23.80	21.80	20.80	21.30	20.80	20.80	21.30	20.80	
	LTE Band5	Ant.1	25.00	21.50	20.50	21.50	21.00	21.00	21.50	21.00	
	LTE Band7	Ant.3	24.80	18.30	17.30	21.30	19.80	19.80	21.30	19.80	
	LTE Band7	Ant.4	25.00	25.00	25.00	23.50	21.50	21.50	23.50	21.50	
	LTE Band7	Ant.5	22.50	19.00	18.00	22.50	21.00	21.00	22.50	21.00	
CA_5A+66A	LTE Band5	Ant.0	23.80	21.80	20.80	21.30	20.80	20.80	21.30	20.80	
	LTE Band5	Ant.1	25.00	21.50	20.50	21.50	21.00	21.00	21.50	21.00	

	LTE Band66	Ant.3	24.80	17.30	16.30	22.80	21.30	21.30	22.80	21.30
	LTE Band66	Ant.4	25.00	25.00	25.00	22.50	21.50	21.50	22.50	21.50
	LTE Band66	Ant.5	23.20	21.70	20.70	21.20	19.70	19.70	21.20	19.70

EN-DC Configurations	E-UTRA	NR	Antenna Configurations					
	Band	Band	1	2	3	4	5	6
7A+n5A	LTE Band7	n5	LTE Ant.3	LTE Ant.4	LTE Ant.5	LTE Ant.3	LTE Ant.4	LTE Ant.5
			nr Ant.0	nr Ant.0	nr Ant.0	nr Ant.1	nr Ant.1	nr Ant.1
66A+n5A	LTE Band66	n5	LTE Ant.3	LTE Ant.4	LTE Ant.5	LTE Ant.3	LTE Ant.4	LTE Ant.5
			nr Ant.0	nr Ant.0	nr Ant.0	nr Ant.1	nr Ant.1	nr Ant.1
2A+n7A	LTE Band2	n7	LTE Ant.3	LTE Ant.5	/	/	/	
			nr Ant.4	nr Ant.4	/	/	/	/
4A+n7A	LTE Band4	n7	LTE Ant.4	LTE Ant.5	LTE Ant.3	LTE Ant.5	LTE Ant.3	LTE Ant.4
			nr Ant.3	nr Ant.3	nr Ant.4	nr Ant.4	nr Ant.5	nr Ant.5
5A+n7A	LTE Band5	n7	LTE Ant.0	LTE Ant.0	LTE Ant.0	LTE Ant.1	LTE Ant.1	LTE Ant.1
			nr Ant.3	nr Ant.4	nr Ant.5	nr Ant.3	nr Ant.4	nr Ant.5
66A+n7A	LTE Band66	n7	LTE Ant.4	LTE Ant.5	LTE Ant.3	LTE Ant.5	LTE Ant.3	LTE Ant.4
			nr Ant.3	nr Ant.3	nr Ant.4	nr Ant.4	nr Ant.5	nr Ant.5
7A+n26A	LTE Band7	n26	LTE Ant.3	LTE Ant.4	LTE Ant.5	LTE Ant.3	LTE Ant.4	LTE Ant.5
			nr Ant.0	nr Ant.0	nr Ant.0	nr Ant.1	nr Ant.1	nr Ant.1
2A+n66A	LTE Band2	n66	LTE Ant.3	LTE Ant.5	/	/	/	/
			nr Ant.4	nr Ant.4	/	/	/	/
5A+n66A	LTE Band5	n66	LTE Ant.0	LTE Ant.0	LTE Ant.0	LTE Ant.1	LTE Ant.1	LTE Ant.1
			nr Ant.3	nr Ant.4	nr Ant.5	nr Ant.3	nr Ant.4	nr Ant.5
7A+n66A	LTE Band7	n66	LTE Ant.4	LTE Ant.5	LTE Ant.3	LTE Ant.5	LTE Ant.3	LTE Ant.4
			nr Ant.3	nr Ant.3	nr Ant.4	nr Ant.4	nr Ant.5	nr Ant.5
12A+n66A	LTE Band12	n66	LTE Ant.0	LTE Ant.0	LTE Ant.0	LTE Ant.1	LTE Ant.1	LTE Ant.1
			nr Ant.3	nr Ant.4	nr Ant.5	nr Ant.3	nr Ant.4	nr Ant.5
2A+n38A	LTE Band2	n38	LTE Ant.4	LTE Ant.5	LTE Ant.3	LTE Ant.5	LTE Ant.3	LTE Ant.4
			nr Ant.3	nr Ant.3	nr Ant.4	nr Ant.4	nr Ant.5	nr Ant.5
4A+n38A	LTE Band4	n38	LTE Ant.4	LTE Ant.5	LTE Ant.3	LTE Ant.5	LTE Ant.3	LTE Ant.4
			nr Ant.3	nr Ant.3	nr Ant.4	nr Ant.4	nr Ant.5	nr Ant.5
5A+n38A	LTE Band5	n38	LTE Ant.0	LTE Ant.0	LTE Ant.0	LTE Ant.1	LTE Ant.1	LTE Ant.1
			nr Ant.3	nr Ant.4	nr Ant.5	nr Ant.3	nr Ant.4	nr Ant.5
66A+n38A	LTE Band66	n38	LTE Ant.4	LTE Ant.5	LTE Ant.3	LTE Ant.5	LTE Ant.3	LTE Ant.4
			nr Ant.3	nr Ant.3	nr Ant.4	nr Ant.4	nr Ant.5	nr Ant.5
2A+n41A	LTE Band2	n41	LTE Ant.4	LTE Ant.5	LTE Ant.3	LTE Ant.5	LTE Ant.3	LTE Ant.4
			nr Ant.3	nr Ant.3	nr Ant.4	nr Ant.4	nr Ant.5	nr Ant.5
4A+n41A	LTE Band4	n41	LTE Ant.4	LTE Ant.5	LTE Ant.3	LTE Ant.5	LTE Ant.3	LTE Ant.4
			nr Ant.3	nr Ant.3	nr Ant.4	nr Ant.4	nr Ant.5	nr Ant.5
26A+n41A	LTE Band26	n41	LTE Ant.0	LTE Ant.0	LTE Ant.0	LTE Ant.1	LTE Ant.1	LTE Ant.1
			nr Ant.3	nr Ant.4	nr Ant.5	nr Ant.3	nr Ant.4	nr Ant.5
66A+n41A	LTE Band66	n41	LTE Ant.4	LTE Ant.5	LTE Ant.3	LTE Ant.5	LTE Ant.3	LTE Ant.4
			nr Ant.3	nr Ant.3	nr Ant.4	nr Ant.4	nr Ant.5	nr Ant.5

Mode	Band	Antenna	WWAN Antenna								
			Full Power	Receiver on				Receiver off			
				Head		Body-worn		Hotspot	Specific		
				Standalone	Simultaneous transmission	Standalone	Simultaneous transmission	Simultaneous transmission	Standalone	Simultaneous transmission	
				WWAN	WWAN + WLAN	WWAN	WWAN + WLAN	WWAN + WLAN	WWAN	WWAN + WLAN	
Off	State5	State10	State3	State8	State8	State3	State8				
DC_7A+n5A	LTE Band7	Ant.3	24.80	18.30	17.30	21.30	19.80	19.80	21.30	19.80	
	LTE Band7	Ant.4	25.00	25.00	25.00	23.50	21.50	21.50	23.50	21.50	
	LTE Band7	Ant.5	22.50	19.00	18.00	22.50	21.00	21.00	22.50	21.00	
	n5	Ant.0	23.80	21.80	20.80	21.30	20.80	20.80	21.30	20.80	
	n5	Ant.1	25.00	21.50	20.50	21.50	20.00	20.00	21.50	20.00	
DC_66A+n5A	LTE Band66	Ant.3	24.80	17.30	16.30	22.80	21.30	21.30	22.80	21.30	
	LTE Band66	Ant.4	25.00	25.00	25.00	22.50	21.50	21.50	22.50	21.50	
	LTE Band66	Ant.5	23.20	21.70	20.70	21.20	19.70	19.70	21.20	19.70	
	n5	Ant.0	23.80	21.80	20.80	21.30	20.80	20.80	21.30	20.80	
	n5	Ant.1	25.00	21.50	20.50	21.50	20.00	20.00	21.50	20.00	
DC_2A_n7A	LTE Band2	Ant.3	23.80	18.80	18.30	22.30	20.80	20.80	22.30	20.80	
	LTE Band2	Ant.5	22.20	21.20	20.20	21.20	19.20	19.20	21.20	19.20	
	n7	Ant.4	25.40	25.40	25.40	22.90	20.90	20.90	22.90	20.90	
DC_4A_n7A	LTE Band4	Ant.3	23.80	16.80	15.80	21.30	20.30	20.30	21.30	20.30	
	LTE Band4	Ant.4	24.00	24.00	24.00	21.50	20.50	20.50	21.50	20.50	
	LTE Band4	Ant.5	22.20	20.20	19.20	20.20	18.70	18.70	20.20	18.70	
	n7	Ant.3	25.20	18.20	17.20	20.70	19.20	19.20	20.70	19.20	
	n7	Ant.4	25.40	25.40	25.40	22.90	20.90	20.90	22.90	20.90	
	n7	Ant.5	22.90	19.90	18.90	22.90	21.40	21.40	22.90	21.40	
DC_5A_n7A	LTE Band5	Ant.0	23.80	21.80	20.80	21.30	20.80	20.80	21.30	20.80	
	LTE Band5	Ant.1	25.00	21.50	20.50	21.50	21.00	21.00	21.50	21.00	
	n7	Ant.3	25.20	18.20	17.20	20.70	19.20	19.20	20.70	19.20	
	n7	Ant.4	25.40	25.40	25.40	22.90	20.90	20.90	22.90	20.90	
	n7	Ant.5	22.90	19.90	18.90	22.90	21.40	21.40	22.90	21.40	
DC_66A_n7A	LTE Band66	Ant.3	23.80	16.30	15.30	21.80	20.30	20.30	21.80	20.30	
	LTE Band66	Ant.4	24.00	24.00	24.00	21.50	20.50	20.50	21.50	20.50	
	LTE Band66	Ant.5	22.20	20.70	19.70	20.20	18.70	18.70	20.20	18.70	
	n7	Ant.3	25.20	18.20	17.20	20.70	19.20	19.20	20.70	19.20	
	n7	Ant.4	25.40	25.40	25.40	22.90	20.90	20.90	22.90	20.90	
	n7	Ant.5	22.90	19.90	18.90	22.90	21.40	21.40	22.90	21.40	
DC_7A_n26A	LTE Band7	Ant.3	24.80	18.30	17.30	21.30	19.80	19.80	21.30	19.80	
	LTE Band7	Ant.4	25.00	25.00	25.00	23.50	21.50	21.50	23.50	21.50	
	LTE Band7	Ant.5	22.50	19.00	18.00	22.50	21.00	21.00	22.50	21.00	
	n26	Ant.0	23.80	21.30	20.30	21.80	20.80	20.80	21.80	20.80	
	n26	Ant.1	25.00	21.00	20.00	22.00	21.00	21.00	22.00	21.00	

DC_2A_n66A	LTE Band2	Ant.3	23.80	18.80	18.30	22.30	20.80	20.80	22.30	20.80
	LTE Band2	Ant.5	22.20	21.20	20.20	21.20	19.20	19.20	21.20	19.20
	n66	Ant.4	25.00	25.00	25.00	22.00	21.00	21.00	22.00	21.00
DC_5A_n66A	LTE Band5	Ant.0	23.80	21.80	20.80	21.30	20.80	20.80	21.30	20.80
	LTE Band5	Ant.1	25.00	21.50	20.50	21.50	21.00	21.00	21.50	21.00
	n66	Ant.3	24.80	16.80	17.30	22.30	20.80	20.80	22.30	20.80
	n66	Ant.4	25.00	25.00	25.00	22.00	21.00	21.00	22.00	21.00
	n66	Ant.5	23.20	21.20	20.70	20.70	19.20	19.20	20.70	19.20
DC_7A_n66A	LTE Band7	Ant.3	23.80	17.30	16.30	20.30	18.80	18.80	20.30	18.80
	LTE Band7	Ant.4	24.00	24.00	24.00	22.50	20.50	20.50	22.50	20.50
	LTE Band7	Ant.5	21.30	17.80	16.80	21.30	19.80	19.80	21.30	19.80
	n66	Ant.3	24.80	16.80	17.30	22.30	20.80	20.80	22.30	20.80
	n66	Ant.4	25.00	25.00	25.00	22.00	21.00	21.00	22.00	21.00
	n66	Ant.5	23.20	21.20	20.70	20.70	19.20	19.20	20.70	19.20
DC_12A_n66A	LTE Band12	Ant.0	23.80	23.80	22.80	22.80	21.80	21.80	22.80	21.80
	LTE Band12	Ant.1	25.00	25.00	24.00	23.50	22.50	22.50	23.50	22.50
	n66	Ant.3	24.80	16.80	17.30	22.30	20.80	20.80	22.30	20.80
	n66	Ant.4	25.00	25.00	25.00	22.00	21.00	21.00	22.00	21.00
	n66	Ant.5	23.20	21.20	20.70	20.70	19.20	19.20	20.70	19.20
DC_2A_n38A	LTE Band2	Ant.3	23.80	18.80	18.30	22.30	20.80	20.80	22.30	20.80
	LTE Band2	Ant.4	24.00	24.00	24.00	22.00	21.00	21.00	22.00	21.00
	LTE Band2	Ant.5	22.20	21.20	20.20	21.20	19.20	19.20	21.20	19.20
	n38	Ant.3	25.20	18.70	17.20	20.70	19.20	19.20	20.70	19.20
	n38	Ant.4	25.40	25.40	25.40	23.40	21.90	21.90	23.40	21.90
	n38	Ant.5	22.90	20.90	19.40	22.90	22.90	22.90	22.90	22.90
DC_4A_n38A	LTE Band4	Ant.3	23.80	16.80	15.80	21.30	20.30	20.30	21.30	20.30
	LTE Band4	Ant.4	24.00	24.00	24.00	21.50	20.50	20.50	21.50	20.50
	LTE Band4	Ant.5	22.20	20.20	19.20	20.20	18.70	18.70	20.20	18.70
	n38	Ant.3	25.20	18.70	17.20	20.70	19.20	19.20	20.70	19.20
	n38	Ant.4	25.40	25.40	25.40	23.40	21.90	21.90	23.40	21.90
	n38	Ant.5	23.60	21.60	20.10	23.60	23.60	23.60	23.60	23.60
DC_5A_n38A	LTE Band5	Ant.0	23.80	21.80	20.80	21.30	20.80	20.80	21.30	20.80
	LTE Band5	Ant.1	25.00	21.50	20.50	21.50	21.00	21.00	21.50	21.00
	n38	Ant.3	25.20	18.70	17.20	20.70	19.20	19.20	20.70	19.20
	n38	Ant.4	25.40	25.40	25.40	23.40	21.90	21.90	23.40	21.90
	n38	Ant.5	22.90	20.90	19.40	22.90	22.90	22.90	22.90	22.90
DC_66A_n38A	LTE Band66	Ant.3	23.80	16.30	15.30	21.80	20.30	20.30	21.80	20.30
	LTE Band66	Ant.4	24.00	24.00	24.00	21.50	20.50	20.50	21.50	20.50
	LTE Band66	Ant.5	22.20	20.70	19.70	20.20	18.70	18.70	20.20	18.70
	n38	Ant.3	25.20	18.70	17.20	20.70	19.20	19.20	20.70	19.20
	n38	Ant.4	25.40	25.40	25.40	23.40	21.90	21.90	23.40	21.90
	n38	Ant.5	23.60	21.60	20.10	23.60	23.60	23.60	23.60	23.60
DC_2A_n41A	LTE Band2	Ant.3	23.80	18.80	18.30	22.30	20.80	20.80	22.30	20.80

	LTE Band2	Ant.4	24.00	24.00	24.00	22.00	21.00	21.00	22.00	21.00
	LTE Band2	Ant.5	22.20	21.20	20.20	21.20	19.20	19.20	21.20	19.20
	n41	Ant.3	25.20	17.20	16.20	19.20	17.70	17.70	19.20	17.70
	n41	Ant.4	25.40	25.40	25.40	22.40	19.90	19.90	22.40	19.90
	n41	Ant.5	22.90	19.40	17.40	22.90	21.40	21.40	22.90	21.40
DC_4A_n41A	LTE Band4	Ant.3	23.80	16.80	15.80	21.30	20.30	20.30	21.30	20.30
	LTE Band4	Ant.4	24.00	24.00	24.00	21.50	20.50	20.50	21.50	20.50
	LTE Band4	Ant.5	22.20	20.20	19.20	20.20	18.70	18.70	20.20	18.70
	n41	Ant.3	25.20	17.20	16.20	19.20	17.70	17.70	19.20	17.70
	n41	Ant.4	25.40	25.40	25.40	22.40	19.90	19.90	22.40	19.90
	n41	Ant.5	22.90	19.40	17.40	22.90	21.40	21.40	22.90	21.40
DC_26A_n41A	LTE Band26	Ant.0	23.80	21.80	20.80	21.80	20.80	20.80	21.80	20.80
	LTE Band26	Ant.1	25.00	21.50	20.50	22.00	21.00	21.00	22.00	21.00
	n41	Ant.3	25.20	17.20	16.20	19.20	17.70	17.70	19.20	17.70
	n41	Ant.4	25.40	25.40	25.40	22.40	19.90	19.90	22.40	19.90
	n41	Ant.5	22.90	19.40	17.40	22.90	21.40	21.40	22.90	21.40
DC_66A_n41A	LTE Band66	Ant.3	23.80	16.30	15.30	21.80	20.30	20.30	21.80	20.30
	LTE Band66	Ant.4	24.00	24.00	24.00	21.50	20.50	20.50	21.50	20.50
	LTE Band66	Ant.5	22.20	20.70	19.70	20.20	18.70	18.70	20.20	18.70
	n41	Ant.3	25.20	17.20	16.20	19.20	17.70	17.70	19.20	17.70
	n41	Ant.4	25.40	25.40	25.40	22.40	19.90	19.90	22.40	19.90
	n41	Ant.5	22.90	19.40	17.40	22.90	21.40	21.40	22.90	21.40

* P_{max} is used for RF tune up procedure. The maximum allowed output power is equal to $P_{max} - 2$ dB device uncertainty.

Maximum target power, P_{max} , is configured in NV settings in EUT to “limit maximum transmitting power”. This power is converted into “peak power in NV settings for TDD schemes”. The EUT maximum allowed output power is equal to $P_{max} - 2$ dB device uncertainty. EFS file P_{limit} level will compare to P_{max} , when P_{limit} is high than P_{max} , the power will be limited to P_{max} power level.

**All P_{limit} power levels entered in the Table correspond to average power levels after accounting for duty cycle in the case TDD modulation schemes (for e.g., GSM & LTE TDD & NR TDD).

Based on selection criteria described in Section 6.2.1, the selected technologies/bands for testing time-varying test sequences are listed in Table 4-1, the *Reserve_power_margin* (dB) for this EUT is set to 3dB in EFS, and is used in Part 2 test.

The radio configurations used in Part 2 test for selected technologies, bands, DSIs and antennas are listed in Table 8-2. The corresponding worst-case radio configuration 1gSAR or 10gSAR values for selected technology/band/D SI are extracted from Part 1 report and are listed in the last column of Table 8-2.

Based on equations (1a) and (3a), it is clear that Part 2 testing outcome is normalized quantity, which implies that it can be applied to any radio configuration within a selected technology/band/D SI. Thus, as long as applying the worst-case SAR obtained from the worst radio

configuration in Part 1 testing to calculate time-varying SAR exposure in equations (1a) and (3a), the accuracy in compliance demonstration remains the same.

Table 8-2 Radio configuration selected for Part2 test

Test case	Test Scenario	Tech	Band	Antenna	DSI	Channel	Fre. (MHz)	BW	RB size	RB offset	Mode	Position	Distance(mm)	Part1 SAR@Plimit 1g SAR (W/Kg)	Tune up Pmax [dBm]	Measured Pmax [Power meter]	EFS Plimit [dBm]	Measured Plimit [Power meter]
1	Sequence1	GSM	850	0	3	251	848.8	/	/	/	GPRS 4TX Slots	Back Side	15	0.638	27.50	25.99	26.50	24.63
2	Sequence2		850	0	3	251	848.8	/	/	/	GPRS 4TX Slots	Back Side	15	0.638	27.50	25.99	26.50	24.63
3	Sequence1		1900	3	10	512	1850.2	/	/	/	GPRS 4TX Slots	Right Tilt	0	0.702	25.30	23.35	22.80	20.86
4	Sequence2		1900	3	10	512	1850.2	/	/	/	GPRS 4TX Slots	Right Tilt	0	0.702	25.30	23.35	22.80	20.86
5	Sequence1	WCDMA	4	3	3	1513	1752.6	/	/	/	RMC	Back Side	15	0.334	24.60	24.19	22.60	22.42
6	Sequence2		4	3	3	1513	1752.6	/	/	/	RMC	Back Side	15	0.334	24.60	24.19	22.60	22.42
7	Sequence1		4	3	10	1412	1732.4	/	/	/	RMC	Right Cheek	0	0.651	24.60	24.22	16.60	16.32
8	Sequence2		4	3	10	1412	1732.4	/	/	/	RMC	Right Cheek	0	0.651	24.60	24.22	16.60	16.32
9	Sequence1	LTE	41	4	8	40620	2593	20	1	99	QPSK	Back Side	15	0.164	26.30	25.92	25.80	25.42
10	Sequence2		41	4	8	40620	2593	20	1	99	QPSK	Back Side	15	0.164	26.30	25.92	25.80	25.42
11	Sequence1		66	3	10	132322	1745	20	50	49	QPSK	Right Tilt	0	0.583	23.80	23.21	16.30	15.46
12	Sequence2		66	3	10	132322	1745	20	50	49	QPSK	Right Tilt	0	0.583	23.80	23.21	16.30	15.46
13	Sequence1	NR	12	1	3	141700	708.5	15	36	22	DFT-s-OFDM QPSK	Back Side	15	0.213	25.00	24.25	24.00	23.49
14	Sequence2		12	1	3	141700	708.5	15	36	22	DFT-s-OFDM QPSK	Back Side	15	0.213	25.00	24.25	24.00	23.49
15	Sequence1		66	3	5	349000	1745	40	1	1	DFT-s-OFDM QPSK	Right Tilt	0	0.546	24.80	24.15	16.80	16.26

16	Sequence2		66	3	5	349000	1745	40	1	1	DFT-s-OFDM QPSK	Right Tilt	0	0.546	24.80	24.15	16.80	16.26
17	Call Drop	LTE	66	3	10	132322	1745	20	50	49	QPSK	Right Tilt	0	0.583	23.80	23.21	16.30	15.46
18	call tech&band change&ANT Switch&DSI switch	LTE	41	4	8	40620	2593	20	1	99	QPSK	Back Side	15	0.164	26.30	25.92	25.80	25.42
		WCDMA	4	3	10	1412	1732.4	/	/	/	RMC	Right Cheek	0	0.651	24.60	24.22	16.60	16.32
19	100s-60s-100s	LTE	41	4	8	40620	2593	20	1	99	QPSK	Back Side	15	0.164	26.30	25.92	25.80	25.42
			48	10	10	55990	3625	20	50	25	QPSK	Right Cheek	0	0.611	20.80	19.45	16.80	16.03
20	60s-100s-60s	LTE	41	4	8	40620	2593	20	1	99	QPSK	Back Side	15	0.164	26.30	25.92	25.80	25.42
			48	10	10	55990	3625	20	50	25	QPSK	Right Cheek	0	0.611	20.80	19.45	16.80	16.03
21	SARvsSAR (n66_B5)	NR	66	3	5	349000	1745	40	1	1	DFT-s-OFDM QPSK	Right Tilt	0	0.546	24.80	24.15	16.80	16.26
		LTE	5	0	5	20600	844	10	25	12	QPSK	Right Cheek	0	1.139	23.80	23.29	21.80	21.17
22	head→no head→head	LTE	66	3	10	132322	1745	20	50	49	QPSK	Right Tilt	0	0.583	23.80	23.21	16.30	15.46
			66	3	3	132322	1745	20	1	99	QPSK	Back Side	15	0.425	24.80	24.15	22.80	22.21
			66	3	10	132322	1745	20	50	49	QPSK	Right Tilt	0	0.583	23.80	23.21	16.30	15.46
23	no head→head→no head	LTE	66	3	3	132322	1745	20	1	99	QPSK	Back Side	15	0.425	24.80	24.15	22.80	22.21
			66	3	10	132322	1745	20	50	49	QPSK	Right Tilt	0	0.583	23.80	23.21	16.30	15.46
			66	3	3	132322	1745	20	1	99	QPSK	Back Side	15	0.425	24.80	24.15	22.80	22.21

Note:

Based on the selection criteria described in Section 6.2, the radio configurations for the Tx varying transmission test cases listed in Section 5 are:

- Technologies and bands for time-varying Tx power transmission: The test case 1~16 listed in Table 8-2 are selected to test with the test sequences defined in Section 6.1 in both time-varying conducted power measurement and time-varying SAR measurement.
- Technology and band for change in call test: The test case 17 listed in Table 8-2 are selected for performing the call drop test in conducted power setup. LTE Band 66 having the lowest P_{limit} among all technologies and bands.
- Technologies and bands for change : The test case 18 listed in Table 8-2 by establishing a call in LTE Band 41, and then handing over to WCDMA Band 4 exposure scenario in conducted power setup.
- Technologies and bands for change in Antenna: The test case 18 listed in Table 8-2 is selected for antenna switch test by establishing a call in LTE Band 41 in antenna 4, and then handing over to WCDMA Band 4 in antenna 3 exposure scenario in conducted power setup.
- Technologies and bands for change in DSI: The test case 18 listed in Table 8-2 is selected for DSI switch test by establishing a call in LTE Band 41 in DSI=8, and then handing over to DSI = 10 exposure scenario in conducted power setup.
- Technologies and bands for change in Time window: The test case 19 listed in Table 8-2 is selected for time window switch test by establishing a call in LTE Band 41 in 100s time window , and then handing over to LTE Band 48 in 60s time window exposure scenario in conducted power setup.
- Technologies and bands for change in Time window: The test case 20 listed in Table 8-2 is selected for time window switch test by establishing a call in LTE Band 48 in 60s time window , and then handing over to LTE Band 41 in 100s time window exposure scenario in conducted power setup.
- Technologies and bands for switch in SAR exposure: The test case 21 listed in Table 8-2 are selected for SAR exposure switching test in one of the supported simultaneous WWAN transmission scenario, i.e., LTE Band 5 + NR Band 66 active in the same 100s time window, in conducted power setup.
- Exposure category switch in non-head to head to non-head: The test case 22 listed in Table 8-2 is selected for exposure category switch test by establishing a call in LTE Band 66 in DSI=10, and then handing over to DSI = 3 , and finally handing over to DSI = 10, exposure scenario in conducted power setup.
- Exposure category switch in head to non-head to head: The test case 23 listed in Table 8-2 is selected for exposure category switch test by establishing a call in LTE Band 66 in DSI=3, and then handing over to DSI = 10 , and finally handing over to DSI = 3, exposure scenario in conducted power setup.

8.2 P_{max} and P_{limit} Measurement Results

The measured P_{limit} for all the selected radio configurations given in Table 8-2 are listed in below Table 8-3. P_{max} was also measured for radio configurations selected for testing time-varying Tx power transmission scenarios in order to generate test sequences following the test procedures in Section 6.1.

Table 8-3 Measured P_{limit} and P_{max} of selected radio configurations

Test case	Test Scenario	Tech	Band	Antenna	DSI	Channel	Fre. (MHz)	BW	RB size	RB offset	Mode	Position	Distance(mm)	Part1 SAR@P _{limit} 1g SAR (W/Kg)	Tune up Pmax [dBm]	Measured Pmax [Power meter]	EFS P _{limit} [dBm]	Measured P _{limit} [Power meter]
1	Sequence1	GSM	850	0	3	251	848.8	/	/	/	GPRS 4TX Slots	Back Side	15	0.638	27.50	25.99	26.50	24.63
2	Sequence2		850	0	3	251	848.8	/	/	/	GPRS 4TX Slots	Back Side	15	0.638	27.50	25.99	26.50	24.63
3	Sequence1		1900	3	10	512	1850.2	/	/	/	GPRS 4TX Slots	Right Tilt	0	0.702	25.30	23.35	22.80	20.86

4	Sequence2		1900	3	10	512	1850.2	/	/	/	GPRS 4TX Slots	Right Tilt	0	0.702	25.30	23.35	22.80	20.86
5	Sequence1	WCDMA	4	3	3	1513	1752.6	/	/	/	RMC	Back Side	15	0.334	24.60	24.19	22.60	22.42
6	Sequence2		4	3	3	1513	1752.6	/	/	/	RMC	Back Side	15	0.334	24.60	24.19	22.60	22.42
7	Sequence1		4	3	10	1412	1732.4	/	/	/	RMC	Right Cheek	0	0.651	24.60	24.22	16.60	16.32
8	Sequence2		4	3	10	1412	1732.4	/	/	/	RMC	Right Cheek	0	0.651	24.60	24.22	16.60	16.32
9	Sequence1		41	4	8	40620	2593	20	1	99	QPSK	Back Side	15	0.164	26.30	25.92	25.80	25.42
10	Sequence2	LTE	41	4	8	40620	2593	20	1	99	QPSK	Back Side	15	0.164	26.30	25.92	25.80	25.42
11	Sequence1		66	3	10	132322	1745	20	50	49	QPSK	Right Tilt	0	0.583	23.80	23.21	16.30	15.46
12	Sequence2		66	3	10	132322	1745	20	50	49	QPSK	Right Tilt	0	0.583	23.80	23.21	16.30	15.46
13	Sequence1		NR	12	1	3	141700	708.5	15	36	22	DFT-s- OFDM QPSK	Back Side	15	0.213	25.00	24.25	24.00
14	Sequence2	12		1	3	141700	708.5	15	36	22	DFT-s- OFDM QPSK	Back Side	15	0.213	25.00	24.25	24.00	23.49
15	Sequence1	66		3	5	349000	1745	40	1	1	DFT-s- OFDM QPSK	Right Tilt	0	0.546	24.80	24.15	16.80	16.26
16	Sequence2	66		3	5	349000	1745	40	1	1	DFT-s- OFDM QPSK	Right Tilt	0	0.546	24.80	24.15	16.80	16.26
17	Call Drop	LTE	66	3	10	132322	1745	20	50	49	QPSK	Right Tilt	0	0.583	23.80	23.21	16.30	15.46
18	call tech&band change&ANT Switch&DSI switch	LTE	41	4	8	40620	2593	20	1	99	QPSK	Back Side	15	0.164	26.30	25.92	25.80	25.42
		WCDMA	4	3	10	1412	1732.4	/	/	/	RMC	Right Cheek	0	0.651	24.60	24.22	16.60	16.32
19	100s-60s-100s	LTE	41	4	8	40620	2593	20	1	99	QPSK	Back Side	15	0.164	26.30	25.92	25.80	25.42
			48	10	10	55990	3625	20	50	25	QPSK	Right Cheek	0	0.611	20.80	19.45	16.80	16.03

20	60s-100s-60s	LTE	41	4	8	40620	2593	20	1	99	QPSK	Back Side	15	0.164	26.30	25.92	25.80	25.42
			48	10	10	55990	3625	20	50	25	QPSK	Right Cheek	0	0.611	20.80	19.45	16.80	16.03
21	SARvsSAR (n66_B5)	NR	66	3	5	349000	1745	40	1	1	DFT-s-OFDM	Right Tilt	0	0.546	24.80	24.15	16.80	16.26
		LTE	5	0	5	20600	844	10	25	12	QPSK	Right Cheek	0	1.139	23.80	23.29	21.80	21.17
22	head→no head→head	LTE	66	3	10	132322	1745	20	50	49	QPSK	Right Tilt	0	0.583	23.80	23.21	16.30	15.46
			66	3	3	132322	1745	20	1	99	QPSK	Back Side	15	0.425	24.80	24.15	22.80	22.21
			66	3	10	132322	1745	20	50	49	QPSK	Right Tilt	0	0.583	23.80	23.21	16.30	15.46
23	no head→head→no head	LTE	66	3	3	132322	1745	20	1	99	QPSK	Back Side	15	0.425	24.80	24.15	22.80	22.21
			66	3	10	132322	1745	20	50	49	QPSK	Right Tilt	0	0.583	23.80	23.21	16.30	15.46
			66	3	3	132322	1745	20	1	99	QPSK	Back Side	15	0.425	24.80	24.15	22.80	22.21

Note:

Based on the selection criteria described in Section 6.2, the radio configurations for the

Tx varying transmission test cases listed in Section 5 are:

- Technologies and bands for time-varying Tx power transmission: The test case 1~16 listed in Table 8-2 are selected to test with the test sequences defined in Section 6.1 in both time-varying conducted power measurement and time-varying SAR measurement.
- Technology and band for change in call test: The test case 17 listed in Table 8-2 are selected for performing the call drop test in conducted power setup. LTE Band 66 having the lowest Plimit among all technologies and bands.
- Technologies and bands for change : The test case 18 listed in Table 8-2 by establishing a call in LTE Band 41, and then handing over to WCDMA Band 4 exposure scenario in conducted power setup.
- Technologies and bands for change in Antenna: The test case 18 listed in Table 8-2 is selected for antenna switch test by establishing a call in LTE Band 41 in antenna 4, and then handing over to WCDMA Band 4 in antenna 3 exposure scenario in conducted power setup.
- Technologies and bands for change in DSI: The test case 18 listed in Table 8-2 is selected for DSI switch test by establishing a call in LTE Band 41 in DSI=8, and then handing over to DSI = 10 exposure scenario in conducted power setup.
- Technologies and bands for change in Time window: The test case 20 listed in Table 8-2 is selected for time window switch test by establishing a call in LTE Band 41 in 100s time window , and then handing over to LTE Band 48 in 60s time window exposure scenario in conducted power setup.
- Technologies and bands for change in Time window: The test case 21 listed in Table 8-2 is selected for time window switch test by establishing a call in LTE Band 48 in 60s time window , and then handing over to LTE Band 41 in 100s time window exposure scenario in conducted power setup.
- Technologies and bands for switch in SAR exposure: The test case 21 listed in Table 8-2 are selected for SAR exposure switching test in one of the supported simultaneous WWAN transmission scenario, i.e., LTE Band 5 + NR Band 66 active in the same 100s time window, in conducted power setup.
- Exposure category switch in non-head to head to non-head: The test case 22 listed in Table 8-2 is selected for exposure category switch test by establishing a call in LTE Band 66 in DSI=10, and then handing over to DSI = 3 , and finally handing over to DSI = 10, exposure scenario in conducted power setup.
- Exposure category switch in head to non-head to head: The test case 23 listed in Table 8-2 is selected for exposure category switch test by establishing a call in LTE Band 66 in DSI=3, and then handing over to DSI = 10 , and finally handing over to DSI = 3, exposure scenario in conducted power setup.

Note:

1. The uncertainty of GSM is ± 1.2 dB as provided by manufacturer.
2. The uncertainty of WCDMA is ± 1.2 dB as provided by manufacturer.
3. The uncertainty of LTE is ± 1.2 dB as provided by manufacturer.
4. The uncertainty of NR FDD is ± 1.2 dB as provided by manufacturer.
5. The uncertainty of NR TDD is ± 1.2 dB as provided by manufacturer.
6. The Pmax and Plimit of Table is target power.

8.3 Time-varying TX Power Measurement Results

The measurement setup is shown in Figures 7-1. The purpose of the time-varying Tx power measurement is to demonstrate the effectiveness of power limiting enforcement and that the time-averaged Tx power when represented in time-averaged 1gSAR or 10gSAR values does not exceed FCC limit as shown in Eq. (1a) and (1b), rewritten below:

$$1g_or_10gSAR(t) = \frac{conducted_Tx_power(t)}{conducted_Tx_power_P_{limit}} * 1g_or_10gSAR_P_{limit} \quad (1a)$$

$$\frac{\frac{1}{T_{SAR}} \int_{t-T_{SAR}}^t 1g_or_10gSAR(t) dt}{FCC\ SAR\ limit} \leq 1 \quad (1b)$$

where, $conducted_Tx_power(t)$, $conducted_Tx_power_P_{limit}$, and $1g_or_10gSAR_P_{limit}$ correspond to the measured instantaneous conducted Tx power, measured conducted Tx power at P_{limit} , and measured 1gSAR or 10gSAR values at P_{limit} reported in Part1 test (listed in Table 8-2 of this report as well)

Following the test procedure in Section 6.3, the conducted Tx power measurement for all selected configurations are reported in this section. In all the conducted Tx power plots, the dotted line represents the requested power by callbox (test sequence 1 or test sequence 2), the blue curve represents the instantaneous conducted Tx power measured using power meter, the green curve represents time-averaged power and red line represents the conducted power limit that corresponds to FCC limit of 1.6 W/kg for 1gSAR or 4.0 W/kg for 10gSAR.

Similarly, in all the 1g or 10gSAR plots (when converted using Eq. (1a)), the green curve represents the 100s/60s-time averaged 1gSAR or 10gSAR value calculated based on instantaneous 1gSAR or 10gSAR; and the red line limit represents the FCC limit of 1.6 W/kg for 1gSAR or 4.0 W/kg for 10gSAR.

The power limiting enforcement is effective in all the tests, and the time-averaged 1g SAR does not exceed the SAR design target + device uncertainty for all the tested technologies/bands. Therefore, Qualcomm Smart Transmit time averaging feature is validated.

8.3.1 GSM 850

Test result for test sequence 1:

Time-averaged conducted Tx power is converted/calculated into time-averaged 1gSAR using Equation (1a) and plotted below to demonstrate that the time-averaged 1gSAR versus time does not exceed the FCC limit of 1.6 W/kg for 1gSAR:

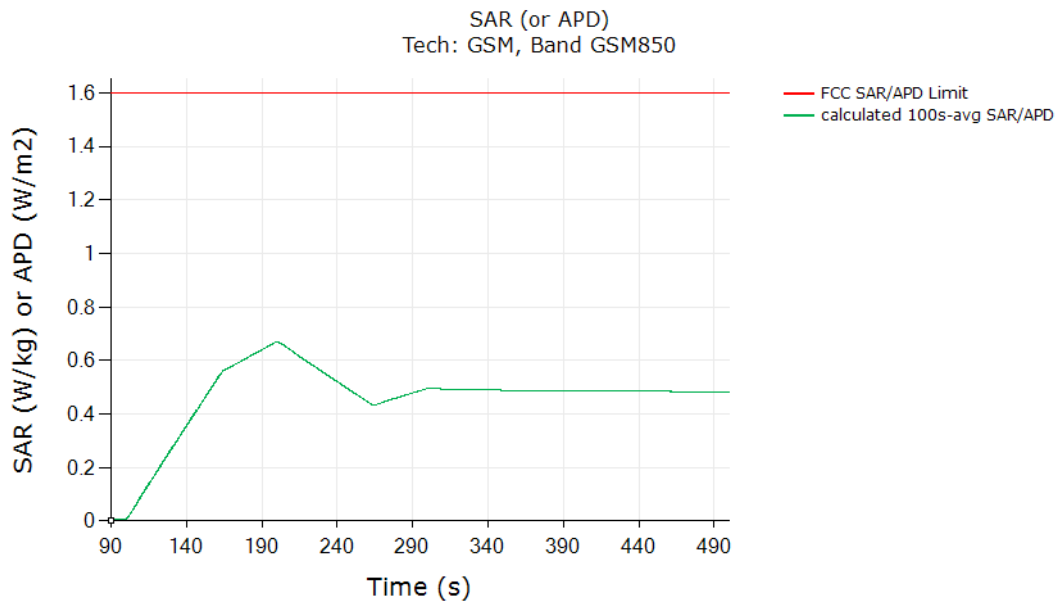

	(W/Kg)
FCC 1gSAR limit	1.6
Max 100s-time averaged 1gSAR (green curve)	0.671
<p>Validated: Max time averaged SAR (green curve) does not exceed measured SAR at $P_{limit} + 1.2\text{dB}$ device uncertainty.</p>	

Test result for test sequence 2:

Time-averaged conducted Tx power is converted/calculated into time-averaged 1gSAR using Equation (1a) and plotted below to demonstrate that the time-averaged 1gSAR versus time does not exceed the FCC limit of 1.6 W/kg for 1gSAR:

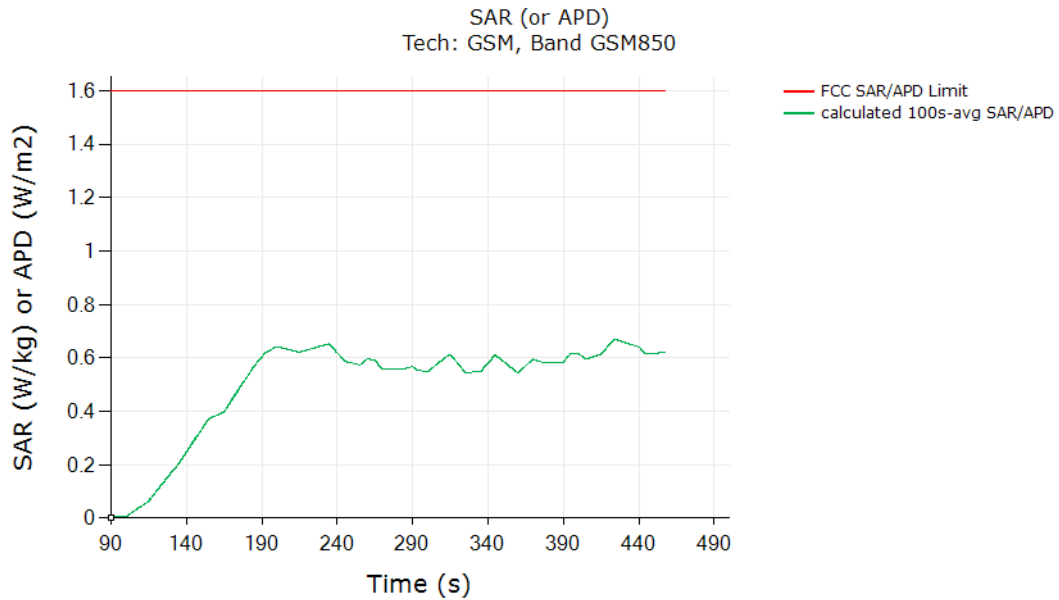

	(W/Kg)
FCC 1gSAR limit	1.6
Max 100s-time averaged 1gSAR (green curve)	0.670
Validated: Max time averaged SAR (green curve) does not exceed measured SAR at $P_{limit} + 1.2\text{dB}$ device uncertainty.	

8.3.2 GSM1900

Test result for test sequence 1:

Time-averaged conducted Tx power is converted/calculated into time-averaged 1gSAR using Equation (1a) and plotted below to demonstrate that the time-averaged 1gSAR versus time does not exceed the FCC limit of 1.6 W/kg for 1gSAR:

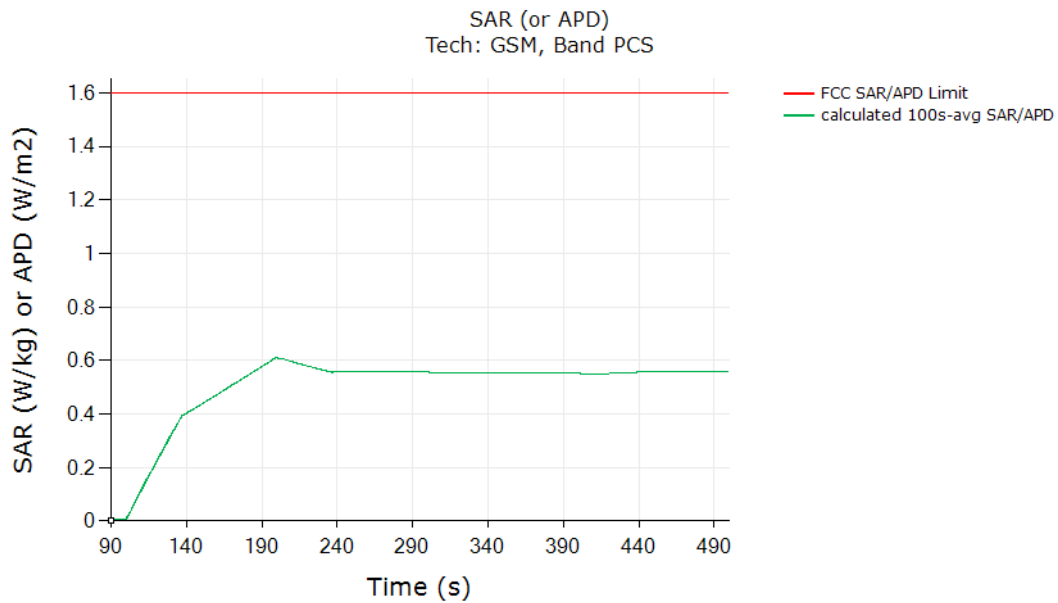

	(W/Kg)
FCC 1gSAR limit	1.6
Max 100s-time averaged 1gSAR (green curve)	0.612
<p>Validated: Max time averaged SAR (green curve) does not exceed measured SAR at $P_{limit} + 1.2\text{dB}$ device uncertainty.</p>	

Test result for test sequence 2:

Time-averaged conducted Tx power is converted/calculated into time-averaged 1gSAR using Equation (1a) and plotted below to demonstrate that the time-averaged 1gSAR versus time does not exceed the FCC limit of 1.6 W/kg for 1gSAR:

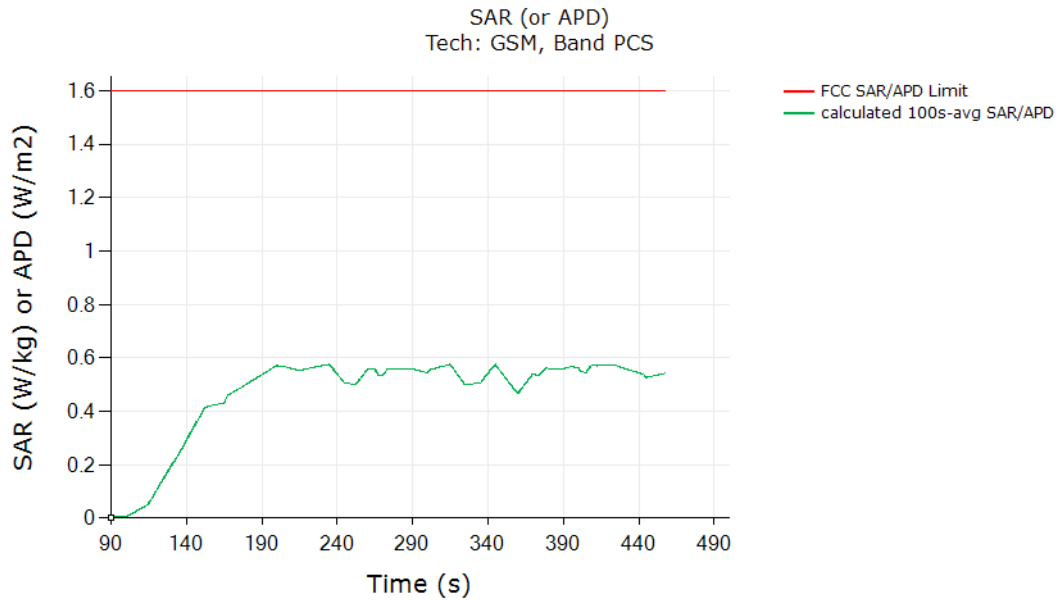

	(W/Kg)
FCC 1gSAR limit	1.6
Max 100s-time averaged 1gSAR (green curve)	0.576
<p>Validated: Max time averaged SAR (green curve) does not exceed measured SAR at $P_{limit} + 1.2\text{dB}$ device uncertainty.</p>	

8.3.3 WCDMA Band 4

Test result for test sequence 1:

Time-averaged conducted Tx power is converted/calculated into time-averaged 1gSAR using Equation (1a) and plotted below to demonstrate that the time-averaged 1gSAR versus time does not exceed the FCC limit of 1.6 W/kg for 1gSAR:

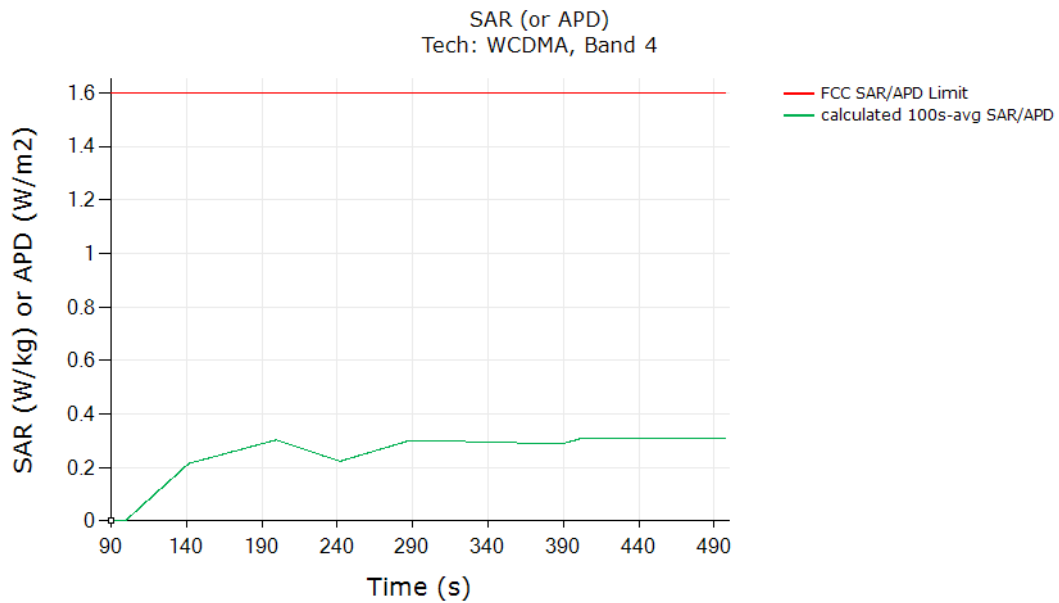

	(W/Kg)
FCC 1gSAR limit	1.6
Max 100s-time averaged 1gSAR (green curve)	0.307
<p>Validated: Max time averaged SAR (green curve) does not exceed measured SAR at $P_{limit} + 1.2\text{dB}$ device uncertainty.</p>	

Test result for test sequence 2:

Time-averaged conducted Tx power is converted/calculated into time-averaged 1gSAR using Equation (1a) and plotted below to demonstrate that the time-averaged 1gSAR versus time does not exceed the FCC limit of 1.6 W/kg for 1gSAR:

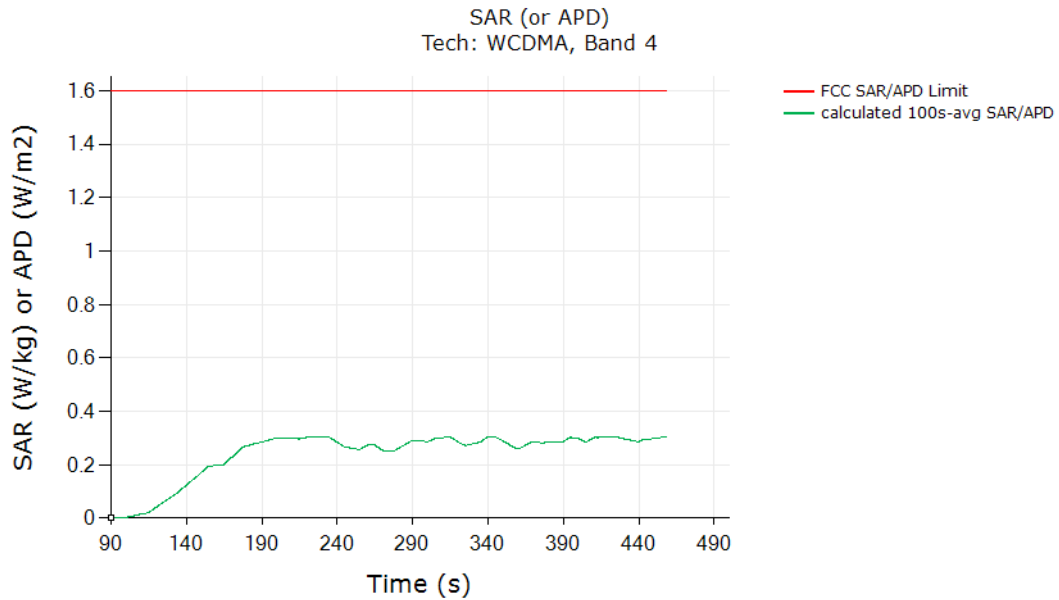

	(W/Kg)
FCC 1gSAR limit	1.6
Max 100s-time averaged 1gSAR (green curve)	0.305
<p>Validated: Max time averaged SAR (green curve) does not exceed measured SAR at $P_{limit} + 1.2\text{dB}$ device uncertainty.</p>	

8.3.4 WCDMA Band 4

Test result for test sequence 1:

Time-averaged conducted Tx power is converted/calculated into time-averaged 1gSAR using Equation (1a) and plotted below to demonstrate that the time-averaged 1gSAR versus time does not exceed the FCC limit of 1.6 W/kg for 1gSAR:

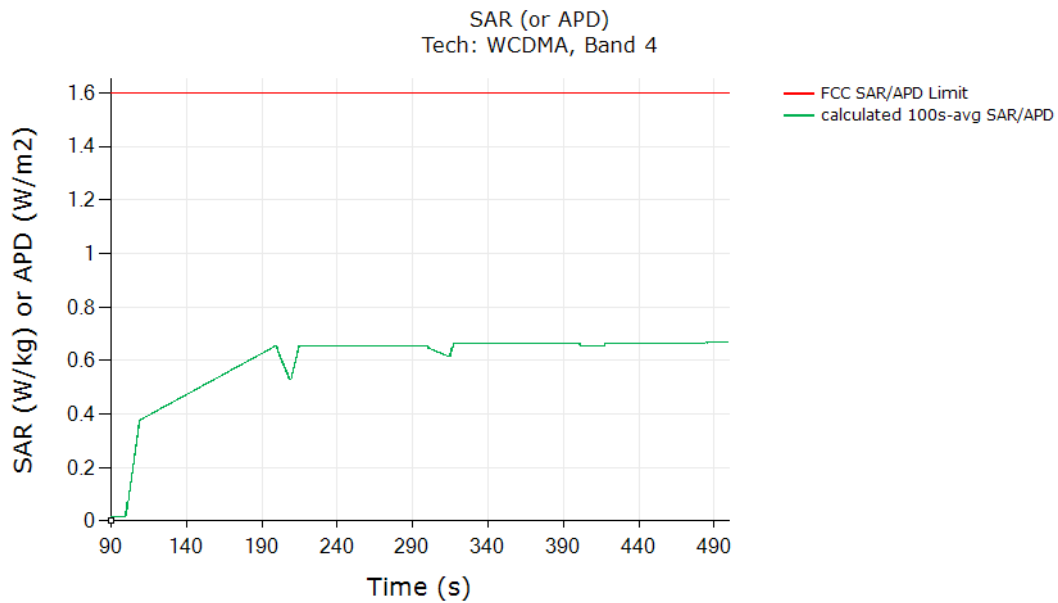

	(W/Kg)
FCC 1gSAR limit	1.6
Max 100s-time averaged 1gSAR (green curve)	0.666
<p>Validated: Max time averaged SAR (green curve) does not exceed measured SAR at $P_{limit} + 1.2\text{dB}$ device uncertainty.</p>	

Test result for test sequence 2:

Time-averaged conducted Tx power is converted/calculated into time-averaged 1gSAR using Equation (1a) and plotted below to demonstrate that the time-averaged 1gSAR versus time does not exceed the FCC limit of 1.6 W/kg for 1gSAR:

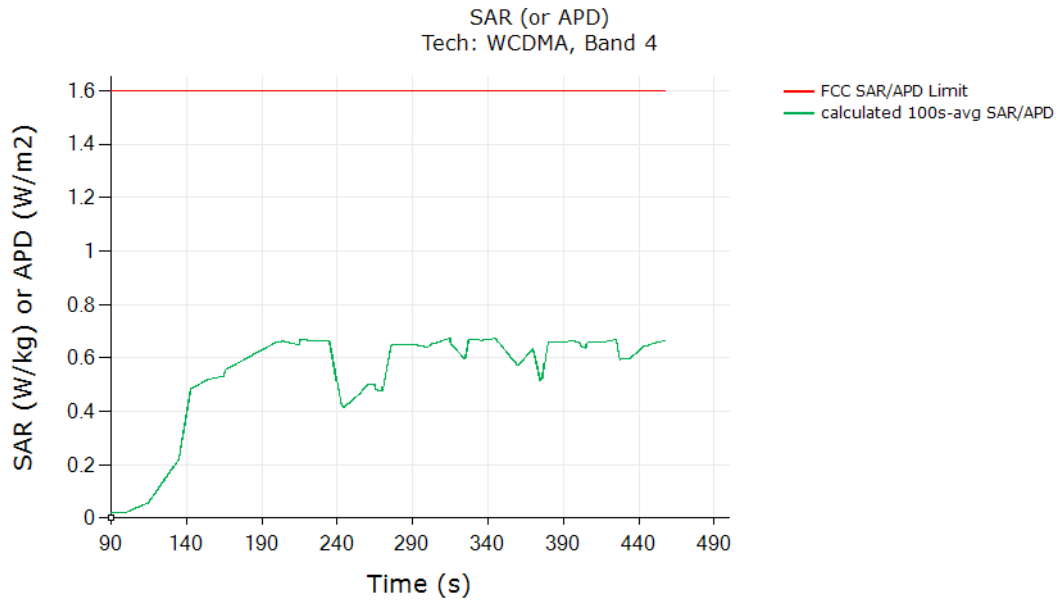

	(W/Kg)
FCC 1gSAR limit	1.6
Max 100s-time averaged 1gSAR (green curve)	0.674
<p>Validated: Max time averaged SAR (green curve) does not exceed measured SAR at $P_{limit} + 1.2\text{dB}$ device uncertainty.</p>	

8.3.5 LTE Band 41

Test result for test sequence 1:

Time-averaged conducted Tx power is converted/calculated into time-averaged 1gSAR using Equation (1a) and plotted below to demonstrate that the time-averaged 1gSAR versus time does not exceed the FCC limit of 1.6 W/kg for 1gSAR:

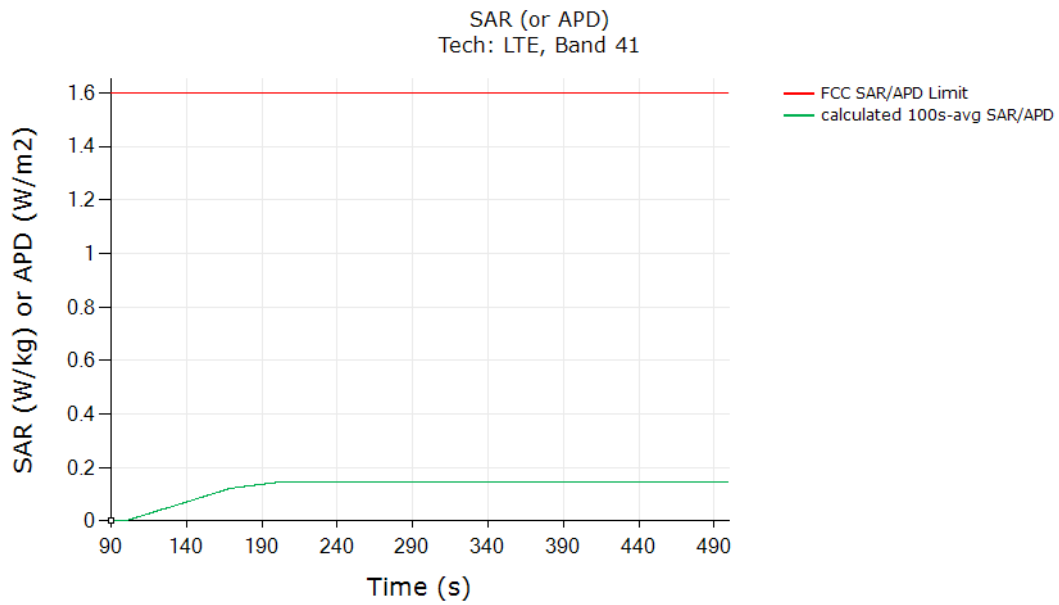

	(W/Kg)
FCC 1gSAR limit	1.6
Max 100s-time averaged 1gSAR (green curve)	0.146
<p>Validated: Max time averaged SAR (green curve) does not exceed measured SAR at $P_{limit} + 1.2\text{dB}$ device uncertainty.</p>	

Test result for test sequence 2:

Time-averaged conducted Tx power is converted/calculated into time-averaged 1gSAR using Equation (1a) and plotted below to demonstrate that the time-averaged 1gSAR versus time does not exceed the FCC limit of 1.6 W/kg for 1gSAR:

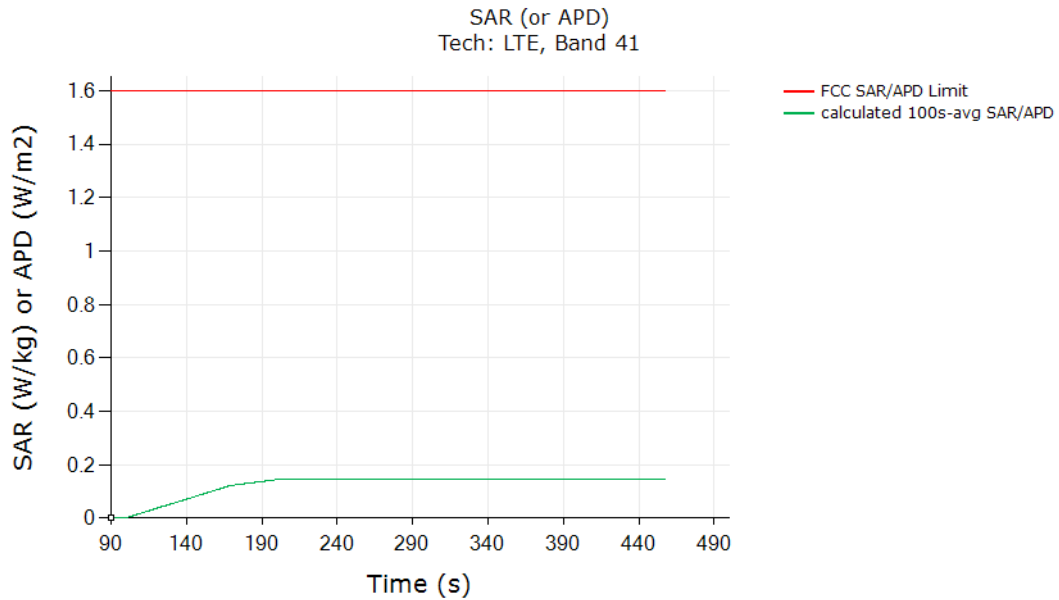

	(W/Kg)
FCC 1gSAR limit	1.6
Max 100s-time averaged 1gSAR (green curve)	0.145
<p>Validated: Max time averaged SAR (green curve) does not exceed measured SAR at $P_{limit} + 1.2\text{dB}$ device uncertainty.</p>	

8.3.6 LTE Band 66

Test result for test sequence 1:

Time-averaged conducted Tx power is converted/calculated into time-averaged 1gSAR using Equation (1a) and plotted below to demonstrate that the time-averaged 1gSAR versus time does not exceed the FCC limit of 1.6 W/kg for 1gSAR:

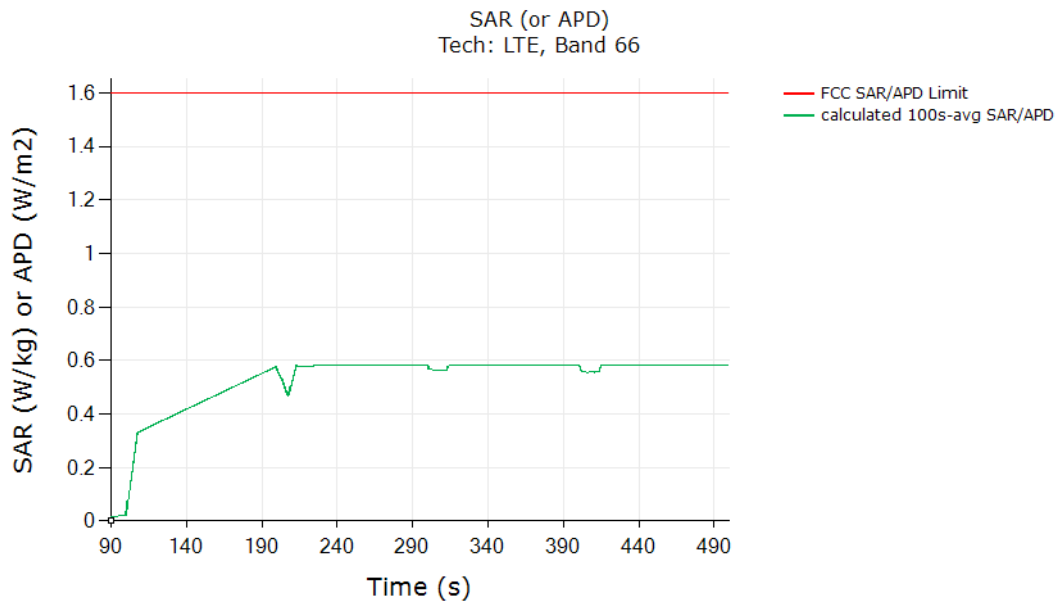

	(W/Kg)
FCC 1gSAR limit	1.6
Max 100s-time averaged 1gSAR (green curve)	0.581
<p>Validated: Max time averaged SAR (green curve) does not exceed measured SAR at $P_{limit} + 1.2\text{dB}$ device uncertainty.</p>	

Test result for test sequence 2:

Time-averaged conducted Tx power is converted/calculated into time-averaged 1gSAR using Equation (1a) and plotted below to demonstrate that the time-averaged 1gSAR versus time does not exceed the FCC limit of 1.6 W/kg for 1gSAR:

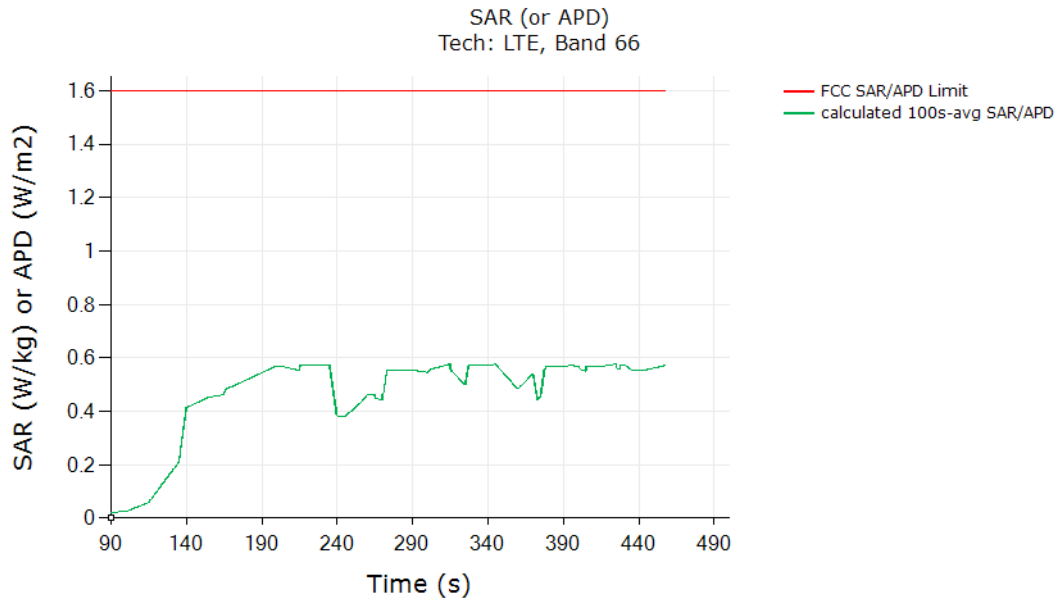

	(W/Kg)
FCC 1gSAR limit	1.6
Max 100s-time averaged 1gSAR (green curve)	0.577
<p>Validated: Max time averaged SAR (green curve) does not exceed measured SAR at $P_{limit} + 1.2\text{dB}$ device uncertainty.</p>	

8.3.7 NR n12 SA

Test result for test sequence 1:

Time-averaged conducted Tx power is converted/calculated into time-averaged 1gSAR using Equation (1a) and plotted below to demonstrate that the time-averaged 1gSAR versus time does not exceed the FCC limit of 1.6 W/kg for 1gSAR:

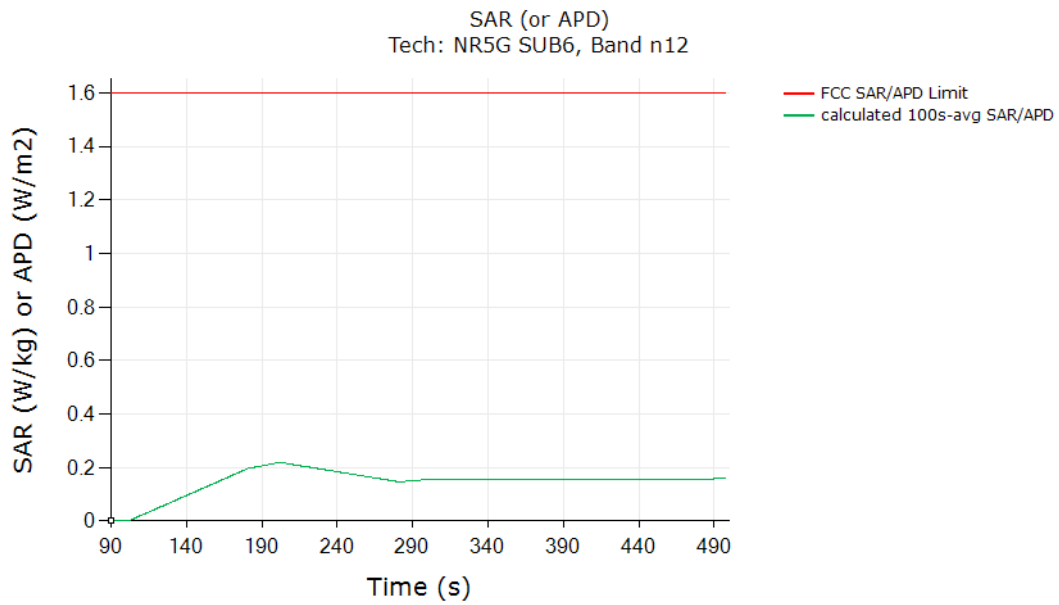

	(W/Kg)
FCC 1gSAR limit	1.6
Max 100s-time averaged 1gSAR (green curve)	0.219
<p>Validated: Max time averaged SAR (green curve) does not exceed measured SAR at $P_{limit} + 1.2\text{dB}$ device uncertainty.</p>	

Test result for test sequence 2:

Time-averaged conducted Tx power is converted/calculated into time-averaged 1gSAR using Equation (1a) and plotted below to demonstrate that the time-averaged 1gSAR versus time does not exceed the FCC limit of 1.6 W/kg for 1gSAR:

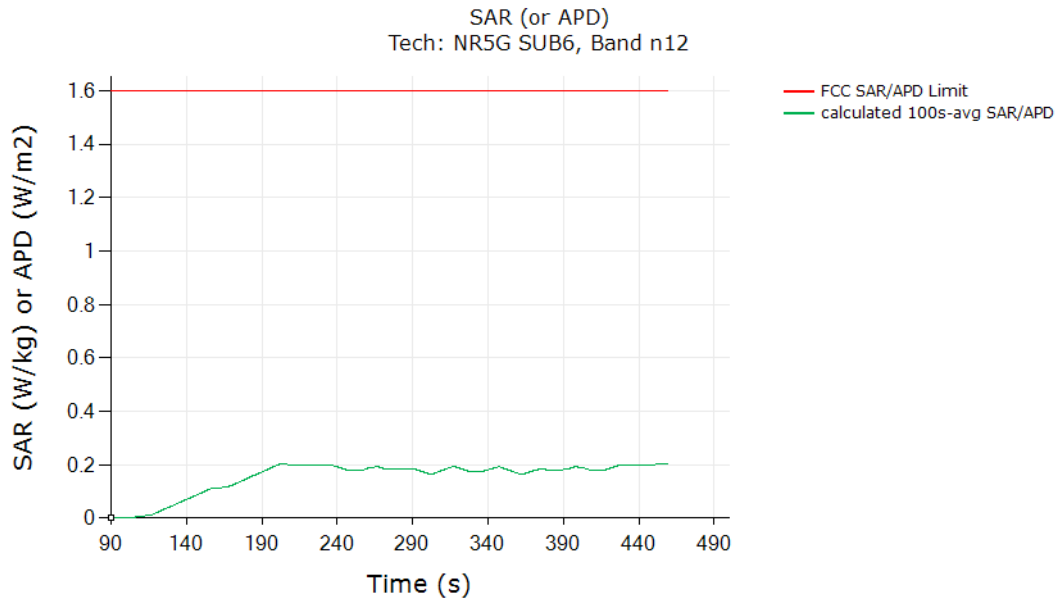

	(W/Kg)
FCC 1gSAR limit	1.6
Max 100s-time averaged 1gSAR (green curve)	0.205
<p>Validated: Max time averaged SAR (green curve) does not exceed measured SAR at $P_{limit} + 1.2\text{dB}$ device uncertainty.</p>	

8.3.8 NR n66 SA

Test result for test sequence 1:

Time-averaged conducted Tx power is converted/calculated into time-averaged 1gSAR using Equation (1a) and plotted below to demonstrate that the time-averaged 1gSAR versus time does not exceed the FCC limit of 1.6 W/kg for 1gSAR:

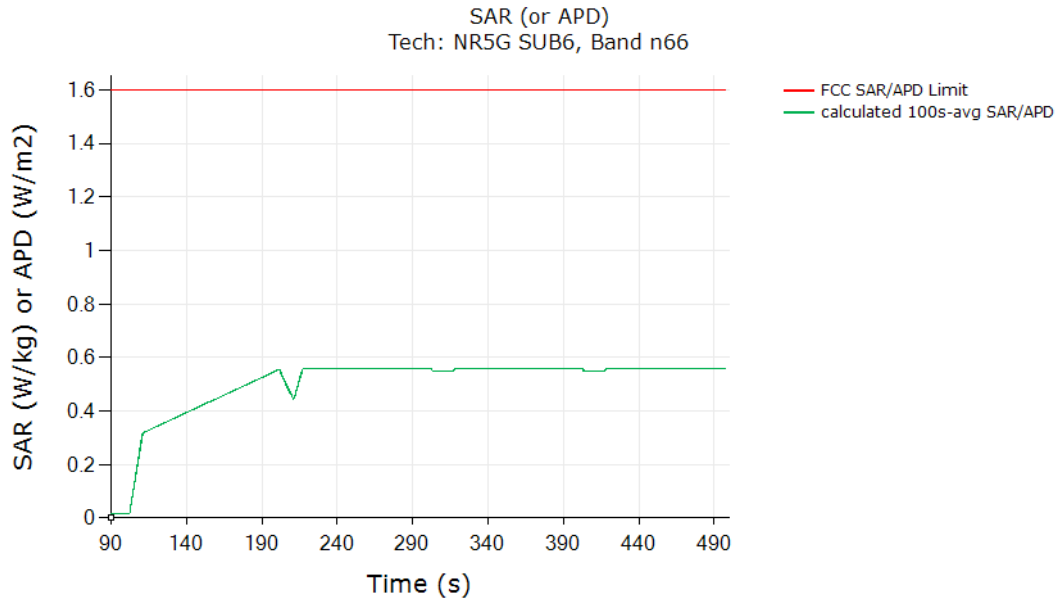

	(W/Kg)
FCC 1gSAR limit	1.6
Max 100s-time averaged 1gSAR (green curve)	0.558
<p>Validated: Max time averaged SAR (green curve) does not exceed measured SAR at $P_{limit} + 1.2\text{dB}$ device uncertainty.</p>	

Test result for test sequence 2:

Time-averaged conducted Tx power is converted/calculated into time-averaged 1gSAR using Equation (1a) and plotted below to demonstrate that the time-averaged 1gSAR versus time does not exceed the FCC limit of 1.6 W/kg for 1gSAR:

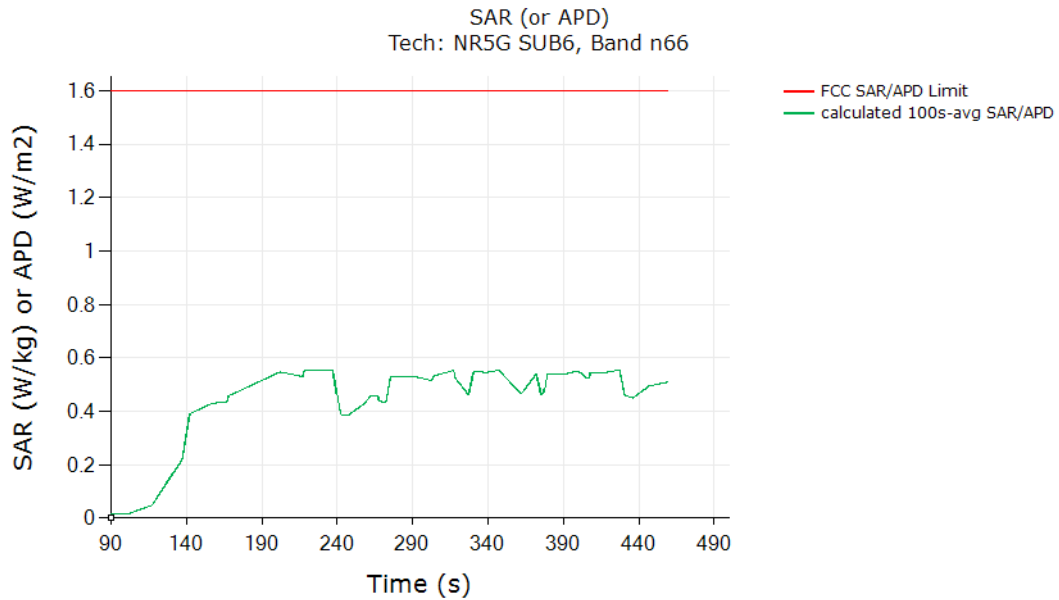

	(W/Kg)
FCC 1gSAR limit	1.6
Max 100s-time averaged 1gSAR (green curve)	0.554
<p>Validated: Max time averaged SAR (green curve) does not exceed measured SAR at $P_{limit} + 1.2\text{dB}$ device uncertainty.</p>	

8.4 Call Drop Test Results

This test was measured with LTE Band 66, DSI=10, and with callbox requesting maximum power. The call drop was manually performed when the EUT is transmitting at $P_{reserve}$ level as shown in the plot below. The measurement setup is shown in Figure 7-1. The detailed test procedure is described in Section 6.3.2.

Call drop test result:

Time-averaged conducted Tx power is converted/calculated into time-averaged 1gSAR using Equation (1a) and plotted below to demonstrate that the time-averaged 1gSAR versus time does not exceed the FCC limit of 1.6 W/kg for 1gSAR:

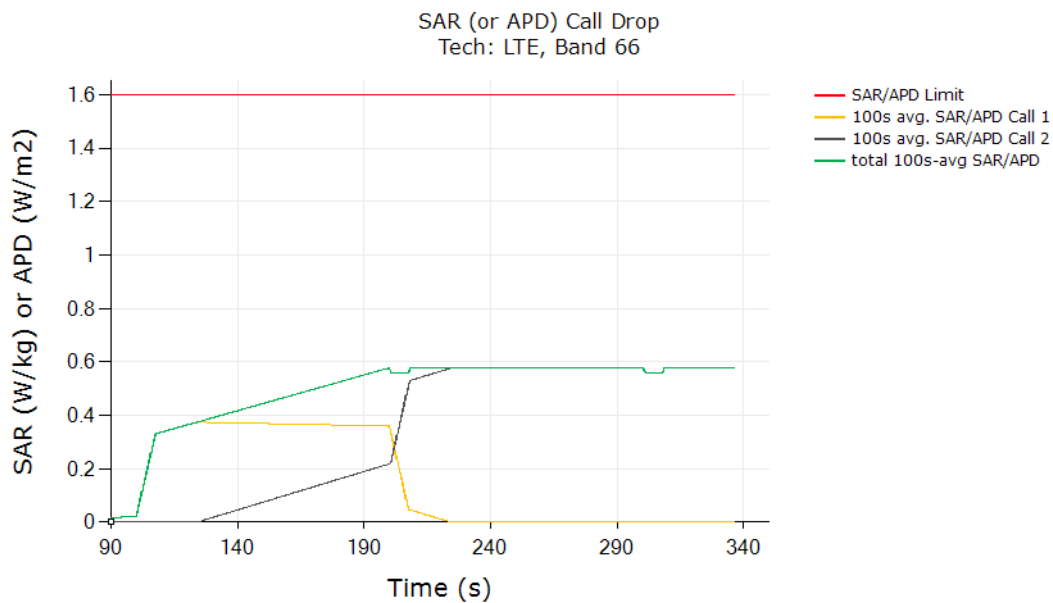

	(W/Kg)
FCC 1gSAR limit	1.6
Max 100s-time averaged 1gSAR (green curve)	0.744
Validated	

Note: The test result validated the continuity of power limiting in call change scenario.

8.5 Change in Technology/Band, Antenna and DSI switch Test Case

This test was conducted with callbox requesting maximum power, and with antenna & technology switch from LTE Band 41 Antenna4 DSI8 to WCDMA Band 4 Antenna3 DSI10. Following procedure detailed in Section 6.3.3, 6.3.4 and 6.3.6, and using the measurement setup shown in Figure 7-1, the technology/band switch was performed when the EUT is transmitting at Preserve level as shown in the plot below

Change in technology/band test result:

Time-averaged conducted Tx power measurement results were converted into time-averaged normalized SAR values using Equation (6a), (6b) and (6c), and plotted below to demonstrate that the normalized time-averaged RF exposure does not exceed the FCC limit of 1.0:

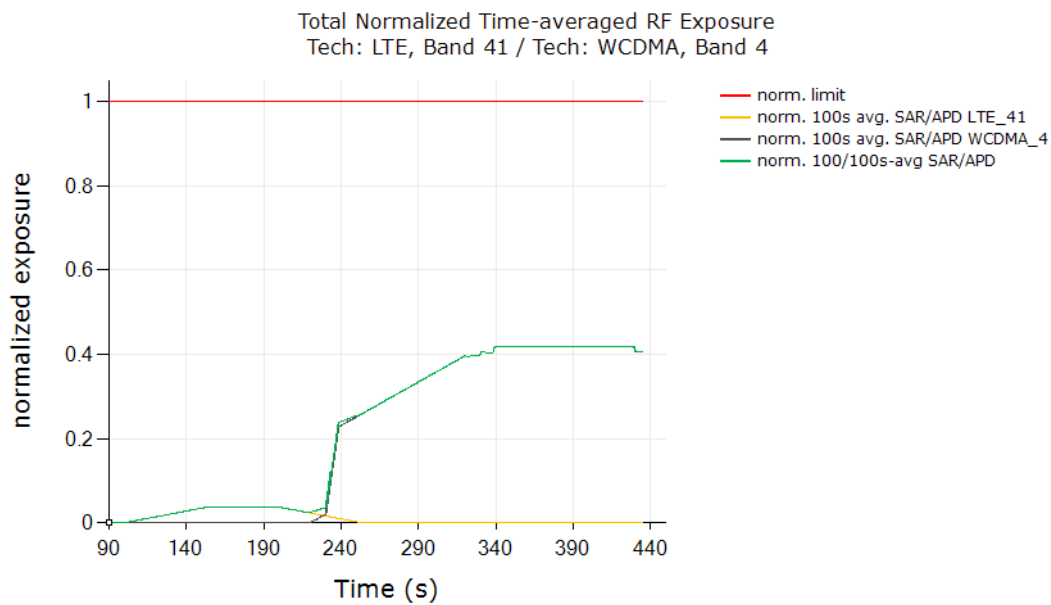

	(W/Kg)
FCC normalized total exposure limit	1.0
Max 100s-time averaged normalized Exposure Ratio (green curve)	0.417
Validated	

Note: The test result validated the continuity of power limiting in technology/band switch scenario.

8.6 Change in Time Windows Switch Test Results

This test was conducted with callbox requesting maximum power, and with time-windows/antenna switch between LTE Band 41 (100s window) and LTE Band 48 (60s window). Following procedure detailed in section 6.3.5, and using the measurement setup shown in Figure 6-1(b), the time-window switch via tech/band/antenna switch was performed when the DUT is transmitting at $P_{reserve}$ level.

8.6.1 Test case 1 transition from LTE Band 41 to LTE Band 48(i.e., 100s to 60s), then back to NR Band7

Test results for change in time-window (from 100s to 60s to 100s)

All the conducted Tx power measurement results were converted into time-averaged normalized SAR values using Equation (7a), (7b) and (7c), and plotted below to demonstrate that the normalized time-averaged RF exposure does not exceed the FCC limit of 1.0. Equation (7a) is used to convert the Tx power of device to obtain 100s-averaged normalized SAR in LTE Band 41 as shown in black curve. Similarly, equation (7b) is used to obtain 60s-averaged normalized SAR in LTE Band 48 as shown in orange curve. Equation (7c) is used to obtain total time-averaged normalized SAR as shown in green curve (i.e., sum of black and orange curves).

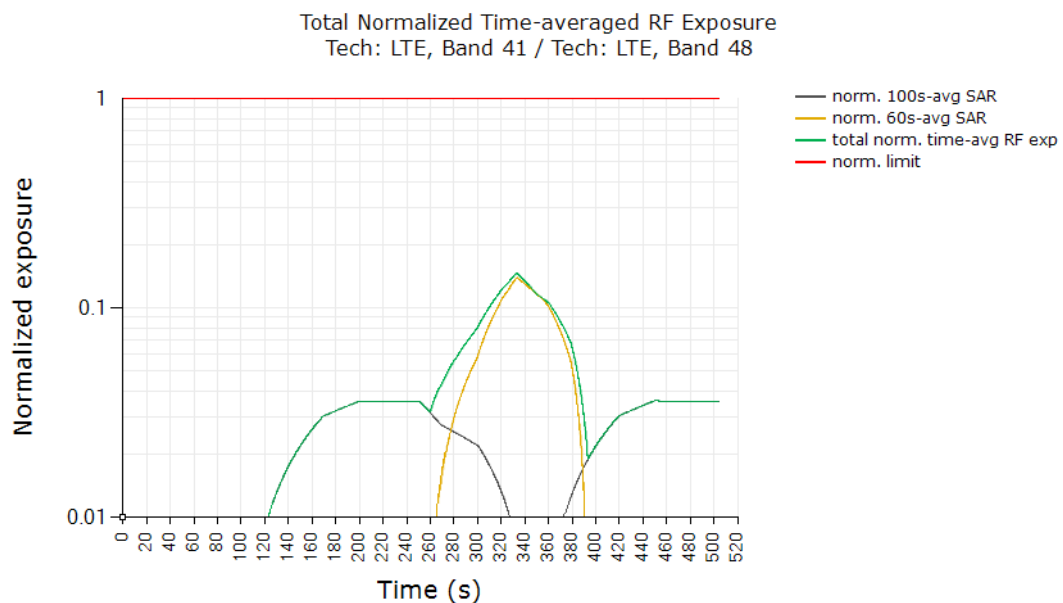

	(W/Kg)
FCC normalized total exposure limit	1.0
Max 100s-time averaged normalized Exposure Ratio (green curve)	0.147
Validated	

Plot Notes:

Maximum power is requested by callbox for the entire duration of the test, with tech/band switches from 100s-to-60s window at ~260s time stamp, and from 60s-to-100s window at ~350s time stamp. Smart Transmit controls the Tx power during these timewindow switches to ensure total time-averaged RF exposure, i.e., sum of black and orange curves given is always compliant. In time-window switch test, at all times the total time averaged normalized RF exposure (green curve) should not exceed normalized SAR_design_target

+total uncertainty. In this test, with a maximum normalized SAR of 0.147 being ≤ 0.503 ($=0.611/1.6$ +total uncertainty), the above test result validated the continuity of power limiting in time-window switch scenario.

8.6.2 Test case 2 transition from LTE Band 48 to LTE Band 41(i.e., 60s to 100s), then back to NR Band78

Test results for change in time-window (from 60s to 100s to 60s)

All the conducted Tx power measurement results were converted into time-averaged normalized SAR values using Equation (7a), (7b) and (7c), and plotted below to demonstrate that the normalized time-averaged RF exposure does not exceed the FCC limit of 1.0. Equation (7a) is used to convert the Tx power of device to obtain 100s-averaged normalized SAR in LTE Band 48 as shown in black curve. Similarly, equation (7b) is used to obtain 60s-averaged normalized SAR in LTE Band 41 as shown in orange curve. Equation (7c) is used to obtain total time-averaged normalized SAR as shown in green curve (i.e., sum of black and orange curves).

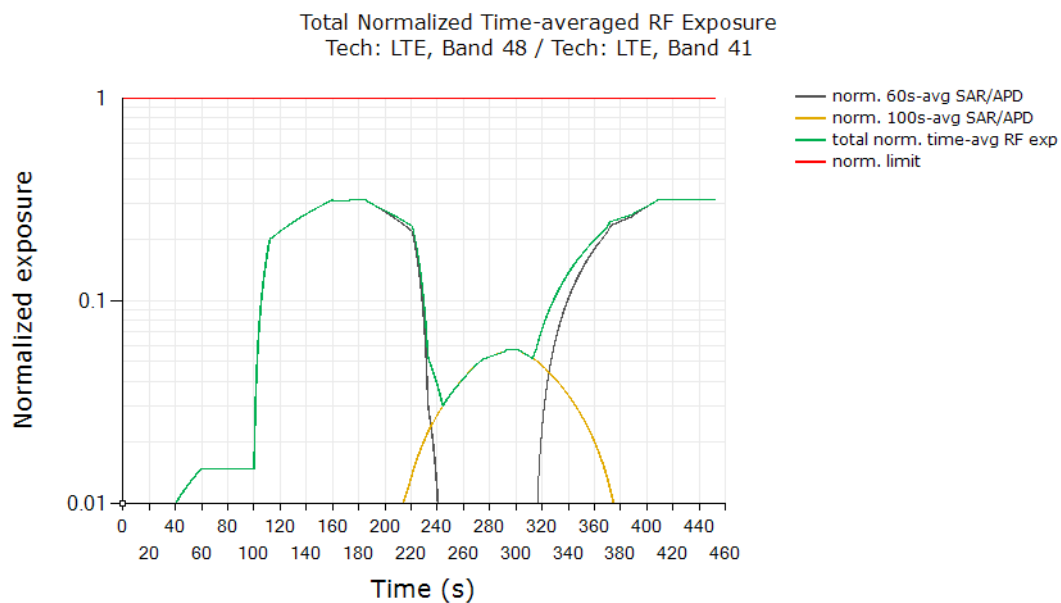

	(W/Kg)
FCC normalized total exposure limit	1.0
Max 100s-time averaged normalized Exposure Ratio (green curve)	0.317
Validated	

Plot Notes:

Maximum power is requested by callbox for the entire duration of the test, with tech/band switches from 60s-to-100s window at ~185s time stamp, and from 100s-to-+0s window at ~313s time stamp. Smart Transmit controls the Tx power during these timewindow switches to ensure total time-averaged RF exposure, i.e., sum of black and orange curves given is always compliant. In time-window switch test, at all times the total time averaged normalized RF exposure (green curve) should not exceed normalized SAR_design_target +total uncertainty. In this test, with a maximum normalized SAR of 0.317 being ≤ 0.503 ($=0.611/1.6$ +total uncertainty), the above test result validated thecontinuity of power limiting in time-window switch scenario.

8.7 Switch in SAR Exposure Test Results(EN-DC Combination)

This test was conducted with callbox requesting maximum power, and with the EUT in LTE Band 5 + 5G NR FR1 n66. Following procedure detailed in Section 6.3.7 and Annex B.2, and using the measurement setup shown in Figure 7-1, since LTE and Sub6 NR are on different antenna ports, the SAR exposure switch measurement is performed with the EUT in various SAR exposure scenarios, i.e., in SAR_{sub6} NR only scenario(t=0s ~ 120s), SAR_{sub6} + SAR_{LTE} scenario (t=120s ~ 240s) and SAR_{LTE} only scenario(t>240s).

Plot Note: All the conducted Tx power measurement results were converted into time-averaged normalized SAR values using Equation (7a), (7b) and (7c), and plotted below to demonstrate that the normalized time-averaged RF exposure does not exceed the FCC limit of 1.0. Equation (7a) is used to convert the LTE Tx power of device to obtain 100s-averaged normalized SAR in LTE Band 7 as shown in black curve. Similarly, equation (7b) is used to obtain 60s-averaged normalized SAR in 5G NR FR1 n78 as shown in orange curve. Equation (7c) is used to obtain total time-averaged normalized SAR as shown in green curve (i.e., sum of black and orange curves).

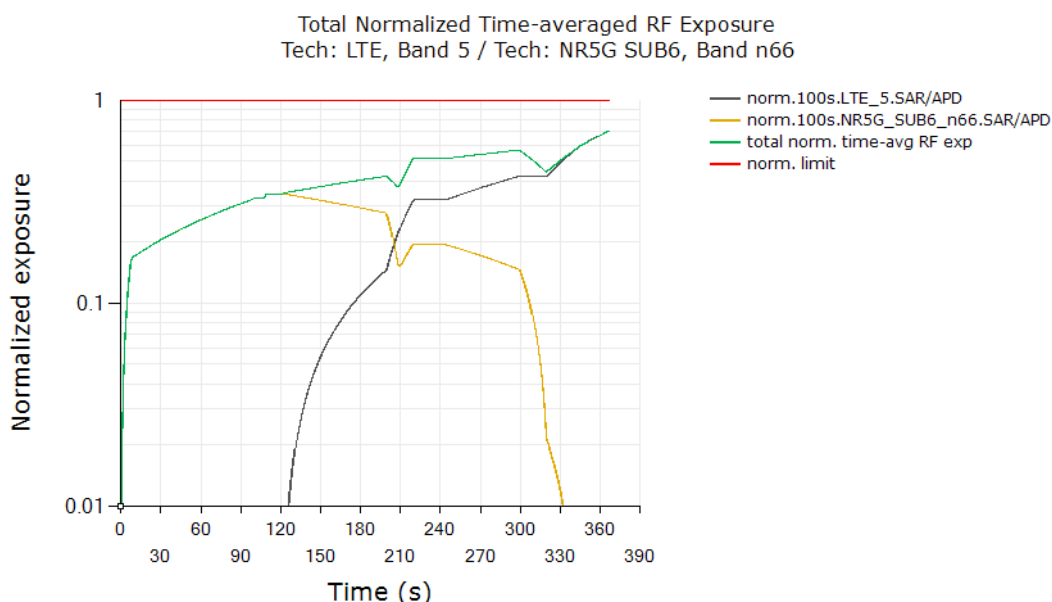

	(W/Kg)
FCC normalized total exposure limit	1.0
Max 100s-time averaged normalized Exposure Ratio (green curve)	0.706
Validated	

Plot Notes:

Device starts predominantly in 5G NR SAR exposure scenario between 0s and 120s, and in LTE SAR + 5G NR SAR exposure scenario between 120s and 240s, and in predominantly in LTE SAR exposure scenario after t=240s. Here, Smart Transmit allocates a maximum of 100% of exposure margin (based on 3dB reserve margin setting) for 5G NR. This corresponds to a normalized 1gSAR exposure value = $100\% * 0.546W/kg \text{ measured SAR at } 5G \text{ NR } P_{limit} / 1.6W/kg \text{ limit} = 0.341 \pm 1.2dB \text{ device related uncertainty}$ (see orange curve between 0s~120s). For predominantly LTE SAR exposure scenario, maximum normalized 1gSAR exposure should correspond to 100% exposure margin = $1.139W/kg \text{ measured SAR at LTE } P_{limit} / 1.6W/kg \text{ limit} = 0.712 \pm 1.2dB \text{ device related uncertainty}$ (see black curve

after $t = 240s$). Additionally, in SAR exposure switch test, at all times the total time-averaged normalized RF exposure (green curve) should not exceed normalized SAR_design_target +1.2dB device uncertainty. In this test, with a maximum normalized SAR of 0.706 being $\leq 0.985 (=1.139/1.6 +1.2dB$ device uncertainty), the above test result validated the continuity of power limiting in SAR exposure switch scenario.

8.8 Exposure Category Switch

This test was conducted with callbox requesting maximum power, and with DSI switch between NR n7, Antenna13 (Head Exposure). Following procedure detailed in Section 6.3.8, the DSI switch was performed when the EUT is transmitting at Preserve level as shown in the plot below

Change in head to no-head to head test result:

Maximum power is requested by callbox for the entire duration of the test, time-averaged exposure in head DSI gradually increases until t~305s where the device is switched from head exposure DSI(first DSI, orange curve) to non-head exposure DSI(second DSI, black curve) as evident from increase in exposure of black curve and no change in orange curve between t~305s and t~315s. At t~315s, device is switched back from non-head exposure to head exposure as evident from increase in exposure of orange curve and no change in black curve. In this test, the time-averaged normalized RF exposure in head exposure DSI(orange curve) did not exceed normalized limit of 1.0 at all times, and is less than normalized SAR 0.437 being $\leq 0.504 (=0.583/1.6 + 1.2\text{dB device uncertainty})$, validating the exposure continuity when switching between head exposure and non-head exposure categories

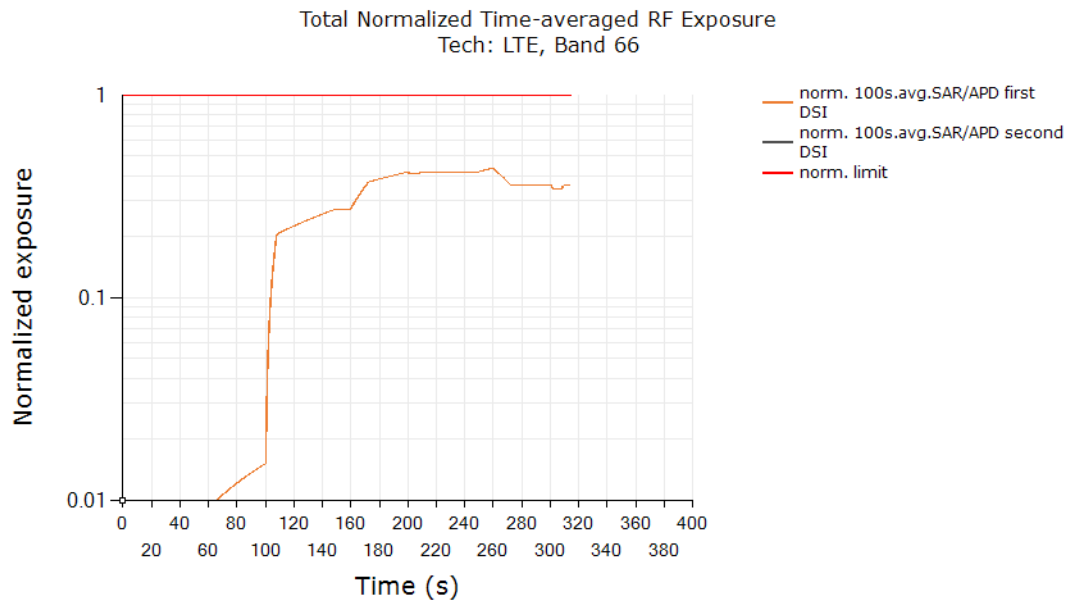

FCC normalized total exposure limit	1.0
Max 100s-time averaged normalized Exposure Ratio (green curve)	0.437
Validated	

Change in non-head to head to non-head test result:

Maximum power is requested by callbox for the entire duration of the test, time-averaged exposure in head DSI gradually increases until t~150s where the device is switched from head exposure DSI(first DSI, orange curve) to non-head exposure DSI(second DSI, black curve) as evident from increase in exposure of black curve and no change in orange curve between t~150s and t~160s. At t~160s, device is switched back from non-head exposure to head exposure as evident from increase in exposure of orange curve and no change in black curve. In this test, the time-averaged normalized RF exposure in head exposure DSI(orange curve) did not exceed normalized limit of 1.0 at all times, and is less than normalized SAR 0.251 being $\leq 0.504 (=0.583/1.6 + 1.2\text{dB device uncertainty})$, validating the exposure continuity when switching between head exposure and non-head exposure categories.

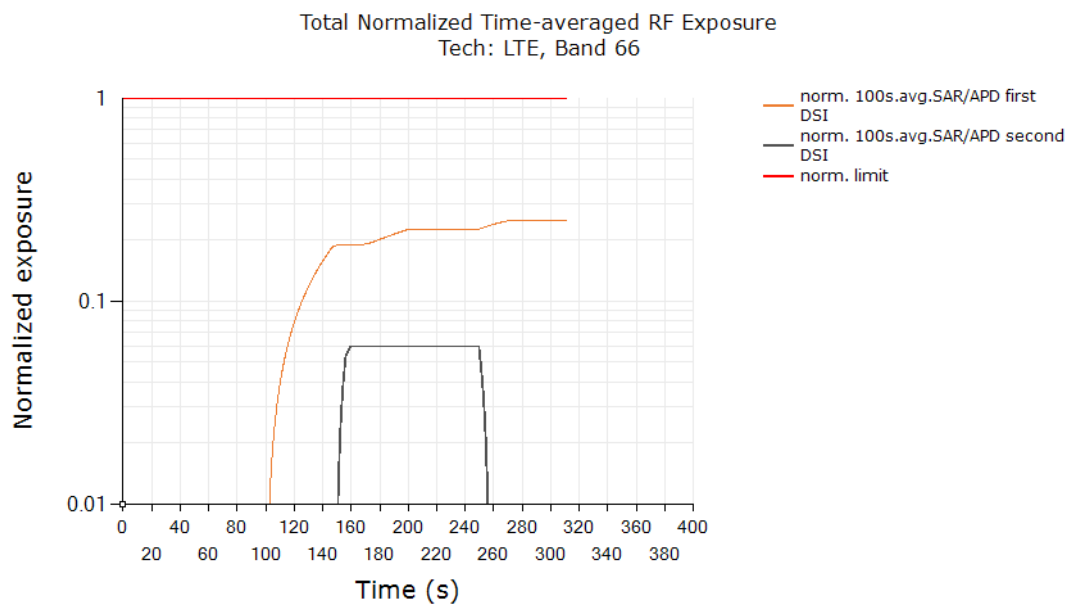

FCC normalized total exposure limit	1.0
Max 100s-time averaged normalized Exposure Ratio (green curve)	0.251
Validated	

9 SAR TEST RESULT for Sub-6 SMART TRANSMIT FEATURE VALIDATION

9.6 SAR Measurement for Time-varying Tx Power Scenario

Following Section 6.4 procedure, time-averaged SAR measurements are conducted using EX3DV4 probe at peak location of area scan over 500 seconds. cDASY6 system check, associated SPEAG certificates and liquid check for SAR measurement is provided in Annex C. Since the sampling rate used by cDASY6 for pointSAR measurements is not in user control, the number of points in 100s or 60s interval is determined from the scan duration setting in cDASY6 time-average pointSAR measurement by (100s or 60s / cDASY6_scan_duration * total number of pointSAR values recorded). Running average is performed over these number of points in excel spreadsheet to obtain 100s-/60s-averaged pointSAR.

Following Section 6.4, for each of selected technology/band (listed in Table 8-2):

1. With Reserve_power_margin set to 0 dB, area scan is performed at P_{limit} , and time-averaged pointSAR measurements are conducted to determine the pointSAR at P_{limit} at peak location, denoted as pointSAR P_{limit} .
2. With Reserve_power_margin set to actual (intended) value, two more time-averaged pointSAR measurements are performed at the same peak location for test sequences 1 and 2.

To demonstrate compliance, all the pointSAR measurement results were converted into 1gSAR or 10gSAR values by using Equation (3a), rewritten below:

$$1g_or_10gSAR(t) = \frac{pointSAR(t)}{pointSAR_{P_{limit}}} * 1g_or_10gSAR_{P_{limit}} \quad (3a)$$

where, $pointSAR(t)$, $pointSAR_{P_{limit}}$ and $1g_or_10gSAR_{P_{limit}}$ correspond to the measured instantaneous point SAR, measured point SAR at P_{limit} from above step 1 and 2, and measured 1gSAR or 10gSAR values at P_{limit} obtained from Part 1 report and listed in Table 8-2 in Section 7.1 of this report.

9.6.1 GSM 850

SAR Test result for test sequence 1:

Time-averaged conducted Tx power is converted/calculated into time-averaged 1gSAR using Equation (1a) and plotted below to demonstrate that the time-averaged 1gSAR versus time does not exceed the FCC limit of 1.6 W/kg for 1gSAR:

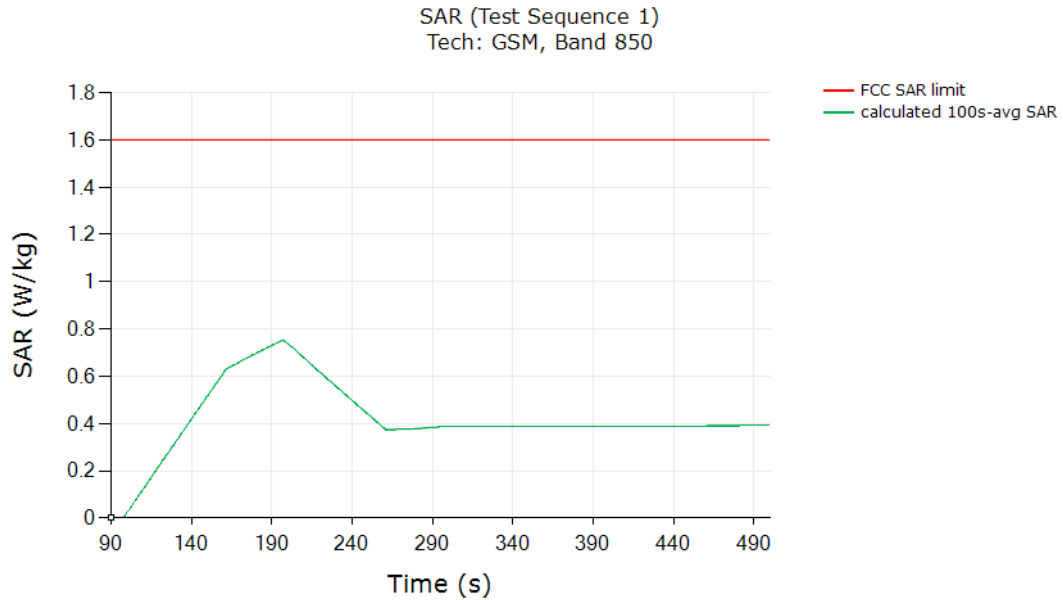

	(W/Kg)
FCC 1gSAR limit	1.6
Max 100s-time averaged 1gSAR (green curve)	0.752
Validated: Max time averaged SAR (green curve) does not exceed measured SAR at $P_{limit} + 1.2\text{dB}$ device uncertainty.	

SAR Test result for test sequence 2:

Time-averaged conducted Tx power is converted/calculated into time-averaged 1gSAR using Equation (1a) and plotted below to demonstrate that the time-averaged 1gSAR versus time does not exceed the FCC limit of 1.6 W/kg for 1gSAR:

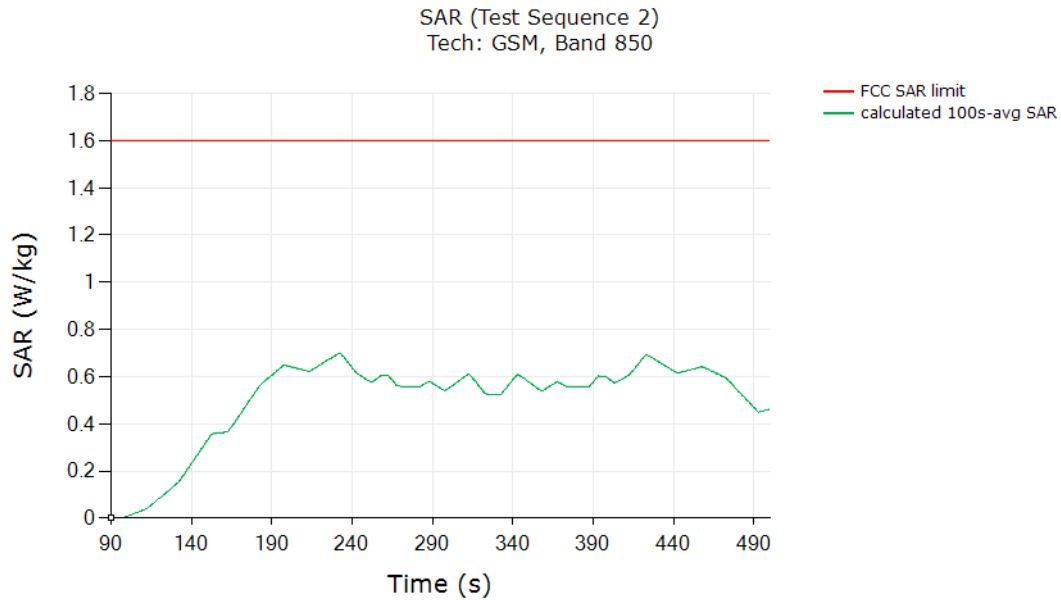

	(W/Kg)
FCC 1gSAR limit	1.6
Max 100s-time averaged 1gSAR (green curve)	0.698
<p>Validated: Max time averaged SAR (green curve) does not exceed measured SAR at $P_{limit} + 1.2\text{dB}$ device uncertainty.</p>	

9.6.2 GSM 1900

SAR Test result for test sequence 1:

Time-averaged conducted Tx power is converted/calculated into time-averaged 1gSAR using Equation (1a) and plotted below to demonstrate that the time-averaged 1gSAR versus time does not exceed the FCC limit of 1.6 W/kg for 1gSAR:

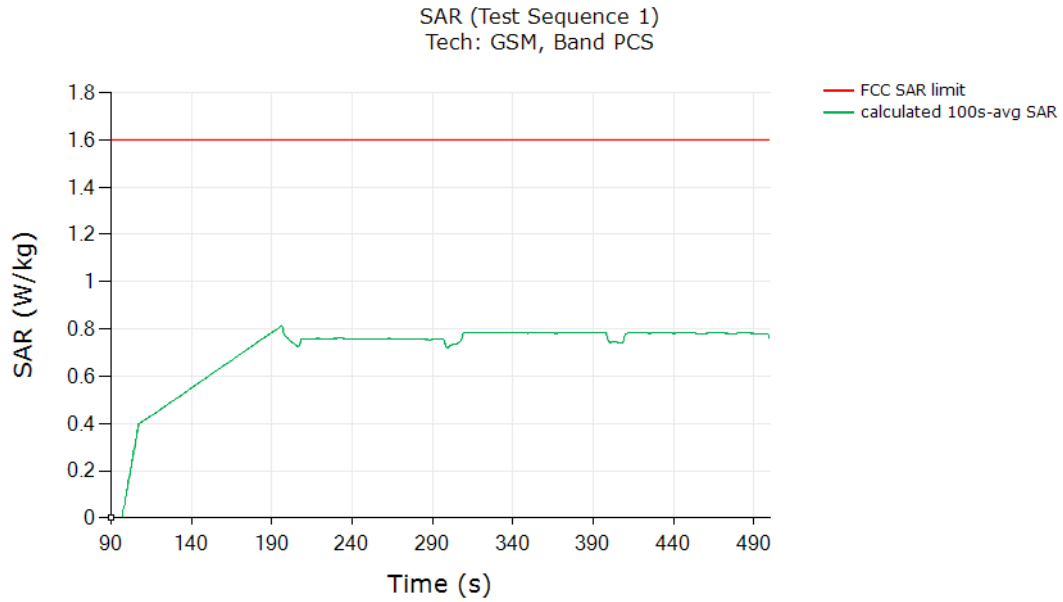

	(W/Kg)
FCC 1gSAR limit	1.6
Max 100s-time averaged 1gSAR (green curve)	0.813
Validated: Max time averaged SAR (green curve) does not exceed measured SAR at $P_{limit} + 1.2\text{dB}$ device uncertainty.	

SAR Test result for test sequence 2:

Time-averaged conducted Tx power is converted/calculated into time-averaged 1gSAR using Equation (1a) and plotted below to demonstrate that the time-averaged 1gSAR versus time does not exceed the FCC limit of 1.6 W/kg for 1gSAR:

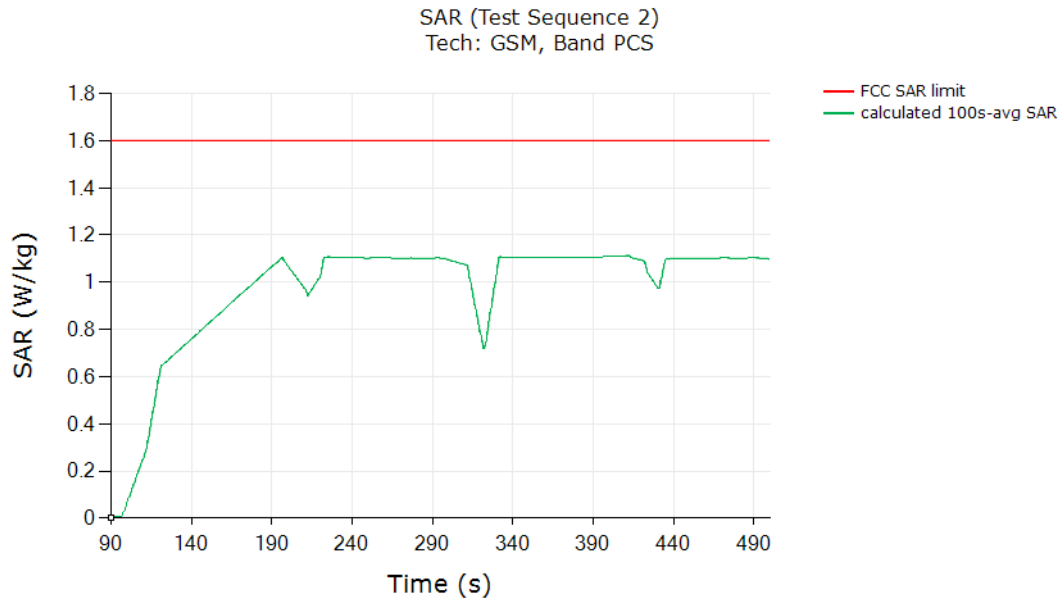

	(W/Kg)
FCC 1gSAR limit	1.6
Max 100s-time averaged 1gSAR (green curve)	0.853
<p>Validated: Max time averaged SAR (green curve) does not exceed measured SAR at $P_{limit} + 1.2\text{dB}$ device uncertainty.</p>	

9.6.3 WCDMA Band 4

SAR Test result for test sequence 1:

Time-averaged conducted Tx power is converted/calculated into time-averaged 1gSAR using Equation (1a) and plotted below to demonstrate that the time-averaged 1gSAR versus time does not exceed the FCC limit of 1.6 W/kg for 1gSAR:

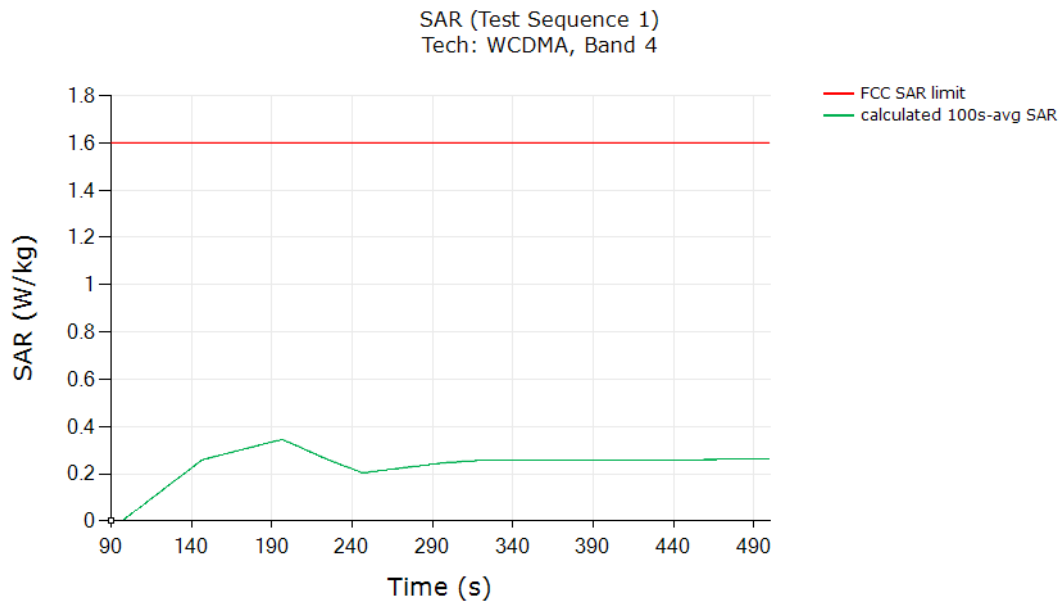

	(W/Kg)
FCC 1gSAR limit	1.6
Max 100s-time averaged 1gSAR (green curve)	0.344
Validated: Max time averaged SAR (green curve) does not exceed measured SAR at $P_{limit} + 1.2\text{dB}$ device uncertainty.	

SAR Test result for test sequence 2:

Time-averaged conducted Tx power is converted/calculated into time-averaged 1gSAR using Equation (1a) and plotted below to demonstrate that the time-averaged 1gSAR versus time does not exceed the FCC limit of 1.6 W/kg for 1gSAR:

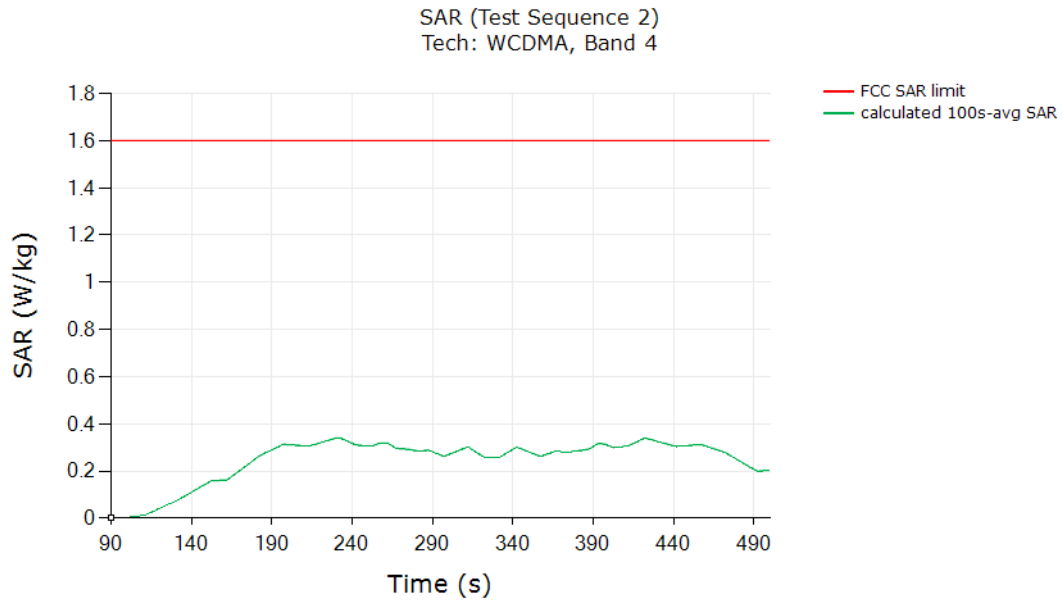

	(W/Kg)
FCC 1gSAR limit	1.6
Max 100s-time averaged 1gSAR (green curve)	0.340
<p>Validated: Max time averaged SAR (green curve) does not exceed measured SAR at $P_{limit} + 1.2\text{dB}$ device uncertainty.</p>	

9.6.4 WCDMA Band 5

SAR Test result for test sequence 1:

Time-averaged conducted Tx power is converted/calculated into time-averaged 1gSAR using Equation (1a) and plotted below to demonstrate that the time-averaged 1gSAR versus time does not exceed the FCC limit of 1.6 W/kg for 1gSAR:

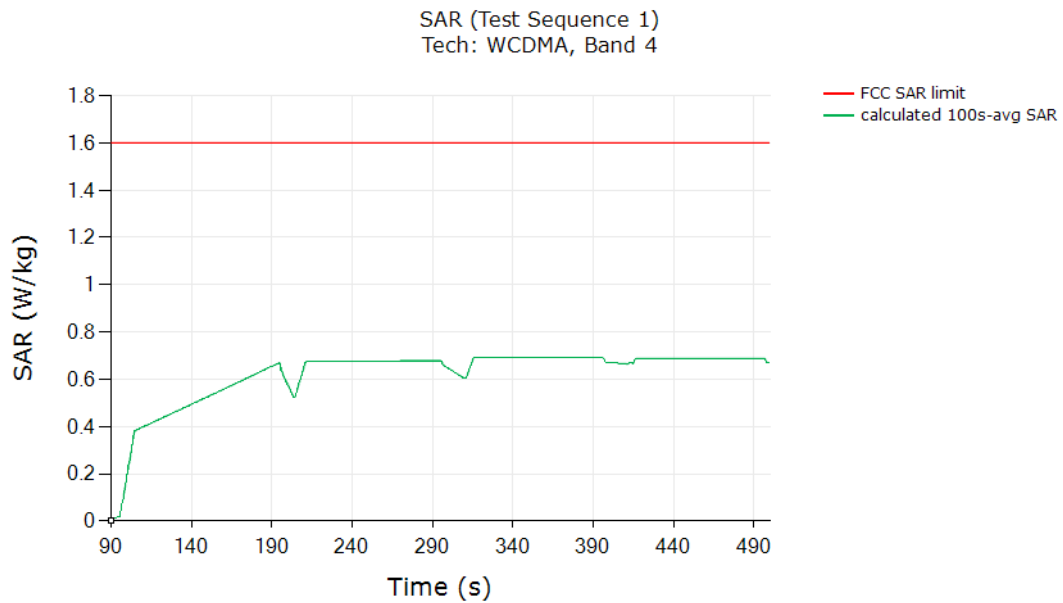

	(W/Kg)
FCC 1gSAR limit	1.6
Max 100s-time averaged 1gSAR (green curve)	0.692
Validated: Max time averaged SAR (green curve) does not exceed measured SAR at $P_{limit} + 1.2\text{dB}$ device uncertainty.	

SAR Test result for test sequence 2:

Time-averaged conducted Tx power is converted/calculated into time-averaged 1gSAR using Equation (1a) and plotted below to demonstrate that the time-averaged 1gSAR versus time does not exceed the FCC limit of 1.6 W/kg for 1gSAR:

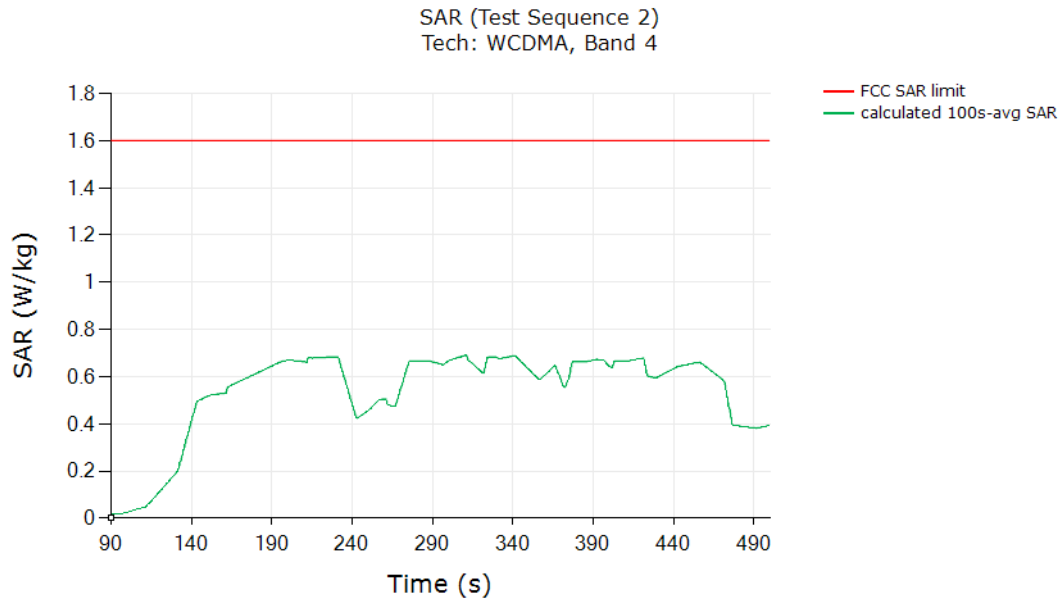

	(W/Kg)
FCC 1gSAR limit	1.6
Max 100s-time averaged 1gSAR (green curve)	0.691
<p>Validated: Max time averaged SAR (green curve) does not exceed measured SAR at $P_{limit} + 1.2\text{dB}$ device uncertainty.</p>	

9.6.5 LTE Band 74

SAR Test result for test sequence 1:

Time-averaged conducted Tx power is converted/calculated into time-averaged 1gSAR using Equation (1a) and plotted below to demonstrate that the time-averaged 1gSAR versus time does not exceed the FCC limit of 1.6 W/kg for 1gSAR:

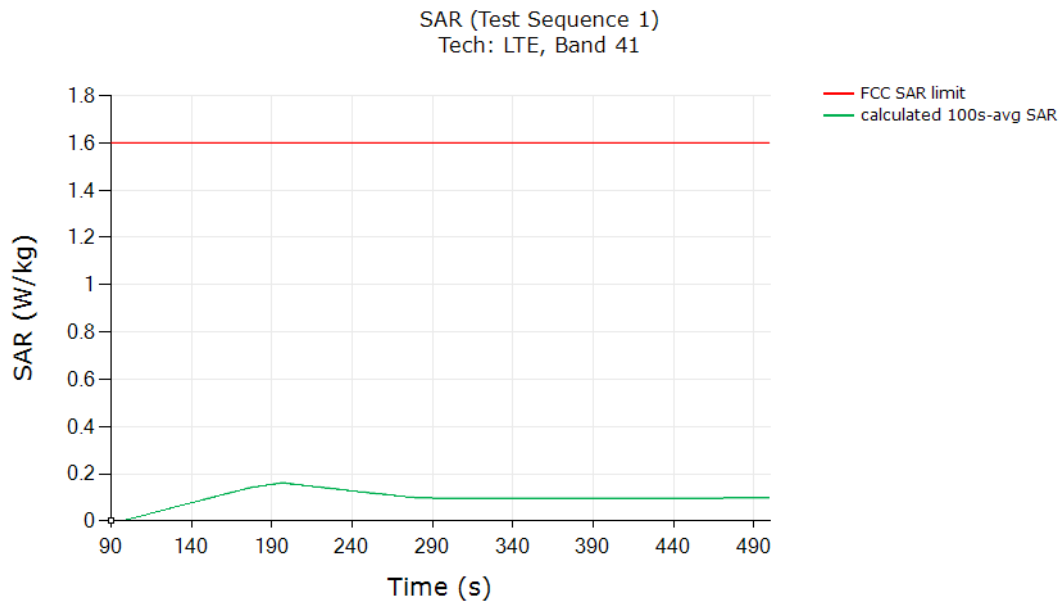

	(W/Kg)
FCC 1gSAR limit	1.6
Max 100s-time averaged 1gSAR (green curve)	0.161
<p>Validated: Max time averaged SAR (green curve) does not exceed measured SAR at $P_{limit} + 1.2\text{dB}$ device uncertainty.</p>	

SAR Test result for test sequence 2:

Time-averaged conducted Tx power is converted/calculated into time-averaged 1gSAR using Equation (1a) and plotted below to demonstrate that the time-averaged 1gSAR versus time does not exceed the FCC limit of 1.6 W/kg for 1gSAR:

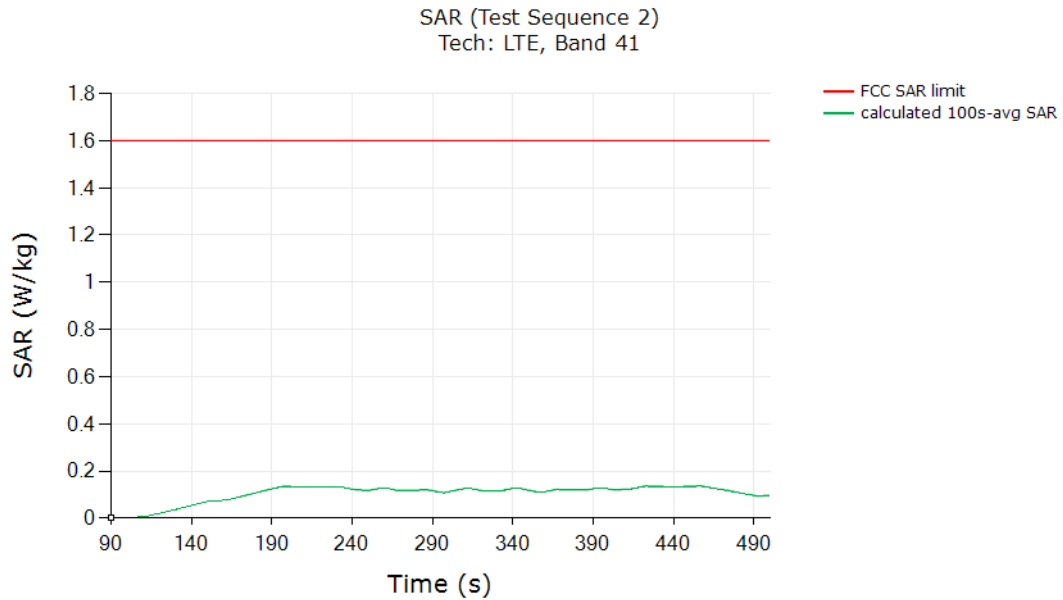

	(W/Kg)
FCC 1gSAR limit	1.6
Max 100s-time averaged 1gSAR (green curve)	0.136
<p>Validated: Max time averaged SAR (green curve) does not exceed measured SAR at $P_{limit} + 1.2\text{dB}$ device uncertainty.</p>	

9.6.6 LTE Band 66

SAR Test result for test sequence 1:

Time-averaged conducted Tx power is converted/calculated into time-averaged 1gSAR using Equation (1a) and plotted below to demonstrate that the time-averaged 1gSAR versus time does not exceed the FCC limit of 1.6 W/kg for 1gSAR:

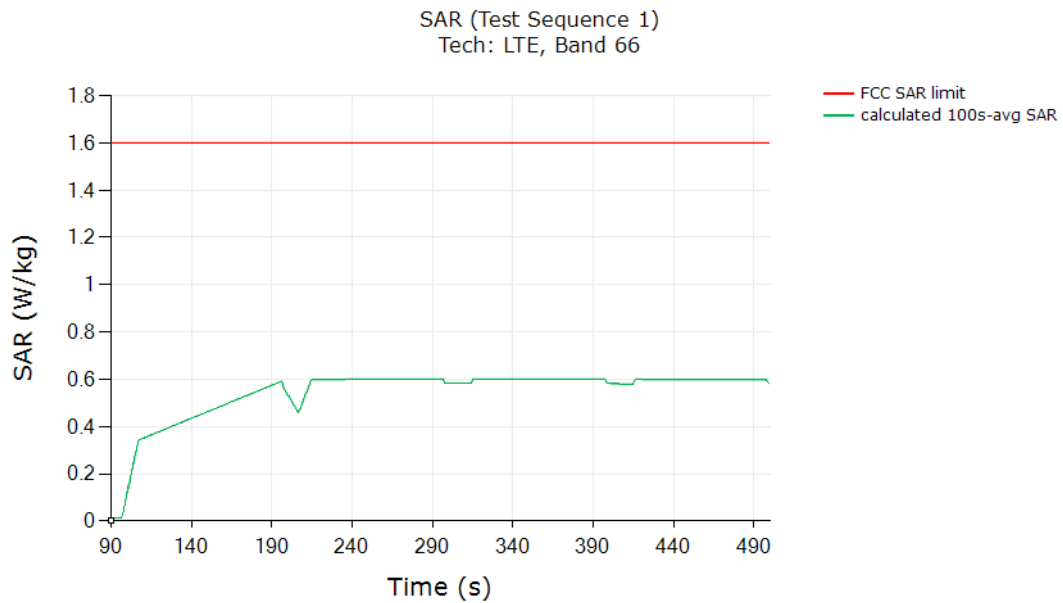

	(W/Kg)
FCC 1gSAR limit	1.6
Max 100s-time averaged 1gSAR (green curve)	0.602
Validated: Max time averaged SAR (green curve) does not exceed measured SAR at $P_{limit} + 1.2\text{dB}$ device uncertainty.	

SAR Test result for test sequence 2:

Time-averaged conducted Tx power is converted/calculated into time-averaged 1gSAR using Equation (1a) and plotted below to demonstrate that the time-averaged 1gSAR versus time does not exceed the FCC limit of 1.6 W/kg for 1gSAR:

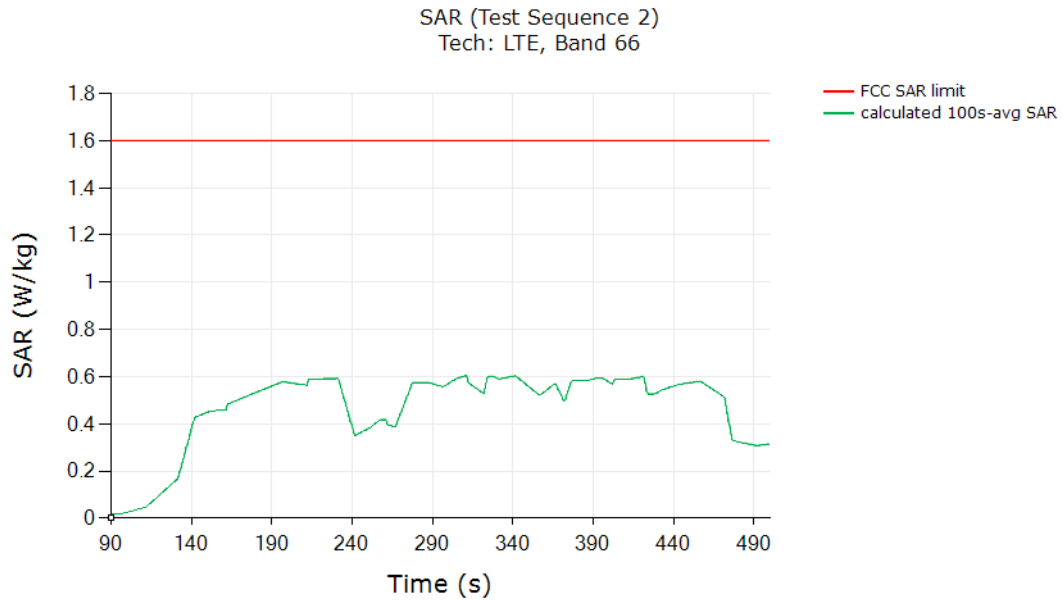

	(W/Kg)
FCC 1gSAR limit	1.6
Max 100s-time averaged 1gSAR (green curve)	0.604
<p>Validated: Max time averaged SAR (green curve) does not exceed measured SAR at $P_{limit} + 1.2\text{dB}$ device uncertainty.</p>	

9.6.7 NR n12 SA

SAR Test result for test sequence 1:

Time-averaged conducted Tx power is converted/calculated into time-averaged 1gSAR using Equation (1a) and plotted below to demonstrate that the time-averaged 1gSAR versus time does not exceed the FCC limit of 1.6 W/kg for 1gSAR:

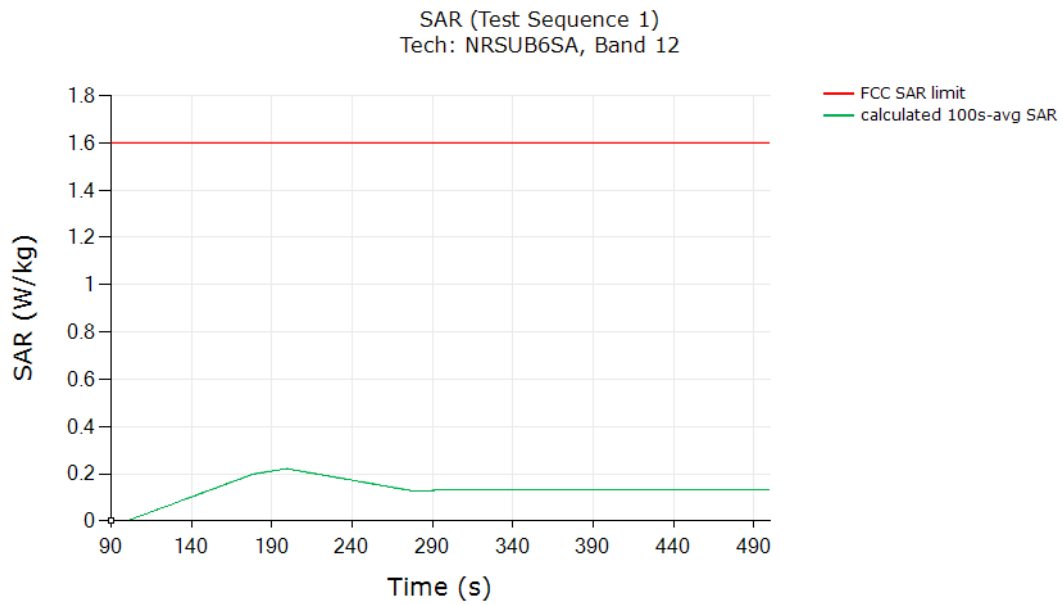

	(W/Kg)
FCC 1gSAR limit	1.6
Max 100s-time averaged 1gSAR (green curve)	0.221
Validated: Max time averaged SAR (green curve) does not exceed measured SAR at $P_{limit} + 1.2\text{dB}$ device uncertainty.	

SAR Test result for test sequence 2:

Time-averaged conducted Tx power is converted/calculated into time-averaged 1gSAR using Equation (1a) and plotted below to demonstrate that the time-averaged 1gSAR versus time does not exceed the FCC limit of 1.6 W/kg for 1gSAR:

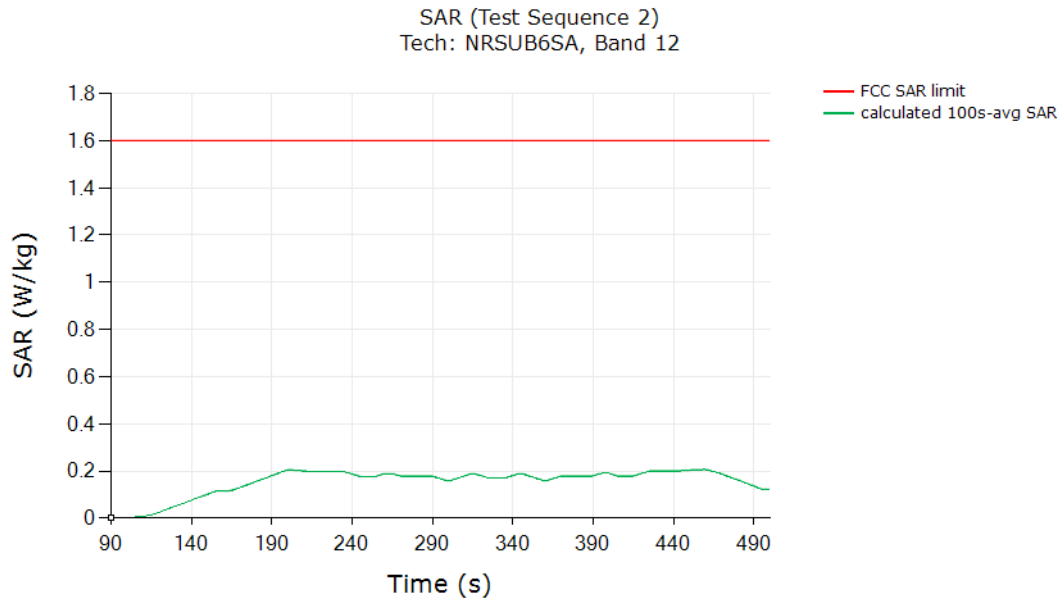

	(W/Kg)
FCC 1gSAR limit	1.6
Max 100s-time averaged 1gSAR (green curve)	0.206
<p>Validated: Max time averaged SAR (green curve) does not exceed measured SAR at $P_{limit} + 1.2\text{dB}$ device uncertainty.</p>	

9.6.8 NR n66 SA

SAR Test result for test sequence 1:

Time-averaged conducted Tx power is converted/calculated into time-averaged 1gSAR using Equation (1a) and plotted below to demonstrate that the time-averaged 1gSAR versus time does not exceed the FCC limit of 1.6 W/kg for 1gSAR:

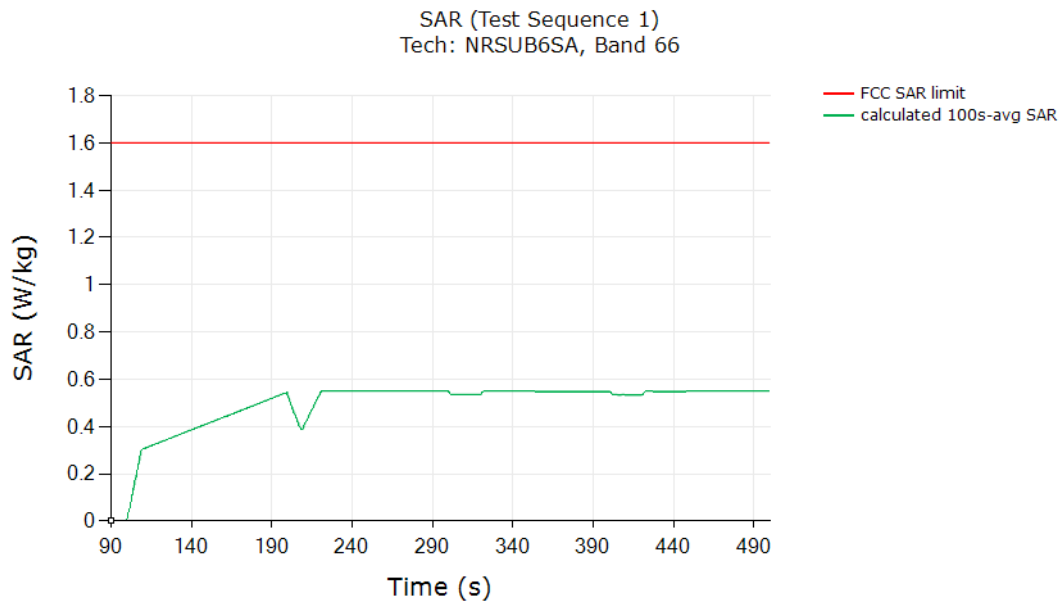

	(W/Kg)
FCC 1gSAR limit	1.6
Max 100s-time averaged 1gSAR (green curve)	0.549
Validated: Max time averaged SAR (green curve) does not exceed measured SAR at $P_{limit} + 1.2\text{dB}$ device uncertainty.	

SAR Test result for test sequence 2:

Time-averaged conducted Tx power is converted/calculated into time-averaged 1gSAR using Equation (1a) and plotted below to demonstrate that the time-averaged 1gSAR versus time does not exceed the FCC limit of 1.6 W/kg for 1gSAR:

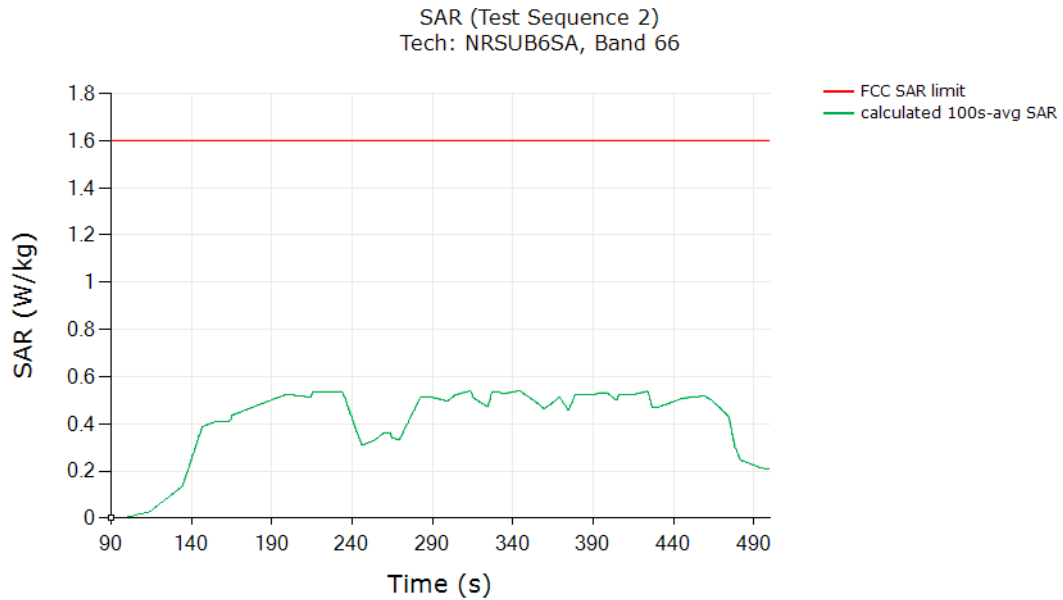

	(W/Kg)
FCC 1gSAR limit	1.6
Max 100s-time averaged 1gSAR (green curve)	0.539
Validated: Max time averaged SAR (green curve) does not exceed measured SAR at $P_{limit} + 1.2\text{dB}$ device uncertainty.	

10 TEST EQUIPMENTS LIST

Description	Manufacturer	Model	Serial No./Version	Cal. Date	Cal. Due
PC	Dell	N/A	N/A	N/A	N/A
Test Software	Speag	DASY8	16.2.2.1588	N/A	N/A
750MHz Validation Dipole	Speag	D750V3	SN: 1208	2024/08/19	2027/08/18
835MHz Validation Dipole	Speag	D835V2	SN: 4d187	2024/05/08	2027/05/07
1750MHz Validation Dipole	Speag	D1750V2	SN: 1130	2024/05/08	2027/05/07
1950MHz Validation Dipole	Speag	D1950V3	SN: 1240	2024/08/22	2027/08/21
2600MHz Validation Dipole	Speag	D2600V2	SN: 1095	2024/05/08	2027/05/07
Data Acquisition Electronics	Speag	DAE4	SN: 1710	2025/01/20	2026/01/19
E-Field Probe	Speag	EX3DV4	SN: 7510	2024/06/25	2025/06/24
Signal Generator	Keysight	N5173B	MY62150163	2024/08/12	2025/08/11
Power Meter	R&S	NRVD-B2	835843/014	2024/08/08	2025/08/07
Power Sensor	R&S	NRV-Z4	100381	2024/08/08	2025/08/07
Power Sensor	R&S	NRV-Z2	100211	2024/08/08	2025/08/07
Power Sensor	R&S	NRP8S	112091	2024/08/12	2025/08/11
Power Sensor	R&S	NRP8S	112092	2024/08/12	2025/08/11
Wireless Communication Test Set	R&S	CMW500	104946	2024/06/24	2025/06/23
UXM 5G Wireless Test Platform	Keysight	E7515B	MY59321617	2024/08/12	2025/08/11
Network Analyzer	Agilent	E5071C	MY46103472	2024/09/11	2025/09/10
Thermometer	Elitech	RC-4HC	EF7239002655	2024/10/31	2025/10/30
Thermometer	Elitech	RC-4HC	EF7216002974	2024/10/31	2025/10/30
Power Amplifier	Mini-Circuits	ZVA-183W-S+	932502132	N/A	N/A
Dielectric Probe Kit	Speag	DAK3.5	SN: 1312	N/A	N/A
Phantom	Speag	ELI V8.0	SN: 2159	N/A	N/A
Attenuator	COM-MW	ZA-S1-31	1305003187	N/A	N/A
Directional coupler	AA-MCS	AAMCS-UDC	000272	N/A	N/A
Directional coupler	N/A	SHX-DC0.5/8-10S	22041501	N/A	N/A
Directional coupler	N/A	SHX-DC0.5/8-10S	22041502	N/A	N/A

Note: For dipole antennas, BALUN has adopted 3 years as calibration intervals, and on annual basis, every measurement dipole has been evaluated and is in compliance with the following criteria:

1. There is no physical damage on the dipole;
2. System validation with specific dipole is within 10% of calibrated value;
3. Return-loss in within 20% of calibrated measurement.
4. Impedance (real or imaginary parts) in within 5 Ohms of calibrated measurement.

11 CONCLUSIONS

Qualcomm Smart Transmit feature employed has been validated through the conducted and radiated power measurement, as well as SAR measurement.

As demonstrated in this report, the power limiting enforcement is effective and the total normalized time-averaged RF exposure does not exceed 1.0 for all the transmission scenarios described in Section 5.

Therefore, the EUT complies with FCC RF exposure requirement.

ANNEX A TEST SEQUENCES

1. Test sequence is generated based on below parameters of the EUT:
 - a) Measured maximum power (P_{max})
 - b) Measured Tx_power_at_SAR_design_target (P_{limit})
 - c) Reserve_power_margin (dB)
 - d) $P_{reserve}$ (dBm) = measured P_{limit} (dBm) – Reserve_power_margin (dB)
 - e) SAR_time_window (100s for FCC)

2. Test Sequence 1 Waveform:

Based on the parameters above, Test Sequence 1 is generated with one transition between high and low transmission powers. Here, high power = P_{max} ; low power = $P_{max}/2$, and the transition occurs after 80 seconds at high power (P_{max}). If the power enforcement is taking into effective during one 100 seconds/60 seconds time window, the validation test with this defined Test Sequence 1 is valid; otherwise, select other radio configurations (band/DSI within the same technology group) having lower P_{limit} for this test. The Test Sequence 1 waveform is shown below:

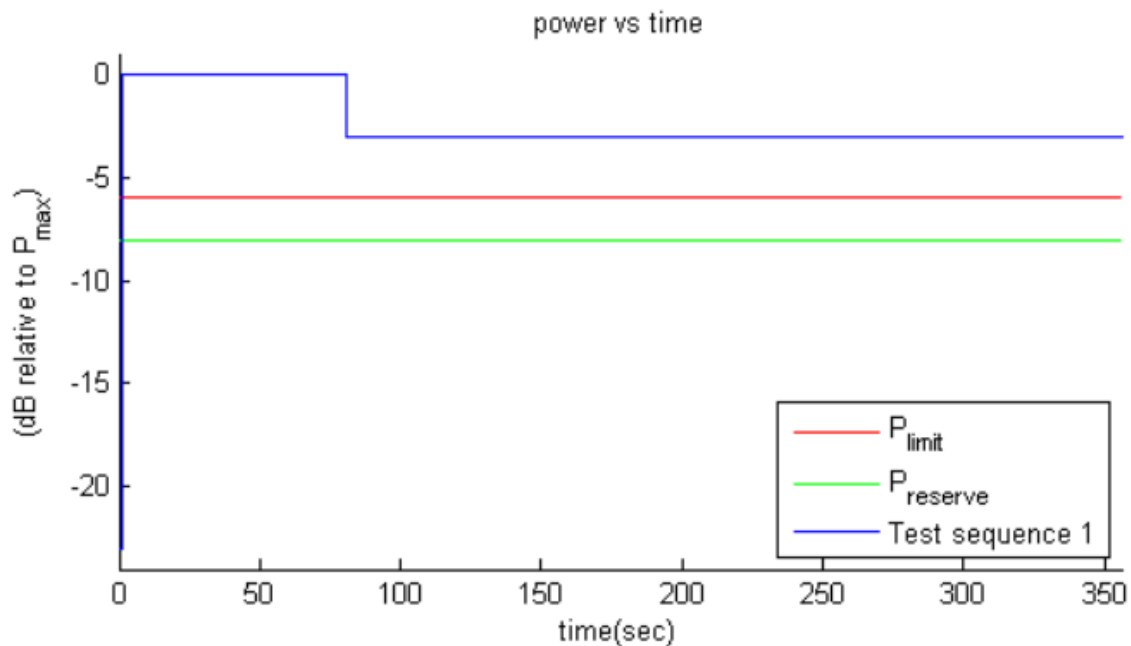

Figure A-1 Test Sequence1 Waveform

3. Test Sequence 2 Waveform:

Based on the parameters in A-1, the Test Sequence 2 is generated as described in Table A-1 and pictured in Figure A-2, which contains two 170 seconds-long sequences (yellow and green highlighted rows) that are mirrored around the center row of 20 seconds, resulting in a total duration of 360 seconds:

Table A-1 Test Sequence 2

Time duration (seconds)	dB relative to P_{limit} or $P_{reserve}$
15	$P_{reserve} - 2$
20	P_{limit}
20	$(P_{limit} + P_{max})/2$ averaged in mW and rounded to nearest 0.1 dB step
10	$P_{reserve} - 6$
20	P_{max}
15	P_{limit}
15	$P_{reserve} - 5$
20	P_{max}
10	$P_{reserve} - 3$
15	P_{limit}
10	$P_{reserve} - 4$
20	$(P_{limit} + P_{max})/2$ averaged in mW and rounded to nearest 0.1 dB step
10	$P_{reserve} - 4$
15	P_{limit}
10	$P_{reserve} - 3$
20	P_{max}
15	$P_{reserve} - 5$
15	P_{limit}
20	P_{max}
10	$P_{reserve} - 6$
20	$(P_{limit} + P_{max})/2$ averaged in mW and rounded to nearest 0.1 dB step
20	P_{limit}
15	$P_{reserve} - 2$

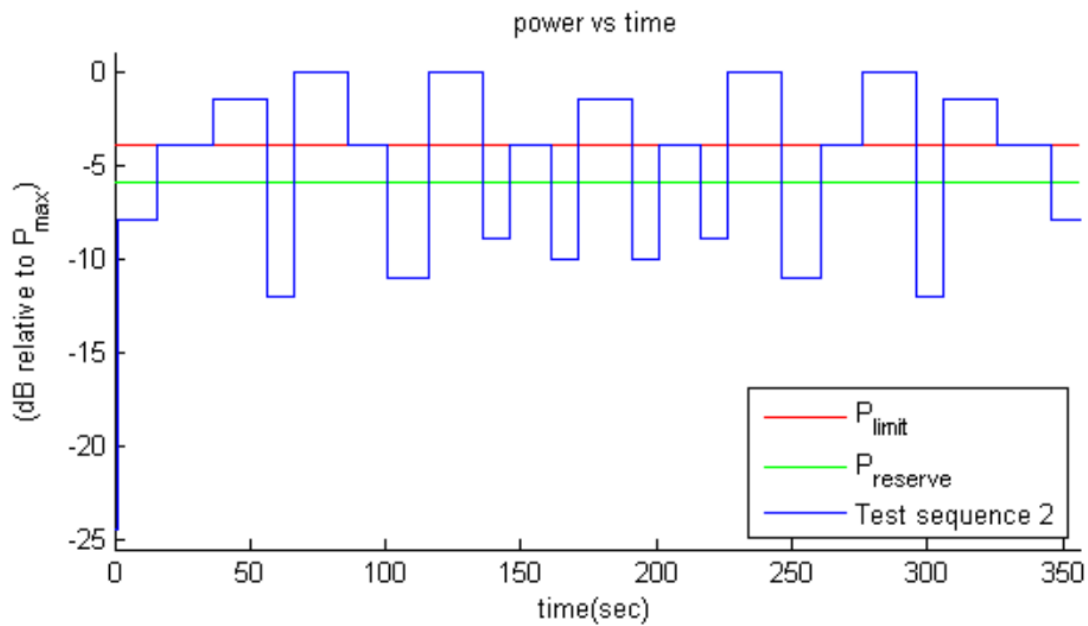

Figure A-2 Test Sequence2 Waveform

ANNEX B TEST PROCEDURES for SUB-6 GHz NR + LTE RADIO

This Annex B provides the test procedures for validating Qualcomm Smart Transmit feature for LTE + Sub-6 GHz NR non-standalone (NSA) mode transmission scenario, where sub-6GHz LTE link acts as an anchor.

B.1 Time-varying Transmission Power Test for Sub-6 GHz NR in NSA Mode

Follows Section 6.2.1 to select test configurations for time-varying test. This test is performed with two pre-defined test sequences (described in Section 6.1) applied to 5G NR (with LTE on all-down bits or low power for the entire test after establishing the LTE+ Sub-6 GHz NR call with the callbox). Follow the test procedures described in Section 6.3.1 to demonstrate the effectiveness of power limiting enforcement and that the time averaged Tx power of Sub-6 GHz NR when converted into 1gSAR values does not exceed the regulatory limit at all times (see Eq. (1a) and (1b)). Sub-6 GHz NR response to test sequence1 and test sequence2 will be similar to other technologies (say, LTE), and are shown in Section 6.3.7 and 6.3.8.

B.2 Switch in SAR Exposure Between LTE vs. Sub-6 GHz NR During Transmission

This test is to demonstrate that Smart Transmit feature accurately accounts for switching in exposures among SAR for LTE radio only, SAR from both LTE radio and Sub-6 GHz NR, and SAR from Sub-6 GHz NR only scenarios, and ensures total time-averaged RF exposure compliance with FCC limit.

Test Procedure

1. Measure conducted Tx power corresponding to P_{limit} for LTE and Sub-6 GHz NR in selected band. Test condition to measure conducted P_{limit} is:
 - Establish device in call with the callbox for LTE in desired band. Measure conducted Tx power corresponding to LTE P_{limit} with Smart Transmit enabled and Reserve_power_margin set to 0 dB, callbox set to request maximum power.
 - Repeat above step to measure conducted Tx power corresponding to Sub-6 GHz NR P_{limit} . If testing LTE+ Sub-6 GHz NR in non-standalone mode, then establish LTE+ Sub-6 GHz NR call with callbox and request all down bits for radio1 LTE. In this scenario, with callbox requesting maximum power from 5G NR, measured conducted Tx power corresponds to radio2 P_{limit} (as radio1 LTE is at all-down bits).
2. Set Reserve_power_margin to actual (intended) value with EUT setup for LTE + Sub-6 GHz NR call. First, establish LTE connection in all-up bits with the callbox, and then Sub-6 GHz NR connection is added with callbox requesting UE to transmit at maximum power in Sub-6 GHz NR. As soon as the Sub-6 GHz NR connection is established, request all-down bits on LTE link (otherwise, Sub-6 GHz NR will not have sufficient RF exposure margin to sustain the call with LTE in all-up bits). Continue LTE (all-down bits) + Sub-6 GHz NR transmission for more than one time-window duration to test predominantly Sub-6 GHz NR SAR exposure scenario (as SAR exposure is negligible from all-down bits in LTE). After at least one time-window, request LTE to go all-up bits to test LTE SAR and Sub-6 GHz NR SAR exposure scenario. After at least one more time-window, drop (or request all-down bits) Sub-6 GHz NR transmission to test predominantly LTE SAR exposure scenario. Continue the test for at least one more time-

window. Record the conducted Tx powers for both LTE and Sub-6 GHz NR for the entire duration of this test.

3. Once the measurement is done, extract instantaneous Tx power versus time for both LTE and Sub-6 GHz NR links. Similar to technology/band switch test in Section 6.3.3, convert the conducted Tx power for both these radios into 1gSAR value (see Eq. (6a) and (6b)) using corresponding technology/band P_{limit} measured in Step 1, and then perform 100s running average to determine time-averaged 1gSAR versus time as illustrated in Figure 3-1.
4. Make one plot containing: (a) instantaneous Tx power versus time measured in Step 2.
5. Make another plot containing: (a) instantaneous 1gSAR versus time determined in Step 3, (b) computed time-averaged 1gSAR versus time determined in Step 3, and (c) corresponding regulatory 1gSARlimit of 1.6W/kg.

The validation criteria is, at all times, the time-averaged 1gSAR versus time shall not exceed the regulatory 1gSARlimit of 1.6W/kg

ANNEX C DASY 8 SYSTEM VERIFICATION

C.1 DASY8 SAR Test System Diagram

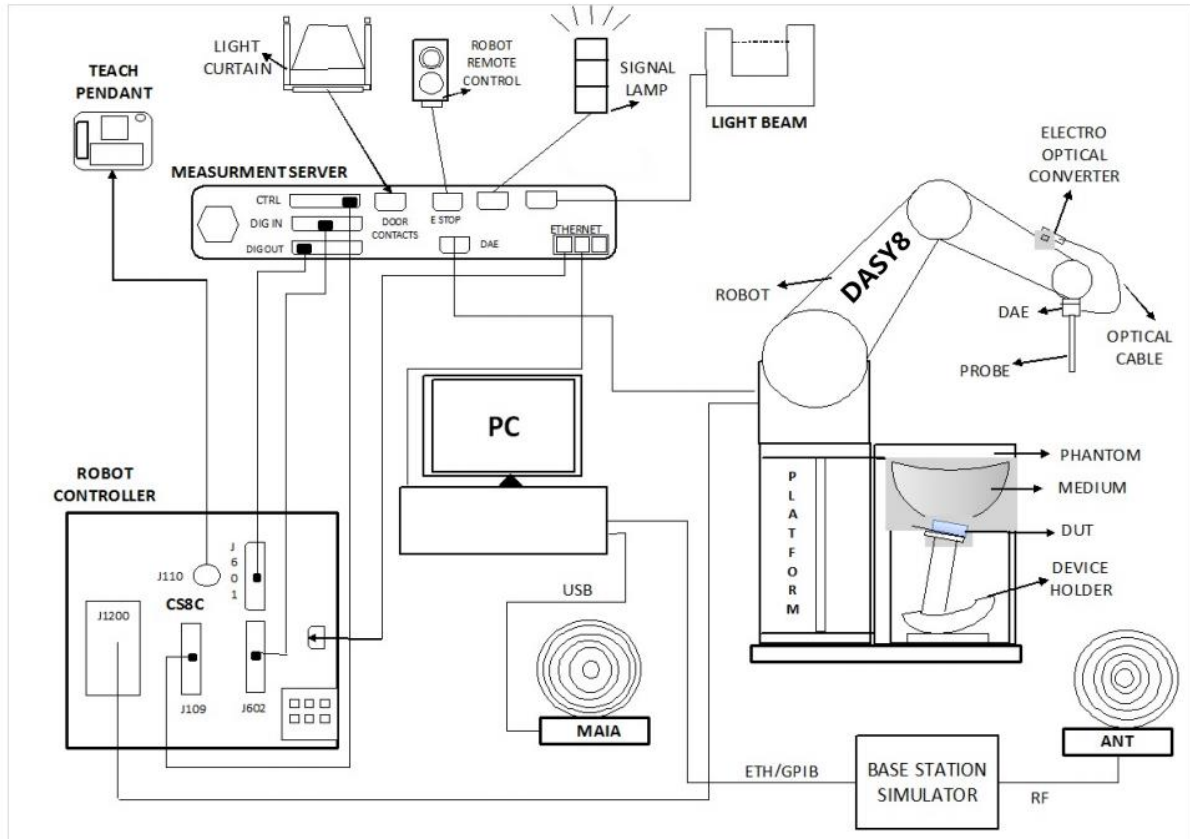

C.2 Simulating Liquid Verification Result

The dielectric parameters of the liquids were verified prior to the SAR evaluation using an SCLMP Dielectric Probe Kit.

Date	Liquid Type	Fre. (MHz)	Temp. (°C)	Meas. Conductivity (σ) (S/m)	Meas. Permittivity (ϵ)	Target Conductivity (σ) (S/m)	Target Permittivity (ϵ)	Conductivity Tolerance (%)	Permittivity Tolerance (%)
2025.05.16	Head	750	21.3	0.90	41.85	0.89	41.94	1.12	-0.21
2025.05.16	Head	835	21.3	0.90	41.84	0.90	41.50	0.00	0.82
2025.05.17	Head	1750	21.4	1.38	40.09	1.37	40.08	0.73	0.03
2025.05.18	Head	1950	21.5	1.42	39.06	1.40	40.00	1.43	-2.35
2025.05.18	Head	2600	21.5	1.97	38.60	1.96	39.01	0.51	-1.05

Note: The tolerance limit of Conductivity and Permittivity is $\pm 5\%$.

C.3 System Check Result

Comparing to the original SAR value provided by SPEAG, the validation data should be within its specification of 10 % (for 1 g).

Date	Liquid Type	Freq. (MHz)	Power (mW)	Measured SAR (W/kg)	Normalized SAR (W/kg)	Dipole SAR (W/kg)	Tolerance (%)
2025.05.16	Head	750	100	0.866	8.66	8.46	2.36
2025.05.16	Head	835	100	1.010	10.10	9.74	3.70
2025.05.17	Head	1750	100	3.640	36.40	37.00	-1.62
2025.05.18	Head	1950	100	4.220	42.20	41.70	1.20
2025.05.18	Head	2600	100	5.740	57.40	55.90	2.68

Note: The tolerance limit of System validation $\pm 10\%$.

System Performance Check Data (750MHz Head)

Exposure Conditions

Phantom Section, TSL	Position, Test Distance [mm]	Band	Group, UID	Frequency [MHz], Channel Number	Conversion Factor	TSL Conductivity [S/m]	TSL Permittivity	Ambient Temperature [°C]	Liquid Temperature [°C]
Flat, HSL		CD835	CW, 0--	750.0, 100	10.29	0.902	41.9	22.5	21.3

Hardware Setup

Phantom	TSL, Measured Date	Probe, Calibration Date	DAE, Calibration Date
Twin-SAM V5.0 (30deg probe tilt) - 2159	HBBL-600-10000 2025-05-16	EX3DV4 - SN7510, 2024-06-25	DAE4 Sn1710, 2025-01-20

Scan Setup

	Area Scan	Zoom Scan
Grid Extents [mm]	80.0 x 160.0	30.0 x 30.0 x 30.0
Grid Steps [mm]	10.0 x 10.0	6.0 x 6.0 x 1.5
Sensor Surface [mm]	3.0	1.4
Graded Grid	Yes	Yes
Grading Ratio	1.5	1.5
MAIA	N/A	N/A
Surface	VMS + 6p	VMS + 6p
Detection		
Scan Method	Measured	Measured

Measurement Results

	Area Scan	Zoom Scan
Date	2025-05-16	2025-05-16
psSAR1g [W/kg]	0.845	0.866
psSAR10g [W/kg]	0.556	0.568
Power Drift [dB]	-0.01	-0.02
Power Scaling	Disabled	Disabled
Scaling Factor [dB]		
TSL Correction	No correction	No correction
M2/M1 [%]		85.3
Dist 3dB Peak [mm]		20.2

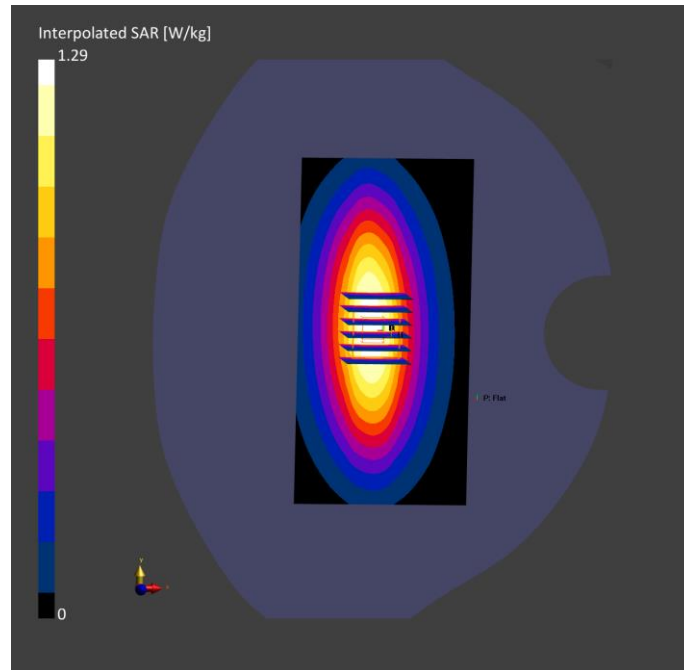

System Performance Check Data (835MHz Head)

Exposure Conditions

Phantom Section, TSL	Position, Test Distance [mm]	Band	Group, UID	Frequency [MHz], Channel Number	Conversion Factor	TSL Conductivity [S/m]	TSL Permittivity	Ambient Temperature [°C]	Liquid Temperature [°C]
Flat, HSL		CD835	CW, 0--	835.0, 50	9.99	0.903	41.8	22.5	21.3

Hardware Setup

Phantom	TSL, Measured Date	Probe, Calibration Date	DAE, Calibration Date
Twin-SAM V5.0 (30deg probe tilt) - 2159	HBBL-600-10000 2025-05-16	EX3DV4 - SN7510, 2024-06-25	DAE4 Sn1710, 2025-01-20

Scan Setup

	Area Scan	Zoom Scan
Grid Extents [mm]	80.0 x 160.0	30.0 x 30.0 x 30.0
Grid Steps [mm]	10.0 x 10.0	6.0 x 6.0 x 1.5
Sensor Surface [mm]	3.0	1.4
Graded Grid	Yes	Yes
Grading Ratio	1.5	1.5
MAIA	N/A	N/A
Surface	VMS + 6p	VMS + 6p
Detection		
Scan Method	Measured	Measured

Measurement Results

	Area Scan	Zoom Scan
Date	2025-05-16	2025-05-16
psSAR1g [W/kg]	0.984	1.01
psSAR10g [W/kg]	0.642	0.668
Power Drift [dB]	0.02	0.02
Power Scaling	Disabled	Disabled
Scaling Factor [dB]		
TSL Correction	No correction	No correction
M2/M1 [%]		81.7
Dist 3dB Peak [mm]		12.1

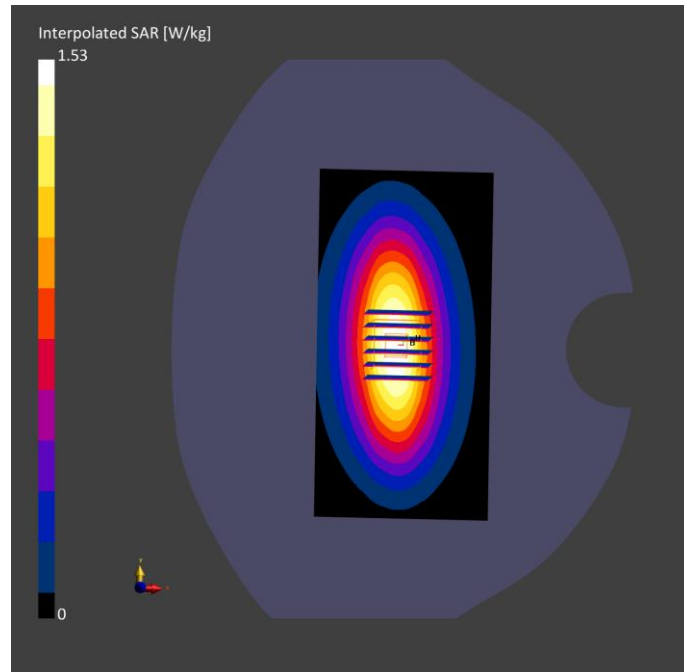

System Performance Check Data (1750MHz Head)

Exposure Conditions

Phantom Section, TSL	Position, Test Distance [mm]	Band	Group, UID	Frequency [MHz], Channel Number	Conversion Factor	TSL Conductivity [S/m]	TSL Permittivity	Ambient Temperature [°C]	Liquid Temperature [°C]
Flat, HSL		D1750	CW, 0--	1750.0, 50	8.67	1.38	40.1	22.6	21.4

Hardware Setup

Phantom	TSL, Measured Date	Probe, Calibration Date	DAE, Calibration Date
Twin-SAM V5.0 (30deg probe tilt) - 2159	HBBL-600-10000 2025-05-17	EX3DV4 - SN7510, 2024-06-25	DAE4 Sn1710, 2025-01-20

Scan Setup

Measurement Results

	Area Scan	Zoom Scan		Area Scan	Zoom Scan
Grid Extents [mm]	80.0 x 80.0	30.0 x 30.0 x 30.0	Date	2025-05-17	2025-05-17
Grid Steps [mm]	10.0 x 10.0	6.0 x 6.0 x 1.5	psSAR1g [W/kg]	3.32	3.64
Sensor Surface [mm]	3.0	1.4	psSAR10g [W/kg]	1.75	1.96
Graded Grid	Yes	Yes	Power Drift [dB]	0.03	0.08
Grading Ratio	1.5	1.5	Power Scaling	Disabled	Disabled
MAIA	N/A	N/A	Scaling Factor [dB]		
Surface Detection	VMS + 6p	VMS + 6p	TSL Correction	No correction	No correction
Scan Method	Measured	Measured	M2/M1 [%]		82.6
			Dist 3dB Peak [mm]		9.6

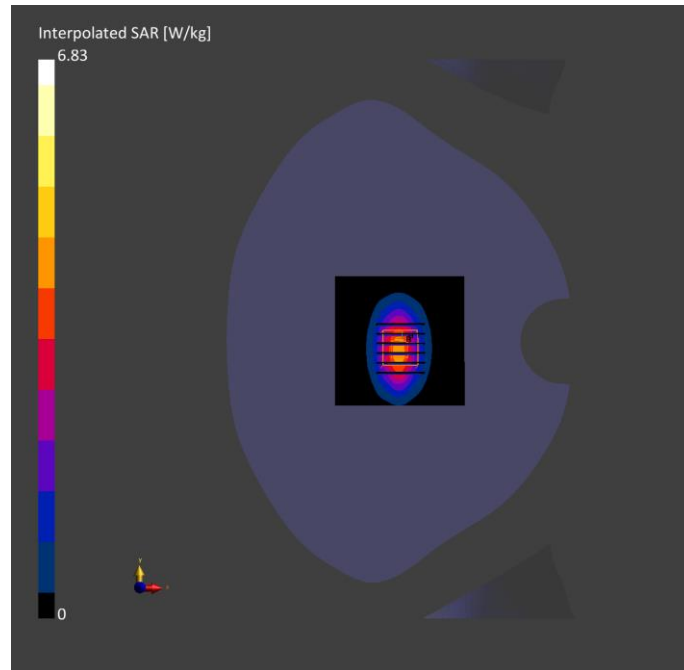

System Performance Check Data (1950MHz Head)

Exposure Conditions

Phantom Section, TSL	Position, Test Distance [mm]	Band	Group, UID	Frequency [MHz], Channel Number	Conversion Factor	TSL Conductivity [S/m]	TSL Permittivity	Ambient Temperature [°C]	Liquid Temperature [°C]
Flat, HSL		CD1950	CW, 0--	1950.0, 50	8.33	1.42	39.1	22.7	21.5

Hardware Setup

Phantom	TSL, Measured Date	Probe, Calibration Date	DAE, Calibration Date
Twin-SAM V5.0 (30deg probe tilt) - 2159	HBBL-600-10000 2025-05-18	EX3DV4 - SN7510, 2024-06-25	DAE4 Sn1710, 2025-01-20

Scan Setup

Measurement Results

	Area Scan	Zoom Scan		Area Scan	Zoom Scan
Grid Extents [mm]	80.0 x 80.0	30.0 x 30.0 x 30.0	Date	2025-05-18	2025-05-18
Grid Steps [mm]	10.0 x 10.0	5.0 x 5.0 x 1.5	psSAR1g [W/kg]	3.98	4.22
Sensor Surface [mm]	3.0	1.4	psSAR10g [W/kg]	1.98	2.18
Graded Grid	Yes	Yes	Power Drift [dB]	0.02	0.03
Grading Ratio	1.5	1.5	Power Scaling	Disabled	Disabled
MAIA	N/A	N/A	Scaling Factor [dB]		
Surface	VMS + 6p	VMS + 6p	TSL Correction	No correction	No correction
Detection			M2/M1 [%]		81.4
Scan Method	Measured	Measured	Dist 3dB Peak [mm]		9.6

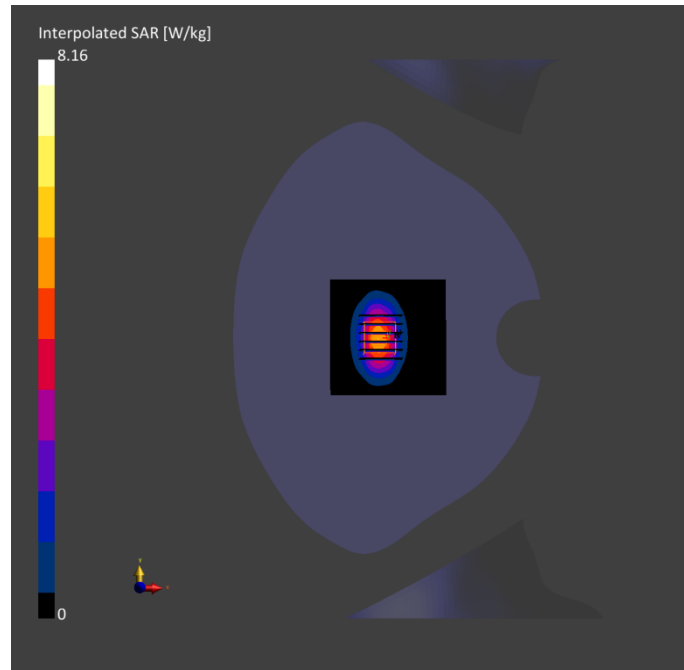

System Performance Check Data (2600MHz Head)

Exposure Conditions

Phantom Section, TSL	Position, Test Distance [mm]	Band	Group, UID	Frequency [MHz], Channel Number	Conversion Factor	TSL Conductivity [S/m]	TSL Permittivity	Ambient Temperature [°C]	Liquid Temperature [°C]
Flat, HSL		D2600	CW, 0--	2600.0, 50	7.59	1.97	38.6	22.7	21.5

Hardware Setup

Phantom	TSL, Measured Date	Probe, Calibration Date	DAE, Calibration Date
Twin-SAM V5.0 (30deg probe tilt) - 2159	HBBL-600-10000 2025-05-18	EX3DV4 - SN7510, 2024-06-25	DAE4 Sn1710, 2025-01-20

Scan Setup

Measurement Results

	Area Scan	Zoom Scan		Area Scan	Zoom Scan
Grid Extents [mm]	80.0 x 80.0	30.0 x 30.0 x 30.0	Date	2025-05-18	2025-05-18
Grid Steps [mm]	10.0 x 10.0	5.0 x 5.0 x 1.5	psSAR1g [W/kg]	5.71	5.74
Sensor Surface [mm]	3.0	1.4	psSAR10g [W/kg]	2.60	2.58
Graded Grid	Yes	Yes	Power Drift [dB]	0.00	-0.01
Grading Ratio	1.5	1.5	Power Scaling	Disabled	Disabled
MAIA	N/A	N/A	Scaling Factor [dB]		
Surface Detection	VMS + 6p	VMS + 6p	TSL Correction	No correction	No correction
Scan Method	Measured	Measured	M2/M1 [%]		80.1
			Dist 3dB Peak [mm]		9.2

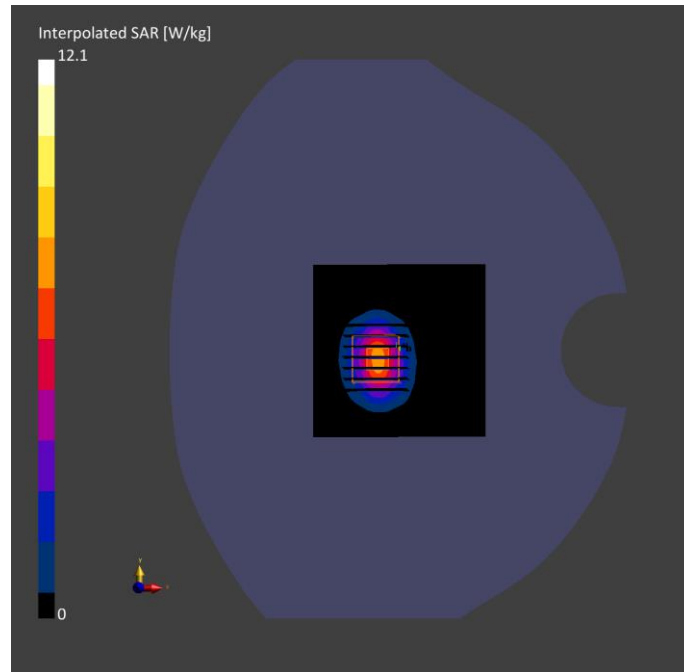

ANNEX D Calibration Report

Please refer the document “BL-SZ2530966-AC-1.pdf”

ANNEX E TEST SETUP PHOTOS

Please refer the document “BL-SZ2530966-AS-1.pdf”.

Statement

1. The laboratory guarantees the scientificity, accuracy and impartiality of the test, and is responsible for all the information in the report, except the information provided by the customer. The customer is responsible for the impact of the information provided on the validity of the results.
2. The report without China inspection body and laboratory Mandatory Approval (CMA) mark has no effect of proving to the society.
3. For the report with CNAS mark or A2LA mark, the items marked with "☆" are not within the accredited scope.
4. This report is invalid if it is altered, without the signature of the testing and approval personnel, or without the "inspection and testing dedicated stamp" or test report stamp.
5. The test data and results are only valid for the tested samples provided by the customer.
6. This report shall not be partially reproduced without the written permission of the laboratory.
7. Any objection shall be raised to the laboratory within 30 days after receiving the report.

--END OF REPORT--