

FCC Part 15 Subpart C Transmitter Certification

Direct Sequence Spread Spectrum Transmitter

Test Report

FCC ID: R7P26-1129-01

FCC Rule Part: 15.247

ACS Report Number: 05-0384-15C-DTS

Manufacturer: Cellnet Technology, Inc.
Trade Name: InfiNet Concentrator
Model: 26-1129

Test Begin Date: October 19, 2005
Test End Date: October 24, 2005

Report Issue Date: April 26, 2006



FOR THE SCOPE OF ACCREDITATION UNDER LAB Code 200612

Prepared by: 
J. Kirby Munroe
Manager Wireless Certifications
ACS, Inc.

Reviewed by: 
R. Sam Wismer
Engineering Manager
ACS, Inc.

This test report shall not be reproduced except in full. This report may be reproduced in part with prior written consent of ACS, Inc. The results contained in this report are representative of the sample(s) submitted for evaluation.

This report contains 19 pages

Table of Contents

1.0 General	3
1.1 Purpose	3
1.2 Product Description	3
1.2.1 General	3
1.2.2 Intended Use	3
2.0 Test Facilities	4
2.1 Location	4
2.2 Laboratory Accreditations/Recognitions/Certifications	4
2.3 Radiated Emissions Test Site Description	5
2.3.1 Semi-Anechoic Chamber Test Site	5
2.3.2 Open Area Tests Site (OATS)	6
2.4 Conducted Emissions Test Site Description	7
3.0 Applicable Standards and References	7
4.0 List of Test Equipment	8
5.0 Support Equipment	8
6.0 EUT Setup Block Diagram	9
7.0 Summary of Tests	10
7.1 Section 15.203 - Antenna Requirement	10
7.2 Section 15.207 - Power Line Conducted Emissions	10
7.2.1 Test Methodology	10
7.2.2 Test Results	10
7.3 Section 15.109 - Radiated Emissions (Unintentional Radiation)	13
7.3.1 Test Methodology	13
7.3.2 Test Results	13
7.4 Section 15.247(a)(2) – 6 dB Bandwidth	14
7.4.1 Test Methodology	14
7.4.1 Test Results	14
7.5 Section 15.247(b) – Peak Output Power	15
7.5.1 Test Methodology	15
7.5.2 Test Results	15
7.6 Section 15.247(c) – Band-Edge Compliance and Spurious Emissions	16
7.6.1 Section 15.247 (c) – Band-Edge Compliance	16
7.6.1.1 Test Methodology	16
7.6.1.2 Test Results	16
7.6.2 Section 15.247(c) – Conducted Spurious Emissions	17
7.6.2.1 Test Methodology	17
7.6.2.2 Test Results	17
7.6.3 Section 15.247(c) – Radiated Spurious Emissions	18
7.6.3.1 Test Methodology	18
7.6.3.2 Duty Cycle Correction	18
7.6.3.3 Test Results	18
7.6.3.4 Sample Calculation	18
7.7 Section 15.247(d) – Power Spectral Density	19
7.7.1 Test Methodology	19
7.7.2 Test Results	19
9.0 CONCLUSION	19

1.0 GENERAL

1.1 Purpose

The purpose of this report is to demonstrate compliance with Part 15, Subpart C of the FCC's Code of Federal Regulations.

1.2 Product Description

1.2.1 General

The InfiNet Concentrator is a device that is part of a Mesh network. Its function is to receive data from Utility meters and relay that information to the mesh network. The InfiNet Concentrator also acts as a repeater within this mesh network. It relays data it receives from its WAN radio to other InfiNet Concentrators. The InfiNet Concentrator consists of several devices. One is the LAN radio, or BLT, that receives data from utility meters. The next device, the Integrated Wangate Radio (IWR), is the WAN radio that communicates over the WAN or mesh network. It also contains a power supply and a microprocessor board which processes data and controls the unit.

The overall system is considered a composite device by definition of the FCC. It contains the Integrated Wangate Radio (IWR) radio which uses Frequency Hopping Spread Spectrum modulation techniques operating in the 902-928MHz ISM frequency band. The second radio, the BLT, uses Direct Sequence Spread Spectrum modulation techniques and also operates in the 902-928MHz ISM frequency band. The radios will never operate simultaneously.

This test report is specific to the BLT radio portion only. A separate test report 05-0384-15C-DSS will be issued for the Integrated Wangate Radio (IWR) radio section contained within this device.

1.2.2 Intended Use

The InfiNet Concentrator is a device that is part of a Mesh network. Its function is to receive data from Utility meters and relay that information to the mesh network. The InfiNet Concentrator also acts as a repeater within this mesh network.

2.0 TEST FACILITIES

2.1 Location

The radiated and conducted emissions test sites are located at the following address:

Advanced Compliance Solutions
5015 B.U. Bowman Drive
Buford, GA 30518
Phone: (770) 831-8048
Fax: (770) 831-8598

2.2 Laboratory Accreditations/Recognitions/Certifications

The Semi-Anechoic Chamber Test Site, Open Area Test Site (OATS) and Conducted Emissions Site have been fully described, submitted to, and accepted by the FCC, Industry Canada and the Japanese Voluntary Control Council for Interference by information technology equipment. In addition, ACS is compliant to ISO 17025 as certified by the National Institute of Standards and Technology under their National Voluntary Laboratory Accreditation Program. The following certification numbers have been issued in recognition of these accreditations and certifications:

FCC Registration Number: 89450

Industry Canada Lab Code: IC 4175

VCCI Member Number: 1831

- VCCI OATS Registration Number R-1526
- VCCI Conducted Emissions Site Registration Number: C-1608

NVLAP Lab Code: 200612

2.3 Radiated Emissions Test Site Description

2.3.1 Semi-Anechoic Chamber Test Site

The Semi-Anechoic Chamber Test Site consists of a 20' x 30' x 18' shielded enclosure. The chamber is lined with Toyo Ferrite Grid Absorber, model number FFG-1000. The ferrite tile grid is 101 x 101 x 19mm thick and weighs approximately 550 grams. These tiles are mounted on steel panels and installed directly on the inner walls of the chamber.

The turntable is 150cm in diameter and is located 160cm from the back wall of the chamber. The chamber is grounded via 1 - 8' copper ground rod, installed at the center of the back wall, it is bound to the ground plane using 3/4" stainless steel braided cable.

The turntable is all steel, flush mounted table installed in an all steel frame. The table is remotely operated from inside the control room located 25' from the range. The turntable is electrically bonded to the surrounding ground plane via steel fingers installed on the edge of the turn table. The steel fingers make constant contact with the ground plane during operation.

Behind the turntable is a 3' x 6' x 4' deep shielded pit used for support equipment if necessary. The pit is equipped with 1 - 4" PVC chases from the turntable to the pit that allow for cabling to the EUT if necessary. The underside of the turntable can be accessed from the pit so cables can be supplied to the EUT from the pit.

A diagram of the Semi-Anechoic Chamber Test Site is shown in Figure 2.3-1 below:

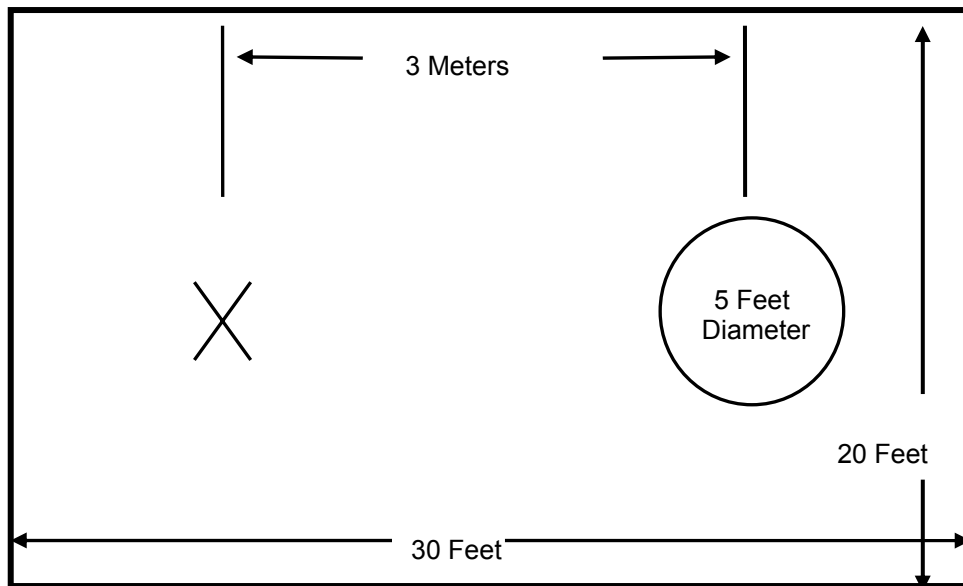

Figure 2.3-1: Semi-Anechoic Chamber Test Site

2.3.2 Open Area Tests Site (OATS)

The open area test site consists of a 40' x 66' concrete pad covered with a perforated electro-plated galvanized sheet metal. The perforations in the sheet metal are 1/8" holes that are staggered every 3/16". The individual sheets are placed to overlap each other by 1/4" and are riveted together to provide a continuous seam. Rivets are spaced every 3" in a 3 x 20 meter perimeter around the antenna mast and EUT area. Rivets in the remaining area are spaced as necessary to properly secure the ground plane and maintain the electrical continuity.

The entire ground plane extends 12' beyond the turntable edge and 16' beyond the antenna mast when set to a 10 meter measurement distance. The ground plane is grounded via 4 - 8' copper ground rods, each installed at a corner of the ground plane and bound to the ground plane using 3/4" stainless steel braided cable.

The turntable is an all aluminum 10' flush mounted table installed in an all aluminum frame. The table is remotely operated from inside the control room located 40' from the range. The turntable is electrically bonded to the surrounding ground plane via steel fingers installed on the edge of the turn table. The steel fingers make constant contact with the ground plane during operation.

Adjacent to the turntable is a 7' x 7' square and 4' deep concrete pit used for support equipment if necessary. The pit is equipped with 5 - 4" PVC chases from the pit to the control room that allow for cabling to the EUT if necessary. The underside of the turntable can be accessed from the pit so cables can be supplied to the EUT from the pit. The pit is covered with 2 sheets of 1/4" diamond style reinforced steel sheets. The sheets are painted to match the perforated steel ground plane; however the underside edges have been masked off to maintain the electrical continuity of the ground plane. All reflecting objects are located outside of the ellipse defined in ANSI C63.4.

A diagram of the Open Area Test Site is shown in Figure 2.3-2 below:

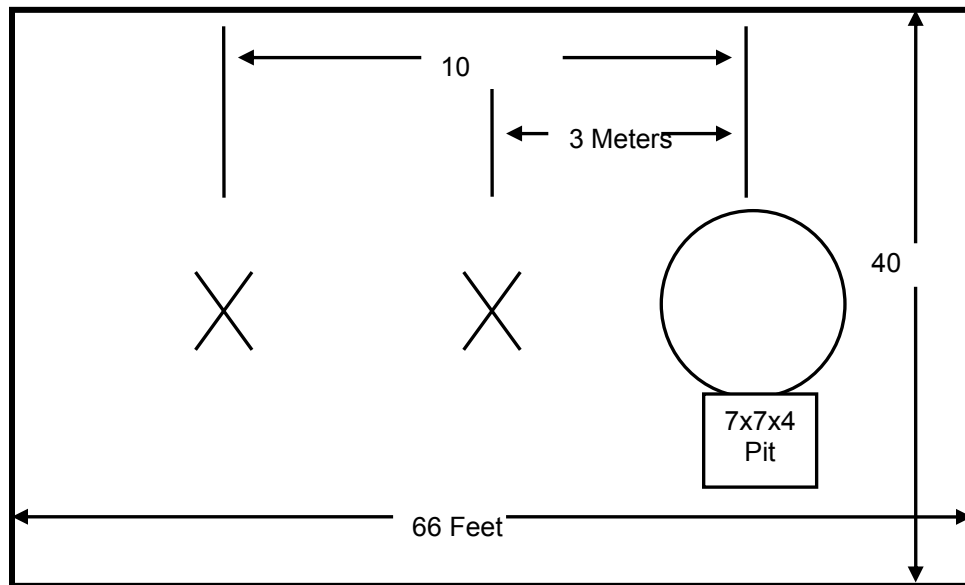

Figure 2.3-2: Open Area Test Site

2.4 Conducted Emissions Test Site Description

The AC mains conducted EMI site is a shielded room with the following dimensions:

- Height: 3.0 Meters
- Width: 3.6 Meters
- Length: 4.9 Meters

The room is manufactured by Rayproof Corporation and installed by Panashield, Inc. Earth ground is provided to the room via an 8' copper ground rod. Each panel of the room is connected electrically at intervals of 4".

Power to the room is filtered to prevent ambient noise from coupling to the EUT and measurement equipment. Filters are models 1B42-60P manufactured by Rayproof Corporation.

The room is of sufficient size to test table top and floor standing equipment in accordance with section 6.1.4 of ANSI C63.4.

A diagram of the room is shown below in figure 2.4-1:

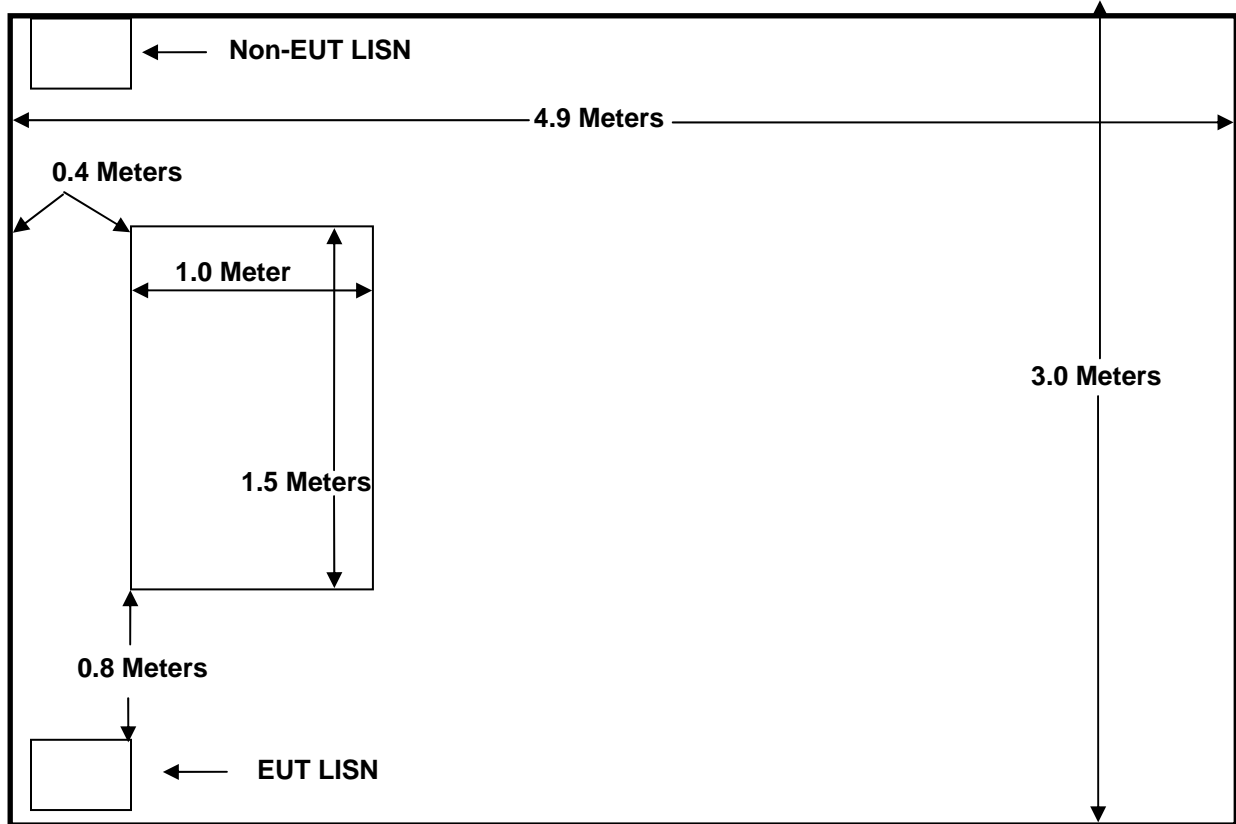

Figure 2.4-1: AC Mains Conducted EMI Site

3.0 APPLICABLE STANDARD REFERENCES

The following standards were used:

- 1 - ANSI C63.4-2003: Method of Measurements of Radio-Noise Emissions from Low-Voltage Electrical And Electronic Equipment in the 9 KHz to 40GHz
- 2 - US Code of Federal Regulations (CFR): Title 47, Part 15, Subpart C: Radio Frequency Devices, Intentional Radiators
- 3 - FCC OET Bulletin 65 Appendix C - Evaluating Compliance with FCC Guidelines for Human Exposure to Radiofrequency Electromagnetic Fields

4.0 LIST OF TEST EQUIPMENT

All test equipment used for regulatory testing is calibrated yearly or according to manufacturer's specifications.

Table 4.0-1: Test Equipment

Equipment Calibration Information					
ACS#	Mfg.	Eq. type	Model	S/N	Cal. Due
25	Chase	Bi-Log Antenna	CBL6111	1043	05/23/06
152	EMCO	LISN	3825/2	9111-1905	01/18/06
165	ACS	Conducted EMI Cable Set	RG8	165	01/06/06
22	Agilent	Pre-Amplifier	8449B	3008A00526	05/06/06
73	Agilent	Pre-Amplifier	8447D	272A05624	05/18/06
30	Spectrum Technologies	Horn Antenna	DRH-0118	970102	05/09/06
105	Microwave Circuits	High Pass Filter	H1G810G1	2123-01 DC0225	06/09/06
3	Rohde & Schwarz	ESMI Receiver	804.8932.52	839379/011	12/15/05
4	Rohde & Schwarz	ESMI Receiver	1032.5640.53	833827/003	12/15/05
NA	Agilent	Spectrum Analyzer	E4440A	MY43362209	09/08/06
6	Harbour Industries	HF RF Cable	LL-335	00006	03/16/06
7	Harbour Industries	HF RF Cable	LL-335	00007	03/16/06
208	Harbour Industries	HF RF Cable	LL142	00208	06/24/06
167	ACS	Chamber EMI Cable Set	RG6	167	12/29/05
204	ACS	Chamber EMI RF cable	RG8	204	01/07/06

5.0 SUPPORT EQUIPMENT

Table 5-3: Support Equipment

Manufacturer	Equipment Type	Model Number	Serial Number	FCC ID
The EUT was tested and operates stand-alone. No Support equipment utilized.				

6.0 EQUIPMENT UNDER TEST SETUP AND BLOCK DIAGRAM

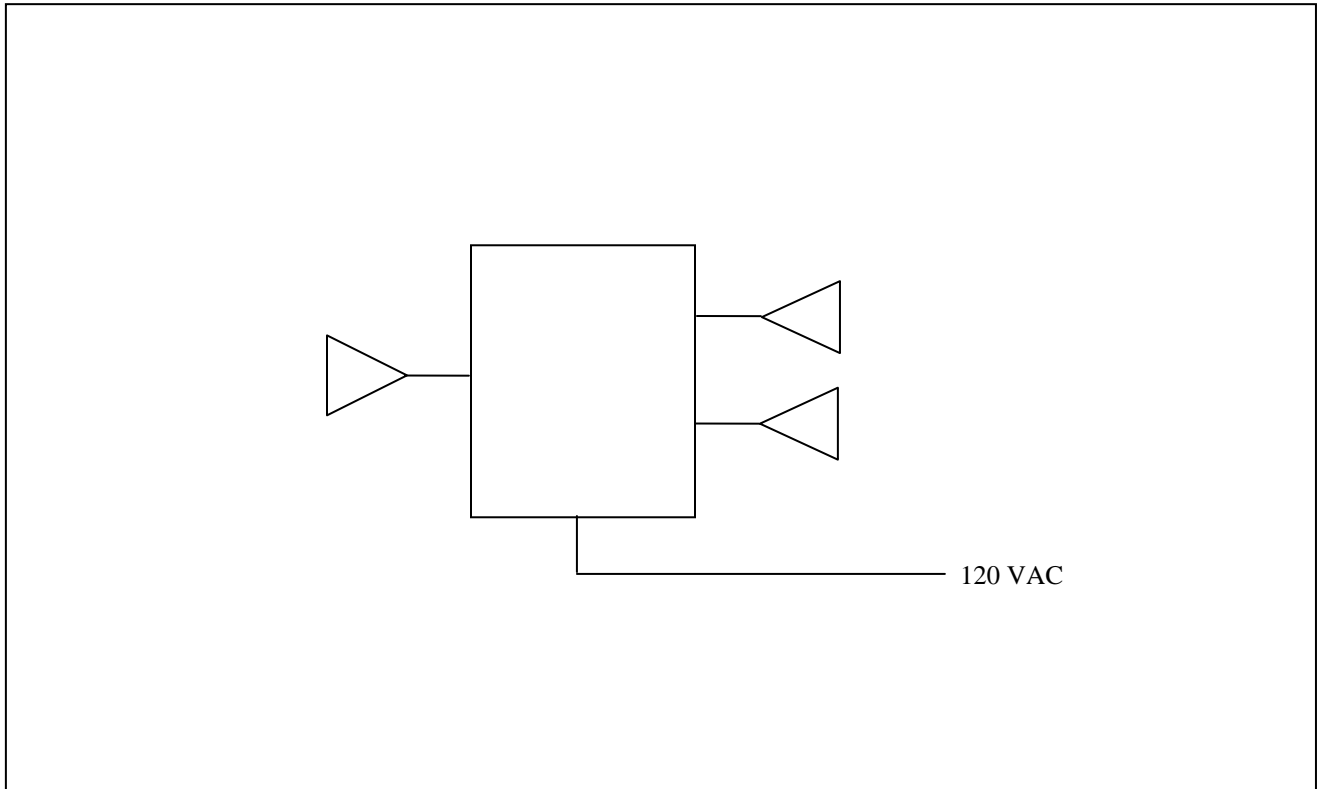

Figure 6.0-1: EUT Test Setup

7.0 SUMMARY OF TESTS

Along with the tabular data shown below, plots were taken of all signals deemed important enough to document.

7.1 Antenna Requirement - FCC Section 15.203

The EUT employs Standard N-Type Connectors. This equipment is designed for use by the utility industry and is not marketed to the general public and must be professionally installed. The standard connectors allow for antenna replacement by qualified service personnel.

7.2 Power Line Conducted Emissions - FCC Section 15.207

7.2.1 Test Methodology

Conducted emissions were performed from 150kHz to 30MHz with the spectrum analyzer's resolution bandwidth set to 9kHz and the video bandwidth set to 30kHz. The calculation for the conducted emissions is as follows:

Corrected Reading = Analyzer Reading + LISN Loss + Cable Loss

Margin = Applicable Limit - Corrected Reading

Results of the test are shown below in and Tables 7.2.2-1 through 7.2.2-4 and Figure 7.2.2-1 through 7.2.2-2

7.2.2 Test Results

Table 7.2.2-1: Line 1 Conducted EMI Results (Quasi-Peak)

Frequency MHz	Level dBµV	Transducer (dB)	Limit dBµV	Margin dB	Line	PE
0.198	52.9	9.9	63.6	10.7	L1	FLO
0.390	40.5	9.9	58	17.4	L1	FLO
0.582	42.9	9.9	56	13.0	L1	FLO
1.170	39.3	10.0	56	16.7	L1	FLO
1.464	38.8	10.0	56	17.1	L1	FLO
2.208	35.9	10.0	56	20.0	L1	FLO
3.834	33.6	10.0	56	22.3	L1	FLO
6.864	20.1	10.1	60	39.8	L1	FLO
13.536	21.9	10.2	60	38.0	L1	FLO
19.422	23.4	10.2	60	36.5	L1	FLO

Table 7.2.2-2: Line 1 Conducted EMI Results (Average)

Frequency MHz	Level dBµV	Transducer (dB)	Limit dBµV	Margin dB	Line	PE
0.198	42.7	9.9	53.6	10.9	L1	FLO
0.396	32.6	9.9	47.9	15.2	L1	FLO
0.594	32.9	9.9	46	13.0	L1	FLO
1.140	26.2	10.0	46	19.7	L1	FLO
1.476	26.2	10.0	46	19.7	L1	FLO
2.220	24.9	10.0	46	21.0	L1	FLO
3.828	23.5	10.0	46	22.4	L1	FLO
6.858	15.7	10.1	50	34.2	L1	FLO
13.476	16.3	10.2	50	33.6	L1	FLO
19.422	21.7	10.2	50	28.2	L1	FLO

Table 7.2.2-3: Line 2 Conducted EMI Results (Quasi-Peak)

Frequency MHz	Level dB μ V	Transducer (dB)	Limit dB μ V	Margin dB	Line	PE
0.198	54.0	9.9	63.6	9.5	L2	FLO
0.390	41.6	9.9	58	16.3	L2	FLO
0.582	44.3	9.9	56	11.6	L2	FLO
1.170	40.7	10.0	56	15.2	L2	FLO
1.692	39.4	10.0	56	16.6	L2	FLO
1.998	38.9	10.0	56	17.0	L2	FLO
2.214	37.2	10.0	56	18.7	L2	FLO
4.938	34.9	10.1	56	21.0	L2	FLO
10.446	24.4	10.1	60	35.5	L2	FLO
13.176	25.5	10.2	60	34.4	L2	FLO

Table 7.2.2-4: Line 2 Conducted EMI Results (Average)

Frequency MHz	Level dB μ V	Transducer (dB)	Limit dB μ V	Margin dB	Line	PE
0.198	43.7	9.9	53.6	9.9	L2	FLO
0.396	33.8	9.9	47.9	14.0	L2	FLO
0.588	34.4	9.9	46	11.5	L2	FLO
1.206	28.0	10.0	46	17.9	L2	FLO
1.674	27.8	10.0	46	18.1	L2	FLO
2.004	26.7	10.0	46	19.2	L2	FLO
2.202	26.7	10.0	46	19.2	L2	FLO
4.860	26.6	10.1	46	19.4	L2	FLO
10.380	16.7	10.1	50	33.2	L2	FLO
13.242	18.8	10.2	50	31.1	L2	FLO

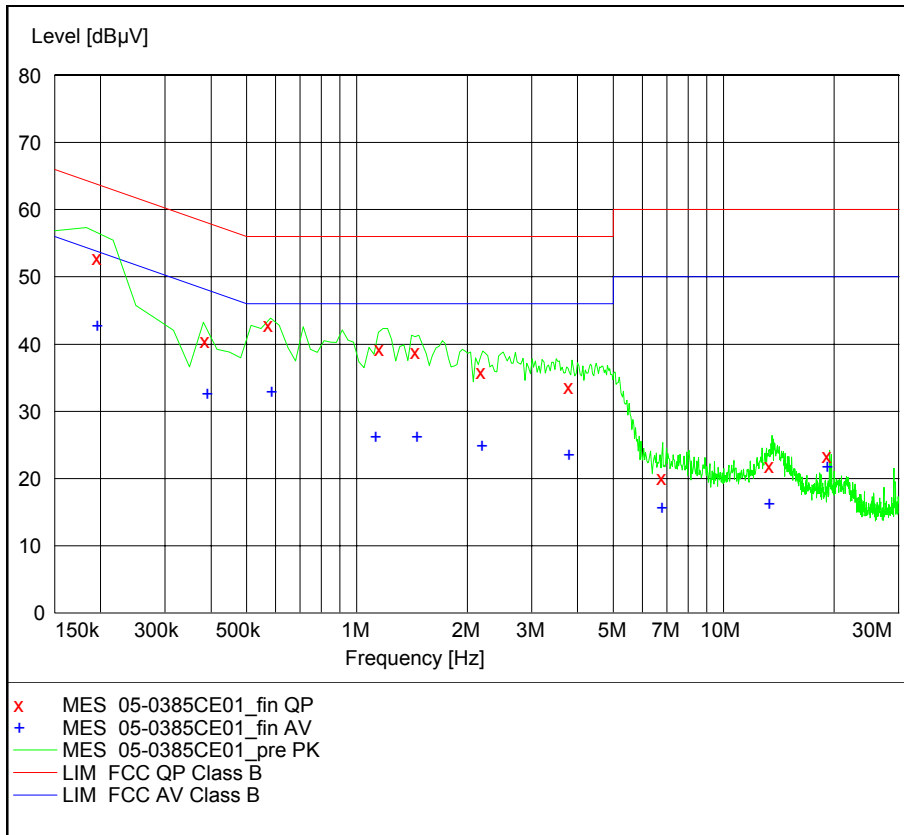

Figure 7.2.2-1: Conducted Emissions Graph – Line 1

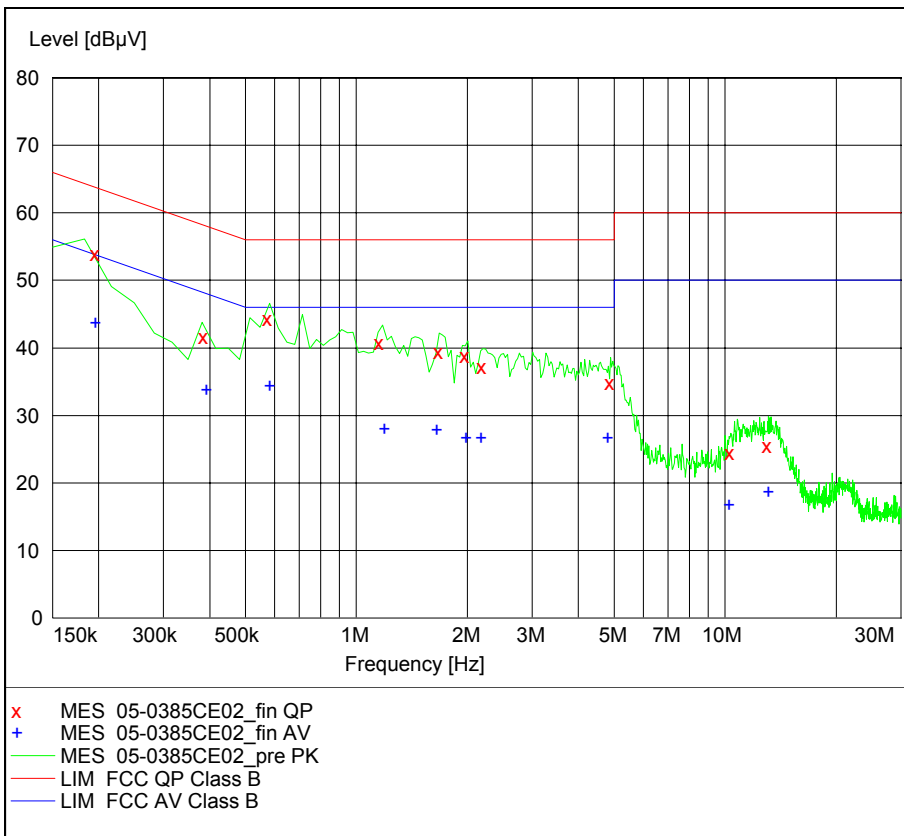

Figure 7.2.2-2: Conducted Emissions Graph – Line 2

7.3 Radiated Emissions - FCC Section 15.109(Unintentional Radiation)

7.3.1 Test Methodology

Radiated emissions tests were performed over the frequency range of 30MHz to 1 GHz. Measurements of the radiated field strength were made at a distance of 3m from the boundary of the equipment under test (EUT) and the receiving antenna. The antenna height was varied from 1m to 4m so that the maximum radiated emissions level would be detected. Radiated measurements were made with the Spectrum Analyzer's resolution bandwidth set to 120 KHz for measurements above 30MHz. Average measurements are taken with the RBW and VBW were set to 1MHz and 10 Hz respectively for measurements above 1000MHz.

7.3.2 Test Results

Results of the test are given below in Table 7.3.2-1:

Table 7.3.2-1: Radiated Emissions

Frequency (MHz)	Uncorrected Reading (dB μ V/m)	Antenna Polarity (H/V)	Total Correction Factor (dB)	Corrected Reading (dB μ V/m)	Limit (dB μ V/m)	Margin (dB)
38.84	37.12	V	-9.99	27.13	40	12.9
54.28	41.29	V	-15.60	25.69	40	14.3
77.66	48.38	V	-16.72	31.66	40	8.3
116.59	46.90	V	-9.90	37.00	43.5	6.5
154.82	43.22	V	-10.43	32.79	43.5	10.7
233.00	46.47	H	-9.60	36.87	46	9.1
387.07	48.93	H	-2.98	45.95	46	0.1
504.88	35.40	V	-0.41	34.99	46	11.0
541.80	42.58	V	-0.06	42.52	46	3.5
619.36	40.36	H	0.65	41.01	46	5.0
851.50	37.58	H	4.40	41.98	46	4.0

* Note: All emissions above 851.50 MHz were attenuated at least 20 dB below the permissible limit.

7.4 6dB Bandwidth – FCC Section 15.247(a)

7.4.1 Test Methodology

The 6dB bandwidth was measured in accordance with the FCC publication “New Guidance on Measurements for Digital Transmission Systems in Section 15.247”. The RBW of the spectrum analyzer was set to 100 kHz and VBW 300 kHz. Span was set large enough to capture the entire emissions and >> RBW.

7.4.2 Test Results

Results are shown below in table 7.4.2-1 and figure 7.4.2-1:

Table 7.4.2-1: 6dB Bandwidth

Frequency [MHz]	Bandwidth [MHz]	Limit	Result
917.58	1.312	≥ 500 kHz	PASS

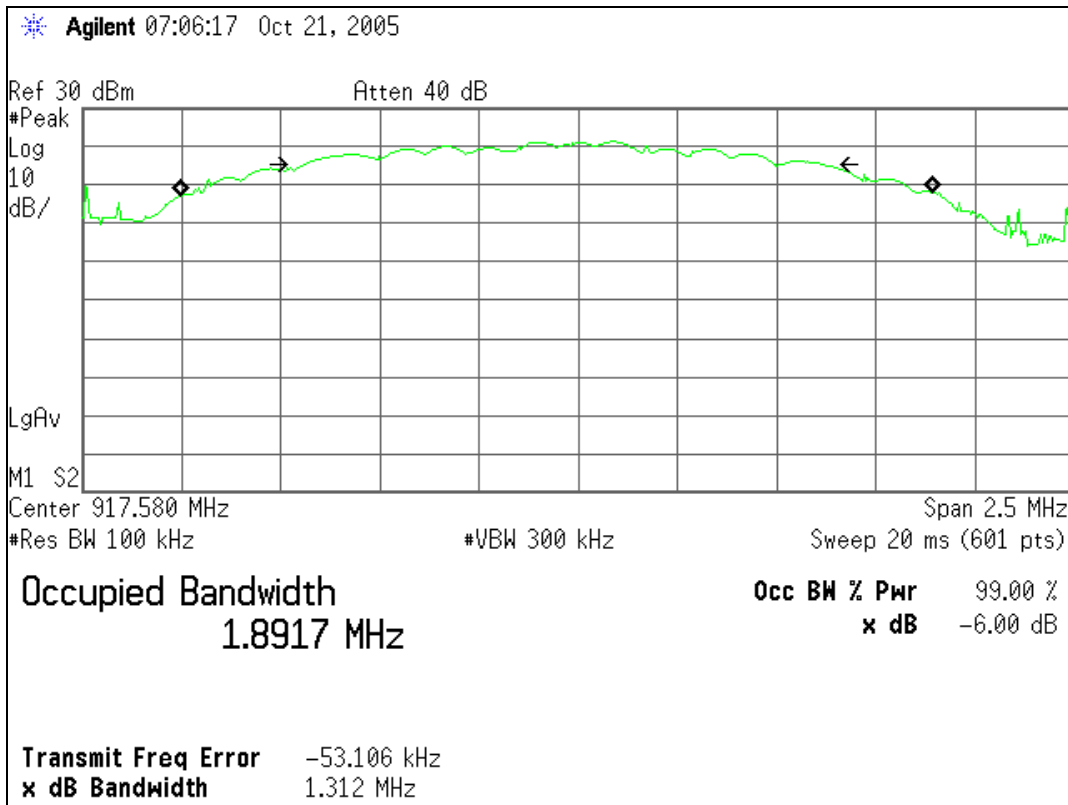

Figure 7.4.2-1: 6dB Bandwidth Plot

7.5 Peak Output Power Requirement - FCC Section 15.247(b)

7.5.1 Test Methodology

The Peak Output Power was measured in accordance with the FCC publication “New Guidance on Measurements for Digital Transmission Systems in Section 15.247” Power Option 1. The RF output of the equipment under test was directly connected to the input of the Spectrum Analyzer. The resolution and video bandwidths of the spectrum analyzer were set at sufficient levels, >> emission bandwidth, to produce accurate results. The analyzer was set for Max Hold using a peak detector.

7.5.2 Test Results

Results are shown below in Table 7.5.2-1 and Figures 7.5.2-1:

Table 7.5.2-1: Peak Output Power

Frequency (MHz)	Output Power (dBm)
917.58	26.47

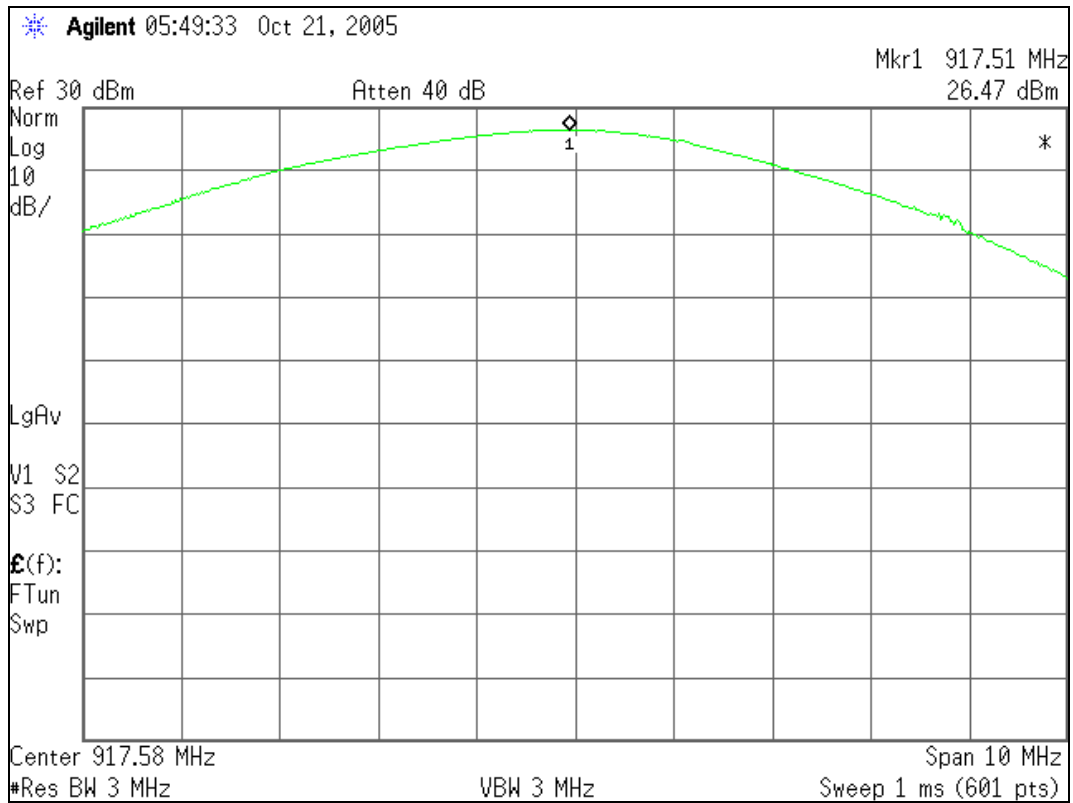

Figure 7.5.2-1: Output power

7.6 Band-Edge Compliance and Spurious Emissions - FCC Section 15.247(d)

7.6.1 Band-Edge Compliance of RF Emissions

7.6.1.1 Test Methodology

The EUT was investigated at 917.58 MHz to determine band-edge compliance. For this measurement the spectrum analyzer's RBW and VBW was set to 100 kHz.

7.6.1.2 Test Results

In a 100 kHz bandwidth at the lower and upper band-edge, the radio frequency power that was produced by the EUT is at least 20 dB below that in the 100 kHz bandwidth within the band that contains the highest level of desired power. Band-edge compliance is displayed in Figure 7.6.1.2-1.

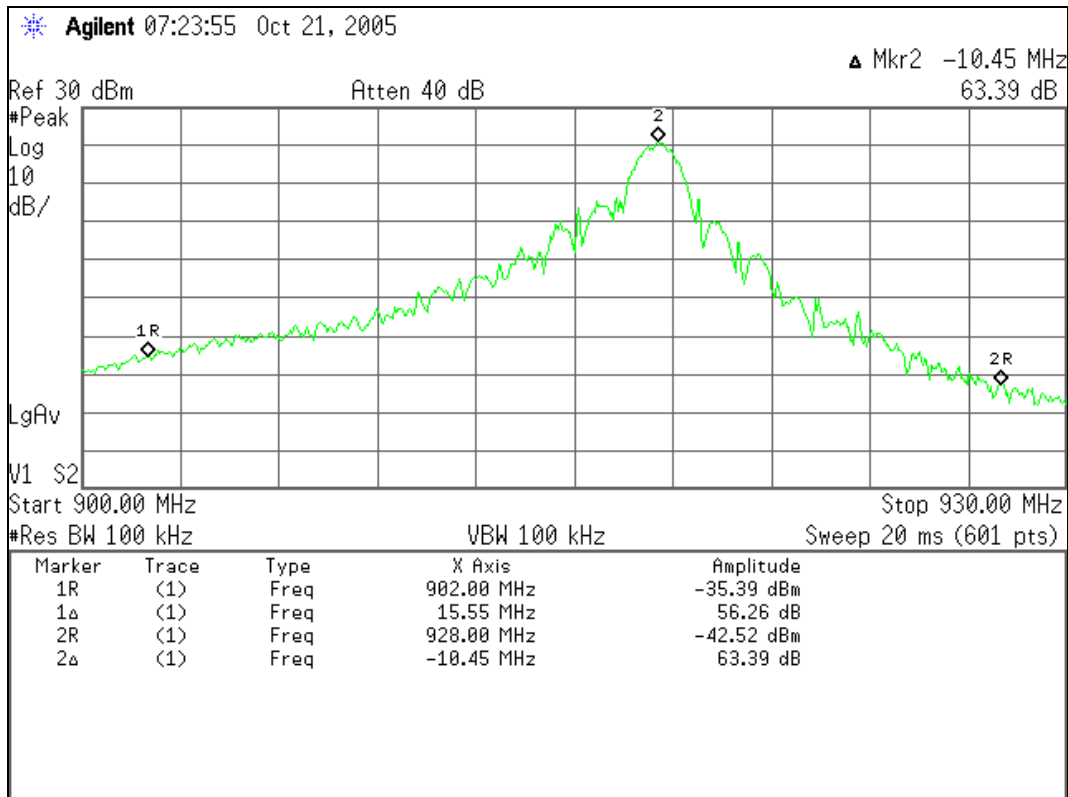

Figure 7.6.1.2-1: Band-edge

7.6.2 RF Conducted Spurious Emissions

The RF Conducted Spurious Emissions were measured in accordance with the FCC publication “New Guidance on Measurements for Digital Transmission Systems in Section 15.247”. The RF output of the equipment under test was directly connected to the input of the Spectrum Analyzer. The EUT was investigated for conducted spurious emissions from 30MHz to 10GHz, 10 times the highest fundamental frequency. For each measurement, the spectrum analyzer’s RBW was set to 100 kHz. The peak detector and Max Hold function of the analyzer were utilized.

7.6.2.2 Test Results

In a 100 kHz bandwidth, the radio frequency power that was produced by the EUT emissions is at least 20 dB below that in the 100 kHz bandwidth within the band that contains the highest level of desired power. RF Conducted Emissions are displayed in Figures 7.6.2.2-1 through 7.6.2.2-2.

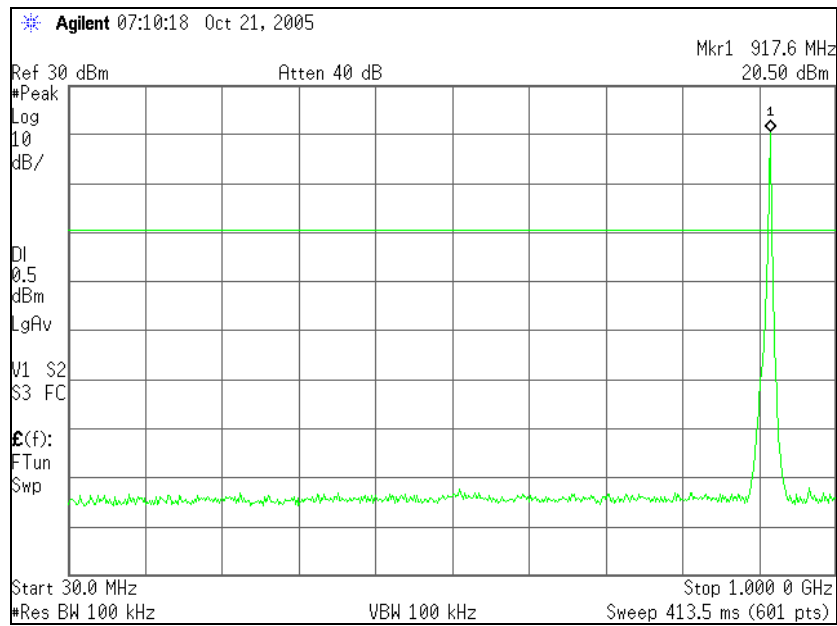

Figure 7.6.2.2-1: RF Conducted Spurious Emission 30 MHz – 1 GHz

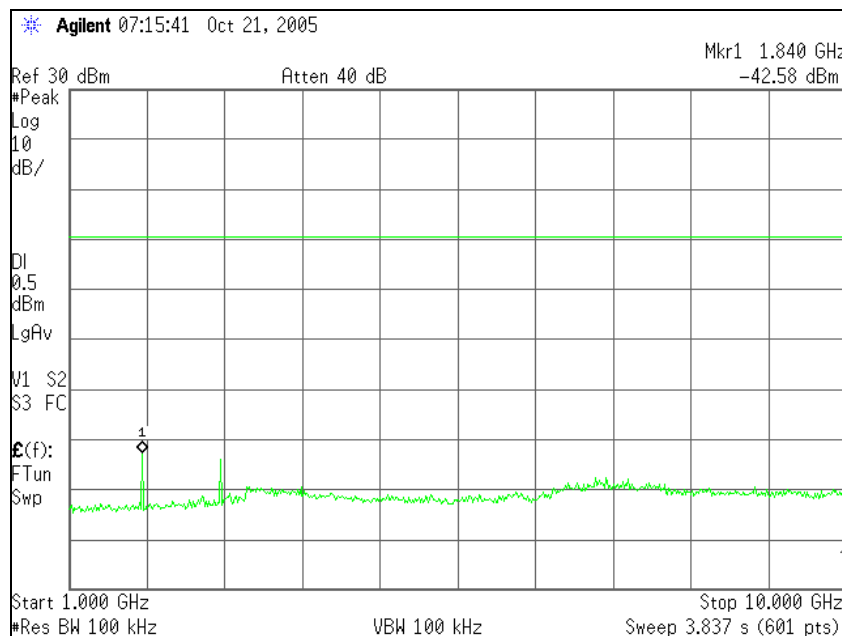

Figure 7.6.2.2-2: RF Conducted Spurious Emission 1 GHz – 10 GHz

7.6.3 Radiated Spurious Emissions (Restricted Bands) - FCC Section 15.205

7.6.3.1 Test Methodology

Radiated emissions tests were made over the frequency range of 30MHz to 10GHz, 10 times the highest fundamental frequency.

The EUT was rotated through 360° and the receive antenna height was varied from 1m to 4m so that the maximum radiated emissions level would be detected. For frequencies below 1000MHz, quasi-peak measurements were made using a resolution bandwidth (RBW) of 120 kHz and a video bandwidth (VBW) of 300 kHz. For frequencies above 1000MHz, average measurements were calculated based on the peak measurements made with RBW of 1 MHz and a VBW of 1 MHz. The average emissions were calculated by applying the duty cycle correction of the EUT to the peak measurements for comparison to the average limit.

7.6.3.2 Duty Cycle Correction

For average radiated measurements, the measured level was reduced by a factor 13.98dB to account for the duty cycle of the EUT. The EUT transmits for approximately 20mS within a 100ms period. Therefore the duty cycle is 20%. The duty cycle correction factor is determined using the formula: $20\log(0.20) = -13.98\text{dB}$.

7.6.3.3 Test Results

Using the procedures set forth in the FCC publication “New Guidance on Measurements for Digital Transmission Systems in Section 15.247”, radiated spurious emissions found in the band of 30MHz to 10GHz are reported in Table 7.6.3.3-1. Each emission found to be in a restricted band as defined by section 15.205, was compared to the radiated emission limits as defined in section 15.209.

Table 7.6.3.3-1: Radiated Spurious Emissions

Frequency (MHz)	Level (dBuV)		Antenna Polarity (H/V)	Correction Factors (dB)	Corrected Level (dBuV/m)		Limit (dBuV/m)		Margin (dB)	
	pk	avg			pk	avg	pk	avg	pk	avg
2752.74	57.21	57.21	H	1.56	58.77	44.79	74	54	15.23	9.21
2752.74	65.43	65.43	V	1.56	66.99	53.01	74	54	7.01	0.99
4587.9	46.30	46.30	H	6.80	53.10	39.12	74	54	20.90	14.88
4587.9	45.77	45.77	V	6.80	52.57	38.59	74	54	21.43	15.41

7.6.3.4 Sample Calculation:

$$R_C = R_U + CF_T$$

Where:

- CF_T = Total Correction Factor (AF+CA+AG)-DC (Average Measurements Only)
- R_U = Uncorrected Reading
- R_C = Corrected Level
- AF = Antenna Factor
- CA = Cable Attenuation
- AG = Amplifier Gain
- DC = Duty Cycle Correction Factor

Example Calculation: Peak

Corrected Level: $57.21 + 1.56 = 58.77 \text{ dBuV/m}$
 Margin: $74\text{dBuV/m} - 58.77 \text{ dBuV/m} = 15.23 \text{ dB}$

Example Calculation: Average

Corrected Level: $57.21 + 1.56 - 13.98 = 44.79 \text{ dBuV}$
 Margin: $54\text{dBuV} - 44.79 \text{ dBuV} = 9.21 \text{ dB}$

7.7 Peak Power Spectral Density- FCC Section 15.247(d)

7.7.1 Test Methodology

The power spectral density was measured in accordance with the FCC publication “New Guidance on Measurements for Digital Transmission Systems in Section 15.247”. The emission peaks within the pass band were located and zoomed in on. The spectrum analyzer RBW was set to 3 kHz and VBW 3 kHz. Span was adjusted to 1 MHz and the sweep time was calculated to be 333s (Span/3 kHz).

7.7.2 Test Results

Results are shown below in table 7.7.2-1 and figure 7.7.2-1:

Table 7.7.2-1: Peak Power Spectral Density

Frequency [MHz]	Level [dBm]	Limit [dBm]	Result
917.58	7.56	8	PASS

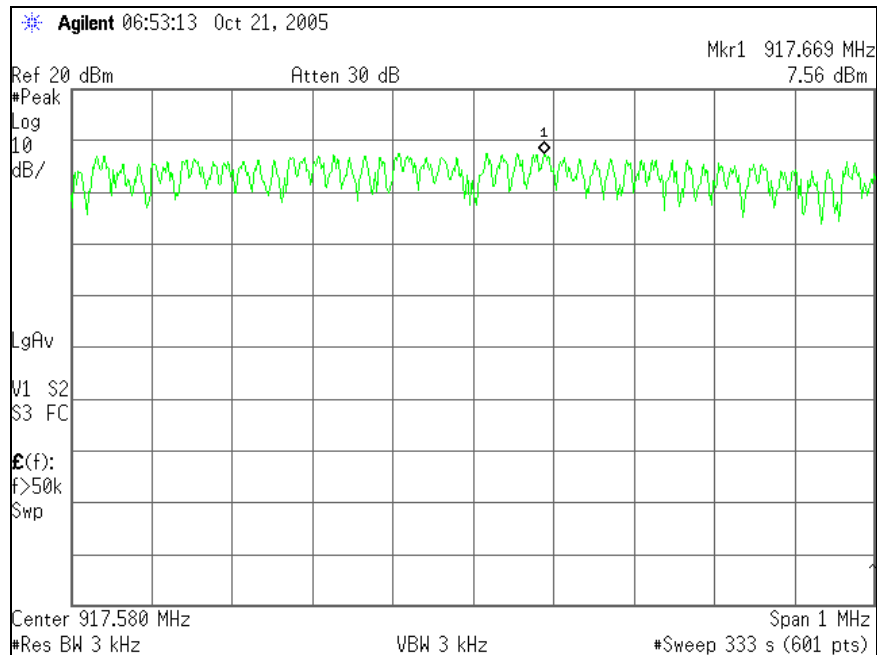

Figure 7.7.2-1: Peak Power Spectral Density

8.0 CONCLUSION

In the opinion of ACS, Inc. the InfiNet Concentrator model 26-1129, manufactured by Cellnet Technology, Inc., does meet the requirements of FCC Part 15 subpart C.